

საქართველოს ინტელექტუალური საკუთრების
ეროვნული ცენტრი
საქპატენტი

**სამრეწველო საკუთრების
ო ფ ი ს ი ა ლ უ რ ი
ბ ი უ ლ ე ტ ე ნ ი**

4(416)

**გამოგონებები
სასარგებლო მოდელები
დიზაინები
სასაქონლო ნიშნები**

საერთაშორისო კოდეზი ზიზლიოგრაფიული მონასეების იდენტიფიკაციისათვის

გამოგონებები, სასარგებლო მოდელები

- (10) – ექსპერტიზაგავლილი განაცხადის გამოქვეყნების ნომერი
- (11) – პატენტის ნომერი და სახეობის კოდი
- (21) – განაცხადის სარეგისტრაციო ნომერი
- (22) – განაცხადის შეტანის თარიღი
- (23) – სავაჭოველო პრიორიტეტის თარიღი ან ადრინდელი პრიორიტეტის მქონე განაცხადის შეტანის თარიღი და, თუ შესაძლებელია, განაცხადის ომერი
- (24) – თარიღი, რომლიდანაც იწყება პატენტის მოქმედება
- (31) – საპრიორიტეტო განაცხადის ნომერი
- (32) – საპრიორიტეტო განაცხადის შეტანის თარიღი
- (33) – კოდი ქვეყნის ან რეგიონული ორგანიზაციისა, რომლის უწყებამაც მიანიჭა ნომერი საპრიორიტეტო განაცხადს
- (44) – დამავი სახეობის კური არქონე, მაგრამ ექსპერტიზაგავლილი განაცხადის გამოქვეყნების თარიღი და ბიულეტენის ნომერი
- (45) – რეგისტრაცია გათვლილი საპატენტო სახეობის გამოქვეყნების თარიღი
- (51) – საერთაშორისო საპატენტო კლასიფიკაციის ინდექსი

- (54) – გამოგონების დასახელება
- (57) – რეფერატის ტექსტი
- (60) – სრულ ექსპერტიზაგავლილ გამოგონებაზე უცხოური საპატენტო უწყების მიერ გაცემული დამავი სახეობის ნომერი, თარიღი, რომლიდანაც იწყება ამ დამავი სახეობის მოქმედება, და კოდი ქვეყნის ან რეგიონული ორგანიზაციისა, რომლის უწყებამაც გასცა ეს დამავი სახეობი
- (62) – უფრო ადრინდელი განაცხადის ნომერი და, თუ შესაძლებელია, წარდგენის თარიღი გამოცალკეებული განაცხადის შემთხვევაში
- (71) – განმცხადებლის სახელი, გვარი (ქვეყნის კოდი)
- (72) – გამოგონებულის სახელი, გვარი (ქვეყნის კოდი)
- (73) – პატენტმფლობელის სახელი, გვარი (ქვეყნის კოდი), მისამართი
- (74) – წარმომადგენლის ან პატენტმფლობელის სახელი, გვარი
- (85) – საერთაშორისო განაცხადის უროვნული ფაზის დაწყების თარიღი
- (86) – საერთაშორისო განაცხადის ნომერი და შეტანის თარიღი
- (87) – საერთაშორისო განაცხადის გამოქვეყნების ნომერი და თარიღი

ლიზინი

- (10) – განაცხადის გამოქვეყნების ნომერი
- (11) – პატენტის ნომერი და სახეობის კოდი ან რეგისტრაციის ნომერი
- (15) – რეგისტრაციის თარიღი/პატენტის გაგრძელების თარიღი
- (18) – პატენტის ან რეგისტრაციის მოქმედების ვადის გასვლის სავარაუდო თარიღი
- (21) – განაცხადის ნომერი
- (22) – განაცხადის შეტანის თარიღი
- (23) – სავაჭოველო პრიორიტეტის თარიღი ან ადრინდელი პრიორიტეტის მქონე განაცხადის შეტანის თარიღი და, თუ შესაძლებელია, განაცხადის ნომერი
- (24) – თარიღი, რომლიდანაც იწყება პატენტის მოქმედება
- (28) – ღიზინების რაოდენობა განაცხადში
- (30) – საპრიორიტეტო მონაცემები (განაცხადის ნომერი, განაცხადის შეტანის თარიღი და ორასოიანი კოდი იმ ორგანიზაციის იდენტიფიკაციისათვის, სადაც იყო წარდგენილი საპრიორიტეტო განაცხადი)
- (31) – საპრიორიტეტო განაცხადის ნომერი
- (32) – საპრიორიტეტო განაცხადის შეტანის თარიღი
- (33) – კოდი ქვეყნის ან რეგიონული ორგანიზაციისა, რომლის უწყებამაც მიანიჭა ნომერი საპრიორიტეტო განაცხადს
- (34) – IUPAC სტანდარტის (IUPAC) შესაბამისი ორასოიანი კოდი იმ ორგანიზაციის იდენტიფიკაციისათვის, სადაც იყო წარდგენილი საპრიორიტეტო განაცხადი
- (44) – ღიზინის გამოქვეყნების თარიღი და ბიულეტენის ნომერი (პირველი პუბლიკაცია)

- (45) – საერთაშორისო ბიუროს მიერ დარეგისტრირებული ღიზინის გამოქვეყნების თარიღი და ბიულეტენის ნომერი
- (51) – ღიზინების საერთაშორისო კლასიფიკაცია (ლოკარნოს კლასიფიკაციის კლასი და ქვეკლასი)
- (54) – ღიზინის დასახელება
- (55) – ღიზინის გამოცხადება
- (57) – ღიზინის არსებითი ნიშნების აღწერა, ფერის ჩათვლით
- (58) – ყველა სახის ცვლილების შესახებ რეესტრში ჩანაწერის შეტანის თარიღი
- (62) – ადრინდელი განაცხადის, რეგისტრაციის ან სახეობის ნომერი და, თუ შესაძლებელია, წარდგენის თარიღი, გამოცალკეებული განაცხადის შემთხვევაში
- (71) – განმცხადებლის სახელი, გვარი (ქვეყნის კოდი), მისამართი
- (72) – ავტორის სახელი, გვარი ან დასახელება (ქვეყნის კოდი)
- (73) – პატენტმფლობელის სახელი, გვარი (ქვეყნის კოდი), მისამართი
- (74) – წარმომადგენლის სახელი, გვარი და მისამართი
- (81) – შესაბამისი მონაწილე მხარეები:
 - II. მონაწილე მხარეები, აღნიშნული 1960 წლის აქტის თანახმად
 - III. მონაწილე მხარეები, აღნიშნული 1999 წლის აქტის თანახმად
- (85) – მფლობელის მუდმივი საცხოვრებელი ადგილი
- (86) – მფლობელის მოქალაქეობა
- (87) – მფლობელის საცხოვრებელი ადგილი
- (88) – ქვეყანა, სადაც მფლობელს აქვს ნამდვილი და მოქმედი სამრეწველო ან სავაჭრო სანარმო

სასაქონლო ნიშნები

- (111) – რეგისტრაციის ნომერი
- (151) – რეგისტრაციის თარიღი
- (156) – რეგისტრაციის ვადის გაგრძელების თარიღი
- (181) – რეგისტრაციის ვადის გასვლის სავარაუდო თარიღი
- (186) – ვადის გაგრძელების გასვლის სავარაუდო თარიღი
- (141) – რეგისტრაციის მოქმედების ვადის გაუქმების თარიღი
- (210) – განაცხადის ნომერი
- (220) – განაცხადის შეტანის თარიღი
- (230) – სავაჭოველო მონაცემები
- (260) – ნომერი განაცხადისა, რომელზედაც გამოკანონდა ექსპერტიზის დადებითი გადაწყვეტილება რეგისტრაციის შესახებ (გამოქვეყნების ნომერი)
- (310) – პირველი განაცხადის ნომერი
- (320) – პირველი განაცხადის შეტანის თარიღი
- (330) – პირველი განაცხადის მიმღები უროვნული ან რეგიონული უწყების ან ორგანიზაციის საიდენტიფიკაციო კოდი
- (51) – საქონლისა და მომსახურების საერთაშორისო კლასიფიკაცია სასაქონლო ნიშნის რეგისტრაციისათვის და/ან კლასიფიკირებული საქონლისა და/ან მომსახურების ჩამონათვალი
- (531) – სასაქონლო ნიშნის გამოცხადებითი ელემენტების აღწერა სასაქონლო ნიშნების გამოცხადებითი ელემენტების საერთაშორისო კლასიფიკაციის (ვენის კლასიფიკაცია) მიხედვით

- (540) – ნიშნის გამოსახულება
- (550) – სასაქონლო ნიშნის ტიპი ან სახეობა
- (580) – განაცხადსა და ნიშნის რეგისტრაციისთან დაკავშირებული ყველა სახის ცვლილებაზე ჩანაწერის შეტანის თარიღი
- (591) – ინფორმაცია განცხადებულ ფერებზე
- (731) – განმცხადებლის სახელი და მისამართი
- (732) – მფლობელის სახელი და მისამართი
- (740) – წარმომადგენლის სახელი და მისამართი
- (750) – მიმონწერის მისამართი
- (770) – ცვლილებაზე განმცხადებლის ან მფლობელის სახელი და მისამართი უფლების გადაცემის შემთხვევაში
- (771) – ცვლილებაზე განმცხადებლის ან მფლობელის სახელი და მისამართი უფლების გადაცემის გარეშე
- (791) – ლიცენზიაციის სახელი და მისამართი
- (793) – ლიცენზიის პირობები და/ან შეზღუდვაზე მიწიშება (ლიცენზიის სახე, სალიცენზიო ხელშეკრულების ნომერი, სალიცენზიო ხელშეკრულების თარიღი, სალიცენზიო ხელშეკრულების მოქმედების ვადა)
- (800) – სასაქონლო ნიშნის რეგისტრაციის მონაცემები ნიშნების საერთაშორისო რეგისტრაციის მდრიდის ხელშეკრულებასთან დაკავშირებული პროტოკოლის მიხედვით (საერთაშორისო რეგისტრაციის ნომერი)

- (21) AP 0000 000000 – გამოგონებაზე განაცხადის ნომერი
- (10) AP 0000 0000 A – გამოგონებაზე განაცხადის გამოქვეყნების ნომერი (პირველი პუბლიკაცია)
- (11) P 0000 0000 B – გამოგონების პატენტის ნომერი (მეორე პუბლიკაცია)
- (21) API 0000 000000 – შემოტანილ პატენტზე განაცხადის ნომერი
- (11) PI 0000 0000 A – შემოტანილი პატენტის ნომერი (პირველი პუბლიკაცია)
- (21) AU 0000 000000 – სასარგებლო მოდელებზე განაცხადის ნომერი
- (10) AU 0000 000 U – სასარგებლო მოდელებზე განაცხადის გამოქვეყნების ნომერი (პირველი პუბლიკაცია)
- (11) U 0000 000 Y – სასარგებლო მოდელების პატენტის ნომერი (მეორე პუბლიკაცია)
- (21) AD 0000 000000 – ღიზინზე განაცხადის ნომერი
- (10) AD 0000 000 S – ღიზინზე განაცხადის გამოქვეყნების ნომერი (პირველი პუბლიკაცია)
- (11) D 0000 000 S – ღიზინის პატენტის ნომერი (მეორე პუბლიკაცია)

- M – სასაქონლო ნიშანი
- (210) AM 0000 000000 – განაცხადის ნომერი
- (260) AAM 0000 00000 A – განაცხადის გამოქვეყნების ნომერი
- (111) M 0000 00000 R – რეგისტრაციის ნომერი
- MMM0000 00000 Rn – მომდევნო ვადით რეგისტრაციის ნომერი, სადაც n=1, 2, 3...
- M 0000 00000 R(P) – რეგისტრაციის ნომერი ნიშანზე უფლების ნაწილობრივი გადაცემისას
- * – საქპატენტის საპატენტო პალარის გადაწყვეტილების შემდეგ გამოქვეყნებული განაცხადის ნომერი
- ** – სასამართლოს გადაწყვეტილების შემდეგ გამოქვეყნებული განაცხადის ნომერი

გამოგონებებისა და სასარგებლო მოდელების საერთაშორისო კლასიფიკაციის იდენტიფიკაცია

- განყოფილება A – ადამიანის პირველადი მოთხოვნილების საგნები
- განყოფილება B – ტექნოლოგიური პროცესები; ტრანსპორტირება
- განყოფილება C – ქიმიკა; მეტალურგია
- განყოფილება D – საფეიქრო ნაწარმი; ქალაქი
- განყოფილება E – მშენებლობა; საბითო საქმი; სტაციონარული ნაგებობები
- განყოფილება F – მექანიკა; განათება; გათბობა; იარაღი; ასაფეთქებელი საშუალებები
- განყოფილება G – ფიზიკა
- განყოფილება H – ელექტრონა

**ისმო-ს წევრი სახელმწიფოებისა და ორგანიზაციების აღნიშვნის
ორასოიანი კოდეზი
(ისმოს სტანდარტი ST.3)**

AD	ანდორა	GD	გრენადა	MY	მალაიზია
AE	არაბთა გაერთიანებული საამიროები	GE	საქართველო	MZ	მოზამბიკი
AF	ავღანეთი	GG	გენზი	NA	ნამიბია
AG	ანტიგუა და ბარბუდა	GH	განა	NE	ნიგერი
AI	ანგილია	GI	გიბრალტარი	NG	ნიგერია
AL	ალბანეთი	GL	გრენლანდია	NI	ნიჟარაგუა
AM	სომხეთი	GM	გამბია	NL	ნიდერლანდები
AN	ანტილის კუნძულები (ნიდერლანდები)	GN	გვინეა	NO	ნორვეგია
AO	ანგოლა	GQ	ეკვატორული გვინეა	NP	ნეპალი
AP	ინტელექტუალური საკუთრების აფრიკის რეგიონალური ორგანიზაცია (ARIPO)	GR	საბერძნეთი	NR	ნაურუ
AR	არგენტინა	GS	სამხრეთი ჯორჯია და სამხრეთი სენდვიჩის კუნძულები	NZ	ახალი ზელანდია
AT	ავსტრია	GT	გვატემალა	OA	აფრიკის ინტელექტუალური საკუთრების ორგანიზაცია (OAPI)
AU	ავსტრალია	GW	გვინეა-ბისაუ	OM	ომანი
AW	არუბა	GY	გაიანა	PA	პანამა
AZ	აზერბაიჯანი	HK	ჰონგ კონგი	PE	პერუ
BA	ბოსნია და ჰერცეგოვინა	HN	ჰონდურასი	PG	პაპუა-ახალი გვინეა
BB	ბარბადოსი	HR	ხორვატია	PH	ფილიპინები
BD	ბანგლადეში	HT	ჰაიტი	PK	პაკისტანი
BE	ბელგია	HU	უნგრეთი	PL	პოლონეთი
BF	ბურკინა-ფასო	IB	ინტელექტუალური საკუთრების მსოფლიო ორგანიზაციის (ისმო, WIPO) საერთაშორისო ბიურო	VE	ვენესუელა
BG	ბულგარეთი	ID	ინდონეზია	VG	ვირჯინის კუნძულები (ბრიტანეთი)
BH	ბაჰრეინი	IE	ირლანდია	PY	პარაგვაი
BI	ბურუნდი	IL	ისრაელი	QA	კატარი
BJ	ბენინი	IM	მენის კუნძული	QZ	ეკვადორის თანამეგობრობის მცენარეთა ჯიშების უწყება (CPVO)
BM	ბერმუდის კუნძულები	IN	ინდოეთი	RO	რუმინეთი
BN	ბრუნეი-დარუსალამი	IQ	ირაკი	RS	სერბია
BO	ბოლივია	IR	ირანის ისლამური რესპუბლიკა	RU	რუსეთის ფედერაცია
BR	ბრაზილია	IS	ისლანდია	RW	რუანდა
BS	ბაჰამის კუნძულები	IT	იტალია	SA	საუდის არაბეთი
BT	ბჰუტანი	JE	ჯეზი	SB	სოლომონის კუნძულები
BV	ბუვეტის კუნძულები	JM	იამაიკა	SC	სეიშელის კუნძულები
BW	ბოტსვანა	JO	იორდანია	SD	სუდანი
BX	ბენელუქსის ინტელექტუალური საკუთრების უწყება (BOIP)	JP	იაპონია	SE	შვედეთი
BY	ბელორუსია	KE	კენია	SG	სინგაპური
BZ	ბელისი	KG	ყირგიზეთი	SH	წმინდა ჰელენის კუნძული
CA	კანადა	KH	კამბოჯა	SI	სლოვენია
CD	კონგოს დემოკრატიული რესპ.	KI	კირიბატი	SK	სლოვაკია
CF	ცენტრალური აფრიკის რესპ.	KM	კომორის კუნძულები	SL	სიერა-ლეონე
CG	კონგო	KN	სენტ კიტსი და ნევისი	SM	სან-მარინო
CH	შვეიცარია	KP	კორეის სახალხო დემოკრატიული რესპუბლიკა	SN	სენეგალი
CI	კოტ-დ'ივუარი	KR	კორეის რესპუბლიკა	SO	სომალი
CK	კუკის კუნძულები	KW	კუვეიტი	SR	სურინამი
CL	ჩილე	KY	კაიმენის კუნძულები	ST	სან-ტომე და პრინსიპი
CM	კამერუნი	KZ	ყაზახეთი	SV	სალვადორი
CN	ჩინეთი	LA	ლაოსი	SY	სირია
CO	კოლუმბია	LB	ლიბანი	SZ	სვაზილენდი
CR	კოსტა-რიკა	PT	პორტუგალია	TC	თურქის და კაიკოსის კუნძულები
CU	კუბა	PW	პალაუ	TD	ჩადი
CV	მწვანე კონცხის კუნძულები	LC	სენტ-ლუსია	TG	ტოგო
CY	კვიპროსი	LI	ლიხტენშტაინი	TH	ტაილანდი
CZ	ჩეხეთის რესპუბლიკა	LK	შრი-ლანკა	TJ	ტაჯიკეთი
DE	გერმანია	LR	ლიბერია	TL	ტიმოლ-ლესტე
DJ	ჯიბუტი	LS	ლესოტო	TM	თურქმენეთი
DK	დანია	LT	ლიტვა	TN	ტუნისი
DM	დომინიკა	LU	ლუქსემბურგი	TO	ტონგა
DO	დომინიკელთა რესპუბლიკა	LV	ლატვია	TR	თურქეთი
DZ	ალჟირი	LY	ლიბია	TT	ტრინიდადი და ტობაგო
EA	ევრაზიის საპატენტო ორგანიზაცია (EAPO)	MA	მაროკო	TV	ტუვალუ
EC	ეკვადორი	MC	მონაკო	TW	ტაივანი, ჩინეთის პროვინცია
EE	ესტონეთი	MD	რესპუბლიკა მოლდოვა	TZ	ტანზანია
EG	ეგვიპტე	ME	ჩერნოგორია (მონტენეგრო)	UA	უკრაინა
EH	დასავლეთი საჰარა	MG	მადაგასკარი	UG	უგანდა
EM	შინაგანი ბაზრის ჰარმონიზაციის უწყება (სასაქონლო ნიშნები და სამრეწველო ნიშნები (OHIM) ევროპის საპატენტო უწყება (EPO))	MK	მაკედონია ყოფილი იუგოსლავიის რესპუბლიკა	US	აშშ
EP	ევროპის საპატენტო უწყება (EPO)	ML	მალი	UY	ურუგვაი
ER	ერიტრეა	MM	მიანმა	UZ	უზბეკეთი
ES	ესპანეთი	MN	მონღოლეთი	VA	ვატიკანი
ET	ეთიოპია	MO	მაკაო	VC	სანტ-ვინსენტი და გრენადინები
FI	ფინეთი	MP	ჩრდ. მარიანას კუნძულები	VN	ვიეტნამი
FJ	ფიჯი	MR	მავრიტანია	VU	ვანუატუ
FK	ფოლკლენდის კუნძულები	MS	მოსკერავტი	WO	WIPO-ინტელექტუალური საკუთრების მსოფლიო ორგანიზაცია
FO	ფარერის კუნძულები	MT	მალტა	WS	სამოა
FR	საფრანგეთი	MU	მავრიკია	XN	ნორდული საპატენტო ინსტიტუტი (NPI)
GA	გაბონი	MV	მალდივის კუნძულები	YE	იემენი
GB	დიდი ბრიტანეთი	MW	მალავი	ZA	სამხრეთ აფრიკა
GC	სპარსეთის ყურის არაბული სახელმწიფოების თანამშრომლობის საბჭოს უწყება (GCC)	MX	მექსიკა	ZM	ზამბია
				ZW	ზიმბაბვე

შ ი ნ ა ა რ ს ი

გამოქვეყნებული ობიექტები	3
გამოგონებები	
• განაცხადები, რომლებზეც გამოტანილია გადანყვეტილება პატენტის გაცემის შესახებ	4
• გამოგონების პატენტები	8
სასარგებლო მოდელები	
• სასარგებლო მოდელების პატენტები	10
დიზაინები	
• განაცხადები, რომლებზეც გამოტანილია გადანყვეტილება რეგისტრაციის შესახებ	12
• დიზაინები, რომლებიც რეგისტრირებულია საერთაშორისო ბუროში საქართველოს ტერიტორიაზე უფლებათა გავრცელების მოთხოვნით	13
სასაქონლო ნიშნები	
• ეროვნული პროცედურით შემოტანილი განაცხადები, რომლებზეც გამოტანილია გადანყვეტილება რეგისტრაციის შესახებ	69
• რეგისტრირებული სასაქონლო ნიშნები	79
• დაჩქარებული პროცედურით რეგისტრირებული სასაქონლო ნიშნები	83
• საერთაშორისო სასაქონლო ნიშნები, რომლებზეც გამოტანილია გადანყვეტილება დაცვის მინიჭების შესახებ	85
• საერთაშორისო სასაქონლო ნიშნები, რომლებსაც მიენიჭა დაცვა საქართველოში	156
ოფიციალური შეტყობინებები	
სასაქონლო ნიშნები	
• რეგისტრაციის მოქმედების ვადის გაგრძელება	161
• უფლებების სრული გადაცემა	162
• მფლობელის სახელისა და/ან მისამართის ცვლილება	164
• სასაქონლო ნიშნების რეგისტრაციის ბათილად ცნობა	165
• საერთაშორისო სასაქონლო ნიშნის რეგისტრაციის გაუქმება	168
სისტემური საძიებლები	
გამოგონებები	169
სასარგებლო მოდელები	170
დიზაინები	171
სასაქონლო ნიშნები	172

გამოქვეყნებული ობიექტები

გამოგონებები

- განცხადები, რომლებზეც გამოტანილია გადაწყვეტილება პატენტის გაცემის შესახებ: 11738; 13311; 12537; 12697; 13248; 13078; 12747; 13220
- პატენტები: 6249-6252

სასარგებლო მოდელები

- პატენტები: 1846-1851

ღიზინები

- განცხადი, რომელზეც გამოტანილია გადაწყვეტილება რეგისტრაციის შესახებ: 815
- ღიზინები, რომლებიც რეგისტრირებულია საერთაშორისო ბიუროში საქართველოს ტერიტორიაზე უფლებათა გაცემის მოთხოვნით: 83370; 83383; 83392; 84515; 84534; 84546; 83414; 83453; 83488; 83490; 83494-83496; 83596; 84661; 84667; 83558; 83567; 84709; 84742; 84748; 83572; 83574; 83580; 84367; 84811; 84821; 83634; 83655; 83682; 83684; 84874; 83733; 83840; 84640

სასაქონლო ნიშნები

- ეროვნული პროცედურით შემოტანილი განცხადები, რომლებზეც გამოტანილია გადაწყვეტილება რეგისტრაციის შესახებ: 69118; 71153; 72155; 73130; 73136, 73137; 74755; 75090; 75095*; 75703; 75720; 76184; 76307; 76364-76366; 76421; 76459; 76460; 76710; 76736; 76739; 76785; 76842; 76847; 76956; 77098; 77127; 77329; 77347; 77348; 77370, 77371; 77466; 77531; 77553; 76974
- რეგისტრირებული სასაქონლო ნიშნები: 25664-25699
- ლაქარებული პროცედურით რეგისტრირებული სასაქონლო ნიშნები: 25660-25663; 25700
- საერთაშორისო სასაქონლო ნიშნები, რომლებზეც გამოტანილია გადაწყვეტილება დაცვის მინიჭების შესახებ: 73350*; 74142*; 74829*; 75185; 75363; 75396; 75399; 75407; 75513; 75560, 75561; 75564; 75566; 75575; 75577; 75591; 75592; 75608; 75610; 75648; 75662; 75671; 75677; 75681; 75687; 75689; 75691; 75710; 75717, 75718; 75722-75733; 75737; 75741, 75742; 75754-75757; 75760, 75761; 75770-75775; 75777; 75779-75782; 75789; 75831; 75838-75850; 75853-75859; 75861-75864; 75887; 75896-75900; 75903, 75904; 75911, 75912; 75964; 75966, 75967; 75969; 75976, 75977; 75983-75987; 76020; 76103; 76148; 76234; 76236; 76243; 76511; 76514; 76534; 76537; 76539-76542; 76544, 76545; 76547, 76548; 76599; 76604; 76610; 76613; 76626; 76656-76659; 76661-76665; 76679, 76680; 76682, 76683; 76712; 76782, 76783; 76982, 76983; 76989-76991; 77063, 77064; 77066-77071; 77080, 77081; 77084-77087; 77272-77274; 77278-77283; 77629-77637
- საერთაშორისო სასაქონლო ნიშნები, რომლებსაც მიენიჭა დაცვა საქართველოში: 71385; 72440; 72487; 72898; 73380; 73630; 73644; 73657; 73731; 74031; 74037; 74039; 74073; 74227; 74531; 74589; 74619; 74735; 74738-74741; 74746; 74748, 74749; 74752, 74753; 74764-74767; 74783; 74785-74790; 74792, 74793; 74998-75001; 75003; 75006, 75007; 75011-75016; 75035; 75044; 75129; 75139; 75141-75144; 75152-75155; 75252; 75260-75262; 75270; 75272; 75275; 75276

გამოგონებები

ბანასხალები, რომლებზეც გამოტანილია გადაწყვეტილება პატენტის გასაქმის შესახებ

გადაწყვეტილების გასაჩივრება შესაძლებელია საქპატენტის სააპელაციო პალატაში გამოქვეყნებიდან 3 თვის ვადაში ან მცხეთის რაიონული სასამართლოს ადმინისტრაციულ საქმეთა კოლეგიაში 1 თვის ვადაში (მის.: ქ. მცხეთა, სამხედროს ქ. №17).

ბანყოფილება A

A 01

(10) AP 2015 11738 A (51) Int. Cl. (2006)

A 01 N 25/02
A 01 N 43/90
A 01 N 45/02
A 01 N 43/56
A 01 N 43/36
A 01 N 47/30
A 01 N 43/653
A 01 N 43/70
A 01 N 51/00
A 01 N 43/54
A 01 N 37/34
A 01 N 35/10
A 01 N 39/02
A 01 P 3/00
A 01 P 7/04

(21) AP 2008 011738 (22) 2008 08 13

(31) 0716592.1

(32) 2007 08 24

(33) GB

(71) სინჯენტა ლიმიტედ (GB)

იუროპეან რეჯიონალ სენტრ, პრისტლი როუდ, სურეი რესერჩ პარკ, გილდფორდი, სურეი GU2 7YH (GB)

(72) გორდონ, ელასტეირ ბელი (GB);

კლერ, ლუიზ ჰარისი (GB);

იან, დევიდ ტოუგი (GB)

(74) თამარ კოჭლამაზაშვილი

(85) 2010 03 24

(86) PCT/GB2008/002730, 2008 08 13

(54) **გაუმჯობესებული ორბანული**

კომპოზიცია, მისი მიღების ხერხი და გამოყენება

(57) შემოთავაზებულია კომპოზიცია, რომელიც შეიცავს ნაერთს ფორმულით I



სადაც თითოეული R¹ და R² მნიშვნელობები მოყვანილია აღწერილობაში და, სულ მცირე, ერთ ბიოლოგიურად აქტიურ ნაერთს, რომელიც შეიცავს, სულ მცირე, ერთ არომატულ ხუთ და/ან ექვს წევრიან ციკლს, სადაც ციკლი შეიცავს, სულ მცირე, აზოტის ერთ

ატომს ციკლის ატომის სახით. ასეთი კომპოზიციები შეიძლება წარმოადგენდეს ემულსიურ კონცენტრატებს ან დამზადებული იყოს ემულსიური კონცენტრატებისგან. ასევე, შემოთავაზებულია კომპოზიციის მიღების ხერხი და მისი გამოყენება მცენარეთა მავნებლების წინააღმდეგ, აგრეთვე, სასოფლო-სამეურნეო მავნებლებთან ბრძოლის ხერხი.

მუხლები: 4 დამოუკიდებელი

21 დამოკიდებული

ცხრილი: 2

A 23

(10) AP 2015 13311 A (51) Int. Cl. (2006)

A 23 L 2/00

(21) AP 2013 013311 (22) 2013 12 05

(71) ზურაბ ძნელაძე (GE)

მეცნიერების ქ. 9, ბ. 5, 3500,

ოზურგეთი (GE);

მანუჩარ მამეიშვილი (GE)

26 მაისის ქ. 30, 3500, ოზურგეთი (GE)

(72) ზურაბ ძნელაძე (GE);

მანუჩარ მამეიშვილი (GE)

(54) **მატონიზირებული სასმელი „ბანამარო“**

(57) სასმელი, მას.-%-ში, შეიცავს: 9-15 შავი ბაიის ჩაის კონცენტრირებულ ექსტრაქტს, 1,5-4,5 ჩაის ღეროების სპირტიან ნაყენს, 1-3 კოლერს, 0,9-1,2 ლიმონმუავას, 0,3-0,5 ლიმონის ზეთს, 0,3-0,45 ნახშირორჟანგს, 1-3 აქტინიდის (კივი) ფოთლების სპირტიან ნაყენს და დანარჩენს-წყალს.

მუხლები: 1 დამოუკიდებელი

2 დამოკიდებული

ცხრილი: 1

A 61

(10) AP 2015 12537 A (51) Int. Cl. (2006)

A 61 K 8/97

A 61 Q 19/08

A 61 K 8/92

A 61 Q 19/00

A 61 Q 17/00

- (21) AP 2010 012537 (22) 2010 06 17
 (31) 0954235
 (32) 2009 06 22
 (33) FR
 (71) პიერ ფაბრ დერმო-კოსმეტიკ (FR)
 45, პლას აბელ განს, F- 92100 ბულონ
 ბიიანკური (FR)
 (72) ან მანდო (FR);
 ელენ დიუპლანი (FR)
 (74) შალვა გვარამაძე
 (85) 2012 01 17
 (86) PCT/FR2010/051207, 2010 06 17
 (54) **MORINGA SP.-ის მთლიანი**
თესლების მსტრაქტი და მისი
გამოყენება კოსმეტიკურ და/ან
დერმატოლოგიურ კომპოზიციებში
 (57) გამოგონება ეხება Moringa sp. გვარის მცენარეების M.oleifera-ს ან M.drouhardii-ს გარსიანი თესლების ექსტრაქტის, რომელიც შეიცავს ცხიმებს და პოლიფენოლებს, გამოყენებას დაბერების საწინააღმდეგო საშუალებების აქტიური კომპონენტის სახით კანის დაბერების ნიშნების წინააღმდეგ საბრძოლველად, აგრეთვე, კანის ბარიერული ფუნქციის გასაძლიერებლად და აღსადგენად.
 მუხლები: 3 დამოუკიდებელი
 5 დამოკიდებული

განყოფილება B

B 03

- (10) **AP 2015 12697 A** (51) **Int. Cl. (2006)**
B 03 B 13/00
 (21) AP 2012 012697 (22) 2012 05 04
 (71) მიხეილ გამცემლიძე (GE)
 ფანასკერტელის ქ. 15ა, ბ. 43, 0194,
 თბილისი (GE);
 როინ ენაგელი (GE)
 ჭონჭაძის ქ. 14, 0165, რუსთავი (GE);
 ასმათ შევილაძე (GE)
 თემქა X ბ კვარტ., კორპ. 2, ბ. 12, 0178,
 თბილისი (GE)
 (72) მიხეილ გამცემლიძე (GE);
 როინ ენაგელი (GE);
 ასმათ შევილაძე (GE)
 (54) **ფლოტაციის პროცესის მართვის**
ხერხი
 (57) ხერხი ითვალისწინებს მადნის მინერალიზაციის შემადგენლობის მაჩვენებლის, გადაფქვილი და თიხოვანი მასალის რაოდენობის, პულპის სიმკვრივის, ჰაერის ხარჯის, შემკრები და შემზღვეველი ფლოტაციური რეაგენტების ხარჯის გაზომვებსა და მიღებული სიგნალების ალგებრული ფაქტორების სტაბილიზაციას, ამასთან, დამატებით ახდენენ ქაფის პროდუქტში გადასული სასარგებლო კომპონენტების რაოდენობის განმსაზღვრელი ელექტრული წინაღობის – R გაზომვას, სიგნალების ფარდობის $(p+R)/m$ გამოთვლას, სადაც p პულპის სიმკვრივეა, ხოლო m პულპაში თიხოვანი მასალის რაოდენობაა. მიღებული სიგნალების ფარდობის შედარებით წინასწარ დადგენილ იმავე სიგნალების ფარდობასთან ახორციელებენ შემკრები ან შემზღვეველი რეაგენტების ხარჯის რეგულირებას.
 მუხლები: 1 დამოუკიდებელი
 ფიგურა: 1

B 62

- (10) **AP 2015 13248 A** (51) **Int. Cl. (2006)**
B 62 M 3/04
 (21) AP 2013 013248 (22) 2013 09 30
 (71) თამაზ ჯინჭარაძე (GE)
 ჟორდანიას ქ. 37, 6000, ბათუმი (GE);
 თეიმურაზ მიქელაძე (GE)
 გორგილაძის ქ. 95/101, ბ. 21, 6000,
 ბათუმი (GE);
 მარინა მიქელაძე (GE)
 ხოშტარის ქ. 27/31, ბ. 13, 0108,
 თბილისი (GE)
 (72) თამაზ ჯინჭარაძე (GE);
 თეიმურაზ მიქელაძე (GE);

მარინა მიქელაძე (GE)
 (54) ველოსიპედი
 (57) ველოსიპედს აქვს ჩარჩო 1, საჭე 2, სატერ-ფულეები 3, უნაგირი 4, სიმაღლეში გადაადგი-ლების შესაძლებლობის მქონე უნაგირის დამ-ჭერი საყრდენი სვეტი 5. უნაგირის სიმაღლეში გადაადგილება და ფიქსირება შესაძლებელია ველოსიპედით მგზავრობის დროს, რაც უზ-რუნველყოფილია: უნაგირის დამჭერი საყრ-დენი სვეტის მუდმივად მადემფირებული წა-მომწევი მექანიზმით 6, ჩარჩოში სიმაღლეში გადაადგილების შესაძლებლობის მქონე საყ-რდენ სვეტზე გათვალისწინებული ზედა და ქვედა შემზღვეველებით 7 და 8, უნაგირზე ვე-ლოსიპედისტი მხარ დაწოლის ძალის 9 შერ-ჩევით და მუდმივად მადემფირებული საყრდენი სვეტის მუხრუჭით 10, რომელიც იმართება საჭიდან, მაგალითად, საჭეზე დამაგრებული ბერკეტითა 11 და ტროსით 12.
 მუხლები: 1 დამოუკიდებელი ფიგურა: 1

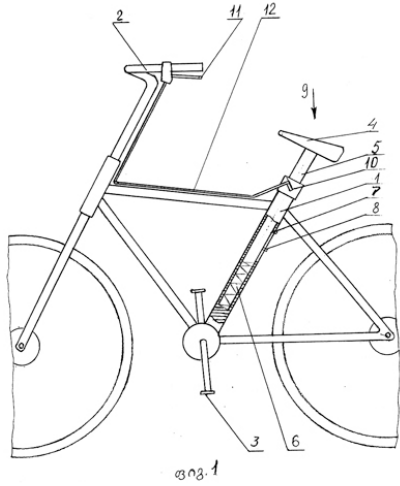

ბანყოფილება C

C 07

- (10) AP 2015 13078 A (51) Int. Cl. (2006)
 C 07 D 267/10
 C 07 D 413/04
 C 07 D 413/06
 C 07 D 413/10
 C 07 D 413/12
 C 07 D 413/14
 C 07 D 417/06
 C 07 D 417/14
- (21) AP 2011 013078 (22) 2011 10 05
- (31) 2010-227864; 2011-175336
- (32) 2010 10 07; 2011 08 10
- (33) JP; JP

- (71) ტაკედა ფარმასიუტიკალ კომპანი ლიმიტიდ (JP)
 1-1, დოშომაჩი 4-ჩომე, ჩუო-კუ, ოსაკა-ში, ოსაკა, 541- 0045 (JP)
- (72) იუჯი იშიჩი (JP);
 მასამი იამადა (US);
 ტაკუ კამეი (JP);
 იკუო ფუჯიმორი (US);
 იოშიჰისა ნაკადა (JP);
 ტომოია იუკავა (JP);
 ნობუკი საკაუჩი (JP);
 იუსუკე ოჰბა (JP);
 ტეტსუია ტსუკამოტო (JP)
- (74) შადვა გვარამაძე
- (85) 2013 05 02
- (86) PCT/JP2011/073745, 2011 10 05
- (54) 1,4 - ოქსაზეპანის წარმოებულეები
- (57) გამოგონება ეხება 1,4-ოქსაზეპანის წარ-მოებულეებს ფორმულით (I),

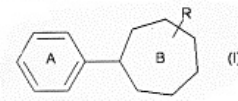

რომელიც ხასიათდება მონოამინების განმე-ორებითი შთანთქმის ძლიერი ინჰიბიტორული აქტიურობით. რგოლი A არის ჩანაცვლებული ფენილის რგოლი, რგოლი B წარმოადგენს არასავალდებულოდ ჩანაცვლებულ 1,4-ოქსა-ზეპანს.
 მუხლები: 12 დამოუკიდებელი
 5 დამოკიდებული

ბანყოფილება E

E 05

- (10) AP 2015 12747 A (51) Int. Cl. (2006)
 E 05 B 21/06
- (21) AP 2010 012747 (22) 2010 12 08
- (31) 20105001
- (32) 2010 01 04
- (33) FI
- (71) აბლოი ოი (FI)
 ვაჰლფორშინკატუ 20 ფი - 80100
 იონსუუ (FI)
- (72) სეპო კიისკი (FI)
- (74) ალექსანდრე გეგეჰკორი
- (85) 2012 06 12
- (86) PCT/FI2010/051006, 2010 12 08
- (54) მბრუნავისკომპონენი ცილინდრული საკეტი და ბასალები კომპონენია
- (57) კომპინაცია შეიცავს საკეტსა 1 და გა-სალებს 9. საკეტი შეიცავს გასალების ბრუნვის შემზღვეველ საშუალებას 3, ხოლო გასალებს 9 აქვს მიმართველი ზედაპირები გასალების

ბრუნვის შემზღვეველი საშუალებისთვის. გასაღების ბრუნვის შემზღვეველი საშუალება შეიცავს ჩარჩოს 6, რომელსაც აქვს გასაღების პროფილის მქონე ნახვრეტი 4. ჩარჩო შეიცავს საჩერებელ მექანიზმს 25, შემზღვეველ მექანიზმს 24 და გარსაცმს 5, რომელიც, სულ ცოტა, ნაწილობრივ გარს ერტყმის ჩარჩოს. საჩერებელი მექანიზმი და შემზღვეველი მექანიზმი განლაგებულია ერთ ხაზზე ისე, რომ შემზღვეველი მექანიზმი მოთავსებულია გასაღების პროფილის მქონე ნახვრეტის ერთ მხარეს, ხოლო საჩერებელი მექანიზმი მოთავსებულია გასაღების პროფილის მქონე ნახვრეტის საპირისპირო მხარეს.

მუხლები: 1 დამოუკიდებელი
14 დამოკიდებული

ფიგურა: 8

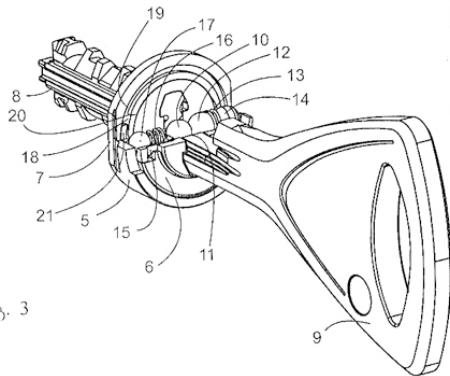

ფიგ. 3

განყოფილება F

F 03

(10) AP 2015 13220 A (51) Int. Cl. (2006)
F 03 B 3/18
F 03 B 1/00
F 15 D 1/04

(21) AP 2012 013220 (22) 2012 01 17

(31) 1150384

(32) 2011 01 18

(33) FR

(71) ალსტომ რინიუებლ ტექნოლოჯის (FR)
82, ავენიუ ლეონ ბლუმი, 38100
გრენობლი, საფრანგეთი (FR)

(72) თეოფანე ფოგია (FR);
ჯინ-ბერნარ ჰოუდელინი (FR)

(74) ლარისა ამირხანიანი

(85) 2013 09 05

(86) PCT/EP2012/050605, 2012 01 17

(54) მოღუნული მილსადენი განკუთვნილი ჰიდრაგლიკური მანქანისთვის, მანაწილებელი კვანძი პელტონის ტურბინის თვალისთვის და ჰიდრაგლიკური მანქანა

(57) გამოგონება განეკუთვნება ჰიდრაგლიკური მანქანის მოღუნულ მილსადენს 2 მასზე ნაკადის მისამართად. ამასთან, მილსადენს აქვს მის შიგა კედელზე დამაგრებული წიბოები 8, რომლებსაც აქვს ხვრელები.

მუხლები: 3 დამოუკიდებელი
7 დამოკიდებული

ფიგურა: 7

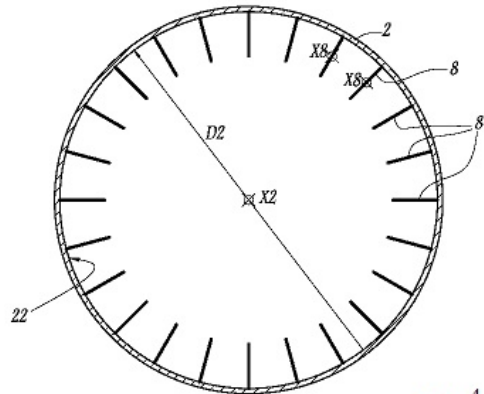

ფიგ. 4

გამომგონების კატეგორიები

განყოფილება A

A 01

- (11) P 2015 6252 B** (51) **Int. Cl. (2006)**
A 01 B 3/46
 (10) AP 2014 13342 A (44) 21(409)/2014
 (21) AP 2013 013342
 (22) 2013 12 27
 (24) 2013 12 27
 (73) ჯემალ კაციტაძე (GE)
 ერწოს ქ. 4, ბ. 138, 0192, თბილისი (GE);
 ივანე კაპანაძე (GE)
 გრ. ფერადის ქ. 5/1, ბ. 509, 0131,
 თბილისი (GE);
 ილია ბიძინაშვილი (GE)
 წყნეთის ქ., კორ. 1, ბ. 106, 0162,
 თბილისი (GE);
 სევერიან მასხაჭავაძე (GE)
 თემქის დას., II მკრ., კვარტ. 2, კორპ. 31,
 ბ. 32, 0191, თბილისი (GE)
 (72) ჯემალ კაციტაძე (GE);
 ივანე კაპანაძე (GE);
 ილია ბიძინაშვილი (GE);
 სევერიან მასხაჭავაძე (GE)
 (54) **ბუთანი ცვალებადი მოღების
 ბანი**

- (72) მარკ ჯი ბოკი (US);
 ქრისტოფ გაული (DE);
 ვენკატეშვარ რაო გუმადი (IN);
 საუმიტრა სენგუპტა (IN)
 (74) ალექსანდრე ქართველიშვილი
 (54) **1,3-ორჩანაცვლებული იმიდა-
 ზოლიდი-2-ონის წარმოებულები,
 როგორც CYP 17-ის ინჰიბიტორები**

- (11) P 2015 6251 B** (51) **Int. Cl. (2006)**
C 07 D 471/04
C 07 D 487/04
A 61 K 31/437
A 61 K 31/506
A 61 K 31/519
A 61 P 19/00
A 61 P 25/00
A 61 P 35/00

- (10) AP 2014 12896 A (44) 21(409)/2014
 (21) AP 2011 012896
 (22) 2011 04 20
 (24) 2011 04 20
 (31) 61/326,626; PCT/US2011/033192
 (32) 2010 04 21; 2011 04 10
 (33) US; WO
 (86) PCT/US2011/033192, 2011 04 20
 (73) პლექსიკონ, ინკ. (US)
 91 ბოლივარ დრაივ, სუიტ ა, ბერკლი,
 CA 94710 (US)
 (72) ცზიაჩუნ ჩჯანი (CN);
 პრაბჰა ნ. იბრაჰიმი (US);
 უეინ სპევაკი (US);
 ჯეიმს ტსაი (US);
 ტოდ იუნგი (US);
 ინგ ჩჯანი (CN);
 ჩაო ჩჯანი (US)
 (74) შალვა გვარამაძე
 (54) **ნაერთები და ხერხები კინაზას
 მოღუღირებისათვის და მათი
 გამოყენება**

განყოფილება C

C 07

- (11) P 2015 6250 B** (51) **Int. Cl. (2006)**
C 07 D 403/04
C 07 D 403/14
C 07 D 407/14
C 07 D 409/14
C 07 D 417/14
A 61 K 31/4178
A 61 P 35/00
 (10) AP 2014 12550 A (44) 21(409)/2014
 (21) AP 2010 012550
 (22) 2010 06 24
 (24) 2010 06 24
 (31) 1500/CHE/2009; 2181/DEL/2009
 (32) 2009 06 26; 2009 10 21
 (33) IN; IN
 (86) PCT/EP2010/059029, 2010 06 24
 (73) ნოვარტის აგ (CH)
 ლისტმეტრასე 35, CH-4056, ბაზელი (CH)

განყოფილება E

E 21

- (11) P 2015 6249 B (51) Int. Cl. (2006)
E 21 B 41/00
- (10) AP 2014 12347 A (44) 21(409)/2014
- (21) AP 2010 012347
- (22) 2010 01 22
- (24) 2010 01 22
- (31) 10 2009 007 453. 8
- (32) 2009 02 04
- (33) DE
- (86) PCT/DE2010/ 000059, 2010 01 22
- (73) ლეიბნიც - ინსტიტუტ ფურ
მეერესვისენშაფტენ (DE)
ვიშპოფსტრ. 1- 3, 24148 კიელ (DE)
- (72) კლაუს ვოლმენი (DE);
მატიას ჰაეკელი (DE)
- (74) ალექსანდრე გეგეჰკორი
- (54) ნახშირწყალბადების ჰიდრა-
ტებიდან გუნებრივი ბაზის
მიღების ხერხი, ბეოლოგიურ
ფორმაციებში ნახშირორქანის
ერთდროული დაბროვებით

სასარგებლო მოდელები

სასარგებლო მოდელების კატეგორიები

განყოფილება A

A 23

- (11) U 2015 1850 Y (51) Int. Cl. (2006)
A 23 L 1/221
- (10) AU 2014 13358 U (44) 21(409)/2014
(21) AU 2014 013358
(22) 2014 01 24
(24) 2014 01 24
- (73) ნუგზარ ქაცარაძე (GE)
სოფ. ქვედა საქარა, 2002,
ზესტაფონი (GE)
- (72) ნუგზარ ქაცარაძე (GE)
- (54) მცენარეული ნედლეულის ზეთიანი
ემულსიების მიღების ხერხი

A 61

- (11) U 2015 1846 Y (51) Int. Cl. (2006)
A 61 K 31/00
A 61 J 31/04
- (10) AU 2014 12582 U (44) 21(409)/2014
(21) AU 2012 012582
(22) 2012 02 20
(24) 2012 02 20
- (73) ეთერ ქემერტელიძე (GE)
პეკინის გამზ. 33ა, ბ. 40, 0160,
თბილისი (GE);
დურმიშხან ტურაბელიძე (GE)
გოთუას ქ. 22, ბ. 74, 0160,
თბილისი (GE)
- (72) ეთერ ქემერტელიძე (GE);
დურმიშხან ტურაბელიძე (GE)
- (54) კერატოლიზური მოქმედების
მქონე ფსორიაზის საწინააღმდეგო
მაკაბონს მიღების ხერხი

- (11) U 2015 1851 Y (51) Int. Cl. (2006)
A 61 K 35/10
A 61 K 35/12
A 61 K 36/00
- (10) AU 2014 13386 U (44) 21(409)/2014
(21) AU 2014 013386
(22) 2014 02 13
(24) 2014 02 13
- (73) ამალია შაყულაშვილი (GE)
წერეთლის ქ. 1, 0800, ახალციხე (GE)
- (72) ამალია შაყულაშვილი (GE)

- (54) კანის დაავადებების, ხანგრძლივად
შეუხორციელებელი ჰრილოზებისა და
დამწვრობის სამკურნალო მაკაბონს

- (11) U 2015 1847 Y (51) Int. Cl. (2006)
A 61 L 2/23
- (10) AU 2014 12801 U (44) 13(401)/2014
(21) AU 2012 012801
(22) 2012 07 19
(24) 2012 07 19
- (73) ვლადიმერ ფადიურაშვილი (GE)
კახეთის გზატკეცილი კორპ. 36ა, ბ. 24,
0190, თბილისი (GE);
თეა ფადიურაშვილი (GE)
მანაბლის ქ. 20/25, 0105, თბილისი (GE);
ზაზა ფადიურაშვილი (GE)
კახეთის გზატკეცილი 36ა, ბ. 24, 0190,
თბილისი (GE);
ნადეჟდა ელიავა (GE)
წითელწყაროს 2-ე შესახვევი, 8ა, 0103,
თბილისი (GE)
- (72) ვლადიმერ ფადიურაშვილი (GE);
თეა ფადიურაშვილი (GE);
ზაზა ფადიურაშვილი (GE);
ნადეჟდა ელიავა (GE)
- (54) საღებავების-სასტიმული-
ციო კომპოზიციის „ფადიურა-27“

განყოფილება C

C 05

- (11) U 2015 1849 Y (51) Int. Cl. (2006)
C 05 F 11/02
- (10) AU 2014 13234 U (44) 21(409)/2014
(21) AU 2013 013234
(22) 2013 09 18
(24) 2013 09 18
- (73) ქრისტო კახნიაშვილი (GE)
ლოლიძის ქ. 18, ბ. 44, 0171, თბილისი (GE);
კახაბერ ხუციშვილი (GE)
ბუდაპეშტის ქ. 13ა, ბ. 7, 0119, თბილისი (GE)
- (72) ქრისტო კახნიაშვილი (GE);
კახაბერ ხუციშვილი (GE)
- (54) ორბანულ-მინერალური სასუქის
მიღების ხერხი

ლიზენი

ბანასხადი, რომელზეც გამოტანილია გადაწყვეტილება რეგისტრაციის შესახებ

გადაწყვეტილების გასაჩივრება შესაძლებელია საქაატენტის სააპელაციო პალატაში გამოქვეყნებიდან 3 თვის ვადაში ან მცხეთის რაიონული სასამართლოს ადმინისტრაციულ საქმეთა კოლეგიაში 1 თვის ვადაში (მის.: ქ. მცხეთა, სამხედროს ქ. №17).

(10) AD 2015 815 S (51) 32-00

(21) AD 2014 000815

(22) 2014 08 26

(28) 1

(71) ლალი ჭუმბურიძე (GE)

დიდი დილომი, ტელევიზორების ქარხნის მიმდებარედ I კორპ. ბ. 2, 0131, თბილისი (GE)

(72) ლალი ჭუმბურიძე (GE)

(54) ბრავიკული სიმბოლო

(55)



ლიჯანიები, რომლების რეგისტრირებულია სავრთაშორისო ბიუროში საქართველოს ტერიტორიაზე უზღუდატა ბავრსელაბის მოთხოვნით

გადაწვეტილების გასაჩივრება შესაძლებელია საქპატენტის სააპელაციო პალატაში გამოქვეყნებიდან 3 თვის ვადაში ან მცხეთის რაიონული სასამართლოს ადმინისტრაციულ საქმეთა კოლეგიაში 1 თვის ვადაში (მის.: ქ. მცხეთა, სამხედროს ქ. №17).

- (11) **DM/083370** (51) **10-02**
- (15) 2014 04 15 (45) 2014/41 (2014 10 17)
- (22) 2014 04 15
- (28) 1
- (73) SWATCH AG (SWATCH SA) (SWATCH LTD.)
Jakob-Stämpfli-Strasse 94, CH-2502 Biel/Bienne (CH)
- (85) CH
- (86) CH
- (87) CH
- (88) CH
- (89) CH
- (81) II. BZ, MA. III. AL, AM, AZ, BA, CH, EM, GE, KG, LI, MC, MD, ME, MK, MN, NO, OM, SG, TJ, TN, TR, UA
- (72) Antonio FAZIO
Avenue de Cour 40,1007 Lausanne, Suisse
- (54) 1. Wristwatch
- (55)



(11) DM/083383

(51) 12-11

(15) 2014 04 15

(45) 2014/41 (2014 10 17)

(22) 2014 04 15

(28) 1

(30) 04.11.2013; 002337865; EM

(73) PIAGGIO & C. S.P.A.

Viale Rinaldo Piaggio, 25, I-56025 PONTEDERA (PISA) (IT)

(85) --

(86) EM, IT

(87) EM, IT

(88) EM, IT

(89) EM

(81) II. KP. III. AL, BA, CH, GE, IS, MC, MD, ME, MK, RS, SG, TR, UA

(72) Marco LAMBRI

c/o PIAGGIO & C. S.p.A. Viale Rinaldo Piaggio, 25, I-56025 Pontedera (PI), Italy;

Riccardo MINUTI

c/o PIAGGIO & C. S.p.A. Viale Rinaldo Piaggio, 25, I-56025 Pontedera (PI), Italy

(54) 1. Motor scooter

(55)

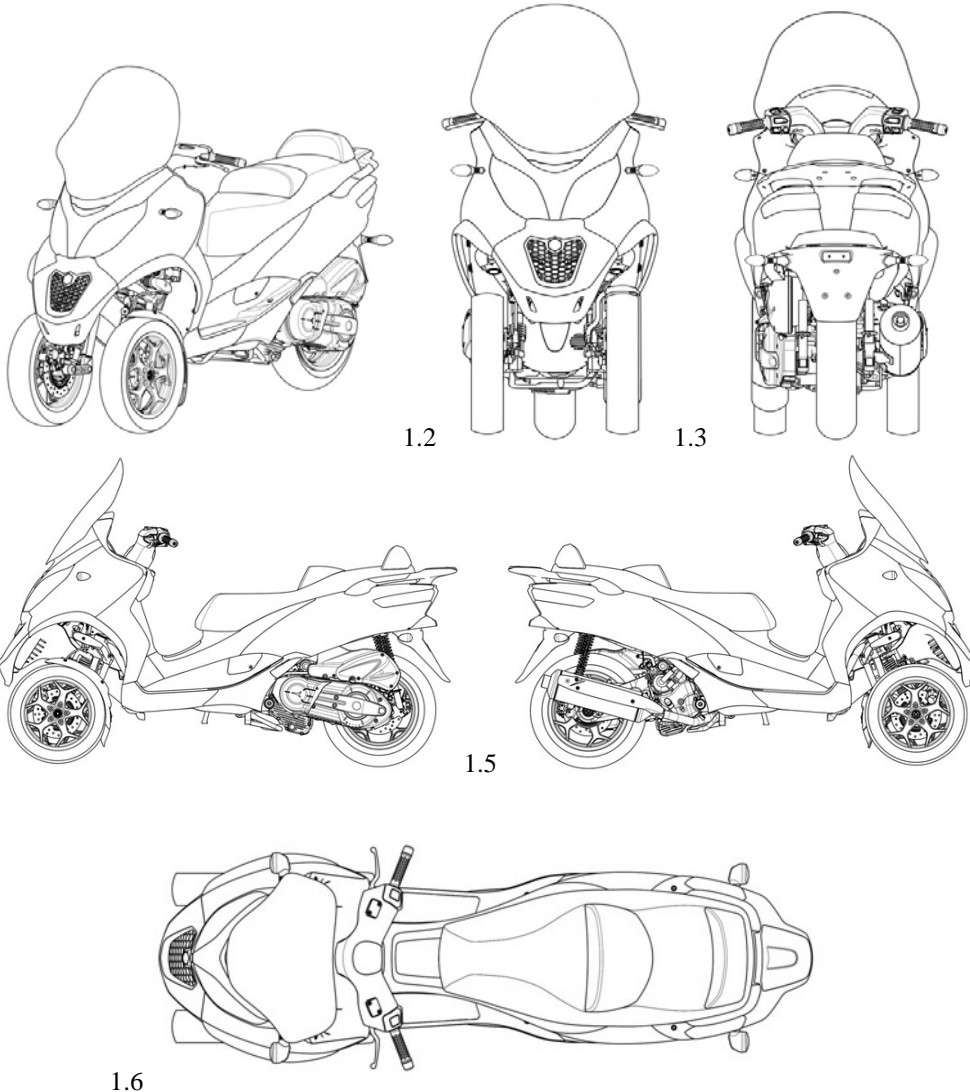

(11) DM/083392

(51) 10-02

(15) 2014 04 17

(45) 2014/41 (2014 10 17)

(22) 2014 04 17

(28) 2

(73) SWATCH AG (SWATCH SA) (SWATCH LTD.)

Jakob-Stämpfli-Strasse 94, CH-2502 Biel/Bienne (CH)

(85) CH

(86) CH

(87) CH

(88) CH

(89) CH

(81) II. BZ, MA. III. AL, AM, AZ, BA, CH, EM, GE, KG, LI, MC, MD, ME, MK, MN, NO, OM, SG, TJ, TN, TR, UA

(72) 1: Claudia CARIERI

Swatchlab, Via Archimede 6, I-20129 Milano, Italie;

2: Claudia CANNONE

Swatchlab, Via Archimede 6, I-20129 Milano, Italie

(54) 1.-2. Wristwatches

(55)



(11) DM/084515

(51) 10-06

(15) 2014 09 19

(45) 2014/41 (2014 10 17)

(22) 2014 09 19

(28) 1

(73) GUNSAN ELEKTRİK MALZEMELERİ SANAYİ VE TİCARET ANONİM ŞİRKETİ

Osmangazi Mahallesi, Yıldırım Beyazıt Caddesi No: 29, SANCAKTEPE İSTANBUL (TR)

(85) TR

(86) TR

(87) TR

(88) TR

(89) TR

(81) III. AL, AZ, BA, EG, EM, GE, RS, SY, UA

(72) MURAT GÜN

Osmangazi Mah., Yıldırım Beyazıt Cad.No:29, Sancaktepe, 34887 İSTANBUL, Turkey

(54) 1. Hotel doorbell system

(55)

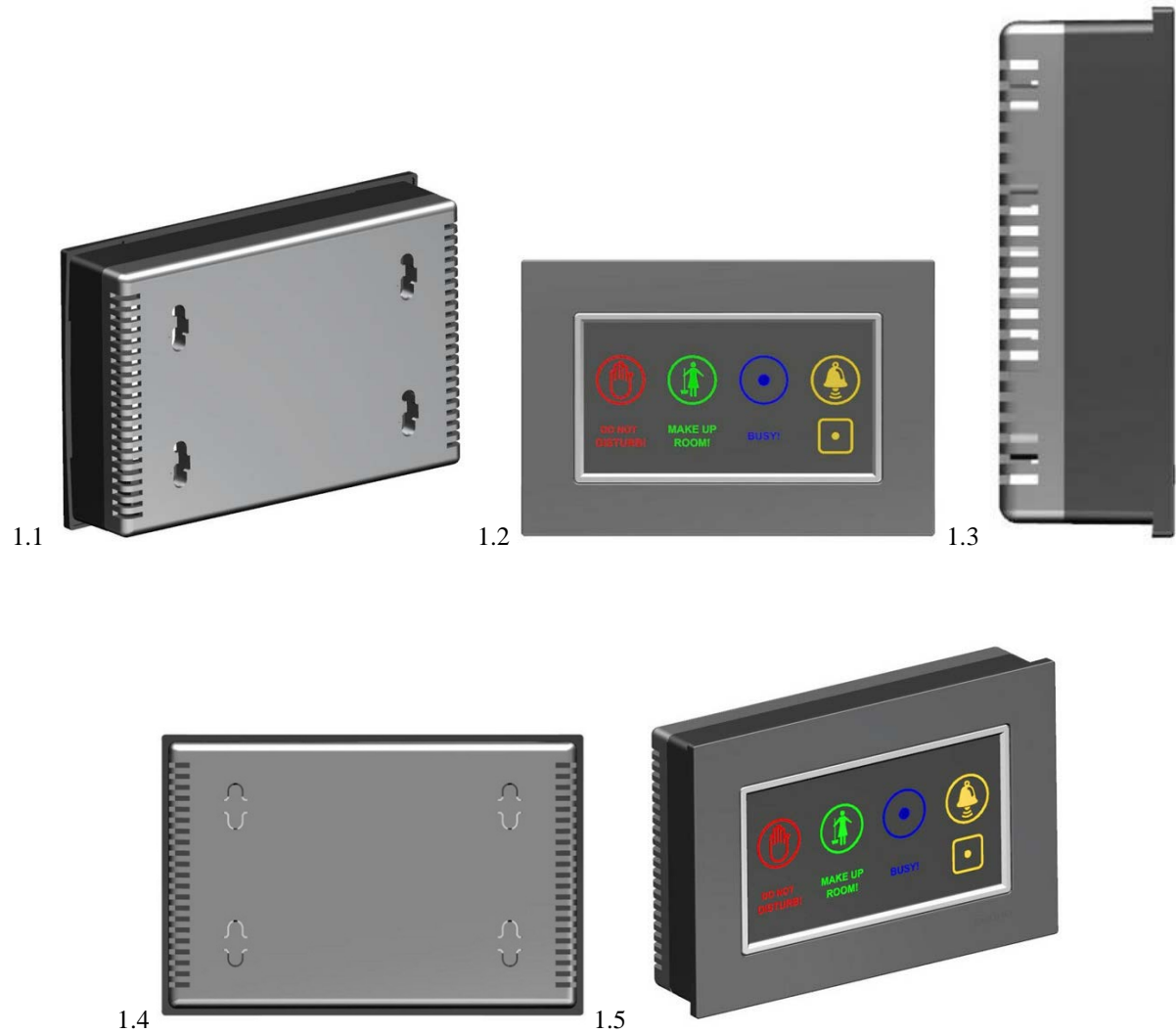

- (11) **DM/084534** (51) **21-01**
 (15) 2014 07 22 (45) 2014/41 (2014 10 17)
 (22) 2014 07 22
 (28) 1
 (30) 04.06.2014; 518028; CN
 (73) STRETENTSEV PAVLO
 Boulevard Lesi Ukrainki 8, ap. 44, Kiev 01133 (UA)
 (85) --
 (86) UA
 (87) n/a
 (88) n/a
 (89) UA
 (81) III. AM, AZ, EM, GE, TR, UA
 (72) 1: Svytoslav Itkin
 Amnon ve Tamar street 9a/7,42202 Netanya, Israel
 (54) 1. Backgammon board
 (55)

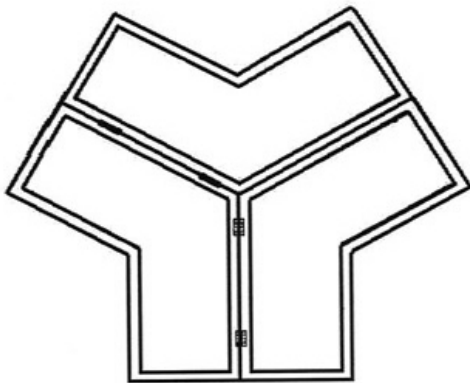

1.1

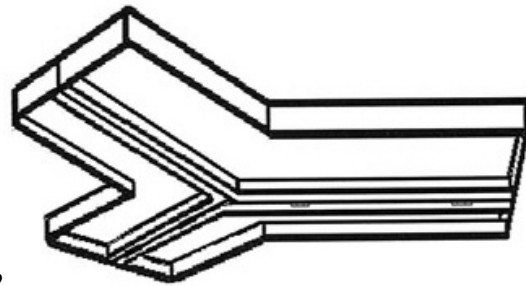

1.2

(11) DM/084546

(51) 32-00

(15) 2014 09 30

(45) 2014/41 (2014 10 17)

(22) 2014 09 30

(28) 7

(73) VALENTINO S.P.A.

Via Turati, 16/18, I-20121 MILANO (IT)

(85) --

(86) EM, IT

(87) EM, IT

(88) EM, IT

(89) EM

(81) III. AZ, EM, GE, KG, ME, RS, TJ, TR, UA

(54) 1.-7. Ornamentation

(55)

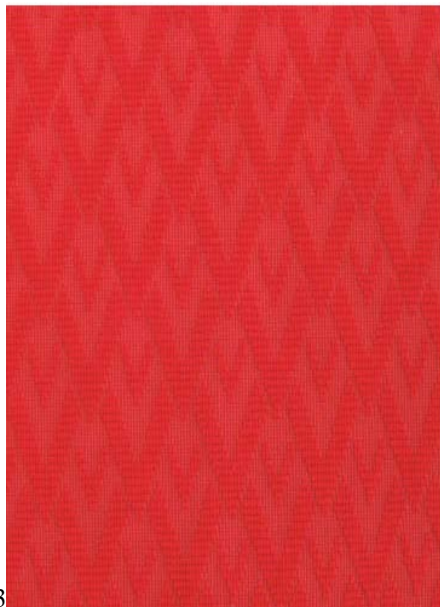

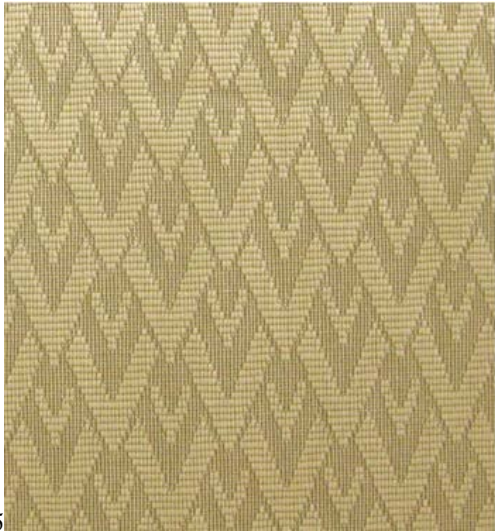

5



6



7

(11) DM/083414

(51) 10-02

(15) 2014 04 22

(45) 2014/42 (2014 10 24)

(22) 2014 04 22

(28) 2

(73) SWATCH AG (SWATCH SA) (SWATCH LTD.)

Jakob-Stämpfli-Strasse 94, CH-2502 Biel/Bienne (CH)

(85) CH

(86) CH

(87) CH

(88) CH

(89) CH

(81) II. BZ, MA. III. AL, AM, AZ, BA, CH, EM, GE, KG, LI, MC, MD, ME, MK, MN, NO, OM, SG, TJ, TN, TR, UA

(72) 1: Patrizio VITA

Swatchlab, Via Archimede 6, 20129 Milano, Italie;

2: Antonio FAZIO, Avenue de Cour 40, 1007 Lausanne, Suisse

(54) 1.-2. Wristwatches

(55)



(11) DM/083453

(51) 10-02

(15) 2014 04 25

(45) 2014/43 (2014 10 31)

(22) 2014 04 25

(28) 1

(73) SWATCH AG (SWATCH SA)(SWATCH LTD.)

Jakob-Stämpfli-Strasse 94, CH-2502 Biel/Bienne (CH)

(85) CH

(86) CH

(87) CH

(88) CH

(89) CH

(81) II. BZ, MA. III. AL, AM, AZ, BA, CH, EM, GE, KG, LI, MC, MD, ME, MK, MN, NO, OM, SG, TJ, TN, TR, UA

(72) 1: Patrizio VITA

Congiunte dx, 30, 04100 Latina, Italie

(54) 1. Wristwatch

(55)



1.1



1.2

(11) DM/083488

(15) 2014 04 30

(22) 2014 04 30

(28) 8

(30) for designs No(s) 1, 5: 30.10.2013; 002336057-0001; EM;
 for designs No(s) 2, 6: 30.10.2013; 002336057-0002; EM;
 for designs No(s) 3, 7: 30.10.2013; 002336057-0003; EM;
 for designs No(s) 4, 8: 30.10.2013; 002336057-0004; EM;
 for designs No(s) 1, 5: 30.10.2013; 002336057-0005; EM;
 for designs No(s) 2, 6: 30.10.2013; 002336057-0006; EM;
 for designs No(s) 3, 7: 30.10.2013; 002336057-0007; EM;
 for designs No(s) 4, 8: 30.10.2013; 002336057-0008; EM

(73) BORIS TATIEVSKI

Martin-Buber-Str. 12, 14163 Berlin (DE)

(85) n/a

(86) DE, EM

(87) n/a

(88) n/a

(89) EM

(81) II. MA. III. AL, AM, AZ, BA, BW, CH, EG, GE, GH, IS, KG, MD, ME, MK, MN, NA, NO, OA, OM, RS, SG, ST, SY, TJ, TN, TR, UA

(72) 1-8: Boris Tatievski

Martin-Buber-Strasse 12, 14163 Berlin, Germany

(54) 1.-8. Canisters

(55)



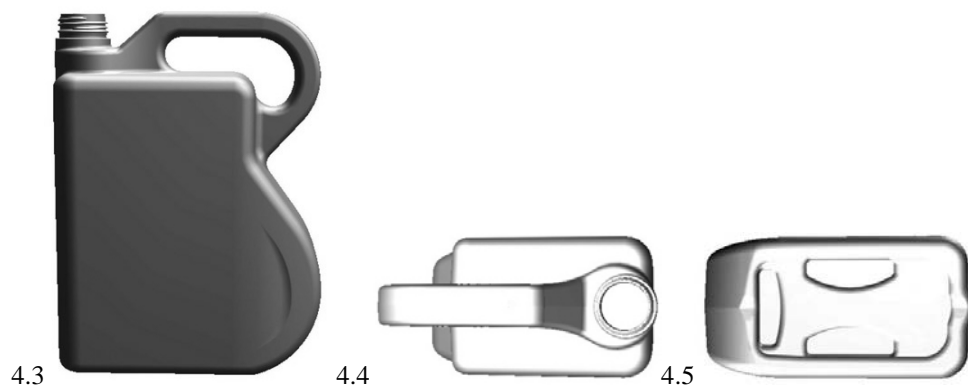
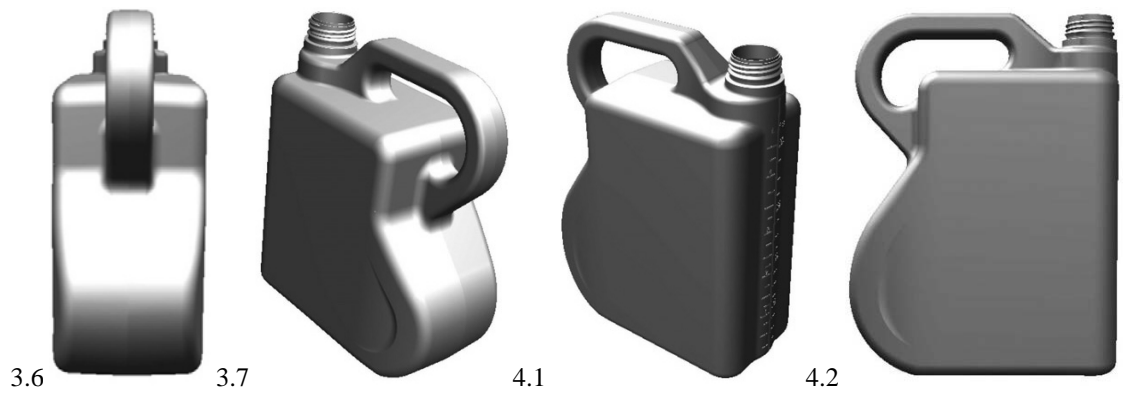
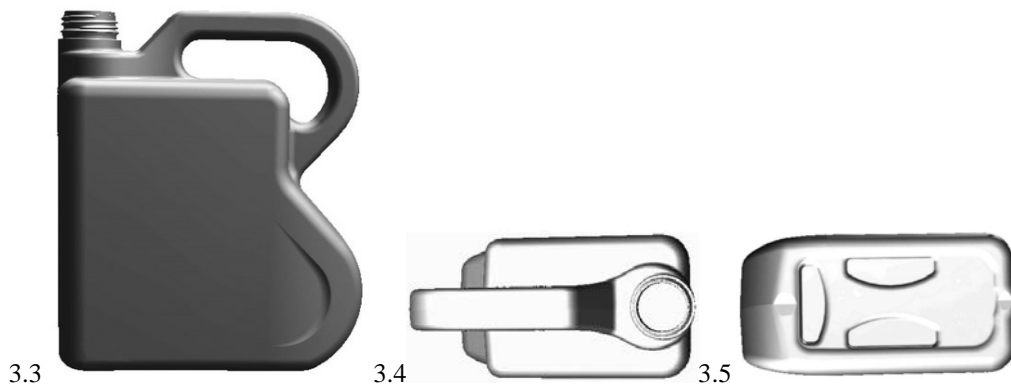
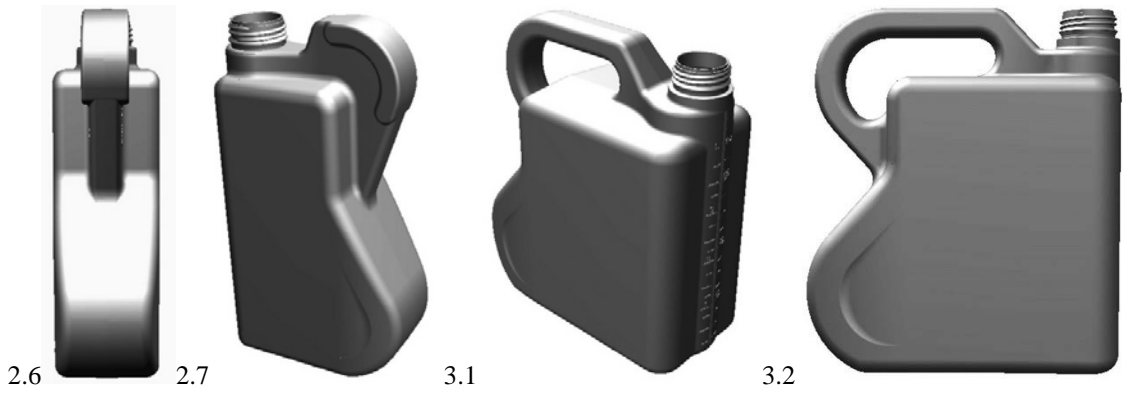

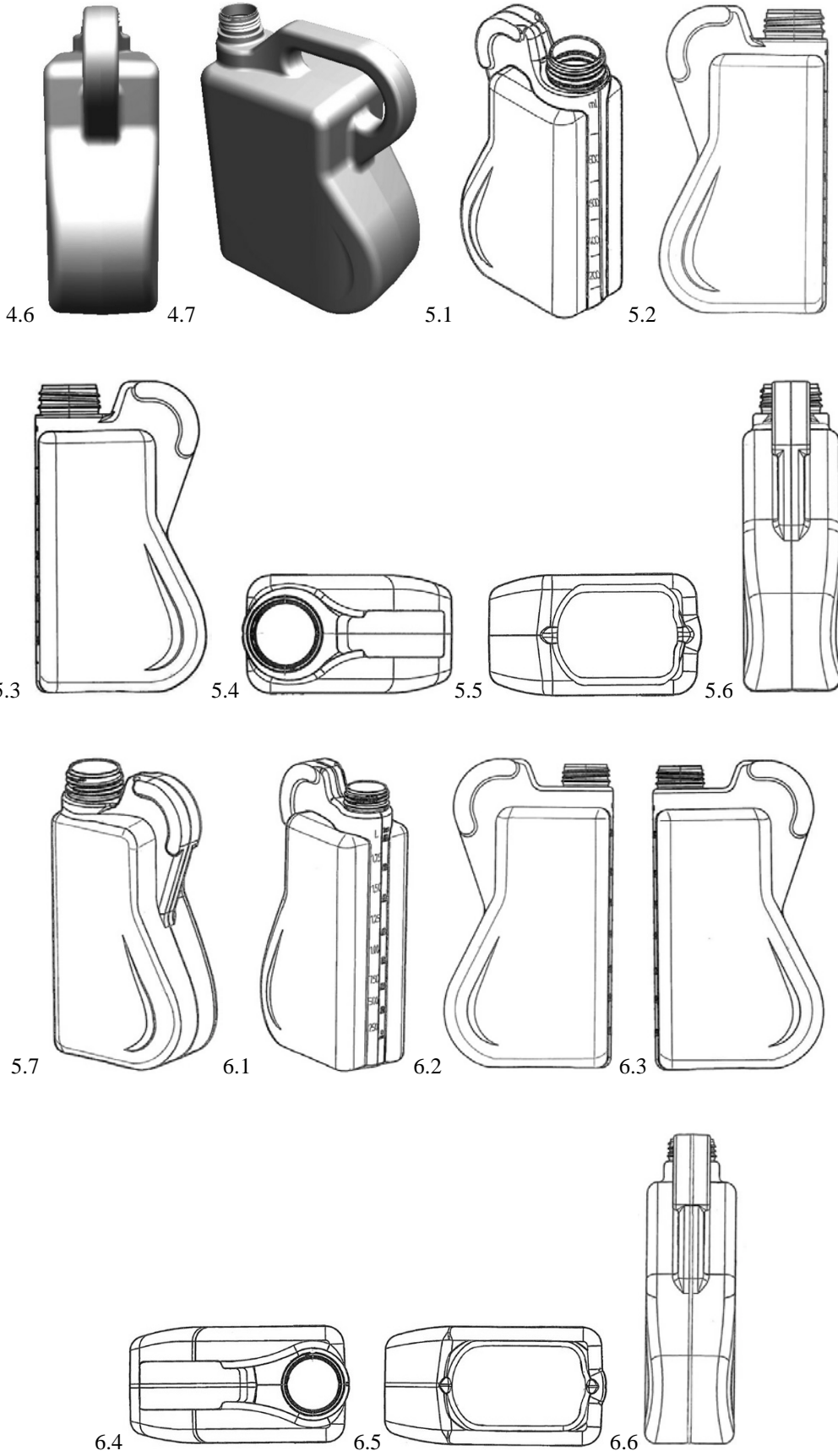

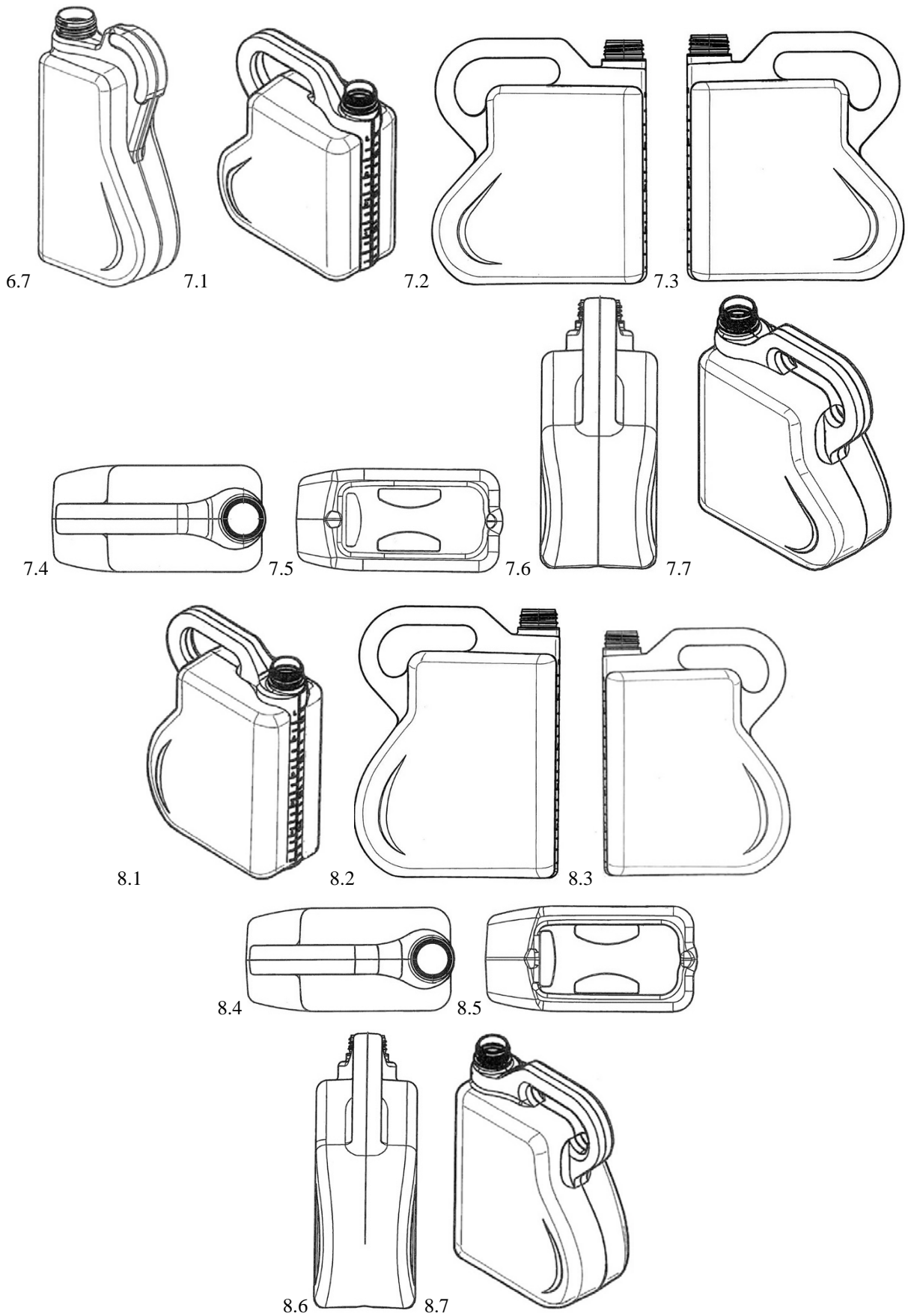

(11) DM/083490

(51) 09-03

(15) 2014 04 30

(45) 2014/43 (2014 10 31)

(22) 2014 04 30

(28) 17

(73) BIOFARMA

50 rue Carnot F-92284 SURESNES CEDEX (FR)

(85) --

(86) FR, EM

(87) n/a

(88) n/a

(89) FR

(81) II. MA. III. BA, CH, EG, EM, GE, GH, ME, MK, NA, OA, OM, RS, SG, TN, TR, UA

(72) 1-17: SERVIER INTERNATIONAL

50 rue Carnot, 92284 SURESNES Cédex, France

(54) 1.-17. Product packagings

(55)

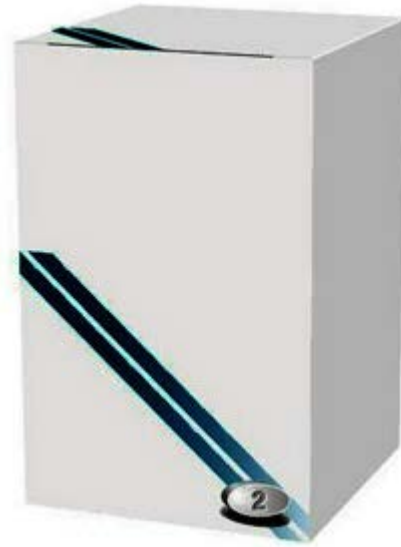
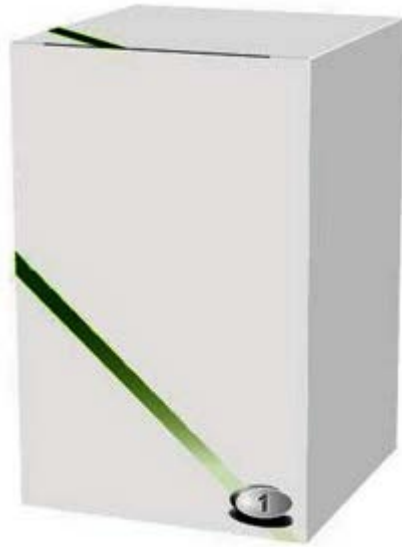
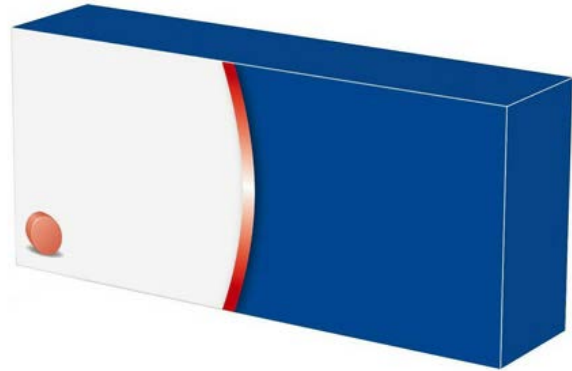
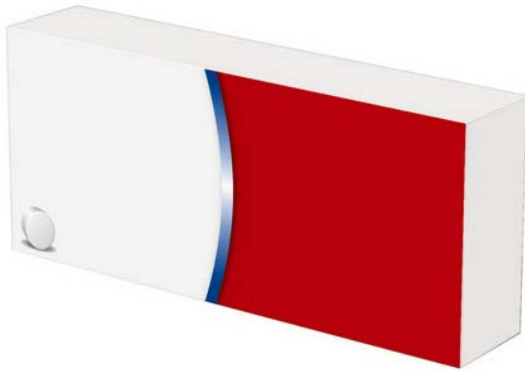

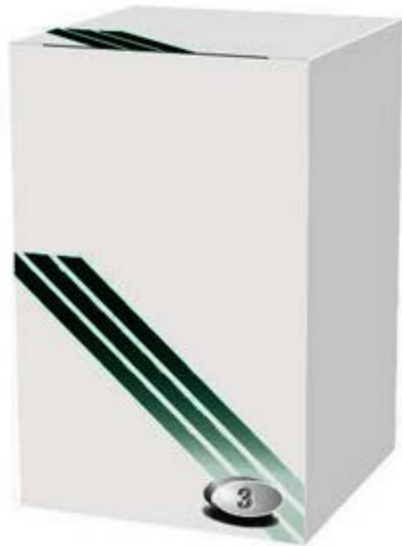

5



6



7

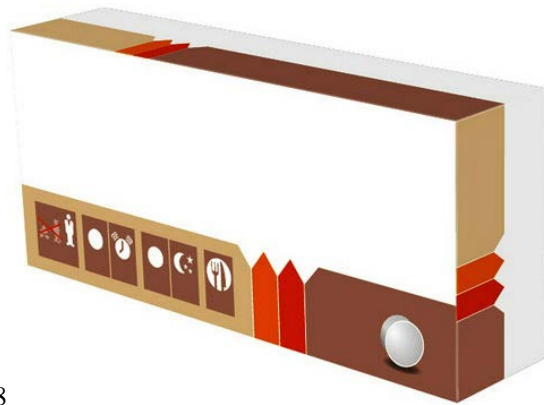

8

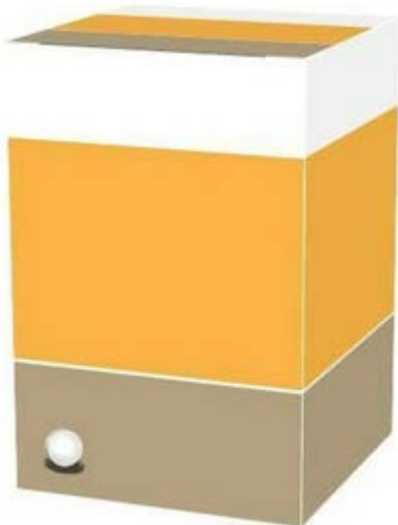

9



10



11



12



13



14



15



16

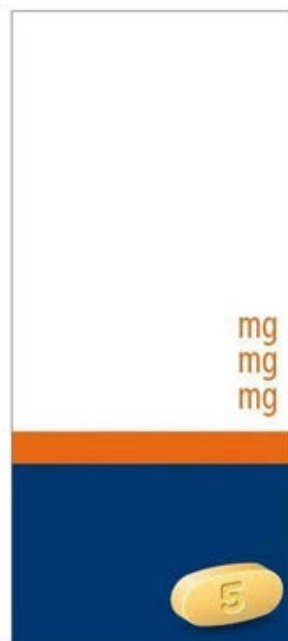

17

(11) DM/083494

(51) 10-02

(15) 2014 04 25

(45) 2014/43 (2014 10 31)

(22) 2014 04 25

(28) 1

(73) SWATCH AG (SWATCH SA) (SWATCH LTD.)

Jakob-Stämpfli-Strasse 94, CH-2502 Biel/Bienne (CH)

(85) CH

(86) CH

(87) CH

(88) CH

(89) CH

(81) II. BZ, MA. III. AL, AM, AZ, BA, CH, EM, GE, KG, LI, MC, MD, ME, MK, MN, NO, OM, SG, TJ, TN, TR, UA

(72) 1: Claudia CARIERI

Via Enrico Toti, 28, I-20862 Arcore, Italie

(54) 1. Wristwatch

(55)



1.1



1.2

(11) DM/083495

(51) 10-02

(15) 2014 04 25

(45) 2014/43 (2014 10 31)

(22) 2014 04 25

(28) 6

(73) SWATCH AG (SWATCH SA) (SWATCH LTD.)

Jakob-Stämpfli-Strasse 94, CH-2502 Biel/Bienne (CH)

(85) CH

(86) CH

(87) CH

(88) CH

(89) CH

(81) II. BZ, MA. III. AL, AM, AZ, BA, CH, EM, GE, KG, LI, MC, MD, ME, MK, MN, NO, OM, SG, TJ, TN, TR, UA

(72) 1: Patrizio VITA

Congiunte dx, 30, I-04100 Latina, Italie;

2: Claudia CANNONE

Via Giovanni Papini, 23, I-20900 Monza, Italie;

3-5: Min KIM, St. Alban-Ring 238, CH-4052 Basel, Suisse;

6: Antonio FAZIO, Avenue de Cour 40, CH-1007 Lausanne, Suisse

(54) 1.-6. Wristwatches

(55)





(11) DM/083496

(51) 10-07

(15) 2014 04 25

(45) 2014/43 (2014 10 31)

(22) 2014 04 25

(28) 1

(73) SWATCH AG (SWATCH SA) (SWATCH LTD.)

Jakob-Stämpfli-Strasse 94, CH-2502 Biel/Bienne (CH)

(85) CH

(86) CH

(87) CH

(88) CH

(89) CH

(81) II. BZ, MA. III. AL, AM, AZ, BA, CH, EM, GE, KG, LI, MC, MD, ME, MK, MN, NO, OM, SG, TJ, TN, TR, UA

(72) 1: Min KIM

St. Alban-Ring 238, CH-4052 Basel, Suisse

(54) 1. Watch strap

(55)

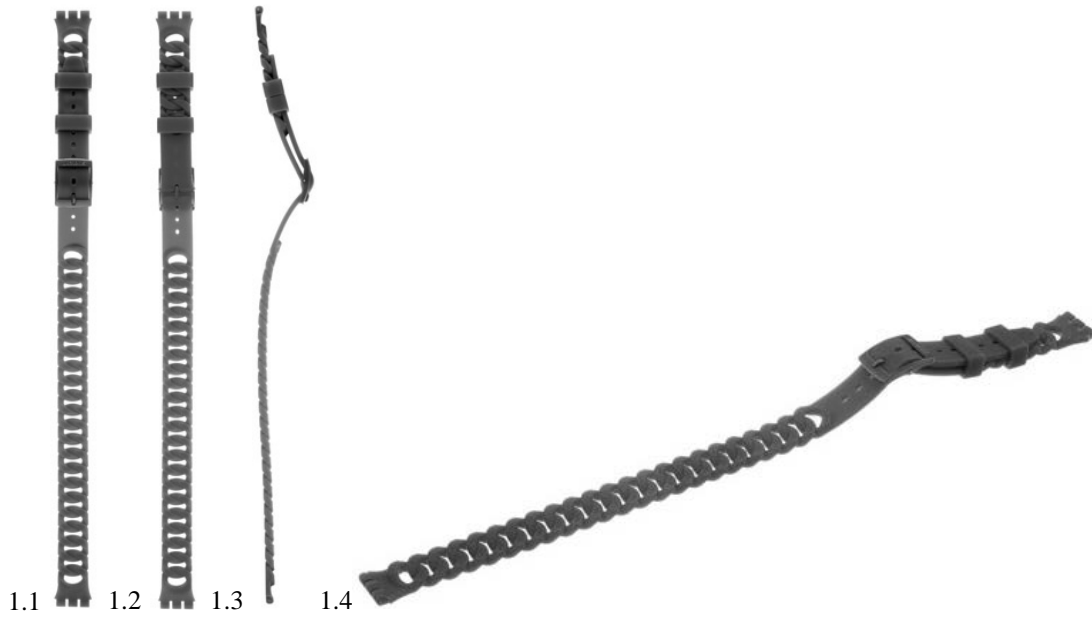

(11) DM/083596

(51) 10-02

(15) 2014 04 25

(45) 2014/43 (2014 10 31)

(22) 2014 04 25

(28) 2

(73) ETA SA MANUFACTURE HORLOGÈRE SUISSE

Schild-Rust-Strasse 17, CH-2540 Grenchen (CH)

(85) CH

(86) CH

(87) CH

(88) CH

(89) CH

(81) II. BZ, MA. III. AL, AM, AZ, BA, CH, EM, GE, KG, LI, MC, MD, ME, MK, MN, NO, OM, SG, TJ, TN, TR, UA

(72) 1-2: Véronique STOLL

Chemin de la Marnière 14A, CH-2504 Biel/Bienne, Suisse

(54) 1.-2. Wristwatches

(55)



(11) DM/084661

(51) 13-03

(15) 2014 01 24

(45) 2014/43 (2014 10 31)

(22) 2014 01 24

(28) 8

(30) for designs No(s) 1, 2, 3, 4, 5, 6, 7, 8: 24.07.2013; 2013 05441/1; TR;

for designs No(s) 1, 2, 3, 4, 5, 6, 7, 8: 24.07.2013; 2013 05441/2; TR;

for designs No(s) 1, 2, 3, 4, 5, 6, 7, 8: 24.07.2013; 2013 05441/3; TR;

for designs No(s) 1, 2, 3, 4, 5, 6, 7, 8: 24.07.2013; 2013 05441/4; TR;

for designs No(s) 1, 2, 3, 4, 5, 6, 7, 8: 24.07.2013; 2013 05441/5; TR;

for designs No(s) 1, 2, 3, 4, 5, 6, 7, 8: 24.07.2013; 2013 05441/6; TR;

for designs No(s) 1, 2, 3, 4, 5, 6, 7, 8: 24.07.2013; 2013 05441/7; TR;

for designs No(s) 1, 2, 3, 4, 5, 6, 7, 8: 24.07.2013; 2013 05441/8; TR

(73) VİKO ELEKTRİK VE ELEKTRONİK ENDÜSTRİSİ SANAYİ VE TİCARET ANONİM ŞİRKETİ
Abdurrahmangazi Mah., Ebubekir Cad. No: 44, Samandıra Kartal, TR-34887 İstanbul (TR)

(85) TR

(86) TR

(87) TR

(88) TR

(89) TR

(81) III. EM, GE, KG, UA

(72) No. 1 MIRZAT KOÇ

Abdurrahmangazi Mah. Ebubekir Cd. No:44, 34887 Sancaktepe - ISTANBUL / TURKEY;

No. 2 FULYA TURGUT

Abdurrahmangazi Mah. Ebubekir Cd. No:44, 34887 Sancaktepe - ISTANBUL / TURKEY

(54) 1. Two-gang earthed group socket with switch; 2. Two-gang earthed group socket;

3. Three-gang earthed group socket with switch; 4. Three-gang earthed group socket;

5. Four-gang earthed group socket with switch; 6. Four-gang earthed group socket;

7. Six-gang earthed group socket with switch; 8. Six-gang earthed group socket

(55)

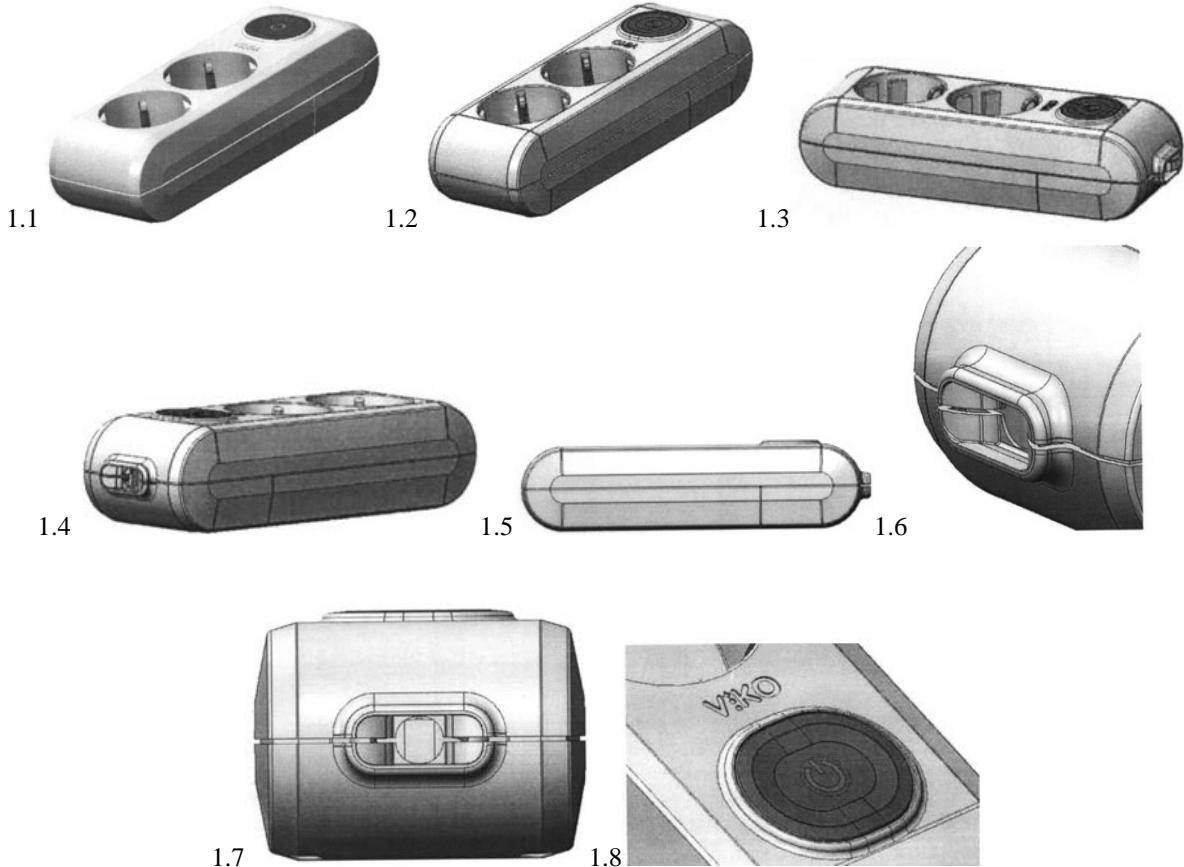

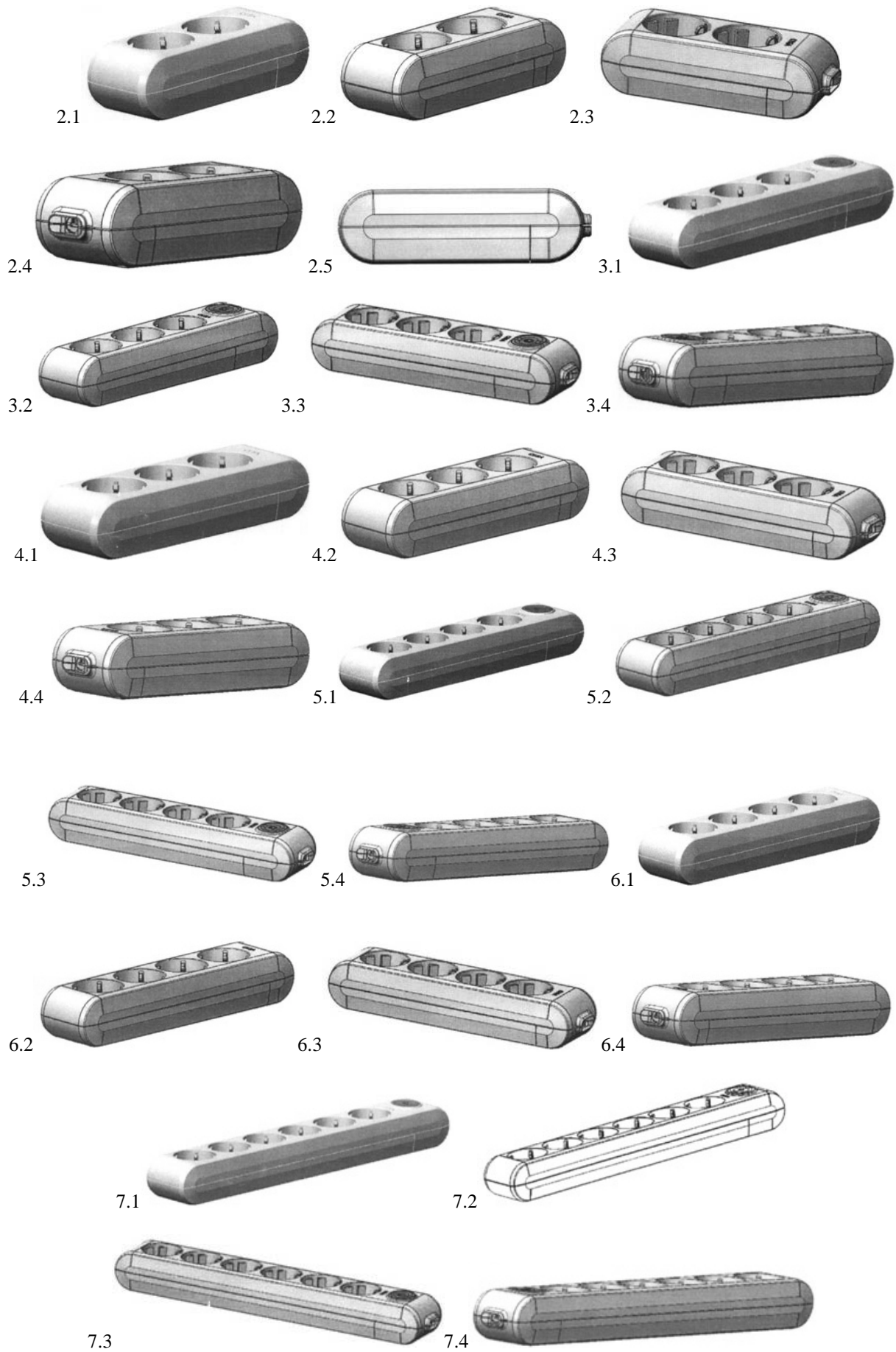

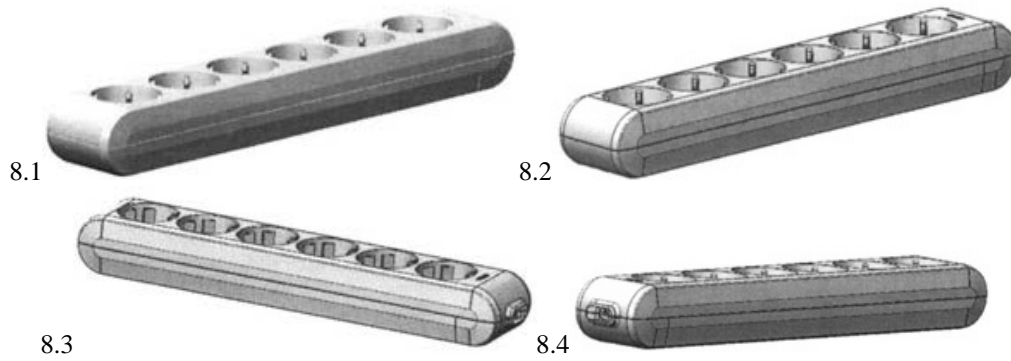

- (11) DM/084667 (51) 13-03
 (15) 2014 09 30 (45) 2014/43 (2014 10 31)
 (22) 2014 09 30 (28) 2
 (30) 16.06.2014; 2014/04386; TR
 (73) GUNSAN ELEKTRIK MALZEMELERI SANAYI VE TICARET ANONIM SIRKETI
 Osmangazi Mahallesi Yildirim Beyazit Caddesi No:29, Sancaktepe/Istanbul (TR)
 (85) TR
 (86) TR
 (87) TR
 (88) TR
 (89) TR
 (81) III. AL, AZ, BA, EG, EM, GE, RS, SY, UA
 (72) MURAT GUN
 Osmangazi Mah. Yildirim Beyazit Cad.No:29 Sancaktepe, 34887 ISTANBUL, Turkey
 (54) 1.-2. Dimmers
 (55)

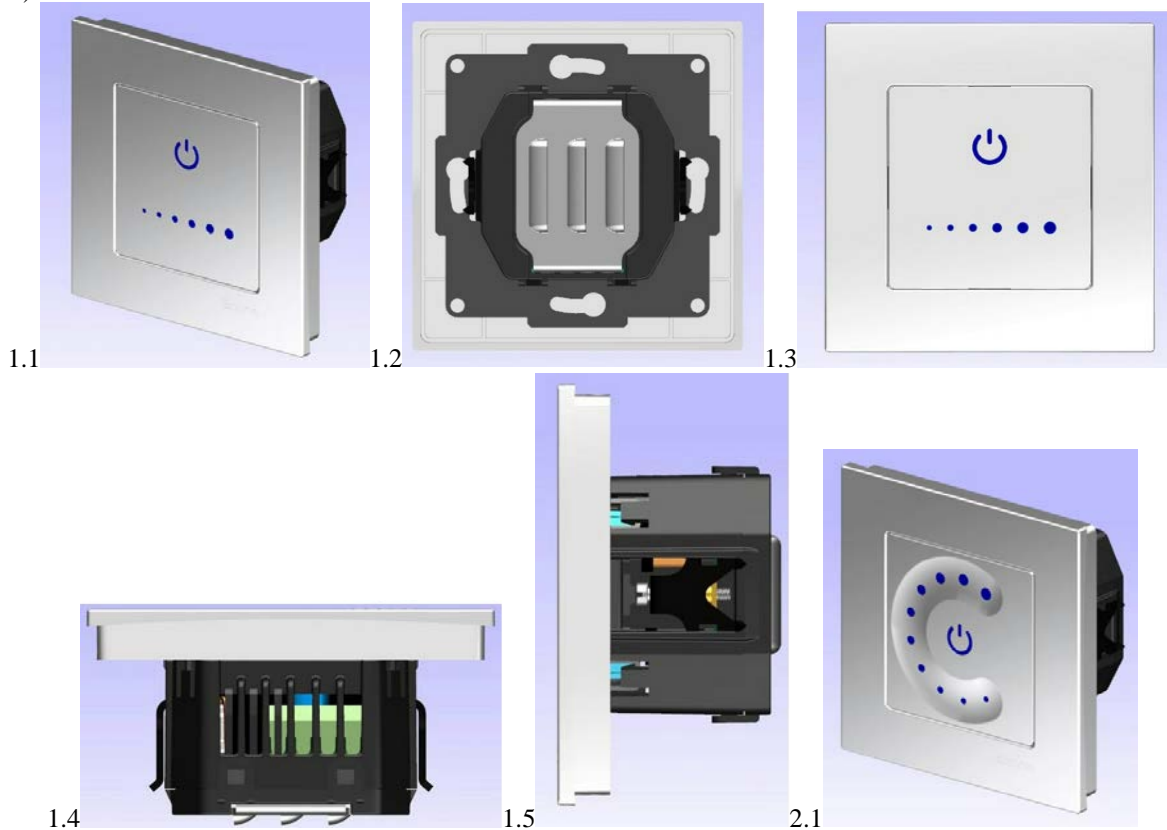

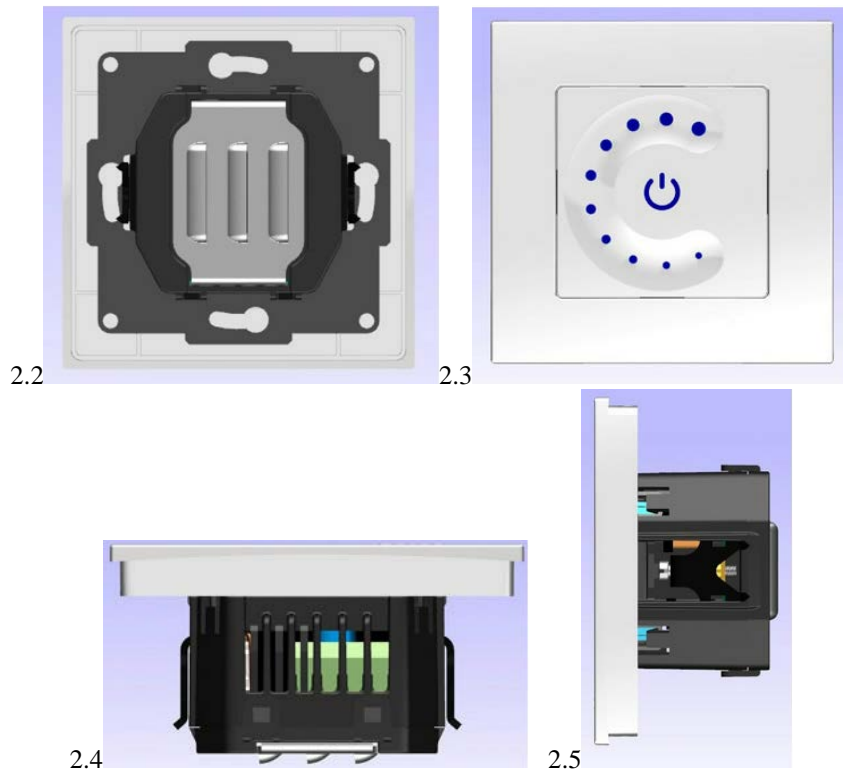

(11) DM/083558

(15) 2014 05 02

(22) 2014 05 02

(28) 1

(73) CERTINA AG (CERTINA SA) (CERTINA LTD.)
17, chemin des Tourelles, CH-2400 LE LOCLE (CH)

(85) CH

(86) CH

(87) CH

(88) CH

(89) CH

(81) II. BZ, MA. III. AL, AM, AZ, BA, CH, EM, GE, KG, LI, MC, MD, ME, MK, MN, NO, OM, SG, TJ, TN, TR, UA

(72) 1: Lorenzo VALLONE

Via Volta 16, 6830 Chiasso, Suisse

(54) 1. Watch case

(55)





(11) DM/083567

(15) 2014 05 07

(22) 2014 05 07

(28) 5

(73) HARRY WINSTON SA

Chemin du Tourbillon 8, CH-1228 Plan-les-Ouates (CH)

(85) CH

(86) CH

(87) CH

(88) CH

(89) CH

(81) II. BZ, MA. III. AL, AM, AZ, BA, CH, EM, GE, KG, LI, MC, MD, ME, MK, MN, NO, OM, SG, TJ, TN, TR, UA

(72) Dominique Rivière

360 E. 72nd Street, Apt.Nb1003, 10021 New York N.Y., États-Unis d'Amérique

(54) 1. Ring; 2. Necklace; 3. Ring; 4. Necklace; 5. Earring

(55)

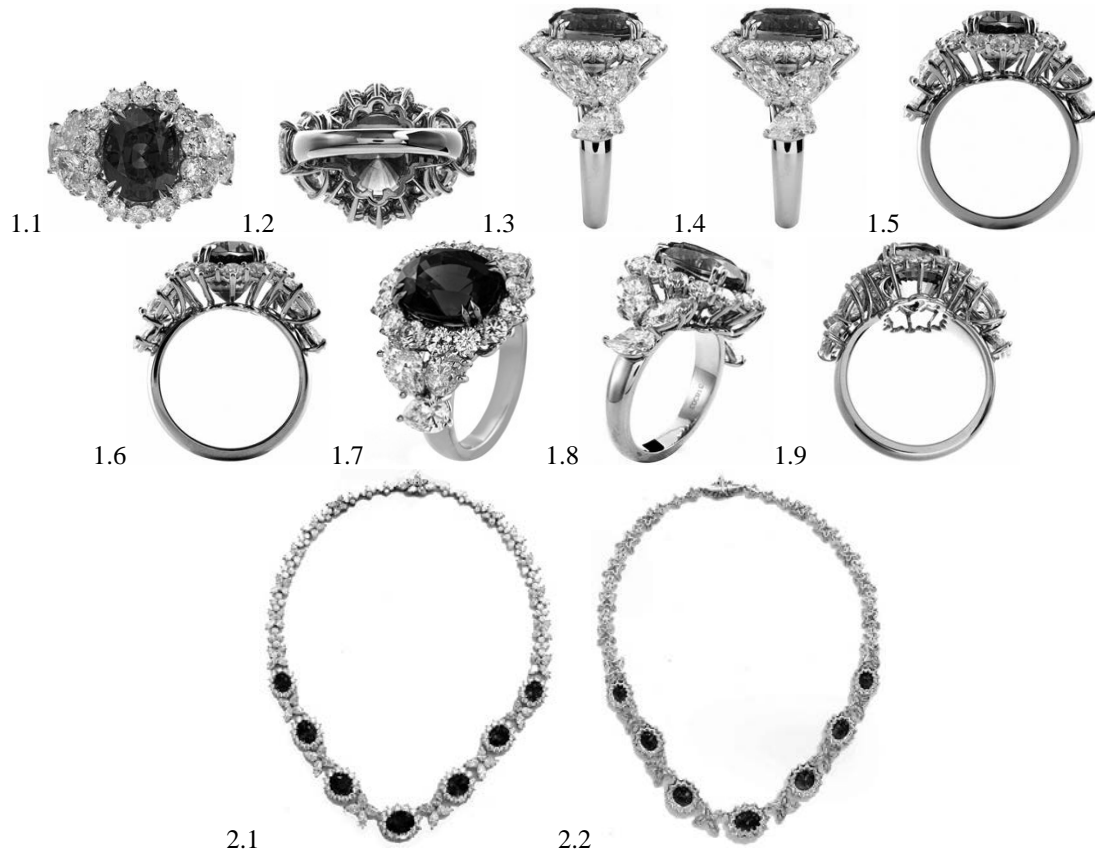

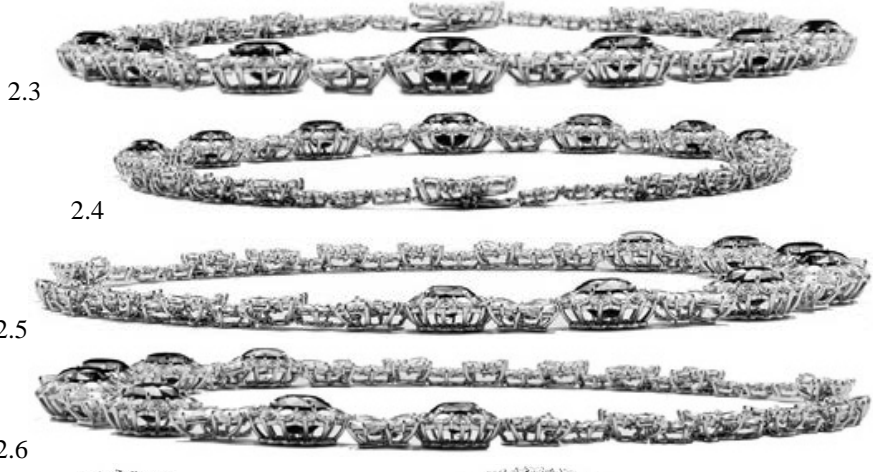



4.3



4.4



4.5



4.6



4.7



4.8



5.1



5.2



5.3



5.4



5.5



5.6



5.7



5.8



5.9



5.10

(11) DM/084709

(51) 09-01

(15) 2014 10 21

(45) 2014/44 (2014 11 07)

(22) 2014 10 21

(28) 1

(73) SAVERGLASS

3 rue de la Gare, F-60960 FEUQUIERES (FR)

(85) FR, EM

(86) FR, EM

(87) FR, EM

(88) FR, EM

(89) FR

(81) III. AM, AZ, BA, CH, EG, GE, MC, MD, ME, MK, NO, RS, SG, TR, UA

(54) 1. Bottle

(55)



1.1



1.2

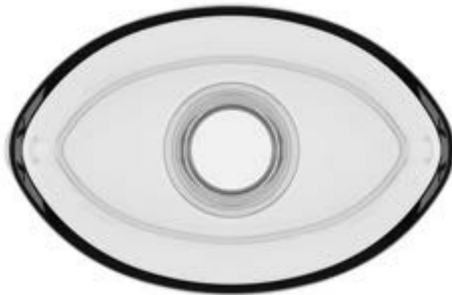

1.3

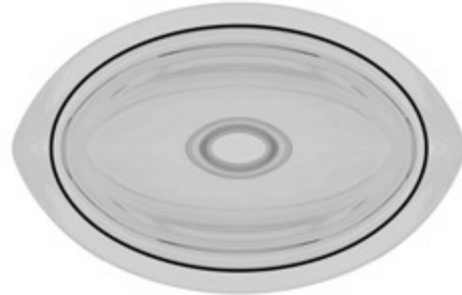

1.4



1.5

(11) DM/084742

(51) 11-01

(15) 2014 10 24

(45) 2014/44 (2014 11 07)

(22) 2014 10 24

(28) 3

(73) "FREY WILLE" GMBH & CO. KG.

Gumpendorferstrasse 81, A-1060 Wien (AT)

(85) EM

(86) EM

(87) EM

(88) EM

(89) EM

(81) III. CH, EG, EM, GE, MD, MK, MN, SG, TR, UA

(54) 1.-3. Bracelets (jewellery)

(55)



1.1



1.2



1.3



1.4



2.1



2.2



2.3



2.4



3.1



3.2



3.3



3.4

(11) DM/084748

(51) 06-01

(15) 2014 07 21

(45) 2014/44 (2014 11 07)

(22) 2014 07 21

(28) 2

(30) 23.01.2014; D20140012A; HR (23) 11.11.2013, 51. Medunarodni sajam namjestaja, opreme i, Belgrade; No 2: 04.02.2014, Furniture Fair, Stockholm; 13.01.2014, IMM Cologne, Cologne; 24.01.2014, Maison&Objet Paris, Paris; 08.04.2014, Salone del Mobile, Milan; 08.03.2014, Wohnen&Interieur, Wien

(73) KVADRA D.O.O. ZA PROIZVODNJU, TRGOVINU I USLUGE

Pustodol Začretski 19G, HR-49223 Sveti Križ Začretje (HR)

(85) --

(86) HR, EM

(87) n/a

(88) n/a

(89) HR

(81) II. CI, KP. III. AL, AM, AZ, BA, CH, EG, EM, GE, IS, KG, LI, MC, MD, ME, MK, NO, OM, RS, SG, TR, UA

(72) 1-2: Neven Kovacic

Jankomir 22, 10 090 Zagreb, Croatia;

1-2: Sanja Kovacic, Nova cesta 117, 10 000 Zagreb, Croatia

(54) 1. Rotating sofa; 2. Rotating armchair

(55)



1.1



1.2



1.3



1.4

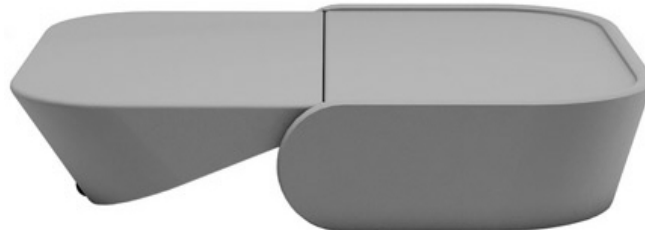

1.5



1.6



2.1



2.2



2.3



2.4



2.5

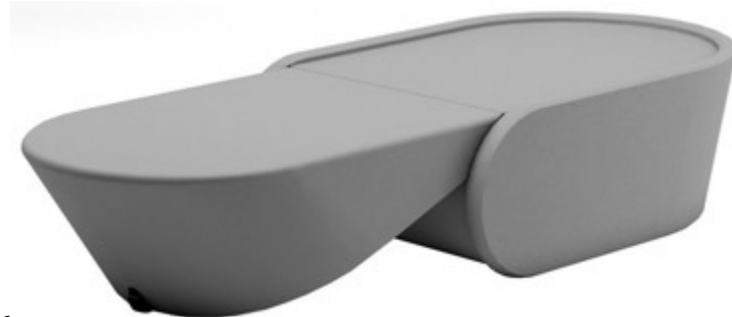

2.6

(11) DM/083572

(51) 10-02

(15) 2014 05 09

(45) 2014/45 (2014 11 14)

(22) 2014 05 09

(28) 1

(73) SWATCH AG (SWATCH SA) (SWATCH LTD.)

Jakob-Stämpfli-Strasse 94, CH-2502 Biel/Bienne (CH)

(85) CH

(86) CH

(87) CH

(88) CH

(89) CH

(81) II. BZ, MA. III. AL, AM, AZ, BA, CH, EM, GE, KG, LI, MC, MD, ME, MK, MN, NO, OM, SG, TJ, TN, TR, UA

(72) 1: Patrizio VITA

Congiunte dx, 30, 04100 Latina, Italie

(54) 1. Wristwatch

(55)



(11) DM/083574

(51) 10-02

(15) 2014 05 09

(45) 2014/45 (2014 11 14)

(22) 2014 05 09

(28) 1

(73) SWATCH AG (SWATCH SA) (SWATCH LTD.)

Jakob-Stämpfli-Strasse 94, CH-2502 Biel/Bienne (CH)

(85) CH

(86) CH

(87) CH

(88) CH

(89) CH

(81) II. BZ, MA. III. AL, AM, AZ, BA, CH, EM, GE, KG, LI, MC, MD, ME, MK, MN, NO, OM, SG, TJ, TN, TR, UA

(72) 1: Patrizio VITA

Congiunte dx, 30, 04100 Latina, Italie

(54) 1. Wristwatch

(55)



1.1



1.2

(11) DM/083580

(51) 10-02

(15) 2014 05 09

(45) 2014/45 (2014 11 14)

(22) 2014 05 09

(28) 1

(73) SWATCH AG (SWATCH SA) (SWATCH LTD.)

Jakob-Stämpfli-Strasse 94, CH-2502 Biel/Bienne (CH)

(85) CH

(86) CH

(87) CH

(88) CH

(89) CH

(81) II. BZ, MA. III. AL, AM, AZ, BA, CH, EM, GE, KG, LI, MC, MD, ME, MK, MN, NO, OM, SG, TJ, TN, TR, UA

(72) 1: Andrea ARRIGONI

Via Ponte Seveso 39, 20125 Milano, Italie

(54) 1. Wristwatch

(55)



1

(11) DM/084367

(51) 09-01

(15) 2014 05 12

(45) 2014/45 (2014 11 14)

(22) 2014 05 12

(28) 5

(73) BIBITA GROUP SHPK

Rruga e Bogdaneve, Pall. EUROCOL, Kati V, Tirana (AL)

(85) --

(86) n/a

(87) AL (88) n/a

(89) AL

(81) IL, GA, MA, ML, NE, SN. III. AZ, BA, BW, CH, EG, EM, GE, GH, KG, ME, MK, NA, OA, OM, RS, RW, SY, TJ, TN, TR, UA

(72) BIBITA GROUP SHPK

Rruga e Bogdaneve, Pall. EUROCOL, Kati V, Tirana, Albania

(54) 1.-5. Containers for energy drinks

(55)

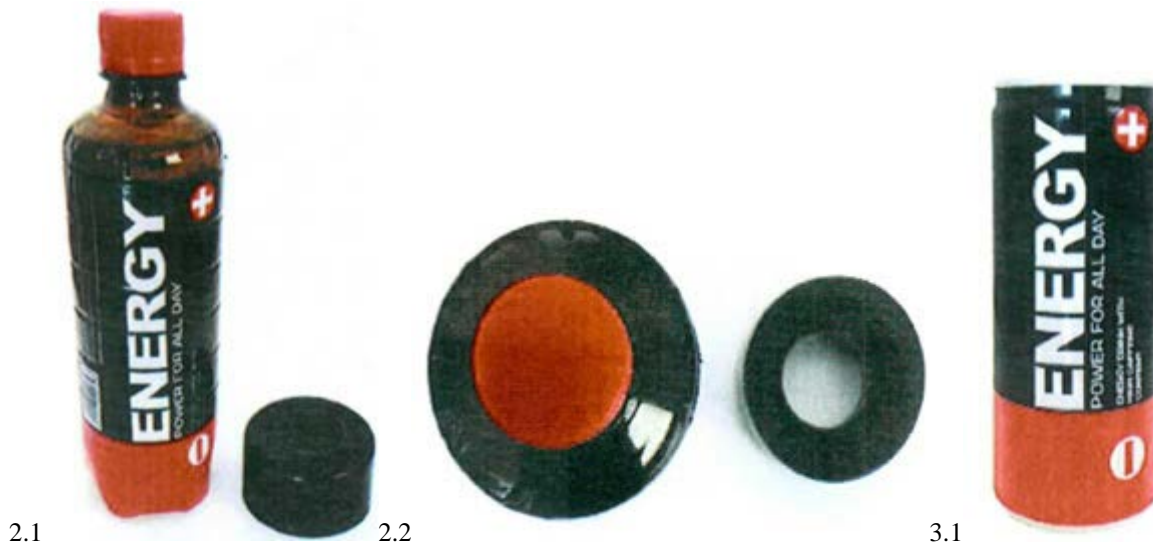



3.2



4.1



4.2



4.3



5.1



5.2



(11) DM/084811

(51) 09-01

(15) 2014 11 04

(45) 2014/46 (2014 11 21)

(22) 2014 11 04

(28) 1

(30) 13.10.2014; 002555813-0001; EM

(73) SAVERGLASS

3 rue de la Gare, F-60960 FEUQUIERES (FR)

(85) FR, EM

(86) FR, EM

(87) FR, EM

(88) FR, EM

(89) FR

(81) II. MA. III. AM, AZ, BA, CH, EG, GE, MC, MD, ME, MK, NO, RS, SG, SY, TN, TR, UA

(54) 1. Bottle

(55)

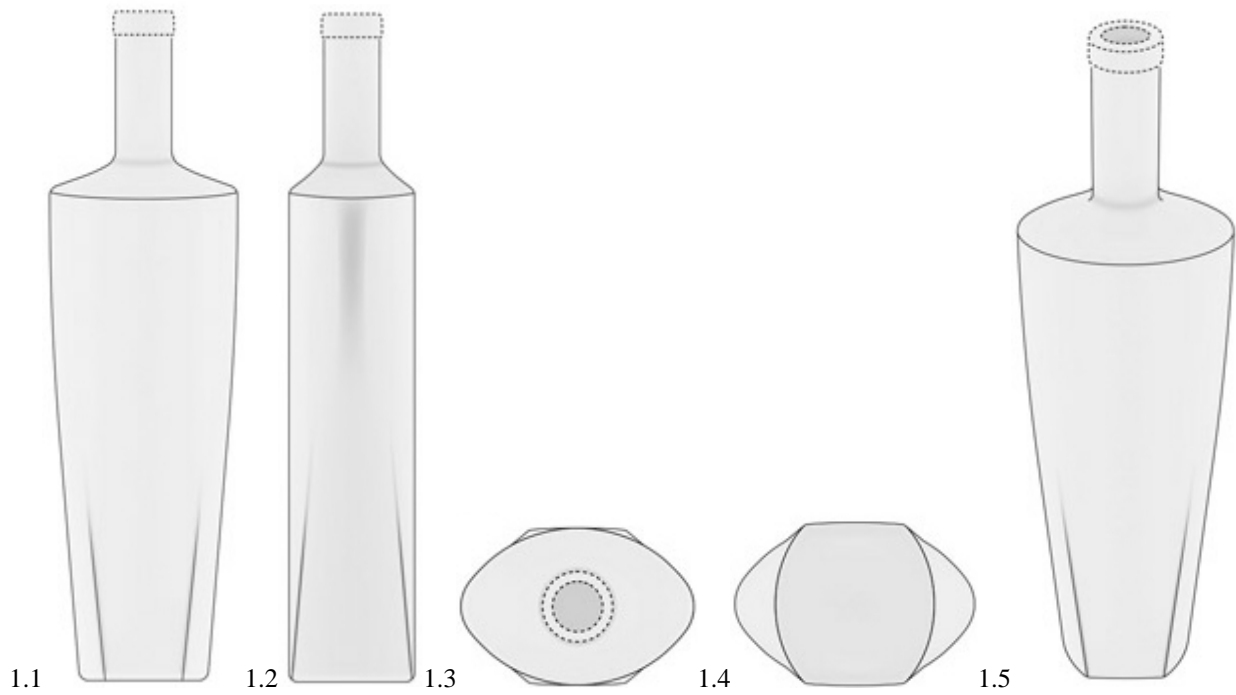

- (11) **DM/084821** (51) **19-08**
 (15) 2014 04 14 (45) 2014/46 (2014 11 21)
 (22) 2014 04 14
 (28) 4
 (73) EVELINE COSMETICS SA S.K.A.
 ul. Żytnia 19, PL-05-506 LESZNOWOLA (PL)
 (85) --
 (86) PL, EM
 (87) n/a
 (88) n/a
 (89) PL
 (81) III. AM, AZ, BA, GE, GH, KG, MD, ME, MK, OA, RS, SG, TJ, TN, TR, UA
 (72) 1: EVELINE COSMETICS S.A. S.K.A.
 ul. Żytnia 19, PL-05-506 LESZNOWOLA, Poland
 (54) 1.-4. Surface ornamentation for container labels
 (55)



(11) DM/083634

(51) 11-01

(15) 2014 05 22

(45) 2014/47 (2014 11 28)

(22) 2014 05 22

(28) 6

(73) HARRY WINSTON SA

Chemin du Tourbillon 8, CH-1228 Plan-les-Ouates (CH)

(85) CH

(86) CH

(87) CH

(88) CH

(89) CH

(81) II. BZ, MA. III. AL, AM, AZ, BA, CH, EM, GE, KG, LI, MC, MD, ME, MK, MN, NO, OM, SG, TJ, TN, TR, UA

(72) 1-6: Rie YATSUGI-KANG

272 Highland Street, 07626 Cresskill N.J., États-Unis d'Amérique

(54) 1. Pendant necklace; 2. Necklace; 3. Pendant necklace; 4. Earring; 5. Bracelet; 6. Earring

(55)



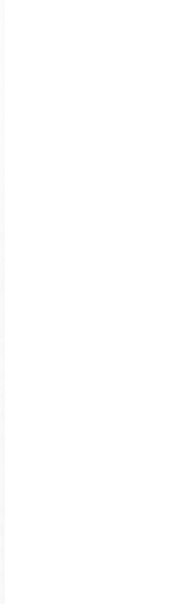

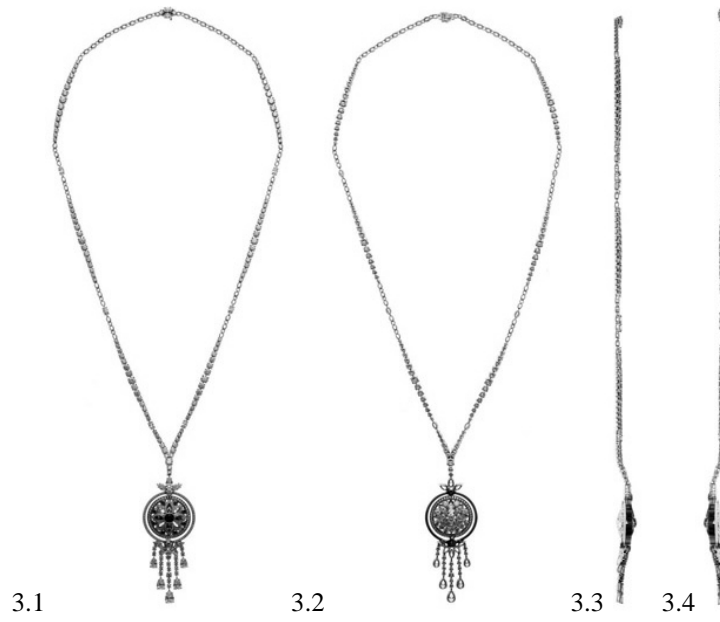

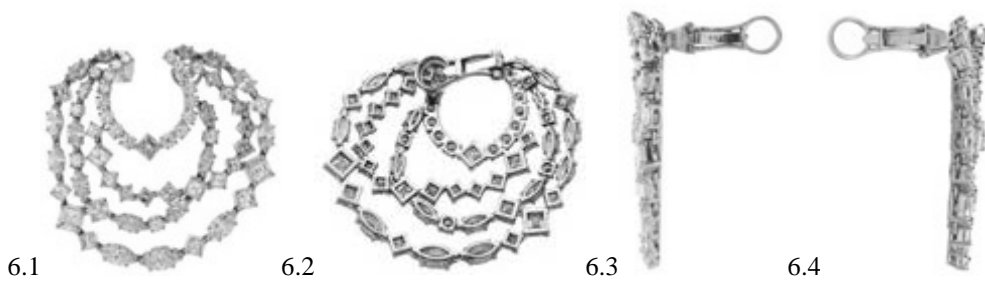
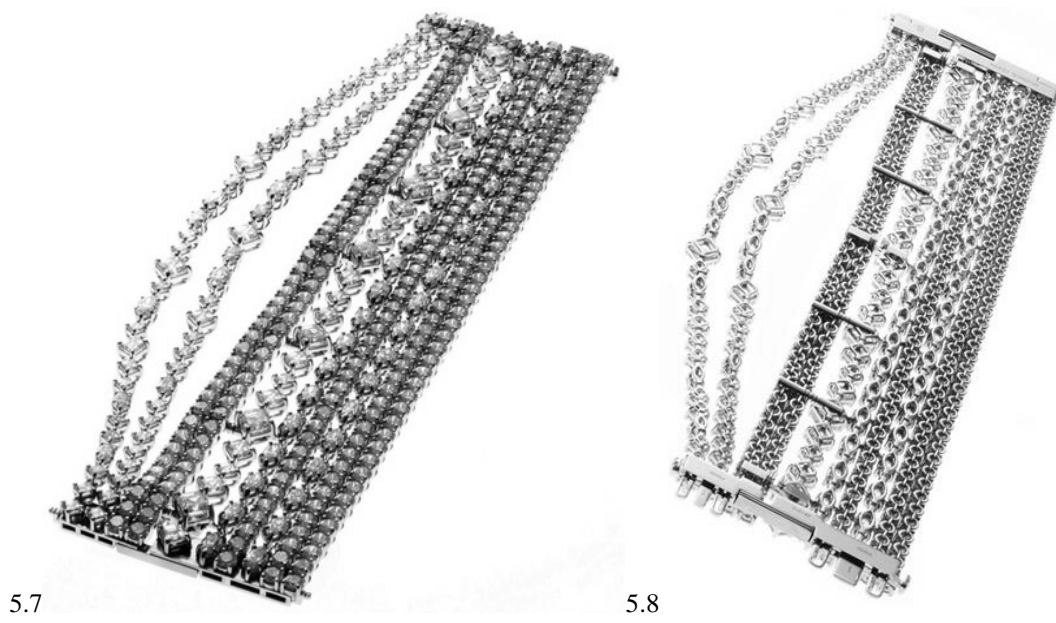
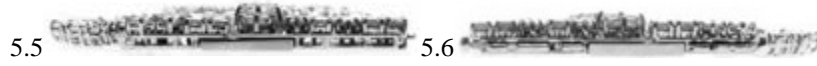
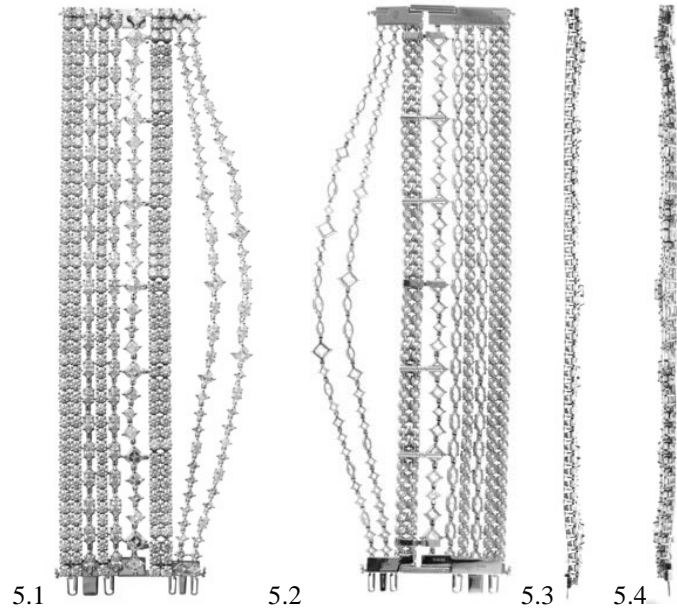



(11) DM/083655

(15) 2014 05 22

(22) 2014 05 22

(28) 2

(73) THE SWATCH GROUP MANAGEMENT SERVICES AG (THE SWATCH GROUP MANAGEMENT SERVICES SA) (THE SWATCH GROUP MANAGEMENT SERVICES LTD.)

Seevorstadt 6, CH-2502 BIEL/BIENNE (CH)

(85) CH

(86) CH

(87) CH

(88) CH

(89) CH

(81) II. BZ, MA. III. AL, AM, AZ, BA, CH, EM, GE, KG, LI, MC, MD, ME, MK, MN, NO, OM, SG, TJ, TN, TR, UA

(72) 1-2: Fernando SOARES

rue Fleury 5, CH-2000 Neuchâtel, Switzerland

(54) 1.-2. Watches

(55)

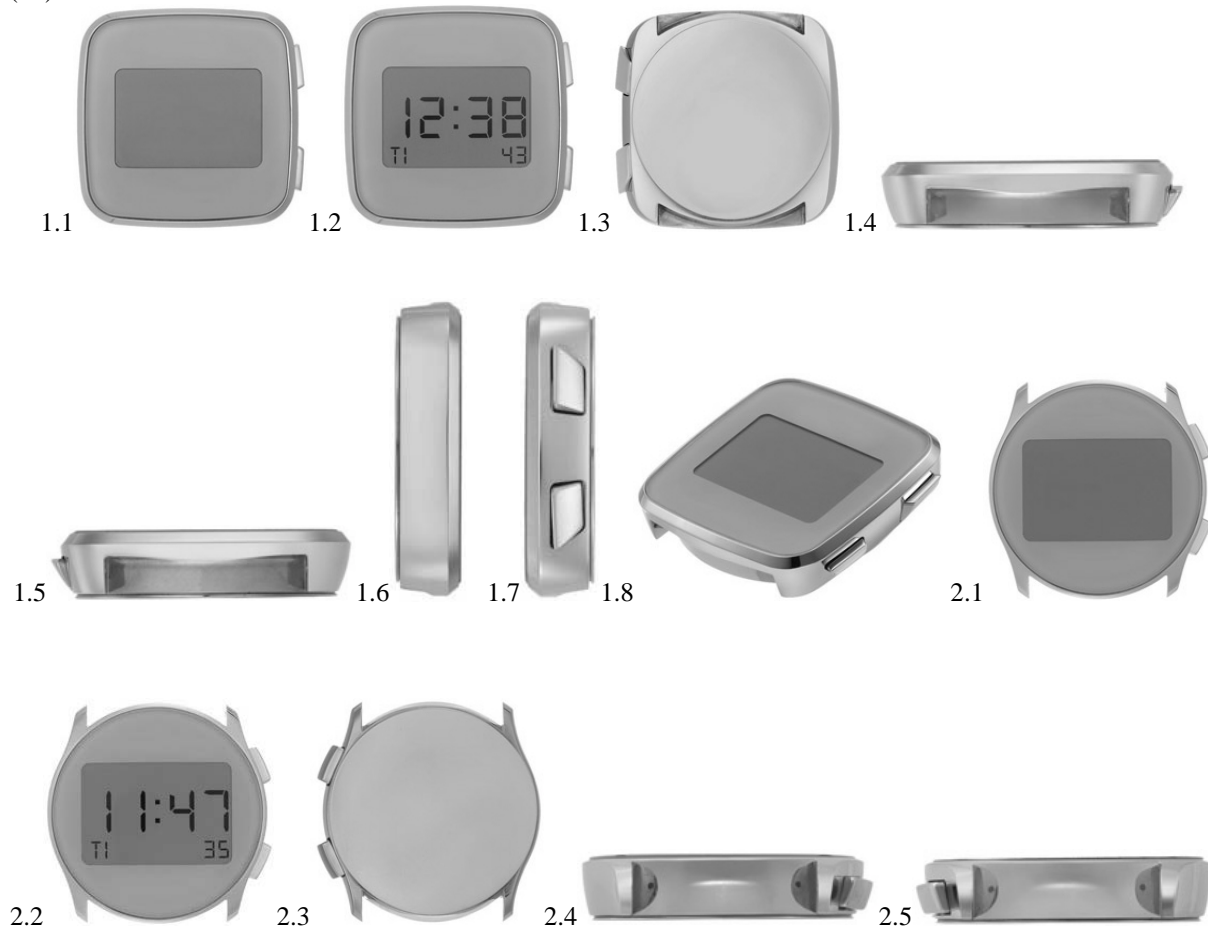

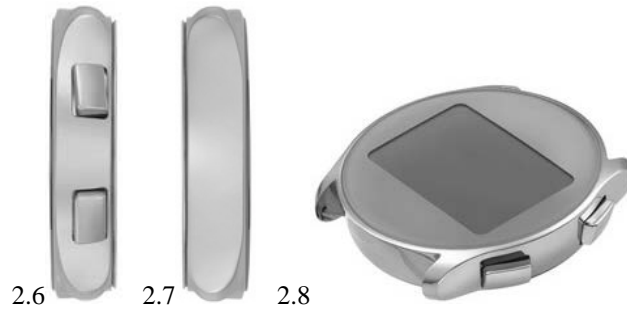

(11) DM/083682

(15) 2014 05 26

(22) 2014 05 26

(28) 1

(73) SWATCH AG (SWATCH SA) (SWATCH LTD.)

Jakob-Stämpfli-Strasse 94, CH-2502 Biel/Bienne (CH)

(85) CH

(86) CH

(87) CH

(88) CH

(89) CH

(81) II. BZ, MA. III. AL, AM, AZ, BA, CH, EM, GE, KG, LI, MC, MD, ME, MK, MN, NO, OM, SG, TJ, TN, TR, UA

(72) 1: Antonio FAZIO

Avenue de Cour 40, CH-1007 Lausanne, Suisse;

1: Richard PERMIN

Rue de Chavannes 29, F-69660 Collonges au Mont d'Or, France

(54) 1. Wristwatch

(55)

(51) 10-02

(45) 2014/47 (2014 11 28)



(11) DM/083684

(51) 11-01

(15) 2014 05 27

(45) 2014/47 (2014 11 28)

(22) 2014 05 27

(28) 6

(73) HARRY WINSTON SA

Chemin du Tourbillon 8, CH-1228 Plan-les-Ouates (CH)

(85) CH

(86) CH

(87) CH

(88) CH

(89) CH

(81) II. BZ, MA. III. AL, AM, AZ, BA, CH, EM, GE, KG, LI, MC, MD, ME, MK, MN, NO, OM, SG, TJ, TN, TR, UA

(72) 1, 2: Chaaree KWON

635 W. 42nd Street, Apt. N17e, 10036 New York N.Y., États-Unis d'Amérique;

3, 4, 5: Rie YATSUGI-KANG

272 Highland St., 07626 Cresskill N.J., États-Unis d'Amérique;

6: Dominique Rivière

360 E. 72nd Street, Apt. Nb1003, 10021 New York N.Y., États-Unis d'Amérique

(54) 1.-2. Earrings; 3. Finger ring; 4. Earring; 5.-6. Finger rings

(55)

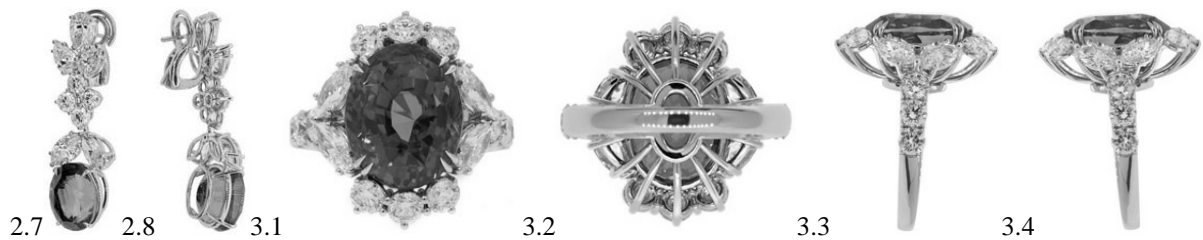

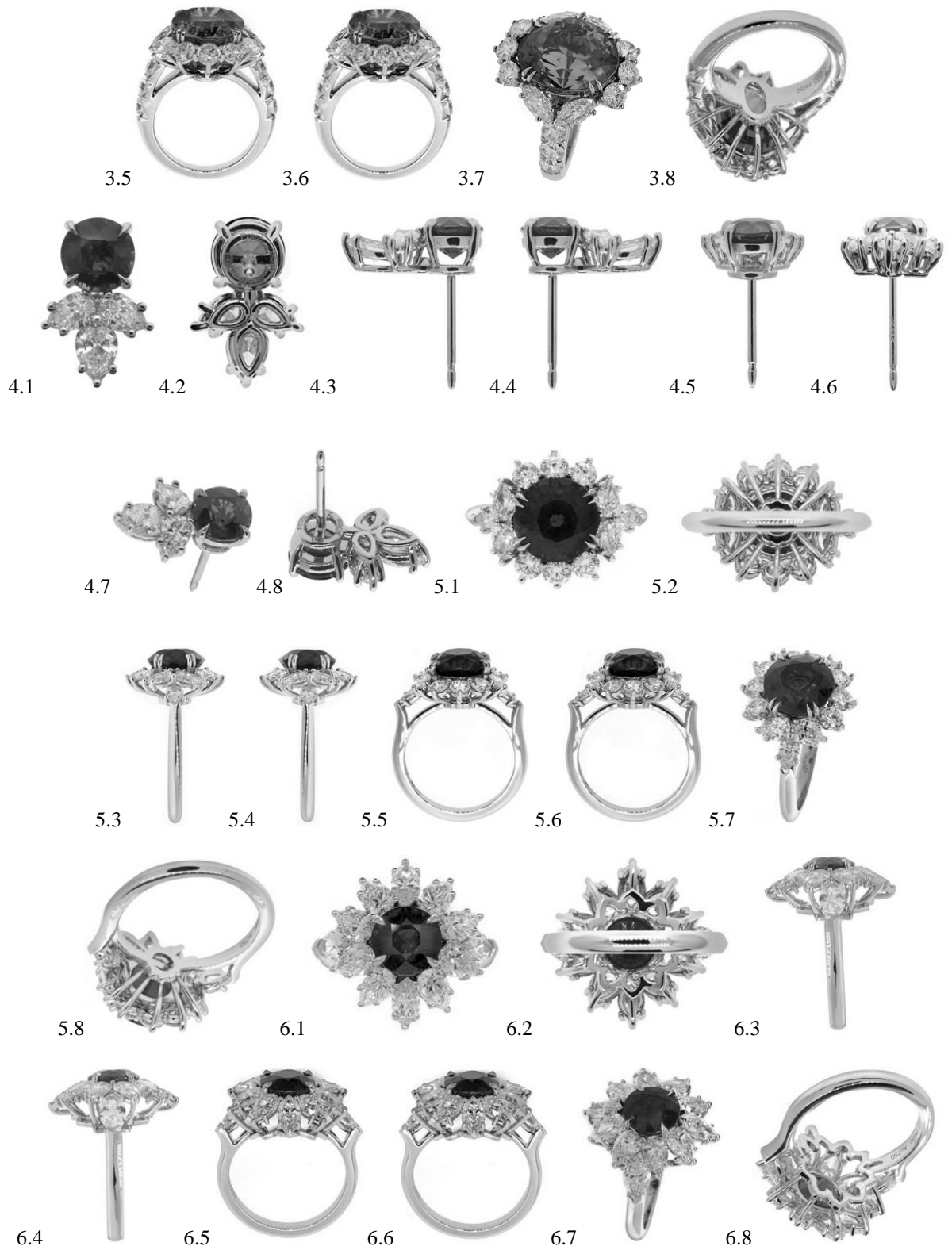

- (11) DM/084874 (51) 19-08
(15) 2014 09 05 (45) 2014/47 (2014 11 28)
(22) 2014 09 05
(28) 5
(73) W.L. GORE & ASSOCIATES INC.
555 Paper Mill Road, Newark, DE 19714-9206 (US)
(85) --
(86) n/a
(87) n/a
(88) DE, EM
(89) DE
(81) III. CH, EM, GE, KR, NO, TR, UA
(72) 1-5: Rupert Dodell
Hermann-Oberth-Str. 22, 85640 Putzbrunn, Germany
(54) 1.-5. Tags
(55)

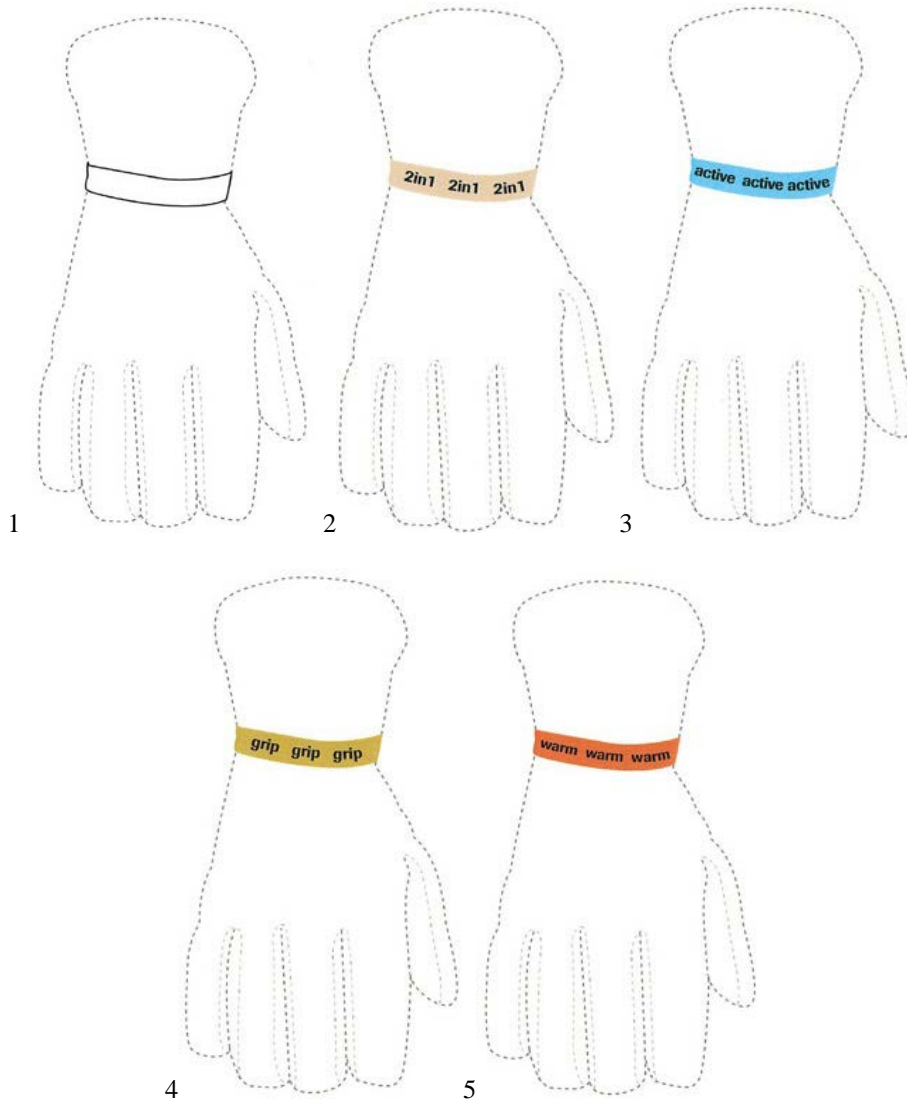

(11) DM/083733

(51) 10-02

(15) 2014 06 03

(45) 2014/48 (2014 12 05)

(22) 2014 06 03

(28) 1

(73) SWATCH AG (SWATCH SA) (SWATCH LTD.)

Jakob-Stämpfli-Strasse 94, CH-2502 Biel/Bienne (CH)

(85) CH

(86) CH

(87) CH

(88) CH

(89) CH

(81) II. BZ, MA. III. AL, AM, AZ, BA, CH, EM, GE, KG, LI, MC, MD, ME, MK, MN, NO, OM, SG, TJ, TN, TR, UA

(72) 1: Ylenia AGATE

Via San Tomaso 96, 24121 Bergamo, Italie

(54) 1. Wristwatch

(55)



1

- (11) **DM/083840** (51) **09-01**
 (15) 2014 06 04 (45) 2014/48 (2014 12 05)
 (22) 2014 06 04
 (28) 14
 (73) ALPLA WERKE ALWIN LEHNER GMBH & CO. KG
 Allmendstrasse, A-6971 Hard (AT)
 (85) --
 (86) EM
 (87) EM
 (88) EM
 (89) EM
 (81) III. CH, EM, GE, UA
 (72) Danler Karl
 Landstrasse 21c, 6900, Bregenz, Austria
 (54) 1.-14. Bottles
 (55)

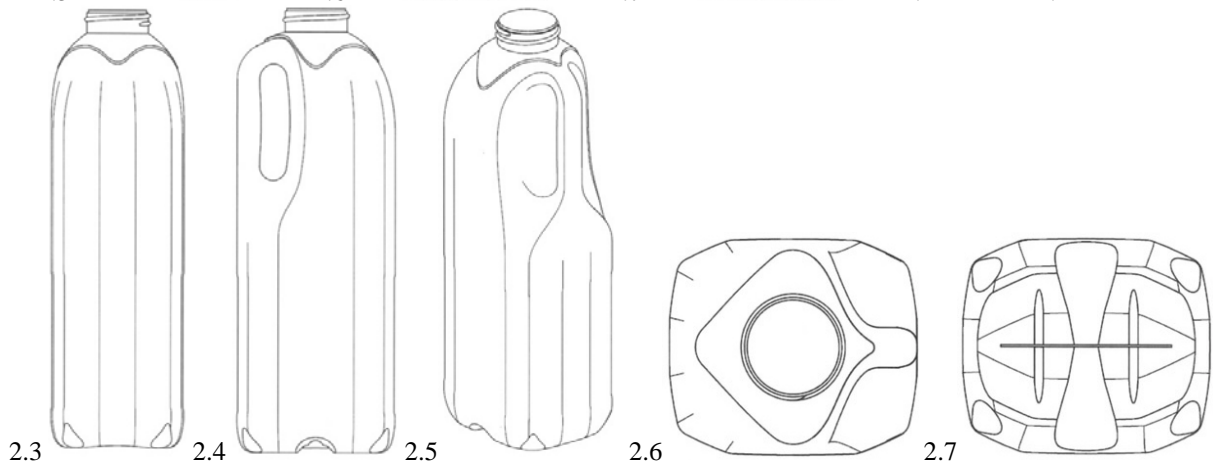
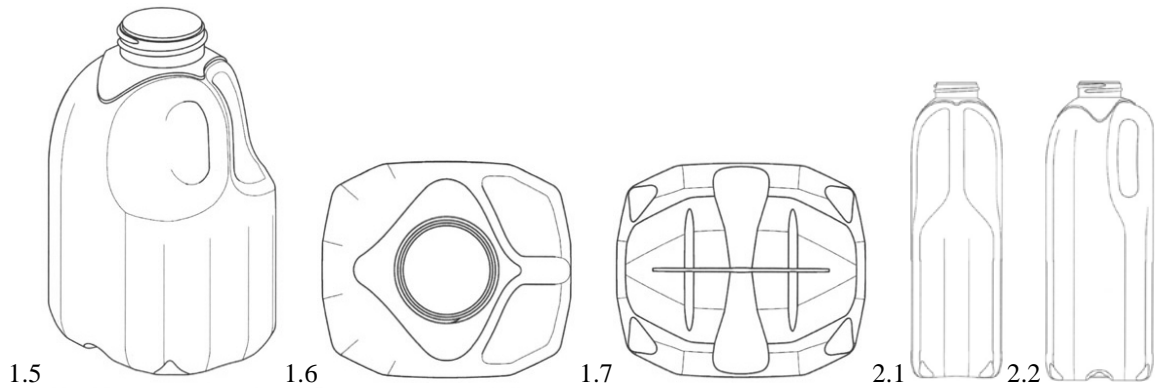
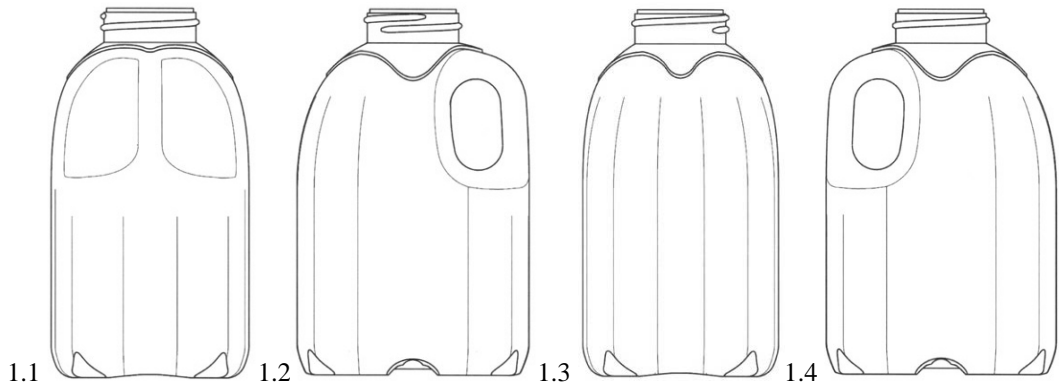

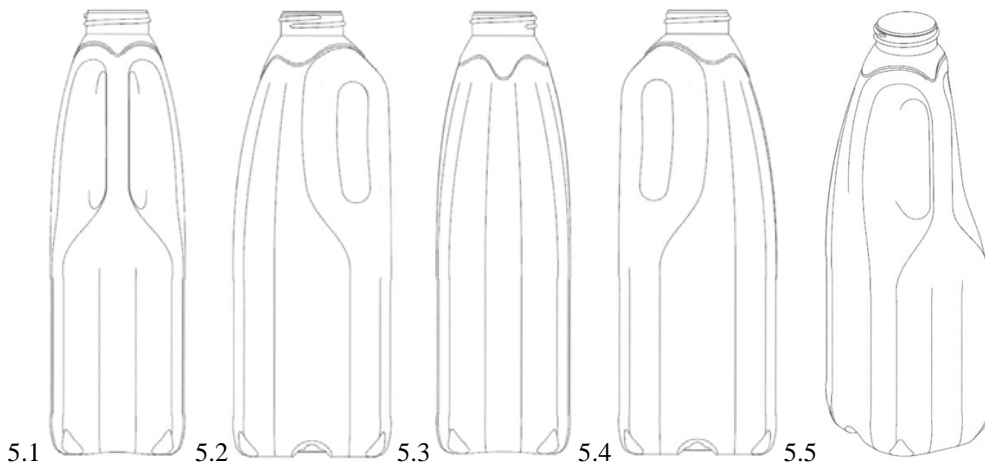
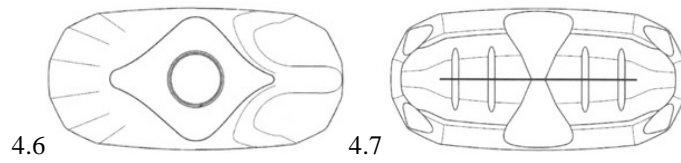
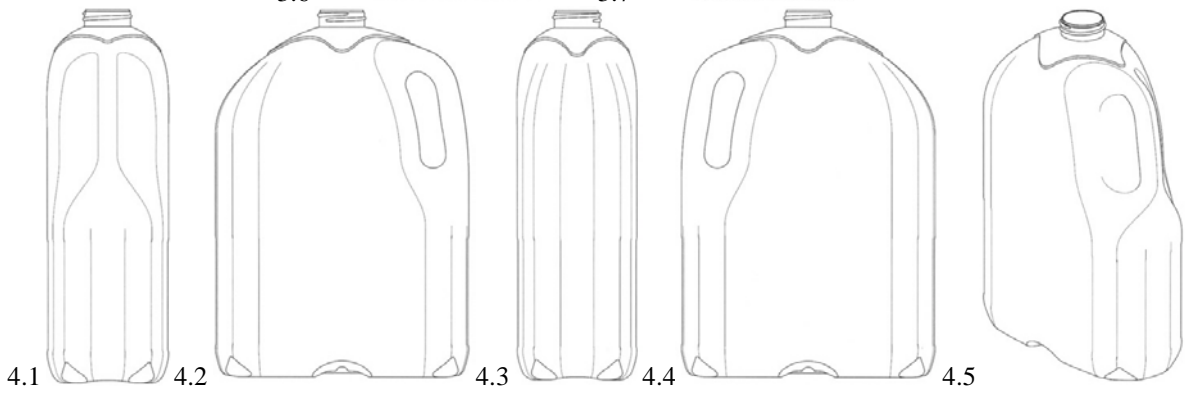
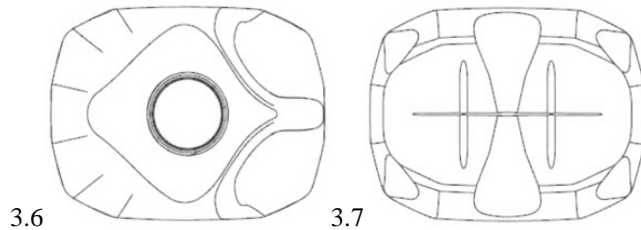
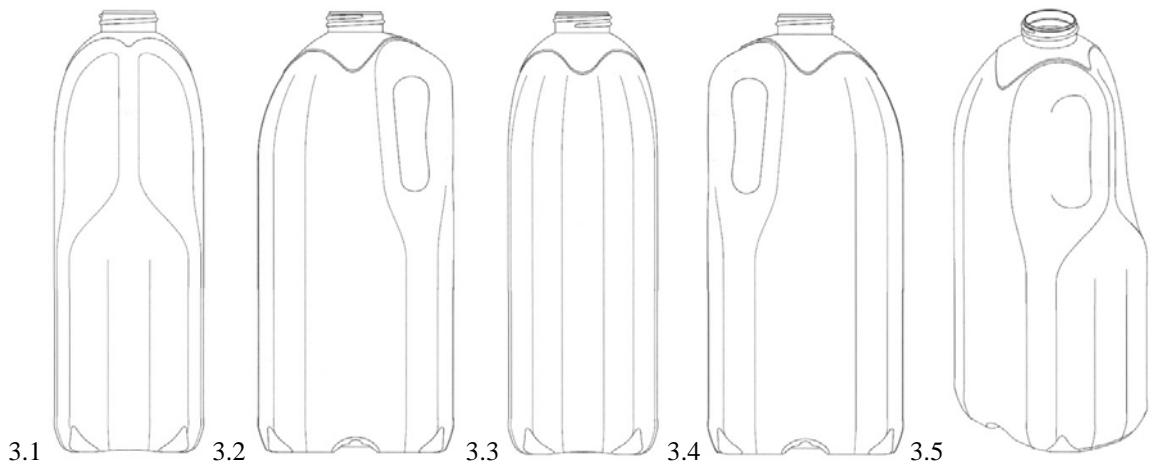

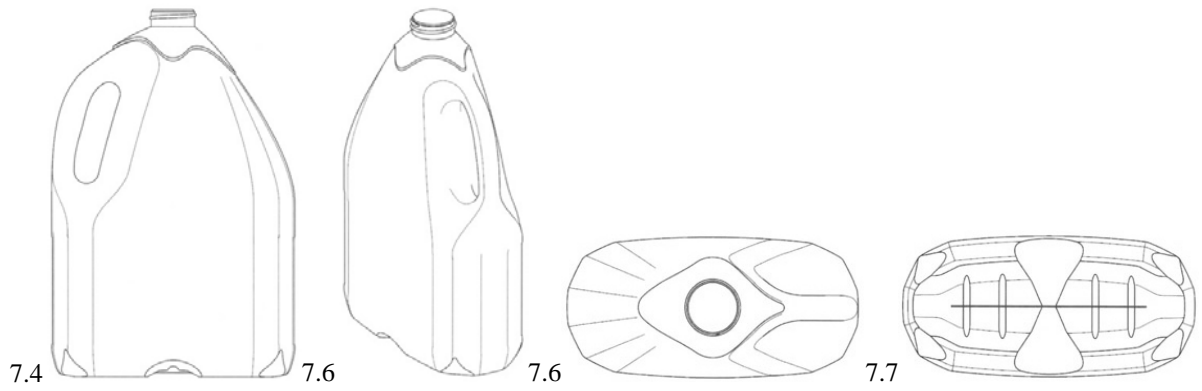
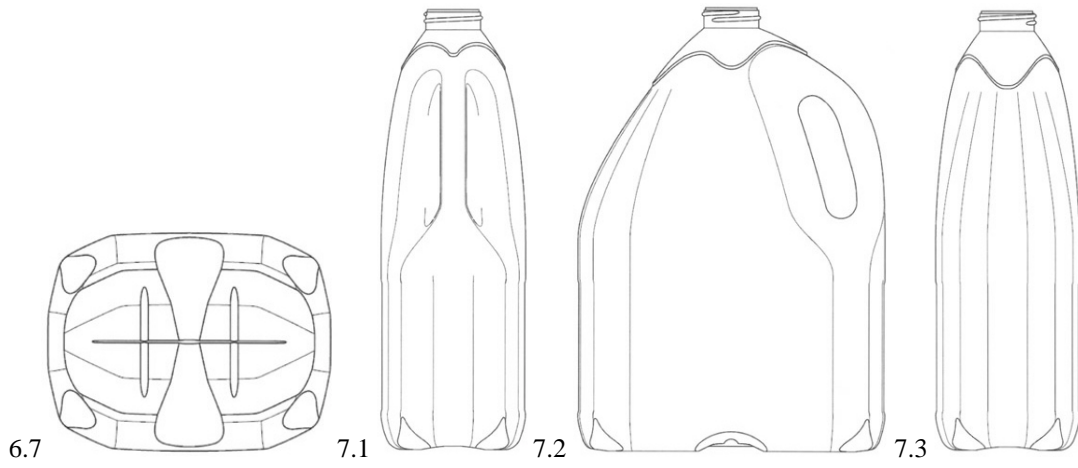
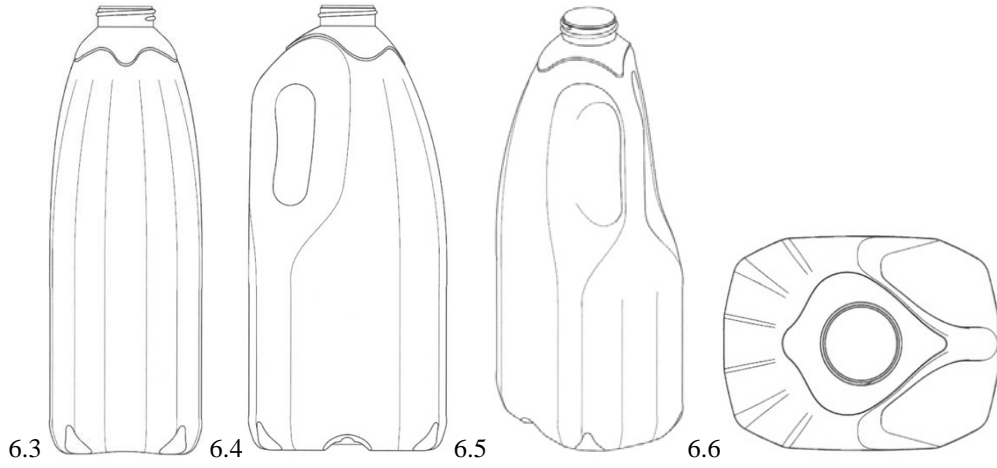
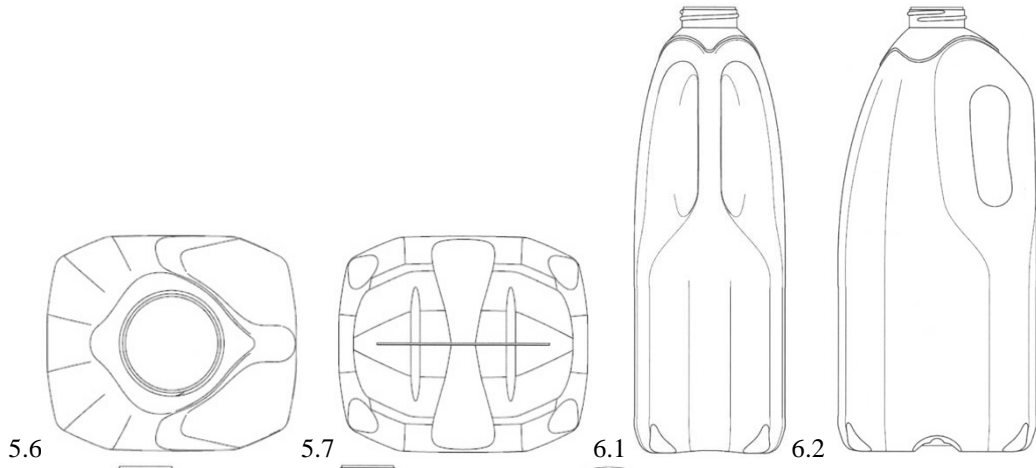

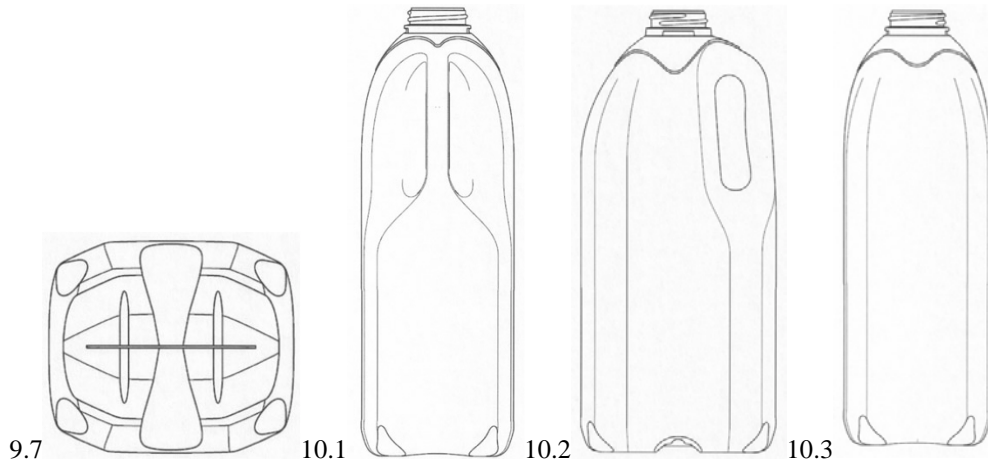
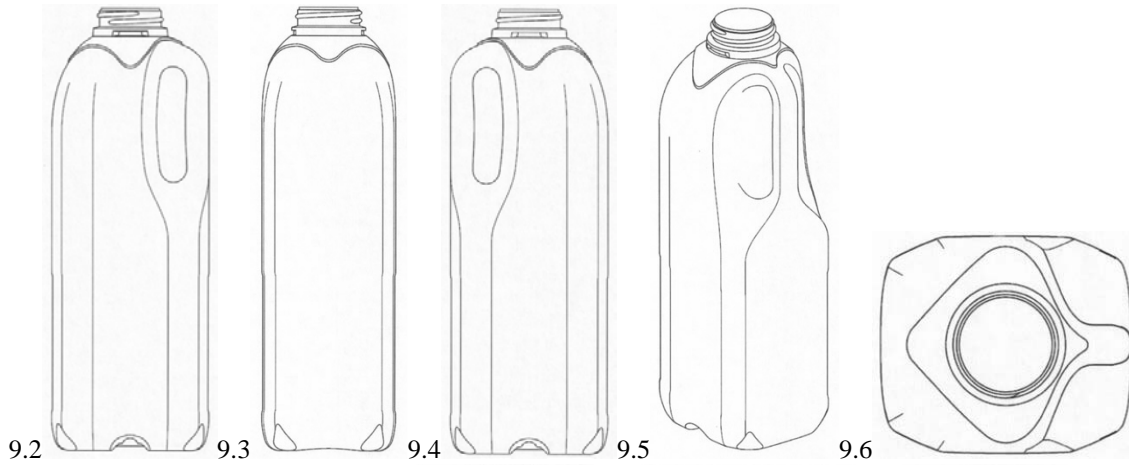
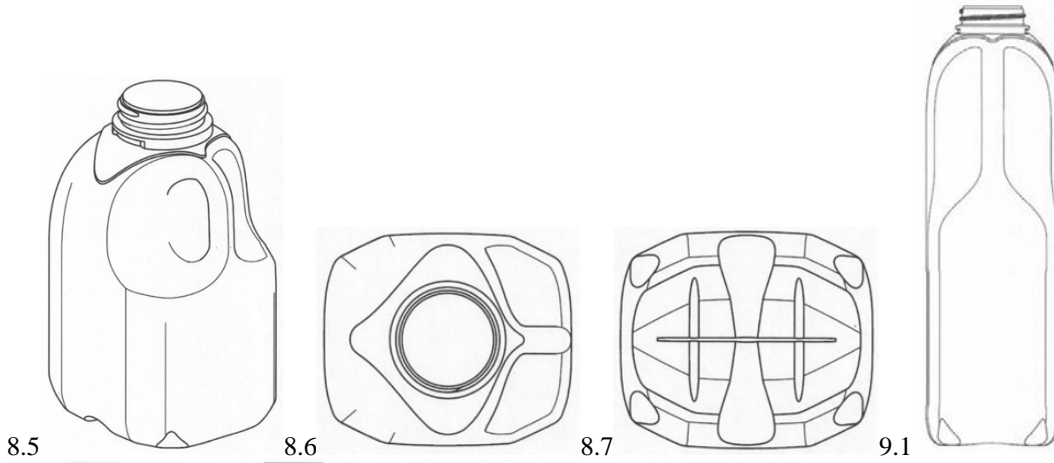
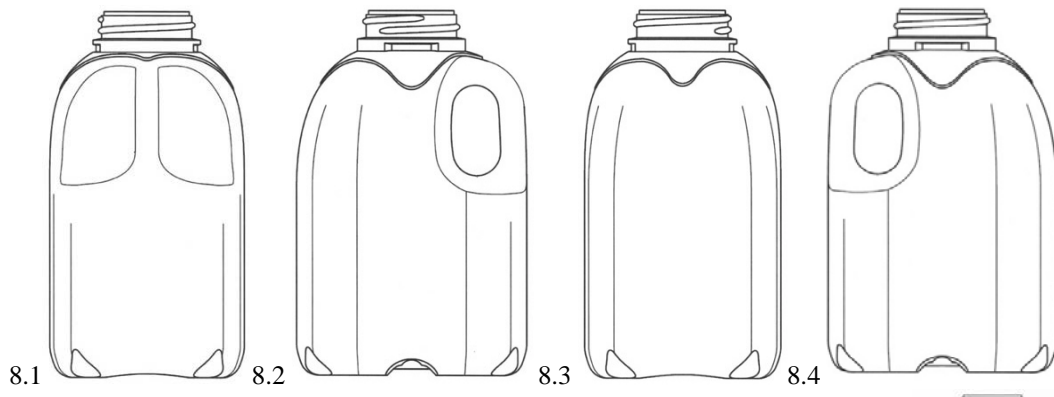

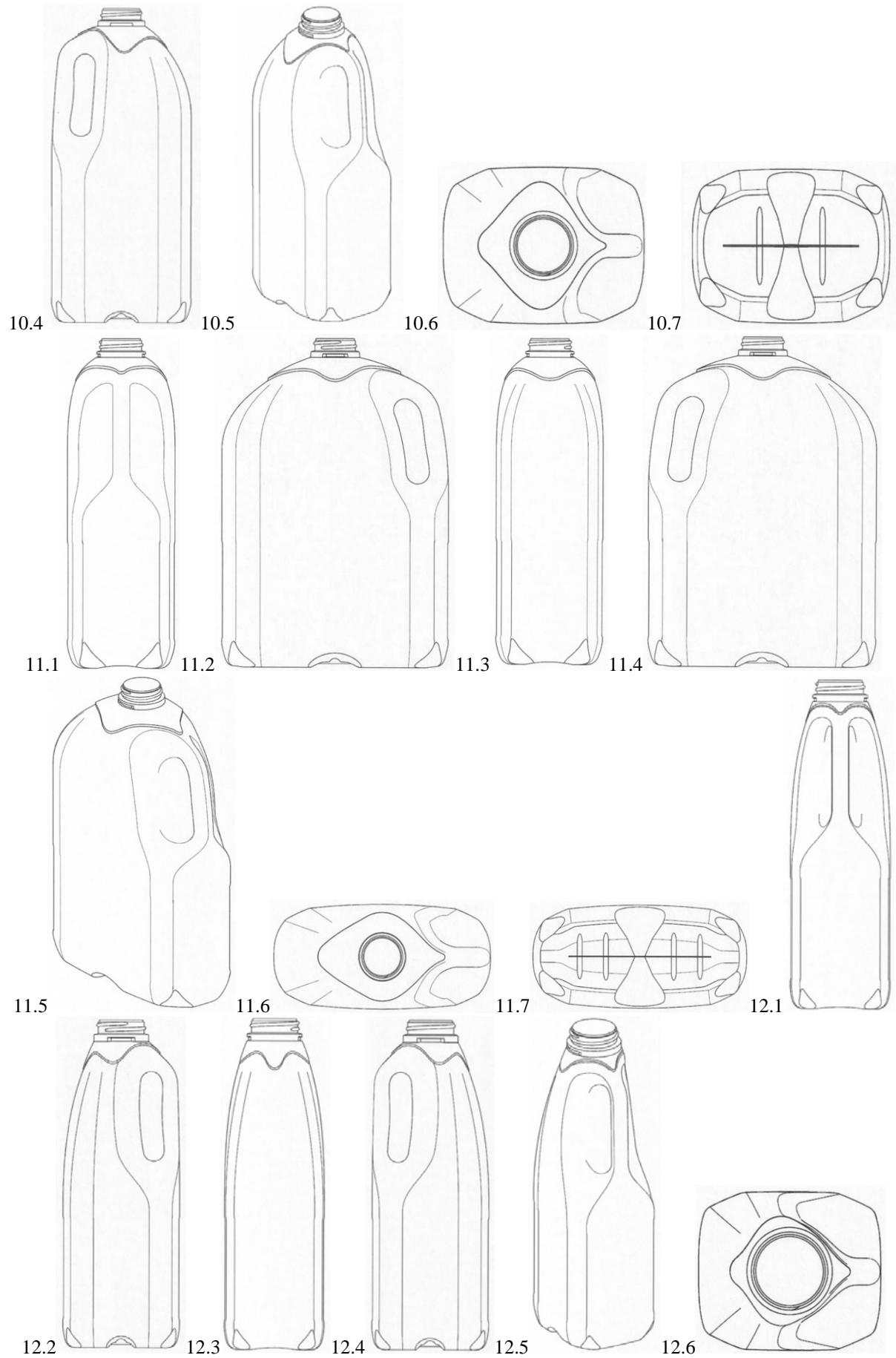

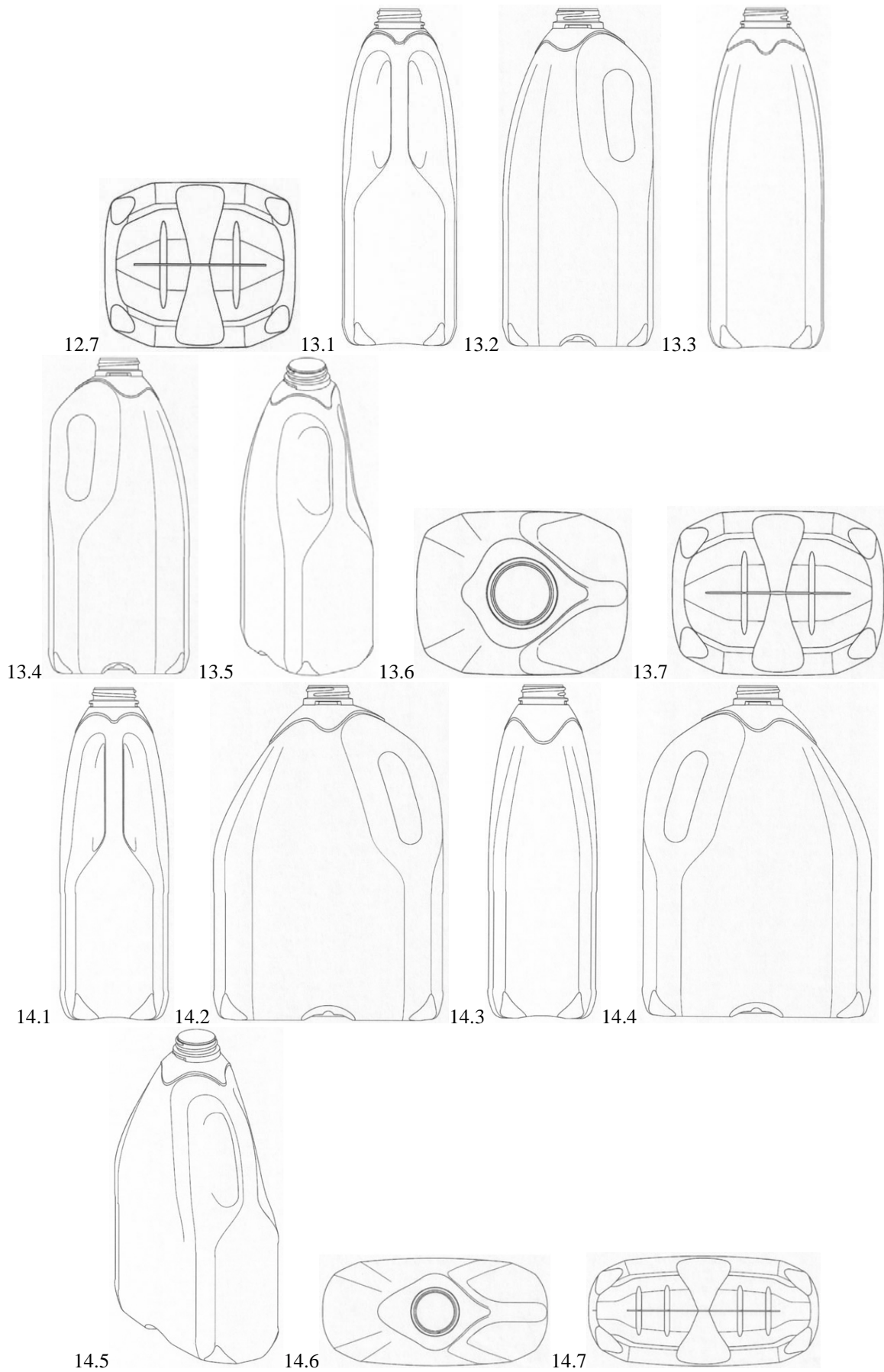

(11) DM/084640

(51) 24-02

(15) 2014 06 02

(45) 2014/48 (2014 12 05)

(22) 2014 06 02

(28) 1

(30) 30.12.2013; 2013 03749; UA

(73) LYAPKO MYKOLA GRYGOROVYCH

m-n Sonyachny, 8-21, Krasnogorivka, Marjinsky rajon, Donetska obl. 85630 (UA)

(85) --

(86) UA

(87) UA

(88) n/a

(89) UA

(81) III. CH, EM, GE, TR

(72) Lyapko Mykola Gerygorovych

m-n Sonyachny, 8-21, Krasnogorivka, Marjinsky rajon, Donetska obl., 85630, Ukraine

(54) 1. Oxygen tent

(55)

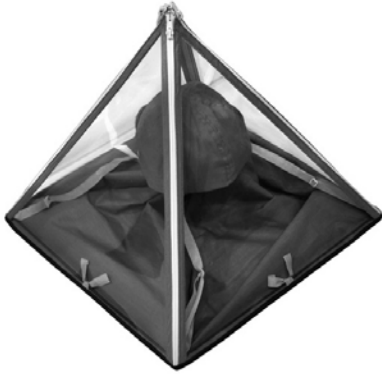

1.1



1.2



1.3



1.4



1.5



1.6

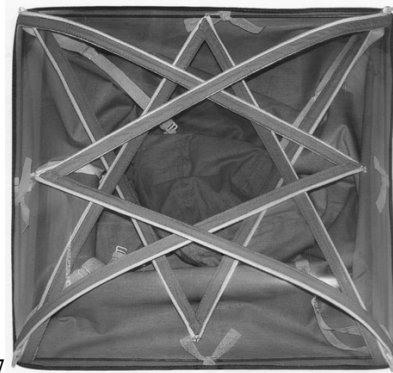

1.7

სასაქონლო ნიშნები

ეროვნული პროცედურით შემოტანილი განაცხადები, რომლებზეც გამოტანილია გადაწყვეტილება რიგისტრაციის შესახებ

გადაწყვეტილების გასაჩივრება შესაძლებელია საქპატენტის სააპელაციო პალატაში გამოქვეყნებიდან 3 თვის ვადაში ან მცხეთის რაიონული სასამართლოს ადმინისტრაციულ საქმეთა კოლეგიაში 1 თვის ვადაში (მის.: ქ. მცხეთა, სამხედროს ქ. №17).

(260) AM 2015 69118 A

(210) AM 69118

(220) 2014 01 10

(731) შპს „ქართული ღვინისა და ალკოჰოლური სასმელების კომპანია“ სოფ. აჩინებუღი, 2200, თელავი, საქართველო

(740) შოთა მეტრეველი

(540)



Old Tbilisi



(591) მწვანე, შავი, ნაცრისფერი

(531) 07.01.01-25.01.19-27.05.05-29.01.15-

(526) ნიშანი დაცულია მთლიანობაში. მასში შემავალი სიტყვა "TBILISI" არ ექვემდებარება დამოუკიდებელ სამართლებრივ დაცვას.

(511)

33 – ალკოჰოლური სასმელები (ღუდის გარდა).

(260) AM 2015 71153 A

(210) AM 71153

(220) 2013 03 01

(731) სს „სმარტექსი“

ჭავჭავაძის გამზ. 74, 0162, თბილისი, საქართველო

(540)

smartex

We deliver

(591) წითელი, მწვანე, ყვითელი, ლურჯი,

რუხი, იისფერი, შინდისფერი

(531) 27.05.17-27.05.22-29.01.12-

(511)

39 – კურიერის მომსახურება (კორესპონდენციის ან საქონლის ადგილზე მიტანა).

(260) AM 2015 72155 A

(210) AM 72155

(220) 2013 05 08

(310) 85778406

(320) 2012 11 13

(330) US

(731) ტივანა კორპორეიშნ, ჯორჯიის შტატის კორპორაცია

3630 პინტრი როუდი NE, სუიტი 1480,

ატლანტა, ჯორჯია 30326, აშშ

(740) თამარ კოჭლამაზაშვილი

(540)

TEAVANA
HEAVEN OF TEA

(591) შავ-თეთრი

(531) 01.15.15-02.01.23-27.05.17-

(511)

30 – ჩაი და ჩაის ნარევები; ყინულკარამელი, სახელდობრ: პიტნის ყინულკარამელი ჩაის არომატით; თაფლი კოვზის ფორმით; ბალახოვანი ჩაის სასმელები; ჩაი და ბალახოვანი ჩაის სასმელები და ბალახოვანი ჩაის სასმელების კონცენტრატები, ხილის არომატით; გაყინული ტკბილეულობა, საკონდიტრო ნაწარმი, ჩაის, ბალახოვანი ჩაის და ხილის არომატით; კაკაო, ბალახოვანი და არაბალახოვანი ჩაი; ჩაი, კაკაო და სასმელები; შოკოლადის ფხვნილის საფუძველზე დამზადებული სასმელები და ვანილის საფუძველზე დამზადებული სასმელები; სასმელებში დასამატებელი სოუსები; შოკოლადის ვაჟინი; არომატიზებული ვაჟინები სასმელებში დასამატებლად; დასაღვეად გამზადებული ჩაი; ნაყინი და გაყინული ტკბილეულობა, საკონდიტრო ნაწარმი, სახელდობრ: ნაყინი, რძის ნაყინი (დესერტი), გაყინული იოგურტი, გაყინული დესერტები სოიოს საფუძველზე; კანფეტები და ტკბილეულობა, საკონდიტრო ნაწარმი, სახელდობრ; შოკოლადი, შაქარი, ნუშის კანფეტები და გაყინული ტკბილეულობა, საკონდიტრო ნაწარმი; პურ-ფუნთუშეული, სახელდობრ; მაფინები, ხორბლის ან შერიის კვერუკები, ბისკვიტები, ნამცხვრები, ცომეული საკონდიტრო ნა-

წარმი და პური; ბრიკეტირებული საკვები კონცენტრატები, სახელობრ: სასურსათო ბრიკეტები მარცვლოვანი პროდუქტებისგან და სასურსათო ბრიკეტები შერიისაგან; შაქარი; სანელებლები; თაფლი; ავაგა (დამატკობელი); არომატიზებული ვაჟინები სასმელებისთვის.

35 – ბიზნესის ადმინისტრირება, მენეჯმენტი ბიზნესის სფეროში; ფრანჩაიზინგი, სახელობრ: ტექნიკური დახმარების შეთავაზება (კომერციული კონცესიის ხელშეკრულების საფუძველზე) რესტორნების, კაფეების, ყავახანების, ჩაის სახლების (ჩაიხანების), სასაუზმეების, ბარების დაფუძნებაში და მართვაში; საცალო ვაჭრობის მაღაზიები, რომლებიც ვაჭრობენ ყავით, ჩაით, კაკაოთი, მზა და დაფასოებული საკვებით, ჩაის დასამზადებლად განკუთვნილ ელექტრო და არაელექტრო ხელსაწყოებით, ჭურჭლით, სამზარეულო ჭურჭლით (სამზარეულოს საკუთნობით), მინის ჭურჭლით და ნაკეთობებით, სასაჩუქრე საქონლით, თევზებით, ჯამებით, შესანახი კონტეინერებით, სტატუეტებით, ფიგურებით, დეკორატიული ნივთებით, ტანსაცმლით, შანდლებით, საკმეველით, სახლისათვის განკუთვნილი სურნელებით (არომატიზატორებით), პირადი ჰიგიენის ნივთებით, მუსიკალური ჩანაწერებით და წიგნებით; მომსახურება საბითუმო ვაჭრობის, საბითუმო ვაჭრობის მაღაზიებისა და საბითუმო შეკვეთების სფეროებში, ზემოხსენებული მომსახურება განეკუთვნება შემდეგ საქონელს: ყავა, ჩაი, კაკაო, მზა და დაფასოებული საკვები, ჩაის დასამზადებლად განკუთვნილი ელექტრო და არაელექტრო ხელსაწყოები, ჭურჭელი, სამზარეულოს ჭურჭელი (სამზარეულოს საკუთნო), მინის ჭურჭელი და ნაკეთობები, სასაჩუქრე საქონელი, თევზები, ჯამები, შესანახი კონტეინერები, სტატუეტები, ფიგურები, დეკორატიული ნივთები, ტანსაცმელი, შანდლები, საკმეველი, სახლისათვის განკუთვნილი სურნელები (არომატიზატორები), პირადი ჰიგიენის ნივთები, მუსიკალური ჩანაწერები და წიგნები; საქონლის შეკვეთა ფოსტით, საქონლის შეკვეთა კატალოგით, კომპიუტერის მეშვეობით საქონლის შეკვეთა „ონ-ლაინ“ რეჟიმში, კომპიუტერის მეშვეობით „ონ-ლაინ“ რეჟიმში საცალო ვაჭრობა საბოლოო მომხმარებელთან უშუალო კავშირით, საქონლის შეკვეთა „ონ-ლაინ“ რეჟიმში და საქონლის გაყიდვა „ონ-ლაინ“ რეჟიმში, ზემოხსენებული მომსახურება განეკუთვნება შემდეგ საქონელს: ყავა, ჩაი, კაკაო, მზა და დაფასოებული საკვები, ჩაის დასამზადებლად განკუთვნილი ელექტრო და არაელექტრო ხელსაწყოები, ჭურჭელი, სამზარეულო ჭურჭელი (სამზარეულოს საკუთნო), მინის ჭურჭელი, სასაჩუქრე საქონელი,

თევზები, ჯამები, შესანახი კონტეინერები, სტატუეტები, ფიგურები, დეკორატიული ნივთები, ტანსაცმელი, შანდლები, საკმეველი, სახლისათვის განკუთვნილი სურნელები (არომატიზატორები), პირადი ჰიგიენის ნივთები, მუსიკალური ჩანაწერები და წიგნები; საჩუქრების რეგისტრაცია კომპიუტერის მეშვეობით „ონ-ლაინ“ რეჟიმში და საჩუქრების რეგისტრაციასთან დაკავშირებული მომსახურება შეკვეთის მიღებისას.

43 – რესტორნები, კაფეები, კაფეტერიები, სასაუზმეები, ჩაის ბარები, ჩაის სახლები (ჩაიხანები), ჩაის ოთახები (საჩაიეები), რესტორნები საკვების გატანის სერვისით; კეიტერინგი, (ბანკეტების, ქორწილების, სადღესასწაულო ღონისძიებების სარესტორნო მომსახურება; კერძების მომზადება (სახლში მიტანით); კვების პროდუქტებით მომარაგება ხელშეკრულების საფუძველზე; კერძების (საკვების) და სასმელების მომზადება.

- (260) AM 2015 73130 A
- (210) AM 73130
- (220) 2013 07 18
- (731) შპს „ეი-ბი-სი ფარმაცია“
სანაპიროს ქ.10, 0108, თბილისი,
საქართველო
- (740) სალომე ჯელაძე
- (540)

LACIDEX
ლაციდექსი
ЛАЦИДЕКС

- (591) შავ-თეთრი
- (511)
- 5 – ფარმაცევტული და ვეტერინალური პრეპარატები; სამედიცინო დანიშნულების დიეტური ნივთიერებები, ბავშვთა კვება; საღებუნები, სახვევი მასალა.

- (260) AM 2015 73136 A
- (210) AM 73136
- (220) 2013 07 22
- (731) შეფა ფრანჩაიზის ელტედე
7 ჰა'სოლელა სტ., ბეიტ-შემეშ, 99052,
ისრაელი
- (740) ლილიანა დარახველიძე
- (540)

AROMA ESPRESSO BAR

- (591) შავ-თეთრი
- (511)
- 30 – ბრინჯი, ტაპიოკა (მანიოკა), საგო, ფქვილი და მარცვლოვანი პროდუქტი, პურ-ფუნთუშეული, საკონდიტრო ნაწარმი, ნაყინი; თაფ-

ლი, ბადაგის ვაჟინი; საფუარი, საცხობი ფხვნილები, მარილი, მღოვვი; ძმარი, საკაზმები; სანელებლები; საკვები ყინული.

43 – საკვები პროდუქტებითა და სასმელებით უზრუნველყოფა; კაფეები (კაფე); ბარები; რესტორნები.

(260) AM 2015 73137 A

(210) AM 73137

(220) 2013 07 22

(731) შეფა ფრანჩაიზიზ ელტელე 7 ჰა'სოლელა სტ., ბეიტ-შემეშ, 99052, ისრაელი

(740) ლილიანა დარახველიძე

(540)



(591) შავ-თეთრი

(531) 27.05.22-26.04.24-27.05.24-

(511)

30 – ბრინჯი, ტაპიოკა (მანიოკა), საგო, ფქვილი და მარცვლოვანი პროდუქტი, პურ-ფუნთუშეული, საკონდიტრო ნაწარმი, ნაყინი; თაფლი, ბადაგის ვაჟინი; საფუარი, საცხობი ფხვნილები, მარილი, მღოვვი; ძმარი, საკაზმები; სანელებლები; საკვები ყინული.

43 – საკვები პროდუქტებითა და სასმელებით უზრუნველყოფა; კაფეები (კაფე); ბარები; რესტორნები.

(260) AM 2015 74755 A

(210) AM 74755

(220) 2013 11 15

(731) შპს „გეო-ალკო“ ლილოს ქ. 51, 0198, თბილისი, საქართველო

(540)

ძველი იბერია ДРЕВНЯЯ ИБЕРИЯ

(591) შავ-თეთრი

(526) ნიშანი დაცულია მთლიანობაში. მასში შემავალი სიტყვები „იბერია“ და „ИБЕРИЯ“ არ ექვემდებარება დამოუკიდებელ სამართლებრივ დაცვას.

(511)

33 – ალკოჰოლიანი სასმელი (ლუდის გარდა).

(260) AM 2015 75090 A

(210) AM 75090

(220) 2013 12 09

(731) შპს „შილდა ესთეითი“ ერეკლე II გამზ., 1, 2200, თელავი, საქართველო

(740) შალვა გვარამაძე

(540)

Shildis Mtebi

(591) შავ-თეთრი

(511)

32 – ლუდი; მინერალური და გაზიანი წყალი და სხვა უალკოჰოლო სასმელები; ხილის სასმელები და ხილის წვენები; ვაჟინები და სასმელების დასამზადებელი სხვა შედგენილობები.

33 – ალკოჰოლიანი სასმელები (ლუდის გარდა).

(260) AM 2015 75095 A*

(210) AM 75095

(220) 2013 12 09

(731) სოდილაქ 68, რიუ დე ვილიე, 92300 ლევალიუა-პერე, საფრანგეთი

(740) პავლე მეიფარიანი

(540)

MODILAC

(511)

5 – სამედიცინო დანიშნულების დიეტური კვება და ნივთიერებები; ბავშვთა კვება; ბავშვთათვის და ჩვილ ბავშვთათვის განკუთვნილი რძის ფხვნილი და რძე; საკვები და დიეტური დანამატები ადამიანებისათვის, განსაკუთრებით კი ბავშვებისათვის და ჩვილ ბავშვებისათვის; დავიტამინებული და მინერალებით გამდიდრებული სასმელები; დიეტური სასმელები.

29 – რძე და რძის პროდუქტები, სახელობრ, ვიტამინებით გამდიდრებული რძე, არომატიზებული რძე, რძის დესერტები, იოგურტები, საკვები ზეთები და ცხიმები; კარაქი; ყველი; რძიანი სასმელები რძის ჭარბი შემცველობით.

30 – კაკაო; ფქვილი და მარცვლოვანი პროდუქტები; პურ-ფუნთუშეული, საკონდიტრო ნაწარმი; ნაყინი; საკაზმები; ყველის საკაზმი.

32 – მინერალური და გაზიანი წყალი და სხვა უალკოჰოლო სასმელები; ხილის სასმელები და ხილის წვენები; ვაჟინები და სასმელების დასამზადებელი სხვა შედგენილობები.

(260) AM 2015 75703 A

(210) AM 75703

(220) 2014 01 28

- (731) ბენსუზან რესტორანტ კორპორეიშენ
131 უესტ მე-3 სტრიტი, ნიუ-იორკი,
ნიუ-იორკის შტატი 10012, აშშ
(740) თამაზ შილაკაძე
(540)

BLUE NOTE

- (511)
25 – ტანსაცმელი, პერანგები, ქუდეები.
41 – კაბარეს მომსახურება; გართობის უზრუნველყოფა ცოცხალი შესრულებით; ცოცხალი ჯაზ-წარმოდგენები.
43 – რესტორნების მომსახურება.

- (260) AM 2015 75720 A
(210) AM 75720
(220) 2014 01 29
(731) შპს „ლთბ“
თორნიკე ერისთავის ქ. №2, 0192
თბილისი, საქართველო
(740) გიორგი თაქთაქიშვილი
(540)



- (591) შავ-თეთრი
(531) 14.03.07, 07.15.06, 26.03.04, 26.13.25,
27.05.23, 14.03.03
(511)
6 – ავეჯის ლითონის ფურნიტურა, მათ შორის, გორგოლაჭები, ბორბლები.
20 – ავეჯი, სარკეები, სურათების ჩარჩოები და ა. შ.; ხის, კორპის, ლელქაშის, ლერწმის, რქის, ძვლის, სპილოს ძვლის, ვეშაპის უღვაშის, კუს ბაკნის, ნიჟარის, ქარვის, სადაფის, „ზღვის ხვრთქლისა“ და ამ მასალების შემცველებების ან პლასტმასის ნაკეთობა, რომელიც არ მიეკუთვნება სხვა კლასებს.
35 – საცალო საბითუმო ვაჭრობა.

- (260) AM 2015 76184 A
(210) AM 76184
(220) 2014 03 07
(731) ლევან ალაგიძე
ხეიხიას ქ. №17, ბ. 12, 0160 თბილისი,
საქართველო
(740) თამაზ მახარაშვილი

(540)



- (591) ლურჯი, თეთრი
(531) 19.07.12, 25.03.13, 01.15.15, 29.01.04
(526) ნიშანი დაცულია მთლიანობაში. მასში შემავალი სიტყვა "FOOD" არ ექვემდებარება დამოუკიდებელ სამართლებრივ დაცვას.
(511)
29 – რძე და რძის პროდუქტები.
30 – საკონდიტრო ნაწარმი, ნაყინი, საკაზმები (მაიონეზი, კეტჩუპი).

- (260) AM 2015 76307 A
(210) AM 76307
(220) 2014 03 19
(731) ასტრაზენეკა აბ
SE-151 85 სედერტელიე, შვედეთი
(740) თამაზ შილაკაძე
(540)

FORXIGA

- (511)
5 – ფარმაცევტული პრეპარატები და ნივთიერებები.

- (260) AM 2015 76364 A
(210) AM 76364
(220) 2014 03 21
(731) ფილიპ მორის ბრენდზ სარლ
კე უანრენო 3, 2000 ნევშატელი,
შვეიცარია
(740) შალვა გვარამაძე
(540)

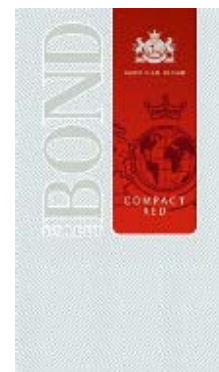

- (591) თეთრი, შავი, სხვადასხვა ტონის ნაცრისფერი, ცისფერი და წითელი
(531) 01.05.01, 24.01.25, 24.09.07, 25.01.01,
25.07.15, 27.05.10, 29.01.15
(526) ნიშანი დაცულია მთლიანობაში. მასში შემავალი სიტყვები "AMERICAN BLEND" არ ექვემდებარება დამოუკიდებელ სამართლებრივ დაცვას.

(511)
34 – დამუშავებული ან დაუმუშავებელი თამბაქო; თამბაქოს პროდუქტები, სიგარეტის, სიგარეტების, სიგარილოების, საკუთარ სიგარეტში გასახვევი თამბაქოს, ჩიბუხის თამბაქოს, საღეჭი თამბაქოს, საბურნუთე თამბაქოს, კრეტეკის ჩათვლით; თამბაქო „სნუსი“; თამბაქოს შემცველები (არასამედიცინო დანიშნულების); მწველთა საკუთონოები სიგარეტის ქაღალდის და სიგარეტის მილაკების (მუნდშტუკების), სიგარეტის ფილტრების, თამბაქოს ქილების, სიგარეტის კოლოფების და საფერფლებების, ჩიბუხების, სიგარეტის გადასახვევი ჯიბის მოწყობილობების, სანთებულების ჩათვლით; ასანთი.

- (260) AM 2015 76365 A
- (210) AM 76365
- (220) 2014 03 21
- (731) ფილიპ მორის ბრენდს სარლ
კე ჟანრენო 3, 2000 ნევშატელი,
შვეიცარია
- (740) შალვა გვარამაძე
- (540)



(591) თეთრი, შავი, სხვადასხვა ტონის ნაცრისფერი, ცისფერი და ღურჯი
(531) 24.01.25, 24.09.07, 25.07.15, 25.01.01, 27.05.10, 29.01.15, 01.05.01
(526) ნიშანი დაცულია მთლიანობაში. მასში შემავალი სიტყვები "AMERICAN BLEND" არ ექვემდებარება დამოუკიდებელ სამართლებრივ დაცვას.
(511)
34 – დამუშავებული ან დაუმუშავებელი თამბაქო; თამბაქოს პროდუქტები, სიგარეტის, სიგარეტების, სიგარილოების, საკუთარ სიგარეტში გასახვევი თამბაქოს, ჩიბუხის თამბაქოს, საღეჭი თამბაქოს, საბურნუთე თამბაქოს, კრეტეკის ჩათვლით; თამბაქო „სნუსი“; თამბაქოს შემცველები (არასამედიცინო დანიშნულების); მწველთა საკუთონოები სიგარეტის ქაღალდის და სიგარეტის მილაკების (მუნდშტუკების), სიგარეტის ფილტრების, თამბაქოს ქილების, სიგარეტის კოლოფების და საფერფლებების, ჩიბუხების, სიგარეტის გადასახვევი

ჯიბის მოწყობილობების, სანთებულების ჩათვლით; ასანთი.

- (260) AM 2015 76366 A
- (210) AM 76366
- (220) 2014 03 21
- (731) ფილიპ მორის ბრენდს სარლ
კე ჟანრენო 3, 2000 ნევშატელი,
შვეიცარია
- (740) შალვა გვარამაძე
- (540)

MARLBORO NEW TOUCH

(511)
34 – დამუშავებული ან დაუმუშავებელი თამბაქო; თამბაქოს პროდუქტები, სიგარეტის, სიგარეტების, სიგარილოების, საკუთარ სიგარეტში გასახვევი თამბაქოს, ჩიბუხის თამბაქოს, საღეჭი თამბაქოს, საბურნუთე თამბაქოს, კრეტეკის ჩათვლით; თამბაქო „სნუსი“; თამბაქოს შემცველები (არასამედიცინო დანიშნულების); მწველთა საკუთონოები სიგარეტის ქაღალდის და სიგარეტის მილაკების (მუნდშტუკების), სიგარეტის ფილტრების, თამბაქოს ქილების, სიგარეტის კოლოფების და საფერფლებების, ჩიბუხების, სიგარეტის გადასახვევი ჯიბის მოწყობილობების, სანთებულების ჩათვლით; ასანთი.

- (260) AM 2015 76421 A
- (210) AM 76421
- (220) 2014 03 26
- (731) აიკონ ჰელზ ენდ ფიტნეს ინკ
1500 საუთ 1000 ვესტ, ლოგან, იუტა
84321, აშშ
- (740) გიორგი ღვინჯილია
- (540)

NORDICTRACK

(511)
28 – სარბენი ბილიკები: ორბიტრეკები; ველოტრენაჟორები ადგილზე ვარჯიშისათვის; ტრენაჟორები ტანვარჯიშისათვის; სკამები ტანვარჯიშისათვის; სახელურები ტანვარჯიშისათვის; შტანგები; ჰანტელები; ფირფიტები შტანგისათვის; გრიფები შტანგისათვის, საყრდენები შტანგისათვის; საყრდენები ჰანტელებისათვის; საკეტები შტანგებისა და ჰანტელებისათვის; სახტუნაო თოკები; მდგრადი სავარჯიშოები (ესპანდერები); ხელით სამართავი ფიტნესის ადჟურვილობა; ბურთები ვარჯიშისათვის; სტაციონალური ტრენაჟორები ადგილზე ვარჯიშისათვის; ყველა ზემოთხამოთვლილი გარდა შემუშავებული, განკუთვნილი ან გაყიდვაში მყოფი ზამთრის სპორტის სახეობისათვის.

- (260) AM 2015 76459 A
- (210) AM 76459
- (220) 2014 03 28
- (731) შპს „მაგნუმ ელექტრონიკსი“
თარხნიშვილის ქ.1, გასასვლელი 1, 0179
თბილისი, საქართველო
- (540)

CRON

- (511)
11 – განათების, გათბობის, ორთქლწარმოქმნის, საკვები პროდუქტის თბური დამუშავების, გასაცივებელი, საშრობი, ვენტილაციის, წყალგამანაწილებელი და სანიტარულ-ტექნიკური მოწყობილობები.
- 35 – რეკლამა; მართვა საქმიან სფეროში; ადმინისტრირება საქმიან სფეროში; საოფისე სამსახური.

- (260) AM 2015 76460 A
- (210) AM 76460
- (220) 2014 03 28
- (731) ტოიოტა ჯიდოშა კაბუშიკი კაიშა
(მოვაჭრე როგორც ტოიოტა მორტორ
კორპორეიშენ)
1, ტოიოტა-ჩო, ტოიოტა-ში, აიჩი-კენ,
იაპონია
- (740) თამარ კოჭლამაზაშვილი
- (540)

FORTUNER

- (511)
12 – ავტომობილები და მათი ნაწილები, კონსტრუქციის ელემენტები, მათთვის განკუთვნილი მზიდი ნაწილები.

- (260) AM 2015 76710 A
- (210) AM 76710
- (220) 2014 04 15
- (731) შპს „პითუსაკო“
წერეთლის გამზ. 77, თბილისი,
საქართველო
- (740) დავით ხალვაში
- (540)



- (591) ლურჯი, წითელი, თეთრი
- (531) 26.13.25, 27.05.24, 29.01.13, 26.11.12
- (511)
29 – ხორცი, თევზი, ფრინველი და ნანადირევი; ხორცის ექსტრაქტები; დაკონსერვებული,

გამხმარი და თბურად დამუშავებული ბოსტნეული და ხილი; ქვლე, მურაბა, კომპოტი; კვერცხი, რძე და რძის ნაწარმი; ზეთები და საკვები ცხიმები.

30 – ყავა, ჩაი, კაკაო, შაქარი, ბრინჯი, ტაპიოკა (მანიოკა), საგო, ყავის შემცველები; ფქვილი და მარცვლოვანი პროდუქტი, პურ-ფურთუშეული, საკონდიტრო ნაწარმი, ნაყინი; თაფლი, ბადაგის ვაჭინი; საფუარი, საცხობი ფხვნილები; მარილი, მღოგვი; ძმარი, საკაზმები; სანელებლები; საკვები ყინული.

31 – სოფლის მეურნეობის, ბაღჩა-ბაღისა და ტყის პროდუქტები და მარცვლეული, რომელიც არ მიეკუთვნება სხვა კლასებს; ცოცხალი ცხოველები; ცოცხალი ხილი და ბოსტნეული; თესლეული, ცოცხალი მცენარეები და ყვავილები; ცხოველთა საკვები; ალაო.

- (260) AM 2015 76736 A
- (210) AM 76736
- (220) 2014 04 22
- (731) ჰარინგტონ დიველოპმენტ ინკ.
ელვირა მენდესის სტრიტი, ვალერინო
ბლდგ, მე-3 სართ., პანამა
- (740) გივი აკოფაშვილი
- (540)



- (591) თეთრი, შავი, ლურჯი, წითელი
- (531) 03.01.02, 19.03.24, 25.01.01, 27.05.24,
29.01.14
- (511)
34 – სიგარეტი, თამბაქო, თამბაქოს ნაწარმი, მწვეველთა საკუთნო, სანთებელა, ასანთი.

- (260) AM 2015 76739 A
- (210) AM 76739
- (220) 2014 04 22
- (731) ლჯ ლაიფ საიენსიზ, ლტდ.
58, სამეუნან-რო, ჩონოგუ, სეული,
კორეის რესპუბლიკა
- (740) თამარ კოჭლამაზაშვილი
- (540)

PROTESCAL

(511)
5 – ფარმაცევტული პრეპარატები; გიალურონული მჟავას შემცველი ფარმაცევტული პრეპარატები, რომლებიც გამოიყენება შინაგანი ორგანოების ან კანის ადგეზიის თავიდან ასაცილებლად ქირურგიული ოპერაციების დროს; ქირურგიული ოპერაციების დროს ადგეზიის თავიდან ასაცილებლად გამოსაყენებელი აგენტები/საშუალებები; გიალურონული მჟავას შემცველი აგენტები/შემადგენლობები, რომლებიც გამოიყენება ქირურგიულ ოპერაციებში, ადგეზიის თავიდან ასაცილებლად; გიალურონული მჟავას შემცველი აგენტები/საშუალებები, რომლებიც გამოიყენება ქირურგიული ადგეზიის თავიდან ასაცილებლად; ქირურგიულ ოპერაციებში გამოსაყენებელი ალგინატები და კარბოქსიმეთილცელულოზა; გიალურონული მჟავას შემცველი ქირურგიული საშუალებები/პრეპარატები, რომლებიც გამოიყენება ქირურგიულ ოპერაციებში.

(260) AM 2015 76785 A
(210) AM 76785
(220) 2014 04 24

(731) სს „რეალ ინვესტი“
ძველი თბილისის რაიონში, დ.
აღმაშენებლის გამზ. №150, საქართველო

(740) ვახტანგ ტოროტაძე
(540)

Roof Garden რუფ გარდენ

(511)
43 – საკვები პროდუქტებითა და სასმელებით უზრუნველყოფა; დროებითი საცხოვრებელი უზრუნველყოფა.

(260) AM 2015 76842 A
(210) AM 76842
(220) 2014 04 28
(731) ალმირალ, ს.ა.
რონდა ხენერალ მიტრე, 151, 08022
ბარსელონა, ესპანეთი
(740) გიორგი თაქთაქიშვილი
(540)

“ბრიმიკა”

(511)
5 – ფარმაცევტული პრეპარატები.

(260) AM 2015 76847 A
(210) AM 76847
(220) 2014 04 28
(731) ექსონ მობილ კორპორეიშნ
5959 ლას კოლინას ბუელვარი, ირვინგი,
ტექსასის შტატი 75039-2298, აშშ

(740) შალვა გვარამაძე
(540)

EAL

(511)
4 – ჰიდრავლიკური ზეთები; საპოხი ზეთები.

(260) AM 2015 76956 A
(210) AM 76956
(220) 2014 05 02
(731) ოლგა ბელიაკოვა
ქ. დუბოსარი, სტამბოლის ქ. 9, მოლდოვას
რესპუბლიკა
(740) ოლგა ბელიაკოვა
(540)



(591) გარდამავალი ღურჯი, ოქროსფერი
(531) 26.04.24, 27.05.01, 27.05.24, 29.01.12
(511)

14 – კეთილშობილი ლითონები და მათი შენადნობები, მათგან დამზადებული ან დაფარული ნაკეთობა, რომელიც არ მიეკუთვნება სხვა კლასებს; საიუველირო ნაწარმი, ძვირფასი ქვები; საათები და სხვა ქრონომეტრული ხელსაწყოები.

35 – რეკლამა; მართვა საქმიან სფეროში; ადმინისტრირება საქმიან სფეროში; საოფისე სამსახური, ვაჭრობა.

(260) AM 2015 77098 A
(210) AM 77098
(220) 2014 05 13
(731) გიგი კოსმეტიკ ლაბორატორიზ ლტდ.
7 ჰამიფალიმ სტ. ს/ყ 10225, პეტაჰ ტიკვა
49002, ისრაელი
(740) შალვა გვარამაძე
(540)

GIGI

(511)
3 – სილამაზის და სხეულის მოსაველელი საშუალებები, სახელდობრ, საპნები, პარფიუმერია, ეთერ ზეთები, კოსმეტიკური საშუალებები, თმის ღოსიონები.

(260) AM 2015 77127 A
(210) AM 77127
(220) 2014 05 14

(731) შპს „ავიტა“
ტაშკენტის ქ. №31, ბ. 164, თბილისი,
საქართველო
(740) ელჩინი ვალიევი
(540)

იმუფლორი
Immuflo
Иммуфлор

(511)
5 – ფარმაცევტული და ვეტერინარული პრეპარატები; სანიტარული პრეპარატები სამედიცინო მიზნებისათვის; დიეტური ნივთიერებები სამედიცინო მიზნებისათვის, ბავშვთა კვება; საღებუნები, გადასახვევი საშუალებები; კბილის დასაბუნნი საშუალებები, კბილის ტვიფრის დასამზადებელი საშუალებები; დეზინფექტანტები; მავნე ცხოველების გასანადგურებელი საშუალებები; ფუნგიციდები, ჰერბიციდები.

(260) AM 2015 77329 A

(210) AM 77329

(220) 2014 05 29

(731) აკკორ
110 ავენიუ დიუ ფრანს, 75013 პარიზი,
საფრანგეთი

(740) ლილიანა დარახველიძე

(540)

IBIS

(511)
43 – სასტუმროები (ოტელები), მოტელები, სასტუმრო კომპლექსების ექსპლუატაცია; სასტუმროების (ოტელების) მომსახურება; კვების პროდუქტების და სასმელების უზრუნველყოფის მომსახურება; რესტორნების, კაფეტერიების, კაფეების, ბარების (კლუბების გარდა) მომსახურება; დროებითი საცხოვრებლის უზრუნველყოფა; დასასვენებელი ბაზები (ბანაკები); მოგზაურებისათვის სასტუმროებში ადგილების დაჯავშნა; დროებითი საცხოვრებელი ადგილების დაჯავშნა; კონსულტაციები და რჩევები (არა კომერციული) სასტუმროების (ოტელების) და რესტორნების სფეროში.

(260) AM 2015 77347 A

(210) AM 77347

(220) 2014 05 30

(731) ედ სოლუშნ მედია ესოუშიეტს ლიმიტიდ
ლაიებილიტი პარტნერშიპ
სვიტ 303, პრინსეს ჰაუს, 50-60 ისტქასლ
სორიტ, ლონდონი, W1W 8EA,
გაერთიანებული სამეფო
(740) შალვა გვარამაძე

(540)



(591) იისფერი, ბორდო, თეთრი
(531) 01.01.10, 27.03.15, 26.04.24, 27.05.24,
29.01.13

(511)

35 – სარეკლამო მასალების გაერცელება; რეკლამა; ინტერაქტიული რეკლამა კომპიუტერულ ქსელში.

(260) AM 2015 77348 A

(210) AM 77348

(220) 2014 05 30

(731) ედ სოლუშნ მედია ესოუშიეტს ლიმიტიდ
ლაიებილიტი პარტნერშიპ
სვიტ 303, პრინსეს ჰაუს, 50-60 ისტქასლ
სორიტ, ლონდონი, W1W 8EA,
გაერთიანებული სამეფო

(740) შალვა გვარამაძე

(540)



(591) ღია მწვანე, ნაცრისფერი, თეთრი

(531) 05.03.15, 27.05.01, 29.01.12

(511)

35 – სარეკლამო მასალების გაერცელება; რეკლამა; ინტერაქტიული რეკლამა კომპიუტერულ ქსელში.

(260) AM 2015 77370 A

(210) AM 77370

(220) 2014 06 02

(731) ჰ. ლუნდბეკ ა/ს
ოტილიავეი 9 2500 ვალბი, დანია

(740) თამარ კოჭლამაზაშვილი

(540)

БРИНТЕЛЛИКС

(511)

5 – ფარმაცევტული პრეპარატები; ფარმაცევტული პრეპარატები და ნივთიერებები იმ დაავადებების და დარღვევების მკურნალობისათვის და პრევენციისათვის, რომლებიც აღმოცენდებიან ან ზემოქმედებენ ცენტრალურ ნერვულ სისტემაზე; ცენტრალური ნერვული სისტემის სტიმულატორები; ფარმაცევტული პრეპარატები და ნივთიერებები ფსიქიატრიული და ნევროლოგიური დაავადებების და დარღვევების მკურნალობისათვის და პრევენციისათვის; ფარმაცევტული პრეპარატები და ნივთიერებები ალცჰეიმერის დაავადების, დემენსიის, ფსიქოზების, ალზნების (შფოთვის),

ეპილეფსიის, სკლეროზის, პორფირიების, ჰანტინგტონის დაავადების, უძილობის, პარკინსონის დაავადების, შიზოფრენიის, ბიპოლარული დარღვევების, ონკოლოგიის, ტკივილის სიმპტომის, ალკოჰოლიზმის და ალკოჰოლდამოკიდებულობის, ხასიათის (განწყობის) დარღვევების მკურნალობისა და პრევენციისათვის; პრეპარატები, ნივთიერებები რეაგენტები და აგენტები დიაგნოსტიკური და სამედიცინო მიზნებისათვის.

(260) AM 2015 77371 A

(210) AM 77371

(220) 2014 06 02

(731) შპს „ფლაი ვისტა“

მოსაშვილის ქ. №2, ბ. 86, თბილისი, საქართველო

(740) ჯუმბერ იაკობაძე

(540)



(591) ცისფერი, ბორდოსფერი

(531) 29.01.12, 26.03.23, 27.01.25

(511)

39 – ტრანსპორტირება; საქონლის შეფუთვა და შენახვა; მოგზაურობის ორგანიზება.

(260) AM 2015 77466 A

(210) AM 77466

(220) 2014 06 09

(731) ობშჩესტვო ს ოგრანიჩენნი ოტკეტსტვენოსტიუ „კოორდინირუიუში რასპრედელიტელნი ცენტრ „ეფკო-კასკად“ ულ. ფრუნზე, დ. 4, გ. ალექსეევკა, 309850, ბელგოროდსკაია ობლასტ, რუსეთის ფედერაცია

(740) თამაზ შილაკაძე

(540)



(591) შავ-თეთრი

(531) 07.15.05, 26.03.06, 26.03.19, 27.05.03

(511)

3 – მათეთრებელი პრეპარატები და სხვა სარეცხი ნივთიერებები; წმენდის, გაპრიალების, გაუცხიმოვნებისა და აბრაზიული დამუშავების პრეპარატები; საპნები; პარფიუმერია, ეთერზეთები, კოსმეტიკური საშუალებები, თმის ღოსიონები; კბილის ფხვნილები და პასტები.

(260) AM 2015 77531 A

(210) AM 77531

(220) 2014 06 12

(310) 86/ 141,890

(320) 2013 12 12

(330) US

(731) ტიტან ინტერნეშენელ, ინკ.

2701 სპრუს სტრიტი, კუინსი, ილინოისი 62301, აშშ

(740) თამაზ შილაკაძე

(540)

EXTREME FLOTATION

(511)

12 – სალტეები და საბურავები.

(260) AM 2015 77553 A

(210) AM 77553

(220) 2014 06 13

(731) შპს "SAH&Co"

ვაჟა-ფშაველას გამზ., 79, ბ.159, 0186 თბილისი, საქართველო

(740) ზურაბ ვანიშვილი

(540)



(591) მუქი ცისფერი, წითელი, ყვითელი, ღია რუხი

(531) 01.15.05, 25.01.19, 26.04.24, 27.05.24, 29.01.14

(511)

32 – ლუდი, მინერალური და გაზიანი წყალი და სხვა უალკოჰოლო სასმელები; ხილის სასმელები და ხილის წვენები; ვაჟინები და სასმელების დასამზადებელი სხვა შედგენილობები.

(260) AM 2015 76974 A

(210) AM 76974

(220) 2014 05 05

(731) სვისგეარ სარლ

ჰალდენშტრასე 5, ბაარი, შვეიცარია

(740) ვახტანგ ტოროტაძე

(540)



(531) 16.01.08, 24.13.01, 26.11.12, 27.05.02,
16.01.07

(511)

14 – სამაჯურები; მანუეტის საკინძეები; ჰალს-ტუხის სამაგრები; მაჯის საათები; წამზომები; საათები ჩაყვინთვისთვის; საათის სამაჯურები; მაჯის საათები, ელექტრული; საათები, ელექტრული; მაჯის საათების კეისები (სასაჩუქრე); საათები (არა მაჯის); ატომური საათები; საათი-ბრასლეტები; ქრონოგრაფები; დროის მზომი; ელექტრონული მაჯის საათი ელექტრონული თამაშებით.

რეგისტრირებული სასაქონლო ნიშნები

(111) M 2015 025664 R
 (151) 2015 02 18
 (181) 2025 02 18
 (260) AM 2014 72433 A
 (220) 2013 05 30
 (732) შპს "Orion"

ნაფარეულის ქ. №5, 0179, თბილისი,
 საქართველო

(111) M 2015 025665 R
 (151) 2015 02 18
 (181) 2025 02 18
 (260) AM 2014 72578 A
 (220) 2013 06 10

(732) კარენ ვარდანიანი
 ბაირონის ქ. 3, ბ. 36, ერევანი, სომხეთი

(111) M 2015 025666 R
 (151) 2015 02 18
 (181) 2025 02 18
 (260) AM 2014 72815 A
 (220) 2013 06 24

(732) უნგვოუ იუტონგ ბას კო., ლტდ.
 იუტონგ როუდ, გუანხენგ დისტრიქტ,
 უნგვოუ, ჩინეთი

(111) M 2015 025667 R
 (151) 2015 02 18
 (181) 2025 02 18
 (260) AM 2014 72887 A
 (220) 2013 07 01

(732) ჯენერალ მოტორს ლტკ
 300 რეინესანს სენტერი, სიტი ოფ
 დეტროიტი, მიჩიგანის შტატი 48265-3000,
 აშშ

(111) M 2015 025668 R
 (151) 2015 02 18
 (181) 2025 02 18
 (260) AM 2014 72968 A
 (220) 2013 07 05

(732) სააქციო საზოგადოება „ჯი პი სი“
 მარჯანიშვილის ქ. 26, 0102, თბილისი,
 საქართველო

(111) M 2015 025669 R
 (151) 2015 02 18
 (181) 2025 02 18
 (260) AM 2014 73088 A

(220) 2013 07 12

(732) შპს „ტიფლისსკი ვინნი პოგრებ“
 იუმაშევის ქ. 27, 0198, თბილისი,
 საქართველო

(111) M 2015 025670 R
 (151) 2015 02 18
 (181) 2025 02 18
 (260) AM 2014 73173 A
 (220) 2013 07 24

(732) შპს „ჯეოსთილი“
 დავით გარეჯის ქ. 36, 3700, რუსთავი,
 საქართველო

(111) M 2015 025671 R
 (151) 2015 02 18
 (181) 2025 02 18
 (260) AM 2014 73651 A
 (220) 2013 08 23

(732) ობშჩესტვო ს ოგრანიზენი
 ოტვეტსტვენოსტიუ „ტორის“
 190000, სანქტ-პეტერბურგი, პროსპექტ
 კულტური, ლიტ. D, პომ. 2N, რუსეთის
 ფედერაცია

(111) M 2015 025672 R
 (151) 2015 02 18
 (181) 2025 02 18
 (260) AM 2014 73940 A
 (220) 2013 09 18

(732) ინდივიდუალური მეწარმე „გონა
 მეფარიშვილი“
 სოფ. წითელიხევი, 1000, ბაღდათი,
 საქართველო

(111) M 2015 025673 R
 (151) 2015 02 18
 (181) 2025 02 18
 (260) AM 2014 74060 A
 (220) 2013 09 27

(732) დაიჯეო ბრენდს ბ.ვ.
 10-12 მოლენვერგ, 1014 BG ამსტერდამი,
 ნიდერლანდი

(111) M 2015 025674 R
 (151) 2015 02 18
 (181) 2025 02 18
 (260) AM 2014 74263 A
 (220) 2013 10 09

(732) შპს „ფასარგად“
ვ. ბაგრატიონის ქ., კორპ. 5, ბლოკი 1,
სართული 1, საქართველო

(111) M 2015 025675 R
(151) 2015 02 18
(181) 2025 02 18
(260) AM 2014 74340 A
(220) 2013 10 15
(732) შპს „ემბრიონი“
ს. ყარათაქლა, 4703, გარდაბანი,
საქართველო

(111) M 2015 025676 R
(151) 2015 02 18
(181) 2025 02 18
(260) AM 2014 74378 A
(220) 2013 10 18
(732) პლუმ, ინკ
660 ალაბამა სტრიტი, მე-2 სართული,
სან-ფრანცისკო, კალიფორნია 94110,
აშშ

(111) M 2015 025677 R
(151) 2015 02 18
(181) 2025 02 18
(260) AM 2014 74395 A
(220) 2013 10 21
(732) ღსს „ფარმსინტეზი“
188663, ლენინგრადის ოლქი,
ვსეელოვსკის რაიონი, კუზმოლოვსკის
დასახლება, სადგური კაპიტოლოვო,
N134, ლიტერი 1, რუსეთის ფედერაცია

(111) M 2015 025678 R
(151) 2015 02 18
(181) 2025 02 18
(260) AM 2014 74486 A
(220) 2013 10 25
(732) სს „ივერია“
გუდაუთის ქ. №7, დიდუბის რაიონი, 0119,
თბილისი, საქართველო

(111) M 2015 025679 R
(151) 2015 02 18
(181) 2025 02 18
(260) AM 2014 74492 A
(220) 2013 10 28
(732) ექსპორტადორა უნიფრუტი თრეიდერს
ლიმიტადა
მირაფლორეს 222, 23 ფლორ, 8320198
სანტიაგო, ჩილე

(111) M 2015 025680 R
(151) 2015 02 18
(181) 2025 02 18
(260) AM 2014 74573 A
(220) 2013 11 01
(732) ბიოგენ აიდეკ მა ინკ., მასაჩუსეტსის
კორპორაცია
14 კემბრიჯ სენტერი, კემბრიჯი,
მასაჩუსეტსი 02142, აშშ

(111) M 2015 025681 R
(151) 2015 02 18
(181) 2025 02 18
(260) AM 2014 74630 A
(220) 2013 11 05
(732) ზურაბ ბუბუტიევილი
ფალიაშვილის ქ. 62, 0179, თბილისი,
საქართველო

(111) M 2015 025682 R
(151) 2015 02 18
(181) 2025 02 18
(260) AM 2014 74682 A
(220) 2013 11 07
(732) სპირიტს ინტერნაციონალ ბ.ვ.
3, რიუ დუ ფორტ რჰეინშიემ, L-2419,
ქ. ლუქსემბურგი, ლუქსემბურგი

(111) M 2015 025683 R
(151) 2015 02 18
(181) 2025 02 18
(260) AM 2014 74770 A
(220) 2013 11 18
(732) ვიზა ინტერნემენელ სერვის ესოსიეიშენ
900 მეტრო სენტერ ბუღვარი, ფოსტერ-
სიტი, კალიფორნია 94404, აშშ

(111) M 2015 025684 R
(151) 2015 02 18
(181) 2025 02 18
(260) AM 2014 74982 A
(220) 2013 12 02
(732) მერკ შარპ & დომე კორპ.
უან მერკ დრაივი, უაიტჰაუზ-სტეიშენი,
ნიუ-ჯერსი 08889, აშშ

(111) M 2015 025685 R
(151) 2015 02 18
(181) 2025 02 18
(260) AM 2014 75081 A
(220) 2013 12 06
(732) სს „თბილდვინო“

სარაჯიშვილის გამზ. 2, 0153, თბილისი, საქართველო

(111) M 2015 025686 R
(151) 2015 02 18
(181) 2025 02 18
(260) AM 2014 75082 A
(220) 2013 12 06
(732) სს „თბილღვინო“

სარაჯიშვილის გამზ. 2, 0153, თბილისი, საქართველო

(111) M 2015 025687 R
(151) 2015 02 18
(181) 2025 02 18
(260) AM 2014 75083 A
(220) 2013 12 06
(732) სს „თბილღვინო“

სარაჯიშვილის გამზ. 2, 0153, თბილისი, საქართველო

(111) M 2015 025688 R
(151) 2015 02 18
(181) 2025 02 18
(260) AM 2014 75097 A
(220) 2013 12 09

(732) ასუსტეკ კომპიუტერ ინკორპორეიშენ 4ფ. No:150, ლი-ტე რდ., პეიტოუ, ტაიპეი, ტაივანი, ჩინეთი

(111) M 2015 025689 R
(151) 2015 02 18
(181) 2025 02 18
(260) AM 2014 75119 A
(220) 2013 12 13

(732) ბრიტიშ ამერიკენ ტობაკო (ბრენდს) ინკ. (დელავერის კორპორაცია) 2711 სენტერვილ როუდი, სუიტი 300, უილმინგტონი, დელავერი 19808, აშშ

(111) M 2015 025690 R
(151) 2015 02 18
(181) 2025 02 18
(260) –
(220) 2014 02 12

(732) ზე რისერჩ ფაუნდეიშენ ფორ მაიკრობიელ დისიზიზ ოფ ოსაკა იუნივერსიტი ს/ო ოსაკა იუნივერსიტი, 3-1 იამადაოკა, სუიტა-ში, ოსაკა 565-0871, იაპონია

(111) M 2015 025691 R
(151) 2015 02 18
(181) 2025 02 18
(260) AM 2014 73928 A
(220) 2013 09 16

(732) შპს „ღვინისა და ალკოჰოლური სასმელების კომპანია შაქრიანი“ ე. ახვლედიანის ქ. 66, 2200, თელავი, საქართველო

(111) M 2015 025692 R
(151) 2015 02 18
(181) 2025 02 18
(260) AM 2014 73929 A
(220) 2013 09 16

(732) შპს „ღვინისა და ალკოჰოლური სასმელების კომპანია შაქრიანი“ ე. ახვლედიანის ქ. 66, 2200, თელავი, საქართველო

(111) M 2015 025693 R
(151) 2015 02 18
(181) 2025 02 18
(260) AM 2014 73939 A
(220) 2013 09 17

(732) ჟანომე სეუინგ მაშინ კომპანი ლიმიტედ. 1463 ჰადამა-მატი, ჰატიოძი-სი, ტოკიო, იაპონია

(111) M 2015 025694 R
(151) 2015 02 18
(181) 2025 02 18
(260) AM 2014 74163 A
(220) 2013 10 02

(732) საქართველოს არბიტრთა ასოციაცია ვაკე-საბურთალოს რაიონი, ვაჟა-ფშაველას გამზ. 71, ოფისი №35/1, (ბლოკი 4), თბილისი, საქართველო

(111) M 2015 025695 R
(151) 2015 02 18
(181) 2025 02 18
(260) AM 2014 74345 A
(220) 2013 10 15

(732) მასტერკარდ ინტერნეშენელ ინკორპორეიტიდ, დელავერის კორპორაცია 2000 პერჩიზ სტრიტი, პერჩიზი, ნიუ-იორკი 10577, აშშ

(111) M 2015 025696 R
(151) 2015 02 18
(181) 2025 02 18
(260) AM 2014 74602 A
(220) 2013 11 04
(732) შპს „ლაგაშური“
პ. მელიქიშვილის ქ. №10, ბ. №78, 4600,
ქუთაისი, საქართველო

(111) M 2015 025697 R
(151) 2015 02 18
(181) 2025 02 18
(260) AM 2014 74684 A
(220) 2013 11 08
(732) შპს "LONTIN-ლონტინ"
მელაანის მე-4 შესახე, №31, თბილისი,
საქართველო

(111) M 2015 025698 R
(151) 2015 02 18
(181) 2025 02 18
(260) AM 2014 74979 A
(220) 2013 11 29
(732) შპს „არმუნჯი“
ზურაბ ჭავჭავაძის ქ. 56, 4800, ყვარელი,
საქართველო

(111) M 2015 025699 R
(151) 2015 02 19
(181) 2025 02 19
(260) AM 2014 71659 A
(220) 2013 04 03
(732) ღია გელიაშილი
გალის ქ. 1, 0179, თბილისი, საქართველო

დაქარაუბული პროცედურით რეგისტრირებული სასაქონლო ნიშნები

რეგისტრაციის გაუქმების მოთხოვნით საჩივრის შეტანა შესაძლებელია საქპატენტის სააპელაციო პალატაში გამოქვეყნებიდან 3 თვის ვადაში.

(111) M 2015 25660 R

(151) 2015 01 06

(181) 2025 01 06

(210) AM 80412

(220) 2015 01 22

(732) შპს „პაქსან კორპორეიშენ“
18, ზაგროს სტ., არგენტინა სკ. თეირანი,
ირანის ისლამური რესპუბლიკა

(740) მოჰამად ყასემის

(540)

რახშა
RAKHSHA
РАХША

(591) შავ-თეთრი

(511)

3 – მათეთრებელი პრეპარატები და სხვა სარეცხი ნივთიერებები; წმენდის, გაპრიალების, გაუცხიმოვნებისა და აბრაზიული დამუშავების პრეპარატები; საპნები; პარფიუმერია, ეთერზეთები, კოსმეტიკური საშუალებები, თმის ლოსიონები; კბილის ფხვნილები და პასტები.

(111) M 2015 25661 R

(151) 2015 01 06

(181) 2025 01 06

(210) AM 80411

(220) 2015 01 22

(732) შპს „პაქსან კორპორეიშენ“
18, ზაგროს სტ., არგენტინა სკ. თეირანი,
ირანის ისლამური რესპუბლიკა

(740) მოჰამად ყასემის

(540)

ბარფი
BARF
БАРФ

(591) შავ-თეთრი

(511)

3 – მათეთრებელი პრეპარატები და სხვა სარეცხი ნივთიერებები; წმენდის, გაპრიალების, გაუცხიმოვნებისა და აბრაზიული დამუშავების პრეპარატები; საპნები; პარფიუმერია, ეთერზეთები, კოსმეტიკური საშუალებები, თმის ლოსიონები; კბილის ფხვნილები და პასტები.

(111) M 2015 25662 R

(151) 2015 02 11

(181) 2025 02 11

(210) AM 78239

(220) 2014 08 07

(732) ლაბორატორიოს ლიომონტ ეს ეი დე სი მექსიკა, D.F. 05000, ადოლფო ლოპეზ მატეოს N68, კუაჰიმალპას ცენტრი, მექსიკა

(740) თამარ ხარაზიშვილი

(540)

Slender-1
სლენდერ-1
Слендер-1

(591) შავ-თეთრი

(531) 27.05.05-27.07.01-28.05.00-28.19.00-

(511)

5 – ფარმაცევტული პრეპარატი

(111) M 2015 25663 R

(151) 2015 02 12

(181) 2025 02 12

(210) AM 80359

(220) 2015 01 20

(732) შპს „სანა ფარმაცევტიკისი“
დიდმის მასივი, მე-5 კვ. კორპ. 15,
ავტოფარეხი, შენობა №2, 0159,
თბილისი, საქართველო

(540)

მოლისანი
MOLISAN
МОЛИСАН

(591) შავ-თეთრი

(531) 27.05.05-28.05.00-28.19.00-

(511)

3 – მათეთრებელი პრეპარატები და სხვა სარეცხი ნივთიერებები; წმენდის, გაპრიალების, გაუცხიმოვნებისა და აბრაზიული დამუშავების პრეპარატები; საპნები; პარფიუმერია, ეთერზეთები, კოსმეტიკური საშუალებები, თმის ლოსიონები; კბილის ფხვნილები და პასტები.

5 – ფარმაცევტული და ვეტერინარული პრეპარატები; სამედიცინო დანიშნულების ჰიგიენური პრეპარატები; სამედიცინო და ვეტერინარული დანიშნულების დიეტური საკვები და ნივთიერებები, ბავშვთა კვება; დიეტური დანამატები ადამიანებისა და ცხოველებისათვის; საღებუნები, სახვევი მასალა; კბილის დასაბუნნი და კბილის ტვიფრის დასამზადებელი მასალა; მადეზინფიცირებელი საშუალებები; მანეცხოველების გასანადგურებელი პრეპარატები; ფუნგიციდები, პერბიციდები.

35 – რეკლამა; მართვა საქმიან სფეროში; აღმინისტრირება საქმიან სფეროში; საოფისე მსახური.

(111) M 2015 25700 R

(151) 2015 02 19

(181) 2025 02 19

(210) AM 80508

(220) 2015 01 28

(732) შპს „ტიფლისიდისტილერი“
ნ. ჟვანიას ქ. 10, ოფისი №31, 0179,
თბილისი, საქართველო

(740) ხათუნა იმნაძე

(540)



(591) შავი, წითელი, ყვითელი, ცისფერი, ვერცხლისფერი, ოფსეტური ოქრო, ოქროს კილიტა, PANTONE 168C, PANTONE 187C, PANTONE 7402C

(531) 02.01.23-18.03.02-25.01.19-26.01.14-28.05.00-28.19.00-29.01.15-

(526) ნიშანი დაცულია მთლიანობაში. მასში შემავალი სიტყვები „კოლხეთი“, "КОЛХИДА" არ ექვემდებარება დამოუკიდებელ სამართლებრივ დაცვას.

(511)

33 – ალკოჰოლიანი სასმელები (ლუდის გარდა).

საერთაშორისო სასაქონლო ნიშნები, რომლებზეც ბამოტანილია გადაწყვეტილება დაცვის მინიჭების შესახებ

გადაწყვეტილების გასაჩივრება შესაძლებელია საქპატენტის სააპელაციო პალატაში გამოქვეყნებიდან 3 თვის ვადაში ან მცხეთის რაიონული სასამართლოს ადმინისტრაციულ საქმეთა კოლეგიაში 1 თვის ვადაში (მის.: ქალაქი მცხეთა, სამხედროს ქ. №17).

(260) AM 2015 73350 A*

(800) 1168012

(731) DENK PHARMA GmbH & Co. KG
Prinzregentenstr. 79, 81675 München,
Germany

(540)

DENK

(591) Black, white

(511)

5 – Pharmaceutical preparations and chemical preparations for medical purposes; healthcare preparations; dietetic preparations for medical purposes on the basis of vitamins, mineral nutrients, trace elements, proteins and carbohydrates; food supplements for medical and non-medical purposes.

30 – Dietetic preparations for non-medical purposes on the basis of vitamins, mineral nutrients, trace elements, proteins and carbohydrates.

35 – Wholesale and retail trade with pharmaceutical and chemical preparations used in industry, science, agriculture, horticulture and forestry, especially for use in the foodstuff, food supplement, pharmaceutical and cosmetics industries, artificial sweeteners, paints and dyes, plant extracts and plant oils for cosmetic purposes, chemical preparations for pharmaceutical and medical purposes, animal oils and plant oils as well as plant extracts for pharmaceutical and medical purposes, proteins for pharmaceutical and medical purposes, food supplements for pharmaceutical and medical purposes, minerals and vitamins.

(260) AM 2015 74142 A*

(800) 1175133

(731) SVENSKA CELLULOSA AKTIEBOLAGET
SCA
Box 200, SE-101 23 Stockholm, Sweden

(540)



(591) Green, dark blue, light blue

(511)

1 – Paper pulp; wood pulp; cellulose and chemical cellulose derivatives; acetic acid and unprocessed cellulose acetate; viscose; ethyl alcohol and methyl alcohol.

3 – Bleaching preparations; substances for laundry use; detergents; cleaning polishing, scouring and abrasive preparations; skin care products, namely washing creams, cleansing creams, moisturizers, skin lotions, barrier creams, zinc creams, hand-washing substances, soaps, cakes of soap; perfumery, essential oils; bath oils; shampoos and conditioners; hair gels; after-shave lotions; toothpaste; deodorants; disposable impregnated paper and cotton articles for cleaning, sanitary and cosmetic purposes; cotton wool; cotton sticks.

4 – Fuels; fuels from biological sources; wood heating pellets; renewable fuels; briquettes of wood; wind energy; electrical energy.

5 – Disposable paper and cotton articles impregnated with pharmaceutical lotions for cleaning and sanitary purposes; breast nursing pads; disposable diapers; diaper pants; liners; tampons; sanitary napkins (towels) and other absorbent articles for sanitary purposes; ointments for pharmaceutical purposes; diagnostic agents for pharmaceutical use; dietetic food and substances adapted for medical use; dietary supplements for humans; disposable diapers, diaper pants.

16 – Paper; products made of paper containing cellulose or not, for wiping, drying, cleaning and polishing; paper products for household, hygienic, sanitary and cosmetic purposes; paper and plastic sachets and bags; protective covers made of paper, protective covers made of paper with plastic back sheet, bibs, paper table cloths; printing products; printing paper, fine paper; writing paper, newsprint, paper for books, newspapers, catalogues, magazines and other printed matters.

19 – Nonmetallic building materials, including lumber.

21 – Stands, holders, containers and dispensers for paper, paper towels, liquid soap, air fresheners and other household, kitchen and toilet products, made of plastic, textile or metal; bins, bins for sanitary products, made of plastic or metal.

24 – Woven fabrics and textile goods not included in other classes; bed and table linen, woven, non-

woven or combined with paper; bed and table covers, undersheets.

35 – Business information services provided on-line from a computer database or the internet; distribution of samples; systematization of data in databases.

38 – Providing access to a compilation of information from computer databases matter in relation to health care, hygienic care and geriatric care; providing access to a global computer network for the transfer and dissemination of information.

39 – Transport; transportation logistics, including stevedoring; arrangement of transport including forwarding; transport services, including information and advice relating to customs clearance in relation to import and export; shipping services; packaging and storage of goods; warehouse storage services; energy distribution; fuel distribution services; delivery of fuel; arrangement of the storage of fuels; information and consultation of all aforementioned services.

41 – Education; education services relating to personal care, health care and geriatric care; arranging and conducting of educational seminars in relation to personal care, health care and geriatric care; provision of preserve facilities for hunting and fishing; arranging parties for hunting and fishing.

42 – Industrial analysis and research services in the field of the paper industry including paper pulp area, area of paper and cotton products for household, hygienic, sanitary and cosmetic purposes, forest industry and energy; provision of technical information relating to the manufacture of paper; design of stationery.

44 – Healthcare; consulting services relating to health; services for planning, organizing and monitoring for individualised healthcare, including such services provided online or via the internet; hygienic and beauty care for human beings; forestry services including management, administration, planning, manuring, losing the topsoil, planting, clearing and thinning.

(260) AM 2015 74829 A*
(800) 828824

(731) APPLUS SERVICIOS TECNOLÓGICOS, S.L.
Carretera de Acceso a la, Facultad de Medicina, S/N, Campus de la Uab-Bellaterra, E-08193 CERDANYOLA DEL VALLÈS (BARCELONA), Spain

(540)



(591) White, grey, orange

(511)

42 – Scientific and technological services, as well as research and design services relating thereto, industrial analysis and research services, software design and development, legal services.

(260) AM 2015 75185 A

(800) 1184480

(891) 2013 11 15

(731) PHILIP MORRIS PRODUCTS S.A.

Quai Jeanrenaud 3, CH-2000 Neuchâtel, Switzerland

(540)



(591) Black, white

(511)

34 – Tobacco, raw or manufactured; tobacco products, including cigars, cigarettes, cigarillos, tobacco for roll-your-own cigarettes, pipe tobacco, chewing tobacco, snuff tobacco, kretek; snus; tobacco substitutes (not for medical purposes); smokers' articles, including cigarette paper and tubes, cigarette filters, tobacco tins, cigarette cases and ashtrays, pipes, pocket apparatus for rolling cigarettes, lighters; matches.

(260) AM 2015 75363 A

(800) 1186072

(891) 2013 11 01

(731) OBSHCHESTVO S OGRANICHENNOI OTVETSTVENNOSTYU "INTEL"

Varshavskoye shosse, d. 75, korp. 1, Moscow, Russian Federation

(540)



(511)

33 – Alcoholic beverages (except beers).

(260) AM 2015 75396 A

(800) 1186270

(891) 2013 07 25

(731) CLAUDEL ROUSTANG GALAC

33 avenue du Maine -, Tour Maine Montparnasse, F-75015 Paris, France

(540)



(591) Dark blue, light blue, green, light green, blue and white

(511)

5 – Pharmaceuticals, veterinary products; dietetic substances, beverages and foodstuffs for medical

use; nutritional supplements for medical use; medicinal infusions, medicinal herbs, herb teas for medicinal purposes; foodstuffs and lacteal flour for babies, milk and milk products for babies.

29 – Meat, fish, poultry and game; meat extracts; charcuterie; crustaceans not live; preserved, dried, frozen and cooked fruit, mushrooms and vegetables; fruit pulp and fruit salads; vegetable salads; canned meat, fish, vegetables and fruit; jams, marmalades, compotes; jellies for food; gelatine for food; pollen prepared as foodstuff; weed extracts for food; soya beans preserved for food; protein for human consumption; bouillon, broths, soups; vegetable juices for cooking; eggs, milk, butter, cream (dairy products), yogurts, dairy desserts, dessert creams, drinking yogurts, cheese and other dairy products, dairy and cheese specialties, melted cheeses; milk beverages, milk predominating; soya milk; edible oils and fats; cooked dishes based on the aforesaid goods; non-alcoholic beverages containing milk.

30 – Coffee, tea, cocoa, chocolate; chocolate products; vegetable preparations for use as coffee substitutes; coffee substitutes; beverages made with coffee, tea, cocoa, chocolate; non-medicinal infusions; sugar, natural sweeteners; glucose for food; rice, tapioca, sago; pasta, semolina; flour and preparations made from cereals; dried cereal flakes; bread, pastry, cakes, brioches, pancakes, tarts, pies; soya flour; confectionery, sugar confectionery; popcorn; edible ices; honey; golden syrup, royal jelly for human consumption not for medical use; aniseed; star aniseed; malt extract for food; flavorings other than essential oils; aromatic preparations for food; yeast, baking-powder; cooking salt; mustard; vinegar, sauces (condiments), dressings for salad; tomato ketchup; mayonnaise; seasonings; thickening agents for cooking foodstuffs; weeds (condiments); spices; preserved garden herbs; ice for refreshment; sandwiches; pizzas; rice-based snacks; spring rolls; sushi, tabbouleh; tortillas; tacos; meat tenderizers for household purposes; cooked dishes based on the aforesaid goods.

32 – Beers, mineral and carbonated waters and other non-alcoholic beverages, particularly whey-based beverages; isotonic beverages; lemonades; fruit beverages and fruit juices; tomato juice; vegetable juices (beverages); syrups for beverages; preparations for making beverages (except tea-based, coffee-based, or cocoa-based, milk beverages); pastilles and powders for effervescing beverages; essences for making beverages; preparations for making liqueurs.

(260) AM 2015 75399 A

(800) 1186342

(891) 2013 10 03

(731) LEVGEN VALERIOVYCH BADA KH
vul. Tolstoho, 5A, kv. 44, m. Kyiv 01004,
Ukraine

(540)



(591) Black, white
(511)

35 – Administrative processing of purchase orders; advertising; advertising agencies; advertising by mail order; advisory services for business management; arranging newspaper subscriptions for others; arranging subscriptions to telecommunication services for others; auctioneering; auditing; bill-posting; book-keeping; business appraisals; business information; business inquiries; business investigations; business management and organization consultancy; business management assistance; business management consultancy; business management of hotels; business management of performing artists; business management of sports people; business organization consultancy; business research; commercial administration of the licensing of the goods and services of others; commercial information agencies; commercial information and advice for consumers [consumer advice shop]; commercial or industrial management assistance; compilation of information into computer databases; compilation of statistics; computerized file management; cost price analysis; data search in computer files for others; demonstration of goods; direct mail advertising; dissemination of advertising matter; distribution of samples; document reproduction; drawing up of statements of accounts; economic forecasting; efficiency experts; employment agencies; import-export agencies; invoicing; layout services for advertising purposes; marketing; marketing research; marketing studies; modelling for advertising or sales promotion; news clipping services; office machines and equipment rental; on-line advertising on a computer network; opinion polling; organization of exhibitions for commercial or advertising purposes; organization of fashion shows for promotional purposes; organization of trade fairs for commercial or advertising purposes; outsourcing services [business assistance]; payroll preparation; personnel management consultancy; personnel recruitment; photocopying services; presentation of goods on communication media, for retail purposes; price comparison services; procurement services for others [purchasing goods and services for other businesses]; production of advertising films; professional business consultancy; psychological testing for the selection of personnel; publication of publicity texts; publicity columns preparation; publicity material rental; public relations; radio advertising; relocation services for businesses; rental of advertising space; rental of advertising time on communication media; rental of photocopying machines; rental of vending machines; sales promotion for others; secretarial services; shop window dressing; shorthand; sponsorship search; systemization

of information into computer databases; tax preparation; telemarketing services; telephone answering for unavailable subscribers; television advertising; transcription; typing; updating of advertising material; word processing; writing of publicity texts.

(260) AM 2015 75407 A
 (800) 1186398
 (891) 2013 09 20
 (731) EGIS Gyógyszergyár Zrt.
 Keresztúri út 30-38, H-1106 Budapest,
 Hungary
 (540)

CURELLUS

(511)
 5 – Pharmaceutical preparations for human use.

(260) AM 2015 75513 A
 (800) 1187326
 (891) 2013 02 11
 (731) RUBUN GLOBAL CORP.
 33 Porter Road, P.O. Box 3169 PMB103 Road
 Town, Tortola, British Virgin Islands
 (540)



(591) Blue and white.
 (526) The trademark is protected as a whole. The words "natural choice" included therein shall not be subject to independent legal protection.

(511)
 3 – Bleaching preparations and other substances for laundry use; cleaning, polishing, scouring and abrasive preparations; soaps; perfumery, essential oils, cosmetics, hair lotions; dentifrices.

14 – Precious metals and their alloys and goods in precious metals or coated therewith, not included in other classes; jewellery, precious stones; horological and chronometric instruments.

16 – Paper, cardboard and goods made from these materials, not included in other classes; printed matter; bookbinding material; photographs; stationery; adhesives for stationery or household purposes; artists' materials; paint brushes; typewriters and office requisites (except furniture); instructional and teaching material (except apparatus); plastic materials for packaging (not included in other classes); printers' type; printing blocks.

18 – Leather and imitations of leather, and goods made of these materials and not included in other classes; animal skins, hides; trunks and travelling bags; umbrellas and parasols; walking sticks; whips, harness and saddlery.

(260) AM 2015 75560 A
 (800) 1187901
 (891) 2012 07 13
 (731) DAIKIN INDUSTRIES, LTD.
 Umeda Center Building, 4-12, Nakazaki-nishi
 2-chome, Kita-Ku, Osaka-shi, Osaka
 530-8323, Japan

(540)



(591) Black, light blue and blue.
 (511)

1 – Chemicals; adhesives (not for stationery or household purposes); plant growth regulating preparations; fertilizers; ceramic glazings; higher fatty acids; nonferrous metals; non-metallic minerals; photographic chemicals; photographic paper; sensitized photographic plates; reagent paper; artificial sweeteners; flour and starch for industrial purposes; unprocessed plastics (plastics in primary form); pulp; wallpaper removing preparations.

2 – Canada balsam; copal; sandarac; shellac; pine oil; dammar; mordants; mastic; pine gum; wood preservatives; dyestuffs; pigments; coatings (paints); printing ink; colors (for drawing pictures); anti-rust greases; nonferrous metals in foil or powder form for painters, decorators, printers and artists; precious metals in foil or powder form for painters, decorators, printers and artists.

7 – Metalworking machines and tools; mining machines and apparatus; construction machines and apparatus; loading-unloading machines and apparatus; net hauling machines [fishing]; chemical processing machines and apparatus; textile machines and apparatus; food or beverage processing machines and apparatus; lumbering, woodworking, or veneer or plywood making machines and apparatus; pulp making, papermaking or paper-working machines and apparatus; printing or bookbinding machines and apparatus; sewing machines; agricultural machines, agricultural implements other than hand-operated; shoe making machines; leather tanning machines; tobacco processing machines; glassware manufacturing machines and apparatus; painting machines and apparatus; packaging or wrapping machines and apparatus; potters' wheels; plastic processing machines and apparatus; semiconductor manufacturing machines and systems; machines and apparatus for manufacturing rubber goods; stone working machines and apparatus; non-electric prime movers (not for land vehicles) and parts thereof; pneumatic or hydraulic machines and instruments; adhesive tape dispensing machines; automatic stamping machines; dishwashers; machines and apparatus for wax-polis-

hing, electric; washing machines; vacuum cleaners; electric food blenders (for household purposes); mechanical parking systems; vehicle washing installations; power sprayers for disinfecting, insecticides and deodorants (not for agricultural purposes); machine elements (not for land vehicles); lawnmowers; curtain drawing devices electrically operated; waste compacting machines and apparatus; waste crushing machines; starters for motors and engines; AC motors and DC motors (not including those for land vehicles but including "parts" for any AC motors and DC motors); alternators; DC generators; dynamo brushes; arc welding machines; electric metal cutting machines (by arc, gas or plasma); electric welding apparatus (for metal working); vending machines; fuel dispensing pumps for service stations; electric door openers.

9 – Ear plugs for divers; optical glass; glass covered with an electrical conductor; ozonisers (ozonators); electrolyzers; egg-candlers; cash registers; coin counting or sorting machines; electric sign boards for displaying target figures, current outputs or the like; photo-copying machines; calculating machines; drawing apparatus and instruments adapted for use with computers; time and date stamping machines; time clocks (time recording devices); punched card office machines; voting machines; billing machine; postage stamp checking apparatus; mechanisms for coin-operated apparatus; life saving apparatus and equipment; fire extinguishers; fire hose nozzles; sprinkler systems for fire protection; fire alarms; gas alarms; anti-theft warning apparatus; protective helmets; railway signal apparatus, luminous or mechanical; vehicle breakdown warning triangles; luminous or mechanical road signs; divers' apparatus (not for sports); game programs for arcade video game machines; simulators for the steering and control of vehicles; laboratory apparatus and instruments; photographic machines and apparatus; cinematographic machines and apparatus; optical machines and apparatus; measuring or testing machines and instruments; power distribution or control machines and apparatus; rotary converters; phase modifiers; batteries and cells; electric or magnetic meters and testers; electric wires and cables; telecommunication machines and apparatus; electronic machines, apparatus and their parts; magnetic cores; resistance wires; fuel cell electrodes; gloves for protection against accidents; dust masks; gas masks; welding masks; fireproof garments; glasses; game programs for consumer games adopted for use with an external display screen or monitor; electronic circuits and CD-ROMs recorded with programs for hand-held games with liquid crystal displays; weight belts (for scuba diving); diving wet suits; protective helmets for sports; air tanks (for scuba diving); regulators for scuba diving; phonograph records; metronomes; electronic circuits and CD-ROMs recorded with automatic performance programs for electronic musical

instruments; slide-rules; exposed cinematographic films; exposed slide films; slide film mounts; recorded video discs and video tapes; electronic publications.

35 – Retail services or wholesale services for chemicals; retail services or wholesale services for unprocessed plastics; retail services or wholesale services for coatings (paints); retail services or wholesale services for hydraulic pump, hydraulic flow control valve, hydraulic pressure control valve, hydraulic directional control valve, hydraulic control valve, hydraulic motor, hydraulic cylinder, hydraulic transmission, hydraulic engine, hydraulic actuator; retail services or wholesale services for control apparatus for hydraulic pump, hydraulic flow control valve, hydraulic pressure control valve, hydraulic directional control valve, hydraulic control valve, hydraulic motor, hydraulic cylinder, hydraulic transmission, hydraulic engine, and hydraulic actuator; retail services or wholesale services for semiconductor manufacturing machines and systems; retail services or wholesale services for compressors; retail services or wholesale services for motors; retail services or wholesale services for telecommunication machines and apparatus; retail services or wholesale services for electronic machines, apparatus and their parts; retail services or wholesale services for computers; retail services or wholesale services for power distribution or control machines and apparatus; retail services or wholesale services for measuring or testing machines and instruments; retail services or wholesale services for medical apparatus and instruments; retail services or wholesale services for freezing machines and apparatus; retail services or wholesale services for air-conditioning apparatus; retail services or wholesale services for water heater; retail services or wholesale services for electrical machinery and apparatuses; retail services or wholesale services for rubber; retail services or wholesale services for plastic semi-worked products.

37 – Construction; construction consultancy; operation, check or maintenance of building equipment; shipbuilding; repair or maintenance of vessels; aircraft repair or maintenance; repair of bicycles; repair or maintenance of automobiles; repair or maintenance of railway rolling stocks; repair or maintenance of two-wheeled motor vehicles; repair or maintenance of cinematographic machines and apparatus; repair or maintenance of optical machines and apparatus; repair or maintenance of photographic machines and apparatus; repair or maintenance of loading-unloading machines and apparatus; repair or maintenance of fire alarms; repair or maintenance of office machines and equipment; repair or maintenance of air-conditioning apparatus (for industrial purposes); repair or maintenance of burners; repair or maintenance of boilers; repair or maintenance of pumps; repair or maintenance of freezing machines and ap-

paratus; repair or maintenance of electronic machines and apparatus; repair or maintenance of telecommunication machines and apparatus; repair or maintenance of construction machines and apparatus; repair or maintenance of consumer electric appliances; repair or maintenance of electric lighting apparatus; repair or maintenance of power distribution or control machines and apparatus; repair or maintenance of power generators; repair or maintenance of electric motors; repair or maintenance of laboratory apparatus and instruments; repair or maintenance of measuring and testing machines and instruments; repair or maintenance of medical apparatus and instruments; repair or maintenance of firearms; repair or maintenance of printing or bookbinding machines and apparatus; repair or maintenance of chemical processing machines and apparatus; repair or maintenance of glassware manufacturing machines and apparatus; repair or maintenance of fishing machines and instruments; repair or maintenance of metal working machines and tools; repair or maintenance of shoe making machines; repair or maintenance of industrial furnaces; repair or maintenance of mining machines and apparatus; repair or maintenance of rubber-goods manufacturing machines and apparatus; repair or maintenance of integrated circuits manufacturing machines and systems; repair or maintenance of semiconductor manufacturing machines and systems; repair or maintenance of machines and apparatus for processing foods or beverages; repair or maintenance of machines and apparatus for lumbering, woodworking, or veneer or plywood making; repair or maintenance of textile machines and apparatus; repair or maintenance of tobacco processing machines; repair or maintenance of painting machines and apparatus; repair or maintenance of agricultural machines and implements; repair or maintenance of machines and apparatus for pulp-making, papermaking or paper-working; repair or maintenance of plastic processing machines and apparatus; repair or maintenance of packaging or wrapping machines and apparatus; repair or maintenance of sewing machines; repair or maintenance of reservoirs; repair or maintenance of gasoline station equipment; repair or maintenance of mechanical parking systems; repair or maintenance of bicycle parking apparatus; repair or maintenance of industrial dishwashers; repair or maintenance of cooking equipment for industrial purposes; repair or maintenance of electric washing machines for industrial purposes; repair or maintenance of vehicle washing installations; repair or maintenance of vending machines; repair or maintenance of power-driven floor cleaning machines; repair or maintenance of amusement machines and apparatus; repair or maintenance of apparatus and instruments for use in beauty salons or barbers' shops; repair or maintenance of water pollution control equipment; repair or maintenance of water purifying apparatus; repair or maintenance of

waste compacting machines and apparatus; repair or maintenance of waste crushing machines; repair or maintenance of divers' apparatus; repair or maintenance of nuclear power plants; repair or maintenance of chemical plants; furniture restoration; umbrella repair; repair or maintenance of musical instruments; safe maintenance or repair; shoe repair; clock and watch repair or maintenance; sharpening of scissors and kitchen knives; setup or repair of locks; repair or maintenance of gas water heaters; repair or maintenance of non-electric cooking heaters; repair or maintenance of cooking pots and pans; repair or maintenance of signboards; repair of bags or pouches; repair of personal ornaments; repair of toys or dolls; repair of sports equipment; repair of billiard equipment; repair of game machines and apparatus; repair or maintenance of bath fittings; repair of toilet stool units with a washing water squirts; repair of fishing tackle; repair of spectacles; fur care and repair; laundering; pressing of clothing; clothing repair (mending clothing); fluffing of cotton batting for futon; repair of tatami mats; chimney sweeping; cleaning of building exterior surfaces; window cleaning; carpet and rug cleaning; floor polishing; septic tank cleaning; bathtub and bath boiler cleaning; street cleaning; reservoirs cleaning; disinfecting of telephone hand-sets; vermin exterminating (other than for agriculture, horticulture or forestry); sterilization of medical apparatus and instruments; rental of construction machines and apparatus; rental of floor cleaning machines; rental of mops; rental of car-washing apparatus; rental of electric washing machines; rental of laundry dryers; rental of spin dryers for clothes; rental of mining machines and apparatus.

42 – Meteorological information; architectural design; surveying; geological surveys; designing of machines, apparatus, instruments (including their parts) or systems composed of such machines, apparatus and instruments; designing; computer programming; technical advice relating to performance, operation, etc. of computers, automobiles and other machines that require high levels of personal knowledge, skill or experience of the operators to meet the required accuracy in operating them; testing, inspection or research of pharmaceuticals, cosmetics or foodstuff; research on building construction or city planning; testing or research on prevention of pollution; testing or research on electricity; testing or research on civil engineering; testing, inspection or research on agriculture, livestock breeding or fisheries; testing or research on machines, apparatus and instruments; rental of measuring apparatus; rental of computers; providing computer programs; rental of laboratory apparatus and instruments; rental of drawing instruments.

(260) AM 2015 75561 A
 (800) 1187916
 (891) 2013 05 14
 (731) Товариство з обмеженою відповідальністю "ТОРГОВИЙ ДІМ "ГАДІАХСІР-Україна"
 вул. Патриса Лумумби, б. 4/6, корп. "V",
 кімн. 1308 А, Київ, Печерський район 01042,
 Україна

(540)



(591) Yellow, red and brown

(511)

29 – Butter; butter cream; cheese; chocolate nut butter; cocoa butter; coconut butter; condensed milk; curd; kefir [milk beverage]; koumiss [kumiss] [milk beverage]; milk beverages, milk predominating; milk products; milk shakes; milk; peanut butter; rennet; whey.

(260) AM 2015 75564 A

(800) 1187985

(891) 2013 11 12

(731) CGP (WUHU) SEALING Co., Ltd.
 Anhui Xinwu Economic Development Zone,
 Wuhu County, Wuhu City, 241100 Anhui
 Province, China

(540)



(591) Black, white

(511)

7 – Universal joints; mechanical seals; engine bearings; engine nozzle; sealing joints [part of engines]; fan belts for motors and engines; pistons for cylinders; automobile oil pumps; automobile water-pumps; equipment for vehicle maintenance.

12 – Automobiles; auto mobile chassis; motors, electric, for land vehicles; clutches for land vehicles; engines for land vehicles; propulsion mechanisms for land vehicles; shock absorbers for automobile; transmission shafts for land vehicles; brake pads for automobiles.

(260) AM 2015 75566 A

(800) 1188038

(891) 2013 11 07

(731) Limited Liability Company
 "NEARMEDIC PHARMA"
 ul. Koroleva, 4, office 402, RU-249030
 Obninsk, Kaluzhskaya oblast, Russian
 Federation

(540)



(591) Red-brown

(511)

1 – Chemicals used in industry, science.

5 – Pharmaceutical and veterinary preparations.

42 – Scientific and technological services and research and design relating thereto.

44 – Medical services; veterinary services; hygienic and beauty care for human beings or animals.

(260) AM 2015 75575 A

(800) 1188085

(891) 2013 08 12

(731) POZA ZAKŁAD KRAWIECKI BOŻENA
 POZAUĆ

ul. Kuszniaków 7, PL-80-175 Gdańsk, Poland

(540)



(591) Yellow

(511)

18 – Attaché cases; trunks; backpacks; pocket wallets; purses; briefcases; bags; handbags; suitcases.

25 – Clothing; underwear; footwear; headgear.

35 – Sale of textiles and clothing.

(260) AM 2015 75577 A

(800) 1188142

(891) 2013 04 12

(731) Joint-Stock Company "ROT FRONT"
 2-oy Novokuznetskiy pereulok, d. 13/15,
 RU-115184 Moscow, Russian Federation

(540)

СОЛНЬШКО

(511)

30 – Confectionery made of sugar namely Turkish delight; Pastilles [confectionery]; marshmallow; chocolate spread; chocolate hazelnut spread; chocolate spread with milk; caramels; candy; sweets; chocolate; praline; waffles; pastries.

(260) AM 2015 75591 A

(800) 1188444

(891) 2013 08 02

(731) TERRA FOOD MANAGEMENT
COMPANY LIMITED
Esperidon, 12, 4th floor, CY-1087 Nicosia,
Cyprus

(540)



(591) Red, dark red, light red, white, black and green.

(511)

29 – Meat, fish, poultry and game; meat extracts; preserved, frozen, dried and cooked fruits and vegetables; jellies, jams, compotes; eggs; milk and milk products; edible oils and fats; bacon; albumen for culinary purposes; albumin milk; protein milk; yoghurt; kefir; cheese; sheep cheese; cream (dairy products); whipped cream; processed cheese, meat, milk and cultured milk products; milk jellies; fat-containing mixtures for bread slices; fat-containing mixtures for food; ready-to-serve packed milk, meat, and cheese meals; frozen fruits, berries, and vegetables; frozen fruit and berry mixes; frozen vegetable mixes; frozen and refrigerated semi-cooked meat products; candied fruits, berries, and nuts; condensed milk; caviar; cocoa butter; potato chips; potato flakes; kimchi (fermented vegetable dish); sour milk; fermented milk products; fermented milk beverages; curds; charcuterie; milk shakes; milk shakes with fruits; smoked meat foods; brisket meat; meat cutlets and chops; cutlets in dough; black pudding; kumys (milk beverage); margarine; marmalade; butter; oils; butter spreads; cream butter; sweet cream butter; salt butter; animal fats; melted butter; chocolate butter; butter cream; butter paste; long storage milk; non-perishable milk; baked milk; milk beverages, milk predominating; milk cream; milk cream with cocoa and hazelnuts; milk and curd desserts; milk snacks; fermented milk snacks; cheese snacks; meat foods, meals, and broths; meat mixes for sandwiches; meat pastes, preserves, snacks, salads; salted meat; dried meat; poultry and processed poultry products; processed seeds, including salted, fried seeds; liver; liver pastes; milk based products; cheese products containing milk; sour cream products containing milk; cheese products; cheese spread products; processed cheese paste products; hard cheese products; food products of meat and vegetables; prostokvasha (soured milk); ryazhenka (fermented baked milk); sausages; processed curds; cheese paste; cheese products; cheese mixes for sandwiches; whey; rennet; smetana (sour cream); sour cream products; soya milk (milk substitute); tofu; sausages in batter; pickles; dairy-based spreads for food; cream and vegetable mixes for food; milk soups; cheese

soups; dried milk; dried milk products; tripe; tomato puree; milk ferments for culinary purposes; fruit and berry compotes; potato chips; ham.

(260) AM 2015 75592 A

(800) 1188480

(891) 2013 09 11

(731) CORTEFIEL, S.A.

Avda. del Llano Castellano, 51, E-28034

MADRID, Spain

(540)

CTF

(591) Black, white

(511)

25 – Ready-to-wear clothing for men, women and children, footwear (except orthopedic footwear) and headgear.

(260) AM 2015 75608 A

(800) 789598

(891) 2013 11 04

(731) PROCORDIA FOOD AB

SE-241 81 ESLÖV, Sweden

(540)

FELIX

(511)

29 – Meat, fish, poultry and game; meat extracts; preserved, dried and cooked fruits and vegetables; jellies, jams, fruit sauces; eggs, milk and milk products; edible oils and fats; none of the aforementioned goods containing or consisting of snack food such as nuts, seeds, dried fruits or potato crisps or other snack food, included in the class.

30 – Coffee, tea, cocoa, sugar, rice, tapioca, sago, artificial coffee; flour and preparations made from cereals, bread, pastry and confectionery, ices; honey, treacle; yeast, baking-powder; salt, mustard; vinegar, sauces (condiments); dressing; spices; ice; none of the aforementioned goods containing or consisting of cereal based snack food.

(260) AM 2015 75610 A

(800) 1019099

(891) 2013 10 02

(731) RAUTARUUKKI OYJ

Suolakivenkatu 1, FI-00810 Helsinki, Finland

(540)

PUREX

(511)

2 – Paints, varnishes, lacquers; preservatives against rust and against deterioration of wood; colorants; mordants; raw natural resins; metals in foil and powder form for painters, decorators, printers and artists.

6 – Common metals and their alloys; metal building materials; transportable buildings of metal; materials of metal for railway tracks; non-electric cables and wires of common metal; ironmongery, small items of metal hardware; pipes and tubes of metal; safes; goods of common metal not included in other classes; ores.

40 – Treatment of materials.

(260) AM 2015 75648 A

(800) 1189158

(891) 2013 11 22

(731) COLUMBIA SPORTSWEAR COMPANY

14375 NW Science Park Drive, Portland,
Oregon 97229, USA

(540)



(526) The trademark is protected as a whole. The word "Columbia" included therein shall not be subject to independent legal protection.

(511)

8 – Sport knives, pocket knives, utility knives, multi-function hand tools comprised of any combination of the following: knives, screwdrivers, scissors, saws, cork screws, can openers, bottle openers, files, pliers, ratchets.

9 – Compasses.

11 – Flashlights.

21 – Portable coolers; thermal insulated containers for food or beverage; thermal insulated tote bags for food or beverage; thermal insulated bottles for beverages.

(260) AM 2015 75662 A

(800) 1189242

(891) 2012 11 13

(731) HATEX AS GmbH & Co.KG

Jakob-Kaiser-Strasse 12, 47877 Willich-
Münchheide, Germany

(540)

Elektronik Schäfer

(511)

7 – Bread cutting machines, grating machines for vegetables, coffee grinders, other than hand-operated, electric kitchen machines, electric knives, electric blenders for household purposes, mills for household purposes other than hand-operated, electric fruit presses for household purposes, electric vegetable presses for household purposes, pepper mills other than hand-operated, vacuum cleaners, vacuum cleaner bags; kitchen mixers (electric), grinders.

8 – Hand tools and implements (hand-operated) for household and kitchen purposes, especially knives,

forks, spoons, oyster openers, beard clippers, pruning shears, fiat irons, can openers, non-electric, egg slicers, ice scraper, manicure sets, table cutlery, hand implements for hair curling, pruning knives, pruning scissors, vegetable slicers, barbecue tongs, electric and non-electric depilation appliances, electric and non-electric hair clippers for personal use, cleavers, cheese slicers, nutcrackers, pedicure sets, pincers, non-electric pizza cutters, electric or non-electric shavers, razors, vegetable choppers, hand-operated atomizers for insecticides.

9 – Decorative magnets, scales, spirit levels, kitchen scales.

11 – Lighting, heating, steam generating, cooking, cooling, drying, ventilation apparatus; especially roasting apparatus; rotisseries; toaster; water heaters (apparatus); cooking utensils (electric); ventilation hoods; bed warmers; ice machines and apparatus; electric fans for personal use; electric kettles; filters (parts of household or industrial installations); electric deep fryers; foot warmers (electric or non-electric); hair dryers; halogen oven; hot air apparatus; water heaters; blankets electric (not for medical purposes); heating apparatus (electric); heating cushions pads (electric, not for medical purposes); hot air ovens; heating plates; heating radiators; induction ranges; induction cookers; cooking apparatus and installations; kilns; cooking rings; refrigerating containers; lamps (electric); lamp shades; light-emitting diodes [LED] lighting apparatus; filters for air conditioning; air cooling apparatus; air purifying apparatus; air dryers; microwave ovens (cooking apparatus); electric furnaces; electric cookers; pressure cooking saucepans (electric); stoves; immersion heaters; toilet seats; filters for drinking water; fans (air-conditioning); waffle irons (electric); hot plates; water heaters (apparatus); water intake apparatus; wok sets (electric).

14 – Electric clocks and watches, wall clocks, sundials, alarm clocks.

21 – Household or kitchen utensils and containers, especially cooking pot sets, casserole dishes, grills (cooking utensils), grill supports, heat-insulated containers, glassware, porcelain ware, earthenware, pans, cooking skewers (of metal), closures for pot lids, buckets, pails, electric brushes (except parts of machines), electric combs, glass incorporating fine electrical conductors, electric toothbrushes, boxes of glass, trouser presses, insulating flasks, heat-insulated containers, especially for beverages and food, ceramics for household purposes, cauldrons, cooking pots, cooking utensils (non-electric), cosmetic utensils, cake moulds, cooking pot sets, refrigerating bottles, isothermic bags, candelabra (candlesticks), mixers manual (cocktail shakers), blenders (non-electric) for household purposes, mills for domestic purposes (hand-operated), nail brushes, pepper mills (hand-operated), fitted picnic baskets including dis-

hes, beaters (non-electric), mixing spoons (kitchen utensils), salad bowls, salt cellars, whisks (non-electric) for household purposes, cutting boards for the kitchen, autoclaves (pressure cookers) (non-electric), sifters (household utensils), siphons for carbonated water, vessels of metal for making ices and iced drinks, soup bowls, trays for domestic purposes, tableware (other than knives, forks and spoons), cups, teapots, tea cosies, tea services (tableware), tea strainers, pastry cutters, rolling pins (domestic), table plates, pot lids, pots, oven gloves, oven cloths, pie servers, tart scoops, drinking vessels, drinking glasses, waffle irons (non-electric), kettles (non-electric), grinders for household purposes (non-electric); egg poachers, non-electric kitchen mixers.

(260) AM 2015 75671 A
 (800) 1189351
 (891) 2013 11 26
 (731) SMARTWARES SAFETY & LIGHTING B.V.
 Broekakkerweg 15, NL-5126 BD GILZE,
 Netherlands
 (540)

ELRO

(511)
 9 – Batteries and battery chargers; fire-extinguishing apparatus; electric cables and lines, and parts and fittings therefor, including connectors; telecommunications and security apparatus, namely house alarm installations and fittings therefor; scientific, surveying and electric apparatus and instruments, not included in other classes; optical, weighing, measuring, signalling, checking (supervision), life-saving and teaching apparatus and instruments; apparatus for recording, transmission or reproduction of sound or images; time switches.

11 – Apparatus for lighting, heating, ventilating and water supply purposes for household use, including parts and accessories, included in this class; taps for pipes, for household use.

(260) AM 2015 75677 A
 (800) 1189415
 (891) 2013 11 18
 (731) BEIERSDORF AG
 Unnastrasse 48, 20253 Hamburg, Germany
 (540)

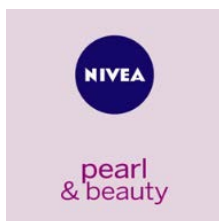

(591) Blue, white, purple and pink
 (511)
 3 – Cosmetics, deodorants and anti-perspirants for personal use.

(260) AM 2015 75681 A
 (800) 1189423
 (891) 2013 11 15
 (731) BEIERSDORF AG
 Unnastrasse 48, 20253 Hamburg, Germany
 (540)

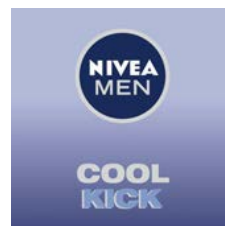

(591) Dark blue, white, silver, medium blue and light blue
 (511)
 3 – Cosmetics, deodorants and anti-perspirants for personal use.

(260) AM 2015 75687 A
 (800) 1095525
 (891) 2013 12 06
 (731) DEALGROVE LIMITED
 Themistokli Dervi, 3, Julia House, CY-1066
 Nicosia, Cyprus
 (540)



(591) White, black, light green, grey green, blue green
 (511)
 5 – Pharmaceutical and veterinary preparations, sanitary preparations for medical purposes; dietetic substances adapted for medical use; food for babies; plasters, materials for dressings; material for stopping teeth, dental wax, disinfectants, preparations for destroying vermin; fungicides, herbicides; acaricides, aconitine, alkaloids for medical purposes, algicides, aldehydes for pharmaceutical purposes, dental amalgams of gold, dental amalgams, amino acids for veterinary purposes, amino acids for medical purposes, antibiotics, aluminium acetate for pharmaceutical purposes, acetates for pharmaceutical purposes, germicides, balms for medical purposes, hygienic bandages, bandages for dressings, biocides, bracelets for medical purposes, anti-rheumatism bracelets, bromine for pharmaceutical purposes, paper for mustard plasters, fly catching paper, mothproofing paper, petroleum jelly for medical purposes, vaccines, oxygen baths, antiseptic cotton, absorbent cotton, cotton for medical purposes, radiological contrast substances for medical purposes, nutritive substances for microorganisms, radioactive substances for medical purposes, bismuth subnitrate for pharmaceutical purposes, melissa water for pharmaceutical purposes, sea water for medicinal bathing, mineral water for medicinal purposes, thermal water,

edible plant fibers [non-nutritive], molding wax for dentists, gases for pharmaceutical purposes, guaiacol for pharmaceutical purposes, haematogen, haemoglobin, hydrastine, hydrastinine, glycerine for medical purposes, glycerophosphates, glucose for medical purposes, gentian for pharmaceutical purposes, hormones for medical purposes, mustard for pharmaceutical purposes, mustard plasters, mud for baths, medicinal mud, gamboge for pharmaceutical purposes, gurjun [gurjon, gurjan] balsam for medical purposes, deodorants, other than for personal use, diastase for medical purposes, digitalin, additives to fodder for medical purposes, mineral food-supplements, nutritional additives for medical purposes, yeast for pharmaceutical purposes, gelatine for medical purposes, cod liver oil, isotopes for medical purposes, insecticides, iodine for pharmaceutical purposes, iodides for pharmaceutical purposes, alkaline iodides for pharmaceutical purposes, iodoform, calomel, cream of tartar for pharmaceutical purposes, tartar for pharmaceutical purposes, capsules for medicines, cachets for pharmaceutical purposes, candy for medical purposes, haemostatic pencils, wart pencils, caustic pencils, carbolineum [parasiticide], caustics for pharmaceutical purposes, cachou for pharmaceutical purposes, quassia for medical purposes, quebracho for medical purposes, gallic acid for pharmaceutical purposes, acids for pharmaceutical purposes, adhesives for dentures, adhesive bands for medical purposes, cocaine, collodion for pharmaceutical purposes, corn rings for the feet, anti-rheumatism rings, medicated candy, angostura bark for medical purposes, barks for pharmaceutical purposes, cedar wood for use as an insect repellent, condurango bark for medical purposes, croton bark, mangrove bark for pharmaceutical purposes, myrobalan bark for pharmaceutical purposes, cinchona for medical purposes, medicinal roots, rhubarb roots for pharmaceutical purposes, lint for medical purposes, starch for dietetic or pharmaceutical purposes, creosote for pharmaceutical purposes, blood for medical purposes, cultures of microorganisms for medical and veterinary use, curare, dental lacquer, liquorice for pharmaceutical purposes, lactose, adhesive plaster, medicines for alleviating constipation, lecithin for medical purposes, lotions for veterinary purposes, dog lotions, lotions for pharmaceutical purposes, lupulin for pharmaceutical purposes, magnesia for pharmaceutical purposes, liniments, ointments for pharmaceutical purposes, sunburn ointments, mercurial ointments, frostbite salve for pharmaceutical purposes, gauze for dressings, anti-horse-fly oils, medicinal oils, mustard oil for medical purposes, camphor oil for medical purposes, castor oil for medical purposes, oil of turpentine for pharmaceutical purposes, dill oil for medical purposes, dental mastics, dental abrasives, dental impression materials, teeth filling material, dressings [medical], surgical dressings, drugs for medical purposes, medicines for

veterinary purposes, serotherapeutic medicines, medicines for human purposes, medicines for dental purposes, menthol, medicinal drinks, moleskin for medical purposes, albuminous milk, milk of almonds for pharmaceutical purposes, royal jelly [for medical purposes], milk ferments for pharmaceutical purposes, irish moss for medical purposes, lacteal flour [for babies], flour for pharmaceutical purposes, linseed for pharmaceutical purposes, fishmeal for pharmaceutical purposes, fly catching adhesives, mint for pharmaceutical purposes, first-aid boxes [filled], dietetic beverages adapted for medical purposes, malted milk beverages for medical purposes, narcotics, medicinal infusions, tincture of iodine, eucalyptol for pharmaceutical purposes, tinctures for medical purposes, opium, opodeldoc, decoctions for pharmaceutical purposes, antiparasitic collars for animals, stick liquorice for pharmaceutical purposes, sulphur sticks [disinfectants], pants, absorbent, for incontinents, pectin for pharmaceutical purposes, napkins for incontinents, pepsins for pharmaceutical purposes, peptones for pharmaceutical purposes, hydrogen peroxide for medical purposes, pills for pharmaceutical purposes, leeches for medical purposes, blood plasma, plasters for medical purposes, eyepatches for medical purposes, poultices, compresses, scapulars for surgical purposes, bunion pads, breast-nursing pads, pomades for medical purposes, powder of cantharides, pyrethrum powder, belts for sanitary napkins [towels], anti-uric preparations, bacterial preparations for medical and veterinary use, bacteriological preparations for medical and veterinary use, balsamic preparations for medical purposes, albuminous preparations for medical purposes, biological preparations for veterinary purposes, biological preparations for medical purposes, veterinary preparations, bismuth preparations for pharmaceutical purposes, vitamin preparations, diagnostic preparations for medical purposes, therapeutic preparations for the bath, haemorrhoid preparations, preparations for callouses, preparations to facilitate teething, preparations for the treatment of burns, fumigation preparations for medical purposes, otopherapy preparations, air freshening preparations, air purifying preparations, bronchodilating preparations, sterilising preparations, soil-sterilizing preparations, corn remedies, pharmaceutical preparations for treating dandruff, preparations for destroying noxious animals, preparations for destroying dry rot fungus, larvae exterminating preparations, fly destroying preparations, preparations for destroying mice, slug exterminating preparations, vermin destroying preparations, pharmaceutical preparations for skin care, contact lens cleaning preparations, preparations of lime for pharmaceutical purposes, bath preparations, medicated, medicinal hair growth preparations, opiates, anticryptogamic preparations, preparations of trace elements for human and animal use, sulphonamides [medicines], sunburn preparations for phar-

maceutical purposes, enzyme preparations for veterinary purposes, enzyme preparations for medical purposes, chemico-pharmaceutical preparations, chemical preparations for veterinary purposes, chemical preparations for the diagnosis of pregnancy, chemical preparations for medical purposes, chemical preparations to treat wheat blight [smut], vine disease treating chemicals, chemical preparations to treat mildew, chemical preparations for treating phylloxera, chemical preparations for pharmaceutical purposes, chilblain preparations, mothproofing preparations, eye-wash, goulard water, chemical conductors for electrocardiograph electrodes, albuminous foodstuffs for medical purposes, dietetic foods adapted for medical purposes, by-products of the processing of cereals [for medical purposes], menstruation bandages, panty liners [sanitary], radium for medical purposes, hydrated chloral for pharmaceutical purposes, solvents for removing adhesive plasters, vaginal washes, solutions for use with contact lenses, chemical reagents for medical or veterinary purposes, gum for medical purposes, rubber for dental purposes, chewing gum for medical purposes, insect repellent incense, insect repellents, repellents for dogs, sanitary napkins, tissues impregnated with pharmaceutical lotions, sarsaparilla [for medical purposes], sugar for medical purposes, asthmatic tea, fumigating pastilles, suppositories, tobacco-free cigarettes for medical purposes, siccatives [drying agents] for medical purposes, syrups for pharmaceutical purposes, turpentine for pharmaceutical purposes, milking grease, greases for veterinary purposes, greases for medical purposes, saporifics, bicarbonate of soda for pharmaceutical purposes, salts for mineral water baths, bath salts for medical purposes, salts for medical purposes, potassium salts for medical purposes, sodium salts for medical purposes, smelling salts, mineral water salts, malt for pharmaceutical purposes, semen for artificial insemination, alcohol for pharmaceutical purposes, alloys of precious metals for dental purposes, ergots for pharmaceutical purposes, anaesthetics, antiseptics, analgesics, adjuvants for medical purposes, styptic preparations, anthelmintics, disinfectants for hygiene purposes, disinfectants for chemical toilets, appetite suppressants for medical purposes, medical preparations for slimming purposes, parasiticides, mouth-washes for medical purposes, febrifuges, depuratives, animal washes, detergents for medical purposes, cattle washes, dog washes, vesicants, articles for headache, remedies for perspiration, remedies for foot perspiration, chemical contraceptives, antiparasitic preparations, evacuants, tonics [medicines], nervines, digestives for pharmaceutical purposes, bouillons for bacteriological cultures, steroids, strychnine, serums, sal ammoniac lozenges, menstruations pads, vulnerary sponges, thymol for pharmaceutical purposes, surgical cloth [tissues], smoking herbs for medical purposes, medicinal herbs, sedatives, surgi-

cal implants [living tissues], sanitary knickers, charcoal for pharmaceutical purposes, fennel for medical purposes, porcelain for dental prostheses, phenol for pharmaceutical purposes, enzymes for veterinary purposes, enzymes for medical purposes, ferments for pharmaceutical purposes, formic aldehyde for pharmaceutical purposes, phosphates for pharmaceutical purposes, quinine for medical purposes, chinoline for medical purposes, diabetic bread, chloroform, flowers of sulphur for pharmaceutical purposes, cement for animal hooves, bone cement for surgical and orthopaedic purposes, dental cements, herbs teas for medical purposes, reducing tea for medical purposes, eucalyptus for pharmaceutical purposes, tobacco extracts [insecticides], extracts of hops for pharmaceutical purposes, elixirs [pharmaceutical preparations], ethers for pharmaceutical purposes, esters for pharmaceutical purposes, cellulose esters for pharmaceutical purposes, cellulose ethers for pharmaceutical purposes, jujube [medicated], rat poison, poisons, bacterial poisons, jalap.

10 – Surgical, medical, dental and veterinary apparatus and instruments; artificial limbs, eyes and teeth; orthopedic articles; suture materials; apparatus for use in medical analysis, blood testing apparatus, anaesthetic apparatus, galvanic therapeutic appliances, apparatus for artificial respiration, apparatus for the treatment of deafness, physical exercise apparatus, for medical purposes, dental apparatus, resuscitation apparatus, dental apparatus, electric, physiotherapy apparatus, bed vibrators, diagnostic apparatus for medical purposes, insufflators, traction apparatus for medical purposes, fumigation apparatus for medical purposes, radiotherapy apparatus, apparatus and installations for the production of X-rays, for medical purposes, radiological apparatus for medical purposes, hearing aids for the deaf, hearing protectors, hernia bandages, maternity belts, bandages, elastic, cupping glasses, dental burs, babies' bottles, hot air vibrators for medical purposes, vibromassage apparatus, gastroscopes, hematimeters, surgical sponges, defibrillators, dialyzers, clips [surgical], feeding bottle valves, mirrors for dentists, mirrors for surgeons, probes for medical purposes, urethral probes, acupuncture needles, suture needles, needles for medical purposes, orthopaedic articles, surgical implants [artificial materials], inhalers, injectors for medical purposes, incubators for medical purposes, incubators for babies, obstetric apparatus, obstetric apparatus for cattle, electric acupuncture instruments, cutlery [surgical], cannulae, droppers for medical purposes, dropper bottles for medical purposes, heart pacemakers, catheters, catgut, incontinence sheets, draw-sheets for sick beds, enema apparatus for medical purposes, artificial skin for surgical purposes, teething rings, compressors [surgical], thermo-electric compresses [surgery], corsets for medical purposes, abdominal corsets, crutches, dentists' armchairs, armchairs for medical or dental purposes, beds, spe-

cially made for medical purposes, lasers for medical purposes, lamps for medical purposes, quartz lamps for medical purposes, ultraviolet ray lamps for medical purposes, fleams, lenses [intraocular prostheses] for surgical implantation, spoons for administering medicine, masks for use by medical personnel, anaesthetic masks, childbirth mattresses, hydrostatic [water] beds for medical purposes, air mattresses, for medical purposes, furniture especially made for medical purposes, water bags for medical purposes, breast pumps, urinals [vessels], knee bandages, orthopedic, tips for crutches for invalids, finger guards for medical purposes, medical guidewires, pumps for medical purposes, thread, surgical, knives for surgical purposes, scissors for surgery, ambulance stretchers, stretchers, wheeled, boots for medical purposes, orthopaedic [orthopedic] footwear, clothing especially for operating rooms, blankets, electric, for medical purposes, supports for flat feet, ophthalmometers, ophthalmoscopes, gloves for massage, gloves for medical purposes, horsehair gloves for massage, pessaries, saws for surgical purposes, ear picks, spittoons for medical purposes, plaster bandages for orthopaedic purposes [casts (Am.)], supportive bandages, suspensory bandages, orthopaedic soles, abdominal pads, cushions for medical purposes, pads [pouches] for preventing pressure sores on patient bodies, air cushions for medical purposes, soporific pillows for insomnia, heating cushions, electric, for medical purposes, belts for medical purposes, abdominal belts, galvanic belts for medical purposes, orthopaedic [orthopedic] belts, umbilical belts, belts, electric, for medical purposes, condoms, aerosol dispensers for medical purposes, arterial blood pressure measuring apparatus, esthetic massage apparatus, massage apparatus, urological apparatus and instruments, orthodontic appliances, nursing appliances, brushes for cleaning body cavities, invalids' hoists, appliances for washing body cavities, corn knives, sterile sheets [surgical], surgical drapes, hair prostheses, artificial eyes, artificial breasts, sets of artificial teeth, artificial limbs, artificial jaws, ice bags for medical purposes, sprayers for medical purposes, bougies [surgery], X-ray photographs for medical purposes, respirators for artificial respiration, strait jackets, scalpels, tongue scrapers, babies' pacifiers [teats], feeding bottle teats, receptacles for applying medicines, spirometers [medical apparatus], vaginal syringes, contraceptives, non-chemical, stethoscopes, operating tables, commode chairs, bed pans, basins for medical purposes, cases fitted for use by surgeons and doctors, arch supports for boots and shoes, thermal packs for first aid purposes, thermometers for medical purposes, trocars, drainage tubes for medical purposes, X-ray tubes for medical purposes, radium tubes for medical purposes, ear trumpets, balling guns, protection devices against X-rays [Roentgen rays], for medical purposes, filters for ultraviolet rays, for medical pur-

poses, cases fitted for medical instruments, elastic stockings for surgical purposes, stockings for varices, splints, surgical, syringes for medical purposes, syringes for injections, hypodermic syringes, uterine syringes, urethral syringes, pins for artificial teeth, forceps, castrating pincers, radiology screens for medical purposes, electrodes for medical use, electrocardiographs.

42 – Chemical analysis, bacteriological research, biological research, cosmetic research; consultancy services relating to research in the field of environmental protection; quality control.

44 – Medical services, veterinary services; hygienic and beauty care for human beings or animals; pharmacy advice; hospitals, midwife services, veterinary assistance, dentistry, medical assistance, beauty salons, sanatoriums, blood bank services, health care, services of a psychologist, nursing, medical, physical therapy, chiropractics, plastic surgery.

(260) AM 2015 75689 A

(800) 1103348

(891) 2013 12 06

(731) DEALGROVE LIMITED

Themistokli Dervi, 3, Julia House, CY-1066
Nicosia

(540)



(591) White, black, light green, grey green, blue green

(511)

5 – Pharmaceutical and veterinary preparations, sanitary preparations for medical purposes; dietetic substances adapted for medical use; food for babies; plasters, materials for dressings; material for stopping teeth, dental wax, disinfectants, preparations for destroying vermin; fungicides, herbicides; acaricides, aconitine, alkaloids for medical purposes, algicides, aldehydes for pharmaceutical purposes, dental amalgams of gold, dental amalgams, amino acids for veterinary purposes, amino acids for medical purposes, antibiotics, aluminium acetate for pharmaceutical purposes, acetates for pharmaceutical purposes, germicides, balms for medical purposes, hygienic bandages, bandages for dressings, biocides, bracelets for medical purposes, anti-rheumatism bracelets, bromine for pharmaceutical purposes, paper for mustard plasters, fly catching paper, mothproofing paper, petroleum jelly for medical purposes, vaccines, oxygen baths, antiseptic cotton, absorbent cotton, cotton for medical purposes, radiological contrast substances for medical purposes, nutritive substances for microorganisms, radioactive substances for medical purposes, bismuth subnitrate for phar-

maceutical purposes, melissa water for pharmaceutical purposes, sea water for medicinal bathing, mineral water for medicinal purposes, thermal water, edible plant fibers [non-nutritive], molding wax for dentists, gases for pharmaceutical purposes, guaiacol for pharmaceutical purposes, haematogen, haemoglobin, hydrastine, hydrastinine, glycerine for medical purposes, glycerophosphates, glucose for medical purposes, gentian for pharmaceutical purposes, hormones for medical purposes, mustard for pharmaceutical purposes, mustard plasters, mud for baths, medicinal mud, gamboge for pharmaceutical purposes, gurjun [gurjon, gurjan] balsam for medical purposes, deodorants, other than for personal use, diastase for medical purposes, digitalin, additives to fodder for medical purposes, mineral food-supplements, nutritional additives for medical purposes, yeast for pharmaceutical purposes, gelatine for medical purposes, cod liver oil, isotopes for medical purposes, insecticides, iodine for pharmaceutical purposes, iodides for pharmaceutical purposes, alkaline iodides for pharmaceutical purposes, iodoform, calomel, cream of tartar for pharmaceutical purposes, tartar for pharmaceutical purposes, capsules for medicines, cachets for pharmaceutical purposes, candy for medical purposes, haemostatic pencils, wart pencils, caustic pencils, carbolineum [parasiticide], caustics for pharmaceutical purposes, cachou for pharmaceutical purposes, quassia for medical purposes, quebracho for medical purposes, gallic acid for pharmaceutical purposes, acids for pharmaceutical purposes, adhesives for dentures, adhesive bands for medical purposes, cocaine, collodion for pharmaceutical purposes, corn rings for the feet, anti-rheumatism rings, medicated candy, angostura bark for medical purposes, barks for pharmaceutical purposes, cedar wood for use as an insect repellent, condurango bark for medical purposes, croton bark, mangrove bark for pharmaceutical purposes, myrobalan bark for pharmaceutical purposes, cinchona for medical purposes, medicinal roots, rhubarb roots for pharmaceutical purposes, lint for medical purposes, starch for dietetic or pharmaceutical purposes, creosote for pharmaceutical purposes, blood for medical purposes, cultures of microorganisms for medical and veterinary use, curare, dental lacquer, liquorice for pharmaceutical purposes, lactose, adhesive plaster, medicines for alleviating constipation, lecithin for medical purposes, lotions for veterinary purposes, dog lotions, lotions for pharmaceutical purposes, lupulin for pharmaceutical purposes, magnesia for pharmaceutical purposes, liniments, ointments for pharmaceutical purposes, sunburn ointments, mercurial ointments, frostbite salve for pharmaceutical purposes, gauze for dressings, anti-horse-fly oils, medicinal oils, mustard oil for medical purposes, camphor oil for medical purposes, castor oil for medical purposes, oil of turpentine for pharmaceutical purposes, dill oil for medical purposes, dental mas-

tics, dental abrasives, dental impression materials, teeth filling material, dressings [medical], surgical dressings, drugs for medical purposes, medicines for veterinary purposes, serotherapeutic medicines, medicines for human purposes, medicines for dental purposes, menthol, medicinal drinks, moleskin for medical purposes, albuminous milk, milk of almonds for pharmaceutical purposes, royal jelly [for medical purposes], milk ferments for pharmaceutical purposes, irish moss for medical purposes, lacteal flour [for babies], flour for pharmaceutical purposes, linseed for pharmaceutical purposes, fishmeal for pharmaceutical purposes, fly catching adhesives, mint for pharmaceutical purposes, first-aid boxes [filled], dietetic beverages adapted for medical purposes, malted milk beverages for medical purposes, narcotics, medicinal infusions, tincture of iodine, eucalyptol for pharmaceutical purposes, tinctures for medical purposes, opium, opodeldoc, decoctions for pharmaceutical purposes, antiparasitic collars for animals, stick liquorice for pharmaceutical purposes, sulphur sticks [disinfectants], pants, absorbent, for incontinents, pectin for pharmaceutical purposes, napkins for incontinents, pepsins for pharmaceutical purposes, peptones for pharmaceutical purposes, hydrogen peroxide for medical purposes, pills for pharmaceutical purposes, leeches for medical purposes, blood plasma, plasters for medical purposes, eyepatches for medical purposes, poultices, compresses, scapulars for surgical purposes, bunion pads, breast-nursing pads, pomades for medical purposes, powder of cantharides, pyrethrum powder, belts for sanitary napkins [towels], anti-uric preparations, bacterial preparations for medical and veterinary use, bacteriological preparations for medical and veterinary use, balsamic preparations for medical purposes, albuminous preparations for medical purposes, biological preparations for veterinary purposes, biological preparations for medical purposes, veterinary preparations, bismuth preparations for pharmaceutical purposes, vitamin preparations, diagnostic preparations for medical purposes, therapeutic preparations for the bath, haemorrhoid preparations, preparations for callouses, preparations to facilitate teething, preparations for the treatment of burns, fumigation preparations for medical purposes, ophotherapy preparations, air freshening preparations, air purifying preparations, bronchodilating preparations, sterilising preparations, soil-sterilizing preparations, corn remedies, pharmaceutical preparations for treating dandruff, preparations for destroying noxious animals, preparations for destroying dry rot fungus, larvae exterminating preparations, fly destroying preparations, preparations for destroying mice, slug exterminating preparations, vermin destroying preparations, pharmaceutical preparations for skin care, contact lens cleaning preparations, preparations of lime for pharmaceutical purposes, bath preparations, medicated, medicinal hair growth pre-

parations, opiates, anticryptogamic preparations, preparations of trace elements for human and animal use, sulphonamides [medicines], sunburn preparations for pharmaceutical purposes, enzyme preparations for veterinary purposes, enzyme preparations for medical purposes, chemico-pharmaceutical preparations, chemical preparations for veterinary purposes, chemical preparations for the diagnosis of pregnancy, chemical preparations for medical purposes, chemical preparations to treat wheat blight [smut], vine disease treating chemicals, chemical preparations to treat mildew, chemical preparations for treating phylloxera, chemical preparations for pharmaceutical purposes, chilblain preparations, mothproofing preparations, eye-wash, goulard water, chemical conductors for electrocardiograph electrodes, albuminous foodstuffs for medical purposes, dietetic foods adapted for medical purposes, by-products of the processing of cereals [for medical purposes], menstruation bandages, panty liners [sanitary], radium for medical purposes, hydrated chloral for pharmaceutical purposes, solvents for removing adhesive plasters, vaginal washes, solutions for use with contact lenses, chemical reagents for medical or veterinary purposes, gum for medical purposes, rubber for dental purposes, chewing gum for medical purposes, insect repellent incense, insect repellents, repellents for dogs, sanitary napkins, tissues impregnated with pharmaceutical lotions, sarsaparilla [for medical purposes], sugar for medical purposes, asthmatic tea, fumigating pastilles, suppositories, tobacco-free cigarettes for medical purposes, siccatives [drying agents] for medical purposes, syrups for pharmaceutical purposes, turpentine for pharmaceutical purposes, milking grease, greases for veterinary purposes, greases for medical purposes, soporifics, bicarbonate of soda for pharmaceutical purposes, salts for mineral water baths, bath salts for medical purposes, salts for medical purposes, potassium salts for medical purposes, sodium salts for medical purposes, smelling salts, mineral water salts, malt for pharmaceutical purposes, semen for artificial insemination, alcohol for pharmaceutical purposes, alloys of precious metals for dental purposes, ergots for pharmaceutical purposes, anaesthetics, antiseptics, analgesics, adjuvants for medical purposes, styptic preparations, anthelmintics, disinfectants for hygiene purposes, disinfectants for chemical toilets, appetite suppressants for medical purposes, medical preparations for slimming purposes, parasiticides, mouthwashes for medical purposes, febrifuges, depuratives, animal washes, detergents for medical purposes, cattle washes, dog washes, vesicants, articles for headache, remedies for perspiration, remedies for foot perspiration, chemical contraceptives, antiparasitic preparations, evacuants, tonics [medicines], nervines, digestives for pharmaceutical purposes, bouillons for bacteriological cultures, steroids, strychnine, serums, sal am-

moniac lozenges, menstruations pads, vulnerary sponges, thymol for pharmaceutical purposes, surgical cloth [tissues], smoking herbs for medical purposes, medicinal herbs, sedatives, surgical implants [living tissues], sanitary knickers, charcoal for pharmaceutical purposes, fennel for medical purposes, porcelain for dental prostheses, phenol for pharmaceutical purposes, enzymes for veterinary purposes, enzymes for medical purposes, ferments for pharmaceutical purposes, formic aldehyde for pharmaceutical purposes, phosphates for pharmaceutical purposes, quinine for medical purposes, chinoline for medical purposes, diabetic bread, chloroform, flowers of sulphur for pharmaceutical purposes, cement for animal hooves, bone cement for surgical and orthopaedic purposes, dental cements, herbs teas for medical purposes, reducing tea for medical purposes, eucalyptus for pharmaceutical purposes, tobacco extracts [insecticides], extracts of hops for pharmaceutical purposes, elixirs [pharmaceutical preparations], ethers for pharmaceutical purposes, esters for pharmaceutical purposes, cellulose esters for pharmaceutical purposes, cellulose ethers for pharmaceutical purposes, jujube [medicated], rat poison, poisons, bacterial poisons, jalap.

10 – Surgical, medical, dental and veterinary apparatus and instruments; artificial limbs, eyes and teeth; orthopedic articles; suture materials; apparatus for use in medical analysis, blood testing apparatus, anaesthetic apparatus, galvanic therapeutic appliances, apparatus for artificial respiration, apparatus for the treatment of deafness, physical exercise apparatus, for medical purposes, dental apparatus, resuscitation apparatus, dental apparatus, electric, physiotherapy apparatus, bed vibrators, diagnostic apparatus for medical purposes, insufflators, traction apparatus for medical purposes, fumigation apparatus for medical purposes, radiotherapy apparatus, apparatus and installations for the production of X-rays, for medical purposes, radiological apparatus for medical purposes, hearing aids for the deaf, hearing protectors, hernia bandages, maternity belts, bandages, elastic, cupping glasses, dental burs, babies' bottles, hot air vibrators for medical purposes, vibromassage apparatus, gastroscopes, hematimeters, surgical sponges, defibrillators, dialyzers, clips [surgical], feeding bottle valves, mirrors for dentists, mirrors for surgeons, probes for medical purposes, urethral probes, acupuncture needles, suture needles, needles for medical purposes, orthopaedic articles, surgical implants [artificial materials], inhalers, injectors for medical purposes, incubators for medical purposes, incubators for babies, obstetric apparatus, obstetric apparatus for cattle, electric acupuncture instruments, cutlery [surgical], cannulae, droppers for medical purposes, dropper bottles for medical purposes, heart pacemakers, catheters, catgut, incontinence sheets, draw-sheets for sick beds, enema apparatus for medical purposes, artificial skin for surgical purposes,

teething rings, compressors [surgical], thermo-electric compresses [surgery], corsets for medical purposes, abdominal corsets, crutches, dentists' armchairs, armchairs for medical or dental purposes, beds, specially made for medical purposes, lasers for medical purposes, lamps for medical purposes, quartz lamps for medical purposes, ultraviolet ray lamps for medical purposes, fleams, lenses [intraocular prostheses] for surgical implantation, spoons for administering medicine, masks for use by medical personnel, anaesthetic masks, childbirth mattresses, hydrostatic [water] beds for medical purposes, air mattresses, for medical purposes, furniture especially made for medical purposes, water bags for medical purposes, breast pumps, urinals [vessels], knee bandages, orthopedic, tips for crutches for invalids, finger guards for medical purposes, medical guidewires, pumps for medical purposes, thread, surgical, knives for surgical purposes, scissors for surgery, ambulance stretchers, stretchers, wheeled, boots for medical purposes, orthopaedic [orthopedic] footwear, clothing especially for operating rooms, blankets, electric, for medical purposes, supports for flat feet, ophthalmometers, ophthalmoscopes, gloves for massage, gloves for medical purposes, horsehair gloves for massage, pessaries, saws for surgical purposes, ear picks, spittoons for medical purposes, plaster bandages for orthopaedic purposes [casts (Am.)], supportive bandages, suspensory bandages, orthopaedic soles, abdominal pads, cushions for medical purposes, pads [pouches] for preventing pressure sores on patient bodies, air cushions for medical purposes, soporific pillows for insomnia, heating cushions, electric, for medical purposes, belts for medical purposes, abdominal belts, galvanic belts for medical purposes, orthopaedic [orthopedic] belts, umbilical belts, belts, electric, for medical purposes, condoms, aerosol dispensers for medical purposes, arterial blood pressure measuring apparatus, esthetic massage apparatus, massage apparatus, urological apparatus and instruments, orthodontic appliances, nursing appliances, brushes for cleaning body cavities, invalids' hoists, appliances for washing body cavities, corn knives, sterile sheets [surgical], surgical drapes, hair prostheses, artificial eyes, artificial breasts, sets of artificial teeth, artificial limbs, artificial jaws, ice bags for medical purposes, sprayers for medical purposes, bougies [surgery], X-ray photographs for medical purposes, respirators for artificial respiration, strait jackets, scalpels, tongue scrapers, babies' pacifiers [teats], feeding bottle teats, receptacles for applying medicines, spirometers [medical apparatus], vaginal syringes, contraceptives, non-chemical, stethoscopes, operating tables, commode chairs, bed pans, basins for medical purposes, cases fitted for use by surgeons and doctors, arch supports for boots and shoes, thermal packs for first aid purposes, thermometers for medical purposes, trocars, drainage tubes for medical purposes, X-ray tubes for

medical purposes, radium tubes for medical purposes, ear trumpets, balling guns, protection devices against X-rays [Roentgen rays], for medical purposes, filters for ultraviolet rays, for medical purposes, cases fitted for medical instruments, elastic stockings for surgical purposes, stockings for varices, splints, surgical, syringes for medical purposes, syringes for injections, hypodermic syringes, uterine syringes, urethral syringes, pins for artificial teeth, forceps, castrating pincers, radiology screens for medical purposes, electrodes for medical use, electrocardiographs.

42 – Chemical analysis, bacteriological research, biological research, cosmetic research; consultancy services relating to research in the field of environmental protection; quality control.

44 – Medical services, veterinary services; hygienic and beauty care for human beings or animals; pharmacy advice; hospitals, midwife services, veterinary assistance, dentistry, medical assistance, beauty salons, sanatoriums, blood bank services, health care, services of a psychologist, nursing, medical, physical therapy, chiropractics, plastic surgery.

(260) AM 2015 75691 A

(800) 1185040

(891) 2013 12 11

(731) HIPP & CO

Brünigstr. 141, CH-6072 Sachseln, Switzerland

(540)



(591) Pink, white, green and blue

(511)

3 – Body and beauty care products for babies, infants, toddlers and children, in particular essential oils, paper and textile tissues impregnated with oils, lotions and/or chemical preparations for general hygienic and body-care purposes, oils, lotions, creams, powders, soaps, skincare tissues impregnated with cosmetic lotions, bath preparations, shampoos, sunscreens; dentifrices, in particular tooth pastes; cotton sticks for cosmetic purposes; soaps and shampoo for medical purposes, in particular for babies and toddlers.

5 – Protein preparations derived from vegetable and animal products for medical purposes, for human consumption; pharmaceutical preparations; dietetic substances for children and invalids, adapted for

medical use; food for babies; lotions, creams, powder and bath preparations, for medical purposes and in particular intended for babies and toddlers; breast-nursing pads.

8 – Cutlery, in particular weaning cutlery and children's cutlery; nail scissors for babies.

9 – Bath thermometers, not for medical purposes; mouse pads; coded telephone cards and phone cards; sound carriers, in particular cds and cassettes.

10 – Baby bottles and drinking bottles for babies, baby-bottle teats, pacifiers and pacifier chains; teething ring; nasal aspirators; bath thermometers for medical purposes; heat-retaining cushions for medical purposes; feeding cups.

21 – Plates not of precious metal, in particular warming plates; heaters for feeding bottles, non-electric; bottle holders, bottle and teat brushes; brush sets; combs; toothbrushes; hairbrushes; drinking glasses; vases (not of precious metal); coffee cups (not of precious metal).

24 – Textile bath towels, washing mitts, washcloths; pre-moistened flannels of nonwoven material; bed linen, in particular for babies, infants and children; crawling blankets; textile towels; mosquito nets; diaper changing pads not of paper (included in this class).

25 – Clothing, in particular for infants, toddlers and children, in particular t-shirts, bodysuits and romper suits; baby bibs; headgear, in particular caps; rainproof ponchos; footwear, in particular gym shoes.

44 – Nutritional consultancy with regard to babies, infants, toddlers and children, consultancy with regard to baby, infant, toddler and child care.

(260) AM 2015 75710 A

(800) 1189771

(891) 2013 03 14

(731) HAHN + KOLB Werkzeuge GmbH

Schlieffenstraße 40 71636 Ludwigsburg,

Germany

(540)

ORION

(511)

6 – Screws of metal; nuts of metal; shims of metal; washers of metal; mouldings of metal for use in building; mouldings of metal; tool chests of metal, empty.

7 – Machines and machine tools; marking changeable holders, angle plates, shell end mill arbours, drill drifts, axial holders, drills, drill bits, drill holders, drill chucks, vices for drilling machines, drill grooving cutters, boring bar holders, branding pencils, diamond cup wheels, diamond grinding pencils, work arbours, lathe chucks, rotatable blades,

lathe chisels, right-angle milling heads, insertion prisms, insert sheaths, single-tooth milling tools, countersinks, flap wheels, planar chucks, spot face cutters, cutter arbours, milling cutters, milling chucks, taps, tap holders, tapping chucks, gravers, bushings, edge finders, collar reamers, tapered mandrels, conical progressive boring drills, countersinks, lever scroll chucks, circular saw blades, spherical cutters, dimension adjusting sets, long-hole milling cutters, magnetic grippers, chucking reamers, sawing machine blades, multi-step drills, step drills, revolving live lathe centres, assembly blocks, multipurpose drilling tools, bridge reamers, zero-setting apparatus, oil expellers, parallel rests, facing cutters and formed cutters, face milling heads, double equal-angle milling cutters, transverse groove shell end mills, radial holders, radius cutters, reducing bushes, cleaning nozzles, rings; cutter arbours, pipe deburrers, lathe carriers for cylindrical grinders, saw blade holders, shell end mills, peeling graters, side milling cutters, grinding arbours, abrasive flap discs, abrasive discs, slot cutters, quick-release insets, styluses, roughing discs, vertical quick-release clamps, locking washers, marking felt, clamping nuts, collet chucks, draw-in collet chucks, twist drills, tool holders, cutting tool holders, stone drills, frontal graters, cup wheels, cut-off wheels, extension sheaths, shell end mills, changeable holders, indexable cutter inserts, workpiece stops, angle plates, single-angle milling cutters, wipers, vertical collet vice clamps, centre drills, live lathe centres; all the aforesaid goods being machines or parts of machines; pressure sprayers as part of compressors.

8 – Hand tools and implements (hand-operated); strippers, dressing stones, blind-riveting tongs, letter stamps, punches for rivets, barrel pumps, sledge hammers, spring balances, files, file cards, filing vices, grease guns, snipe nose pliers, thread rolling dies, thread rolls, hand dressers, hand-held deburrers, hand lappers, hand reamers, hand stamps, lever-shift reversible ratchets, mallets, cable stripping knives, universal pliers, compact markers, centre punches, ball-type tap wrenches, scrabbling picks, magnetic hoists, chisels, cutting edges, parallel vices, ratchet toolkits, vice jaws, marking tools, pipe cutters, pipe shears, pipe jaws, saw bows, shears, engineers' cross peen hammers, dies, die holders, soft-face hammers, screw drivers, spanners, chipping hammers, side nippers, pin punches, socket spanners, dividing caulkers, water pump pliers, tool holders, toolboxes containing hand tools, tap wrenches, all the aforesaid goods being hand-operated hand tools; numbering stamps (hand-operated tool other than for stationery and for household purposes).

14 – Stopwatches.

18 – Tool bags of leather, empty.

21 – Sprayers (sprayers bottles); brushes, filing brushes, hand brushes, spark plug brushes; dustpans.

(260) AM 2015 75717 A
 (800) 1189877
 (891) 2013 12 11
 (731) AVON PRODUCTS, INC.
 World Headquarters, 777 Third Avenue, New
 York NY 10017, USA
 (540)

PARISIAN CHIC

(511)
 3 – Non-medicated toilet preparations; toiletries; skin care preparations; skin moisturizers; body and beauty care preparations; powders, creams and lotions, all for the face, hands and body; cosmetic suntan preparations; soaps; shower and bath preparations; beauty masks; talcum powder; nail polish; nail polish remover; enamel for nails; false nails; adhesives for cosmetic purposes; cosmetics; eye makeup remover, eye shadow, eye liner, mascara, lipstick, lip liner, lip gloss; make-up foundation; blusher; tissues impregnated with cosmetic lotions; cotton sticks for cosmetic purposes; cotton wool for cosmetic purposes; preparations for cleaning, moisturising, colouring and styling the hair; preparations for cleaning the teeth; shaving and aftershave preparations; perfumes, fragrances, toilet waters, cologne; deodorants for human beings; anti-perspirants for personal use (toiletries); essential oils (cosmetic).

(260) AM 2015 75718 A
 (800) 1189881
 (891) 2013 04 16
 (731) WORLD MEDICINE İLAÇLARI LİMİTED
 ŞİRKETİ
 Evren Mah., Camiyolu Cad. No:50 K.2,
 GÜNEŞLİ/BAĞCILAR/İSTANBUL, Turkey
 (540)



Health is a treasure we share.

Здоровье – богатство, которым мы делимся с вами.

Sağlık- sizin ile paylaştığımız bir hazinedir.

(591) Blue, white
 (511)

3 – Bleaching and cleaning preparations, perfumes, cosmetics; deodorants for human beings or for animals; soaps; dentifrices; abrasive preparations including abrasive cloth and paper, pumice stones, and pastes for razor strops; polishing preparations for leather, vinyl, metal, timber.

10 – Surgical, medical, dental and veterinary apparatus and instruments; artificial organs and prostheses; medical orthopaedic materials; suture materials and sterilized covers; devices and equipments for sexual purposes; preservatives (condom); feeding bottles, feeding bottle teats, teats, teethers for babies.

29 – Meat, fish, meat of poultry and game and all kinds of processed meat products; dried beans;

ready-made soups, bouillons; olives, olive paste; milk and milk products including butter; edible vegetable oils; dried, preserved, frozen, cooked, smoked, pickled fruits and vegetables including pollens produced as food; roasted nuts; puree of hazelnut and peanut, tahin namely crushed sesame seeds; eggs, powdered eggs; potato crisps.

36 – Insurance services, financial and monetary services, real estate brokerage, consultancy and management services, custom brokerage services.

39 – Land, air and sea transport services, land, air and sea transports renting services including tour organisation services, booking for travel services, courier services; car parking and garage rental services; boat sheltering services; pipeline transport services; electricity distribution services; water supply services; vehicle and good rescue services; storage, packaging and crating of goods; garbage storage and transport services, waste collection and transport services.

(260) AM 2015 75722 A
 (800) 1189910
 (891) 2013 12 03
 (731) MANICA S.p.A.
 Via all'Adige, 4, I-38068 ROVERETO
 (TRENTO), Italy
 (540)

manica

(591) Black, white
 (511)

1 – Chemicals used in industry, science, as well as in agriculture, horticulture and forestry; manures for land and agriculture; vitriol; growing media hydroponics in agriculture.

5 – Pharmaceutical, veterinary and sanitary preparations for medical purposes; disinfectants, preparations for destroying vermin, fungicides, herbicides.

(260) AM 2015 75723 A
 (800) 1189948
 (891) 2013 08 29
 (731) GUCCIO GUCCI S.P.A.
 Via Tornabuoni, 73/R, I-50123 FIRENZE,
 Italy
 (540)

LADY LOCK

(511)
 18 – Bags, handbags, shoulder bags, luggage, leather document briefcases, wallets, purses, leather key cases, leather backpacks.

(260) AM 2015 75724 A
 (800) 1189989
 (891) 2013 11 22
 (731) OPERA GALLERY SERVICES SA
 5, rue Guillaume Kroll, L-1882 Luxembourg,
 Luxembourg
 (540)

OPERA GALLERY

(526) The trademark is protected as a whole. The word "GALLERY" included therein shall not be subject to independent legal protection.

(511)

35 – Sale of works of art; purchase of works of art on behalf of others; auctioneering; intermediary services in the field of trade in works of art, including the purchase and sale of works of art; presentation of works of art for promotional purposes; administrative management of exhibition sites, forums, colloquiums, conferences, fairs and/or seminars; organization and conducting of conferences, forums, colloquiums, seminars, shows or exhibitions, whether professional or otherwise, for commercial or advertising purposes; promotion of exhibitions, conferences, forums, colloquiums, seminars and/or shows; business management of performing artists; agencies for artists; editing and publishing of commercial or advertising texts; subscriptions to publications and databases (for others); subscription to exhibitions, conferences, forums, colloquiums, seminars and/or shows; bill-posting, advertising and commercial sponsorship; advertising; advertising and promotion for artists; public relations; activities by professional clubs for commercial or advertising purposes; organization of commercial or advertising competitions; rental of advertising space; rental of advertising time on all kinds of communication media; compilation of information into computer databases; document reproduction; computer file management, administrative management of databases; compilation and systematization of information with a view to the integration thereof into computer databases; data search in computer files for others; business management; business administration; public relations; marketing studies, opinion polling; marketing; business management and organization consultancy; business inquiries; business management assistance; office functions; news clipping services.

36 – Financial appraisal of works of art; brokerage of works of art; fund and property collection, financial support (sponsoring, loans, donations, stock exchange); financial affairs, insurance.

41 – Art gallery services (cultural activities); cultural activities; museum services (presentation, exhibition); presentation of works of art for cultural or educational purposes; organization and conducting of conferences, forums, colloquiums, seminars, shows or exhibitions whether professional or other-

wise, for cultural or educational purposes; organization of competitions, games, information campaigns and events, professional or otherwise, for cultural or educational purposes; cultural information service; club services (entertainment, education, cultural affairs); education, training, entertainment; sporting activities; information on entertainment, education and training; news reporter services; photography services; provision, rental and lending of works of art; rental and lending of musical and/or audiovisual works; publishing of texts, books, magazines, newspapers, periodicals, magazines, bulletins, catalogs and other information media (other than advertising texts) on any media; media library and library services, box office services; booking of seats for exhibitions, conferences, forums, colloquiums, seminars and trade fairs; production of films, television or radio programs; production and copying of audiovisual works on all media for broadcast on all network types; film, radio and television entertainment.

42 – Authentication of works of art; styling; studies, advice, consultancy and information on design and graphic arts; research and development of new products for others; graphic art services; graphic design.

(260) AM 2015 75725 A
 (800) 1189998
 (891) 2013 11 05
 (731) SAFE IP S.A.,
 11, Avenue Emile Reuter, L-2420
 LUXEMBOURG, Luxembourg
 (540)



(591) Gray, blue and white

(526) The trademark is protected as a whole. The word "Metal" included therein shall not be subject to independent legal protection.

(511)

6 – Unwrought or semi-wrought steel; steel alloys; cast steel; steel buildings; frames of metal (for building); cotter pins of metal; cast iron, unwrought or semi-wrought; common or or semi-wrought metals; alloys of common metals; metal trays; guard rails of metal for roads; cable grips of metal; wear parts and spare parts of metal namely shields.

12 – Couplings for land vehicles; shock absorbing springs for vehicles; railway or railway car couplings; crankcases for land vehicle components other than for engines; buffers (railway rolling stock); brake rotors for vehicles; axle journals; brake shoes for vehicles; brake segments for vehicles; trailer hitches for vehicles; hubs for vehicle wheels; freewheels for land vehicles; rims for vehicle wheels;

suspension springs for vehicles; transmission shafts for land vehicles; vehicle wheels; vehicle chassis; treads for vehicles [tractor type]; connecting rods for land vehicles other than parts of motors and engines.

(260) AM 2015 75726 A

(800) 1190004

(891) 2013 11 15

(731) Zakrytoe aktsionerное obshchestvo
"EVROCEMENT GRUP"
Malyj Golovin per., 3, str.1, RU-107045
Moskva, Russian Federation

(540)



(591) White, orange, gray and taupe

(511)

19 – Cement.

(260) AM 2015 75727 A

(800) 1190014

(891) 2013 11 08

(731) Zakrytoe aktsionerное obshchestvo
"Akademiya Nauchnoy Krasoty"
ul. Pokrovka, 14/2, stroenie 1, RU-101000
Moscow, Russian Federation

(540)



(591) Pink and gray

(511)

3 – Soap; perfumery; cosmetics; hair lotions; after-shave lotions; beauty masks; cosmetic creams; oils for cosmetic purposes; oils for toilet purposes; perfumes; cosmetic preparations for baths; bath salts, not for medical purposes; cosmetic preparations for skin care; cosmetic preparations for slimming purposes; shampoos; dental bleaching gels; dentifrices; denture polishes; mouth washes, not for medical purposes; preparations for cleaning dentures.

5 – Dietetic substances adapted for medical use; sea water for medicinal bathing; thermal water; mud for baths; medicinal mud; ointments for pharmaceutical purposes; medicinal oils; mineral food supplements; nutritional supplements; wart pencils; vitamin preparations; chemico-pharmaceutical preparations; chemical preparations for pharmaceutical purposes; pharmaceutical preparations; disinfectants for hygiene purposes; medicinal herbs; dental cements;

porcelain for dental prostheses; dental lacquer; dental mastics; dental abrasives; dental impression materials; teeth filling material; medicines for dental purposes; mouthwashes for medical purposes; adhesives for dentures.

35 – Advertising; sales promotion for others; marketing studies; distribution of samples; dissemination of advertising matter; on-line advertising on a computer network; television advertising.

41 – Videotaping; microfilming; videotape editing.

42 – Bacteriological research; biological research; cosmetic research; research and development of new products for others.

44 – Medical services; manicuring; massage; medical clinic services; hairdressing salons; beauty salons; tattooing; sauna services; solarium services; physical therapy; dentistry; plastic surgery.

(260) AM 2015 75728 A

(800) 1190022

(891) 2013 05 02

(731) L'OREAL (Société Anonyme)
14, rue Royale, F-75008 Paris, France

(540)



(591) Black, white

(511)

3 – Perfumed soaps; perfumery; perfumes; eau de toilette; eau de Cologne; perfumed shower and bath gels; perfumed shower and bath salts; deodorants for personal use; non-medicated skincare preparations; cosmetics, in particular creams, milks, lotions, gels and powders for the face, body, hair and hands; non-medicated sun care preparations; suntanning preparations; suncreening preparations; make-up preparations; hair care preparations; shampoos; hair styling preparations; hair-colouring preparations; essential oils for personal use.

8 – Eyelash curlers; tweezers; nail files.

18 – Vanity cases sold empty; toiletry cases sold empty; toiletry bags; beauty cases [not fitted]; make-up cases; make-up bags.

21 – Fitted toiletry cases; powder compacts [cases]; cases adapted for cosmetic utensils; nail brushes; eyebrow brushes; cosmetic brushes; make-up brushes; skin cleansing brushes; mascara brushes; eyelash combs; combs and sponges for cosmetic use.

(260) AM 2015 75729 A

(800) 1190060

(891) 2013 08 08

(731) YANTAI JEREH OILFIELD SERVICES GROUP CO., LTD.
No:7 Aucma Street, Laishan District, Yantai, 264003 Shandong Province, China

(540)

Jereh

(591) Black, white

(511)

7 – Machinery and equipment for industrial oil, petroleum refining; petroleum chemical and industrial equipment; mineworking machines; diesel engines; gas liquefaction equipment (nitrogen liquefaction equipment, hydrogen liquefaction equipment, helium liquefaction equipment); pumps (parts of machines, engines or motors); gasoline splitters; engines, other than for land vehicles; slurry pumps for petroleum; machinery and equipment used in geological exploration, mining and dressing.

12 – Automobiles; trucks; trailers (vehicles); fracturing trucks; cementing trucks; fracturing manifold trucks; bulk trucks; data vans; sand blenders; coiled tubing trucks.

37 – Rebuilding engines that have been worn or partially destroyed; rebuilding machines that have been worn or partially destroyed; machinery installation, maintenance and repair; motor vehicle maintenance and repair; vehicle maintenance; mining; freezing equipment installation and repair; burglar alarm installation and repair; airplane maintenance and repair; painting services.

(260) AM 2015 75730 A

(800) 1190085

(891) 2013 10 10

(731) MEDİPOLİTAN SAĞLIK VE EĞİTİM HİZMETLERİ A.Ş.

Lambacı Sokak No:2/1-2, Koşuyolu, KADIKÖY - İSTANBUL, Turkey

(540)

Medicana

(511)

44 – Medical services.

(260) AM 2015 75731 A

(800) 1190092

(891) 2013 10 28

(731) PRYVATNE AKTSIONERNE TOVARYSTVO "EDEM"

vul. Dachna, 24, m. Pidgorodne, Dnipropetrovskiyi r-n, Dnipropetrovska obl. 52001, Ukraine

(540)

STATUS

(591) Grey, white

(511)

27 – Tapestry [wall hangings] not of textile; wall-paper.

(260) AM 2015 75732 A

(800) 1190094

(891) 2013 11 22

(731) FARMA GRS, farmacevtsko gospodarsko razvojno sredisce, d.o.o.
Seidlova cesta 70, SI-8000 Novo mesto, Slovenia

(540)

ACTIVE&STABLE

(511)

5 – Pharmaceutical and veterinary preparations.

(260) AM 2015 75733 A

(800) 1190122

(891) 2013 12 13

(731) VISOTSKY CONSULTING INC
#4300, 1271 Avenue Of The Americas, New York City NY 10020, USA

(540)



(591) Black, white

(526) The trademark is protected as a whole. The word "CONSULTING" included therein shall not be subject to independent legal protection.

(511)

35 – Business management consulting.

(260) AM 2015 75737 A

(800) 765640

(891) 2013 11 27

(731) BAMBO A/S

Egelund 37, DK-6200 Aabenraa, Denmark

(540)

ABRI

(511)

3 – Soap, perfumery products, essential oils, cosmetics, hair lotions, dentifrices.

5 – Sanitary preparations, hygiene articles for medical use, including napkins and sanitary pads for incontinents, panty liners, menstruation tampons, menstruation bandages.

16 – Babies napkins of paper, paper for household purposes including kitchen rolls, toilet paper, towels

of paper in sheets and roll form, napkins, place mats and paper covers.

(260) AM 2015 75741 A

(800) 977624

(891) 2013 08 17

(731) Baufan Bauchemie Leipzig GmbH
Ludwig-Hupfeld-Str. 19, 04178 Leipzig,
Germany

(540)

baufan

(511)

1 – Chemicals for use in industry; adhesives for use in industry; wallpaper adhesives; wood adhesives; glues for floor, wall and ceiling coverings; fixing materials for floor coverings; adhesives for the do-it-yourself field; universal glues; adhesives for tiles; wood mastics; products for removing wallpapers.

2 – Paints; varnishes; lacquers; anti-rust products for preservation; products to prevent wood deterioration; primers, base hardeners; dispersion paints; silicate paints, paints for roofs and substructures, colored paints used for dyeing other paints; paints for ceilings and walls, paints for fuel depots, latex binders; coatings for mineral bases or bases strengthened by synthetic resin in the field of construction; mastics; color concentrates; fungicide additives for paints.

3 – Solvents for glues, paints, greases, oils and resins, preparations for cleaning paintbrushes and brushes, adhesive removal products; cleaning products, particularly drain cleaners; strippers, laundry preparations.

5 – Algicides and fungicides; spraying agents for removing mold, agents for removing algae, mold and foams.

17 – Insulating coatings; grouting materials (included in this class); insulating salts; sealant compounds for joints.

(260) AM 2015 75742 A

(800) 1014129

(891) 2013 11 22

(731) Otkrytoe aktsionerное obshchestvo
"NIZHEGORODSKY KHIMIKO-
FARMATSEVTISHESKY ZAVOD"
7 Salganskaya St., GSP-459, RU-603950
Nizhny Novgorod, Russian Federation

(540)

ХОНДРОКСИД

(511)

35 – Advertising.

39 – Delivery of goods; storage of goods.

(260) AM 2015 75754 A

(800) 1190182

(891) 2013 10 21

(731) FLEX SOFTWARE SYSTEMS, CLOSED
JOINT STOCK COMPANY
Novolesnaya street, d. 2, RU-127055 Moscow,
Russian Federation

(540)



(591) Dark red and red

(511)

9 – Ticket dispensers; cash registers; electric apparatus for commutation; magnetic tape units for computers; computer memory devices; video screens; disks, magnetic; disk drives for computers; juke boxes for computers; interfaces for computers; calculating machines; electronic pens [visual display units]; encoded magnetic cards; automated teller machines [ATM]; magnetic encoders; computers; notebook computers; money counting and sorting machines; mechanisms for coin-operated apparatus; coin-operated mechanisms for television sets; microprocessors; modems; monitors [computer hardware]; monitors [computer programs]; magnetic data media; computer software, recorded; converters, electric; distance recording apparatus; teaching apparatus; audio and video receivers; printers for use with computers; computer programmes [programs], recorded; computer game programs; computer programs [downloadable software]; computer operating programs, recorded; central processing units [processors]; electronic publications, downloadable; distribution consoles [electricity]; control panels [electricity]; scanners [data processing equipment]; audiovisual teaching apparatus; electric installations for the remote control of industrial operations; video recorders; invoicing machines; tape recorders; data processing apparatus; couplers [data processing equipment]; computer peripheral devices; readers [data processing equipment]; bar code readers; chips [integrated circuits]; projection screens.

35 – Arranging subscriptions to telecommunication services for others; import-export agencies; commercial information agencies; cost price analysis; rental of advertising space; computerized file management; accounting; invoicing; demonstration of goods; presentation of goods on communication media, for retail purposes; sales promotion for others; rental of vending machines; compilation of information into computer databases; business inquiries; systemization of information into computer databases; administrative processing of purchase orders; public relations.

38 – Providing access to databases; providing telecommunication channels for teleshopping services;

computer aided transmission of messages and images; rental of message sending apparatus; rental of modems; rental of telecommunication equipment.

42 – Computer system analysis; recovery of computer data; computer virus protection services; installation of computer software; consultancy in the design and development of computer hardware; computer software consultancy; updating of computer software; maintenance of computer software; conversion of data or documents from physical to electronic media; data conversion of computer programs and data [not physical conversion]; computer system design; rental of web servers; computer rental; rental of computer software; duplication of computer programs; computer software design; computer programming.

(260) AM 2015 75755 A

(800) 1190189

(891) 2013 12 06

(731) YOSEMITE RESEARCH LLC

1209 Orange Street, Wilmington DE 19801,
USA

(540)

MAMMOTH

(511)

9 – Computer software, including computer software for navigation, travel route planning, geographic, transportation and traffic information, driving and walking directions, street atlas information, electronic map display, and destination information.

(260) AM 2015 75756 A

(800) 1190218

(891) 2013 07 31

(731) HENKEL AG & CO. KGAA

Henkelstr. 67, 40589 Düsseldorf, Germany

(540)

Момент

(591) Black, white

(511)

1 – Chemicals used in industry; adhesives used in industry; unprocessed artificial resins.

9 – Dosing, especially for adhesives, as well as for means for removing old coatings and paints; accumulators and batteries, chargers for batteries; LEDs.

16 – Adhesives for stationery and household purposes; adhesive tapes for stationery or household purposes.

17 – Packing, stopping and insulating materials; sealing tapes, heat insulation and sound insulation materials, acrylic and silicone sealants, PU foam, adhesives for sealing purposes, putties.

(260) AM 2015 75757 A

(800) 1190226

(891) 2013 07 29

(731) IHOR SUVOROV

vul. Revenko, 28 B, M. Kremenchuk,
Poltavska oblast 39603, Ukraine

(540)



(591) Red and white

(511)

30 – Confectionery; pastries; fruit jellies (confectionery); confectionery for decorating Christmas trees; high-protein cereal bars; almond confectionery; peanut confectionery; cookies; quiches; fondants (confectionery); gingerbread; cakes; sweetmeats (candy); sweets; chocolate; pastilles (confectionery); halvah.

(260) AM 2015 75760 A

(800) 1190229

(891) 2013 08 09

(731) COMERCIALIZADORA MD S.A. DE C.V.

Circuito de la Productividad #105, Parque
Industrial Guadalajara, 45690 El Salto,
Jalisco, Mexico

(540)

BRONKITOSE

(511)

30 – Honey; molasses for food; golden syrup; coffee; tea; sugar; royal jelly; salt; bread; biscuits and cookies.

(260) AM 2015 75761 A

(800) 1190245

(891) 2013 08 26

(731) Society with Limited Liability

"IZVARINO PHARMA"

Territory of VNTsMDL, Bld.1, village Izvarino,
RU-142750 Moscow, Russian Federation

(540)

УРОФОСЦИН

(511)

35 – Advertising; business management; business administration; office functions; accounting; commercial administration of the licensing of the goods and services of others; administrative processing of purchase orders; advertising agencies; advertising by mail order; updating of advertising material; dissemination of advertising matter; rental of advertising space; commercial information and advice for consumers [consumer advice shop]; cost price analysis; telephone answering for unavailable subscribers; business appraisals; arranging newspaper subscriptions for others; arranging subscriptions to telecommunication services for others; business management of

performing artists; business management assistance; auctioneering; business auditing; bill-posting; professional business consultancy; business information; business inquiries; business investigations; business management and organization consultancy; business management consultancy; business management of hotels; business management of sports people; business organization consultancy; commercial or industrial management assistance; price comparison services; compilation of statistics; compilation of information into computer databases; systemization of information into computer databases; data search in computer files for others; demonstration of goods; direct mail advertising; distribution of samples; document reproduction; economic forecasting; business efficiency expert services; employment agencies; organization of exhibitions for commercial or advertising purposes; organization of fashion shows for promotional purposes; computerized file management; import-export agencies; commercial information agencies; invoicing; personnel management consultancy; marketing; marketing research; marketing studies; modelling for advertising or sales promotion; news clipping services; office machines and equipment rental*; on-line advertising on a computer network; opinion polling; organization of trade fairs for commercial or advertising purposes; outsourcing services [business assistance]; payroll preparation; personnel recruitment; photocopying services; presentation of goods on communication media, for retail purposes; word processing; procurement services for others [purchasing goods and services for other businesses]; production of advertising films; psychological testing for the selection of personnel; public relations; publication of publicity texts; publicity columns preparation; publicity material rental; radio advertising; relocation services for businesses; rental of advertising time on communication media; rental of photocopying machines; rental of vending machines; business research; sales promotion for others; secretarial services; shop window dressing; shorthand; sponsorship search; drawing up of statements of accounts; tax preparation; telemarketing services; television advertising; transcription; typing; writing of publicity texts.

(260) AM 2015 75770 A
 (800) 1190264
 (891) 2013 10 31
 (731) PZ CUSSONS (INTERNATIONAL) LIMITED
 Manchester Business Park, 3500 Aviator Way,
 Manchester M22 5TG, United Kingdom
 (540)



(591) Black, white

(511)
 3 – Hair care products; preparations for the hair; shampoos; conditioners; hair lotions; non-medicated toilet preparations; toilet articles; soaps; deodorants; creams and lotions for the care of the skin and body; facial skin preparations; preparations for use in the bath and shower; cosmetics; body sprays; perfumes; eau de toilette; eau de parfum; eau de cologne; essential oils; shaving and after shave preparations.

(260) AM 2015 75771 A
 (800) 1190273
 (891) 2013 11 01
 (731) ROLEX SA
 3-5-7 rue François-Dussaud, CH-1211
 Genève 26, Switzerland
 (540)

SUNDUST

(511)
 14 – Jewelry, timepieces, namely watches, wristwatches, components of timepieces and accessories for timepieces not included in other classes, clocks and other chronometric instruments, chronometers, chronographs (timepieces), apparatus for timing sports events, time measuring and marking apparatus and instruments not included in other classes; dials (for timepieces), hands (for timepieces), boxes, cases and presentation cases for timepieces and jewelry.

(260) AM 2015 75772 A
 (800) 1190281
 (891) 2013 10 03
 (731) PRIVATE JOINT STOCK COMPANY
 "INDUSTRIAL ASSOCIATION "KONTI"
 Bul. Shevchenko, 6-b, Donetsk 83015,
 Ukraine
 (540)

Золотая птичка

(511)
 30 – Coffee, tea, cocoa, sugar, rice, tapioca, sago, artificial coffee; flour and preparations made from cereals, bread, pastry and confectionery, ices; honey, treacle; yeast, baking-powder; salt, mustard; vinegar, sauces (condiments); spices; edible ices; farinaceous foods; pastries; bagels; bread rolls (confectionery); waffles; waffles with various fillings; waffle cakes; chips (cereal products); cereal product; dragee (confectionery); yeast and not yeast baking; fruit jellies (confectionery); chewing gum; frozen kefir; frozen yogurt; cocoa products; cocoa and coffee beverages; cocoa products; coffee beverages with milk; cocoa with milk; cocoa products; sandwiches; caramels (candy); cakes; crackers; starch foods; croissant; confectionery for decorating Christmas trees; candy for food; marzipan; almond confectionery; flour-milling products; pancakes; muesli; chocolate bevera-

ges; paskha (Easter cake); cookies; cookies glazed with chocolate; cookies with various fillings; quiches (confectionery); quiches with various fillings; pizza; pies; fondants (confectionery); gingerbread; puddings; bagels; bread rolls; sandwiches; sweetmeats (candy); crackers with additives; saltine crackers; petits fours (cakes); cakes; fruit ices; halvah; bakery; sweetmeats (candy); sugar confectionery; waffle candies; charlotte; chocolate; chocolate candies; chocolate bars; chocolate figurines.

(260) AM 2015 75773 A

(800) 1190282

(891) 2013 09 24

(731) PRIVATE JOINT STOCK COMPANY
"INDUSTRIAL ASSOCIATION "KONTI"
Bul. Shevchenko, 6-b, Donetsk 83015,
Ukraine

(540)

Весенняя сказка

(511)

30 – Coffee, tea, cocoa and artificial coffee; rice; tapioca and sago; flour and preparations made from cereals; bread, pastry and confectionery; ices; sugar, honey, treacle; yeast, baking-powder; salt; mustard; vinegar, sauces (condiments); spices; ice; aniseed; peanut confectionery; high-protein cereal bars; baking soda (bicarbonate of soda for cooking purposes); soya bean paste (condiment); bean meal; star aniseed; tapioca flour for food; flour; flour-milling products; bread rolls; buns; sandwiches; vanillin (vanilla substitute); vanilla (flavoring); waffles; vermicelli (noodles); cream of tartar for culinary purposes; farinaceous foods; oatmeal; oat flakes; oat-based food; sea water for cooking; seaweed (condiment); binding agents for ice cream (edible ices); biscuits; cloves (spice); mustard meal; cake frosting (icing); glucose for culinary purposes; relish (condiment); gluten additives for culinary purposes; essences for foodstuffs, except etheric essences and essential oils; fruit jellies (confectionery); chewing gum; custard; leaven; rice-based snack food; cereal-based snack food; frozen yogurt (confectionery ices); frozen kefir (confectionery ices); flavorings, other than essential oils, for beverages; flavorings, other than essential oils, for cakes; flavorings, other than essential oils; wheat germ for human consumption; preparations for stiffening whipped cream; thickening agents for cooking foodstuffs; chips (cereal products); ginger (spice); unroasted coffee; coffee flavorings; coffee-based beverages; coffee beverages with milk; vegetal preparations for use as coffee substitutes; cocoa beverages with milk; cocoa-based beverages; cocoa products; capers; caramels (candy); lozenges (confectionery); curry (spice); potato flour for food; ketchup (sauce); gluten prepared as foodstuff; confectionery with sugar; tortillas; cinnamon (spice); starch for food; hominy grits; groats for human food;

corn, milled; corn, roasted; corn flour; pop corn; corn flakes; turmeric for food; couscous (semolina); salt for preserving foodstuffs; confectionery for decorating Christmas trees; edible ices; ice for refreshment; ice, natural or artificial; liquorice (confectionery); noodles; candy; flaxseed for human consumption; mayonnaise; macaroni; maltose; hominy; chow-chow (condiment); marinades; marzipan; royal jelly; honey; molasses for food; macaroons (pastry); almond paste; almond confectionery; pancakes; spring rolls; gruel, with a milk base, for food; ice-cream; dessert mousses (confectionery); chocolate mousses; nutmegs; muesli; meat gravies; meat tenderizers, for household purposes; mint for confectionery; peppermint sweets; infusions, not medicinal; husked oats; ravioli; pepper; pesto (sauce); beer vinegar; quiches; sweetmeats (candy); pizzas; pies; fondants (confectionery); powder for edible ices; pralines; condiments; dressings for salad; seasonings; unleavened bread; bee glue; gingerbread; puddings; cake powder; fruit coulis (sauces); rice cakes; baking powder; ferments for pastes; sago; garden herbs, preserved (seasonings); celery salt; golden syrup; salt for preserving foodstuffs; soya flour; soya sauce; malt for human consumption; malt biscuits; malt extract for food; tomato sauce; spaghetti; noodle-based prepared meals; ham glaze; rusks; breadcrumbs; petit-beurre biscuits; sushi; tabbouleh; tacos; tapioca; petits fours (cakes); crackers; cake paste; tarts; sorbets (ices); halvah; bread; chicory (coffee substitute); iced tea; tea-based beverages; chutneys (condiments); saffron (seasoning); chocolate; chocolate-based beverages; chocolate beverages with milk; barley meal; barley (crushed).

(260) AM 2015 75774 A

(800) 1190330

(891) 2013 12 06

(731) COAST RESEARCH LLC
1209 Orange Street, Wilmington DE 19801,
USA

(540)

BIG SUR

(511)

9 – Computer features and applications for individuals with hearing and vision impairments and physical and learning disabilities; computers, computer software.

(260) AM 2015 75775 A

(800) 1190333

(891) 2013 11 28

(731) XADO-HOLDING LIMITED LIABILITY
COMPANY
4, 23 Serpnia Lane, Kharkiv 61103,
Ukraine

(540)

**ANY
WAY**

(591) Black, white

(511)

1 – Condensation-preventing chemicals; anti-tarnishing chemicals for windows; preparations for preventing the tarnishing of glass; stain-preventing chemicals for use on fabrics; chemical additives to fungicides; anti-incrustants.

2 – Anti-rust preparations for preservation; anti-rust greases; anti-rust oils; anti-corrosive preparations; protective preparations for metals; anti-tarnishing preparations for metals.

3 – Antistatic preparations for household purposes; air fragrancing preparations; laundry glaze; shining preparations [polish]; non-slipping wax for floors; washing soda, for cleaning; laundry preparations; bleaching soda; leather preservatives [polishes]; polishing creams; polishing preparations; polish for furniture and flooring; floor wax; soap; cleaning preparations; scouring solutions; colour-brightening chemicals for household purposes [laundry]; bleaching salts; cloths impregnated with a detergent for cleaning; disinfectant soap; scale removing preparations for household purposes; drying agents for dishwashing machines; refurbishing preparations; stain removers; laundry bleach; laundry preparations; laundry soaking preparations; laundry starch; preparations for unblocking drain pipes; dry-cleaning preparations; laundry starch; rust removing preparations; deodorant soap; fabric softeners for laundry use.

4 – Lubricants; lubricating oil; firelighters.

5 – Germicides; disinfectants for hygiene purposes; disinfectants for chemical toilets; carbolineum [parasiticide]; antiseptics; air purifying preparations; air deodorising preparations; fungicides; deodorants for clothing and textiles; deodorants, other than for human beings or for animals; insecticides; fly destroying preparations; insect repellent incense; larvae exterminating preparations; vermin destroying preparations; insect repellents; repellents for dogs; preparations for destroying mice; mothproofing paper; mothproofing preparations.

(260) AM 2015 75777 A

(800) 1190358

(891) 2013 11 22

(731) LIMITED LIABILITY COMPANY

"PREMIUM STYLE"

Magistralny tupik 1-st, d.5a, RU-123290

Moscow, Russian Federation

(540)

**Frudesso
Фрудессо**

(591) Black, white

(511)

29 – Jams; jellies for food; fruit jellies; fruit-based snack food; compotes; fruits, tinned; marmalade; fruit pulp; cranberry sauce [compote]; apple puree; fruit salads; crystallized fruits; fruit, preserved; fruit, stewed; fruit peel.

(260) AM 2015 75779 A

(800) 1190369

(891) 2013 07 09

(731) VALEO SERVICE

70 rue Pleyel, F-93200 Saint Denis, France

(540)



(591) Black, gray and yellow

(511)

7 – Machine tools; motors and engines; transmission couplings and belts; transmissions; couplers; torque converters; clutches; fly wheels; damper wheels; retarders and brakes of all kinds, command and control devices and parts thereof, especially mechanical, hydraulic, pneumatic, electrical, electrostatic, electromagnetic; alternators; starter motors; dynamos; igniting devices for internal combustion engines; spark plugs; glow plugs for diesel engines; friction linings and antifriction linings; shoes, shoe plates, blocks, washers, sectors, disks, belts, bearing rings, rollers, made of or coated with friction or anti-friction bodies; electromagnets, especially for carrying purposes; carbon brushes, particularly for alternators, electric motors or dynamos; fans for motors and engines; hydraulic actuators of clutch controls; electric motors other than for land vehicles; hydraulic or pneumatic control devices for apparatus for heating, refrigeration, aeration, ventilation, conditioning, air-conditioning, defogging for vehicles; turbines other than for land vehicles; hydraulic or pneumatic controls for hydraulic clutches; hydraulic or pneumatic control units for engines; transmissions; clutches; clutch mechanisms; friction disks; clutch release bearings; hydraulic clutch controls; electric clutch controls; electronically controlled actuators; hydraulic actuators of clutch controls; couplers; electric generators; alternators; aeronautical engines; compressed

air engines; filters for cleaning cooling air, for motors and engines; fuel, oil filters; shock absorber pistons (parts of machines); anti-pollution devices for motors and engines; vacuum cleaners; vacuum cleaner attachments for disseminating perfumes and disinfectants; gearboxes other than for land vehicles; fuel economizers for motors and engines; cartridges for filtering machines; clack valves [parts of machines]; control cables for machines, engines or motors; control mechanisms for machines, engines or motors; hydraulic controls for machines, motors and engines; pneumatic controls for machines, motors and engines; fuel conversion apparatus for internal combustion engines; fan belts for motors and engines; belts for motors and engines; jacks; cylinder heads for engines; cylinders for motors and engines; pistons for cylinders; starters for motors and engines; water separators; heat exchangers (parts of machines); exhausts for motors and engines; injectors for motor and engines; joints (parts of engines); washing apparatus; washing installations for vehicles; lifting apparatus; machine wheels; pistons (parts of machines or engines); air pumps (garage installations); pressure valves (parts of machines); propulsion mechanisms other than for land vehicles; radiators [cooling] for motors and engines; valves (parts of machines); heat exchangers (parts of machines); turbocompressors; fans for motors and engines; brake shoes, electric plates and segments; automatic apparatus operated by the introduction of a coin or a token, gasoline pumps for service stations.

9 – Scientific, nautical, surveying, photographic apparatus and instruments, cinematographic, optical, weighing, measuring, signaling, for indication of position, detection, checking (supervision), life-saving (rescue), security and teaching; apparatus, instruments, electric and electronic equipment and apparatus for vehicles, namely controls for windscreen wipers, heating and air conditioning, seat adjustment, window regulators, sunroofs, radio and navigation, cruise control.; integrated systems of car radios, navigation and air-conditioning management; circuit breakers; battery cut-off switches (at rest and in the event of collision); electronic management of batteries; utility trays, optical, electric and electronic wiring systems, including in pre-assembled form particularly for vehicles and all components for transmission by multiplexing, coupling or other means, of signals (sounds, images, data) or information on vehicles; apparatus and instruments for conducting, switching, transforming, storing, regulating or controlling carrier currents; systems for the wireless connection of electronic devices; traditional semiconductor fuse boxes, electric interconnection housings; anti-pinching systems for window regulators and sunroofs; on-board communication networks for vehicles, especially multiplexed and particularly apparatus and instruments for mobile phones known as

hands-free kits with a microphone, cordless or other headphones; cameras; microphones; earphones; connectors; clips; connection pieces; interface links; electric, electronic or optical equipment, on board vehicles, including land vehicles, for steering, signaling, controlling, for information, safety as well as processing of information and signals (sounds, images, data) related thereto; liquid level sensors; oil level sensors; temperature sensors; rain sensors; dirt sensors; pressure sensors; position, angle, torque and rotary speed sensors; presence detectors; motion and motion analysis detectors; devices for adjusting headlight beams; signaling systems with light-emitting diodes, including high-power diodes; directional lighting systems; lighting systems for reducing glare from other drivers; control modules for electric motors; electric or electronic regulators for alternators; apparatus for electronic power regulation (current inverters and current variators); chopper circuits (current converters); supercapacitors; current rectifiers; diode bridges; electrical or electronic variators; electric accumulators; electric relays and commutators; printed circuits; electronic components; diodes and semiconductors; rectifiers, especially diode bridges, Peltier-effect modules, radiators and exchangers for diodes and modules; electronic ignition modules; on-board and ground diagnostic calculators; on-board diagnostic systems and remote query diagnostic systems; systems for downloading software and updating software; systems for communication between vehicles and road infrastructure; electromagnetic relays; measuring sensors; ignition coils; ignition switches; ignition distributors; wiring harnesses; ignition harnesses; suppression capacitors; electric and/or electronic clutch controls; electric or electronic gearbox controls; electric locks; electric steering wheel locks; remote control systems; electronic key fobs; transponders; alarms, especially with ultrasound sensors; switches, electric; electric switches; control panels; dashboard instruments, namely revolution counters; speedometers; multifunction display screens; liquid crystal displays; on-board computers for vehicles; navigation assistance devices comprising compact disk players or other digital data media, liquid crystal display screens, microphones, keyboards, loudspeakers and headphones; on-board and ground diagnostic calculators; electric switches; electric control levers; parking assistance and automated parking systems, namely radar parking apparatus, vehicle reversing sensors, anti-collision and anti-impact sensors for vehicles, electronic devices, LIDAR, video cameras, infrared sensors, sonars, anti-collision and anti-impact radars for vehicles, transmitters, ultrasound receivers; obstacle detection devices; systems for communication between motor vehicles and fixed stations; electronic cards; housings for electronic circuits; electrical connectors; rotating contacts; switches below steering wheels; flashing-light units; el-

electronic power supply devices for discharge lamps; data media, especially magnetic or optical media; talking machines, cash registers, calculating machines; fire extinguishers, protection devices for personal use against accidents; air analysis apparatus; printed circuits; integrated circuits; fiber-optic cables; coaxial cables; starter cables for motors; electronic engine heat regulating apparatus; electronic control of valves, pumps, ventilation fans; speed checking apparatus for vehicles, speed governors; optical data media; magnetic data media; transmitting sets (telecommunication); transmitters of electronic signals; time recording apparatus; distance recording apparatus; sound recording apparatus; kilometer recorders for vehicles; gasoline gauges; fuses; printers for use with computers; fire alarms; slope indicators; electric loss indicators; pressure indicator plugs for valves; temperature indicators; speed indicators; data processing apparatus; readers (data processing equipment); bar code readers; optical character readers; software (recorded programs); distance measuring apparatus; modems; monitors (hardware); monitors (computer programs); satellite navigation apparatus; navigation apparatus for vehicles (on-board computers); computers; computer peripherals; warning triangles for vehicles; transmitters of electronic signals; simulators for the steering and control of vehicles; electronic notice boards; taximeters; portable telephones; decelerometers; apparatus for checking the efficiency of vehicle braking devices; electric cards; devices for regulating headlight beams; variators for lighting intensity, especially as a function of braking for brake lights; control modules for electric motors; systems for detecting, processing, signaling and following stationary and moving objects around a vehicle; assistance systems for parking, reversing and blind spot detection; pre-collision detection and collision avoidance systems; automatic braking systems; light variation sensors; automatic and remote locking and unlocking systems for vehicle apertures; automatic and remote starting for vehicle systems; keyless access and starting systems for vehicles; automatic opening and closing systems for vehicle doors, trunks, hoods and roofs; systems for the remote control of vehicle heating or air conditioning by means of a fob, or in combination with another device such as a telephone, pocket computer, electronic agenda; systems for recovering specific vehicle data on a fob; control screens; software; flat screens; compact disk players, including for video compact disks; digital compact disks, including video compact disks and other data media; multimedia equipment for the information and entertainment of passengers of a vehicle; equipment for communication via Internet link or similar equipment and for data display inside a vehicle; reception antennas, transmission antennas for sound, images and data; head-up display screens; lateral trajectory monito-

ring systems; video sensors; road-marking detection apparatus; apparatus and instruments for processing video images; signaling systems and cameras; condensers (capacitors).

11 – Installations for heating, steam generating, cooking, refrigerating, drying, ventilating, water supply and sanitary purposes; air ozonizers; position indicators for valves and faucets, and parts thereof; hot air ovens; conditioners; air conditioners; convectors; heat exchangers; radiators, finned pipes, boilers; central heating equipment; urban heating facilities; heating, refrigerating, airing, ventilating, air conditioning and defogging apparatus for vehicles, command or control parts and units thereof; control panels for such apparatus; heat exchangers; ventilator fans for air-conditioning; heat accumulators; air-purifying apparatus and machines; air deodorizing apparatus; filters for air conditioning; air filtering installations; demisting heating apparatus for vehicles; heating apparatus for defrosting windows of vehicles; radiator caps; solar collectors (heating); heat regenerators; air conditioners for vehicles; fuel economizers; air conditioners for vehicles; defrosters for vehicles; liquid coolers (installations); level regulating valves for tanks; pressurized water tanks; electric regulation valves; storage devices for heat or cold.

12 – Vehicles, apparatus for locomotion by land, air or water; motors and engines; electric motors for vehicles; transmissions; clutches; clutch mechanisms; friction disks; clutch release bearings; clutch torsion dampers; fly wheels; fly-wheels with torsional damper; hydraulic clutch controls; electric clutch controls; electronic, hydraulic actuators for clutch controls; couplers; torque converters for vehicles, their command or control parts and devices; belt speed drives; speed humps; brakes and braking installations for vehicles, their command and control parts and devices; apparatus for checking the efficiency of vehicle braking devices; hydrodynamic retarders and brakes and eddy current (Foucault current) retarders and brakes for vehicles as well as component parts thereof, spare parts for mechanical, hydraulic, pneumatic, electrical or electronic connecting, fastening, commanding, controlling; safety belts for vehicle passengers; accessories for vehicle equipment or decoration, namely doors, hoods, bumpers, steering wheels, window panes, windshields, hoods for vehicles, silencers, gearboxes, axles, wheels, wheel rims, tires, inner tubes, spikes for tires, hub caps, balance weights for wheels, air pumps, automobile chains, seats, seat covers, child safety seats, headrests for seats, trailer connections, luggage carriers, ski luggage racks; headlight inclination correctors; electric and/or electronic power steering devices; electronic power suspension; electromechanical actuators, especially for locking doors, adjusting the position of seats, rear-view mirrors and the

direction of headlights, for controlling sunroofs and window openers; brake linings; steering wheel locks; actuators for locks; car horns; windshield wipers and components thereof such as windshield wiper blades, connectors and fastening systems for windshield wiper blades, windshield wiper arms, deflectors; windshield wiper movement transmission assemblies; windshield wiper support plates; electric motors; motor reducers; windshield washers; windshield washer bottles; lockless petrol tank caps; air intake control valves on a radiator; brake cylinders for hydraulic clutch control; master cylinders for brakes or clutches; vehicle door handles; air intake control valves on a radiator; reversing alarms for vehicles; gearboxes for land vehicles, hydraulic circuits for vehicles; upholstery for vehicle; brake shoes, brake pads and shoes, brake discs; robotic gearboxes; equipment for eliminating pollutant gases by photocatalysis; windshields comprising a screen for viewing data and images; rearview mirrors with video camera, with display, with signal lights; cigar lighters for automobiles.

16 – Printed matter other than magazines, newspapers other than magazines and periodicals other than magazines; books other than magazines; advertising documents; prospectuses, catalogs; paper; packing cardboard; boxes of cardboard, paper or plastic bags, small bags, wrappings, pouches for packaging purposes; bookbinding material; stationery; adhesive materials (for stationery); painting and coating equipment; albums; architects' models; cards; geographical maps; filtering materials (paper); instructional and teaching material; plastic wrapping.

17 – Gutta-percha; natural rubber; balata and substitute materials, packing, stopping and insulating materials; asbestos, mica; insulating coatings for use in building and industry; flexible pipes, not of metal; friction facings for clutches; plastics in extruded form for use in manufacture; tubes, sheets, plates of plastic; extruded plastics in the form of rods and profiles for use in manufacturing; plastics in extruded form for use in manufacture; sealing material, particularly pastes and mastics; friction lining materials, partly processed; compressed air pipe fittings, not of metal; rubber stoppers; insulators for cables; compositions for preventing the radiation of heat; insulators for electric mains; fiberglass for insulation; filtering materials (semi-processed foams or plastics); brake lining materials, partly processed; waterproof packings; soundproofing materials, connecting hose for vehicle radiators.

(260) AM 2015 75780 A
(800) 1190380
(891) 2013 09 06
(731) TISSOT SA
Chemin des Tourelles 17, CH-2400 Le Locle,
Switzerland

(540)

WATCH-SECUR

(511)

9 – Electronic equipment for the marking, encoding, monitoring, tracking or authentication of goods; software for the marking, encoding, monitoring, tracking or authentication of goods.

42 – Design, development, configuration or updating of electronic equipment for the marking, encoding, monitoring, tracking or authentication of goods; programming, configuration or updating of software for the marking, encoding, monitoring, tracking or authentication of goods; technological services for combating counterfeiting; technological services for marking and tracking goods; technological goods authentication services; consultancy in the field of the traceability and authentication of goods.

45 – Legal services for combating counterfeiting; legal services for monitoring and tracking of goods; legal goods authentication services; security services, in particular marking and labeling of goods.

(260) AM 2015 75781 A

(800) 1190386

(891) 2013 11 27

(731) LIMITED LIABILITY COMPANY
"VIKTORIYA"

Pobedy Street, 102 RU-352630 Belorechensk,
Krasnodarskiy Kray, Russian Federation

(540)

БИСКВИТ ФАВОРИТ

(511)

30 – Sponge dough products, namely, sponge cake roll, sponge layer cake, sponge plum cake, sponge pie, sponge dough discs.

(260) AM 2015 75782 A

(800) 1190388

(891) 2013 11 04

(731) IURII OLEKSIIOVYCH LOPAIENKO

kvartal Levchenko, 1A, kv. 18, m. Luhansk
91051, Ukraine

(540)

ОРАКУЛ

(591) black, white

(511)

1 – Additives, chemical, to fungicides; anti-sprouting preparations for plants; anti-sprouting preparations for vegetables; calcium cyanamide [fertilizer]; chemical preparations to prevent mildew; chemical products for use in agriculture, horticulture and forestry (except fungicides, weedkillers, herbicides, insecticides and parasiticides); compost; copper sulphate [vitriol]; nitrogenous fertilizers; nitrogenous lime [manure]; manure for agriculture; phosphates

[fertilisers]; plant growth regulating preparations; saltpeter; salts [fertilisers]; superphosphates [fertilisers].

(260) AM 2015 75789 A

(800) 1190404

(891) 2013 06 03

(731) SEYHMUS YOLAÇAN

Aksaray Mahallesi, Küçükklanga Araligi
Caddesi No:22/A, Fatih – Istanbul, Turkey

(540)

YOLAÇAN

(511)

25 – Clothing, namely, trousers; jackets; overcoats; coats; skirts; suits; jerseys; waistcoats; shirts; ready-made leather linings (parts of clothing); T-shirts; sweatshirts; dresses; shorts; pajamas; pullovers; jeans; tracksuits; rainwear; beachwear; bathing suits; swimming suits; clothing for sports (for exclusive use for sports); clothing for babies, namely, shirts; pants; coats; dresses; underclothing, namely, boxer shorts; brassieres; briefs; pants; socks; footwear, namely, shoes excluding orthopedic shoes; sandals; waterproof boots; walking boots; booties; sporting shoes; slippers; shoe parts, namely, heelpieces; insoles for footwear; footwear uppers; headgear, namely, caps; skull caps; sports caps; hats; berets; gloves (clothing); stockings; belts (clothing); camisoles; sarongs; scarves; neck scarves; shawls; collars; neckties; ties; suspender belts.

(260) AM 2015 75831 A

(800) 1190591

(891) 2013 10 08

(731) SOREMARTEC SA

Rue Joseph Netzer 5, B-6700 Arlon, Belgium

(540)



(591) White, dark orange, various shades of brown, green, beige, various shades of blue

(511)

30 – Pastry and confectionery, chocolate and chocolate-based products, cocoa and cocoa-based products, candy, edible ices.

(260) AM 2015 75838 A

(800) 1190617

(891) 2013 12 06

(731) ANTALOS APPS LLC

1209 Orange Street, Wilmington DE 19801,
USA

(540)

SIERRA

(511)

9 – Mail, messaging, calendar, reminder, contacts, and other computer software.

(260) AM 2015 75839 A

(800) 1190621

(891) 2013 12 06

(731) COAST RESEARCH LLC

1209 Orange Street Wilmington DE 19801,
USA

(540)

PACIFIC

(511)

9 – Computer features and applications for individuals with hearing and vision impairments and physical and learning disabilities; computers, computer software.

(260) AM 2015 75840 A

(800) 1190631

(891) 2013 12 06

(731) CASSOWARY DEVICES LLC

1209 Orange Street, Wilmington DE 19801,
USA

(540)

REDTAIL

(511)

9 – Voice recognition, dictation, dictionary, and other computer software.

(260) AM 2015 75841 A

(800) 1190649

(891) 2013 11 26

(731) JAPAN TOBACCO INC.

2-2-1 Toranomom, Minato-ku, Tokyo, Japan

(540)



(591) Dark blue and white

(511)

34 – Tobacco, raw or manufactured; smoking tobacco, pipe tobacco, rolling tobacco, chewing tobacco, moist tobacco powder called "snus"; cigarettes, electronic cigarettes, cigars, cigarillos; snuff; smokers' articles included in this class; cigarette paper, cigarette tubes and matches.

(260) AM 2015 75842 A
 (800) 1190650
 (891) 2013 11 29
 (731) COMPAGNIE GENERALE DES
 ETABLISSEMENTS MICHELIN
 12 Cours Sablon, F-63000 CLERMONT
 FERRAND, France

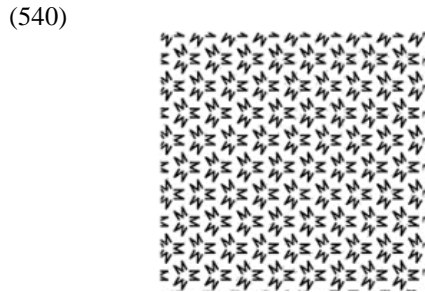

(591) Black, white
 (511)
 12 – Pneumatic tires and inner tubes for vehicle wheels; treads for retreading tires; treads for vehicles [tractor type].

(260) AM 2015 75843 A
 (800) 1190651
 (891) 2013 11 29
 (731) COMPAGNIE GENERALE DES
 ETABLISSEMENTS MICHELIN
 12 Cours Sablon, F-63000 CLERMONT
 FERRAND, France

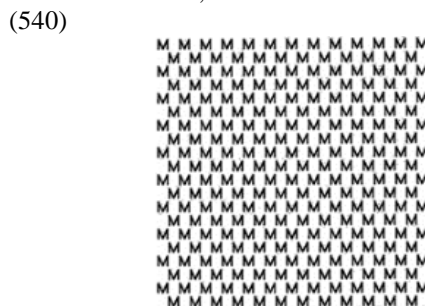

(591) Black, white
 (511)
 12 – Pneumatic tires and inner tubes for vehicle wheels; treads for retreading tires; treads for vehicles [tractor type].

(260) AM 2015 75844 A
 (800) 1190659
 (891) 2013 04 03
 (731) SATURN HOME APPLIANCES S.R.O.
 Konevova, 141/2660, CZ-130 83 Prague
 3 - Zizkov, Czech Republic

(540)

Laretti

(511)
 7 – Machines and machine tools; motors and engines [except for land vehicles]; machine coupling and transmission components (except for land vehicles);

agricultural implements other than hand-operated; incubators for eggs; aerated water making apparatus; aerated beverage-making machines; lawnmowers [machines]; current generators; de-aerators for feed-water; can openers, electric; electric hand drills; printing machines; electric hammers; generators of electricity; blenders, electric, for household purposes; degreasers [machines]; hand-held tools, other than hand-operated; food preparation machines, electromechanical; coffee grinders, other than hand-operated; condensing installations; knives for mowing machines; harvesting machines; food processors, electric; kitchen machines, electric; machines and apparatus for polishing [electric]; machines for making edible pastes; butter machines; washing machines; washing apparatus; mixers [machines]; mineral water making machines; mixing machines; pneumatic hammers; motorized cultivators; meat choppers [machines]; beverage preparation machines, electromechanical; pumps [machines]; scissors, electric; knives, electric; apparatus for drawing up beer under pressure; beer pumps; dust removing installations for cleaning purposes; dust exhausting installations for cleaning purposes; vacuum cleaners; vacuum cleaner bags; vacuum cleaner hoses; grinders/crushers, electric, for household purposes; dishwashers; washing machines [laundry]; ironing machines; smoothing presses; cutting machines; filling machines; fruit presses, electric, for household purposes; spin driers [not heated]; grating machines for vegetables; kneading machines; bread cutting machines; machines and apparatus for cleaning, electric; sewing machines; electric machines and apparatus for household purposes, included in this class.

11 – Apparatus for lighting, heating, steam generating, cooking, refrigerating, drying, ventilating, water supply and sanitary purposes, including: fans [air-conditioning]; electric fans for personal use; ventilation [air-conditioning] installations and apparatus; hair driers; gas boilers; gas burners; electric appliances for making yogurt; roasters; coffee roasters; roasting apparatus; grills [cooking appliances]; griddles [cooking appliances]; ionisation apparatus for the treatment of air; coffee percolators, electric; coffee filters, electric; coffee machines, electric; refrigerating chambers; air conditioning apparatus; cooking utensils, electric; cooking apparatus and installations; cooking rings; kitchen ranges [ovens]; cookers; ice machines and apparatus; ice boxes; microwave ovens [cooking apparatus]; milk cooling installations; freezers; air reheaters; beverage cooling apparatus; roasting jacks; heating plates; stoves [heating apparatus]; oil-scrubbing apparatus; heating installations; hot water heating installations; heating apparatus; heating apparatus, electric; heating apparatus for solid, liquid or gaseous fuels; heating boilers; steam generating installations; pasteurisers; furnaces; air purifying apparatus and machines; air reheaters; air conditioning installations; air cooling

apparatus; air filtering installations; air sterilisers; air driers [dryers]; radiators [heating]; radiators, electric; sanitary apparatus and installations; pressure cooking saucepans, electric; deep fryers, electric; malt roasters; sterilizers; plate warmers; drying apparatus; drying apparatus and installations; kilns; heat accumulators; bread toasters; filters for air conditioning; filters for drinking water; fruit roasters; extractor hoods for kitchens; bread toasters; bread baking machines; bakers' ovens; cooling installations for water; cooling installations for liquids; cooling installations and machines; refrigerators; refrigerating apparatus and machines; refrigerating containers; refrigerating chambers; refrigerating display cabinets [display cases]; cooling appliances and installations; refrigerating appliances and installations; refrigerating cabinets; kettles, electric.

21 – Household or kitchen utensils and containers; combs and sponges; brushes (except paint brushes); brush-making materials; articles for cleaning purposes; steelwool; unworked or semi-worked glass (except glass used in building); glassware, porcelain and earthenware not included in other classes; autoclaves [pressure cookers], non-electric; insulating flasks; bottles; vases; waffle irons, non-electric; containers for household or kitchen use; boxes of metal, for dispensing paper towels; pitchers; feeding troughs; heaters for feeding bottles, non-electric; pots; flower pots; decanters; deodorising apparatus for personal use; cutting boards for the kitchen; ironing boards; beaters, non-electric; domestic grinders, non-electric; blenders, non-electric, for household purposes; coffeepots, non-electric; coffee grinders, hand-operated; coffee services [tableware]; coffee percolators, non-electric; coffee filters, non-electric; cooking pots; stew-pans; rolling pins, domestic; goblets; mugs; ceramics for household purposes; baskets for domestic use; crystal [glassware]; jugs; cooking utensils, non-electric; cookery molds [moulds]; kitchen utensils; saucepan scourers of metal; cooking pot sets; kitchen containers; kitchen mixers, non-electric; blenders, non-electric, for household purposes; domestic grinders, non-electric; cooking skewers, of metal; polishing apparatus and machines, for household purposes, non-electric; funnels; liquor sets; noodle machines, hand-operated; spatulas [kitchen utensils]; basins [bowls]; services [dishes]; utensils for household purposes; pastry cutters; cruet stands for oil and vinegar; basting spoons, for kitchen use; mixing spoons [kitchen utensils]; pepper mills, hand-operated; pepper pots; beer mugs; trivets [table utensils]; porcelain ware; dishes; mixers, manual [cocktail shakers]; drinking vessels; glass jars [carboys]; refrigerating bottles; vessels of metal for making ices and iced drinks; cabarets [trays]; sifters [household utensils]; gridiron supports; griddles [cooking utensils]; salad bowls; sieves [household utensils]; siphons for carbonated water; glass [receptacles]; glassware; painted glassware; fruit

presses, non-electric, for household purposes; tableware, other than knives, forks and spoons; table plates; heat-insulated containers; crockery; ice cube molds [moulds]; bread bins; refrigerating bottles; food cooling devices containing heat exchange fluids, for household purposes; non-electric portable coldboxes; coolers [ice pails]; strainers; strainers for household purposes; boxes for sweetmeats, candy boxes; sugar bowls; garlic presses [kitchen utensils]; hot pots, not electrically heated; cauldrons; tea balls; kettles, non-electric; tea caddies; tea services [tableware]; tea strainers; cups.

(260) AM 2015 75845 A

(800) 1190695

(891) 2013 09 23

(731) I.P. CREATIONS ENTERPRISES LIMITED

Agiou Pavlou, 15 Ledra House, Agios

Andreas, CY-1105 Nikosia, Cyprus

(540)

YAM KEE

(591) Black, white

(511)

16 – Paper, cardboard and goods made from these materials, not included in other classes; printed matter; bookbinding material; photographs; stationery; adhesives for stationery or household purposes; artists' materials; paint brushes; typewriters and office requisites (except furniture); instructional and teaching material (except apparatus); plastic materials for packaging (not included in other classes); printers' type; printing blocks; addressing machines; address plates for addressing machines; address stamps; adhesive bands for stationery or household purposes; adhesives [glues] for stationery or household purposes; adhesive tape dispensers [office requisites]; adhesive tapes for stationery or household purposes; advertisement boards of paper or cardboard; albums; almanacs; announcement cards [stationery]; apparatus for mounting photographs; aquarelles; architects' models; arithmetical tables; atlases; bags [envelopes, pouches] of paper or plastics, for packaging; bags for microwave cooking; balls for ball-point pens; bibs of paper; binding strips [bookbinding]; biological samples for use in microscopy [teaching materials]; blackboards; blotters; blueprints; bookbinding apparatus and machines [office equipment]; bookbinding cloth; bookbindings; bookends; booklets; bookmarkers; books; bottle envelopes of cardboard or paper; bottle wrappers of cardboard or paper; boxes of cardboard or paper; cabinets for stationery [office requisites]; calendars; canvas for painting; carbon paper; cardboard; cardboard articles; cardboard tubes; cards; cases for stamps [seals]; catalogues; chalk for lithography; chalk holders; charcoal pencils; chart pointers, non-electronic;

chromolithographs [chromos]; cigar bands; clipboards; coasters of paper; comic books; compasses for drawing; composing frames [printing]; conical paper bags; copying paper [stationery]; cords for bookbinding; correcting fluids [office requisites]; correcting ink [heliography]; covers of paper for flower pots; covers [stationery]; cream containers of paper; credit card imprinters, non-electric; diagrams; document files [stationery]; document laminators for office use; drawer liners of paper, perfumed or not; drawing boards; drawing instruments; drawing materials; drawing pads; drawing pens; drawing pins; drawing rulers; drawing sets; drawing squares; drawing T-squares; duplicators; elastic bands for offices; electrocardiograph paper; electrotypes; embroidery designs [patterns]; engraving plates; engravings; envelope sealing machines, for offices; envelopes [stationery]; erasing products; erasing shields; etching needles; etchings; fabrics for bookbinding; face towels of paper; figurines [statuettes] of papier mâché; files [office requisites]; filtering materials [paper]; filter paper; finger-stalls [office requisites]; flags of paper; folders for papers; folders [stationery]; forms, printed; fountain pens; franking machines for office use; French curves; galley racks [printing]; garbage bags of paper or of plastics; geographical maps; glue for stationery or household purposes; gluten [glue] for stationery or household purposes; graining combs; graphic prints; graphic representations; graphic reproductions; greeting cards; gummed cloth for stationery purposes; gummed tape [stationery]; gums [adhesives] for stationery or household purposes; handkerchiefs of paper; hand labelling appliances; hand-rests for painters; handwriting specimens for copying; hat boxes of cardboard; hectographs; histological sections for teaching purposes; holders for checkbooks [cheque books]; holders for stamps [seals]; house painters' rollers; index cards [stationery]; indexes; Indian inks; ink; inking pads; inking ribbons; inking ribbons for computer printers; inking sheets for document reproducing machines; inking sheets for duplicators; inkstands; ink sticks; ink stones [ink reservoirs]; inkwells; isinglass for stationery or household purposes; labels, not of textile; ledgers [books]; letter trays; lithographic stones; lithographic works of art; lithographs; loose-leaf binders; luminous paper; magazines [periodicals]; manifolds [stationery]; manuals [handbooks]; marking chalk; mats for beer glasses; mimeograph apparatus and machines; modelling clay; modelling materials; modelling paste; modelling wax, not for dental purposes; moisteners for gummed surfaces [office requisites]; moisteners [office requisites]; molds for modelling clays [artists' materials]; money clips; musical greeting cards; newsletters; newspapers; nibs; nibs of gold; note books; numbering apparatus; numbers [type]; obliterating stamps; office perforators; office requisites, except furniture; oleographs; packaging material ma-

de of starches; pads [stationery]; paint boxes [articles for use in school]; paintbrushes; painters' brushes; painters' easels; paintings [pictures], framed or unframed; palettes for painters; pamphlets; pantographs [drawing instruments]; paper; paper bows; paper clasps; paper-clips; paper coffee filters; paper for radiograms; paper for recording machines; paper knives [cutters] [office requisites]; paper ribbons; paper sheets [stationery]; paper tapes and cards for the recordal of computer programmes; paperweights; papier mâché; parchment paper; passport holders; pastels [crayons]; patterns for dressmaking; patterns for making clothes; pencil holders; pencil lead holders; pen cases; pencil leads; pencils; pencil sharpeners, electric or non-electric; pencil sharpening machines, electric or non-electric; pen clips; penholders; pens [office requisites]; pen wipers; perforated cards for Jacquard looms; periodicals; photo-engravings; photographs [printed]; photograph stands; pictures; placards of paper or cardboard; place mats of paper; plastic bubble packs for wrapping or packaging; plastic cling film, extensible, for palletization; plastic film for wrapping; plastics for modelling; portraits; postage stamps; postcards; posters; printed publications; printed timetables; printers' blankets, not of textile; printers' reglets; printing blocks; printing sets, portable [office requisites]; printing type; prints [engravings]; prospectuses; punches [office requisites]; rollers for typewriters; rosaries; rubber erasers; school supplies [stationery]; scrapers [erasers] for offices; sealing compounds for stationery purposes; sealing machines for offices; sealing stamps; sealing wafers; sealing wax; seals [stamps]; self-adhesive tapes for stationery or household purposes; sheets of reclaimed cellulose for wrapping; shields [paper seals]; signboards of paper or cardboard; silver paper; slate pencils; song books; spools for inking ribbons; square rulers; stamp pads; stamps [seals]; stamp stands; stands for pens and pencils; staples for offices; stapling presses [office requisites]; starch paste [adhesive] for stationery or household purposes; steatite [tailor's chalk]; steel letters; steel pens; stencil cases; stencil plates; stencils; stencils [stationery]; stickers [stationery]; tablecloths of paper; table linen of paper; tablemats of paper; table napkins of paper; tags for index cards; tailors' chalk; teaching materials [except apparatus]; terrestrial globes; tickets; tissues of paper for removing make-up; toilet paper; towels of paper; tracing cloth; tracing needles for drawing purposes; tracing paper; tracing patterns; transfers [decalcomanias]; transparencies [stationery]; trays for sorting and counting money; type [numerals and letters]; typewriter keys; typewriter ribbons; typewriters, electric or non-electric; vignetting apparatus; viscose sheets for wrapping; watercolor [watercolour] sacers for artists; waxed paper; wood pulp board [stationery]; wood pulp paper; wrapping paper; wristbands for the retention of writing instruments; writing board era-

sers; writing brushes; writing cases [sets]; writing cases [stationery]; writing chalk; writing instruments; writing materials; writing or drawing books; writing pads; writing paper; writing slates; Xuan paper for Chinese painting and calligraphy.

29 – Meat, fish, poultry and game; meat extracts; preserved, frozen, dried and cooked fruits and vegetables; jams, compotes; eggs; milk and milk products; edible oils and fats; albumen for culinary purposes; alginates for culinary purposes; almonds, ground; anchovy; animal marrow for food; apple purée; bacon; beans, preserved; black pudding [blood sausage]; bone oil, edible; bouillon; bouillon concentrates; butter; buttercream; caviar; charcuterie; cheese; clams [not live]; coconut butter; cocoa butter; coconut, desiccated; coconut fat; coconut oil; colza oil for food; corn oil; cranberry sauce [compote]; crayfish, not live; cream [dairy products]; croquettes; crustaceans, not live; crystallized fruits; curd; dates; edible birds' nests; fat-containing mixtures for bread slices; fatty substances for the manufacture of edible fats; fish fillets; fish meal for human consumption; fish, not live; fish, preserved; fish, tinned; foods prepared from fish; frozen fruits; fruit-based snack food; fruit chips; fruit jellies; fruit peel; fruit, preserved; fruit preserved in alcohol; fruit pulp; fruit salads; fruit, stewed; fruits, tinned; game, not live; gelatine; gherkins; ginger jam; ham; herrings; hummus [chickpea paste]; isinglass for food; jellies for food; kephir [milk beverage]; kimchi [fermented vegetable dish]; kumys [kumyss] [milk beverage]; lard for food; lentils, preserved; linseed oil for culinary purposes; liver; liver pâté; lobsters, not live; margarine; marmalade; meat jellies; meat, preserved; meat, tinned; milk beverages, milk predominating; mushrooms, preserved; mussels, not live; non-alcoholic egg nog; nuts, prepared; olive oil for food; olives, preserved; onions, preserved; oysters, not live; palm kernel oil for food; palm oil for food; peanut butter; peanuts, processed; peas, preserved; pectin for culinary purposes; piccalilli; pickles; pollen prepared as foodstuff; pork; potato chips; potato flakes; potato fritters; powdered eggs; prawns, not live; preparations for making bouillon; preparations for making soup; raisins; rennet; salmon; salted fish; salted meats; sardines; sauerkraut; sausages; sausages in batter; sea-cucumbers, not live; seaweed extracts for food; sesame oil; shellfish, not live; shrimps, not live; silkworm chrysalis, for human consumption; snail eggs for consumption; soups; soya beans, preserved, for food; soya milk [milk substitute]; spiny lobsters, not live; suet for food; sunflower oil for food; tahini [sesame seed paste]; toasted laver; tofu; tomato juice for cooking; tomato purée; tripe; truffles, preserved; tuna fish; vegetable salads; vegetables, dried; vegetable soup preparations; vegetables, preserved; vegetables, tinned; whey; whipped cream; white of eggs; yogurt; yolk of eggs.

30 – Coffee, tea, cocoa and artificial coffee; rice; tapioca and sago; flour and preparations made from cereals; bread, pastry and confectionery; ices; sugar; honey, treacle; yeast, baking-powder; salt; mustard; vinegar, sauces (condiments); spices; ice; allspice; almond confectionery; almond paste; aniseed; aromatic preparations for food; artificial coffee; baking soda [bicarbonate of soda for cooking purposes]; barley meal; bean meal; beer vinegar; binding agents for ice cream [edible ices]; biscuits; breadcrumbs; bread rolls; buns; cake paste; cake powder; cakes; candy; capers; caramels [candy]; celery salt; cereal-based snack food; cereal preparations; chewing gum; chicory [coffee substitute]; chips [cereal products]; chocolate; chocolate-based beverages; chocolate beverages with milk; chow-chow [condiment]; chutneys [condiments]; cinnamon [spice]; cloves [spice]; cocoa-based beverages; cocoa beverages with milk; coffee-based beverages; coffee beverages with milk; coffee flavorings [flavourings]; condiments; confectionery for decorating Christmas trees; cooking salt; corn flakes; corn flour; corn, milled; corn, roasted; couscous [semolina]; crackers; crushed barley; crushed oats; curry [spice]; custard; dressings for salad; edible ices; essences for foodstuffs, except etheric essences and essential oils; farinaceous foods; ferments for pastes; flavorings [flavourings], other than essential oils, for beverages; flavorings [flavourings], other than essential oils, for cakes; flavorings, other than essential oils; flour-milling products; fondants [confectionery]; frozen yogurt [confectionery ices]; fruit jellies [confectionery]; garden herbs, preserved [seasonings]; gingerbread; ginger [spice]; glucose for culinary purposes; gluten prepared as foodstuff; golden syrup; groats for human food; gruel, with a milk base, for food; halvah; hominy; hominy grits; husked barley; husked oats; ice cream; iced tea; ice for refreshment; ice, natural or artificial; infusions, not medicinal; ketchup [sauce]; leaven; liquorice [confectionery]; macaroni; macarons [pastry]; malt biscuits; malt extract for food; malt for human consumption; maltose; marinades; marzipan; mayonnaise; meat gravies; meat pies; meat tenderizers, for household purposes; mint for confectionery; molasses for food; muesli; mustard meal; natural sweeteners; noodles; nutmegs; oat-based food; oat flakes; oatmeal; pancakes; pasta; pasta sauce; pastilles [confectionery]; peanut confectionery; pepper; peppermint sweets; peppers [seasonings]; petit-beurre biscuits; petits fours [cakes]; pies; pizzas; popcorn; potato flour for food; powders for ice cream; pralines; preparations for stiffening whipped cream; propolis; puddings; quiches; ravioli; relish [condiment]; rice-based snack food; rice cakes; royal jelly; rusks; saffron [seasoning]; salt for preserving foodstuffs; sandwiches; sauces [condiments]; sausage binding materials; seasonings; sea water for cooking; seaweed [condiment]; semolina; sorbets [ices]; soya bean paste [condiment]; soya flour; soya sauce;

spaghetti; spring rolls; star aniseed; starch for food; stick liquorice [confectionery]; sushi; sweetmeats [candy]; tabbouleh; tacos; tapioca flour for food; tarts; tea-based beverages; thickening agents for cooking foodstuffs; tomato sauce; tortillas; turmeric for food; unleavened bread; unroasted coffee; vanilla [flavoring]; vanillin [vanilla substitute]; vegetal preparations for use as coffee substitutes; vermicelli [noodles]; waffles; wheat flour.

32 – Beers; mineral and aerated waters and other non-alcoholic beverages; fruit beverages and fruit juices; syrups and other preparations for making beverages; aloe vera drinks, non-alcoholic; aperitifs, non-alcoholic; beer wort; cider, non-alcoholic; cocktails, non-alcoholic; essences for making beverages; extracts of hops for making beer; ginger beer; grape must, unfermented; isotonic beverages; kvass [non-alcoholic beverage]; lemonades; lithia water; malt beer; malt wort; milk of almonds [beverage]; must; non-alcoholic fruit extracts; non-alcoholic honey-based beverages; orgeat; pastilles for effervescing beverages; peanut milk [non-alcoholic beverage]; powders for effervescing beverages; preparations for making aerated water; preparations for making beverages; preparations for making liqueurs; preparations for making mineral water; sarsaparilla [non-alcoholic beverage]; seltzer water; sherbets [beverages]; soda water; syrups for beverages; syrups for lemonade; table waters; tomato juice [beverage]; vegetable juices [beverages]; waters [beverages]; whey beverages.

33 – Alcoholic beverages [except beers], namely alcoholic beverages containing fruit; alcoholic beverages, except beer; alcoholic essences; alcoholic extracts; anise [liqueur]; anisette [liqueur]; aperitifs; arrack [arak]; bitters; brandy; cider; curacao; cocktails; digesters [liqueurs and spirits]; distilled beverages; fruit extracts, alcoholic; gin; kirsch; liqueurs; mead [hydromel]; peppermint liqueurs; perry; piquette; rice alcohol; rum; sake; spirits [beverages]; vodka; whisky; wine.

35 – Advertising; business management; business administration; office functions; administrative processing of purchase orders; advertising agencies; advertising by mail order; advisory services for business management; arranging newspaper subscriptions for others; arranging subscriptions to telecommunication services for others; auctioneering; bill-posting; book-keeping; business appraisals; business auditing; business efficiency expert services; business information; business inquiries; business investigations; business management and organization consultancy; business management assistance; business management consultancy; business management of hotels; business management of performing artists; business organization consultancy; business research; commercial administration of the licensing of the goods and services of others; commercial in-

formation agencies; commercial information and advice for consumers [consumer advice shop]; commercial or industrial management assistance; compilation of information into computer databases; compilation of statistics; computerized file management; cost price analysis; data search in computer files for others; demonstration of goods; direct mail advertising; dissemination of advertising matter; distribution of samples; document reproduction; drawing up of statements of accounts; economic forecasting; employment agencies; import-export agencies; invoicing; layout services for advertising purposes; marketing research; marketing studies; modelling for advertising or sales promotion; news clipping services; office machines and equipment rental; on-line advertising on a computer network; opinion polling; organization of exhibitions for commercial or advertising purposes; organization of fashion shows for promotional purposes; organization of trade fairs for commercial or advertising purposes; outsourcing services [business assistance]; payroll preparation; personnel management consultancy; personnel recruitment; photocopying services; presentation of goods on communication media, for retail purposes; price comparison services; procurement services for others [purchasing goods and services for other businesses]; professional business consultancy; psychological testing for the selection of personnel; publication of publicity texts; publicity columns preparation; publicity material rental; public relations; radio advertising; relocation services for businesses; rental of advertising space; rental of advertising time on communication media; rental of photocopying machines; rental of vending machines; sales promotion for others; secretarial services; shop window dressing; sponsorship search; shorthand; systemization of information into computer databases; tax preparation; telephone answering for unavailable subscribers; television advertising; transcription; typing; updating of advertising material; word processing; writing of publicity texts.

43 – Services for providing food and drink; temporary accommodation; accommodation bureaux [hotels, boarding houses]; bar services; boarding for animals; boarding house bookings; boarding houses; cafes; cafeterias; canteens; day-nurseries [crèches]; food and drink catering; holiday camp services [lodging]; hotel reservations; hotels; motels; providing campground facilities; rental of chairs, tables, table linen, glassware; rental of meeting rooms; rental of temporary accommodation; rental of tents; rental of transportable buildings; restaurants; retirement homes; self-service restaurants; snack-bars; temporary accommodation reservations; tourist homes.

(260) AM 2015 75846 A
(800) 1190700
(891) 2013 10 11

(731) KNAUF GIPS KG
Am Bahnhof 7, 97346 Iphofen, Germany
(540)

DRYSTAR

(511)
6 – Metal building materials; framework of metal for building; substructures of metal for building; metal moldings [building].

17 – Semi-processed plastic substances; packing, stopping and insulating materials; insulating plates; insulating plaster; mastics and fillers for sealing and insulating purposes.

19 – Building materials (non-metallic); building panels, not of metal; coatings (building materials); plaster filling agents.

(260) AM 2015 75847 A

(800) 1190708

(891) 2013 09 24

(731) TSN Brands LTD

Geneva Place, Waterfront Drive, P.O. Box
3469, Road Town, Tortola, British Virgin
Islands

(540)

iCREAM

(591) Black, white

(511)

32 – Beer; ginger beer; malt beer; preparations for making liqueurs; beer wort; extracts of hops for making beer.

33 – Aperitifs; arrack [arak]; brandy; wine; piquette; whisky; vodka; kirsch; gin; digesters [liqueurs and spirits]; cocktails; curacao; anise [liqueur]; liqueurs; pre-mixed alcoholic beverages, other than beer-based; alcoholic beverages, except beer; alcoholic beverages containing fruit; spirits [beverages]; distilled beverages; mead [hydromel]; peppermint liqueurs; bitters; rum; sake; perry; cider; rice alcohol; alcoholic extracts; fruit extracts, alcoholic; alcoholic essences.

(260) AM 2015 75848 A

(800) 1190723

(891) 2013 11 07

(731) TAKEDA GMBH

Byk-Gulden-Str. 2, 78467 Konstanz, Germany

(540)

КОЛГАРА

(511)

5 – Pharmaceutical and veterinary preparations; sanitary preparations for medical purposes; dietetic food and substances adapted for medical use; dietary supplements for humans; plasters, materials for dressings; vulnerary sponges for medical or surgical purposes for use on or in the body of humans or

animals; surgical implants (living tissues) made from membranes for use on or in the body of humans or animals; materials for dressings in form of membranes, foils and patches for medical or surgical use on or in the body of humans or animals; vulnerary sponges made from or incorporating collagen for use in human or veterinary medicine or in human or veterinary surgery; surgical implants (living tissues) made from membranes made from or incorporating collagen for use in human or veterinary medicine or in human or veterinary surgery; materials for dressings made from membranes, foils and patches made from or incorporating collagen for use in human or veterinary medicine or in human or veterinary surgery; disinfectants; materials for dressings made from membranes, foils and patches and fleeces for the prevention of postoperative adhesions; surgical resorbable implants (living tissues); supportive surgical and medical plasters for use in skin repair and skin improvement procedures; supportive bandages for use in skin repair and skin improvement procedures; supportive medical compresses for use in skin repair and skin improvement procedures.

10 – Surgical, medical, dental and veterinary apparatus and instruments, artificial limbs, eyes and teeth; orthopedic articles; suture materials; implants made from artificial materials made from membranes, foils, patches and fleeces for surgical and medical use; surgical implants (artificial materials) made from membranes, foils, patches and fleeces for the use in or on the body of humans or animals; artificial skin for surgical purposes for the use on the body of humans or animals; surgical resorbable implants made from artificial materials; supportive surgical and medical compresses for use in skin repair and skin improvement procedures, supportive elastic or orthopedic bandages for use in skin repair and skin improvement procedures; sponges for surgical purposes, all for use on or in the human and non-human body.

(260) AM 2015 75849 A

(800) 1190756

(891) 2013 12 03

(731) INTERNATIONAL TRACTORS LIMITED

Village Chak Gujran, p. o. Piplanwala,
Jalandhar Road, Hoshiarpur (pb) – 148002,
India

(540)



(591) Black, white

(511)

12 – Tractors & parts thereof, motor land vehicles & parts thereof included in this class.

(260) AM 2015 75850 A

(800) 1190797

(891) 2013 07 04

(731) OBSHCHESTVO S OGRANICHENNOY
OTVETSTVENNOSTJU "AESP"

bl. 1, 9, Staromonetny pereulok, RU-109017
Moscow, Russian Federation

(540)

SIGNAMAX™
CONNECTIVITY SYSTEMS

(591) Black, white

(511)

9 – High-frequency apparatus; testing apparatus not for medical purposes; remote control apparatus; electro-dynamic apparatus for the remote control of signals; monitoring apparatus, electric; electric apparatus for commutation; computer memory devices; magnetic tape units for computers; plugs, sockets and other contacts [electric connections]; micrometer screws for optical instruments; circuit closers; terminals [electricity]; switchboxes [electricity]; current rectifiers; optical goods; detectors; floppy disks; disks, magnetic; optical discs; disk drives for computers; juke boxes for computers; electronic notice boards; identification threads for electric wires; locks, electric; acoustic conduits; inverters [electricity]; electric loss indicators; measuring instruments; interfaces for computers; coaxial cables; fibre [fiber (am.)] optic cables; cables, electric; holders for electric coils; coils, electric; electromagnetic coils; solenoid valves [electromagnetic switches]; wire connectors [electricity]; magnetic encoders; collectors, electric; commutators; compact discs [read-only memory]; comparators; computers; notebook computers; laptop computers; capacitors; branch boxes [electricity]; distribution boxes [electricity]; magnetic tapes; microprocessors; junction sleeves for electric cables; surveyors' levels; optical data media; magnetic data media; sheaths for electric cables; identification sheaths for electric wires; limiters [electricity]; switches, electric; wafers for integrated circuits; semi-conductors; circuit breakers; fuses; converters, electric; telerupters; regulating apparatus, electric; precision measuring apparatus; magnetic wires; wires, electric; conductors, electric; copper wire, insulated; fuse wire; computer programmes [programs], recorded; computer game programmes; computer programs [downloadable software]; central processing units [processors]; electronic publications, downloadable; distribution consoles [electricity]; control panels [electricity]; voltage surge protectors; relays, electric; light conducting filaments [optical fibers [fibres]]; optical fibers [fibres]

[light conducting filaments]; connections for electric lines; junction boxes [electricity]; resistances, electric; integrated circuits; printed circuits; transistors [electronic]; step-up transformers; transformers [electricity]; tape recorders; data processing apparatus; couplers [data processing equipment]; readers [data processing equipment]; switchboards; distribution boards [electricity]; ducts [electricity].

37 – Asphaltting; drilling of wells; rebuilding engines that have been worn or partially destroyed; rebuilding machines that have been worn or partially destroyed; retreading of tires [tyres]; vulcanization of tires [tyres] [repair]; building sealing; damp-proofing [building]; linen ironing; pressing of clothing; disinfecting; rat exterminating; mining extraction; knife sharpening; building insulating; repair information; construction information; bricklaying; riveting; varnishing; re-tinning; scaffolding; road paving; car wash; motor vehicle wash; window cleaning; vehicle wash; upholstering; building construction supervision; renovation of clothing; anti-rust treatment for vehicles; strong-room maintenance and repair; vehicle maintenance; paper hanging; wallpapering; painting or repair of signs; cleaning of buildings [exterior surface]; vehicle polishing; rental of road sweeping machines; rental of cleaning machines; rental of construction equipment; rental of cranes [construction equipment]; rental of excavators; rental of bulldozers; plumbing; masonry; roofing services; painting, interior and exterior; underwater repair; cabinet making [repair]; plastering; quarrying services; repair of security locks; umbrella repair; parasol repair; motor vehicle maintenance and repair; burner maintenance and repair; film projector repair and maintenance; airplane maintenance and repair; safe maintenance and repair; clock and watch repair; upholstery repair; pump repair; shoe repair; clothing repair; vehicle breakdown assistance [repair]; photographic apparatus repair; furniture restoration; vehicle greasing; vehicle lubrication; demolition of buildings; warehouse construction and repair; vehicle service stations [refuelling and maintenance]; washing; washing of linen; pipeline construction and maintenance; pier breakwater building; underwater construction; harbour construction; factory construction; building of fair stalls and shops; construction; shipbuilding; cleaning of buildings [interior]; street cleaning; vermin exterminating, other than for agriculture; artificial snow-making services; irrigation devices installation and repair; elevator installation and repair; lift installation and repair; heating equipment installation and repair; burglar alarm installation and repair; furnace installation and repair; telephone installation and repair; air conditioning apparatus installation and repair; fire alarm installation and repair; freezing equipment installation and repair; electric appliance installation and repair; kitchen equipment installation; installation, maintenance and repair of computer hardware;

office machines and equipment installation, maintenance and repair; machinery installation, maintenance and repair; interference suppression in electrical apparatus; furniture maintenance; chimney sweeping; boiler cleaning and repair; cleaning of clothing; dry cleaning; vehicle cleaning; diaper cleaning; leather care, cleaning and repair; fur care, cleaning and repair.

42 – Architecture; graphic art design; technical project studies; engineering; material testing; research and development of new products for others; technical research; calibration [measuring]; architectural consultation; design of interior decor; rental of web servers; construction drafting; styling [industrial design]; surveying.

(260) AM 2015 75853 A
 (800) 1190871
 (891) 2013 11 27
 (731) LIMITED LIABILITY COMPANY
 "VIKTORIYA"
 Pobedy Street, 102, RU-352630 Belorechensk,
 Krasnodarskiy Krai, Russian Federation
 (540)



(591) Black, white
 (511)
 30 – Sponge dough products, namely, sponge cake roll, sponge layer cake, sponge plum cake, sponge pie, sponge dough discs.

(260) AM 2015 75854 A
 (800) 1190896
 (891) 2013 12 02
 (731) PUBLIC JOINT-STOCK COMPANY (PJSC)
 KUPYANSK MILK CANNING COMBINAT
 vul. Lomonosova, 26, m. Kupyansk,
 Kharkivska oblast 63702, Ukraine
 (540)



(591) Pink, white, purple, black and gray
 (511)
 29 – Milk; milk products; condensed milk; whipped cream; cream [dairy products]; yoghurt; cocoa butter; kephir [milk beverage]; curd; margarine; butter; chocolate nut butter; buttercream; milk beverages, milk predominating; cheese; whey; rennet; soya milk [milk substitute].

(260) AM 2015 75855 A
 (800) 1190902
 (891) 2013 11 22
 (731) LIMITED LIABILITY COMPANY
 "PREMIUM STYLE"
 Magistralny tupik 1st, d. 5a, RU-123290,
 Moscow, Russian Federation
 (540)

ДЖЕМВИЛЬ DJEMVILLE

(511)
 29 – Jams; jellies for food; fruit jellies; fruit-based snack food; compotes; fruits, tinned; marmalade; fruit pulp; cranberry sauce [compote]; apple puree; fruit salads; crystallized fruits; fruit, preserved; fruit, stewed; fruit peel.

(260) AM 2015 75856 A
 (800) 481049
 (891) 2013 12 19
 (731) ASTELLAS PHARMA EUROPE B.V.
 Sylviusweg 62, NL-2333 BE Leiden,
 Netherlands
 (540)

LOCOBASE

(511)
 5 – Medicines and pharmaceutical products; ointment bases.

(260) AM 2015 75857 A
 (800) 637535
 (891) 2013 12 19
 (731) ASTELLAS PHARMA EUROPE B.V.
 Sylviusweg 62, NL-2333 BE Leiden,
 Netherlands
 (540)

ФЛЕМОКСИН СОЛЮТАБ

(511)
 5 – Pharmaceutical preparations and substances for human use.

(260) AM 2015 75858 A
 (800) 694822
 (891) 2013 10 30
 (731) RENATA FILIPOVA
 Petrinska 10, CZ-150 00 Prague 5, Czech
 Republic
 (540)

ATLASPROFILAX

(511)
 42 – Physical therapy, health care, chiropractic, preventive health care for maintaining good health, manipulation and massage, rehabilitation.

(260) AM 2015 75859 A
 (800) 794860
 (891) 2013 06 25
 (731) PHILIPP PLEIN
 Säntisstraße 5, CH-8580 Amriswil, Switzerland
 (540)

Philipp Plein

(511)
 3 – Perfumery, cosmetics.
 14 – Horological instruments.
 18 – Leather and imitations of leather, and goods made of these materials.
 20 – Furniture, in particular for homes and kitchens.
 21 – Household or kitchen utensils and containers.
 24 – Textiles and textile products.
 25 – Clothing, footwear.
 28 – Gymnastic and sporting apparatus.

(260) AM 2015 75861 A
 (800) 852272
 (891) 2013 10 31
 (731) CONSITEX S.A.
 Via Ligornetto 13, CH-6855 Stabio, Switzerland
 (540)

ERMENEGILDO ZEGNA

(511)
 9 – Spectacles, spectacle settings, prescription glasses and lenses, sunglasses and protective goggles and eyeshades, articles for spectacles and optical articles, spare parts and parts of the above articles, pince-nez, pince-nez mountings, lens for pince-nez, equipment for pince-nez and spectacles, boxes and cases for spectacles and pince-nez.
 14 – Jewellery, precious stones, cuff links and tie pins, horological and chronometric instruments.

(260) AM 2015 75862 A
 (800) 913597
 (891) 2013 06 24
 (731) ODE YALITIM SANAYİ VE TİCARET ANONİM ŞİRKETİ
 Piyalepaşa Ortadoğu İş Merkezi K:12, Şişli İstanbul, Turkey
 (540)



(591) Orange, white and black
 (511)
 17 – Fibreglass for insulation, flexible tubes, insulating materials, insulating tape and band, insulators,

pipes, synthetic rubber, elastic yarns, waterproof packings, glass wool, mineral wool.

(260) AM 2015 75863 A
 (800) 946603
 (891) 2013 10 22
 (731) VINISTA GMBH
 Oberneuhofstrasse 5, CH-6340 Baar, Switzerland
 (540)

KALASCHNIKOW

(511)
 32 – Beers; mineral and aerated waters and other non-alcoholic drinks; fruit drinks and fruit juices; syrups and other preparations for making beverages.

(260) AM 2015 75864 A
 (800) 1027206
 (891) 2013 12 31
 (731) SMARTWARES SAFETY & LIGHTING B.V.
 Broekakkerweg 15, NL-5126 BD GILZE, Netherlands
 (540)

RANEX

(511)
 9 – Electrical and electronic apparatus and instruments for recording, transmission and reproduction of sound or images; apparatus and instruments for conducting, distribution, transforming, accumulating, regulating and sending electricity; intercommunication apparatus, baby intercoms, alarm systems and their components (not included in other classes); clock thermostats and time switches (automatic); electrical switching material.

11 – Apparatus and instruments for lighting and their components, also for indoor and outdoor lighting; lamps for lighting.

(260) AM 2015 75887 A
 (800) 1133985
 (891) 2013 12 16
 (731) NOVARTIS AG
 CH-4002 Basel, Switzerland
 (540)

CHYLOTREZ

(511)
 5 – Pharmaceutical preparations.

(260) AM 2015 75896 A
 (800) 1190926
 (891) 2013 07 11
 (731) TENSAR TECHNOLOGIES LIMITED
 Sett End Road, Shadsworth Business Park, Shadsworth, Blackburn BB1 2PU, United Kingdom

(540)

TENSAR

(511)

17 – Plastics materials in the form of sheets (non-textile), blocks and of rods, all for use in manufacture.

19 – Civil engineering construction and building materials made wholly or principally of plastics.

(260) AM 2015 75897 A

(800) 1190932

(891) 2013 08 09

(731) HYUNDAI MOTOR COMPANY

231, Yangjae-Dong, Seocho-Gu, Seoul

137-938, Republic of Korea

(540)

EQUUS

(591) Black, white

(511)

12 – Passenger cars [automobiles]; lorries; buses; ambulances; dump cars; racing cars; cycles; air bags [safety devices for automobiles]; bicycles; tires for vehicle wheels; rubber belts for land vehicles; grill guards for land vehicles; constant velocity joints for land vehicles; rearview mirrors for automobiles; wood grains for automobiles; sun visors for automobiles; anti-skid chains for automobiles; wiper blades for automobiles; covers for automobile's body; console boxes of trunks for automobiles; room mirrors for automobiles.

(260) AM 2015 75898 A

(800) 1190950

(891) 2013 11 11

(731) EGIS GYÓGYSZERGYÁR ZRT.

Keresztúri út 30-38, H-1106 Budapest, Hungary

(540)

SOLFEGIS

(511)

5 – Pharmaceutical preparations for human use.

(260) AM 2015 75899 A

(800) 1190973

(891) 2013 06 27

(731) IRSAP SPA

VIA DELLE INDUSTRIE, 211, I-45031

ARQUA' POLESINE, Italy

(540)

CREATING YOUR COMFORT

(511)

9 – Electronic units for controlling and regulating heating and air-conditioning apparatus; thermostats.

11 – Apparatus for heating, refrigerating and air-conditioning; radiators; air conditioners; apparatus for steam generating; dehumidifiers; electric heaters.

(260) AM 2015 75900 A

(800) 1190978

(891) 2013 07 24

(731) A3 SPORT s.r.o.

Teslova 1171/15, CZ-301 00 Plzeň, Czech

Republic

(540)

A3 SPORT

(591) Black, white

(511)

35 – Purchase and sale of shoes, clothing and clothing accessories, trading (including mail and electronic form) with footwear, clothing and clothing accessories.

(260) AM 2015 75903 A

(800) 1191028

(891) 2013 11 07

(731) LIMITED LIABILITY COMPANY

"KENEKSI"

str. 1, Ryazansky prospect, d. 8A, RU-109428

Moscow, Russian Federation

(540)

KENEKSI

(591) Black, white

(511)

9 – Scientific, nautical, surveying, photographic, cinematographic, optical, weighing, measuring, signalling, checking [supervision], life-saving and teaching apparatus and instruments; apparatus and instruments for conducting, switching, transforming, accumulating, regulating or controlling electricity; apparatus for recording, transmission or reproduction of sound or images; magnetic data carriers, recording discs; compact discs, DVDs and other digital recording media; mechanisms for coin-operated apparatus; cash registers, calculating machines, data processing equipment, computers; computer software; fire-extinguishing apparatus; DVD players; ticket dispensers; juke boxes, musical; answering machines; fire engines; accumulators, electric; accumulators, electric, for vehicles; actinometers; alidades; altimeters; ammeters; anemometers; anodes; antennas; anticathodes; apertometers [optics]; high-frequency apparatus; testing apparatus not for medical purposes; remote control apparatus; electrodynamic apparatus for the remote control of railway points; electro-dynamic apparatus for the remote control of signals; monitoring apparatus, electric; sound recording apparatus; global positioning system [GPS] apparatus; distillation apparatus for scientific purposes; diffusion apparatus [microscopy]; air analysis appara-

tus; apparatus to check stamping mail; sound transmitting apparatus; apparatus for fermentation [laboratory apparatus]; breathing apparatus for underwater swimming; breathing apparatus, except for artificial respiration; apparatus and installations for the production of x-rays, not for medical purposes; cash registers; electric apparatus for commutation; intercommunication apparatus; stills for laboratory experiments; projection apparatus; radiological apparatus for industrial purposes; x-ray apparatus not for medical purposes; blueprint apparatus; blinkers [signalling lights]; stereoscopic apparatus; telephone apparatus; facsimile machines; phototelegraphy apparatus; electric apparatus for remote ignition; acid hydrometers; salinometers; acidimeters for batteries; aerometers; beacons, luminous; accumulator jars; barometers; anode batteries; galvanic batteries; batteries for lighting; solar batteries; batteries, electric; lever scales [steelyards]; betatrons; binoculars; electronic tags for goods; lens hoods; magnetic tape units for computers; computer memory devices; fire hose nozzles; encoded identification bracelets, magnetic; safety tarpaulins; signalling buoys; life buoys; marking buoys; directional compasses; vacuum gauges; electrolyzers; variometers; verniers; scales; letter scales; weighbridges; precision balances; levelling staffs [surveying instruments]; camcorders; video cassettes; video telephones; video screens; viewfinders, photographic; plugs, sockets and other contacts [electric connections]; micrometer screws for optical instruments; viscosimeters; circuit closers; wavemeters; voltmeters; switchboxes [electricity]; current rectifiers; gas testing instruments; gasometers [measuring instruments]; galvanometers; hands free kits for phones; heliographic apparatus; hygrometers; hydrometers; weights; peepholes [magnifying lenses] for doors; holograms; plotters; loudspeakers; sounding leads; plumb bobs; telemeters; densimeters; densitometers; optical goods; detectors; smoke detectors; false coin detectors; transparencies [photography]; slide projectors; diaphragms [photography]; dictating machines; dynamometers; light-emitting diodes [led]; floppy disks; sound recording discs; disks, magnetic; optical discs; calculating disks; disk drives for computers; juke boxes for computers; dna chips; electronic notice boards; bullet-proof waistcoats; life jackets; identification threads for electric wires; nose clips for divers and swimmers; locks, electric; bells [warning devices]; alarm bells, electric; electric door bells; signal bells; acoustic conduits; mirrors for inspecting work; road signs, luminous or mechanical; mechanical signs; signs, luminous; marine depth finders; probes for scientific purposes; buzzers; needles for record players; measures; pressure measuring apparatus; simulators for the steering and control of vehicles; inverters [electricity]; pressure indicators; temperature indicators; temperature indicator labels, not for medical purposes; incubators for bacteria culture; me-

asuring instruments; cosmographic instruments; mathematical instruments; levelling instruments; instruments containing eyepieces; surveying instruments; azimuth instruments; interfaces for computers; ionization apparatus not for the treatment of air or water; spark-guards; coaxial cables; fibre [fiber (Am.)] optic cables; cables, electric; calipers; slide calipers; screw-tapping gauges; calculating machines; pocket calculators; decompression chambers; cinematographic cameras; electronic pens [visual display units]; holders for electric coils; identity cards, magnetic; video game cartridges; encoded magnetic cards; riding helmets; protective helmets; carriers for dark plates [photography]; automated teller machines [ATM]; cathodes; spools [photography]; choking coils [impedance]; coils, electric; electromagnetic coils; cinematographic film, exposed; computer keyboards; solenoid valves [electromagnetic switches]; wire connectors [electricity]; electronic agendas; push buttons for bells; mouse pads; magnetic encoders; anti-glare visors; collectors, electric; calibrating rings; protective suits for aviators; commutators; compact discs [audio-video]; compact discs [read-only memory]; comparators; marine compasses; computers; laptop computers; notebook computers; capacitors; contacts, electric; wind socks for indicating wind direction; branch boxes [electricity]; distribution boxes [electricity]; junction boxes [electricity]; accumulator boxes; cabinets for loudspeakers; diving suits; garments for protection against fire; galena crystals [detectors]; reflecting discs for wear, for the prevention of traffic accidents; covers for electric outlets; logs [measuring instruments]; lasers, not for medical purposes; lactodensimeters; lactometers; vacuum tubes [radio]; darkroom lamps [photography]; thermionic tubes; amplifying tubes; flashlights [photography]; head cleaning tapes [recording]; magnetic tapes; videotapes; surveying chains; fire escapes; rulers [measuring instruments]; slide-rules; contact lenses; correcting lenses [optics]; optical lenses; optical condensers; sounding lines; electricity conduits; measuring spoons; magnifying glasses [optics]; waling glasses; magnets; decorative magnets; crash test dummies; resuscitation mannequins [teaching apparatus]; mouse [data processing equipment]; manometers; divers' masks; solderers' helmets; protective masks; materials for electricity mains [wires, cables]; voting machines; money counting and sorting machines; material testing instruments and machines; furniture especially made for laboratories; megaphones; portable media players; diaphragms [acoustics]; diaphragms for scientific apparatus; metal detectors for industrial or military purposes; metronomes; rules [measuring instruments]; carpenters' rules; dressmakers' measures; mechanisms for counter-operated apparatus; coin-operated mechanisms for television sets; shutter releases [photography]; micrometers; microscopes; microtomes; micropho-

nes; modems; lightning arresters; monitors [computer hardware]; monitors [computer programs]; terminals [electricity]; junction sleeves for electric cables; cases fitted with dissecting instruments [microscopy]; teeth protectors; knee-pads for workers; headphones; surveyors' levels; sound recording carriers; magnetic data media; optical data media; socks, electrically heated; computer software, recorded; sheaths for electric cables; identification sheaths for electric wires; weighing machines; punched card machines for offices; life saving apparatus and equipment; shoes for protection against accidents, irradiation and fire; objectives [lenses] [optics]; lenses for astrophotography; egg-candlers; fire extinguishers; electrified fences; limiters [electricity]; clothing for protection against accidents, irradiation and fire; clothing for protection against fire; asbestos clothing for protection against fire; clothing especially made for laboratories; ozonisers [ozonators]; octants; eyepieces; ohmmeters; wrist rests for use with computers; spectacle frames; pince-nez mountings; oscillographs; plumb lines; mirrors [optics]; spectacles [optics]; sunglasses; goggles for sports; signalling panels, luminous or mechanical; radio pagers; pince-nez; electronic pocket translators; transmitters [telecommunication]; telephone transmitters; transmitters of electronic signals; switches, electric; periscopes; gloves for divers; gloves for protection against accidents; gloves for protection against x-rays for industrial purposes; asbestos gloves for protection against accidents; furnaces for laboratory use; pipettes; pyrometers; planimeters; plane tables [surveying instruments]; plates for batteries; wafers for integrated circuits; printed circuit boards; compact disc players; cassette players; sound recording strips; x-ray films, exposed; films, exposed; life-saving rafts; laboratory trays; semiconductors; polarimeters; fire pumps; graduated glassware; life belts; fuses; circuit breakers; converters, electric; telerupters; food analysis apparatus; diagnostic apparatus, not for medical purposes; apparatus for recording distance; distance measuring apparatus; speed measuring apparatus [photography]; appliances for measuring the thickness of leather; apparatus for measuring the thickness of skins; speed checking apparatus for vehicles; teaching apparatus; time recording apparatus; hemline markers; apparatus and instruments for astronomy; surveying apparatus and instruments; weighing apparatus and instruments; nautical apparatus and instruments; navigational instruments; optical apparatus and instruments; apparatus and instruments for physics; chemistry apparatus and instruments; measuring apparatus; measuring devices, electric; boiler control instruments; meteorological instruments; naval signalling apparatus; observation instruments; navigation apparatus for vehicles [on-board computers]; satellite navigational apparatus; regulating apparatus, electric; precision measuring apparatus; audio

and video receivers; prisms [optics]; printers for use with computers; retorts' stands; apparatus for changing record player needles; drainers for use in photography; cleaning apparatus for phonograph records; fire beaters; sighting telescopes for firearms; test tubes; pressure indicator plugs for valves; magnetic wires; telegraph wires; telephone wires; wires, electric; conductors, electric; copper wire, insulated; wires of metal alloys [fuse wire]; computer programmes [programs], recorded; computer game programs; computer programs [downloadable software]; computer operating programs, recorded; record players; processors [central processing units]; rods for water diviners; electronic publications, downloadable; distribution consoles [electricity]; control panels [electricity]; radar apparatus; masts for wireless aerials; transmitting sets [telecommunication]; radios; vehicle radios; sprinkler systems for fire protection; frames for photographic transparencies; screens for photoengraving; walkie-talkies; voltage surge protectors; voltage regulators for vehicles; stage lighting regulators; light dimmers [regulators], electric; speed regulators for record players; reducers [electricity]; washing trays [photography]; marking gauges [joinery]; time switches, automatic; relays, electric; safety restraints, other than for vehicle seats and sports equipment; x-ray photographs, other than for medical purposes; rheostats; respirators for filtering air; respirators, other than for artificial respiration; retorts; refractometers; refractors; grids for batteries; speaking tubes; horns for loudspeakers; saccharometers; light conducting filaments [optical fibers [fibres]]; traffic-light apparatus [signalling devices]; dog whistles; signalling whistles; sextants; inductors [electricity]; safety nets; nets for protection against accidents; fire alarms; signals, luminous or mechanical; sirens; scanners [data processing equipment]; smart cards [integrated circuit cards]; connections for electric lines; connections, electric; connectors [electricity]; sonars; sound locating instruments; lighting ballasts; resistances, electric; spectrograph apparatus; spectroscopes; speed indicators; alcoholmeters; satellites for scientific purposes; protection devices for personal use against accidents; audiovisual teaching apparatus; radiotelegraphy sets; radiotelephony sets; spectacle lenses; glass covered with an electrical conductor; antiglare glasses; optical glass; personal stereos; stereoscopes; stands for photographic apparatus; fire boats; sulphitometers; bags adapted for laptops; drying racks [photography]; spherometers; integrated circuits; printed circuits; counters; parking meters; milage recorders for vehicles; revolution counters; abacuses; egg timers [sandglasses]; taximeters; ear plugs for divers; tachometers; television apparatus; telegraphs [apparatus]; telescopes; teleprompters; teletypewriters; portable telephones; theodolites; thermometers, not for medical purposes; thermostats; thermostats for vehicles; crucibles [laboratory];

tone arms for record players; totalizers; transistors [electronic]; transponders; protractors [measuring instruments]; transformers [electricity]; step-up transformers; vehicle breakdown warning triangles; triodes; starter cables for motors; electric discharge tubes, other than for lighting; capillary tubes; neon signs; x-ray tubes not for medical purposes; telephone receivers; gauges; quantity indicators; automatic indicators of low pressure in vehicle tires; petrol gauges; water level indicators; electric loss indicators; light-emitting electronic pointers; inclinometers; levels [instruments for determining the horizontal]; mercury levels; spirit levels; urinometers; amplifiers; particle accelerators; electric installations for the remote control of industrial operations; steering apparatus, automatic, for vehicles; balancing apparatus; video recorders; sound reproduction apparatus; invoicing machines; tape recorders; protection devices against x-rays, not for medical purposes; railway traffic safety appliances; data processing apparatus; oxygen transvasing apparatus; theft prevention installations, electric; film cutting apparatus; drying apparatus for photographic prints; optical character readers; centering apparatus for photographic transparencies; dosage dispensers; battery chargers; chargers for electric batteries; sound alarms; sounding apparatus and machines; editing appliances for cinematographic films; cathodic anti-corrosion apparatus; couplers [data processing equipment]; anti-theft warning apparatus; computer peripheral devices; anti-interference devices [electricity]; demagnetizing apparatus for magnetic tapes; acoustic couplers; alarms; fog signals, non-explosive; whistle alarms; adding machines; readers [data processing equipment]; heat regulating apparatus; photocopiers [photographic, electrostatic, thermic]; bar code readers; downloadable ring tones for mobile phones; downloadable image files; downloadable music files; animated cartoons; filters [photography]; filters for respiratory masks; filters for ultraviolet rays, for photography; usb flash drives; magic lanterns; optical lanterns; signal lanterns; cameras [photography]; glazing apparatus for photographic prints; shutters [photography]; darkrooms [photography]; photometers; flash-bulbs [photography]; enlarging apparatus [photography]; photovoltaic cells; containers for contact lenses; spectacle cases; pince-nez cases; containers for microscope slides; cases especially made for photographic apparatus and instruments; chromatography apparatus for laboratory use; chronographs [time recording apparatus]; laboratory centrifuges; pince-nez chains; cyclotrons; compasses [measuring instruments]; frequency meters; time clocks [time recording devices]; fire blankets; chips [integrated circuits]; jigs [measuring instruments]; pedometers; meteorological balloons; electrified rails for mounting spot lights; asbestos screens for firemen; fire hose; protective helmets for sports; cell phone straps; pince-nez cords; tripods for

cameras; switchboards; distribution boards [electricity]; screens [photography]; workmen's protective face-shields; projection screens; radiology screens for industrial purposes; fluorescent screens; exposure meters [light meters]; ducts [electricity]; galvanic cells; epidiascopes; ergometers; armatures [electricity].

18 – Leather and imitations of leather, and goods made of these materials and not included in other classes; animal skins, hides; trunks and travelling bags; umbrellas and parasols; walking sticks; whips, harness and saddlery; alpenstocks; pocket wallets; card cases [notecases]; reins; harness fittings; chamois leather, other than for cleaning purposes; umbrellas; parasols; saddlery; frames for umbrellas or parasols; handbag frames; cases, of leather or leatherboard; valves of leather; whips; imitation leather; leather, unworked or semi-worked; leatherboard; casings, of leather, for plate springs; umbrella rings; hat boxes of leather; boxes of leather or leather board; boxes of vulcanised fibre; chain mesh purses; purses; fastenings for saddles; butts [parts of hides]; saddle trees; bags [envelopes, pouches] of leather, for packaging; moleskin [imitation of leather]; travelling sets [leatherware]; knee-pads for horses; muzzles; halters; vanity cases, not fitted; leather thread; furniture coverings of leather; gut for making sausages; clothing for pets; trimmings of leather for furniture; collars for animals; music cases; slings for carrying infants; gold beaters' skin; cat o' nine tails; leather leads; pads for horse saddles; horseshoes; girths of leather; coverings of skins [furs]; horse blankets; leather shoulder belts; briefcases; traces [harness]; fur; haversacks; leather straps; straps for soldiers' equipment; harness straps; straps for skates; straps of leather [saddlery]; chin straps, of leather; stirrup leathers; umbrella handles; walking stick handles; suitcase handles; backpacks; travelling bags; riding saddles; net bags for shopping; umbrella or parasol ribs; stirrups; bags; bags for climbers; sling bags for carrying infants; garment bags for travel; valises; handbags; tool bags of leather, empty; beach bags; bags for sports; bags for campers; shopping bags; wheeled shopping bags; school bags; pouch baby carriers; travelling trunks; nose bags [feed bags]; bridoons; umbrella sticks; walking stick seats; bits for animals [harness]; bridles [harness]; harness for animals; key cases; horse collars; trunks [luggage]; suitcases; attaché cases; covers for horse-saddles; umbrella covers; kid; curried skins; animal skins; cattle skins; leather laces; blinders [harness]; game bags [hunting accessories].

35 – Advertising; business management; business administration; office functions; arranging subscriptions to telecommunication services for others; import-export agencies; commercial information agencies; advertising agencies; cost price analysis; rental of advertising space; business auditing; employment

agencies; computerized file management; accounting; invoicing; demonstration of goods; transcription; opinion polling; marketing studies; business information; commercial information and advice for consumers [consumer advice shop]; business investigations; business research; marketing research; personnel recruitment; business management and organization consultancy; business organization consultancy; business management consultancy; personnel management consultancy; professional business consultancy; layout services for advertising purposes; marketing; business management of performing artists; business management of sports people; news clipping services; updating of advertising material; word processing; organization of exhibitions for commercial or advertising purposes; arranging newspaper subscriptions for others; organization of fashion shows for promotional purposes; organization of trade fairs for commercial or advertising purposes; shop window dressing; business appraisals; payroll preparation; data search in computer files for others; sponsorship search; business management assistance; commercial or industrial management assistance; presentation of goods on communication media, for retail purposes; economic forecasting; auctioneering; sales promotion for others; production of advertising films; office machines and equipment rental; rental of advertising time on communication media; publicity material rental; rental of vending machines; rental of photocopying machines; publication of publicity texts; radio commercials; outdoor advertising; distribution of samples; dissemination of advertising matter; direct mail advertising; writing of publicity texts; on-line advertising on a computer network; advertising by mail order; television advertising; document reproduction; compilation of statistics; compilation of information into computer databases; business inquiries; systemization of information into computer databases; advisory services for business management; tax preparation; drawing up of statements of accounts; publicity columns preparation; telemarketing services; psychological testing for the selection of personnel; business management of hotels; commercial administration of the licensing of the goods and services of others; administrative processing of purchase orders; public relations; modelling for advertising or sales promotion; typing; relocation services for businesses; price comparison services; secretarial services; procurement services for others [purchasing goods and services for other businesses]; shorthand; outsourcing services [business assistance]; telephone answering for unavailable subscribers; photocopying services; business efficiency expert services.

(260) AM 2015 75904 A
 (800) 1191034
 (891) 2013 11 19
 (731) LEIVANKASH JEWELLERY LLP

C/o Adams Mitchell, 109 Gloucester Place,
 London W1U 6JW, United Kingdom
 (540)

LeiVanKash

(511)
 14 – Jewellery, fashion jewellery, precious and semi-precious jewellery.

(260) AM 2015 75911 A
 (800) 1191049
 (891) 2013 10 24
 (731) SIGMA-TAU INDUSTRIE
 FARMACEUTICHE RIUNITE S.p.A.
 Viale Shakespeare, 47, I-00144 ROMA, Italy
 (540)

EURARTESIM

(511)
 5 – Pharmaceutical and veterinary preparations; sanitary preparations for medical purposes; dietetic substances adapted for medical use, food for babies; plasters, materials for dressings; material for stopping teeth, dental wax; disinfectants; preparations for destroying vermin; fungicides, herbicides.

(260) AM 2015 75912 A
 (800) 1191050
 (891) 2013 11 18
 (731) ROBERTO CAVALLI S.P.A.
 Piazza San Babila, 3, I-20122 MILANO,
 Italy
 (540)

Justcavalli

(591) Black, white
 (511)
 35 – Advertising; business management; business administration; office functions; dissemination of advertisements; dissemination of advertising matter; rental of advertising spaces; commercial or industrial business management consultancy and assistance; professional business consultancy; modeling for advertising or business promotion; franchising, namely services provided by a franchisor in helping, managing and developing commercial enterprises (services for third parties); the bringing together, for the benefit of others, of a variety of goods enabling customers to conveniently view and purchase those goods in retail stores.

(260) AM 2015 75964 A
 (800) 1018126
 (891) 2013 11 07
 (731) Reckitt Benckiser N.V.
 Siriusdreef 14, NL-2132 WT Hoofddorp,
 Netherlands

(540)

CILLIT BANG

(511)

3 – Bleaching preparations; cleaning, polishing, scouring and abrasive preparations; detergents; soaps; decalcifying and descaling preparations for household purposes; limescale removers, rust removers, stain removers, grease removers; drain and sink unblocking preparations; preparations for prevention of limescale, rust or grease; fabric softeners; laundry additives; all aforementioned goods with or without a disinfective component.

(260) AM 2015 75966 A

(800) 1121627

(891) 2013 12 23

(731) BIOFARMA

50 rue Carnot, F-92284 SURESNES
CEDEX, France

(540)

PROALTA

(511)

5 – Pharmaceutical, biopharmaceutical and veterinary preparations; sanitary preparations for medical purposes; dietetic substances adapted for medical use, food for babies; teeth filling materials and dental impression materials; disinfectants; adjuvants for medical purposes; antiseptics; medicines for human purposes; medicines for veterinary purposes; medicines for dental purposes; eye-wash; bacterial poisons; bacteriological preparations for medical and veterinary use; biological preparations for medical purposes; biological preparations for veterinary purposes; chemico-pharmaceutical preparations; chemical preparations for medical purposes, chemical preparations for pharmaceutical purposes; chemical preparations for veterinary purposes; chemical reagents for medical or veterinary purposes; disinfectants for hygiene purposes; diagnostic preparations for medical purposes; dietetic substances adapted for medical use; dietetic foods adapted for medical purposes; albuminous preparations for medical purposes; elixirs (pharmaceutical preparations); fodder supplements for veterinary purposes; in vitro diagnostic preparations for medical purposes; capsules for medicines; chewing gum for medical purposes; germicides; lotions for pharmaceutical purposes; lotions for veterinary purposes; mouthwashes for medical purposes; nutritional additives for medical purposes; pharmaceutical preparations; pharmaceutical preparations for skin care; sterilising preparations; ointments for pharmaceutical purposes; veterinary preparations.

(260) AM 2015 75967 A

(800) 1133426

(891) 2013 12 30

(731) 5.11, INC.

4300 Spyres Way, Modesto, CA 95356, USA

(540)



(591) Black, white

(511)

11 – Flashlights.

(260) AM 2015 75969 A

(800) 1161913

(891) 2014 01 07

(731) ARES TRADING S.A.

Zone Industrielle de l'Ouriettaz, CH-1170
Aubonne, Switzerland

(540)

REMBURT

(511) 05 – Pharmaceutical products for human use; dietetic substances, namely medical substances.

(260) AM 2015 75976 A

(800) 1191682

(891) 2013 12 16

(731) PEPSICO, INC.

700 Anderson Hill Road, Purchase NY 10577,
USA

(540)



(591) Red, white and blue

(511)

32 – Soft drinks.

(260) AM 2015 75977 A

(800) 1191683

(891) 2013 12 16

(731) PEPSICO, INC.

700 Anderson Hill Road, Purchase NY 10577,
USA

(540)



(591) Red, white and blue
(511)
32 – Soft drinks.

(260) AM 2015 75983 A

(800) 1191869

(891) 2013 08 09

(731) AKTSIONERNO DROUJESTVO
"BULGARTABAC-HOLDING"
"Graf Ignatiev" Str. 62, BG-1000 SOFIA,
Bulgaria

(540)

TY 134

(511)

16 – Paper, cardboard and goods made from these materials, not included in other classes; printed matter; photographs; plastic materials for packaging (not included in other classes); paper and cardboard packages, especially cigarette packages; boxes of cardboard or paper; wrappings and packages (stationery); packing paper, cigar bands; stationery; forms (printed); pamphlets: writing pads; placards of paper or cardboard; posters; decalcomanias; labels, not of textile; calendars; catalogues; folders (stationery); files (office requisites); bags (envelopes, pouches) of paper or plastics, for packaging.

34 – Tobacco; smokers' articles; matches; cigarettes; cigars; cigarillos; lighters for smokers; tobacco-raw, manipulated or processed; tobacco products; cigarette filters; cigarette paper; ashtrays for smokers.

35 – Advertising; business management; business administration; office functions; publication of publicity texts; radio advertising; advertising through posters; distribution of samples, models, patterns; dissemination of advertising matters; sales advertising; advertising agencies; TV advertisements; administrative activities and services for management of domestic and international commercial transactions; consultations connected with the business management; marketing surveys and researches; consulting services for business management; management of business or industrial enterprises assistance; support in business management; organization of exhibitions and fairs with commercial and advertising purposes; outdoor advertising with bill boards; advertising services using outdoor posters, advertising panel and wall surfaces; demonstration of goods; preparation and publishing of advertisements through printed, audio, video, radio, television and electronic media; advertising through the global computer network; actualization of advertisement matters; import-export agencies.

(260) AM 2015 75984 A

(800) 1191871

(891) 2013 08 09

(731) AKTSIONERNO DROUJESTVO
"BULGARTABAC-HOLDING"
"Graf Ignatiev" Str. 62, BG-1000 SOFIA,
Bulgaria

(540)

СТЮАРДЕСА

(511)

16 – Paper, cardboard and goods made from these materials, not included in other classes; printed matter; photographs; plastic materials for packaging (not included in other classes); paper and cardboard packages, especially cigarette packages; boxes of cardboard or paper; wrappings and packages (stationery); packing paper, cigar bands; stationery; forms (printed); pamphlets: writing pads; placards of paper or cardboard; posters; decalcomanias; labels, not of textile; calendars; catalogues; folders (stationery); files (office requisites); bags (envelopes, pouches) of paper or plastics, for packaging.

34 – Tobacco; smokers' articles; matches; cigarettes; cigars; cigarillos; lighters for smokers; tobacco-raw, manipulated or processed; tobacco products; cigarette filters; cigarette paper; ashtrays for smokers.

35 – Advertising; business management; business administration; office functions; publication of publicity texts; radio advertising; advertising through posters; distribution of samples, models, patterns; dissemination of advertising matters; sales advertising; advertising agencies; TV advertisements; administrative activities and services for management of domestic and international commercial transactions; consultations connected with the business management; marketing surveys and researches; consulting services for business management; management of business or industrial enterprises assistance; support in business management; organization of exhibitions and fairs with commercial and advertising purposes; outdoor advertising with bill boards; advertising services using outdoor posters, advertising panel and wall surfaces; demonstration of goods; preparation and publishing of advertisements through printed, audio, video, radio, television and electronic media; advertising through the global computer network; actualization of advertisement matters; import-export agencies.

(260) AM 2015 75985 A

(800) 1191872

(891) 2013 08 09

(731) AKTSIONERNO DROUJESTVO
"BULGARTABAC-HOLDING"
"Graf Ignatiev" Str. 62, BG-1000 SOFIA,
Bulgaria

(540)

BT

(511)

16 – Paper, cardboard and goods made from these materials, not included in other classes; printed matter; photographs; plastic materials for packaging (not included in other classes); paper and cardboard packages, especially cigarette packages; boxes of cardboard or paper; wrappings and packages (stationery); packing paper, cigar bands; stationery; forms (printed); pamphlets: writing pads; placards of paper or cardboard; posters; decalcomanias; labels, not of textile; calendars; catalogues; folders (stationery); files (office requisites); bags (envelopes, pouches) of paper or plastics, for packaging.

34 – Tobacco; smokers' articles; matches; cigarettes; cigars; cigarillos; lighters for smokers; tobacco-raw, manipulated or processed; tobacco products; cigarette filters; cigarette paper; ashtrays for smokers.

35 – Advertising; business management; business administration; office functions; publication of publicity texts; radio advertising; advertising through posters; distribution of samples, models, patterns; dissemination of advertising matters; sales advertising; advertising agencies; TV advertisements; administrative activities and services for management of domestic and international commercial transactions; consultations connected with the business management; marketing surveys and researches; consulting services for business management; management of business or industrial enterprises assistance; support in business management; organization of exhibitions and fairs with commercial and advertising purposes; outdoor advertising with bill boards; advertising services using outdoor posters, advertising panel and wall surfaces; demonstration of goods; preparation and publishing of advertisements through printed, audio, video, radio, television and electronic media; advertising through the global computer network; actualization of advertisement matters; import-export agencies.

(260) AM 2015 75986 A

(800) 1191873

(891) 2013 08 09

(731) AKTSIONERNO DROUJESTVO

"BULGARTABAC-HOLDING"

"Graf Ignatiev" Str. 62, BG-1000 SOFIA,

Bulgaria

(540)

РОДОПИ

(511)

16 – Paper, cardboard and goods made from these materials, not included in other classes; printed matter; photographs; plastic materials for packaging (not included in other classes); paper and cardboard packages, especially cigarette packages; boxes of cardboard or paper; wrappings and packages (stationery); packing paper, cigar bands; stationery; forms (printed); pamphlets: writing pads; placards of paper or cardboard; posters; decalcomanias; labels, not of textile; calendars; catalogues; folders (stationery); files (office requisites); bags (envelopes, pouches) of paper or plastics, for packaging.

(printed); pamphlets: writing pads; placards of paper or cardboard; posters; decalcomanias; labels, not of textile; calendars; catalogues; folders (stationery); files (office requisites); bags (envelopes, pouches) of paper or plastics, for packaging.

34 – Tobacco; smokers' articles; matches; cigarettes; cigars; cigarillos; lighters for smokers; tobacco-raw, manipulated or processed; tobacco products; cigarette filters; cigarette paper; ashtrays for smokers.

35 – Advertising; business management; business administration; office functions; publication of publicity texts; radio advertising; advertising through posters; distribution of samples, models, patterns; dissemination of advertising matters; sales advertising; advertising agencies; TV advertisements; administrative activities and services for management of domestic and international commercial transactions; consultations connected with the business management; marketing surveys and researches; consulting services for business management; management of business or industrial enterprises assistance; support in business management; organization of exhibitions and fairs with commercial and advertising purposes; outdoor advertising with bill boards; advertising services using outdoor posters, advertising panel and wall surfaces; demonstration of goods; preparation and publishing of advertisements through printed, audio, video, radio, television and electronic media; advertising through the global computer network; actualization of advertisement matters; import-export agencies.

(260) AM 2015 75987 A

(800) 1191874

(891) 2013 08 09

(731) AKTSIONERNO DROUJESTVO

"BULGARTABAC-HOLDING"

"Graf Ignatiev" Str. 62, BG-1000 SOFIA,

Bulgaria

(540)

ИНТЕП

(511)

16 – Paper, cardboard and goods made from these materials, not included in other classes; printed matter; photographs; plastic materials for packaging (not included in other classes); paper and cardboard packages, especially cigarette packages; boxes of cardboard or paper; wrappings and packages (stationery); packing paper, cigar bands; stationery; forms (printed); pamphlets: writing pads; placards of paper or cardboard; posters; decalcomanias; labels, not of textile; calendars; catalogues; folders (stationery); files (office requisites); bags (envelopes, pouches) of paper or plastics, for packaging.

34 – Tobacco; smokers' articles; matches; cigarettes; cigars; cigarillos; lighters for smokers; tobacco-raw,

manipulated or processed; tobacco products; cigarette filters; cigarette paper; ashtrays for smokers.

35 – Advertising; business management; business administration; office functions; publication of publicity texts; radio advertising; advertising through posters; distribution of samples, models, patterns; dissemination of advertising matters; sales advertising; advertising agencies; TV advertisements; administrative activities and services for management of domestic and international commercial transactions; consultations connected with the business management; marketing surveys and researches; consulting services for business management; management of business or industrial enterprises assistance; support in business management; organization of exhibitions and fairs with commercial and advertising purposes; outdoor advertising with bill boards; advertising services using outdoor posters, advertising panel and wall surfaces; demonstration of goods; preparation and publishing of advertisements through printed, audio, video, radio, television and electronic media; advertising through the global computer network; actualization of advertisement matters; import-export agencies.

(260) AM 2015 76020 A

(800) 614872

(891) 2014 02 03

(731) BROOKSBURNETT INVESTMENTS LTD

Sofias Tsirou 9, Toulla Court 3, 2nd Floor,
Flat/Office 22, CY-3021, Limassol, Cyprus,
Cyprus

(540)



(591) Blue and black

(511)

25 – Stockings and tights.

(260) AM 2015 76103 A

(800) 1192792

(891) 2013 11 28

(731) TSN Brands LTD

Geneva Place, Waterfront Drive, P.O. Box
3469, Road Town, Tortola, British Virgin
Islands

(540)

iCREAM

(591) Black, white

(511)

29 – Ajvar [preserved peppers]; aloe vera prepared for human consumption; alginates for culinary

purposes; anchovy; peanuts, processed; albumen for culinary purposes; white of eggs; beans, preserved; soya beans, preserved, for food; bouillon; ginger jam; ham; fatty substances for the manufacture of edible fats; toasted laver; edible birds' nests; peas, preserved; mushrooms, preserved; snail eggs for consumption; eggs, milk and milk products; eggs; meat extracts; seaweed extracts for food; non-alcoholic egg nog; fruit chips; low-fat potato chips; lentils, preserved; fruit peel; hummus [chickpea paste]; potato flakes; fruit, stewed; fruit preserved in alcohol; fruit, preserved; preserved, frozen, dried and cooked fruits and vegetables; frozen fruits; crystallized fruits; fish fillets; rennet; milk ferments for culinary purposes; oysters, not live; tuna fish; truffles, preserved; sea-cucumbers, not live; tofu; tahini [sesame seed paste]; cheese; whey; vegetable soup preparations; soups; tripe; preparations for making soup; preparations for making bouillon; sausages in batter; sausages; salted meats; tomato juice for cooking; vegetable juices for cooking; smetana [sour cream]; fat-containing mixtures for bread slices; cream [dairy products]; whipped cream; processed sunflower seeds; processed seeds; herrings; sardines; bacon; fruit salads; vegetable salads; ryazhenka [fermented baked milk]; salted fish; fish, not live; fish, preserved; crustaceans, not live; crayfish, not live; apple purée; cranberry sauce [compote]; pollen prepared as foodstuff; poultry, not live; prostokvasha [soured milk]; curd; foods prepared from fish; processed meat products; milk products; powdered eggs; jams; pickles; liver; pectin for culinary purposes; liver pâté; tomato purée; nuts, prepared; coconut, desiccated; lobsters, not live; olives, preserved; potato fritters; vegetables, dried; vegetables, cooked; vegetables, preserved; milk beverages, milk predominating; meat, fish, poultry and game; meat, preserved; meat; fruit pulp; fish mousses; vegetable mousses; fish meal for human consumption; albumin milk; soya milk [milk substitute]; milk and milk products; milk; mussels, not live; animal marrow for food; almonds, ground; shellfish, not live; butter; coconut oil; sunflower oil for food; palm kernel oil for food; palm oil for food; olive oil for food; linseed oil for culinary purposes; sesame oil; coconut butter; colza oil for food; cocoa butter; peanut butter; edible oils; edible oils and fats; marmalade; piccalilli; margarine; onions, preserved; salmon; lecithin for culinary purposes; spiny lobsters, not live; kumys [kumyss] [milk beverage]; silkworm chrysalis, for human consumption; croquettes; buttercream; prawns, not live; shrimps, not live; gherkins; bouillon concentrates; fruits, tinned [canned (Am.)]; fish, tinned [canned (Am.)]; vegetables, tinned [canned (Am.)]; meat, tinned [canned (Am.)]; black pudding [blood sausage]; milk shakes; clams [not live]; isinglass for food; kimchi [fermented vegetable dish]; kephir [milk beverage]; sauerkraut; yogurt; processed fish spawn; caviar; raisins; charcuterie; fruit-

based snack food; edible fats; suet for food; lard for food; bone oil, edible; coconut fat; yolk of eggs; fruit jellies; jellies for food; meat jellies; jellies, jams; gelatine; game, not live.

30 – Aromatic preparations for food; flavorings [flavourings], other than essential oils, for cakes; flavorings [flavourings], other than essential oils, for beverages; flavorings, other than essential oils; coffee flavorings [flavourings]; star aniseed; high-protein cereal bars; pancakes; noodle-based prepared meals; buns; bread rolls; vanillin [vanilla substitute]; vanilla [flavoring] [flavouring]; waffles; vermicelli [noodles]; natural sweeteners; sausage binding materials; binding agents for ice cream [edible ices]; sea water for cooking; seaweed [condiment]; malt biscuits; cloves [spice]; cake frosting [icing]; glucose for culinary purposes; mustard; gluten additives for culinary purposes; yeast; yeast, baking-powder; thickening agents for cooking foodstuffs; leaven; rice-based snack food; cereal-based snack food; artificial coffee; vegetal preparations for use as coffee substitutes; dressings for salad; fruit jellies [confectionery]; confectionery for decorating Christmas trees; cakes; pastries; peanut confectionery; almond confectionery; pasta; pâté [pastries]; ginger [spice]; frozen yogurt [confectionery ices]; cocoa; cream of tartar for culinary purposes; capers; caramels [candy]; curry [spice]; gruel, with a milk base, for food; ketchup [sauce]; quiches; gluten prepared as foodstuff; sweetmeats [candy]; liquorice [confectionery]; peppermint sweets; cinnamon [spice]; coffee; unroasted coffee; starch for food; crackers; custard; hominy grits; semolina; oatmeal; crushed barley; groats for human food; corn, milled; corn, roasted; meat pies; turmeric for food; couscous [semolina]; farinaceous foods; noodles; ice for refreshment; candy; ice, natural or artificial; edible ices; rice cakes; mayonnaise; macaroons [pastry]; macaroni; maltose; hominy; marinades; marzipan; honey; royal jelly; ice cream; bean meal; flour and preparations made from cereals, bread, pastry and confectionery, ices; tapioca flour for food; potato flour for food; corn flour; flour; wheat flour; soya flour; barley meal; dessert mousses [confectionery]; chocolate mousses; muesli; mint for confectionery; cocoa beverages with milk; coffee beverages with milk; coffee-based beverages; cocoa-based beverages; tea-based beverages; chocolate beverages with milk; chocolate-based beverages; infusions, not medicinal; crushed oats; husked oats; nutmegs; stick liquorice [confectionery]; soya bean paste [condiment]; pastilles [confectionery]; molasses for food; pepper; allspice; peppers [seasonings]; pesto [sauce]; biscuits; petit-beurre biscuits; pies; pizzas; meat gravies; fondants [confectionery]; popcorn; powders for ice cream; baking powder; mustard meal; pralines; condiments; meat tenderizers, for household purposes; cereal preparations; flour-milling products; oat-based food; propolis; gingerbread; spices; petits fours [cakes];

puddings; cake powder; fruit coulis [sauces]; ravioli; chewing gum; relish [condiment]; rice; wheat germ for human consumption; spring rolls; sago; sugar; palm sugar; aniseed; linseed for human consumption; golden syrup; cake paste; confectionery; baking soda [bicarbonate of soda for cooking purposes]; malt for human consumption; salt for preserving foodstuffs; cooking salt; celery salt; sorbets [ices]; ham glaze; soya sauce; tomato sauce; sauces [condiments]; spaghetti; seasonings; preparations for stiffening whipped cream; rusks; breadcrumbs; sushi; sandwiches; tabbouleh; tacos; tapioca; almond paste; tortillas; garden herbs, preserved [seasonings]; vinegar; beer vinegar; vinegar, sauces [condiments]; ferments for pastes; halvah; bread; unleavened bread; corn flakes; oat flakes; chips [cereal products]; chicory [coffee substitute]; tea; iced tea; chutneys [condiments]; cheeseburgers [sandwiches]; chow-chow [condiment]; saffron [seasoning]; chocolate; malt extract for food; essences for foodstuffs, except ethereal essences and essential oils; husked barley.

32 – Aperitifs, non-alcoholic; lithia water; seltzer water; soda water; waters [beverages]; aerated water; mineral water [beverages]; table waters; kvass [non-alcoholic beverage]; cocktails, non-alcoholic; lemonades; peanut milk [non-alcoholic beverage]; milk of almonds [beverage]; non-alcoholic beverages; isotonic beverages; non-alcoholic honey-based beverages; aloe vera drinks, non-alcoholic; whey beverages; non-alcoholic fruit juice beverages; fruit nectars, non-alcoholic; orgeat; powders for effervescing beverages; sarsaparilla [non-alcoholic beverage]; syrups for lemonade; syrups for beverages; smoothies; tomato juice [beverage]; cider, non-alcoholic; vegetable juices [beverages]; fruit juices; preparations for making aerated water; preparations for making liqueurs; preparations for making mineral water; preparations for making beverages; must; grape must, unfermented; malt wort; pastilles for effervescing beverages; sherbets [beverages]; non-alcoholic fruit extracts; essences for making beverages.

(260) AM 2015 76148 A

(800) 1061256

(891) 2014 01 16

(731) Obschestvo s ogranichennoy
otvetstvennostyou "LEON"
str. 1A, 20, rue Kulakova, RU-123592
Moscou, Russian Federation

(540)

ERLIT

(591) Black, white

(511)

11 – Apparatus for lighting, heating, steam generating, cooking, refrigerating, drying, ventilating, water supply and sanitary purposes.

20 – Furniture, mirrors, picture frames; goods, not included in other classes, of wood, cork, reed, cane, wicker, horn, bone, ivory, whalebone, shell, amber, mother-of-pearl, meerschaum and substitutes for all these materials, or of plastics.

(260) AM 2015 76234 A
(800) 1193536
(891) 2013 08 23
(731) ZENTIVA GROUP, A.S.
U Kabelovny 130 CZ-102 37 Praha
10 – Dolní Měcholupy, Czech Republic
(540)

MEMBACK

(511)
5 – Pharmaceuticals, pharmaceutical preparations for human use.

(260) AM 2015 76236 A
(800) 1193542
(891) 2013 10 30
(731) AVON PRODUCTS, INC.
World Headquarters, 777 Third Avenue,
New York NY 10017, USA
(540)

AVON LUCK

(511)
3 – Non-medicated toilet preparations; toiletries; skin care preparations; skin moisturizers; body and beauty care preparations; powders, creams and lotions, all for the face, hands and body; cosmetic suntan preparations; soaps; shower and bath preparations; beauty masks; talcum powder; nail polish; nail polish remover; enamel for nails; false nails; adhesives for cosmetic purposes; cosmetics; eye makeup remover, eye shadow, eye liner, mascara, lipstick, lip liner, lip gloss; make-up foundation; blusher; tissues impregnated with cosmetic lotions; cotton sticks for cosmetic purposes; cotton wool for cosmetic purposes; preparations for cleaning, moisturising, colouring and styling the hair; preparations for cleaning the teeth; shaving and aftershave preparations; perfumes, fragrances, toilet waters, cologne; deodorants for human beings; anti-perspirants for personal use (toiletries); essential oils (cosmetic).

(260) AM 2015 76243 A
(800) 1193585
(891) 2013 12 10
(731) ROCHE DIAGNOSTICS GMBH
Sandhoferstrasse 116, 68305 Mannheim,
Germany
(540)

VENTANA AS

(511)
9 – Clinical and pathological laboratory instruments; automated slide staining apparatus for treating and staining tissue slide specimens for research and scientific use in fields of histology and pathology.
10 – Medical processing apparatus and instruments for treating and staining specimens for analysis in the fields of histology and pathology; automated slide staining apparatus for treating and staining tissue slide specimens for diagnostic use.

(260) AM 2015 76511 A
(800) 1195673
(891) 2013 07 16
(731) THE AMERICAN SOCIETY OF
MECHANICAL ENGINEERS
Two Park Avenue, New York NY
10016-5990, USA
(540)

THE AMERICAN
SOCIETY OF
MECHANICAL
ENGINEERS

(591) Black, white
(511)
9 – Downloadable electronic publications in the nature of e-books, magazines, journals, printed codes, manuals, books, academic papers, newspapers, pamphlets and newsletters in the field of engineering, technology and science; Multimedia software recorded on digital media featuring educational courses, workshops, seminars, conferences, symposia, and training in the field of engineering, technology and science; downloadable computer software featuring educational courses, workshops, seminars, conferences, symposia and training in the field of engineering, technology and science.

16 – Publications of all kinds, namely, magazines, printed codes, manuals, books, newspapers, and pamphlets of an engineering, technology and science nature.

35 – Association services, namely, promoting the interest of those involved with mechanical engineering profession and promoting the use and services of engineers (terms too vague in the opinion of the International Bureau – Rule 13(2)(b) of the Common Regulations).

41 – Educational services, namely, conducting seminars, conferences and courses in the fields of engineering, technology, science and public speaking; providing on-line publications in the nature of e-books, magazines, journals, printed codes, manuals, books, academic papers, newspapers, pamphlets and newsletters in the field of engineering, technology and science; on-line academic library services; Education services, namely, providing live and on-line

classes, seminars and workshops in the field of engineering, technology and science.

42 – Indicating membership in an association of mechanical engineers (terms too vague in the opinion of the International Bureau – Rule 13(2)(b) of the Common Regulations); assessment and evaluation of the services of manufacturers, fabricators, designers, inspection companies, and personnel in meeting codes and standards in the field of engineering, technology and science, and issuance of certifications and accreditation in accordance with the results of such assessment and evaluation.

(260) AM 2015 76514 A

(800) 1195719

(891) 2013 10 04

(731) WORLD MEDICINE İLAÇ SANAYİ VE
TİCARET LİMİTED ŞİRKETİ
Evren Mahallesi Cami Yolu Caddesi No:50,
Kat 1 B Zemin 4-5-6, Güneşli/Bağcılar/İSTAN-
BUL, Turkey

(540)

DUSKONAL
ДУСКОНАЛ

(591) Black, white

(511)

5 – Medicines for human purposes, medicines for veterinary purposes, vitamins, chemical preparations for medical purposes, dietetic substances adapted for medical use; dietetic foods adapted for medical purposes; amino acids for medical purposes, nutritional supplements, pollen dietary substances, mineral food supplements, protein dietary supplements, baby foods, medicinal herbs, herbal beverages adapted for medical purposes; medicines for dental purposes, hygienic products for medical purposes including pads, waddings for medical purposes, plasters for medical purposes, dressings for medical purposes; preparations for destroying noxious plants, preparations for destroying noxious animals, fungicides; deodorants other than for human beings or for animals; air deodorising preparations; disinfectants for hygiene purposes, antiseptics, detergents for medical purposes.

(260) AM 2015 76534 A

(800) 1195844

(891) 2013 10 14

(731) DEXCEL LTD.
P.O.B. 50 38100 Hadera, Israel

(540)

DEXCEL

(511)

3 – Bleaching preparations and other substances for laundry use; cleaning, polishing, scouring and abra-

sive preparations; soaps; perfumery, essential oils; cosmetics; hair and body lotions; bath foams; shampoos; hair conditioners; creams, gels, moisturizers; salts; powders; toiletries; aftershaves; make-up preparations; deodorants for personal use; dentifrices.

(260) AM 2015 76537 A

(800) 1195849

(891) 2014 02 10

(731) ORIKONT-NAROFOMINSK LLC
str. Professionalnaya, d. 7/1, d. Alabino,
Naro-Fominskiy r-n, RU-143345
Moskovskaya obl., Russian Federation

(540)



(591) Black, gray and bright green

(511)

3 – Scale removing preparations for household purposes; antistatic preparations for household purposes; air fragrancing preparations; sachets for perfuming linen; scented water; floor wax; non-slipping wax for floors; non-slipping liquids for floors; wind-screen cleaning liquids; colorants for toilet purposes; laundry starch; laundry glaze; polishing preparations; fabric softeners for laundry use; laundry bleaching preparations; dry-cleaning preparations; floor wax removers [scouring preparations]; rust removing preparations; cleaning preparations; wallpaper cleaning preparations; preparations for unblocking drain pipes; laundry preparations; colour-brightening chemicals for household purposes [laundry]; shining preparations [polish]; stain removers; scouring solutions; laundry blueing; bleaching salts; detergents other than for use in manufacturing operations and for medical purposes; degreasers other than for use in manufacturing processes.

(260) AM 2015 76539 A

(800) 1195868

(891) 2013 10 18

(731) LONCIN MOTOR CO., LTD.
No:99, Hualong Avenue, Jiulong Park,
Jiulongpo District, 400052 Chongqing, China

(540)

LONCIN

(591) Black, white

(511)

7 – Agricultural machines; lawnmowers [machines]; disintegrators; mixing machines; excavators; elevators [lifts]; metalworking machines; generators of electricity; diesel engines not for land vehicles; gaso-

line engines not for land vehicles; wind-powered electricity generators; pumps [machines]; compressors [machines]; soldering apparatus, gas-operated; snow ploughs.

(260) AM 2015 76540 A

(800) 1195906

(891) 2013 11 11

(731) Obshestvo s ogranichennoy otvetstvennostyu "LEGION CO"

16 A, Navoi Street, district Shayhontohur, Tashkent city 100011, Uzbekistan

(540)

Хан-Атлас

(591) Black, white

(511)

33 – Vodka.

(260) AM 2015 76541 A

(800) 1195908

(891) 2013 11 21

(731) SWATCH AG (SWATCH SA) (SWATCH LTD)

Jakob-Stämpfli-Strasse 94, CH-2502 Biel/Bienne, Switzerland

(540)

i POP SWATCH

(511)

9 – Apparatus for recording, transmission and reproduction of sound or images; magnetic recording media, sound recording disks; compact disks, DVDs and other digital recording media; apparatus enabling the playing of compressed sound files (mp3); calculating machines and data processing equipment, software; games software for mobile telephones, computers and digital personal stereos; electronic game software for mobile telephones, for computers and for digital personal stereos; computers, portable computers, handheld computers, mobile computers, personal computers, wrist computers, electronic tablets and computerized and mobile devices, digital personal stereos, mobile telephones and new-generation mobile telephones featuring greater functionality (smartphones); telecommunications apparatus and instruments; apparatus for the recording, transmission, reproduction of sound or images, particularly mobile telephones and new-generation mobile telephones featuring greater functionality (smartphones); handheld electronic apparatus for accessing the Internet and sending, receiving, recording and storing short messages, electronic messages, telephone calls, faxes, video-conferences, images, sound, music, text and other digital data; handheld electronic apparatus for wireless receiving, storing and transmitting of data or messages; handheld electronic apparatus for monitoring and organizing perso-

nal information; handheld electronic apparatus for global positioning [GPS] and displaying maps and transport information; hand-held electronic apparatus for games; handheld electronic devices for detecting, monitoring, storing, surveillance and transmitting data relating to the user activity, namely position, itinerary, distance traveled, heart rate; covers for computers, portable and mobile telephones; optical apparatus and instruments, particularly spectacles, sunglasses, magnifying glasses; cases for spectacles, magnifying glasses and sunglasses; batteries for electronic apparatus and computers, batteries for timepieces and chronometric instruments.

14 – Precious metals and their alloys and goods made of these materials or coated therewith included in this class, namely figurines, trophies; jewelry, namely rings, earrings, cuff links, bracelets, charms, brooches, chains, necklaces, tie pins, tie clips, jewelry caskets (cases), cases; precious stones, semi-precious stones; timepieces and chronometric instruments, namely chronometers, chronographs, clocks, watches, wristwatches, wall clocks, alarm clocks as well as parts and accessories for the aforesaid goods, namely hands, anchors, pendulums, barrels, watch cases, watch straps, watch dials, clockworks, watch chains, movements for timepieces, watch springs, watch glasses, presentation cases for timepieces, cases for timepieces.

(260) AM 2015 76542 A

(800) 1195961

(891) 2013 12 27

(731) OAO "TRANSPNEVMATIKA"

ul. Mochalina, 2a, Nizhegorodskaya oblast, RU-607760 Pervomaysk, Russian Federation

(540)



(591) Black, white

(511)

6 – Brackets of metal.

7 – T-branches-dust catchers [parts of machines]; compressors [machines]; oil separators; filters [parts of machines or engines]; soldering lamps.

11 – Garden ovens.

12 – Pressure relays of the antiskid device for vehicles [parts of braking system]; brake cylinders for vehicles; magnetic rail brakes for vehicles; vehicles; apparatus for locomotion by land; spare parts for motorcycles; spare parts included in class 12 for all the above listed goods.

(260) AM 2015 76544 A
 (800) 1195996
 (891) 2014 02 10
 (731) ISKRA INDUSTRY CO., LTD.
 1-14-2, Nihonbashi, Chuo-ku, Tokyo, Japan
 (540)

TOUCHI

(511)
 5 – Mineral food-supplements; nutritional supplements, in particular nutritional supplements for medical purposes; dietetic foods adapted for medical purposes.

(260) AM 2015 76545 A
 (800) 1196049
 (891) 2013 10 29
 (731) IITTALA GROUP OY AB
 Hämeentie 135, FI-00560 Helsinki, Finland
 (540)



(591) Black, white
 (511)

6 – Common metals and their alloys; metal building materials; transportable buildings of metal; materials of metal for railway tracks; non-electric cables and wires of common metal; ironmongery, small items of metal hardware; pipes and tubes of metal; safes; goods of common metal not included in other classes; ores; baskets of common metal; bottle caps of metal; boxes of common metal; closures of metal for containers; clothes hooks of metal; door knockers of metal; figurines [statuettes] of common metal; works of art of common metal; decorative boxes of metal; containers, transportation and packaging articles, of metal.

8 – Hand tools and implements (hand-operated); cutlery; side arms; razors; agricultural, gardening and landscaping hand tools; cutting, drilling, grinding, sharpening and surface treatment hand tools; garden tools, hand-operated; hand-operated tools for treatment of materials, and for construction, repair and maintenance; flat irons; can openers, non-electric; knives; cutting tools [hand tools]; slicers for food preparation, non-electric; peelers for food preparation, non-electric; scissors; nutcrackers; oyster openers; sharpening tools [hand operated]; table cutlery [knives, forks and spoons]; disposable tableware [cutlery] made of plastics.

18 – Leather and imitations of leather, and goods made of these materials and not included in other classes; animal skins, hides; trunks and travelling bags; umbrellas and parasols; walking sticks; whips, harness and saddlery; boxes of leather or leather board; bags [envelopes, pouches] of leather, for packaging; luggage, bags and wallets.

20 – Furniture, mirrors, picture frames; goods (not included in other classes) of wood, cork, reed, cane, wicker, horn, bone, ivory, whalebone, shell, amber, mother-of-pearl, meerschaum and substitutes for all these materials, or of plastics; baskets, not of metal; bottle closures, not of metal; bottle racks; clothes hooks, not of metal; coat hangers; coatstands; containers, not of metal [storage, transport]; decorations of plastic for foodstuffs; door knockers, not of metal; figurines [statuettes] of wood, wax, plaster or plastic; hat stands; interior textile window blinds; keyboards for hanging keys; magazine racks; beds, bedding (except linen), mattresses, pillows and cushions; works of art, of wood, wax, plaster or plastic; picnic baskets [not fitted]; decorative boxes and containers of wood, cork, reed, cane, wicker, horn, bone, ivory, whalebone, shell, amber, mother-of-pearl, meerschaum and substitutes for all these materials, or of plastics.

21 – Household or kitchen utensils and containers; combs and sponges; brushes (except paint brushes); brush-making materials; articles for cleaning purposes; steelwool; unworked or semi-worked glass (except glass used in building); glassware, porcelain and earthenware not included in other classes; baskets for domestic use; bottle openers; bottles; bread bins; molds [kitchen utensils]; candle extinguishers; candle rings; candle holders; ceramics for household purposes; tableware, cookware and containers for household and kitchen use; cleaning instruments, hand-operated; coasters, not of paper and other than table linen; blenders, non-electric, for household purposes; coffee filters, non-electric; coffee percolators, non-electric; coffeepots, non-electric; grinders, non-electric; cooking utensils, non-electric; fruit presses, non-electric for household purposes; kettles, non-electric; mixing machines, non-electric, for household purposes; pastry cutters; saucepan scourers; cooking pins of metal; corkscrews; cruet sets for oil and vinegar; cups and plates of paper or plastic; cutting boards for the kitchen; glasses and drinking vessels; dish covers; figurines [statuettes] of porcelain, ceramic, earthenware or glass; fitted picnic baskets, including dishes; fruit presses, non-electric, for household purposes; gardening gloves; garlic presses [kitchen utensils]; gloves for kitchen purposes; graters [household utensils]; heat-insulated containers; ironing boards; knife rests for the table; menu card holders; napkin holders; napkin rings; pepper and salt mills, hand-operated; pitchers; soap boxes; soap dispensers; spice sets; salt cellars; tableware, other than knives, forks and spoons; trays for domestic purposes; works of art of porcelain, ceramic, earthenware or glass; oven mitts; decorative boxes and containers of porcelain, earthenware or glass.

22 – Ropes, string, nets, tents, awnings, tarpaulins, sails, sacks and bags (not included in other classes);

padding and stuffing materials (except of rubber or plastics); raw fibrous textile materials; bags and sacks of textile for packaging, storage and transport; textile bags for merchandise packaging; packing [cushioning, stuffing] materials, not of rubber or plastics; laundry bags.

24 – Textiles and textile goods, not included in other classes; bed covers; table covers; bath linen, except clothing; bed clothes and blankets; kitchen and table linen; covers [loose] for furniture; curtains of textile or plastic; handkerchiefs of textile; household linen; mattress covers; shower curtains of textile or plastic; table napkins of textile; towels of textile.

25 – Clothing, footwear, headgear; aprons [clothing]; belts [clothing]; paper clothing; scarfs.

35 – Advertising; business management; business administration; office functions; administrative processing of purchase orders; advisory services for business management; business appraisals; business investigations; commercial administration of the licensing of the goods and services of others; commercial information and advice for consumers [consumer advice shop]; compilation and systemization of information into computer databases; demonstration of goods; dissemination of advertising matter; import-export agencies; invoicing; marketing research; organization of exhibitions for commercial or advertising purposes; organization of trade fairs for commercial or advertising purposes; personnel management consultancy; presentation of goods on communication media, for retail purposes; procurement services for others [purchasing goods and services for other businesses]; public relations; rental of advertising space; rental of advertising time on communication media; sales promotion for others; updating of advertising material; resale of hand tools and instruments, cutlery, knives, scissors, household and kitchen utensils and containers, glassware, porcelain, earthenware, storage wares, lighting apparatus, kitchen and household equipment, interior décor articles, textile goods, clothing and aprons.

(260) AM 2015 76547 A

(800) 1196051

(891) 2013 11 06

(731) GUANGDONG ANJUBAO DIGITAL TECHNOLOGY CO., LTD.

The First Building, No:6 Qiyun Road, Science City, High and New Technology Development Zone, Guangzhou City, Guangdong Province, China

(540)



(591) Black, white

(511)

7 – Wrapping machines; elevating apparatus; curtain drawing devices, electrically operated; washing machines; embossing machines; electronic door up-rolling machine; kitchen machines, electric; finishing machines; machinery for producing wire and cable; doors closers, electric; door openers, electric.

9 – Remote control apparatus; computer peripheral devices; video recorders; parking meters; intercommunication apparatus; optical communication device; shutters [photography]; light dimmers [regulators], electric; chargers for electric batteries; theft prevention installations, electric; intelligent telephones; control panels [electricity]; video walkie-talkies; fibre [fiber (Am.)] optic cables; smoke detectors; alarms; monitors [computer hardware]; regulating apparatus, electric; electronic notice boards; network communication device; camcorders; coaxial cables; monitors [computer programs]; materials for electricity mains [wires, cables]; electro-dynamic apparatus for the remote control of signals.

45 – Security consultancy; night guards; undertaking; fire-fighting; baggage inspection for security purposes; chaperoning; rental of fire alarms; monitoring of burglar and security alarms; clothing rental; licensing of computer software [legal services].

(260) AM 2015 76548 A

(800) 1196070

(891) 2013 11 25

(731) LIMITED LIABILITY COMPANY "ASKONA Holding Company"

90 Vatutina St., Kovrov, RU-601900 Vladimir Region, Russian Federation

(540)

Taktile

(511)

17 – Packing [cushioning, stuffing] materials of rubber or plastics; padding materials of rubber or plastics.

20 – Furniture, mirrors, picture frames; goods (not included in other classes) of wood, cork, reed, cane, wicker, horn, bone, ivory, whalebone, shell, amber, mother-of-pearl, meerschaum and substitutes for all these materials, or of plastics.

22 – Ropes, string, nets, tents, awnings, tarpaulins, sails, sacks and bags (not included in other classes); padding and stuffing materials (except of rubber or plastics); raw fibrous textile materials.

24 – Textiles and textile goods, not included in other classes; bed covers; table covers.

35 – Advertising; business management; business administration; office functions.

(260) AM 2015 76599 A

(800) 1196414

(891) 2013 12 04

(731) LABORATOIRES DE BIOLOGIE
VEGETALE YVES ROCHER
La Croix des Archers, F-56200 LA
GACILLY, France

(540)

QUELQUES NOTES D'AMOUR

(511)

3 – Soaps; deodorants for personal use; perfumes; perfumery products for cosmetic use; home perfuming products excluding vaporizers; sachets for perfuming linen; essential oils; cosmetic shaving, pre-shave and after-shave products; cosmetic products in any galenic form not for medical use; cosmetic products for face and body care; cosmetic products for bathing and showering; cosmetic make-up products; sun care products for cosmetic use; products for hair treatment, care and beautification for cosmetic use; cosmetic products for foot and hand care; dentifrices.

(260) AM 2015 76604 A

(800) 1196449

(891) 2013 08 09

(731) CONTINENTAL REIFEN DEUTSCHLAND
GMBH
Vahrenwalder Str. 9, 30165 Hannover,
Germany

(540)

Continental 

(591) Black, white

(511)

1 – Chemicals used in industry, science, photography, agriculture, horticulture and forestry; unprocessed artificial resins, unprocessed plastics; manures; fire-extinguishing compositions; tempering and soldering preparations; tanning substances; adhesives used in industry; rubber solvents; synthetic materials for absorbing oils; vulcanization accelerators; vulcanizing preparations; photosensitive plates for printing purposes; sensitised offset-printing plates; brake fluid.

4 – Industrial oil and grease; lubricants; dust absorbing, wetting and binding compositions; fuels (including engine fuel) and illuminants; grease for motor vehicles; brake paste.

6 – Common metals and their alloys; metal building materials; transportable constructions of metal; metal building materials for railway tracks; metal cables and wires (not for electrical purposes); ironmongery and small items of metal hardware; metal pipes and flexible tubings; metal hose and pipe connectors; metal manifolds, couplings and adapters; metal hose and pipe couplings, fittings as far as included in

this class; metal pipes and tubes for ventilation and air-conditioning systems; metal molds; metal goods as far as included in this class.

7 – Metal, wood, rubber and plastics working machines, for the manufacture, repair and disassembly of land and sea vehicles, for the chemical industry, agriculture, mining, textile, food and beverage, construction and packaging industry; machine tools; printing machines; printing frames, printing plates; machines used in the manufacture of printing plates; printing plates [not light-sensitive]; pressure casting molds [machine; components]; lithographic printing plates for printing machines; motors and engines (except for land vehicles and aerospace vehicles); components for motors and engines of all types, including electric motors and their components (except for land vehicles and aerospace vehicles); control units for motors and engines (except for aerospace vehicles); electric starters for motors and engines (except for aerospace vehicles); motor driven electric generators (except for aerospace vehicles); main cylinders; electric motors (except for land vehicles and aerospace vehicles) and pumps (machines); engine actuators (throttle valves, idle governors, linear actuators, air control valves, air flap actuators, exhaust gas recirculation valves) (except for aerospace vehicles); injection valves, injection nozzles for engines (except for aerospace vehicle engines); fuel pumps; fuel injection systems; spark plugs for combustion engines (except for aerospace vehicle engines); glow plugs for diesel engines (except for aerospace vehicle engines); ignition coils; air filters for engines; catalytic converters; chargers [turbochargers]; turbocompressors; control units for machines; controlled adjusting devices for vehicle parts such as vehicle seats, windows, mirrors, sliding roofs, throttle valves, camshafts; machine coupling and transmission components, including shift clutches (except for land vehicles); drive belts, transmission belts, V-belts, V-ribbed belts, variator belts, timing belts, synchronous belts, nubbed belts, double-sided timing belts, flat belts, lift belts (machine components), conveyor belts; machine components, such as springs, shock absorber pistons, vibration dampers; molded parts made from rubber and rubber-metal bondings for vibration control as far as included in this class; engine mounts; hydraulic mounts, torsional vibration dampers; actuators; all of the aforementioned goods exclusive of aerospace vehicle power plants, aerospace vehicle piston engines, aerospace vehicle turbine engines and parts and controls therefor; valves (machine components); conveyor belts, belt conveyors, parts and accessories for conveyor belts and belt conveyors; passenger conveyors not included in other classes; (compressed air) spray guns for water, oil, gas, paint and other gaseous or liquid substances; metal fittings (accessories for spray guns or sprayers); mechanical vehicle jacks; lawn mowers (machines); agricultural imple-

ments, other than hand operated; automatic distribution machines.

8 – Hand tools for installing, repairing and mounting drive belts; cutlery, forks and spoons; side arms; razors; repair hand tools for motor vehicles; hand tools for installing, testing and checking vehicle brake, fuel feed and injection systems; hand-operated syringes for water, oil, paint, gas and other gaseous or liquid substances; hand-operated spray guns; sprayers; metal fittings (accessories for spray guns or sprayers).

9 – Scientific, nautical, surveying, electric, photographic, cinematographic, optical, weighing, measuring, signaling, checking (supervision), life-saving and teaching apparatus and instruments as far as included in this class; measuring devices and instruments (except for aerospace vehicles); electric control and regulating systems (except for aerospace vehicles) including their processors and sensors for the steering and controlling of vehicles, for improved driving safety, driving stability, suspension quality and noise reduction; electric control and regulating systems (except for aerospace vehicles) including their processors and sensors for regulation and control of brakes, accelerator pedals, transmissions, chassis and exhaust gases; voltage regulators for vehicles; automatic control systems for vehicles (except for aerospace vehicles); electrical and electrohydraulic power steering (except for aerospace vehicles); ammeters, voltmeters, ohmmeters, manometers, thermometers, tachometers (except for aerospace vehicles); compasses, acidimeters, spirit levels, scales; thermostats (except for aerospace vehicles); engine management and/or idle speed control devices (except for aerospace vehicles), data management devices, data processing devices; measuring, warning and display devices and instruments for distance, axle load monitoring, acceleration, speed, engine speed, torque, turn rate, pressure, fill level, fluid supply (particularly fuel and washer fluid supply), altitude, coolant temperature, charge pressure, power, air quality, air mass, oil level, oil pressure, position, rudder position, temperature, travel, travel distance, wind and water depth (all of the aforesaid except for aerospace vehicles); distance warning and controlling devices and display instruments (except for aerospace vehicles); radar devices (except for aerospace vehicles); rearview monitoring equipment; automatic parking assistant systems; optical, acoustic and haptic drowsiness and speed warning devices and display instruments; tire pressure gauge, tire inflating equipment; service indicator, wear indicator, consumption measurement device, maintenance indicator, workshop testing equipment; time recording unit; accident data recorder, apparatus and instruments for conducting, switching, converting, storing, regulating and monitoring electricity (except for aerospace vehicles); electrical fuses, electrical relays, transponders, sensors, electric ac-

tuator (as far as included in this class); detectors (except for aerospace vehicles); pressure switches; controllers; brake fluid testers; diagnostic apparatus (not for medical purposes); monitoring and diagnostic apparatus and devices and systems made thereof for vehicle engines and power trains (except for aerospace vehicles); warning lamps for vehicles; magnetic valves; lasers, not for medical purposes; electric batteries and their components, rechargeable batteries and their components, solar batteries; fuel cells and their components, chargers for electric batteries; alarm equipment; burglar alarms, burglary detection equipment; electrical opening and closing devices for motor vehicles, including control units, controls and electric motors; central locking systems; electronic immobilizers for motor vehicles; remote control devices; remote operation systems for central locking systems; position finding, course tracking and traffic routing devices (except for aerospace vehicles); navigation instruments; navigation devices for vehicles; GPS devices (except for aerospace vehicles); electric/electronic controllers for convertible soft tops, sliding roofs and sun protection devices; data processing devices, computers including electronic calendars, fax machines, monitors, computer peripheral devices, calculators, computer programs and software, recorded; electrical, electronic, opto-electronic and mechanical analog and digital display devices and instruments (except for aerospace vehicles); image transmission and reproduction devices; electrical or electronic display devices; display equipment, display modules, display elements, display panels, displays, monitors, screens, LCDs, devices with LCDs, flat screens, video screens and monitors; touch screens; devices for recording, receiving, transmitting and reproducing analog and/or digital signals, as well as images and sound, antennae, radios, television apparatus, telephones including video telephones; hands-free equipment for telephones; rescue equipment, namely life-saving rafts, fire escapes, safety nets, safety tarpaulins, life belts, life buoys, life jackets, fire extinguishing equipment; contact lenses, spectacles, spectacle cases, binoculars, magnifying glasses, sunglasses, vehicle breakdown warning triangles for vehicles; projectors; film cameras; cameras [photography]; photocopiers; electronic translators; electronic pocket translators; exposed film, magnetic, electronic and optical recording media, with the exception of non-exposed film; recording disks including magnetic cards; cards with integrated circuitry (smart cards); telephone cards; mechanisms for coin-operated apparatus including cash machines; cash registers, computing machines; photovoltaic elements; photo cells; presence monitoring devices.

11 – Apparatus for lighting, heating, steam generating, cooking, refrigerating, drying, blowing, ventilation, air-conditioning and water supply and sanitary purposes; attachments for water supply equ-

ipment for adjusting and changing the water flow volume; end pieces for water supply equipment; heating and air-conditioning systems for vehicles; fans and ventilation modules for vehicles; vehicle headlights; bicycle lights; vehicle tail lamps; heating, cooling, air-conditioning and ventilation systems in vehicles.

12 – Vehicles for transportation on land and/or on water; parts and accessories for vehicles for transportation on land and/or on water as far as included in this class; combination display instruments, land vehicle cockpits, instrument panels, center consoles; tires, inner tubes for tires, wheels, wheel rims, treads for the retreading of tires, hub caps, rim strips, repair outfits for tires, treads and kits for repairing tires and inner tubes not included in other classes; valves for vehicle tires; chassis and parts thereof included in this class; controlled and non-controlled chassis and suspensions; electronic, hydraulic, electromechanical, electrohydraulic and mechanical brakes for vehicles; parts and accessories for electronic, hydraulic, electromechanical, electrohydraulic and mechanical brakes for vehicles; brake cylinders, brake pads, brake calipers, brake disks, brake linings, brake hoses; mechanical and hydraulic controllers and regulators not included in other classes; regulated and unregulated electromechanical and electrohydraulic steering systems and their components; hydraulic power steering, steering columns, steering gear; electrical, electronic and mechanical actuators, drive shafts and electric motors (except for aerospace vehicles); safety equipment for motor vehicles as far as included in this class; airbags, belt tensioners and their parts and accessories as far as included in this class; shaft couplings and transmission mechanism, including shift clutches for land vehicles; active and passive, regulated and unregulated dampers and springs for vehicles, wheels and their parts, particularly air pressure springs and gas springs; air supply units for air spring systems; shock absorbers and suspension struts for vehicles; shock absorber springs for vehicles, suspension springs for vehicles; vibration dampers and torsional vibration dampers (except as components of land vehicle engines) for vehicles; vehicle engines, steering apparatus; vehicle cabins and driver seats; hydromounts as vehicle components as far as included in this class; axles and axle modules, axle boots, diaphragms, drive belts, transmission belts not included in other classes; cooling, heating, brake, fuel, charge air, oil, hydraulic hoses being parts of and accessories for vehicles as far as included in this class; vehicle interiors lining; airbag covers; paneling for dashboards; interior upholstery for vehicles; motor vehicle seats; cigarette lighters for automobiles; cockpit cross beams; driver workstations, driver cabins; ventilation nozzles, air deflector elements and air lines; window and headlight cleaning systems for motor vehicles as well as the associated

containers, nozzles, hoses, hose couplings, pumps, heaters and valves; windshield and headlight cleaning systems; window lift and window positioning systems for vehicles; electric/electronic drives for convertible soft tops, sliding roofs and sun protection devices; rubber or plastic concertina walls for trains and articulated buses; fuel lines; fuel tank systems for motor vehicles.

16 – Printed matter, printers' type, printing blocks, non-textile printing blankets, components and accessories therefor, not included in other classes; atlases, calendars, geographic maps, publications (written); ball pens and pencils, bookbinding articles; photographs; stationery except stationary made out of paper; adhesives for stationery or household purposes; artists' materials; typewriters and office requisites (except furniture); instructional and teaching material (except apparatus), including textbooks, specialist books, magazines, repair and/or user instructions on automotive parts; plastic materials for packaging as far as included in this class; forms, printed forms, print rolls and diagram plates made out of paper for use in tachographs.

17 – Rubber, gutta-percha, gum, asbestos, mica and goods made from these materials and not included in other classes; plastic goods (semi-finished products); sealing, packing and insulating materials; flexible pipes (not made from metal); flexible pipe connections (not made from metal); armoring for tubes (not made from metal); rubber compensators; line seals; sealing gaiters, sealing rings, diaphragms (not included in other classes); natural rubber (liquid); sub-ballast mats made from rubber and rubber substitutes for vibration and shock damping in track construction; oil absorbent mats made of rubber and rubber substitutes; rubber valves; soft top, door, window, engine compartment seals; rubber or plastic upholstery materials; plastic sheeting (except for packaging purposes), including sheeting for sealing and insulating purposes, roof and pond liners made out of plastic; bellows, concertina walls made from rubber or plastic for airport passenger bridges; parts and accessories for all aforementioned goods not included in other classes; rubber for retreading tires; rubber solutions.

18 – Goods of leather and imitations of leather, as far as included in this class; animal skins, hides; trunks and traveling bags; umbrellas, parasols and walking sticks; whips, harness and saddlery including suitcases and bags as far as included in this class, in particular travelling bags, briefcases and handbags, document holders, wallets, key pouches made of leather.

19 – Building materials [non metallic]; non-metallic rigid pipes for building; asphalt, pitch and bitumen; non-metallic transportable buildings; ducts, not of metal, for ventilating and air conditioning installa-

tions; water pipes, not of metal [components]; water pipe valves, not made of metal or plastic.

20 – Furniture including beds (furniture), shelves, cupboards, tables, desks, chairs, armchairs, sofas, head-rests, upholstered furniture; mirrors, picture frames and mattresses; goods (not included in other classes) of wood, cork, reed, cane, wicker, horn, bone, ivory, whalebone, shell, amber, mother-of-pearl, meerschaum and substitutes for all these materials, or of plastics, including steeping bags for camping purposes, barrels, casks not of metal, packaging containers made from plastic; flexible containers of rubber or plastic for the storage and transport of solids, liquids, gases and fuels; containers, not of metal, for liquid fuel; inflatable publicity objects as far as included in this class.

22 – Ropes, string, nets, tents, awnings, tarpaulins, sails, sacks and bags (not included in other classes); padding and stuffing materials (except of rubber or plastics); raw fibrous textile materials; hammocks, bags (envelopes, pouches) of textile, for packaging; car towing ropes; vehicle covers, not fitted.

24 – Textiles and textile goods, elastomer-coated textile fabrics as far as included in this class; printers' blankets of textile; fabric, impervious to gases, for aeronautical balloons; bed and table covers including bed linen, towels, (textile) border edging, bed covers, table napkins of textile, mosquito nets, pennants and flags (not of paper).

25 – Clothing, footwear, headgear including trousers, T-shirts, polo shirts, coats, jackets, overalls, caps, gloves (clothing), shoes, cloth for clothing purposes, ties, scarves.

28 – Games and playthings, gymnastic and sporting articles (as far as included in this class); parts and accessories for the aforementioned goods as far as included in this class, including rollers and wheels for roller skates, inline skates and skateboards, scale model vehicles, in particular model cars; playing cards, balls, plush toy animals and other plush toy articles, kaleidoscopes; electronic games (including video games).

35 – Advertising, business management, business administration; office functions; personnel recruitment, personnel management consultancy, business consultancy services, public relations, radio and television advertising, organization of exhibitions and fairs for commercial and advertising purposes, marketing, sales research, market research; retail (including online retail) services in the following areas: vehicles and vehicle accessories, tires, brakes, rubber end plastic goods, chemical products, fuels and propellants, machines, tools and metal goods, building articles, electrical and electronic goods, sound and data media, printed matter, stationery, office equipment, articles of clothing, shoes and textile

goods, toys, sports equipment; wholesale services (including online wholesale services) in the following areas: vehicles and vehicle accessories, tires, brakes, rubber and plastic goods, chemical products, fuels and propellants, machines, tools and metal goods, building articles, electrical and electronic goods, sound and data media, print shop products, stationery, office equipment, articles of clothing, shoes and textile goods, toys, sports equipment; organizational advice on the granting of usage rights for mobility systems.

37 – Building construction, installation services, car workshop services, conversion, repair, servicing, assembly, dismantling, maintenance, care, cleaning and paint work for vehicles (except for aerospace vehicles), engines (except for aerospace vehicles engines), brakes, tires and their parts; repair of vehicles (except for aerospace vehicles) as part of vehicle breakdown assistance; retreading of tires; maintenance, assembly, repair of evaluation instruments for diagram plates, tachographs, accident data recorder, electronic vehicle logs, test and diagnostic apparatus and instruments; installation, maintenance and repair of machines and machine components; installation, maintenance and repair of conveyor belts and systems; installation, maintenance and repair of EDP systems.

40 – Treatment of materials including the treatment (conversion) of waste; recycling of tires; metal treating.

41 – Education; entertainment; provision of training for third parties in the fields of electronics, electrical engineering and in tire development and manufacturing; sporting and cultural activities including the organization and management of colloquiums, conferences, congresses, symposiums, seminars and workshops; organization of fairs for cultural and educational purposes, compilation of television and radio programs, radio and television entertainment, operation of movie theaters, organization of live events; operation of museums, musical performances, in particular orchestra performances, organization of lotteries and other gambling activities.

42 – Scientific and technological services and the associated research and drafts; industrial experiments and R& services; technical project development; design and development of computer hardware and software; updating of software; maintenance of computer software; technical consultancy relating to franchise; technical advice on the granting of usage rights for mobility systems; engineering surveying for the automotive and rubber industry; technical consultation of evaluation instruments for tachograph disks, tachographs, accident data recorder, electronic vehicle logs, test and diagnostic apparatus and instruments.

- (260) AM 2015 76610 A
 (800) 1196496
 (891) 2013 12 06
 (731) ROTEXS TEKSTİL İHRACAT SANAYİ VE
 TİCARET ANONİM ŞİRKETİ
 Atatürk Organize Sanayi Bölgesi, 10002
 Sokak, No:26, Çiğli-İzmir, Turkey
 (540)



- (591) Blue and black
 (511)
 25 – Clothing, namely, trousers, jackets, overcoats, coats, skirts, suits, jerseys, waistcoats, shirts, ready-made leather linings (parts of clothing), T-shirts, sweatshirts, dresses, bermuda shorts, shorts, pajamas, pullovers, jeans, tracksuits, rainwear, beachwear, bathing suits, swimming suits; clothing for sports (for exclusive use for sports), clothing for babies, namely, shirts, pants, coats, dresses; underclothing, namely, boxer shorts, brassieres, briefs, pants, socks; footwear, namely shoes excluding orthopedic shoes, sandals, waterproof boots, walking boots, booties, sporting shoes, slippers; shoe parts namely heelpieces, insoles for footwear, footwear uppers; headgear, namely caps, skull caps, sports caps, hats, berets; gloves (clothing), stockings, belts (clothing), camisoles, sarongs, scarves, neck scarves, shawls, collars, neckties, ties, suspender belts.
 35 – Advertising; business management; business administration; office functions; the bringing together, for the benefit of others, of clothing, footwear, headgear (excluding the transport thereof), enabling customers to conveniently view and purchase those goods; all of the aforementioned retail services may be provided by retail stores, wholesale outlets, through mail order catalogues or by means of electronic media, including, through web sites or television shopping programmes.

- (260) AM 2015 76613 A
 (800) 1196532
 (891) 2013 10 04
 (731) WORLD MEDICINE İLAÇ SANAYİ VE
 TİCARET LİMİTED ŞİRKETİ
 Evren Mahallesi Cami Yolu, Caddesi No:50
 Kat 1 B Zemin 4-5-6, Güneşli Bağcılar
 İSTANBUL, Turkey
 (540)

REMBO
РЕМБО

- (591) Black, white
 (511)
 5 – Medicines for human purposes, medicines for veterinary purposes, vitamins, chemical preparations

for medical purposes, dietetic substances adapted for medical use; dietetic foods adapted for medical purposes; amino acids for medical purposes, nutritional supplements, pollen dietary substances, mineral food supplements, protein dietary supplements, baby foods, medicinal herbs, herbal beverages adapted for medical purposes; medicines for dental purposes, hygienic products for medical purposes including pads, waddings for medical purposes, plasters for medical purposes, dressings for medical purposes; preparations for destroying noxious plants, preparations for destroying noxious animals, fungicides; deodorants other than for human beings or for animals; air deodorising preparations; disinfectants for hygiene purposes, antiseptics, detergents for medical purposes.

- (260) AM 2015 76626 A
 (800) 1196626
 (891) 2013 10 10
 (731) PRIVATE JOINT STOCK COMPANY
 "INDUSTRIAL ASSOCIATION "KONTI"
 Bul. Shevchenko, 6-b, Donetsk 83015,
 Ukraine
 (540)

День и Ночь

- (511)
 30 – Coffee, tea, cocoa, sugar, rice, tapioca, sago, artificial coffee; flour and preparations made from cereals, bread, pastry and confectionery, ices; honey, treacle; yeast, baking-powder; salt, mustard; vinegar, sauces (condiments); spices; edible ices; bagels; farinaceous foods; pastries; bread rolls (confectionery); buns; sandwiches; waffles; waffle cakes; vermicelli (noodles); chips (cereal products); cereal products; seaweed (condiment); dragee (confectionery); yeast and not yeast baking; essences for foodstuffs; fruit jellies (confectionery); chewing gum; custard; frozen kefir; frozen yogurt; semi-frozen such as dumplings, ravioli, pancakes stuffed, pies, pizza, pancakes; substitutes spices (confectionery); aromatic preparations for food; marshmallow; marshmallow covered with chocolate; cocoa and coffee beverages; coffee beverages with milk; cocoa beverages with milk; cocoa-based ingredients for confectionery products; cocoa; cocoa mixes; cocoa powder; cocoa spreads; paskha (Easter cake); caramels (candy); gruel, for food; cakes; ketchup; crackers; starch foods; croissant; groats for human food; corn, milled; corn, roasted; corn bagels; corn flakes; confectionery for decorating Christmas trees; puff pastry stuffed; candy for food; meat gravies; mayonnaise; farinaceous food pastes; semolina; chow-chow (condiment); marzipan; almond confectionery; flour-milling products; pancakes; pancakes stuffed; gruel, with a milk base, for food; nutmegs (confectionery); mousses; muesli; tea-based beverages; chocolate beverages; infusions, not medicinal; donuts; dumplings; paste; cookies;

cookies glazed with chocolate; quiches (confectionery); meat pies; quiches with various fillings; pizza; natural sweeteners; chips (cereal products); pies; fondants (confectionery); dressings for salad; gingerbread; puddings; soya flour; soya sauce; sweetmeats (candy); rusks; rusks with additives; saltine-rusks; petit-beurre biscuits; dry mixture of spices; sushi; almond paste; cake pastry; dough for pizza; puff pastry; cakes; tomato sauce; fruit, citrus and berry ices; halvah; candy decorations for cakes; chocolate decorations for cakes; bakery; breadsticks; sugar confectionery; waffle candies; charlotte (cake); chocolate; chocolate candies; chocolate bars; chocolate figurines; chocolate beverages with milk; iced tea; meat pasty.

(260) AM 2015 76656 A
 (800) 1120645
 (891) 2014 01 30
 (731) ECKES-GRANINI GROUP GMBH
 Ludwig-Eckes-Platz 1, 55268 Nieder-Olm,
 Germany
 (540)



(591) Grey, red
 (511)
 32 – Beers; mineral waters and aerated waters and other nonalcoholic beverages; fruit beverages and fruit juices; syrups and other preparations for making beverages.

(260) AM 2015 76657 A
 (800) 1141125
 (891) 2014 02 04
 (731) NOVARTIS AG
 CH-4002 Basel, Switzerland
 (540)

BERMENO

(511)
 5 – Vaccines for human use.

(260) AM 2015 76658 A
 (800) 1141127
 (891) 2014 02 04
 (731) NOVARTIS AG
 CH-4002 Basel, Switzerland

(540)

VOXSERO

(511)
 5 – Vaccines for human use.

(260) AM 2015 76659 A
 (800) 1156323
 (891) 2014 02 01
 (731) GILEAD SCIENCES LIMITED
 IDA Business and Technology Park,
 Carrigtohill Co. Cork, Ireland

(540)

ZYDELIG

(511)
 5 – Pharmaceuticals.

(260) AM 2015 76661 A
 (800) 1175621
 (891) 2014 02 19
 (731) NOVARTIS AG
 CH-4002 Basel, Switzerland
 (540)

SUMVIXO

(511)
 5 – Vaccines for human use.

(260) AM 2015 76662 A
 (800) 1175622
 (891) 2014 02 19
 (731) NOVARTIS AG
 CH-4002 Basel, Switzerland
 (540)

STAVANTA

(511)
 5 – Vaccines for human use.

(260) AM 2015 76663 A
 (800) 1175623
 (891) 2014 02 19
 (731) NOVARTIS AG
 CH-4002 Basel, Switzerland
 (540)

STANVADE

(511)
 5 – Vaccines for human use.

(260) AM 2015 76664 A
 (800) 1175625
 (891) 2014 02 19
 (731) NOVARTIS AG
 CH-4002 Basel, Switzerland

(540)

HOLVIANT

(511)

5 – Vaccines for human use.

(260) AM 2015 76665 A

(800) 1175626

(891) 2014 02 19

(731) NOVARTIS AG

CH-4002 Basel, Switzerland

(540)

HOLVERO

(511)

5 – Vaccines for human use.

(260) AM 2015 76679 A

(800) 1197003

(891) 2013 12 10

(731) VIENNA INSURANCE GROUP AG Wiener

Versicherung Gruppe

Schottenring 30, A-1010 Vienna, Austria

(540)



(591) Black and red

(511)

36 – Insurance, financial affairs.

(260) AM 2015 76680 A

(800) 1197025

(891) 2013 11 20

(731) THE POLO/LAUREN COMPANY, L.P.

650 Madison Avenue, New York, NY 10022, USA

(540)



(591) Black, white

(511)

9 – Binoculars, pince-nez cases (eyeglass cases), pince-nez, pince-nez cases, pince-nez chains, pince-nez cords, pince-nez frames, pince-nez chains (eyeglass chains), pince-nez cords, (eyeglass cords), corrective glasses, spectacle cases, spectacle frames, spectacle glasses, spectacles (optics), cases for sunglasses, cords for sunglasses, frames for sunglasses, chains for sunglasses, sunglasses.

11 – Lighting apparatus.

14 – Precious metals and their alloys and goods made of these materials or coated therewith not included in other classes; jewelry articles, precious stones; timepieces and chronometric instruments.

18 – Attache cases, backpacks, beach bags, briefcases (leather goods), walking sticks, card cases (wallets), handbags, key cases, shoulder belts (straps) of leather, parasols, wallets, purses, clutches, school satchels (school bags), school satchels, saddlebags, shopping bags, carrying cases, covers for suits, travel bags, traveling trunks, suitcases, umbrellas, wallets.

20 – Furniture, mirrors, picture frames, pillows.

21 – Household or kitchen utensils and containers; combs and sponges; brushes (except paintbrushes); brush-making materials; glassware, porcelain and earthenware not included in other classes.

24 – Sheets, eiderdowns, bed blankets, duvet covers, pillow cases, pillow shams, bed covers, face towels (not of paper), table napkins of textile, table mats not of paper.

27 – Carpets, rugs, mats and matting, linoleum and other materials for covering existing floors, wall hangings (non-textile).

35 – Retail services and online retail store services offering clothing for men, women and children, footwear, headgear for wear, accessories and household collections.

(260) AM 2015 76682 A

(800) 1197036

(891) 2013 11 04

(731) "YEREVAN JEWELLERY PLANT-1

"GNOMON" OJSC

12 Arshakunyats Ave., 0023 Yerevan, Armenia

(540)



(591) Black, white, golden and khaki

(511)

14 – Ornaments, jewellery, ornaments of precious metal, watches, precious and semi-precious stones.

(260) AM 2015 76683 A

(800) 1197072

(891) 2013 11 06

(731) ROMEO (BEIJING) TRADE CO., LTD

No:105 The First Building, No:28 Wusheng

Xili, Chaoyang District, Beijing, China

(540)

Blue classic

(591) Black, white

(511)

9 – Spectacles (optics); sunglasses; pince-nez mountings; spectacle frames; pince-nez chains; pince-nez cords; correcting lenses (optics); eyeglass cases; spectacle glasses; protective goggles.

(260) AM 2015 76712 A

(800) 1197316

(891) 2013 11 21

(731) ACTAVIS GROUP PTC EHF

Reykjavikurvegi 76-78, IS-220 Hafnarfjordur, Iceland

(540)

PINOCHIN

(511)

5 – Pharmaceutical preparations and substances.

(260) AM 2015 76782 A

(800) 1197913

(891) 2014 01 16

(731) PIERRE FABRE DERMO-COSMETIQUE

45 Place Abel Gance, F-92100 BOULOGNE, France

(540)

CELL CAPITAL

(511)

3 – Cosmetic products for skin care, particularly creams, milks, lotions, gels, fluids, serums, elixirs.

5 – Pharmaceutical products; skin care and hygiene preparations.

(260) AM 2015 76783 A

(800) 1197933

(891) 2014 02 05

(731) DIAGEO BRANDS B.V.

Molenwerf 10-12, NL-1014 BG Amsterdam, Netherlands

(540)

DIMPLE GOLDEN SELECTION

(511)

33 – Alcoholic beverages (except beers).

(260) AM 2015 76982 A

(800) 1199653

(891) 2014 02 03

(731) OBSHESTVO S OGRANICHENNOY

OTVETSTVENNOSTYU
"MASLOEKSTRAKTSIONNIY ZAVOD
YUG RUSI"

Tolstogo sq., 8, RU-344037 Rostov-on-Don, Russian Federation

(540)



(591) Brown, dark brown, light brown, beige,

yellow, light yellow, dark yellow, orange,

gray, red, light red, dark red, white, blue, dark

blue, light blue, azure, green and dark green

(526) The trademark is protected as a whole. The words "МАСЛО ПОДСОЛНЕЧНОЕ", "РАФИНИРОВАННОЕ" and "ДЕЗОДОРИРОВАННОЕ" included therein shall not be subject to independent legal protection.

(511)

29 – Sunflower oil for food.

(260) AM 2015 76983 A

(800) 1199656

(891) 2014 03 15

(731) DR. ING. H.C. F. PORSCHE

AKTIENGESELLSCHAFT

Porscheplatz 1, 70435 Stuttgart, Germany

(540)

911

(511)

12 – Motor vehicles and their parts.

(260) AM 2015 76989 A

(800) 1199659

(891) 2014 01 06

(731) EFE TUR TASIMACILIK PETROL

OTOMOTIV YEDEK PARÇA TURIZM

SANAYI VE TICARET LIMITED SIRKETI

Ömeraga Mah. Sahabettin Bilgius, Cad.

No:13, Izmit Kocaeli, Turkey

(540)



(591) White, dark blue, light blue

(511)

39 – Land transport, air transport, marine transport; storage/warehousing; arranging of travel tours; car transport, ferry-boat transport, bus transport, taxi transport; transportation information; sightseeing (tourism); passenger transport, transporting furniture, delivery of goods, freighting, parcel delivery,

courier services (messages or merchandise), message delivery, freight forwarding, escorting of travelers, travel reservation.

(260) AM 2015 76990 A

(800) 1199661

(891) 2014 02 06

(731) SHENZHEN FOSCAM INTELLIGENT TECHNOLOGY CO.,LTD.
05D, North Wing, 5/F, Block 1, Vision, Shenzhen Business Park, No:9 Gaoxin 9th South Road, Shenzhen Hi-tech Industrial Park, Nanshan District 518057 Shenzhen (CN), China

(540)

FOSCAM
福斯康姆

(591) Black, white

(511)

9 – Computer peripheral equipment; integrated circuits; copying machines (photoelectric, electrostatic, heat); material for electricity mains [wires, cables]; electronic notice boards; network communication equipment; camcorders; cameras [photography]; surveying apparatus and instruments; theft prevention installations, electric.

(260) AM 2015 76991 A

(800) 1199668

(891) 2013 09 18

(731) ALEKSANDR VALEREVICH BOYARINTSEV
bulvar Engelsa, d. 2, kv. 376, Volgogradskaya oblast, RU-400112 Volgograd, Russian Federation

(540)

БР  **НЯ**

(591) Black, white

(511)

1 – Chemicals used in industry, science and photography, as well as in agriculture, horticulture and forestry; unprocessed artificial resins, unprocessed plastics; manures; fire extinguishing compositions; tempering and soldering preparations; chemical substances for preserving foodstuffs; tanning substances; adhesives used in industry; chemical preparations for the manufacture of paints; oil cement [putty].

2 – Paints, varnishes, lacquers; preservatives against rust and against deterioration of wood; colorants; mordants; raw natural resins; metals in foil and powder form for painters, decorators, printers and artists; primers; titanium dioxide [pigment]; indigo [colorant]; alizarine dyes; aniline dyes; colorants; alumi-

nium paints; asbestos paints; bactericidal paints; wood stains; ceramic paints; marking ink for animals; distempers; fireproof paints; enamels for painting; bitumen varnish; copal varnish; mastic [natural resin]; pigments; coatings [paints]; undercoating for vehicle chassis; anti-corrosive preparations; protective preparations for metals; thinners for paints; thinners for lacquers; whitewash; anti-rust greases; badi-geon; anti-rust preparations for preservation; wood preservatives; fixatives [varnishes]; enamels [varnishes]; silver emulsions [pigments].

17 – Rubber, gutta-percha, gum, asbestos, mica and goods made from these materials and not included in other classes; plastics in extruded form for use in manufacture; flexible pipes, not of metal; dielectrics [insulators]; lute; insulators; insulating paints; insulating varnish; latex [rubber]; boiler composition to prevent the radiation of heat; acrylic resins [semi-finished products]; synthetic resins [semi-finished products].

35 – Advertising; business management; business administration; office functions; demonstration of goods; presentation of goods on communication media, for retail purposes; publication of publicity texts; radio advertising; distribution of samples; direct mail advertising; on-line advertising on a computer network.

(260) AM 2015 77063 A

(800) 1200511

(891) 2014 01 27

(731) CHENGDU AIMINER LEATHER PRODUCTS CO., LTD.
No:16, Wenchangzhonglu, Cuqiao, Wuhou District, Chengdu City, 610043 Sichuan Province, China

(540)



(591) Black, white

(511)

25 – Clothing, namely, shirts and pants, boots, footwear, boots for climbing, sports shoes, sandals, headgear for wear, hosiery, neckties, belts [clothing].

(260) AM 2015 77064 A

(800) 1200521

(891) 2014 02 13

(731) FIDIA FARMACEUTICI S.P.A.
Via Ponte della Fabbrica, 3/A, I-35031 Abano Terme, Italy

(540)

ИТАМИ

(511)

5 – Pharmaceutical and veterinary preparations; sanitary preparations for medical purposes; dietetic substances adapted for medical use, food for babies; plasters, materials for dressings; material for stopping teeth, dental wax; disinfectants; preparations for destroying vermin; fungicides, herbicides.

(260) AM 2015 77066 A

(800) 1200635

(891) 2014 03 07

(731) AMF GRUNDINVEST GMBH

Blutenfeldplatz, 76532 Baden-Baden, Germany

(540)



(591) Dark blue, light blue, yellow, orange, red, violet and green

(511)

5 – Pharmaceutical preparations.

44 – Hospitals; health centers; pharmacists' services to make up prescriptions; pharmacy advice.

(260) AM 2015 77067 A

(800) 1200556

(891) 2013 11 18

(731) ROCKWELL AUTOMATION, INC.

1201 South Second Street, Milwaukee, WI 53204, USA

(540)

ROCKWELL AUTOMATION

(526) The trademark is protected as a whole. The word "AUTOMATION" included therein shall not be subject to independent legal protection.

(511)

7 – Elevating and conveying machinery and power transmission machinery, namely, shaft supports, shaft hangers, bearings, shaft couplings, collars, clutches, gears, sheaves, sprockets, pulleys, electric motors, and parts thereof.

9 – Electrical and electronic controls and systems namely, industrial control and building maintenance systems namely, programmable logic controllers, input/output devices, including analog and digital in-

put/output devices for use in the field of industrial control and building maintenance; electrical and electronic controls and systems, namely, motor drives, motion controllers, servo drives, industrial computers and workstations, namely a computer monitor, keyboard and mouse, operator interface devices, namely operator terminals and operator monitors, message displays, alpha/numeric displays, touch screens, and push button displays; circuit protection devices, namely disconnects, over load relays, contact switches, and circuit breakers; wiring systems, namely specialized cable and connectors assemblies; push buttons, touch buttons, relay, timers, signaling devices namely stackable tower lights and sound modules; terminal blocks, network communication devices, namely electronic interfaces, and circuit boards; electrical and electronic motor control centers, electrical motor starters including solid state and manual starters, electrical contactors, over load relays, motor and line protection devices, namely current relays, thermistor protection relays, control circuit transformers, trip current relays, line voltage and line current monitors, arcing ground fault sensors, arcing ground fault relays and control circuit transformers; emergency stop devices, namely push buttons, trip switches, light curtains, touch cables, and interlock switches; safety floor mats; sensors, namely photo electric sensors, inductive, capacitive and ultrasonic proximity sensors, limit switches, encoders, speed sensors, pressure sensors, temperature sensors and safety switches; computer software for providing human machine interface and visualization, communications over a network and between application programs, information management, logic programming, scheduling, simulation validation, archiving, logic and processed control, computer software for use in the design, operation and maintenance of industrial automation processes.

42 – Design for others, consulting services, namely, computer consulting services, information technology consultancy and consulting services concerning industrial networks controller programming, human-machine interfaces and delivery of solutions to customers, all in the field of industrial automation, engineering services and computer programming services in the fields of industrial automation and building maintenance; technical support services, namely trouble shooting of computer hardware and software problems via telephone, email, electronically and in person; installation, repair and maintenance of computer software used in the industrial automation and building maintenance fields.

(260) AM 2015 77068 A

(800) 1200574

(891) 2014 01 31

(731) JINJIANG YIREN SHOES CO., LTD.

Junken Farm Industrial Area, Xibin Town, Jinjiang City, Fujian Province, China

(540)

Löffler

(591) Black, white

(511)

25 – Shoes; football shoes; clothing; hats; hosiery; swimsuits; leather belts for clothing; neckties; cyclists' clothing; sports shoes.

(260) AM 2015 77069 A

(800) 1200609

(891) 2014 02 05

(731) OBSHESTVO S OGRANICHENNOY OTVETSTVENNOST'U "HENKEL RUS" Kolokolnikov pereulok, 11, RU-107045 Moscow, Russian Federation

(540)

ХозЛента

(511)

16 – Adhesive tapes for stationery or household purposes.

(260) AM 2015 77070 A

(800) 1200628

(891) 2014 03 11

(731) MERCK KGAA Frankfurter Strasse 250, 64293 Darmstadt, Germany

(540)

FEMIBION

(511)

5 – Pharmaceutical preparations; dietetic preparations for medical use, food supplements for medical use, materials for dressings; medicated creams.

(260) AM 2015 77071 A

(800) 1200677

(891) 2014 02 26

(731) MPEX PHARMACEUTICALS, INC. 100 Somerset Corporate Boulevard, Bridgewater NJ 08807, USA

(540)

QUINSAIR

(591) Black, white

(511)

5 – Pharmaceutical preparations, namely, antibiotics.

(260) AM 2015 77080 A

(800) 1200699

(891) 2013 10 23

(731) WORLD MEDICINE İLAÇ SANAYİ VE TİCARET LİMİTED ŞİRKETİ Evren Mah. Camiyolu Cad. No:50 K:1 B, Zemin 4-5-6, Güneşli Bağcılar İstanbul, Turkey

(540)

ACTONİD

(591) Black, white

(511)

5 – Medicines for human purposes, medicines for veterinary purposes, vitamin preparations, chemical preparations for medical purposes, dietetic substances adapted for medical use; dietetic foods adapted for medical purposes; baby foods, medicinal herbs, herbal beverages adapted for medical purposes, nutritional supplements, pollen dietary supplements, mineral food supplements, protein dietary supplements; medicines for dental purposes, hygienic products for medical purposes including sanitary pads, breast-nursing pads and bunion pads, waddings for medical purposes, plasters for medical purposes, dressings for medical purposes, babies' napkins, preparations for destroying noxious plants, preparations for destroying noxious animals, fungicides, deodorants other than for human beings or for animals, air deodorising preparations, disinfectants for hygiene purposes, antiseptics, detergents for medical purposes.

(260) AM 2015 77081 A

(800) 1200702

(891) 2014 03 13

(731) DIAGEO BRANDS B.V. Molenwerf 10-12, NL-1014 BG Amsterdam, Netherlands

(540)

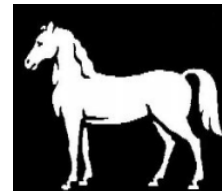

(591) Black, white

(511)

33 – Alcoholic beverages.

(260) AM 2015 77084 A

(800) 1200769

(891) 2013 10 23

(731) WORLD MEDICINE İLAÇ SANAYİ VE TİCARET LİMİTED ŞİRKETİ Evren Mah. Camiyolu Cad. No.50 K.1B, Zemin -4-5-6, GÜNEŞLİ/BAĞCILAR/İS-TANBUL, Turkey

(540)

FORALES

(591) Black, white

(511)

5 – Medicines for human purposes, medicines for veterinary purposes, vitamin preparations, chemical preparations for medical purposes, dietetic substances

ces adapted for medical use; dietetic foods adapted for medical purposes; baby foods, medicinal herbs, herbal beverages adapted for medical purposes, nutritional supplements, pollen dietary supplements, mineral food supplements, protein dietary supplements; medicines for dental purposes, hygienic products for medical purposes including sanitary pads, breast nursing pads and bunion pads, waddings for medical purposes, plasters for medical purposes, dressings for medical purposes, babies' napkins, preparations for destroying noxious plants, preparations for destroying noxious animals, fungicides, deodorants other than for human beings or for animals, air deodorising preparations, disinfectants for hygiene purposes, antiseptics, detergents for medical purposes.

(260) AM 2015 77085 A
(800) 1200792
(891) 2013 11 12
(731) BOUCHERON HOLDING
26 Place Vendôme, F-75001 PARIS, France
(540)

BOUCHERON

(511)
35 – Advertising, radio and television advertising, online advertising on networks; information technology; advertising management; direct mail advertising (tracts, samples, prospectuses, printed matter, free newspapers), dissemination of advertising matter; placing of advertisements, advertising mailing, publication of advertising texts, sales promotion for others, rental of advertising space, rental of advertising time by any means of communication; business management assistance to industrial or commercial companies, consulting on business organization, management, information or inquiries, information compilation, economic forecasting, market study and research; presentation of goods on any means of communication for the retail sale of a variety of goods and services, namely in the fields of jewelry, jewels and watchmaking (rings, bracelets, necklaces (jewelry), earrings, brooches (jewelry), pendants (jewelry), medals, cuff links, tie pins, key rings (trinkets or fobs), caskets (cases), jewelry cases (caskets), timepieces and chronometric instruments, watches, wristwatches, clocks, pendulum clocks (watchmaking), chronometers, chronographs (watches), watch cases, movements for timepieces, watch straps, watch chains, watch glasses, presentation cases for timepieces, cases for timepieces, statues and statuettes of precious metal), fashion (clothing, footwear, hats, spectacles, belts), leather goods and luggage, beauty and hygiene (cosmetics, soaps, perfumery products, essential oils, sanitary products, toilet articles); commercial administration of the licensing of products for others; import-export agencies; commercial information agencies; supply ser-

vices for third parties (purchase of goods for other companies); commercial information and advice for consumers (consumer advice shop); organization of fashion shows for promotional purposes; demonstration of products; auctioneering; arranging of exhibitions and/or fairs for commercial or advertising purposes; marketing; sales promotion for others; shop window dressing.

(260) AM 2015 77086 A
(800) 1200804
(891) 2014 01 31
(731) JOHNSON MATTHEY PUBLIC LIMITED
COMPANY
5th Floor, 25 Farringdon Street, London
EC4A 4AB, United Kingdom
(540)

Nitro-Lok

(511)
1 – Precious metal gauze catalysts.

(260) AM 2015 77087 A
(800) 1200805
(891) 2014 01 31
(731) JOHNSON MATTHEY PUBLIC LIMITED
COMPANY
5th Floor, 25 Farringdon Street, London
EC4A 4AB, United Kingdom
(540)

Hi-Lok

(511)
1 – Precious metal gauze catalysts.

(260) AM 2015 77272 A
(800) 1202443
(891) 2013 10 04
(731) WORLD MEDICINE İLAÇ SANAYİ VE
TİCARET LİMİTED ŞİRKETİ
Evren Mah. Camiyolu Cad. No.50 K.1B,
Zemin -4-5-6, GÜNEŞLİ/BAĞCILAR/İS-
TANBUL, Turkey
(540)

LISTORA ЛИСТОРА

(591) Black, white
(511)
5 – Medicines for human purposes, medicines for veterinary purposes, vitamins, chemical preparations for medical purposes, dietetic substances adapted for medical use; dietetic foods adapted for medical purposes; amino acids for medical purposes, nutritional supplements, pollen dietary substances, mineral food supplements, protein dietary supplements, baby foods, medicinal herbs, herbal beverages adapted for

medical purposes; medicines for dental purposes, hygienic products for medical purposes including pads, waddings for medical purposes, plasters for medical purposes, dressings for medical purposes; preparations for destroying noxious plants, preparations for destroying noxious animals, fungicides; deodorants other than for human beings or for animals; air deodorising preparations; disinfectants for hygiene purposes, antiseptics, detergents for medical purposes.

(260) AM 2015 77273 A

(800) 1202452

(891) 2013 09 11

(731) VITOL HOLDING B.V.

K.P. van der Mandelelaan 130, NL-3062 MB
Rotterdam, Netherlands

(540)

VITOL

(511)

1 – Chemicals used for industrial purposes including in the processing of gas, industrial oils and greases, lubricants, dust absorbing, wetting and binding compositions, fuels (including motor spirit), coal, common metals and their alloys, namely, zinc and non-ferrous metals; methanol.

4 – Industrial oils and greases; lubricants; dust absorbing, wetting and binding compositions; fuels (including motor spirit); coal; benzene; petroleum (crude or refined), petroleum derivatives and petroleum-based fuel; liquid, solid and gaseous fuels; motor fuel; gas and liquid petroleum gas; lubricants; paraffin and illuminating waxes; non-chemical additives for motor fuel, fuels and lubricants; naphtha; ethanol.

35 – Wholesale trade in natural resources including, oil, metals, minerals and natural gasses; trade in grain, rice, sugar, crude sugar and other agricultural products and foodstuffs; wholesale trade in chemicals used for industrial purposes, coal, common metals and their alloys, namely, zinc and non-ferrous metals; wholesale trade in naphtha, ethanol, methanol; wholesale trade in petroleum derivatives and petroleum-based preparations, paraffin and waxes, illuminants, non-chemical additives for motor fuel, fuels and lubricants; business organization advice relating to business risks in the field of the trade in natural resources.

36 – Financial consultancy, financial analysis, securities brokerage, financial appraisals and financing activities all in the field of natural resources; financial services for risk management in the field of natural resources.

37 – Extraction of oil; drilling for oil and gas; extraction of gas from gas fields; mining for minerals and drilling for natural gasses; extraction of petroleum and mining for other fuels, ores and metals; fu-

elling of aircrafts and ships; fuelling of vehicles; maintenance and repair of aircrafts and aircraft engines; fuel bunkering services.

39 – Transportation, package and storage of natural resources including oil, metals, minerals and natural gasses; transportation, package and storage of grain, rice, sugar, crude sugar and other agricultural products and foodstuffs; transportation, package and storage of chemicals used for industrial purposes, coal, common metals and their alloys, namely, zinc and non-ferrous metals; transportation, package and storage of naphtha, ethanol, methanol; transportation, package and storage of petroleum derivatives and petroleum-based preparations, paraffin and waxes, illuminants, non-chemical additives for motor fuel, fuels and lubricants; transportation, storage and distribution [transport] of oil and fuel (including jet fuels).

40 – Oil refinery services; treatment of minerals and natural gasses; blending of crude oil and synthetic oils; treatment of naphtha, ethanol, methanol; treatment of gas and liquid petroleum gas, of lubricants, of paraffin and of waxes and illuminants; treatment of coal and benzene.

42 – Geophysical exploration for the oil, gas and mining industries; scientific analysis and testing for oil, gas and mineral installation; analysis for oil field exploitation; analysis for the exploration of metals, minerals and natural gasses; conducting feasibility studies (technical research) relative to oil field exploitation, mineral exploitation and natural gas (fields) exploitation.

(260) AM 2015 77274 A

(800) 1202467

(891) 2014 02 25

(731) OBSHCHESTVO S OGRANICHENNOY
OTVETSTVENNOSTYU "MIR OFISA"
ul. Okruzhnaya, d. 6A, RU-440031 Penza,
Russian Federation

(540)



(591) White, yellow-brown, gray-white, green, red and black

(511)

5 – Balms for medical purposes; mineral waters for medical purposes; thermal water; dietary fiber; hormones for medical purposes; mustard for pharmaceutical purposes; mineral food supplements; nutritional supplements for medical purposes; capsules

for medicines; cachets for pharmaceutical purposes; candy for medical purposes; candy, medicated; medicinal roots; medicines for alleviating constipation; medicinal oils; drugs for medical purposes; medicines for human purposes; royal jelly for pharmaceutical purposes; milk ferments for pharmaceutical purposes; lacteal flour for babies; mint for pharmaceutical purposes; linseed meal for pharmaceutical purposes; medicinal infusions; tinctures for medical purposes; opium; opodeldoc; decoctions for pharmaceutical purposes; pills for pharmaceutical purposes; leeches for medical purposes; vitamin preparations; opotherapy preparations; bath preparations, medicated; medicinal hair growth preparations; chemico-pharmaceutical preparations; albuminous foodstuffs for medical purposes; dietetic foods adapted for medical purposes; food for babies; by-products of the processing of cereals for dietetic or medical purposes; linseed for pharmaceutical purposes; syrups for pharmaceutical purposes; soporifics; styptic preparations; vermifuges; appetite suppressants for medical purposes; medical preparations for slimming purposes; parasiticides; mouthwashes for medical purposes; febrifuges; depuratives; laxatives; tonics [medicines]; nervines; digestives for pharmaceutical purposes; medicinal herbs; fennel for medical purposes; diabetic bread adapted for medical use; chloroform; herbal teas for medicinal purposes; slimming tea for medical purposes; extracts of hops for pharmaceutical purposes; elixirs [pharmaceutical preparations]; ethers for pharmaceutical purposes; esters for pharmaceutical purposes.

(260) AM 2015 77278 A
 (800) 1202482
 (891) 2014 02 18
 (731) OLEKSANDR STANISLAVOVYCH BOZHKO
 prov. Novyi, 12, s. Potash, Mankivskii r-n,
 Cherkaska obl. 20100;
 ANDRII SERHIIOVYCH KOVALENKO
 vul. Lenina, bud. 58, kv. 4, m. Smila,
 Cherkaska obl. 20700, Ukraine

(540)

Mirado

(591) Black, white
 (511)

11 – Heat accumulators; hot air apparatus; heating elements; hot plates; radiator caps; stoves (heating apparatus); heating installations; heating installations (water); heating apparatus; heating apparatus, electric; radiators (heating); radiators, electric; central heating radiators.

(260) AM 2015 77279 A
 (800) 1202488
 (891) 2014 02 28
 (731) KEYSIGHT TECHNOLOGIES, INC.
 1400 Fountaingrove Parkway, Santa Rosa CA
 95403, USA

(540)



(591) Black, white
 (511)

9 – Electronic, opto-electronic, photonic, and nano-scale test, signaling, imaging, and measurement apparatus, instruments, systems, and equipment, and parts, components and accessories therefor; optical and imaging apparatus, instruments, and equipment, and parts, components and accessories therefor; monolithic optical assemblies and laser combiners for electronic and scientific apparatus, instruments, and systems; scientific and laboratory apparatus, instruments, and equipment, and parts, components and accessories therefor; electronic and electrical apparatus, instruments, and equipment, and parts, components and accessories therefor; lasers; microscopes; monitoring apparatus; recording apparatus; processors; microprocessors; detectors; sensors; transmitters; receivers; remote control apparatus; motion control apparatus; computers; computer hardware; computer peripherals; computer software; computer programs; software, namely, design automation software; software, namely, measurement application software; software, namely, electronic circuit design automation software for modeling, simulation and design of electronic parts, components, assemblies, and systems; software and software components for instrument control, analysis, and measurements; data storage devices; data processing apparatus; power supplies and power systems; source measure analyzers; power quality monitors for electronic and industrial apparatus, instruments, and systems.

(260) AM 2015 77280 A
 (800) 1202521
 (891) 2013 12 09
 (731) ARAMARK ORGANIZATIONAL
 SERVICES, INC.
 14 Par-La-Ville, P.O. Box HM 2257,
 3rd Floor, Hamilton HM JX, Bermuda
 (540)



(591) Black, white
 (511)

25 – Wearing apparel, namely, shirts, pants, shorts, jackets, coats, caps, hats, socks, panty hose, coveralls, overalls, rainwear, underwear, gloves, sweaters, laboratory coats, smocks, belts, suspenders, aprons, vests, sweatshirts, visors, t-shirts, face-warming masks, scarves, skirts, dresses, sports coats, ties and uniforms.

35 – Business management services; personnel management consulting services; advertising consulting services; and billing and reimbursement services provided to hospitals and medical care providers; business management consultancy, including giving assistance and advising in the establishment of retail stores in airports in the field of souvenirs and novelty items; the bringing together, for the benefit of others, of souvenirs and novelty items, except the transport thereof, enabling consumers to conveniently watch and purchase those goods; business management consultancy, including giving assistance and advising in the establishment of retail stores in the field of wearing apparel and related articles, the bringing together, for the benefit of others, of wearing apparel and related articles, except the transport thereof, enabling consumers to conveniently watch and purchase those goods; wholesale distributorships featuring books, periodicals, and printed matter; retail shop services at airports featuring souvenirs and novelty items; retail store and mail order catalog services in the field of wearing apparel and related articles.

37 – Maintenance and repair services for electrical appliances, heaters, ventilation units, and air conditioners; janitorial and custodial services, namely, building cleaning services, hard surface floor and carpet care, window cleaning, curtain and blind cleaning, upholstery cleaning, trash collection and housekeeping service; maintenance and repair for educational, medical, corporate, industrial, and residential facilities.

40 – Custom manufacture and sewing repair of garments to the order and specification of others.

42 – Interior decorating services and design services for others in the field of food service operations.

43 – Providing food, refreshment, and beverage services; restaurant services; lodging services; child care centers.

44 – Healthcare services; planning contract medical service programs; quality assurance services provided to hospitals and medical care providers; nutrition counseling and fitness awareness programs; landscaping services.

45 – Rental of clothing and uniforms, linens, and clean room garments.

(260) AM 2015 77281 A

(800) 1202524

(891) 2013 10 28

(731) OBCHTCHESTVO S OGRANITCHENNOY OTVETSTVENNOSTYU "STRATEGUIYA" 78-26, oul. Aguibalova, RU-443041 Samara, Russian Federation

(540)

«ЖИГУЛИ авторское»

(511)

32 – Beers; mineral and aerated waters and other non-alcoholic beverages; fruit beverages and fruit juices; syrups and other preparations for making beverages; beverages containing beer; non-alcoholic malt beverages other than for medical use; cocktails containing beer; must; malt wort; beer wort; kvass [non-alcoholic beverage]; non-alcoholic honey-based beverages; extracts of hops for making beer.

(260) AM 2015 77282 A

(800) 1202558

(891) 2014 01 16

(731) ZVERINATU ADVOKATU BIROJS

"RSP UN PARTNER (RÖDL & PARTNER)"

Kronvalda bulv. 3-1, LV-1010 Riga, Latvia

(540)

RSP

(511)

35 – Payroll preparation, cost and price analysis, professional business consultancy, consulting in business organization and affairs, personnel management consultancy, business management and organization consultancy, business management consultancy, accounting, auditing, computer-aided file management, business appraisals, efficiency experts, employment agencies, personnel recruitment, psychological testing for the selection of personnel, business management planning, tax preparation, economic forecasting; systemization of information into computer databases; compilation of information into computer databases; procurement of user access authorization to different communication networks, namely intermediation of landline contracts and intermediation of mobile network contracts for third parties.

36 – Insurance consultancy, financial analysis, financial consultancy, mutual funds, property management, real estate appraisal, housing agents, real estate agencies, real estate management, health insurance, life insurance, services of pension funds, fiscal assessments, accident insurance, underwriting intermediation of insurance, financial management, trusteeship, insurance consultancy, insurance underwriting.

42 – Updating of computer software; design of computer software; computer consultancy services; recovery of computer data; maintenance of computer software; computer system analysis; rental of database access time (computer services); computer programming; rental of data processing devices; leasing of computer access time for data processing (computer services); quality testing.

45 – Legal services and legal representation; investigations in legal matters; arbitration services; consulting in copyright and intellectual property rights.

(260) AM 2015 77283 A
 (800) 1202584
 (891) 2014 02 25
 (731) FUJIAN JINYUAN FASHION CO., LTD.
 Jinyuan Industrial Park, Baogai Science and
 Technology Park, Shishi, Fujian, China
 (540)

Jinyuan 金苑

(591) Black, white
 (511)
 25 – Clothing; layettes [clothing]; waterproof clothing; footwear; hats; hosiery; scarfs; leather belts [clothing]; wedding dresses; gloves [clothing].

(260) AM 2015 77629 A
 (800) 1034296
 (891) 2014 03 21
 (731) ALL ROUND IP B.V.
 Elswout 6, NL-5655 JS Eindhoven,
 Netherlands
 (540)

Mi Moneda

(511)
 14 – Precious metals and their alloys and goods in precious metal or coated therewith, not included in other classes; jewellery, precious stones; horological and chronometric instruments.

18 – Leather and imitations of leather, and goods made of these materials and not included in other classes; animal skins, hides; trunks and travelling bags; umbrellas, parasols and walking sticks; whips, harness and saddlery.

25 – Clothing, footwear, headgear.

(260) AM 2015 77630 A
 (800) 1045133
 (891) 2014 03 14
 (731) UPM RAFLATAC OY
 Tesomankatu 31, FI-33310 Tampere, Finland
 (540)

UPM Raflatac

(511)
 16 – Self-adhesive laminates in the form of reels, sheets and labels; security and anti-theft labels and laminates made of paper or cardboard.

17 – Plastic-based and/or of synthetic material manufactured self-adhesive laminates in the form of reels, sheets and labels; self-adhesive thermal and pressure sensitive laminates in the form of reels, sheets and labels.

(260) AM 2015 77631 A
 (800) 1051925
 (891) 2014 04 02
 (731) BAYER CONSUMER CARE AG
 Peter Merian-Strasse 84, CH-4052 Basel,
 Switzerland
 (540)

HA30JI

(511)
 5 – Pharmaceutical preparations.

(260) AM 2015 77632 A
 (800) 1054299
 (891) 2014 04 07
 (731) SELO MEDICAL GMBH
 Moosham 29 A-5585 Unternberg, Austria
 (540)

SELOGYN

(511)
 5 – Pharmaceutical preparations, exclusively for gynecological purposes and for vaginal use.

(260) AM 2015 77633 A
 (800) 1111426
 (891) 2014 04 03
 (731) ALMIRALL, S.A.
 Ronda General Mitre, 151, E-08022
 Barcelona, Spain
 (540)

TAZZLIRA

(511) 5 – Pharmaceutical preparations.

(260) AM 2015 77634 A
 (800) 1115300
 (891) 2014 04 03
 (731) ALMIRALL, S.A.
 Ronda General Mitre, 151, E-08022
 Barcelona, Spain
 (540)

DUVEKLIR

(511)
 5 – Pharmaceutical preparations.

(260) AM 2015 77635 A
 (800) 1156020
 (891) 2014 02 14
 (731) HEINEKEN ENTREPRISE
 2, rue des Martinets, F-92500 Rueil-
 Malmaison, France
 (540)



(591) Red and black
(511)
32 – Beers; mineral and aerated waters and other non-alcoholic beverages; beverages based on fruit and fruit juices; syrups and other preparations for making beverages (excluding those based on coffee, tea or cocoa, and milk beverages); non-alcoholic aperitifs.

33 – Alcoholic beverages (except beers); ciders; wines; spirits; liqueurs; alcoholic extracts or essences.

(260) AM 2015 77636 A

(800) 1168380

(891) 2014 04 14

(731) CHIPITA INDUSTRIAL AND
COMMERCIAL COMPANY
S.A. WITH THE DISTINCTIVE TITLE
CHIPTA S.A.

12th km National Road, Athens-Lamia,
GR-144 52 Metamorphosis, Greece

(540)



(591) Red, dark red and white

(511)

29 – Preserved and dried fruits and vegetables (raisins, sultanas, currants), crystallized fruits (candied lemon and orange peel), dates, processed nuts, potato products of all types (chips, crisps, sticks, flakes, fritters); frosted fruits, frozen fruits, fruit chips, fruit jellies, fruit-based snack food, jams, ginger jam, marmalade, peanut butter, compotes, spreads for bread slices (hazelnut or nougat or vanilla or with other flavor), edible oils and fats.

30 – Cocoa products, vanilla products, wheat flour, flour for food, flour and preparations made from cereals (except foodstuff for animals), cereal bars, cereal-based snack food, cereals prepared for human consumption (oat flakes and those made from other cereals), farinaceous foods, prepared baking mixtures for bread; cakes and small pastries, pancakes, cake paste, cake powder, candy decorations for cakes, rice cakes, rice-based snack food, flavorings for cakes other than essential oils, bread rolls, rusks, breadcrumbs, bread products of all types (chips, crisps, sticks), wafers, wafer rolls, filled with hazelnut or nougat or cocoa cream or vanilla, swiss rolls, croissants, cookies, biscuits, pastry and confectionery, nut confectionery, marzipan.

(260) AM 2015 77637 A

(800) 1179657

(891) 2014 05 26

(731) KONINKLIJKE DOUWE EGBERTS B.V.

Oosterdoksstraat 80, NL-1011 DK

Amsterdam, Netherlands

(540)



(591) Golden, various shades of red, dark brown and white

(511)

30 – Coffee, also coffee in filter packing, coffee-based beverages; coffee and coffee beverages containing milk, milk powder, coffee substitutes, cocoa, chocolate, cereals, fruits, sugar, herbs or spices or a combination of these products; coffee-extracts, instant coffee, coffee substitutes; tea, tea-based beverages, leaf tea, herbal tea other than for medicinal use, tea-extracts, instant tea, tea-substitutes; tea infusions, infusions; cocoa, cocoa-based beverages; chocolate and chocolate extracts in powder, granulated or liquid form; sugar, rice, tapioca, sago; flour and preparations made from cereals, bread, biscuits, cakes; pastry and confectionery, ices; honey, treacle; yeast; baking-powder; salt, mustard; pepper, vinegar, condiments; fruit sauces; spices; herbs for the preparation (making) of beverages; mixtures of herbs for the preparation (making) of beverages; mixtures mainly consisting of herbs with the addition of dried fruits for the preparation (making) of beverages; decoctions of herbs, not for medical use; ice.

**საერთაშორისო სასაქონლო ნიშნები,
რომლებსაც მიენიჭა დაცვა საქართველოში**

(260) AM 2014 71385 A
(800) 1150564
(151) 2012 12 13
(181) 2022 12 13
(511) 34

(260) AM 2014 73731 A
(800) 1171920
(151) 2013 05 23
(181) 2023 05 23
(511) 07

(260) AM 2014 72440 A
(800) 1159192
(151) 2013 04 03
(181) 2023 04 03
(511) 05

(260) AM 2014 74031 A
(800) 1174141
(151) 2013 06 22
(181) 2023 06 22
(511) 09

(260) AM 2014 72487 A
(800) 1159581
(151) 2013 03 28
(181) 2023 03 28
(511) 05, 35

(260) AM 2014 74037 A
(800) 1111893
(151) 2012 02 21
(891) 2013 07 19
(181) 2022 02 21
(511) 05

(260) AM 2014 72898 A
(800) 1162837
(151) 2013 01 31
(181) 2023 01 31
(511) 09

(260) AM 2014 74039 A
(800) 1119739
(151) 2012 04 20
(891) 2013 07 11
(181) 2022 04 20
(511) 07

(260) AM 2014 73380 A
(800) 1167795
(151) 2013 04 15
(181) 2023 04 15
(511) 32, 34

(260) AM 2014 74073 A
(800) 1174478
(151) 2013 06 20
(181) 2023 06 20
(511) 09, 35, 38, 42

(260) AM 2014 73630 A
(800) 1170716
(151) 2013 03 22
(181) 2023 03 22
(511) 05

(260) AM 2014 74227 A
(800) 1175936
(151) 2012 12 20
(181) 2022 12 20
(511) 08, 12, 21

(260) AM 2014 73644 A
(800) 1170830
(151) 2013 03 22
(181) 2023 03 22
(511) 05

(260) AM 2014 74531 A
(800) 1178730
(151) 2013 03 28
(181) 2023 03 28
(511) 01, 02, 04, 05, 06, 07, 08, 10, 11, 12, 13, 14,
15, 16, 17, 18, 19, 20, 21, 22, 23, 24, 25, 26,
27, 28, 29, 30, 31, 33, 34, 35, 36, 37, 38, 39,
40, 41, 42, 43, 44, 45

(260) AM 2014 73657 A
(800) 1171023
(151) 2013 07 16
(181) 2023 07 16
(511) 18, 25, 35

(260) AM 2014 74589 A
 (800) 1179287
 (151) 2012 11 26
 (181) 2022 11 26
 (511) 03, 35, 44

(181) 2023 08 30
 (511) 05

(260) AM 2014 74619 A
 (800) 1031897
 (151) 2010 02 02
 (891) 2013 06 20
 (181) 2020 02 02
 (511) 34

(260) AM 2014 74749 A
 (800) 1180752
 (151) 2013 09 16
 (181) 2023 09 16
 (511) 16, 41

(260) AM 2014 74735 A
 (800) 1180660
 (151) 2013 03 19
 (181) 2023 03 19
 (511) 09, 14, 25

(260) AM 2014 74752 A
 (800) 1180764
 (151) 2013 08 26
 (181) 2023 08 26
 (511) 13

(260) AM 2014 74738 A
 (800) 1180686
 (151) 2013 05 14
 (181) 2023 05 14
 (511) 05

(260) AM 2014 74753 A
 (800) 1180767
 (151) 2013 09 26
 (181) 2023 09 26
 (511) 10

(260) AM 2014 74739 A
 (800) 1180690
 (151) 2013 05 29
 (181) 2023 05 29
 (511) 06

(260) AM 2014 74764 A
 (800) 1180769
 (151) 2013 09 19
 (181) 2023 09 19
 (511) 09, 10

(260) AM 2014 74740 A
 (800) 1180696
 (151) 2013 07 12
 (181) 2023 07 12
 (511) 03, 05, 10

(260) AM 2014 74765 A
 (800) 1180777
 (151) 2013 09 30
 (181) 2023 09 30
 (511) 16, 25, 35, 41

(260) AM 2014 74741 A
 (800) 1180701
 (151) 2013 07 12
 (181) 2023 07 12
 (511) 06, 07, 11, 12, 14, 17, 19, 26, 40

(260) AM 2014 74766 A
 (800) 1180800
 (151) 2013 05 14
 (181) 2023 05 14
 (511) 05

(260) AM 2014 74746 A
 (800) 1180709
 (151) 2013 07 02
 (181) 2023 07 02
 (511) 35, 41, 42

(260) AM 2014 74767 A
 (800) 1180804
 (151) 2013 09 03
 (181) 2023 09 03
 (511) 05

(260) AM 2014 74748 A
 (800) 1180738
 (151) 2013 08 30

(260) AM 2014 74783 A
 (800) 1180805
 (151) 2013 08 26
 (181) 2023 08 26
 (511) 05

(260) AM 2014 74785 A (800) 1180807 (151) 2013 09 03 (181) 2023 09 03 (511) 05	(181) 2023 09 30 (511) 16, 25
(260) AM 2014 74786 A (800) 1180808 (151) 2013 08 26 (181) 2023 08 26 (511) 05	(260) AM 2014 74999 A (800) 1182921 (151) 2013 07 19 (181) 2023 07 19 (511) 32, 33, 43
(260) AM 2014 74787 A (800) 1180809 (151) 2013 08 26 (181) 2023 08 26 (511) 05	(260) AM 2014 75000 A (800) 1182922 (151) 2013 09 17 (181) 2023 09 17 (511) 05
(260) AM 2014 74788 A (800) 1180810 (151) 2013 09 25 (181) 2023 09 25 (511) 05	(260) AM 2014 75001 A (800) 1182926 (151) 2013 08 09 (181) 2023 08 09 (511) 11
(260) AM 2014 74789 A (800) 1180811 (151) 2013 09 25 (181) 2023 09 25 (511) 05	(260) AM 2014 75003 A (800) 1182940 (151) 2013 03 01 (181) 2023 03 01 (511) 09, 28, 38, 41, 42
(260) AM 2014 74790 A (800) 1180815 (151) 2013 08 23 (181) 2023 08 23 (511) 05	(260) AM 2014 75006 A (800) 1182953 (151) 2013 04 08 (181) 2023 04 08 (511) 09, 16, 21, 25, 28, 35, 41, 42
(260) AM 2014 74792 A (800) 1180855 (151) 2013 07 12 (181) 2023 07 12 (511) 06, 07, 11, 12, 14, 40	(260) AM 2014 75007 A (800) 1182958 (151) 2013 04 16 (181) 2023 04 16 (511) 17, 19
(260) AM 2014 74793 A (800) 1180881 (151) 2013 09 12 (181) 2023 09 12 (511) 17, 19	(260) AM 2014 75011 A (800) 1182978 (151) 2013 07 01 (181) 2023 07 01 (511) 35, 41, 43
(260) AM 2014 74998 A (800) 1182914 (151) 2013 09 30	(260) AM 2014 75012 A (800) 1182991 (151) 2013 08 23 (181) 2023 08 23 (511) 35, 37, 42

(260) AM 2014 75013 A
 (800) 1183046
 (151) 2013 08 16
 (181) 2023 08 16
 (511) 01, 05, 09, 10, 42

(181) 2023 04 16
 (511) 17, 19, 37, 42

(260) AM 2014 75014 A
 (800) 1183057
 (151) 2013 09 19
 (181) 2023 09 19
 (511) 30

(260) AM 2014 75142 A
 (800) 1184158
 (151) 2013 04 26
 (181) 2023 04 26
 (511) 09, 35

(260) AM 2014 75015 A
 (800) 1183062
 (151) 2013 09 23
 (181) 2023 09 23
 (511) 12, 35, 39

(260) AM 2014 75143 A
 (800) 1184189
 (151) 2013 07 25
 (181) 2023 07 25
 (511) 20, 24

(260) AM 2014 75016 A
 (800) 1183091
 (151) 2013 09 13
 (181) 2023 09 13
 (511) 33

(260) AM 2014 75144 A
 (800) 1184197
 (151) 2013 09 02
 (181) 2023 09 02
 (511) 14, 18, 25, 26

(260) AM 2014 75035 A
 (800) 1183296
 (151) 2013 05 15
 (181) 2023 05 15
 (511) 09, 11

(260) AM 2014 75152 A
 (800) 1184300
 (151) 2013 09 20
 (181) 2023 09 20
 (511) 06

(260) AM 2014 75044 A
 (800) 1183331
 (151) 2013 10 08
 (181) 2023 10 08
 (511) 30

(260) AM 2014 75153 A
 (800) 1184301
 (151) 2013 09 02
 (181) 2023 09 02
 (511) 09

(260) AM 2014 75129 A
 (800) 1183792
 (151) 2013 10 29
 (181) 2023 10 29
 (511) 34

(260) AM 2014 75154 A
 (800) 1184344
 (151) 2013 07 24
 (891) 2013 04 24
 (181) 2023 07 24
 (511) 02

(260) AM 2014 75139 A
 (800) 1184041
 (151) 2013 07 09
 (181) 2023 07 09
 (511) 18, 25, 35

(260) AM 2014 75155 A
 (800) 1184346
 (151) 2013 08 13
 (181) 2023 08 13
 (511) 03, 09, 14, 18, 25, 35

(260) AM 2014 75141 A
 (800) 1184147
 (151) 2013 04 16

(260) AM 2014 75252
 (800) 1184915
 (151) 2015 02 17
 (181) 2025 02 17
 (511) 33, 35

(260) AM 2014 75260
(800) 1185071
(151) 2015 02 17
(181) 2025 02 17
(511) 5

(260) AM 2014 75261
(800) 1185072
(151) 2015 02 17
(181) 2025 02 17
(511) 5

(260) AM 2014 75262
(800) 1185073
(151) 2015 02 17
(181) 2025 02 17
(511) 5

(260) AM 2014 75270
(800) 1185207
(151) 2015 02 17
(181) 2025 02 17
(511) 5

(260) AM 2014 75272
(800) 1185221
(151) 2015 02 17
(181) 2025 02 17
(511) 3

(260) AM 2014 75275
(800) 923264
(151) 2015 02 17
(181) 2025 02 17
(511) 30

(260) AM 2014 75276
(800) 1160271
(151) 2015 02 17
(181) 2025 02 17
(511) 05

ოფიციალური შეტყობინებები

სასაქონლო ნიშნები

რეგისტრაციის მოქმედების ვადის გაგრძელება

(111) M 1995 1234 R2

(156) 2015 12 04

(186) 2025 12 04

(732) ი. რ. სკუიბ & სანზ. ლ.ლ.კ.
ზე კორპორეიშენ ტრასტ კომპანისათვის,
1209 ორინჯ სტრიტი, უილმინგტონი,
ნიუ-კასლის ოლქი, 19801 დელავერი,
აშშ

(111) M 2005 16079 R1

(156) 2015 07 14

(186) 2025 07 14

(732) ბრისტოლ-მაიერს სკუიბ კომპანი
345 პარკ ავენიუ, ნიუ-იორკი, ნიუ-იორკი
10154, აშშ

(111) M 1995 1236 R2

(156) 2015 12 04

(186) 2025 12 04

(732) ი. რ. სკუიბ & სანზ. ლ.ლ.კ.
ზე კორპორეიშენ ტრასტ კომპანისათვის,
1209 ორინჯ სტრიტი, უილმინგტონი,
ნიუ-კასლის ოლქი, 19801 დელავერი,
აშშ

(111) M 2005 16080 R1

(156) 2015 07 14

(186) 2025 07 14

(732) ბრისტოლ-მაიერს სკუიბ ფარმა კომპანი
ე დელავერ ჯენერალ პარტნერშიფ
რუტ 206 & პროვინსლან როუდი,
პრინსტონი, ნიუ-ჯერზი 08540, აშშ

(111) M 1995 1237 R2

(156) 2015 12 04

(186) 2025 12 04

(732) ი. რ. სკუიბ & სანზ. ლ.ლ.კ.
ზე კორპორეიშენ ტრასტ კომპანისათვის,
1209 ორინჯ სტრიტი, უილმინგტონი,
ნიუ-კასლის ოლქი, 19801 დელავერი,
აშშ

(111) M 2005 16087 R1

(156) 2015 07 14

(186) 2025 07 14

(732) სოსიეტე დე პროდიუი ნესტლე ს.ა.
1800 ვევეი, შვეიცარია

(111) M 2005 15881 R1

(156) 2015 03 01

(186) 2025 03 01

(732) პრინკო კორპ.
ზნ, კრიეიშენ 4 როუდი, ჰსინჩუ საიენს
პარკი, ჰსინჩუ, ტაივანი, ჩინეთის
პროვინცია

(111) M 1995 491 R2

(156) 2015 01 21

(186) 2025 01 16

(732) ბრიტიშ ამერიკან ტობაკო (ბრენდზ) ინკ.
2711 სენტერვილ როუდი, სუიტ 300,
უილმინგტონი, დელავერი 19808, აშშ

(111) M 2005 15905 R1

(156) 2015 04 01

(186) 2025 04 01

(732) მაკდონალდ'ზ ინტერნეშენელ პროპერტი
კომპანი, ლტდ.
2711 სენტერვილ როუდი, სუიტ 400,
უილმინგტონი, დელავერი, აშშ

(111) M 1995 637 R2

(156) 2015 05 22

(186) 2025 05 22

(732) ჩაინა ტობაკო ჰუნან ინდასტრიალ კო.,
ლტდ.
ზნ188 სექცია 3 უანჯიალი ჟონგ როუდი,
იუპუა დისტრიქტი, ჩანგშა-სიტი, ჰუნანი,
ჩინეთი

უფლებების სრული გადასვლა

(111) M 2001 013874 R1
(732) ლუკოზად რიბენა სანტორი ლიმიტიდ
2 ლონგუოლკ როუდი, სტოკლეი პარკი,
აქსბრიჯი, UB11 1BA, გაერთიანებული
სამეფო
(770) სმითკლან ბიჩემ ლიმიტიდ
980 გრეიტ უესტ როუდი, ბრენტფორდი,
მიდლსექსი TW8 9GS, გაერთიანებული
სამეფო
(580) 2015 02 16

(111) M 2006 016427 R
(732) სვის ფარმა ინტერნეიშენალ აგ
ვალდმანშტრასე 8, 8001 ციურისი,
შვეიცარია
(770) ვარშავსკიე ზაკლადი ფარმაცეუტიჩნე
„პოლფა“ სპოლკა აკციინა
ულ. კაროლკოვა 22/24, 01-207 ვარშავა,
პოლონეთი
(580) 2015 02 06

(111) M 2009 019377 R
(732) სვის ფარმა ინტერნეიშენალ აგ
ვალდმანშტრასე 8, 8001 ციურისი,
შვეიცარია
(770) ვარშავსკიე ზაკლადი ფარმაცეუტიჩნე
„პოლფა“ სპოლკა აკციინა
ულ. კაროლკოვა 22/24, 01-207 ვარშავა,
პოლონეთი
(580) 2015 02 06

(111) M 2009 019419 R
(732) ჰეგო ლიმიტიდ
ლეოფოროს სპიროუ კიპრიანოუ 67,
კირიაკიდეს ბიზნეს სენტერი, 4003,
ლიმასოლი, კვიპროსი
(770) კარიგანელე ჰოლდინგს ლიმიტიდ
ანექსარტისიას & კირიაკოუ მაცი,
3 როუსოს ლიმასოლ ტაუერი,
10 ფლორი, 3040, ლიმასოლი, კვიპროსი
(580) 2015 02 16

(111) M 2011 021092 R
(732) სვის ფარმა ინტერნეიშენალ აგ
ვალდმანშტრასე 8, 8001 ციურისი,
შვეიცარია
(770) ვარშავსკიე ზაკლადი ფარმაცეუტიჩნე
„პოლფა“ სპოლკა აკციინა
ულ. კაროლკოვა 22/24, 01-207 ვარშავა,
პოლონეთი
(580) 2015 02 06

(111) M 2011 021093 R
(732) სვის ფარმა ინტერნეიშენალ აგ
ვალდმანშტრასე 8, 8001 ციურისი,
შვეიცარია
(770) ვარშავსკიე ზაკლადი ფარმაცეუტიჩნე
„პოლფა“ სპოლკა აკციინა
ულ. კაროლკოვა 22/24, 01-207 ვარშავა,
პოლონეთი
(580) 2015 02 06

(111) M 2011 021094 R
(732) სვის ფარმა ინტერნეიშენალ აგ
ვალდმანშტრასე 8, 8001 ციურისი,
შვეიცარია
(770) ვარშავსკიე ზაკლადი ფარმაცეუტიჩნე
„პოლფა“ სპოლკა აკციინა
ულ. კაროლკოვა 22/24, 01-207 ვარშავა,
პოლონეთი
(580) 2015 02 06

(111) M 2011 021096 R
(732) სვის ფარმა ინტერნეიშენალ აგ
ვალდმანშტრასე 8, 8001 ციურისი,
შვეიცარია
(770) ვარშავსკიე ზაკლადი ფარმაცეუტიჩნე
„პოლფა“ სპოლკა აკციინა
ულ. კაროლკოვა 22/24, 01-207 ვარშავა,
პოლონეთი
(580) 2015 02 06

(111) M 2011 021097 R
(732) სვის ფარმა ინტერნეიშენალ აგ
ვალდმანშტრასე 8, 8001 ციურისი,
შვეიცარია
(770) ვარშავსკიე ზაკლადი ფარმაცეუტიჩნე
„პოლფა“ სპოლკა აკციინა
ულ. კაროლკოვა 22/24, 01-207 ვარშავა,
პოლონეთი
(580) 2015 02 06

(111) M 2011 021099 R
(732) სვის ფარმა ინტერნეიშენალ აგ
ვალდმანშტრასე 8, 8001 ციურისი,
შვეიცარია
(770) ვარშავსკიე ზაკლადი ფარმაცეუტიჩნე
„პოლფა“ სპოლკა აკციინა
ულ. კაროლკოვა 22/24, 01-207 ვარშავა,
პოლონეთი
(580) 2015 02 06

(111) M 2011 021100 R
 (732) სვის ფარმა ინტერნეიშენალ აგ
 ვალდმანშტრასე 8, 8001 ციურიხი,
 შვეიცარია
 (770) ვარშავსკიე ზაკლადი ფარმაცეუტიჩნე
 „პოლფა“ სპოლკა აკციინა
 ულ.კაროლკოვა 22/24, 01-207 ვარშავა,
 პოლონეთი
 (580) 2015 02 06

(770) ვარშავსკიე ზაკლადი ფარმაცეუტიჩნე
 „პოლფა“ სპოლკა აკციინა
 ულ.კაროლკოვა 22/24, 01-207 ვარშავა,
 პოლონეთი
 (580) 2015 02 06

(111) M 2011 021101 R
 (732) სვის ფარმა ინტერნეიშენალ აგ
 ვალდმანშტრასე 8, 8001 ციურიხი,
 შვეიცარია
 (770) ვარშავსკიე ზაკლადი ფარმაცეუტიჩნე
 „პოლფა“ სპოლკა აკციინა
 ულ.კაროლკოვა 22/24, 01-207 ვარშავა,
 პოლონეთი
 (580) 2015 02 06

(111) M 1998 008668 R1
 (732) აპტუს 830. გმბჰ (ნიუკო)
 ამ ბოლშიაიდ 50, 56424 მოგენდორფი,
 გერმანია
 (770) მარს, ინკორპორეტიდ
 6885 ელმ სტრიტი მაკ-ლინი, ვირჯინია
 22101-3883, აშშ
 (580) 2015 02 13

(111) M 2011 021102 R
 (732) სვის ფარმა ინტერნეიშენალ აგ
 ვალდმანშტრასე 8, 8001 ციურიხი,
 შვეიცარია
 (770) ვარშავსკიე ზაკლადი ფარმაცეუტიჩნე
 „პოლფა“ სპოლკა აკციინა
 ულ.კაროლკოვა 22/24, 01-207 ვარშავა,
 პოლონეთი
 (580) 2015 02 06

(111) M 2013 024068 R
 (732) აარუსკარლჰამნ ინვესტ აბ
 ჯუნგმანსგატან, 12, 211 19 მალმე,
 შვედეთი
 (770) უნილევერ ნ.ვ.
 ვეენა 455, 3013 AL როტერდამი,
 ნიდერლანდი
 (580) 2015 02 09

(111) M 1996 003446 R1
 (732) სვის ფარმა ინტერნეიშენალ აგ
 ვალდმანშტრასე 8, 8001 ციურიხი,
 შვეიცარია
 (770) ვარშავსკიე ზაკლადი ფარმაცეუტიჩნე
 „პოლფა“ სპოლკა აკციინა
 ულ. კაროლკოვა 22/24, 01-207 ვარშავა,
 პოლონეთი
 (580) 2015 02 06

(111) M 1997 006652 R1
 (732) სვის ფარმა ინტერნეიშენალ აგ
 ვალდმანშტრასე 8, 8001 ციურიხი,
 შვეიცარია

მფლობელის სახელისა და/ან მისამართის ცვლილება

(111) M 2004 015605 R

(732) გარდიენ იუროპ ს.ა.რ.ლ.
ზონ ინდუსტრიელ ვოლსე, L-3452
დუდელანჟი, გრანდ დუს დე,
ლუქსემბურგი

(770) გარდიენ იუროპ ს.ა.
ცონ ინდუსტრიელ ვოლსე, L-3452
დუდელანჟი, გრანდ დუს დე,
ლუქსემბურგი

(580) 2015 02 11

(111) M 1998 008668 R1

(732) სერამის გმბჰ
ამ ბოლშაიდ 50, 56424 მოგენდორფი,
გერმანია

(770) აპტუს 830. გმბჰ (ნიუკო)
ამ ბოლშაიდ 50, 56424 მოგენდორფი,
გერმანია

(580) 2015 02 13

(111) M 1998 009710 R1

(732) გრეი გლობალ გრუპ ლლკ
დელავერის შეზღუდული პასუხისმგებ-
ლობის კომპანია
200 მესუთე ავენიუ, ნიუ-იორკი,
ნიუ-იორკი, აშშ

(770) გრეი გლობალ გრუპ ინკ.
200 მესუთე ავენიუ, ნიუ-იორკი,
ნიუ-იორკი, აშშ

(580) 2015 02 09

სასაქონლო ნიშნების რეგისტრაციის ბათილად ცნობა

(111) M 2004 15489 R
 (141) 2014 09 30, არ არის გადახდილი რეგისტრაციის შემდგომი 10 წლით გაგრძელების საფასური
 (732) კონ-უეი ინკ.
 2855 კამპუს დრაივი, სან-მატეო, კალიფორნია 94403, აშშ

(111) M 2004 15509 R
 (141) 2014 10 16, არ არის გადახდილი რეგისტრაციის შემდგომი 10 წლით გაგრძელების საფასური
 (732) ულქერ გილა სანაიი ვე თიჯარეთ ა.შ.
 დაეუთფაშა ჯადეხი N 10, 34015 თოფქაფი, სტამბოლი, თურქეთი

(111) M 2004 15490 R
 (141) 2014 09 30, არ არის გადახდილი რეგისტრაციის შემდგომი 10 წლით გაგრძელების საფასური
 (732) კონ-უეი ინკ.
 2855 კამპუს დრაივი, სან-მატეო, კალიფორნია 94403, აშშ

(111) M 2004 15513 R
 (141) 2014 10 16, არ არის გადახდილი რეგისტრაციის შემდგომი 10 წლით გაგრძელების საფასური
 (732) კეშტ ვა სანატ შომალ კო.
 210/3, ვახიდ დასტგერდი, მოდარესი, ექსპ. ვეი, თეირანი, ირანის ისლამური რესპუბლიკა

(111) M 2004 15500 R
 (141) 2014 10 16, არ არის გადახდილი რეგისტრაციის შემდგომი 10 წლით გაგრძელების საფასური
 (732) უნილევერ ნ.გ.
 ვეენა 455, NL-3013 AL როტერდამი, ნიდერლანდი

(111) M 2004 15514 R
 (141) 2014 10 16, არ არის გადახდილი რეგისტრაციის შემდგომი 10 წლით გაგრძელების საფასური
 (732) კეშტ ვა სანატ შომალ კო.
 210/3, ვახიდ დასტგერდი, მოდარესი, ექსპ. ვეი, თეირანი, ირანის ისლამური რესპუბლიკა

(111) M 2004 15502 R
 (141) 2014 10 16, არ არის გადახდილი რეგისტრაციის შემდგომი 10 წლით გაგრძელების საფასური
 (732) ისტმენ ქემიკალ კომპანი
 100 ნორთ ისტმენ როუდი, კინგსპორტი, ტენესი 37660, აშშ

(111) M 2004 15522 R
 (141) 2014 11 18, არ არის გადახდილი რეგისტრაციის შემდგომი 10 წლით გაგრძელების საფასური
 (732) იპსენ ფარმა ს.ა.ს.
 65 კე შორზე შორსი, ბულონ-ბიიანქური 92100, საფრანგეთი

(111) M 2004 15505 R
 (141) 2014 10 16, არ არის გადახდილი რეგისტრაციის შემდგომი 10 წლით გაგრძელების საფასური
 (732) უოტკინს მანუფექჩურინგ კორპორეიშენ
 კალიფორნიის შტატის კორპორაცია
 1280 პარკ სენტერ დრაივი, ვისტა, კალიფორნია 92083, აშშ

(111) M 2004 15523 R
 (141) 2014 11 18, არ არის გადახდილი რეგისტრაციის შემდგომი 10 წლით გაგრძელების საფასური
 (732) იპსენ ფარმა ს.ა.ს.
 65 კე შორზე შორსი, ბულონ-ბიიანქური 92100, საფრანგეთი

(111) M 2004 15506 R
 (141) 2014 10 16, არ არის გადახდილი რეგისტრაციის შემდგომი 10 წლით გაგრძელების საფასური
 (732) უოტკინს მანუფექჩურინგ კორპორეიშენ
 კალიფორნიის შტატის კორპორაცია
 1280 პარკ სენტერ დრაივი, ვისტა, კალიფორნია 92083, აშშ

(111) M 2004 15525 R
 (141) 2014 11 18, არ არის გადახდილი რეგისტრაციის შემდგომი 10 წლით გაგრძელების საფასური
 (732) მარს, ინკორპორეიტიდ (დელავერის შტატის კორპორაცია)
 6885 ელმ სტრიტი, მაკლინი, ვირჯინია 22101-3883, აშშ

(111) M 2004 15531 R
 (141) 2014 11 28, არ არის გადახდილი რეგისტრაციის შემდგომი 10 წლით გაგრძელების საფასური
 (732) ოლო „პროფიტ-ს“
 ზაგორიევსკაია სტრიტი, კ. 10, ბლდ.4, 115598 მოსკოვი, რუსეთის ფედერაცია

(111) M 2004 15542 R
 (141) 2014 12 02, არ არის გადახდილი რეგისტრაციის შემდგომი 10 წლით გაგრძელების საფასური
 (732) შპს „იკატო“
 შროშის ქ., 1, ბ. 16, 0179, თბილისი, საქართველო

(111) M 2004 15532 R
 (141) 2014 11 28, არ არის გადახდილი რეგისტრაციის შემდგომი 10 წლით გაგრძელების საფასური
 (732) ოლო „პროფიტ-ს“
 ზაგორიევსკაია სტრიტი, კ. 10, ბლდ.4, 115598 მოსკოვი, რუსეთის ფედერაცია

(111) M 2004 15543 R
 (141) 2014 12 03, არ არის გადახდილი რეგისტრაციის შემდგომი 10 წლით გაგრძელების საფასური
 (732) „ალენ მაკ“ ად
 148 „ვასილ ლევსკი“ სტრიტი, 4000 პლოვიდია, ბულგარეთი

(111) M 2004 15533 R
 (141) 2014 12 02, არ არის გადახდილი რეგისტრაციის შემდგომი 10 წლით გაგრძელების საფასური
 (732) ოლო „პროფიტ-ს“
 ზაგორიევსკაია სტრიტი, კ. 10, ბლდ.4, 115598 მოსკოვი, რუსეთის ფედერაცია

(111) M 2004 15547 R
 (141) 2014 12 16, არ არის გადახდილი რეგისტრაციის შემდგომი 10 წლით გაგრძელების საფასური
 (732) პრონტო-მოსკვა
 ვოლგოგრადსკი პროსპექტი, დომ. 2, 109316 მოსკოვი, რუსეთის ფედერაცია

(111) M 2004 15534 R
 (141) 2014 12 02, არ არის გადახდილი რეგისტრაციის შემდგომი 10 წლით გაგრძელების საფასური
 (732) ოლო „პროფიტ-ს“
 ზაგორიევსკაია სტრიტი, კ. 10, ბლდ.4, 115598 მოსკოვი, რუსეთის ფედერაცია

(111) M 2004 15552 R
 (141) 2014 12 16, არ არის გადახდილი რეგისტრაციის შემდგომი 10 წლით გაგრძელების საფასური
 (732) კ.რ. ბარდ, ინკ.
 730 სენტრალ ავენიუ, მიურეი-ჰილი, ნიუ-ჯერზი 07974, აშშ

(111) M 2004 15535 R
 (141) 2014 12 02, არ არის გადახდილი რეგისტრაციის შემდგომი 10 წლით გაგრძელების საფასური
 (732) ოლო „პროფიტ-ს“
 ზაგორიევსკაია სტრიტი, კ. 10, ბლდ.4, 115598 მოსკოვი, რუსეთის ფედერაცია

(111) M 2004 15553 R
 (141) 2014 12 16, არ არის გადახდილი რეგისტრაციის შემდგომი 10 წლით გაგრძელების საფასური
 (732) კ.რ. ბარდ, ინკ.
 730 სენტრალ ავენიუ, მიურეი-ჰილი, ნიუ-ჯერზი 07974, აშშ

(111) M 2004 15540 R
 (141) 2014 12 02, არ არის გადახდილი რეგისტრაციის შემდგომი 10 წლით გაგრძელების საფასური
 (732) მარია დე ლოს ანჯელეს ბროტონს მოლა
 ს/მანუელ ლოპეს კერედა, 31, 03204 ელჩე (ალიკანტე), ესპანეთი

(111) M 2004 15560 R
 (141) 2014 12 16, არ არის გადახდილი რეგისტრაციის შემდგომი 10 წლით გაგრძელების საფასური
 (732) ფილიპ მორის ბრენდს სარლ
 კე ქანრენო 3, 2000 ნევშატელი, შვეიცარია

(111) M 2004 15563 R
 (141) 2014 12 16, არ არის გადახდილი რეგისტრაციის შემდგომი 10 წლით გაგრძელების საფასური
 (732) ჯემ კორეა კომპანი 199-1, ჩეონგჩეონ-2 დონგი, ბუკუინგ-გუ, ინხეონი, კორეის რესპუბლიკა

(111) M 2004 15585 R
 (141) 2015 01 05, არ არის გადახდილი რეგისტრაციის შემდგომი 10 წლით გაგრძელების საფასური
 (732) „ალენ მაკ“ ად 148 „ვასილ ლევსკი“ სტრიტი, 4000 პლოვდივი, ბულგარეთი

(111) M 2004 15566 R
 (141) 2014 12 16, არ არის გადახდილი რეგისტრაციის შემდგომი 10 წლით გაგრძელების საფასური
 (732) ნისან ჯიდოშა კაბუშიკი კაიშა (აგრეთვე ვაჭრობს, როგორც ნისან მორტორ კო., ლტდ.) N 2 ტაკარაჩო, კანაგავა-კუ, იოკოჰამა-ში, კანაგავა-კენ, იაპონია

(111) M 2004 15586 R
 (141) 2015 01 05, არ არის გადახდილი რეგისტრაციის შემდგომი 10 წლით გაგრძელების საფასური
 (732) შევრონ ინტელექტუალ პროპერტი ლლკ დელავერის შტატი, შეზლუდული პასუხისმგებლობის კომპანია 6001 ბოლინგერ კანიონ როუდი, სან-რამონი, კალიფორნია 94583, აშშ

(111) M 2004 15567 R
 (141) 2014 12 16, არ არის გადახდილი რეგისტრაციის შემდგომი 10 წლით გაგრძელების საფასური
 (732) ვაიეტ ლლკ ფაივ ჯირალდა ფარში, მედისონი, ნიუ-ჯერზი 07940, აშშ

(111) M 2004 15596 R
 (141) 2015 01 20, არ არის გადახდილი რეგისტრაციის შემდგომი 10 წლით გაგრძელების საფასური
 (732) გლაქსო გრუპ ლიმიტიდ 980 გრიტ უესტ როუდი, ბრენტფორდი, მიდლსექსი TW8 9GS, გაერთიანებული სამეფო

(111) M 2004 15568 R
 (141) 2014 12 16, არ არის გადახდილი რეგისტრაციის შემდგომი 10 წლით გაგრძელების საფასური
 (732) ვაიეტ ლლკ ფაივ ჯირალდა ფარში, მედისონი, ნიუ-ჯერზი 07940, აშშ

(111) M 2004 15598 R
 (141) 2015 01 20, არ არის გადახდილი რეგისტრაციის შემდგომი 10 წლით გაგრძელების საფასური
 (732) ბენქ კორპორეიშენ 157, შან-ინგ როუდ კვეიშანი, ტაო-იუანი, ტაივანი, რ.ო.ს., ტაივანი, ჩინეთის პროვინცია

(111) M 2004 15569 R
 (141) 2014 12 16, არ არის გადახდილი რეგისტრაციის შემდგომი 10 წლით გაგრძელების საფასური
 (732) ვაიეტ ლლკ ფაივ ჯირალდა ფარში, მედისონი, ნიუ-ჯერზი 07940, აშშ

(111) M 2004 15599 R
 (141) 2015 01 20, არ არის გადახდილი რეგისტრაციის შემდგომი 10 წლით გაგრძელების საფასური
 (732) ბენქ კორპორეიშენ 16, ჯიჰუ როუდი, ნეიჰუ დისტ., ტაიპეი 114, ტაივანი, ჩინეთის პროვინცია

(111) M 2004 15580 R
 (141) 2015 01 05, არ არის გადახდილი რეგისტრაციის შემდგომი 10 წლით გაგრძელების საფასური
 (732) ფონტერა კოოპერატივ გრუპ ლიმიტიდ ბილდინგ 103, ლეონარდ ისიტ დრაივი, ოკლენდ ეპორტი, ოკლენდი, ახალი ზელანდია

(111) M 2004 15603 R
 (141) 2015 01 20, არ არის გადახდილი რეგისტრაციის შემდგომი 10 წლით გაგრძელების საფასური
 (732) გლაქსოსმითკლაინ ბაიოლოჯიკალ ზ ს.ა. რიუ დე ლ'ინსტიტუტ 89, B-1330 რიქსენსარტი, ბელგია

საერთაშორისო სანაქონლო ნიშნის რეგისტრაციის განუქმება

(800) 939502

(731) Pharmazeutische Fabrik Montavit
Gesellschaft m.b.H., Salzbergstraße 96,
A-6060 Absam, Austria

(540)

SALIVIT

(591) Black, white

(511) 5

(141) 2015 02 09

საფუძველი: საქპატენტის თავმჯდომარის 2015 წლის 06 თებერვლის ბრძანება № 20 თბილისის
საქალაქო სასამართლოს სამოქალაქო საქმეთა კოლეგიის 2014 წლის 22 აგვისტოს
კანონიერ ძალაში შესული გადაწყვეტილების (საქმე №2/5699-14 წ.) აღსასრულებლად.

სისტემური საძიებლები გამომგონებები

**საერთაშორისო კლასიფიკაციის ინდექსის და განაცხადის
გამოქვეყნების ნომრის შესაბამისობის ცხრილი**

საერთაშორისო კლასიფიკაციის ინდექსი (51)	განაცხადის გამოქვეყნების ნომერი (10)
A 01 N 25/02; A 01 N 43/90; A 01 N 45/02; A 01 N 43/56; A 01 N 43/36; A 01 N 47/30; A 01 N 43/653; A 01 N 43/70; A 01 N 51/00; A 01 N 43/54; A 01 N 37/34; A 01 N 35/10; A 01 N 39/02; A 01 P 3/00; A 01 P 7/04	AP 2015 11738 A
A 23 L 2/00	AP 2015 13311 A
A 61 K 8/97; A 61 Q 19/08; A 61 K 8/92; A 61 Q 19/00; A 61 Q 17/00	AP 2015 12537 A
B 03 B 13/00	AP 2015 12697 A
B 62 M 3/04	AP 2015 13248 A
C 07 D 267/10; C 07 D 413/04; C 07 D 413/06; C 07 D 413/10; C 07 D 413/12; C 07 D 413/14; C 07 D 417/06; C 07 D 417/14	AP 2015 13078 A
E 05 B 21/06	AP 2015 12747 A
F 03 B 3/18; F 03 B 1/00; F 15 D 1/04	AP 2015 13220 A

**განაცხადის გამოქვეყნების ნომრის დასაერთაშორისო
კლასიფიკაციის ინდექსის შესაბამისობის ცხრილი**

განაცხადის გამოქვეყნების ნომერი (10)	საერთაშორისო კლასიფიკაციის ინდექსი (51)
AP 2015 11738 A	A 01 N 25/02; A 01 N 43/90; A 01 N 45/02; A 01 N 43/56; A 01 N 43/36; A 01 N 47/30; A 01 N 43/653; A 01 N 43/70; A 01 N 51/00; A 01 N 43/54; A 01 N 37/34; A 01 N 35/10; A 01 N 39/02; A 01 P 3/00; A 01 P 7/04
AP 2015 12537 A	A 61 K 8/97; A 61 Q 19/08; A 61 K 8/92; A 61 Q 19/00; A 61 Q 17/00
AP 2015 12697 A	B 03 B 13/00
AP 2015 12747 A	E 05 B 21/06
AP 2015 13078 A	C 07 D 267/10; C 07 D 413/04; C 07 D 413/06; C 07 D 413/10; C 07 D 413/12; C 07 D 413/14; C 07 D 417/06; C 07 D 417/14
AP 2015 13220 A	F 03 B 3/18; F 03 B 1/00; F 15 D 1/04
AP 2015 13248 A	B 62 M 3/04
AP 2015 13311 A	A 23 L 2/00

**საერთაშორისო კლასიფიკაციის ინდექსის, პატენტის ნომრის
და გამოქვეყნების ნომრის შესაბამისობის ცხრილი**

საერთაშორისო კლასიფიკაციის ინდექსი (51)	პატენტის ნომერი (11)	განაცხადის გამოქვეყნების ნომერი (10)
A 01 B 3/46	P 2015 6252 B	AP 2014 13342 A
C 07 D 403/04; C 07 D 403/14; C 07 D 407/14; C 07 D 409/14; C 07 D 417/14; A 61 K 31/4178; A 61 P 35/00	P 2015 6250 B	AP 2014 12550 A
C 07 D 471/04; C 07 D 487/04; A 61 K 31/437; A 61 K 31/506; A 61 K 31/519; A 61 P 19/00; A 61 P 25/00; A 61 P 35/00	P 2015 6251 B	AP 2014 12896 A
E 21 B 41/00	P 2015 6249 B	AP 2014 12347 A

**კატეგორიის ნომრის, განაცხადის გამოქვეყნების ნომრის
და სავარაუდო კლასიფიკაციის ინდექსის შესაბამისობის ცხრილი**

კატეგორიის ნომერი (11)	განაცხადის გამოქვეყნების ნომერი (10)	სავარაუდო კლასიფიკაციის ინდექსი (51)
P 2015 6249 B	AP 2014 12347 A	E 21 B 41/00
P 2015 6250 B	AP 2014 12550 A	C 07 D 403/04; C 07 D 403/14; C 07 D 407/14; C 07 D 409/14; C 07 D 417/14; A 61 K 31/4178; A 61 P 35/00
P 2015 6251 B	AP 2014 12896 A	C 07 D 471/04; C 07 D 487/04; A 61 K 31/437; A 61 K 31/506; A 61 K 31/519; A 61 P 19/00; A 61 P 25/00; A 61 P 35/00
P 2015 6252 B	AP 2014 13342 A	A 01 B 3/46

**განაცხადის ნომრის, განაცხადის გამოქვეყნების ნომრის
და კატეგორიის ნომრის შესაბამისობის ცხრილი**

განაცხადის ნომერი (21)	განაცხადის გამოქვეყნების ნომერი (10)	კატეგორიის ნომერი (11)
AP 2010 012347	AP 2014 12347 A	P 2015 6249 B
AP 2010 012550	AP 2014 12550 A	P 2015 6250 B
AP 2011 012896	AP 2014 12896 A	P 2015 6251 B
AP 2013 013342	AP 2014 13342 A	P 2015 6252 B

სასარგებლო მოდელები

**სავარაუდო კლასიფიკაციის ინდექსის, კატეგორიის ნომრის
და გამოქვეყნების ნომრის შესაბამისობის ცხრილი**

სავარაუდო კლასიფიკაციის ინდექსი (51)	კატეგორიის ნომერი (11)	განაცხადის გამოქვეყნების ნომერი (10)
A 23 L 1/221	U 2015 1850 Y	AU 2014 13358 U
A 61 K 31/00; A 61 J 31/04	U 2015 1846 Y	AU 2014 12582 U
A 61 K 35/10, 35/12, 36/00	U 2015 1851 Y	AU 2014 13386 U
A 61 L 2/23	U 2015 1847 Y	AU 2014 12801 U
C 05 F 11/02	U 2015 1849 Y	AU 2014 13234 U
G 08 B 17/10	U 2015 1848 Y	AU 2014 13103 U

**კატეგორიის ნომრის, განაცხადის გამოქვეყნების ნომრის
და სავარაუდო კლასიფიკაციის ინდექსის შესაბამისობის ცხრილი**

კატეგორიის ნომერი (11)	განაცხადის გამოქვეყნების ნომერი (10)	სავარაუდო კლასიფიკაციის ინდექსი (51)
U 2015 1846 Y	AU 2014 12582 U	A 61 K 31/00; A 61 J 31/04
U 2015 1847 Y	AU 2014 12801 U	A 61 L 2/23
U 2015 1848 Y	AU 2014 13103 U	G 08 B 17/10
U 2015 1849 Y	AU 2014 13234 U	C 05 F 11/02
U 2015 1850 Y	AU 2014 13358 U	A 23 L 1/221
U 2015 1851 Y	AU 2014 13386 U	A 61 K 35/10, 35/12, 36/00

ბანაცხადის ნომრის, ბანაცხადის გამოქვეყნების ნომრისა და პატენტის ნომრის შესაბამისობის ცხრილი

ბანაცხადის ნომერი (21)	ბანაცხადის გამოქვეყნების ნომერი (10)	პატენტის ნომერი (11)
AU 2012 012582	AU 2014 12582 U	U 2015 1846 Y
AU 2012 012801	AU 2014 12801 U	U 2015 1847 Y
AU 2013 013103	AU 2014 13103 U	U 2015 1848 Y
AU 2013 013234	AU 2014 13234 U	U 2015 1849 Y
AU 2014 013358	AU 2014 13358 U	U 2015 1850 Y
AU 2014 013386	AU 2014 13386 U	U 2015 1851 Y

ღიზინები

საერთაშორისო კლასიფიკაციის ინდექსის და ბანაცხადის გამოქვეყნების ნომრის შესაბამისობის ცხრილი

საერთაშორისო კლასიფიკაციის ინდექსი (51)	ბანაცხადის გამოქვეყნების ნომერი (10)
32-00	AD 2015 815 S

ბანაცხადის გამოქვეყნების ნომრის და საერთაშორისო კლასიფიკაციის ინდექსის შესაბამისობის ცხრილი

ბანაცხადის გამოქვეყნების ნომერი (10)	საერთაშორისო კლასიფიკაციის ინდექსი (51)
AD 2015 815 S	32-00

სასაქონლო ნიშნები

რეგისტრაციის ნომრის, განაცხადის ნომრის,
განაცხადის გამოქვეყნების ნომრისა და ბიულეტენის ნომრის
შესაბამისობის ცხრილი

რეგისტრაციის ნომერი (11)	განაცხადის ნომერი (210)	განაცხადის გამოქვეყნების ნომერი (260)	ბიულეტენის ნომერი
M 2015 25660 R	AM 2015 80412	-	4(416) 2015
M 2015 25661 R	AM 2015 80411	-	4(416) 2015
M 2015 25662 R	AM 2015 78239	-	4(416) 2015
M 2015 25663 R	AM 2015 80359	-	4(416) 2015
M 2015 25664 R	AM 2013 72433	AM 2014 72433 A	11(399) 2014
M 2015 25665 R	AM 2013 72578	AM 2014 72578 A	13(401) 2014
M 2015 25666 R	AM 2013 72815	AM 2014 72815 A	19(407) 2014
M 2015 25667 R	AM 2013 72887	AM 2014 72887 A	17(405) 2014
M 2015 25668 R	AM 2013 72968	AM 2014 72968 A	14(402) 2014
M 2015 25669 R	AM 2013 73088	AM 2014 73088 A	14(402) 2014
M 2015 25670 R	AM 2013 73173	AM 2014 73173 A	19(407) 2014
M 2015 25671 R	AM 2013 73651	AM 2014 73651 A	12(400) 2014
M 2015 25672 R	AM 2013 73940	AM 2014 73940 A	15(403) 2014
M 2015 25673 R	AM 2013 74060	AM 2014 74060 A	18(406) 2014
M 2015 25674 R	AM 2013 74263	AM 2014 74263 A	14(402) 2014
M 2015 25675 R	AM 2013 74340	AM 2014 74340 A	18(406) 2014
M 2015 25676 R	AM 2013 74378	AM 2014 74378 A	14(402) 2014
M 2015 25677 R	AM 2013 74395	AM 2014 74395 A	14(402) 2014
M 2015 25678 R	AM 2013 74486	AM 2014 74486 A	18(406) 2014
M 2015 25679 R	AM 2013 74492	AM 2014 74492 A	17(405) 2014
M 2015 25680 R	AM 2013 74573	AM 2014 74573 A	16(404) 2014
M 2015 25681 R	AM 2013 74630	AM 2014 74630 A	14(402) 2014
M 2015 25682 R	AM 2013 74682	AM 2014 74682 A	14(402) 2014
M 2015 25683 R	AM 2013 74770	AM 2014 74770 A	18(406) 2014
M 2015 25684 R	AM 2013 74982	AM 2014 74982 A	16(404) 2014
M 2015 25685 R	AM 2013 75081	AM 2014 75081 A	14(402) 2014
M 2015 25686 R	AM 2013 75082	AM 2014 75082 A	14(402) 2014
M 2015 25687 R	AM 2013 75083	AM 2014 75083 A	14(402) 2014
M 2015 25688 R	AM 2013 75097	AM 2014 75097 A	18(406) 2014
M 2015 25689 R	AM 2013 75119	AM 2014 75119 A	18(406) 2014
M 2015 25691 R	AM 2013 73928	AM 2014 73928 A	15(403) 2014
M 2015 25692 R	AM 2013 73929	AM 2014 73929 A	15(403) 2014
M 2015 25693 R	AM 2013 73939	AM 2014 73939 A	15(403) 2014
M 2015 25694 R	AM 2013 74163	AM 2014 74163 A	15(403) 2014
M 2015 25695 R	AM 2013 74345	AM 2014 74345 A	18(406) 2014
M 2015 25696 R	AM 2013 74602	AM 2014 74602 A	14(402) 2014
M 2015 25697 R	AM 2013 74684	AM 2014 74684 A	14(402) 2014
M 2015 25698 R	AM 2013 74979	AM 2014 74979 A	15(403) 2014
M 2015 25699 R	AM 2013 71659	AM 2014 71659 A	3(391) 2014
M 2015 25700 R	AM 2015 80508	-	4(416) 2015

ბანაცხადის გამოქვეყნების ნომრის და ბანაცხადის ნომრის შესაბამისობის ცხრილი

ბანაცხადის გამოქვეყნების ნომერი (260)	ბანაცხადის ნომერი (210)	1	2
1	2		
AM 2015 69118 A	AM 2012 69118	AM 2015 76421 A	AM 2014 76421
AM 2015 71153 A	AM 2013 71153	AM 2015 76459 A	AM 2014 76459
AM 2015 72155 A	AM 2013 72155	AM 2015 76460 A	AM 2014 76460
AM 2015 73130 A	AM 2013 73130	AM 2015 76710 A	AM 2014 76710
AM 2015 73136 A	AM 2013 73136	AM 2015 76736 A	AM 2014 76736
AM 2015 73137 A	AM 2013 73137	AM 2015 76739 A	AM 2014 76739
AM 2015 74755 A	AM 2013 74755	AM 2015 76785 A	AM 2014 76785
AM 2015 75090 A	AM 2013 75090	AM 2015 76842 A	AM 2014 76842
AM 2014 75095 A*	AM 2013 75095	AM 2015 76847 A	AM 2014 76847
AM 2015 75703 A	AM 2014 75703	AM 2015 76956 A	AM 2014 76956
AM 2015 75720 A	AM 2014 75720	AM 2015 77098 A	AM 2014 77098
AM 2015 76184 A	AM 2014 76184	AM 2015 77127 A	AM 2014 77127
AM 2015 76307 A	AM 2014 76307	AM 2015 77329 A	AM 2014 77329
AM 2015 76364 A	AM 2014 76364	AM 2015 77347 A	AM 2014 77347
AM 2015 76365 A	AM 2014 76365	AM 2015 77348 A	AM 2014 77348
AM 2015 76366 A	AM 2014 76366	AM 2015 77370 A	AM 2014 77370
		AM 2015 77371 A	AM 2014 77371
		AM 2015 77466 A	AM 2014 77466
		AM 2015 77531 A	AM 2014 77531
		AM 2015 77553 A	AM 2014 77553
		AM 2015 76974 A	AM 2014 76974

ბანაცხადის გამოქვეყნების ნომრის საძიებელი საქონლისა და/ან მომსახურების კლასის მიხედვით

საქონლისა და/ან მომსახურების კლასი (511)	ბანაცხადის გამოქვეყნების ნომერი (260)	1	2
1	2		
3	AM 2015 77098 A	28	AM 2015 76421 A
3	AM 2015 77466 A	29	AM 2015 75095 A*
4	AM 2015 76847 A	29	AM 2015 76184 A
5	AM 2015 73130 A	29	AM 2015 76710 A
5	AM 2015 75095 A*	30	AM 2015 72155 A
5	AM 2015 76307 A	30	AM 2015 73136 A
5	AM 2015 76739 A	30	AM 2015 73137 A
5	AM 2015 76842 A	30	AM 2015 75095 A*
5	AM 2015 77127 A	30	AM 2015 76184 A
5	AM 2015 77370 A	30	AM 2015 76710 A
6	AM 2015 75720 A	31	AM 2015 76710 A
11	AM 2015 76459 A	32	AM 2015 75090 A
12	AM 2015 76460 A	32	AM 2015 75095 A*
12	AM 2015 77531 A	32	AM 2015 77553 A
14	AM 2015 76956 A	33	AM 2015 69118A
14	AM 2015 76974 A	33	AM 2015 74755 A
20	AM 2015 75720 A	33	AM 2015 75090 A
25	AM 2015 75703 A	34	AM 2015 76364 A
		34	AM 2015 76365 A
		34	AM 2015 76366 A
		34	AM 2015 76366 A
		34	AM 2015 76736 A
		35	AM 2015 72155 A
		35	AM 2015 75720 A

1	2
35	AM 2015 76459 A
35	AM 2015 76956 A
35	AM 2015 77347 A
35	AM 2015 77348 A
39	AM 2015 71153 A
39	AM 2015 77371 A
41	AM 2015 75703 A

1	2
43	AM 2015 72155 A
43	AM 2015 73136 A
43	AM 2015 73137 A
43	AM 2015 75703 A
43	AM 2015 76785 A
43	AM 2015 77329A

დაჩქარებული პროცედურით რეგისტრირებული სასაქონლო ნიშნის ნომრის საძიებელი საქონლისა და/ან მომსახურების კლასის მიხედვით

საქონლისა და/ან მომსახურების კლასი (511)	დაჩქარებული პროცედურით რეგისტრირებული სასაქონლო ნიშნის ნომერი (111)
3	M 2015 25660 R
3	M 2015 25661 R
3	M 2015 25663 R
5	M 2015 25662 R
5	M 2015 25663 R
33	M 2015 25700 R
35	M 2015 25663 R

სამრეწველო საკუთრების ოფისიალური ბიულეტენი

4(416)

ბიულეტენების ქართული და ინგლისურენოვანი გამოცემების ელექტრონული ვერსიის გაცნობა შესაძლებელია საქპატენტის ვებგვერდზე (www.sakpatenti.org.ge).

შენიშვნა:

ბიულეტენებში გამოქვეყნებული ობიექტების ზუსტი გამოსახულებები იხილეთ საქპატენტის ვებგვერდზე განთავსებულ ელექტრონულ ვერსიაში.

მთავარი რედაქტორი:	ნ. ბებრიშვილი
პორექტორი:	ლ. ჭანტურია
დამაბაბაღონებელი:	მ. ორდენიძე
	ქ. სვანიძე
პოლიგრაფიული ჯგუფი:	მ. მეჩტიშვილი
	ი. გოგოლაშვილი
	ლ. დოლიძე

ხელმოწერილია გამოსაცემად: 2015 02 24

ტირაჟი: 25
შეკვეთა №4