

საქართველოს ინტელექტუალური საკუთრების
ეროვნული ცენტრი
საქპატენტი

**სამრეწველო საკუთრების
ო ფ ი ს ი ა ლ უ რ ი
ბ ი უ ლ ე ტ ე ნ ი**

7(419)

**გამოგონებები
სასარგებლო მოდელები
დიზაინები
სასაქონლო ნიშნები
საქონლის აღზიდნარმოშობის დასახელებები და
გეოგრაფიული აღნიშვნები**

საერთაშორისო კოდეზი ბიბლიოგრაფიული მონაცემების იდენტიფიკაციისთვის

გამოგონებები, სასარგებლო მოდელები

- (10) – ექსპერტიზაგადასმული განაცხადის გამოქვეყნების ნომერი
- (11) – პატენტის ნომერი და სახეობის კოდი
- (21) – განაცხადის სარეგისტრაციო ნომერი
- (22) – განაცხადის შეტანის თარიღი
- (23) – სავაჭრო ნიშნის პრიორიტეტის თარიღი ან ადრინდელი პრიორიტეტის მქონე განაცხადის შეტანის თარიღი და, თუ შესაძლებელია, განაცხადის ომერი
- (24) – თარიღი, რომლიდანაც იწყება პატენტის მოქმედება
- (31) – საპრიორიტეტო განაცხადის ნომერი
- (32) – საპრიორიტეტო განაცხადის შეტანის თარიღი
- (33) – კოდი ქვეყნის ან რეგიონული ორგანიზაციისა, რომლის უწყებამაც მიანიჭა ნომერი საპრიორიტეტო განაცხადს
- (44) – დამავი სახეობის კური ანონსი, მაგრამ ექსპერტიზაგადასმული განაცხადის გამოქვეყნების თარიღი და ბიულეტენის ნომერი
- (45) – რეგისტრაცია გათვლილი საპატენტო სახეობის გამოქვეყნების თარიღი
- (51) – საერთაშორისო საპატენტო კლასიფიკაციის ინდექსი

- (54) – გამოგონების დასახელება
- (57) – რეფერატის ტექსტი
- (60) – სრულ ექსპერტიზაგადასმული გამოგონებაზე უცხოური საპატენტო უწყების მიერ გაცემული დამავი სახეობის ნომერი, თარიღი, რომლიდანაც იწყება ამ დამავი სახეობის მოქმედება, და კოდი ქვეყნის ან რეგიონული ორგანიზაციისა, რომლის უწყებამაც გასცა ეს დამავი სახეობა
- (62) – უფრო ადრინდელი განაცხადის ნომერი და, თუ შესაძლებელია, წარდგენის თარიღი გამოცალკევებული განაცხადის შემთხვევაში
- (71) – განმცხადებლის სახელი, გვარი (ქვეყნის კოდი)
- (72) – გამომგონებლის სახელი, გვარი (ქვეყნის კოდი)
- (73) – პატენტმფლობელის სახელი, გვარი (ქვეყნის კოდი), მისამართი
- (74) – წარმომადგენლის ან პატენტმწმუნებულის სახელი, გვარი
- (85) – საერთაშორისო განაცხადის უროვნული ფაზის დაწყების თარიღი
- (86) – საერთაშორისო განაცხადის ნომერი და შეტანის თარიღი
- (87) – საერთაშორისო განაცხადის გამოქვეყნების ნომერი და თარიღი

ლიზინი

- (10) – განაცხადის გამოქვეყნების ნომერი
- (11) – პატენტის ნომერი და სახეობის კოდი ან რეგისტრაციის ნომერი
- (15) – რეგისტრაციის თარიღი/პატენტის გაგრძელების თარიღი
- (18) – პატენტის ან რეგისტრაციის მოქმედების ვადის გასვლის სავარაუდო თარიღი
- (21) – განაცხადის ნომერი
- (22) – განაცხადის შეტანის თარიღი
- (23) – სავაჭრო ნიშნის პრიორიტეტის თარიღი ან ადრინდელი პრიორიტეტის მქონე განაცხადის შეტანის თარიღი და, თუ შესაძლებელია, განაცხადის ნომერი
- (24) – თარიღი, რომლიდანაც იწყება პატენტის მოქმედება
- (28) – ღიზანების რაოდენობა განაცხადში
- (30) – საპრიორიტეტო მონაცემები (განაცხადის ნომერი, განაცხადის შეტანის თარიღი და ორასოიანი კოდი იმ ორგანიზაციის იდენტიფიკაციისათვის, სადაც იყო წარდგენილი საპრიორიტეტო განაცხადი)
- (31) – საპრიორიტეტო განაცხადის ნომერი
- (32) – საპრიორიტეტო განაცხადის შეტანის თარიღი
- (33) – კოდი ქვეყნის ან რეგიონული ორგანიზაციისა, რომლის უწყებამაც მიანიჭა ნომერი საპრიორიტეტო განაცხადს
- (34) – ILM-ს სტანდარტის (ST.3) შესაბამის ორასოიანი კოდი იმ ორგანიზაციის იდენტიფიკაციისათვის, სადაც იყო წარდგენილი საპრიორიტეტო განაცხადი
- (44) – ღიზანის გამოქვეყნების თარიღი და ბიულეტენის ნომერი (პირველი პუბლიკაცია)

- (45) – საერთაშორისო ბიუროს მიერ დარეგისტრირებული ღიზანის გამოქვეყნების თარიღი და ბიულეტენის ნომერი
- (51) – ღიზანის საერთაშორისო კლასიფიკაცია (ლოკარნოს კლასიფიკაციის კლასი და ქვეკლასი)
- (54) – ღიზანის დასახელება
- (55) – ღიზანის გამოცხადება
- (57) – ღიზანის არსებითი ნიშნების აღწერა, ფერის ჩათვლით
- (58) – ყველა სახის ცვლილების შესახებ რეესტრში ჩანაწერის შეტანის თარიღი
- (62) – ადრინდელი განაცხადის, რეგისტრაციის ან სახეობის ნომერი და, თუ შესაძლებელია, წარდგენის თარიღი, გამოცალკევებული განაცხადის შემთხვევაში
- (71) – განმცხადებლის სახელი, გვარი (ქვეყნის კოდი), მისამართი
- (72) – ავტორის სახელი, გვარი ან დასახელება (ქვეყნის კოდი)
- (73) – პატენტმფლობელის სახელი, გვარი (ქვეყნის კოდი), მისამართი
- (74) – წარმომადგენლის სახელი, გვარი და მისამართი
- (81) – შესაბამისი მონაწილე მხარეები:
 - II. მონაწილე მხარეები, აღნიშნული 1960 წლის აქტის თანახმად
 - III. მონაწილე მხარეები, აღნიშნული 1999 წლის აქტის თანახმად
- (85) – მფლობელის მუდმივი საცხოვრებელი ადგილი
- (86) – მფლობელის მოქალაქეობა
- (87) – მფლობელის საცხოვრებელი ადგილი
- (88) – ქვეყანა, სადაც მფლობელს აქვს ნამდვილი და მოქმედი სამრეწველო ან სავაჭრო სანარმო

სასაქონლო ნიშნები

- (111) – რეგისტრაციის ნომერი
- (151) – რეგისტრაციის თარიღი
- (156) – რეგისტრაციის ვადის გაგრძელების თარიღი
- (181) – რეგისტრაციის ვადის გასვლის სავარაუდო თარიღი
- (186) – ვადის გაგრძელების გასვლის სავარაუდო თარიღი
- (141) – რეგისტრაციის მოქმედების ვადის გაუქმების თარიღი
- (210) – განაცხადის ნომერი
- (220) – განაცხადის შეტანის თარიღი
- (230) – სავაჭრო ნიშნის მონაცემები
- (260) – ნომერი განაცხადისა, რომელზედაც გამოკანონდა ექსპერტიზის დადებითი გადაწყვეტილება რეგისტრაციის შესახებ (გამოქვეყნების ნომერი)
- (310) – პირველი განაცხადის ნომერი
- (320) – პირველი განაცხადის შეტანის თარიღი
- (330) – პირველი განაცხადის მიმღები უროვნული ან რეგიონული უწყების ან ორგანიზაციის საიდენტიფიკაციო კოდი
- (51) – საქონლისა და მომსახურების საერთაშორისო კლასიფიკაცია სასაქონლო ნიშნის რეგისტრაციისათვის და/ან კლასიფიკირებული საქონლისა და/ან მომსახურების ჩამონათვალი
- (531) – სასაქონლო ნიშნის გამოცხადებითი ელემენტების აღწერა სასაქონლო ნიშნების გამოცხადებითი ელემენტების საერთაშორისო კლასიფიკაციის (ვენის კლასიფიკაცია) მიხედვით

- (540) – ნიშნის გამოცხადება
- (550) – სასაქონლო ნიშნის ტიპი ან სახეობა
- (580) – განაცხადსა და ნიშნის რეგისტრაციისთან დაკავშირებული ყველა სახის ცვლილებაზე ჩანაწერის შეტანის თარიღი
- (591) – ინფორმაცია განცხადებულ ფერებზე
- (731) – განმცხადებლის სახელი და მისამართი
- (732) – მფლობელის სახელი და მისამართი
- (740) – წარმომადგენლის სახელი და მისამართი
- (750) – მიმონწერის მისამართი
- (770) – ცვლილებაზე განმცხადებლის ან მფლობელის სახელი და მისამართი უფლების გადაცემის შემთხვევაში
- (771) – ცვლილებაზე განმცხადებლის ან მფლობელის სახელი და მისამართი უფლების გადაცემის გარეშე
- (791) – ლიცენზიაციის სახელი და მისამართი
- (793) – ლიცენზიის პირობები და/ან შეზღუდვაზე მიწინებვა (ლიცენზიის სახე, სალიცენზიო ხელშეკრულების ნომერი, სალიცენზიო ხელშეკრულების თარიღი, სალიცენზიო ხელშეკრულების მოქმედების ვადა)
- (800) – სასაქონლო ნიშნის რეგისტრაციის მონაცემები ნიშნების საერთაშორისო რეგისტრაციის მდრიდის ხელშეკრულებასთან დაკავშირებული პროტოკოლის მიხედვით (საერთაშორისო რეგისტრაციის ნომერი)

- (21) AP 0000 000000 – გამოგონებაზე განაცხადის ნომერი
- (10) AP 0000 0000 A – გამოგონებაზე განაცხადის გამოქვეყნების ნომერი (პირველი პუბლიკაცია)
- (11) P 0000 0000 B – გამოგონების პატენტის ნომერი (მეორე პუბლიკაცია)
- (21) API 0000 000000 – შემოტანილ პატენტზე განაცხადის ნომერი
- (11) PI 0000 0000 A – შემოტანილი პატენტის ნომერი (პირველი პუბლიკაცია)
- (21) AU 0000 000000 – სასარგებლო მოდელებზე განაცხადის ნომერი
- (10) AU 0000 000 U – სასარგებლო მოდელებზე განაცხადის გამოქვეყნების ნომერი (პირველი პუბლიკაცია)
- (11) U 0000 000 Y – სასარგებლო მოდელების პატენტის ნომერი (მეორე პუბლიკაცია)
- (21) AD 0000 000000 – ღიზანზე განაცხადის ნომერი
- (10) AD 0000 000 S – ღიზანზე განაცხადის გამოქვეყნების ნომერი (პირველი პუბლიკაცია)
- (11) D 0000 000 S – ღიზანის პატენტის ნომერი (მეორე პუბლიკაცია)

- M – სასაქონლო ნიშანი
- (210) AM 0000 000000 – განაცხადის ნომერი
- (260) AAM 0000 00000 A – განაცხადის გამოქვეყნების ნომერი
- (111) M 0000 00000 R – რეგისტრაციის ნომერი
- MMM0000 00000 Rn – მომდევნო ვადით რეგისტრაციის ნომერი, სადაც n=1, 2, 3...
- M 0000 00000 R(P) – რეგისტრაციის ნომერი ნიშანზე უფლების ნაწილობრივი გადაცემისას
- * – საქპატენტის სააპელაციო პალარის გადაწყვეტილების შემდეგ გამოქვეყნებული განაცხადის ნომერი
- ** – სასამართლოს გადაწყვეტილების შემდეგ გამოქვეყნებული განაცხადის ნომერი

გამოგონებებისა და სასარგებლო მოდელების საერთაშორისო კლასიფიკაციის იდენტიფიკაცია

- განყოფილება A – ადამიანის პირველადი მოთხოვნილების საგნები
- განყოფილება B – ტექნოლოგიური პროცესები; ტრანსპორტირება
- განყოფილება C – ქიმიკა; მეტალურგია
- განყოფილება D – საფეიქრო ნაწარმი; ქალაქი
- განყოფილება E – მშენებლობა; საბითონ საქმი; სტაციონარული ნაგებობები
- განყოფილება F – მექანიკა; განათება; გათბობა; იარაღი; ასაფეთქებელი საშუალებები
- განყოფილება G – ფიზიკა
- განყოფილება H – ელექტრონობა

**ისმო-ს წევრი სახელმწიფოებისა და ორგანიზაციების აღნიშვნის
ორასობიანი კოდეზი
(ისმოს სტანდარტი ST.3)**

AD	ანდორა	GD	გრენადა	MY	მალაიზია
AE	არაბთა გაერთიანებული საამიროები	GE	საქართველო	MZ	მოზამბიკი
AF	ავღანეთი	GG	გენზი	NA	ნამიბია
AG	ანტიგუა და ბარბუდა	GH	განა	NE	ნიგერი
AI	ანგილია	GI	გიბრალტარი	NG	ნიგერია
AL	ალბანეთი	GL	გრენლანდია	NI	ნიჟარაგუა
AM	სომხეთი	GM	გამბია	NL	ნიდერლანდები
AN	ანტილის კუნძულები (ნიდერლანდები)	GN	გვინეა	NO	ნორვეგია
AO	ანგოლა	GQ	ეკვატორული გვინეა	NP	ნეპალი
AP	ინტელექტუალური საკუთრების აფრიკის რეგიონალური ორგანიზაცია (ARIPO)	GR	საბერძნეთი	NR	ნაურუ
AR	არგენტინა	GS	სამხრეთი ჯორჯია და სამხრეთი სენდვიჩის კუნძულები	NZ	ახალი ზელანდია
AT	ავსტრია	GT	გვატემალა	OA	აფრიკის ინტელექტუალური საკუთრების ორგანიზაცია (OAPI)
AU	ავსტრალია	GW	გვინეა-ბისაუ	OM	ომანი
AW	არუბა	GY	გაიანა	PA	პანამა
AZ	აზერბაიჯანი	HK	ჰონგ კონგი	PE	პერუ
BA	ბოსნია და ჰერცეგოვინა	HN	ჰონდურასი	PG	პაპუა-ახალი გვინეა
BB	ბარბადოსი	HR	ხორვატია	PH	ფილიპინები
BD	ბანგლადეში	HT	ჰაიტი	PK	პაკისტანი
BE	ბელგია	HU	უნგრეთი	PL	პოლონეთი
BF	ბურკინა-ფასო	IB	ინტელექტუალური საკუთრების მსოფლიო ორგანიზაციის (ისმო, WIPO) საერთაშორისო ბიურო	VE	ვენესუელა
BG	ბულგარეთი	ID	ინდონეზია	VG	ვირჯინის კუნძულები (ბრიტანეთი)
BH	ბაჰრეინი	IE	ირლანდია	PY	პარაგვაი
BI	ბურუნდი	IL	ისრაელი	QA	კატარი
BJ	ბენინი	IM	მენის კუნძული	QZ	ევროპის თანამეგობრობის მცენარეთა ჯიშების უწყება (CPVO)
BM	ბერმუდის კუნძულები	IN	ინდოეთი	RO	რუმინეთი
BN	ბრუნეი-დარუსალამი	IQ	ირაკი	RS	სერბია
BO	ბოლივია	IR	ირანის ისლამური რესპუბლიკა	RU	რუსეთის ფედერაცია
BR	ბრაზილია	IS	ისლანდია	RW	რუანდა
BS	ბაჰამის კუნძულები	IT	იტალია	SA	საუდის არაბეთი
BT	ბჰუტანი	JE	ჯეზი	SB	სოლომონის კუნძულები
BV	ბუვეტის კუნძულები	JM	იამაიკა	SC	სეიშელის კუნძულები
BW	ბოტსვანა	JO	იორდანია	SD	სუდანი
BX	ბენელუქსის ინტელექტუალური საკუთრების უწყება (BOIP)	JP	იაპონია	SE	შვედეთი
BY	ბელორუსია	KE	კენია	SG	სინგაპური
BZ	ბელისი	KG	ყირგიზეთი	SH	წმინდა ჰელენის კუნძული
CA	კანადა	KH	კამბოჯა	SI	სლოვენია
CD	კონგოს დემოკრატიული რესპ.	KI	კირიბატი	SK	სლოვაკია
CF	ცენტრალური აფრიკის რესპ.	KM	კომორის კუნძულები	SL	სიერა-ლეონე
CG	კონგო	KN	სენტ კიტსი და ნევისი	SM	სან-მარინო
CH	შვეიცარია	KP	კორეის სახალხო დემოკრატიული რესპუბლიკა	SN	სენეგალი
CI	კოტ-დ'ივუარი	KR	კორეის რესპუბლიკა	SO	სომალი
CK	კუკის კუნძულები	KW	კუვეიტი	SR	სურინამი
CL	ჩილე	KY	კაიმენის კუნძულები	ST	სან-ტომე და პრინსიპი
CM	კამერუნი	KZ	ყაზახეთი	SV	სალვადორი
CN	ჩინეთი	LA	ლაოსი	SY	სირია
CO	კოლუმბია	LB	ლიბანი	SZ	სვაზილენდი
CR	კოსტა-რიკა	PT	პორტუგალია	TC	თურქის და კაიკოსის კუნძულები
CU	კუბა	PW	პალაუ	TD	ჩადი
CV	მწვანე კონცხის კუნძულები	LC	სენტ-ლუსია	TG	ტოგო
CY	კვიპროსი	LI	ლიხტენშტაინი	TH	ტაილანდი
CZ	ჩეხეთის რესპუბლიკა	LK	შრი-ლანკა	TJ	ტაჯიკეთი
DE	გერმანია	LR	ლიბერია	TL	ტიმოლ-ლესტე
DJ	ჯიბუტი	LS	ლესოტო	TM	თურქმენეთი
DK	დანია	LT	ლიტვა	TN	ტუნისი
DM	დომინიკა	LU	ლუქსემბურგი	TO	ტონგა
DO	დომინიკელთა რესპუბლიკა	LV	ლატვია	TR	თურქეთი
DZ	ალჟირი	LY	ლიბია	TT	ტრინიდადი და ტობაგო
EA	ევრაზიის საპატენტო ორგანიზაცია (EAPO)	MA	მაროკო	TV	ტუვალუ
EC	ეკვადორი	MC	მონაკო	TW	ტაივანი, ჩინეთის პროვინცია
EE	ესტონეთი	MD	რესპუბლიკა მოლდოვა	TZ	ტანზანია
EG	ეგვიპტე	ME	ჩერნოგორია (მონტენეგრო)	UA	უკრაინა
EH	დასავლეთი საჰარა	MG	მადაგასკარი	UG	უგანდა
EM	მინაგანი ბაზრის ჰარმონიზაციის უწყება (სასაქონლო ნიშნები და სამრეწველო ნიშნები (OHIM) ევროპის საპატენტო უწყება (EPO))	MK	მაკედონია ყოფილი იუგოსლავიის რესპუბლიკა	US	აშშ
EP	ევროპის საპატენტო უწყება (EPO)	ML	მალი	UY	ურუგვაი
ER	ერიტრეა	MM	მიანმა	UZ	უზბეკეთი
ES	ესპანეთი	MN	მონღოლეთი	VA	ვატიკანი
ET	ეთიოპია	MO	მაკაო	VC	სანტ-ვინსენტი და გრენადინები
FI	ფინეთი	MP	ჩრდ. მარიანას კუნძულები	VN	ვიეტნამი
FJ	ფიჯი	MR	მავრიტანია	VU	ვანუატუ
FK	ფოლკლენდის კუნძულები	MS	მოსკერავტი	WO	WIPO-ინტელექტუალური საკუთრების მსოფლიო ორგანიზაცია
FO	ფარერის კუნძულები	MT	მალტა	WS	სამოა
FR	საფრანგეთი	MU	მავრიკია	XN	ნორდული საპატენტო ინსტიტუტი (NPI)
GA	გაბონი	MV	მალდივის კუნძულები	YE	იემენი
GB	დიდი ბრიტანეთი	MW	მალავი	ZA	სამხრეთ აფრიკა
GC	სპარსეთის ყურის არაბული სახელმწიფოების თანამშრომლობის საბჭოს უწყება (GCC)	MX	მექსიკა	ZM	ზამბია
				ZW	ზიმბაბვე

შ ი ნ ა ა რ ს ი

გამოქვეყნებული ობიექტები	3
გამოგონებები	
• განაცხადები, რომლებზეც გამოტანილია გადაწყვეტილება პატენტის გაცემის შესახებ	4
• გამოგონების პატენტები	10
სასარგებლო მოდელები	
• სასარგებლო მოდელების პატენტები	13
დიზაინები	
• რეგისტრირებული დიზაინები	14
• დიზაინები, რომლებიც რეგისტრირებულია საერთაშორისო ბიუროში საქართველოს ტერიტორიაზე უფლებათა გავრცელების მოთხოვნით	15
სასაქონლო ნიშნები	
• ეროვნული პროცედურით შემოტანილი განაცხადები, რომლებზეც გამოტანილია გადაწყვეტილება რეგისტრაციის შესახებ	34
• რეგისტრირებული სასაქონლო ნიშნები	42
• დაჩქარებული პროცედურით რეგისტრირებული სასაქონლო ნიშნები	44
• საერთაშორისო სასაქონლო ნიშნები, რომლებზეც გამოტანილია გადაწყვეტილება დაცვის მინიჭების შესახებ	49
• საერთაშორისო სასაქონლო ნიშნები, რომლებსაც მიენიჭათ დაცვა საქართველოში	185
საქონლის ადგილწარმოშობის დასახელება და გეოგრაფიული აღნიშვნები	
• რეგისტრირებული ადგილწარმოშობის დასახელება	195
ოფიციალური შტაბობინებები	
გამოგონებები	
• უფლებების გადაცემა	196
• პატენტმფლობელის სახელისა და/ან მისამართის ცვლილებები	197
• პატენტების მოქმედების ვადის ამოწურვა	197
• გადაწყვეტილება პატენტების გაუქმების შესახებ	198
• შეცდომების გასწორება	206
სასაქონლო ნიშნები	
• რეგისტრაციის მოქმედების ვადის გაგრძელება	207
• უფლებების სრული გადაცემა	209
სისტემური საძიებლები	
გამოგონებები	211
სასარგებლო მოდელები	213
დიზაინები	214
სასაქონლო ნიშნები	215

გამოქვეყნებული ობიექტები

გამოგონებები

- განაცხადები, რომლებზეც გამოტანილია გადაწყვეტილება პატენტის გაცემის შესახებ: 13392; 12505; 13329; 13187; 13165; 12734; 13204; 13211; 12527; 13388; 13395; 11917
- პატენტები: 6266-6276

სასარგებლო მოდელები

- პატენტი: 1856

ღიზინები

- რეგისტრირებული ღიზინი: 624
- ღიზინები, რომლებიც რეგისტრირებულია სავაჭრო ნიშნის ბიუროში საქართველოს ტერიტორიაზე უფლებათა გაცემის მოთხოვნით: 84039; 84663; 85335; 85345; 85359; 85372; 84194; 85494

სასაქონლო ნიშნები

- ეროვნული პროცედურით შემოტანილი განაცხადები: 75892; 76187; 76223; 76367; 76401; 76617, 76618; 76630; 76639; 76701; 76723; 77309; 77357; 77454; 77573; 77693; 77697; 77944; 78156, 78157; 78262, 78263; 78268; 78790; 78802, 78803; 78851, 78852
- რეგისტრირებული სასაქონლო ნიშნები: 25760-25773; 25776
- დამატებული პროცედურით რეგისტრირებული სასაქონლო ნიშნები: 25747-25759; 25774, 25775; 25777
- სავაჭრო ნიშნის სასაქონლო ნიშნები, რომლებზეც გამოტანილია გადაწყვეტილება დაცვის მიწვევის შესახებ: 71877*; 72708*; 72726*; 73196*; 74551*; 75828, 75829; 76124; 76126; 76130; 76134-76136; 76171; 76173; 76180, 76181; 76247; 76250; 76254; 76266, 76267; 76269; 76272; 76289; 76331-76335; 76339; 76341; 76343, 76344; 76348-76353; 76375-76378; 76411, 76412; 76414-76416; 76418, 76419; 76422, 76423; 76426, 76427; 76430, 76431; 76433; 76437, 76438; 76440; 76442, 76443; 76485; 76492-76494; 76496; 76502; 76543; 76563; 76565; 76571-76574; 76576, 76577; 76579-76582; 76624; 76635-76638; 76640-76652; 76684; 76689; 76740; 76744; 76747-76751; 76753; 76755; 76769; 76820; 76835; 76837, 76838; 76850; 76855; 76861; 76865-76868; 76870; 76875-76877; 76879; 76887; 76889-76895; 76898; 76900; 76902; 76904; 76906; 76908; 76910, 76911; 76913-76916; 76918-76929; 76931; 76933-76936; 76943; 76952; 76957-76962; 76964-76966; 76976-76981; 76997-76999; 77004; 77007-77009; 77011, 77012; 77014-77020; 77022; 77026, 77027; 77035-77052; 77054-77057; 77059; 77061; 77082; 77102-77104; 77107; 77138-77151; 77159; 77170; 77172; 77177; 77179-77185; 77197, 77198; 77200, 77201; 77203, 77204; 77215-77217; 77220, 77221; 77223-77237; 77240; 77243; 77248; 77302; 77304-77308; 77310-77312; 77317; 77319; 77333; 77358-77362; 77364, 77365; 77367, 77368; 77372-77374; 77379-77382; 77384; 77386; 77389; 77392-77394; 77403; 77408; 77428; 77433; 77439; 77442; 77449; 77453; 77456, 77457; 77479; 77484; 77488; 77497; 77505, 77506; 77508; 77548-77551; 77554-77557; 77559-77563; 77565; 77568; 77587; 77598, 77599; 77837; 77923; 77925; 78335, 78336; 80600
- სავაჭრო ნიშნის სასაქონლო ნიშნები, რომლებსაც მიენიჭათ დაცვა საქართველოში: 72500; 72937; 73193; 73259; 73504; 74084; 74338; 74384; 74408-74421; 74520; 74523; 74526; 74626-74629; 74631; 74633; 74635; 74638-74640; 74643, 74644; 74676; 74696; 74839-74845; 74848; 74858-74867; 74871, 74872; 74876-74882; 74884-74888; 74891-74895; 74897, 74898; 74906-74911; 74913-74919; 74943; 75051; 75054; 75058-75060; 75063; 75067; 75072; 75160, 75161; 75163; 75165-75172; 75174, 75175; 75205; 75253, 75254; 75256; 75266; 75269; 75278; 75287; 75289-75291; 75293-75296; 75298; 75308; 75310; 75312, 75313; 75327-75330; 75333-75336; 75355-75359; 75422; 75433; 75621; 75939; 76095; 76907

საქონლის ადგილწარმოშობის დასახელებები და გეოგრაფიული აღნიშვნები

- რეგისტრირებული ადგილწარმოშობის დასახელება: 849-853

გამოგონებები

ბანასხალები, რომლებზეც გამოტანილია გადაწყვეტილება პატენტის გასაქმის შესახებ

გადაწყვეტილების გასაჩივრება შესაძლებელია საქპატენტის სააპელაციო პალატაში გამოქვეყნებიდან 3 თვის ვადაში ან მცხეთის რაიონული სასამართლოს ადმინისტრაციულ საქმეთა კოლეგიაში 1 თვის ვადაში (მის.: ქ. მცხეთა, სამხედროს ქ. №17).

ბანყოფილება A

A 01

(10) AP 2015 13392 A (51) Int. Cl. (2006)
A 01 D 46/26

(21) AP 2014 013392 (22) 2014 02 18

(71) ნუგზარ ებანოიძე (GE)
ზურაბ ჭავჭავაძის ქ. 50, კოტეჯი 2/38,
4600, ქუთაისი (GE);
ვიტალი დუნდუა (GE)
გამსახურდიას ქ. 12, ბ. 63, 4600,
ქუთაისი (GE)

(72) ნუგზარ ებანოიძე (GE);
ვიტალი დუნდუა (GE).

(54) ხეხილის ნაყოფის დამჭერი
მოწყობილობა

(57) მოწყობილობა შეიცავს ენერგეტიკულ საშუალებაზე 1 დამაგრებულ ნაყოფს შემკრებს ბრტყელი დახრილი ზედაპირით, რომელიც შესრულებულია ენერგეტიკული საშუალების ორივე მხარეს, მისდამი სიმეტრიულად განლაგებული შიგა 2 და გარე 3 ნახევარჩარჩოთა წყვილების სახით. შიგა და გარე ნახევარჩარჩოები ერთმანეთთან დაკავშირებულია მათი შემაერთებელი ჩამკეტი მექანიზმით 4.

მუხლები: 1 დამოუკიდებელი

ფიგურა: 4

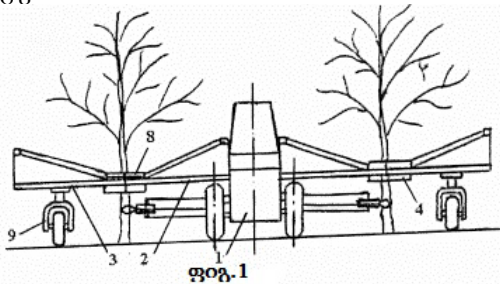

A 61

(10) AP 2015 12505 A (51) Int. Cl. (2006)
A 61 K 9/16

A 61 K 9/20

A 61 K 9/28

A 61 K 31/55

(21) AP 2010 012505 (22) 2010 05 14

(31) 61/268,438; 61/216,493

(32) 2009 06 12; 2009 05 18

(33) US; US

(71) მილენიუმ ფარმაცევტიკალს, ინკ. (US)
40 ლენდსლაუნ სტრიტი, კემბრიჯი,
მასაჩუსეტსი (US)

(72) ბჰავიშია მიტალი (IN)

(74) შალვა გვარამაძე

(85) 2011 12 16

(86) PCT/US2010/001434, 2010 05 14

(54) მჟარი ფორმის ფარმაცევტული
კომპოზიციები და მათი მიღების ხერხი

(57) ფარმაცევტული კომპოზიცია, რომელიც აქტიური ინგრედიენტის სახით შეიცავს ნატრიუმ 4-[[9-ქლორ-7-(2-ფთორ-6-მეთოქსიფენილ)-5H-პირიმიდო[5,4-D][2]ბენზოაჰეპინ-2-ილ] ამინო]-2-მეთოქსიბენზოჰეპტაჰას ან მის კრისტალურ ფორმას და ფარმაცევტული კომპოზიციის სველი გრანულაციის გზით მიღების ხერხი.

მუხლები: 2 დამოუკიდებელი

45 დამოკიდებული

ბანყოფილება B

B 29

(10) AP 2015 13329 A (51) Int. Cl. (2006)
B 29 C 51/36

(21) AP 2013 013329 (22) 2013 12 18

(71) ნიკოლოზ იაკობიძე (GE)
ბახტრიონის ქ. 24, ბ. 28, 0194,
თბილისი (GE);
ნიკოლოზ ნიკოლოზის ძე იაკობიძე (GE)

ფასანაურის ქ. 15, 0179, თბილისი (GE)

(72) ნიკოლოზ იაკობიძე (GE);

ნიკოლოზ ნიკოლოზის ძე იაკობიძე (GE)

(54) რთული კონფიგურაციის
ნაპეტივის დასამზადებელი
მოწყობილობა

(57) მოწყობილობა შეიცავს ნამზადის სახურებელ-დამწნეხავ და საცივარ-მასტაბილიზირებელ სისტემებს, ამასთან, თითოეული სისტემა შესრულებულია რეზერვუარის სახით.

ეოველი რეზერვუარი შედგება ძირითადი კორპუსისა და მასთან გასართად მიერთებული სახურავისგან 14 და შესრულებულია მასში სამონტაჟო კასეტის 9 განთავსების შესაძლებლობით. თითოეული სამონტაჟო კასეტა წარმოადგენს ერთმანეთისგან პერმეტიზებულ შიგა ღრუს მქონე ორსექციან 11 და 12 ჩარჩოს, შესრულებულს იმგვარად, რომ, კასეტის რეზერვუარში განთავსების შემდგომ, ხსენებული ღრუ სექციებიდან ერთს გააჩნია შესაბამისი დენადი გარემოს მიმწოდებელ კვანძთან მიღებული 3 მიერთების შესაძლებლობა, ხოლო მეორეს კი მიღებული 4 ვაკუუმირების კვანძთან მიერთების შესაძლებლობა. ხსენებული კასეტა, ასევე, აღჭურვილია მიღებების ჯგუფით 21 და 22, რომელთაგან ნაწილი დაკავშირებულია ხსენებული ღრუ სექციებიდან ერთ-ერთთან და განკუთვნილია კასეტაში სართულებად ჩამონტაჟებული ნამზადიანი სამარჯვების ქვედა არეში და იმავდროულად რეზერვუარში შესაბამისი დენადი გარემოს მისაწოდებლად, ხოლო ნაწილი კი დაკავშირებულია ხსენებული ღრუ სექციებიდან მეორესთან და იმავდროულად მიერთებულია სამარჯვებულ შესრულებულ სადრენაჟო მილთან, თითოეულ სამარჯვში ვაკუუმირების პროცესის წარმართვის უზრუნველსაყოფად. მოწყობილობა, ასევე, აღჭურვილია სამარჯვებით მასში ნამზადების განსათავსებლად.

მუხლები: 1 დამოუკიდებელი
3 დამოკიდებული
ფიგურა: 7

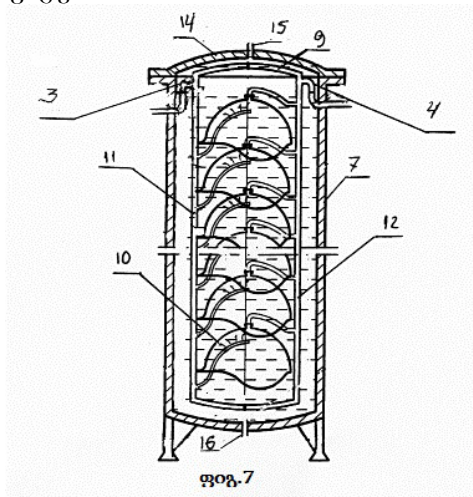

B 42

(10) AP 2015 13187 A (51) Int. Cl. (2006)
B 42 D 15/10
B 42 D 25/00
(21) AP 2012 013187 (22) 2012 01 13
(31) 86/11

(32) 2011 01 18
(33) CH
(71) ტრიუბ აგ (CH)
პინტერე ბანზოფშტრასე 12, CH-5001
აარაუ (CH)
(72) შტეფან ეგლი (CH);
ჰეიდი ვიდმერ გომრესი (CH)
(74) ალექსანდრე გეპჰაკორი
(85) 2013 08 07
(86) PCT/CH2012/000008, 2012 01 13
(54) მრავალფენიანი ინფორმაციის
მატარებლის დამზადების ხერხი და ამ
ხერხით დამზადებული ინფორმაციის
მატარებელი

(57) წარმოდგენილია ისეთი მრავალფენიანი ინფორმაციის მატარებლის დამზადების ხერხი, რომელიც შეიცავს პირველ პოლიმერულ შრეს, რომელსაც აქვს ზედა მხარე, რომელზეც დატანილია ნაწილობრივად დამფარავი გაუმჭვირი შრე, მაგალითად, ლითონის შრე. ინფორმაციის მატარებელს აქვს პოლიმერული მეორე შრე, რომელიც პირველ შრეზეა განთავსებული და გამჭვირვალეა ლითონის შრის, სულ ცოტა, ქვეუბანში. ლაზერის მეშვეობით ხორციელდება ლითონის შრის ნაწილობრივი მოცილება მანამ, სანამ ლითონის შრეში, სულ ცოტა, ერთი დარღვეული ადგილი არ წარმოიქმნება. ლითონის შრე, უპირატესად, ლამინირდება პოლიმერულ პირველ და მეორე შრეებს შორის.
მუხლები: 2 დამოუკიდებელი
19 დამოკიდებული
ფიგურა: 4

B 60

(10) AP 2015 13165 A (51) Int. Cl. (2006)
B 60 B 37/10
(21) AP 2013 013165 (22) 2013 07 18
(71) გიორგი იოსების ძე თუმანიშვილი (GE)
დიდი დილომი, III მკრ., კორპ. 4, ბ. 65, 0131,
თბილისი (GE);
თენგიზ ნადირაძე (GE)
ბახტრიონის ქ. 7ა, ბ. 33, 0194,
თბილისი (GE);
გიორგი გიორგის ძე თუმანიშვილი (GE)
დიდი დილომი, III მკრ., კორპ. 4, ბ. 65, 0131,
თბილისი (GE)
(72) გიორგი იოსების ძე თუმანიშვილი (GE);
თენგიზ ნადირაძე (GE);
გიორგი გიორგის ძე თუმანიშვილი (GE)
(54) მარბონის წყვილთვალი
(57) წყვილთვალი შეიცავს ღერძს და მასზე დაყენებულ თვლებს 3 და 7 და ბუქსებს 1 და 10, ამასთან, ღერძი შესრულებულია ორი ერთმანეთში ჩასმული ღრუ ლილვის სახით,

სადაც გარე ლილვი 4 მიერთებულია შიგა ლილვთან 5 შუა ადგილზე გარანტირებული ჭეკით, ხოლო დანარჩენ ადგილებზე მათ შორის ღრეჩოა, გარდა ამისა, თვლებიდან ერთი გარე ლილვზე დასმულია უძრავად, ხოლო მეორე – ბრუნვის შესაძლებლობით. შესრულების ერთ ვარიანტში თითოეულ თვალზე თვლის გორვის ზედაპირსა და ქიმს შორის ამოჭრილია ღარი ამ ზედაპირების რელსის კუთხესთან ურთიერთქმედების და ხახუნის მოდიფიკატორის ქიმიდან გორვის ზედაპირზე გადასვლის გამოსარიცხად, ხოლო მეორე ვარიანტში თითოეული თვლის ქიმი 12 დამზადებულია ცალკე დეტალის სახით, რომელიც დასმულია აღნიშნულ თვალზე მოძრავად ან უძრავად და დაფიქსირებულია საყელურის 11 მეშვეობით.
 მუხლები: 2 დამოუკიდებელი
 ფიგურა: 1

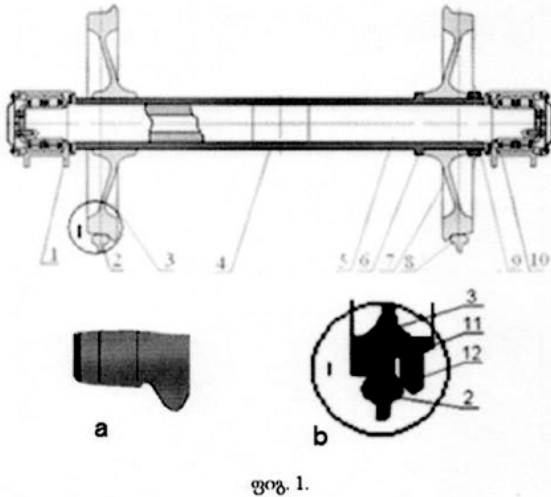

- (31) 09175233.7
- (32) 2009 11 06
- (33) EP
- (71) ვიტა ფარმასიუტიკალზ, ინკ. (US)
 502 ვესტ ოფის ცენტერ დრაივი, ფორტ ვაშინგტონი, პენსილვანია 19034 (US);
 ბორინგერ ინგელჰეიმ ინტერნეიშენალ გმბჰ (DE)
 ბინგერ შტრასე 173, D - 55216 ინგელჰეიმ ამ რეინი (DE)
- (72) მატიას ეკჰარდტი (DE);
 სტეფან პეტერსი (DE);
 პერბერტ ნარი (DE);
 ფრანკ ჰიმელსბახი (DE);
 ლინჰან ჩუჟანი (CN)
- (74) თამაზ შილაკაძე
- (85) 2012 06 05
- (86) PCT/US2010/055586, 2010 11 05
- (54) **ჰმსაჰიდროინფინოპირიდინის და ოქტაჰიდროპენზოქინოლინის არილ- და ჰეტეროარილკარბონილ წარმოებულები**
- (57) ნაერთი ფორმულით

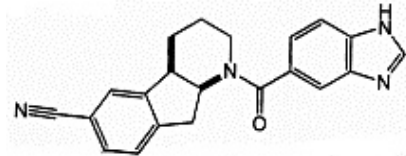

ფარმაცევტული კომპოზიცია მის საფუძველზე, მისი გამოყენება 11β-ჰიდროქსისტეროიდ დეჰიდროგენაზა 1-ის (HSD) ინჰიბიტორებად და მეტაბოლური მოშლილობების სამკურნალოდ.
 მუხლები: 3 დამოუკიდებელი
 3 დამოკიდებული
 ცხრილი: 3

ბანყოფილება C

C 07

- (10) AP 2015 12734 A (51) Int. Cl. (2006)
 C 07 D 221/10
 C 07 D 401/06
 C 07 D 401/12
 C 07 D 417/06
 C 07 D 471/04
 A 61 K 31/473
 A 61 K 31/497
 A 61 K 31/498
 A 61 K 31/5377
 A 61 P 3/00
 C 07 D 401/14
 C 07 D 405/14
 C 07 D 498/04
- (21) AP 2010 012734 (22) 2010 11 05

- (10) AP 2015 13204 A (51) Int. Cl. (2006)
 C 07 D 403/12
 C 07 D 407/12
 C 07 D 409/12
 A 61 K 31/4155
 A 61 P 29/00
- (21) AP 2012 013204 (22) 2012 01 20
- (31) 11151876.7
- (32) 2011 01 24
- (33) EP
- (71) ბოერინგერ ინგელჰაიმ
 ინტერნაციონალ გმბჰ (DE)
 ბინგერ შტრ. 173, 55216 ინგელჰაიმ ამ რაინ (DE)
- (72) რალფ ანდერსკევიტცი (DE);
 დომნიკ მარტირესი (DE);
 თორსტენ ოლსტი (DE);
 ვოლფგანგ რისტი (DE);
 პეტერ სეიტერი (DE)
- (74) თამარ კოჭლამაზაშვილი

- (85) 2013 08 23
- (86) PCT/EP2012/050830, 2012 01 20
- (54) პირაზოლები, რობორც CRTH2 ანტაგონისტები

(57) პირაზოლები ფორმულით (Ia) ან (Ib),

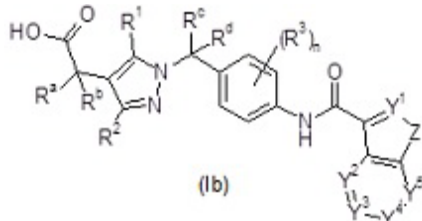
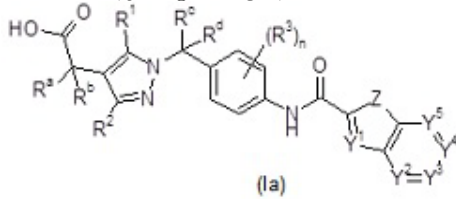

ფარმაცევტული პრეპარატები მათ საფუძველზე და მათი გამოყენება სამკურნალო საშუალების დასამზადებლად ისეთი დაავადებების სამკურნალოდ, რომლებიც დაკავშირებულია CRTH2-ის აქტივობასთან.

მუხლები: 6 დამოუკიდებელი
17 დამოკიდებული
ცხრილი: 2

- (10) AP 2015 13211 A (51) Int. Cl. (2006) C 07 D 487/04 A 61 K 31/519 A 61 P 25/00

- (21) AP 2012 013211 (22) 2012 01 31
- (31) 61/437,848; WO2012/104293
- (32) 2011 01 31; 2012 01 31
- (33) US; IB
- (71) ბოერინგერ ინგელჰაიმ ინტერნაციონალ გმბჰ (DE) ბინგერ შტრ. 173, 55216 ინგელჰაიმ ამ რაინ (DE)
- (72) ჰანს-იოაჰიმ ლანკაუ (DE); ბარბარა ლანგენი (DE); ხრისტიან გრუნვალდი (DE); ნორბერტ ხეფგენი (DE); ჰანს შტანგე (DE); რიტა დოსტი (DE); უტე ვგერლანდი (DE)
- (74) თამარ კოჭლამაზაშვილი
- (85) 2013 08 30
- (86) PCT/EP2012/051546, 2012 01 31
- (54) (1,2,4) ტრიაზოლო [4,3-A] ქინოქსალინის წარმოებულები, რობორც ფოსფორიფოსფატის ინჰიბიტორები

(57) (1,2,4)ტრიაზოლ[4,3-a]ქინოქსალინის წარმოებულები, ზოგადი ფორმულით (I),

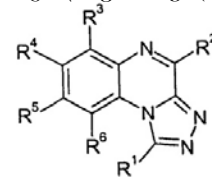

რომლებიც წარმოადგენენ ფოსფორიფოსფატის (PDE2 და PDE10) ინჰიბიტორებს გამოიყენება ცენტრალური ნერვული სისტემის დაავადებების სამკურნალოდ.
მუხლები: 3 დამოუკიდებელი
18 დამოკიდებული

- (10) AP 2015 12527 A (51) Int. Cl. (2006) C 07 H 21/04 C 12 N 15/11

- (21) AP 2010 012527 (22) 2010 06 08
- (31) 61/185,033
- (32) 2009 06 08
- (33) US
- (71) მირაგენ ტერაპეუტიკს (US) 6200 ლუქაუთ როუდი, ბოულდერი, კოლორადო 80301 (US)
- (72) ქრისტინა იამადა (US); უილიამ ს. მარშალი (US)
- (74) თამაზ შილაკაძე
- (85) 2012 01 03
- (86) PCT/US2010/037821, 2010 06 08
- (54) miRNA ინჰიბიტორებისა და მიმეტიკების ქიმიური მოდიფიკაციები
- (57) წარმოდგენილია პოლინუკლეოტიდური miRNA (მიკრორნმ) ინჰიბიტორები სპეციფიკური მოდიფიკაციებით, რომლებიც ეფექტურია miR15b-ს ინჰიბიტორებისათვის. მოცემულია, აგრეთვე, მათი შემცველი ფარმაცევტული კომპოზიციები და მათი გამოყენება მიკრორნმ-ის ექსპრესიასთან დაკავშირებული მდგომარეობების, კერძოდ, გულ-სისხლძარღვთა პათოლოგიების სამკურნალოდ.
მუხლები: 3 დამოუკიდებელი
10 დამოკიდებული
ფიგურა: 8

ბანყოფილება E

E 02

(10) AP 2015 13388 A (51) Int. Cl. (2006)
E 02 F 5/32

(21) AP 2014 013388 (22) 2014 02 14

(71) ვაჟა გოგაძე (GE)
9 აპრილის ხეივანი 15/57, 4400,
ფოთი (GE);
მამუკა გოგაძე (GE)
9 აპრილის ხეივანი 15/60, 4400,
ფოთი (GE);
ალექსანდრე კვირიკაშვილი (GE)
სოფ. ვარძია, 5600, ხარაგაულის რ-ნი (GE)

(72) ვაჟა გოგაძე (GE);
მამუკა გოგაძე (GE);
ალექსანდრე კვირიკაშვილი (GE).

(54) საფხვიერებელი

(57) საფხვიერებელი შეიცავს საბაზო ტრაქტორთან 1 საკიდი სისტემით დაკავშირებულ განივ ძელზე 2 დაყენებულ საფხვიერებელ კბილს 3. საფხვიერებელი კბილის კავშირი საკიდი სისტემის დგართან 4 შესრულებულია ერთმანეთთან დაკავშირებული განივდერძიანი და გრძივდერძიანი სახსრითა 5 და ორი ჰიდროცილინდრით 6.

მუხლები: 1 დამოუკიდებელი
ფიგურა: 2

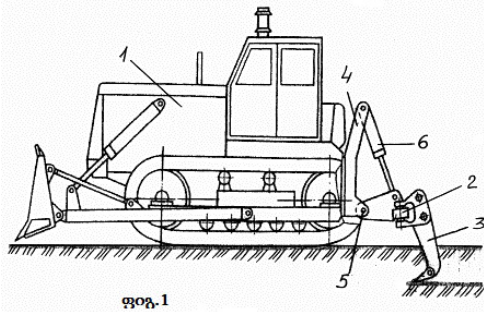

(57) ენერგოსისტემა შეიცავს მთიანი რელიეფის მასივში გაყვანილ ჰორიზონტალურ 1 და ვერტიკალურ 6 გვირაბებს, მათი შეუღლების ადგილში განთავსებულ სამანქანო კამერას 3, რომელშიც დამონტაჟებულია ჰაერის ნაკადით მომუშავე ამძრავით 4 აღჭურვილი გენერატორი 5.

მუხლები: 1 დამოუკიდებელი
ფიგურა: 2

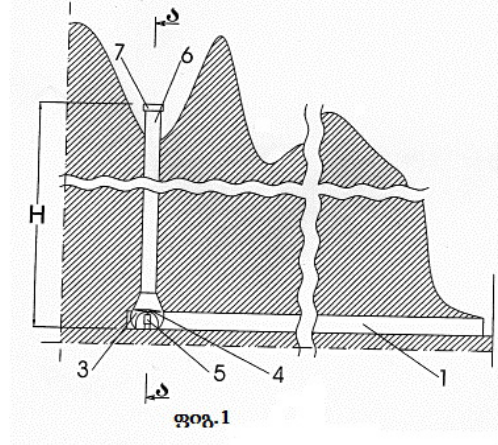

ბანყოფილება H

H 01

(10) AP 2015 11917 A (51) Int. Cl. (2006)
H 01 S 3/067

(21) AP 2010 011917 (22) 2010 08 16

(71) მიხეილ გვათუა (GE)
დიდი დილომი, III მკრ., კორპ. 15, ბ. 168,
0131, თბილისი (GE);
ნინო გვათუა (GE)
დიდი დილომი, III მკრ., კორპ. 15, ბ. 168,
0131, თბილისი (GE);
ვარა გვათუა (GE)
დიდი დილომი, III მკრ., კორპ. 15, ბ. 168,
0131, თბილისი (GE)

(72) შალიკო გვათუა (GE)

(54) ბოჭკოვანი ლაზერი

(57) ბოჭკოვანი ლაზერი შეიცავს აქტიურ ბოჭკოვან შექსატარს, რომლის გულარი ლეგირებულია ფლუორესცენციის უნარის მქონე მინარეგებით, მაგალითად, იშვიათ მიწათა ელემენტებით და უწყვეტი აგზნების შექდილურ სისტემას. აქტიური ბოჭკოვანი შექსატარის შესასვლელ ბოლოზე ფორმირებულია ნახევრადსფერული მიკროლინზა ოპტიკური წებოსგან, რომლის შემადგენლობაში დამატებით შეყვანილია ლაზერული გამოსხივების პასიური მოდულაციის გამომწვევი საღებავი, ხოლო აქტიური ბოჭკოვანი შექსატარის გამოსასვლელი ბოლო ფიქსირებულია პირველ

ბანყოფილება F

F 03

(10) AP 2015 13395 A (51) Int. Cl. (2006)
F 03 G 4/00

(21) AP 2014 013395 (22) 2014 02 20

(71) თემურ ფხოველიშვილი (GE)
ძოწენიძის ქ. 4ა, კორპ. 1, ბ. 9, 0183,
თბილისი (GE)

(72) თემურ ფხოველიშვილი (GE)

(54) პეტროტერმული ენერგოსისტემა

პიესოელემენტზე და ოპტიკურად დაკავშირებულია ბოჭკოვან პიესომოდულატორთან, რომელიც წარმოადგენს პასიურ ბოჭკოვან შუქსატარს, რომლის შესასვლელი ბოლო ფიქსირებულია მაკოდირებელი ელექტროსიგნალით მართვად მეორე პიესოელემენტზე.

მუხლები: 1 დამოუკიდებელი

3 დამოკიდებული

ფიგურა: 1

გამომგონების კატეგორია

განყოფილება A

A 01

- (11) P 2015 6268 B** (51) **Int. Cl. (2006)**
A 01 N 25/04
A 01 N 25/32
- (10) AP 2014 12698 A (44) 24(412)/2014
 (21) AP 2010 012698
 (22) 2010 10 04
 (24) 2010 10 04
 (31) 61/248,983
 (32) 2009 10 06
 (33) US
 (86) PCT/US2010/051282, 2010 10 04
 (73) დაუ აგროსაიენსიზ ელ ელ სი (US)
 9330 ზაიონსვილ როუდ, ინდიანაპოლისი,
 ინდიანა 46268 (US)
 (72) ფრანკლინ კინი (US);
 მეი ლი (CN)
 (74) თამარ კოჭლამაზაშვილი
 (54) „**ზეთი წყალში ტიპის სტაბილური**
ემულსია“

- (11) P 2015 6266 B** (51) **Int. Cl. (2006)**
A 01 N 43/90
C 07 D 211/94
C 07 D 471/10
- (10) AP 2014 12291 A (44) 24(412)/2014
 (21) AP 2009 012291
 (22) 2009 12 09
 (24) 2009 12 09
 (31) 0822748.0; 0905237.4
 (32) 2008 12 12; 2009 03 26
 (33) GB; GB
 (86) PCT/EP2009/066710, 2009 12 09
 (73) სინჯენტა პარტიციპეიშენს აგ (CH)
 შვარცვალდალვე 215, CH-4058,
 ბაზელი (CH);
 სინჯენტა ლიმიტედ (GB)
 იუროპეან რეჯიონალ სენტრ, პრისტლი
 როუდ, სურეი რისერჩ პარკ, გილდფორდი,
 სურეი GU2 7YH,UK (GB)
 (72) მიხეილ მუელეზაჰი (CH);
 ტომას პიტერნა (AT);
 ჯერომ ივ კასაიარ (FR);
 ენდრიუ ედმუნდსი (GB);
 კამილა კორსი (IT);
 მირიამ ელ კასემი (FR);
 როჯერ გრეკემ ჰოლი (GB);
 ანდრე ჟანგუნო (CH);
 ანდრე სტოლერი (CH);

- კრისტოფერ რიხარდ ეილის
 გოდფრეი (GB);
 იურგენ ჰარი შეტცერი (DE);
 ოლივერ ლუისელერი (CH);
 პეტერ მაიენფიში (CH);
 ნეილ ბრიან კარტერი (GB)
 (74) თამარ კოჭლამაზაშვილი
 (54) **საბრომეტირეტიკული N-ოქსიპიპე-**
რიდინები პესტიციდების სახით

A 23

- (11) P 2015 6274 B** (51) **Int. Cl. (2006)**
A 23 C 9/13
- (10) AP 2014 13192 A (44) 24(412)/2014
 (21) AP 2013 013192
 (22) 2013 08 13
 (24) 2013 08 13
 (73) ზურაბ ცქიტიშვილი (GE)
 დები იშხნელები ქ. 4, ბ. 3, 0160,
 თბილისი (GE)
 (72) ზურაბ ცქიტიშვილი (GE)
 (54) **ნაღვლის წარმოების ხერხი**

- (11) P 2015 6275 B** (51) **Int. Cl. (2006)**
A 23 C 19/076
A 01 J 25/00
- (10) AP 2014 13193 A (44) 24(412)/2014
 (21) AP 2013 013193
 (22) 2013 08 13
 (24) 2013 08 13
 (73) ზურაბ ცქიტიშვილი (GE)
 დები იშხნელები ქ. 4, ბ. 3, 0160,
 თბილისი (GE)
 (72) ზურაბ ცქიტიშვილი (GE)
 (54) **აღდგენილი რძისბან ხაჭოს წარმოების**
ხერხი და მოწყობილობა მის
ბანსახორციელებლად

ბანყოფილება B

B 61

- (11) P 2015 6276 B (51) Int. Cl. (2006)
B 61 B 12/04
 (10) AP 2014 13313 A (44) 24(412)/2014
 (21) AP 2013 013313
 (22) 2013 12 06
 (24) 2013 12 06
 (73) ბელა ნაეროზაშვილი (GE)
 ვახბეგის გამზ. 33, ბ. 11, 0177,
 თბილისი (GE);
 თამაზ მჭედლიშვილი (GE)
 ტიციან ტაბიძის ქ. 76, 0179,
 თბილისი (GE);
 ზაურ ბალამწარაშვილი (GE)
 საბურთალოს ქ. 37/4, ბ. 12, 0102,
 თბილისი (GE);
 მარინე ტყემალაძე (GE)
 ვახისუბანი, IV მკრ., I კვარტ., კორპ. 19,
 ბ. 37, 0152, თბილისი (GE);
 რამაზ ტყემალაძე (GE)
 სოფ. ეწერი, 5510, ჭიათურა (GE);
 ლუარსაბ მეხერიშვილი (GE)
 სოფ. ახალუბანი, 3308, მცხეთა (GE)
 (72) ბელა ნაეროზაშვილი (GE);
 თამაზ მჭედლიშვილი (GE);
 ზაურ ბალამწარაშვილი (GE);
 მარინე ტყემალაძე (GE);
 რამაზ ტყემალაძე (GE);
 ლუარსაბ მეხერიშვილი (GE)
 (54) **საკიფი საბაბირო ბზის ვაბონის ბანოვი
 რხევის დინამიკური ჩამოშობი
 მოწყობილობა**

- (32) 2009 12 29
 (33) EP
 (86) PCT/EP2010/070793, 2010 12 28
 (73) პოლიქემ ს.ა. (LU)
 50, ვალ ფლეური, ლ-1526, ლუქსემ-
 ბურგი (LU)
 (72) სტეფანია გაგლიარდი (IT);
 სიმონ დელ სორდო (IT);
 ფედერიკო მაილანდი (IT);
 მიქელა ლეგორა (IT)
 (74) ალექსანდრე გეგეპკორი
 (54) **8-ჰიდროქსიჰინოლი-7-პარბოქსამიდის
 ახალი მემრეული წარმოებულები**

- (11) P 2015 6267 B (51) Int. Cl. (2006)
C 07 D 471/04
C 07 D 471/14
A 61 K 31/437
A 61 K 31/4375
A 61 P 35/00

- (10) AP 2014 12484 A (44) 24(412)/2014
 (21) AP 2010 012484
 (22) 2010 06 02
 (24) 2010 06 02
 (31) 61/184,141
 (32) 2009 06 04
 (33) US
 (86) PCT/EP2010/057719, 2010 06 02
 (73) ნოვარტის აგ (CH)
 ლისტშტრასე 35, CH-4056, ბაზელი (CH)
 (72) პასკალ ფურე (FR);
 ფრანკ შტეფან კალტჰოფი (DE);
 რობერტ შაჰი (CA);
 კრისტინ რაგო (CH);
 ფრედერიკ სტაუფერი (CH)
 (74) ალექსანდრე ქართველიშვილი
 (54) **1H-იმიდაზო[4,5-c]ჰინოლინის
 წარმოებულები**

ბანყოფილება C

C 07

- (11) P 2015 6269 B (51) Int. Cl. (2006)
C 07 D 215/48
C 07 D 401/12
C 07 D 407/12
C 07 D 409/12
C 07 D 413/12
C 07 D 417/12
A 61 K 31/4709
A 61 P 31/10
 (10) AP 2014 12811 A (44) 24(412)/2014
 (21) AP 2010 012811
 (22) 2010 12 28
 (24) 2010 12 28
 (31) 09180895.6

ბანყოფილება F

F 02

- (11) P 2015 6271 B (51) Int. Cl. (2006)
F 02 B 75/32
 (10) AP 2014 13107 A (44) 24(412)/2014
 (21) AP 2013 013107
 (22) 2013 06 05
 (24) 2013 06 05
 (73) რევაზ ვარსიმაშვილი (GE)
 ვაჟა-ფშაველას გამზ., V კვარტ., კორპ. 4,
 ბ. 82, 0186, თბილისი (GE);
 მარიამ ვარსიმაშვილი (GE)
 ვაჟა-ფშაველას გამზ., V კვარტ., კორპ. 4,

- ბ. 82, 0186, თბილისი (GE);
 ზაზა ვარსიმაშვილი (GE)
 ვაჟა-ფშაველას გამზ., V კვარტ., კორპ. 4,
 ბ. 82, 0186, თბილისი (GE);
 ზურაბ ვარსიმაშვილი (GE)
 მცხეთის ქ. 20, ბ. 34, 0179, თბილისი (GE);
 ლუკა ვარსიმაშვილი (GE)
 მცხეთის ქ. 20, ბ. 34, 0179, თბილისი (GE);
 ციალა ვარსიმაშვილი (GE)
 მცხეთის ქ. 20, ბ. 34, 0179, თბილისი (GE);
 მერცია ჭირაქაძე (GE)
 ვაჟა-ფშაველას გამზ., V კვარტ., კორპ. 4,
 ბ. 82, 0186, თბილისი (GE)
- (72) რევაზ ვარსიმაშვილი (GE);
 მარიამ ვარსიმაშვილი (GE);
 ზაზა ვარსიმაშვილი (GE);
 ზურაბ ვარსიმაშვილი (GE);
 ლუკა ვარსიმაშვილი (GE);
 ციალა ვარსიმაშვილი (GE);
 მერცია ჭირაქაძე (GE)
- (54) **შობაწმინდა**

F 03

- (11) P 2015 6272 B (51) Int. Cl. (2006)
F 03 B 3/00
F 03 B 3/12
- (10) AP 2014 13108 A (44) 24(412)/2014
 (21) AP 2013 013108
 (22) 2013 06 05
 (24) 2013 06 05
- (73) ლევან ნიკოლაძე (GE)
 ქ. შარტავას ქ. 35, ბ. 18, 0160,
 თბილისი (GE);
 ვიქსელავ ზაგორუიჩენკო (GE)
 ქ. შარტავას ქ. 35, ბ. 18, 0160,
 თბილისი (GE)
- (72) ლევან ნიკოლაძე (GE);
 ვიქსელავ ზაგორუიჩენკო (GE)
- (54) **ხრახუნული ტურბინა**

- (11) P 2015 6273 B (51) Int. Cl. (2006)
F 03 D 5/02
- (10) AP 2014 13132 A (44) 24(412)/2014
 (21) AP 2013 013132
 (22) 2013 06 21
 (24) 2013 06 21
- (73) ლევან ნიკოლაძე (GE)
 ქ. შარტავას ქ. 35, ბ. 18, 0160,
 თბილისი (GE);
 ვიქსელავ ზაგორუიჩენკო (GE)
 ქ. შარტავას ქ. 35, ბ. 18, 0160,
 თბილისი (GE)
- (72) ლევან ნიკოლაძე (GE);
 ვიქსელავ ზაგორუიჩენკო (GE)

- (54) **ქარის ღვედური დანადგარი
 ღვედთაშორისი თვითღაცენებადი
 ფრთებით**

ბაზოზონები H

H 02

- (11) P 2015 6270 B (51) Int. Cl. (2006)
H 02 J 3/18
- (10) AP 2014 12943 A (44) 24(412)/2014
 (21) AP 2012 012943
 (22) 2012 12 26
 (24) 2012 12 26
- (73) ბადურ ჭუნაშვილი (GE)
 მ. თამარაშვილის ქ. 13ა, ბ. 40, 0177,
 თბილისი (GE);
 ალექსანდრე პეტროსიანი (GE)
 მუხიანის დასახ., II მკრ., კორპ. 8, ბ. 37,
 0172 (GE)
- (72) ბადურ ჭუნაშვილი (GE);
 ალექსანდრე პეტროსიანი (GE)
- (54) **რეაქტიული სიმპლავრის
 კომპენსატორის მართვის ხერხი**

დიზაინები

რეგისტრირებული დიზაინი

- (11) **D 2015 624 S** (51) **12-08**
(10) AD 2014 816 S (44) 24(412)/2014
(21) AD 2014 000816
(22) 2014 09 01
(24) 2014 09 01
(28) 1
(18) 2019 09 01
(73) ირაკლი ხუნდაძე (GE)
თეძქა, III მკრ., I კვარტ., კორპ. 69, ბ. 21,
0197, თბილისი (GE)
(72) ირაკლი ხუნდაძე (GE)
(54) **სვტომობილი**
-

ლიჯანიები, რომლების რეგისტრირებულია სავრთაშორისო ბიუროში საქართველოს ტერიტორიაზე უფლებათა გავრცელების მოთხოვნით

გადაწყვეტილების გასაჩივრება შესაძლებელია საქპატენტის სააპელაციო პალატაში გამოქვეყნებიდან 3 თვის ვადაში ან მცხეთის რაიონული სასამართლოს ადმინისტრაციულ საქმეთა კოლეგიაში 1 თვის ვადაში (მის.: ქ. მცხეთა, სამხედროს ქ. №17).

- (11) **DM/084039** **(51) 10-02**
- (15) 2014 07 18 (45) 2015/03 (2015 01 23)
- (22) 2014 07 18
- (28) 4
- (73) SWATCH AG (SWATCH SA) (SWATCH LTD.)
Jakob-Stämpfli-Strasse 94, CH-2502 Biel/Bienne (CH)
- (85) CH
- (86) CH
- (87) CH
- (88) CH
- (89) CH
- (81) II. BZ, MA, III. AL, AM, AZ, BA, CH, EM, GE, KG, KR, LI, MC, MD, ME, MK, MN, NO, OM, SG, TJ, TN, TR, UA
- (72) 1: Min KIM
St. Alban Ring 238, 4052 Basel, Suisse;
2: Benedicto Reyes Cabrera, "BenCab", Apt.E,
Ecology Village, Don Bosco Street, 1231 Makati City, Philippines;
3: Margherita Taglia
Zahringerstrasse 24, 8001 Zürich, Suisse;
4: Danilo SALA
Via L. Muratori 9, 20050 Sovico, Italie
- (54) 1.-4. Wristwatches
- (55)





2.1



2.2



3.1



3.2



4.1



4.2

(11) DM/084663

(51) 19-99

(15) 2014 07 18

(45) 2015/03 (2015 01 23)

(22) 2014 07 18

(28) 1

(73) FM GROUP WORLD ARTUR TRAWIŃSKI SPÓŁKA Z OGRANICZONĄ
ODPOWIEDZIALNOŚCIĄ SPÓŁKA KOMANDYTOWA
ul. Żmigrodzka 247, PL-51-129 Wrocław (PL)

(85) PL, EM

(86) PL, EM

(87) PL, EM

(88) PL, EM

(89) PL

(81) III. AM, EM, GE, KR, MN, SG

(54) 1. Rotatable device for selection of parfums

(55)



1.1



1.2



1.3



1.4

(11) DM/085335

(51) 09-01

(15) 2015 01 16

(45) 2015/04 (2015 01 30)

(22) 2015 01 16

(28) 1

(30) 27.08.2014; 2014 3769; FR

(73) LVMH FRAGRANCE BRANDS

77 rue Anatole France, F-92300 LEVALLOIS-PERRET (FR)

(85) FR, EM

(86) FR, EM

(87) FR, EM

(88) FR, EM

(89) FR

(81) II. MA. III. CH, EG, EM, GE, KR, LI, MC, ME, MK, OA, RS, SG, TN, TR, UA

(54) 1. Small bottle for perfumery products

(55)



1.1



1.2



1.3



1.4



1.5



1.6



1.7

(11) DM/085345

(51) 07-01

(15) 2015 01 12

(45) 2015/04 (2015 01 30)

(22) 2015 01 12

(28) 6

(30) 16.11.2014, Equip'Hotel, Paris, France

(73) BHS TABLETOP AG

Ludwigsmuehle 1, 95100 Selb (DE)

(85) --

(86) DE, EM

(87) DE, EM

(88) DE, EM

(89) EM

(81) II. KP, MA. III. AZ, BA, CH, EG, EM, GE, GH, IS, KR, LI, MC, MD, ME, MK, NA, NO, OA, OM, RS, SG, TR, UA

(72) 1-6: Carsten Gollnick

Friedrich-Ebert-Str. 37, 14469 Potsdam, Germany

(54) 1. Cup; 2. Flat oval plate; 3. Salad bowl; 4. Plate [dishes]; 5. Plate; 6. Saucer

(55)



1.1



1.2



2.1



2.2



3.1



3.2



4.1



4.2

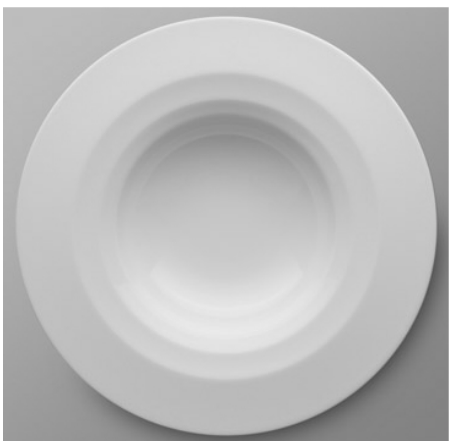

5.1



5.2



6.1



6.2

(11) DM/085359

(51) 02-04

(15) 2014 12 10

(45) 2015/04 (2015 01 30)

(22) 2014 12 10

(28) 2

(73) VALENTINO S.P.A.

Via Turati, 16/18, I-20121 MILANO (IT)

(85) --

(86) EM, IT

(87) EM, IT

(88) EM, IT

(89) EM

(81) III. AZ, EM, GE, KG, KR, TJ, TR, UA

(72) 1-2: SASSI Stefano, c/o VALENTINO S.p.A.

Via Turati, 16/18, I-20121 MILANO, Italy

(54) 1.-2. Shoes

(55)



1.1



1.2



1.3

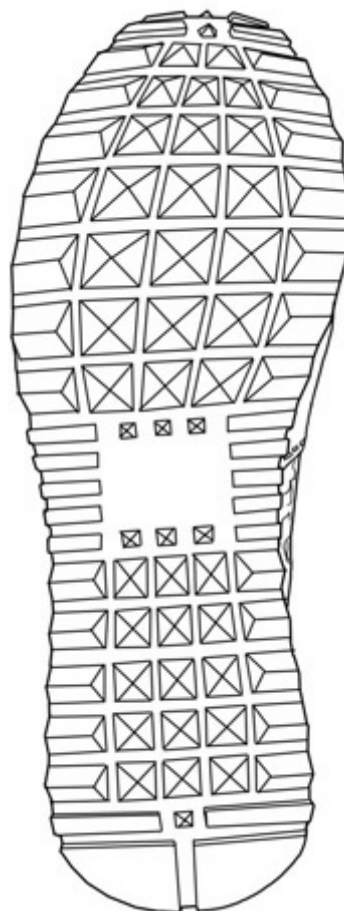



2.1



2.2



2.3



2.4



2.5



2.6



2.7

(11) DM/085372

(51) 23-01

(15) 2014 10 22

(45) 2015/04 (2015 01 30)

(22) 2014 10 22

(28) 3

(30) 24.04.2014; 002452565; EM

(73) 3SUN S.R.L.

Contrada Blocco Terrazze, snc, Z.I., I-95121 CATANIA (CT) (IT)

(85) --

(86) IT, EM

(87) IT, EM

(88) IT, EM

(89) EM

(81) II. MA. III. AL, AM, AZ, BA, BW, GE, GH, HR, KG, NA, OA, OM, ST, TJ, TN, TR

(72) 1-3: D'ANGELO

Salvatore, c/o 3SUN s.r.l. Contrada Blocco Torrazze snc - ZI, 95121 Catania, Italy

(54) 1. Water treatment device; 2. Tank for water treatment device; 3. Water treatment device with a tank

(55)



1.1



1.2



1.3



2



3.1



3.2

(11) DM/084194

(15) 2014 08 12

(22) 2014 08 12

(28) 2

(30) 25.02.2014; 002411918-0001/0002; EM

(73) MAGIC PRODUCTION GROUP S.A.

Findel Business Center, Complexe B, Rue de Trèves, L-2632 Findel (LU)

(85) --

(86) BX, EM

(87) BX, EM

(88) BX, EM

(89) EM

(81) II. BZ, KP, MA, SR. III. AL, AM, AZ, BA, BN, CH, EG, GE, IS, KG, KR, LI, MC, MD, ME, MK, MN, NO, OA, OM, RS, SG, SY, TJ, TN, TR, UA

(72) 1-2: VACCARELLA

Paolo, Strada Pino Torinese, 22bis , I-10020 Baldissero Torinese (Torino), Italy

(54) 1.-2. Construction elements

(55)

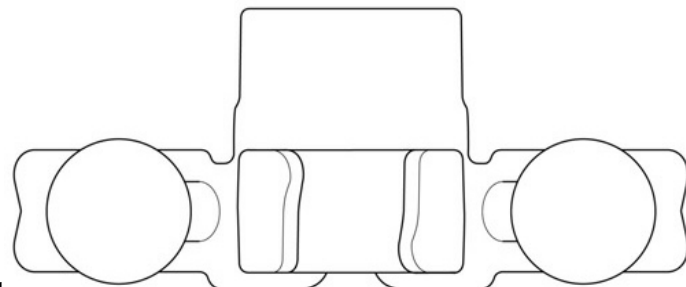
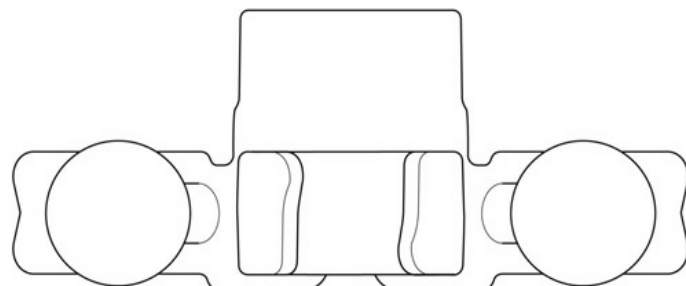
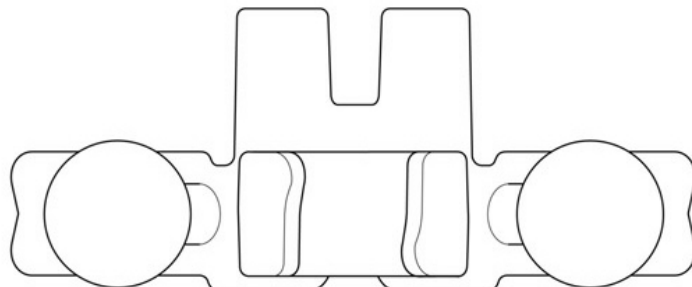
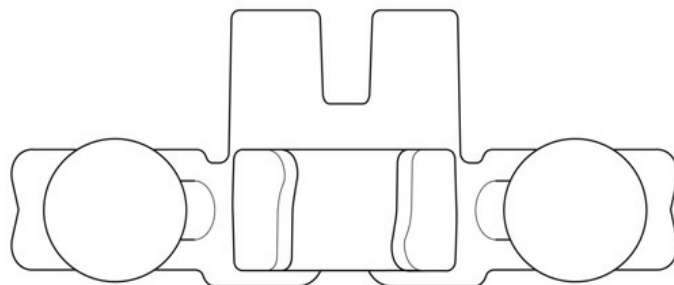

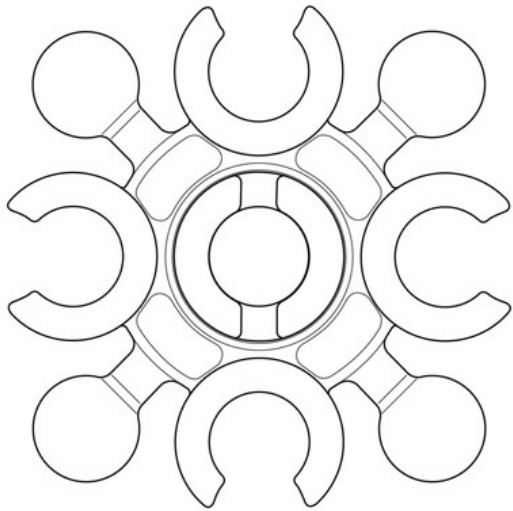

1.5

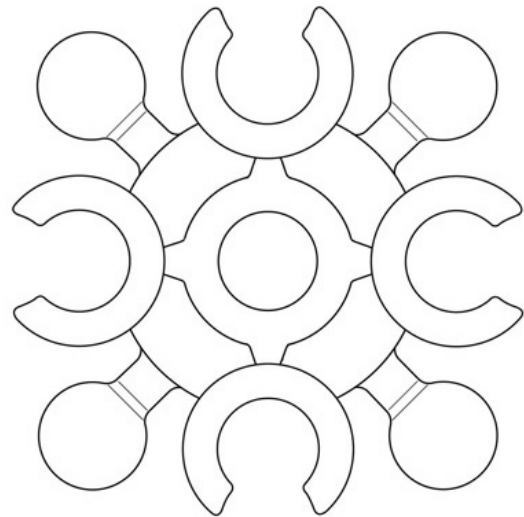

1.6

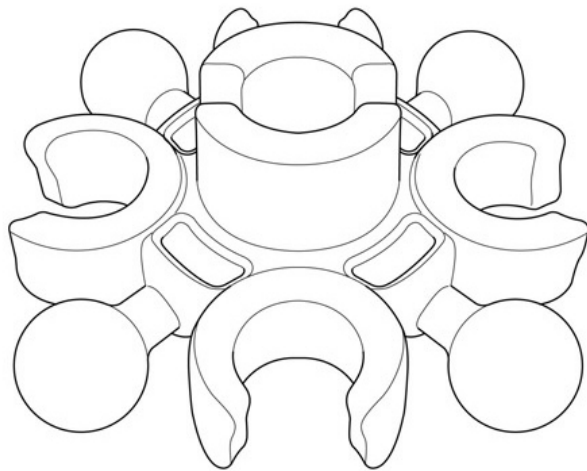

1.7

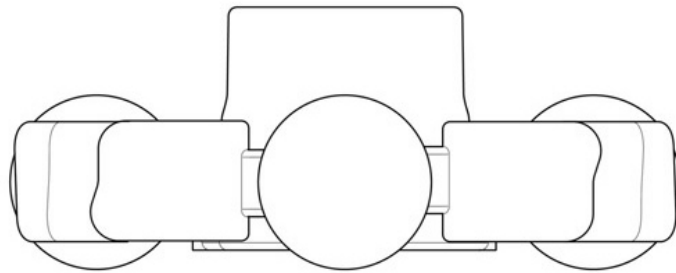

2.1

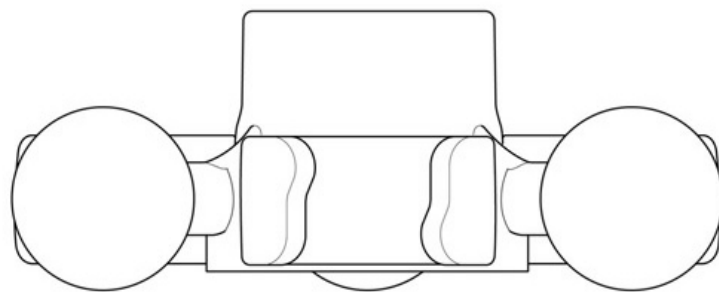

2.2

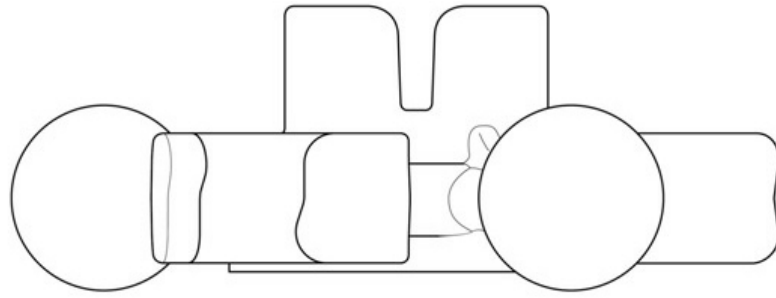

2.3

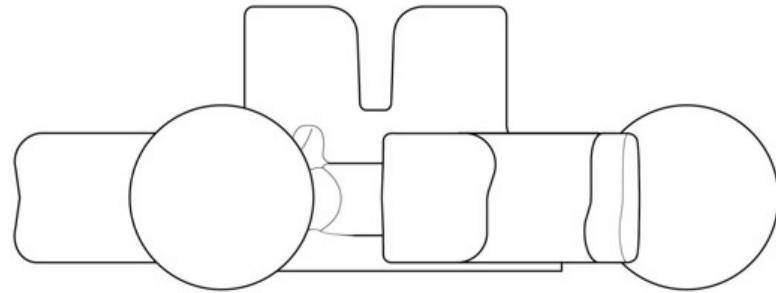

2.4

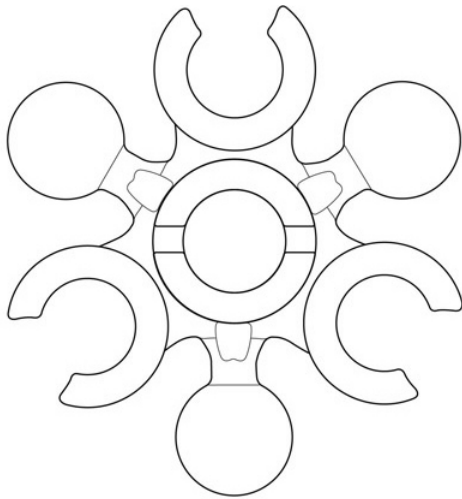

2.5

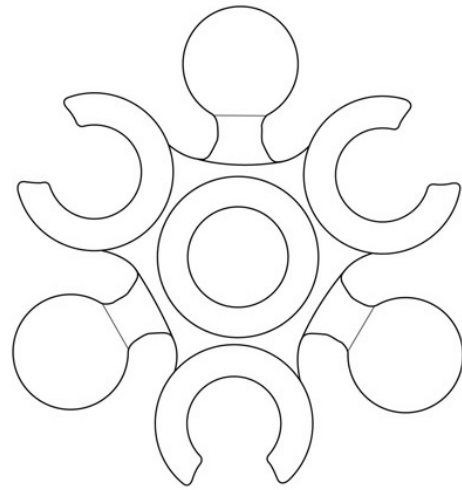

2.6

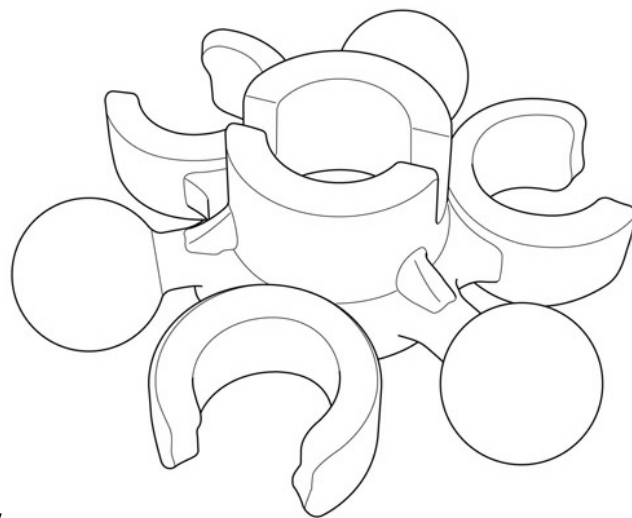

2.7

(11) DM/085494

(51) 26-03

(15) 2015 01 21

(45) 2015/06 (2015 02 13)

(22) 2015 01 21

(28) 2

(30) 28.08.2014; 002526764-0001/0002; EM

(73) SCHREDER S.A.

Rue de Lusambo 67, B-1190 Bruxelles (BE)

(85) EM

(86) EM

(87) EM

(88) EM

(89) EM

(81) III. GE, ME, MK, RS, UA

(72) 1-2: Fabio Righetto

Rua Araxa, 16, 05435-030 Carapicuíba / SP CEP, Brazil

(54) 1.-2. Outdoor lighting fixtures

(55)

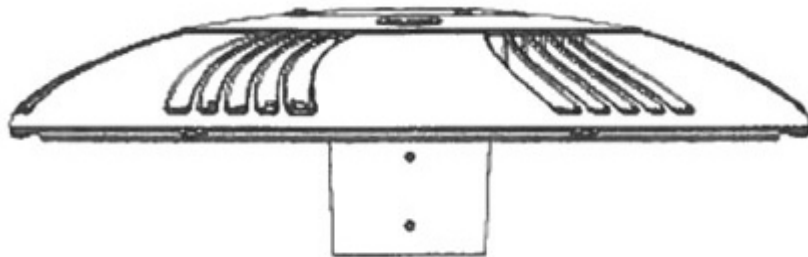

1.1

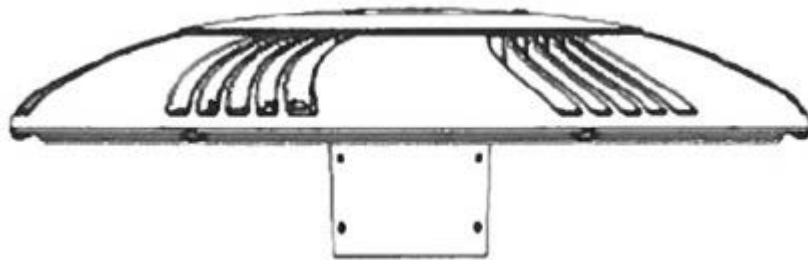

1.2

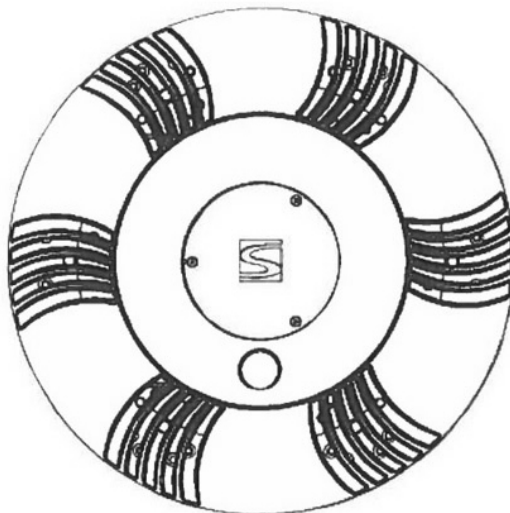

1.3



1.4

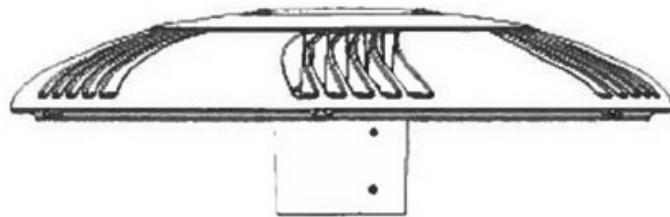

1.5

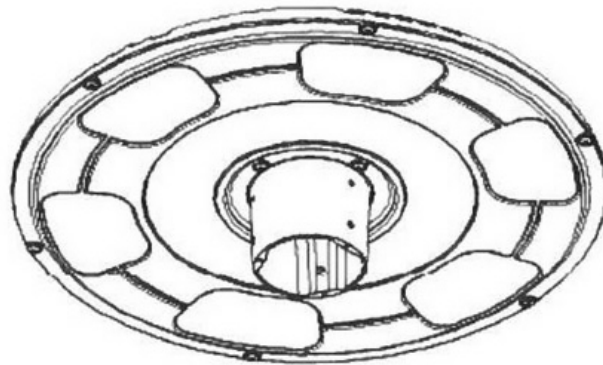

1.6

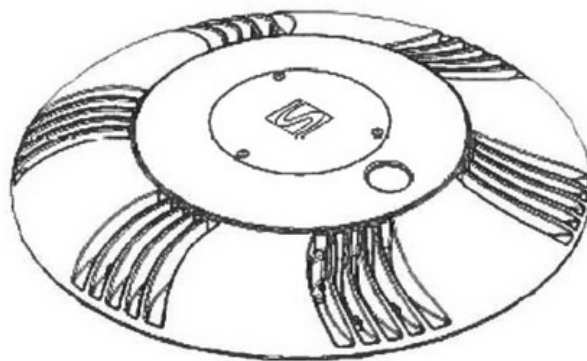

1.7

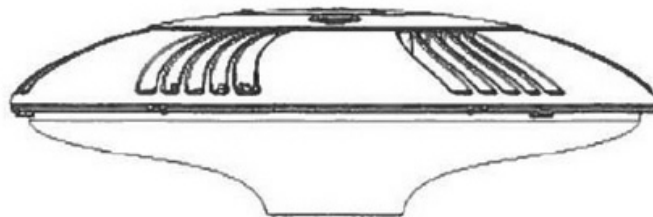

2.1

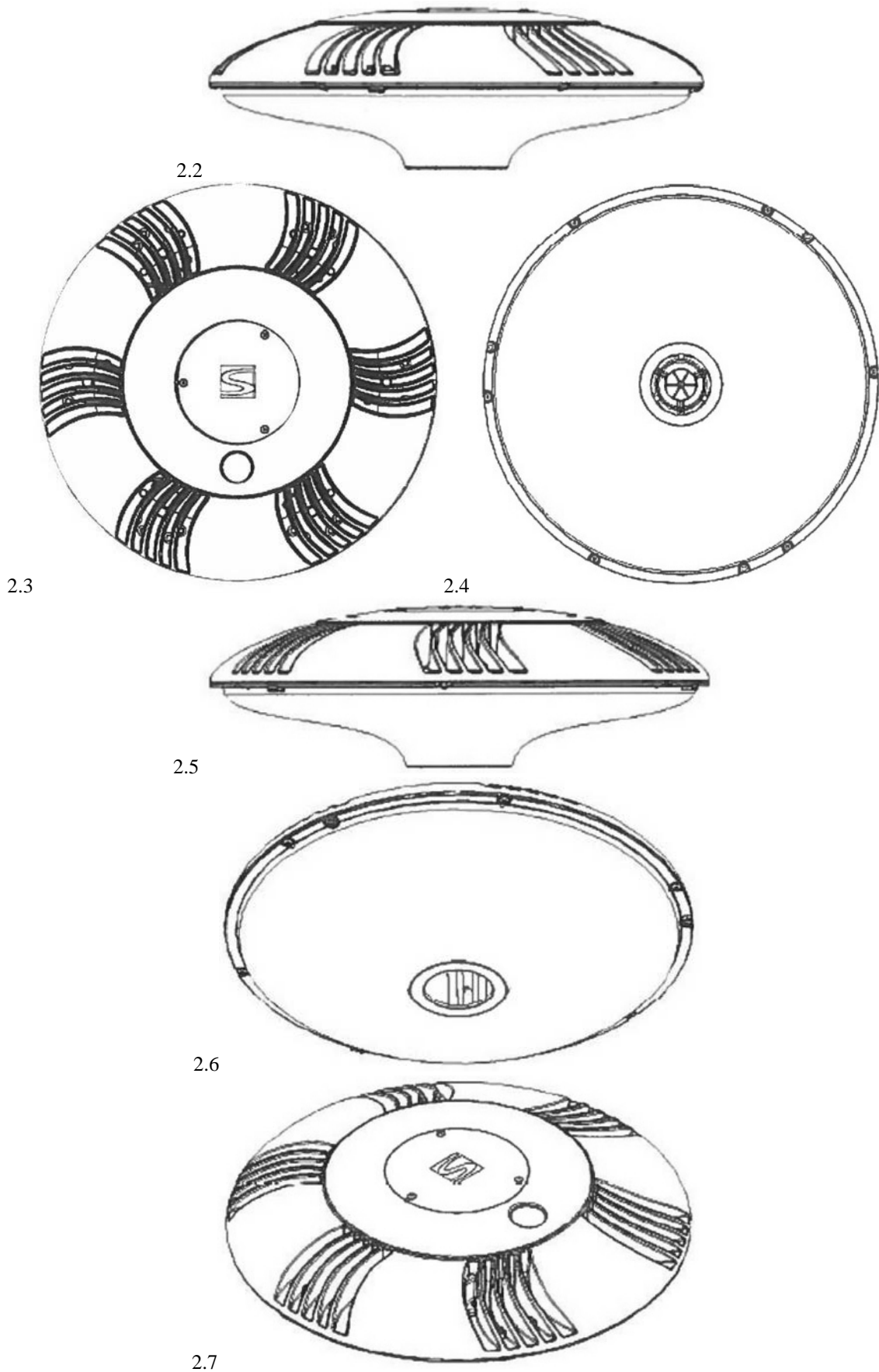

სასაქონლო ნიშნები

ეროვნული პროცედურით შემოტანილი განაცხადები, რომლებზეც გამოტანილია გადაწყვეტილება რეგისტრაციის შესახებ

გადაწყვეტილების გასაჩივრება შესაძლებელია საქპატენტის სააპელაციო პალატაში გამოქვეყნებიდან 3 თვის ვადაში ან მცხეთის რაიონული სასამართლოს ადმინისტრაციულ საქმეთა კოლეგიაში 1 თვის ვადაში (მის.: ქ. მცხეთა, სამხედროს ქ. №17).

(260) AM 2015 75892 A

(210) AM 75892

(220) 2014 02 13

(731) ა(ა)იპ ასოციაცია „ქართული მინა და მინერალური წყლები“ „ბორჯომის“ №2 ჩამომსხმელი ქარხანა, სოფ. ყვიბისი, 1209, ბორჯომის რ-ნი, საქართველო

(540)

ლიკანი

(511)

5 – სამკურნალო მინერალური წყლები.

32 – მინერალური წყლები, გაზირებული წყლები, არაალკოჰოლური სასმელები, მტკნარი წყლები.

35 – რეკლამა; სატელევიზიო რეკლამა, რეკლამისა და გაყიდვების ხელშეწყობის მოდელირება.

(260) AM 2015 76187 A

(210) AM 76187

(220) 2014 03 07

(731) ქოლგეიტ პალმოლივ კომპანი შტატი დელავერის კორპორაცია 300 პარკ ავენიუ, ნიუ-იორკი, ნიუ-იორკის შტატი 10022, აშშ

(740) შალვა გვარამაძე

(540)



(591) წითელი, თეთრი, იისფერი, ყვითელი

(531) 02.09.10, 25.05.25, 26.04.24, 27.05.24, 29.01.14

(526) ნიშანი დაცულია მთლიანობაში. მასში შემავალი სიტყვები "MAXIMUM CAVITY PROTECTION PLUS SUGAR ACID NEUTRALIZER" არ ექვემდებარება დამოუკიდებელ სამართლებრივ დაცვას.

(511)

3 – კბილის პასტები.

(260) AM 2015 76223 A

(210) AM 76223

(220) 2014 03 11

(731) როტმანს ოფ პელ მელ ლიმიტედ ცელერვეგ 4, ცუგი, CH 6300, შვეიცარია

(740) თამარ კოჭლამაზაშვილი

(540)

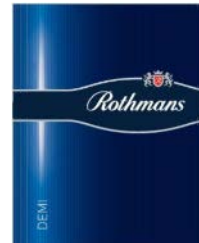

(591) მუქი ლურჯი, ცისფერი, თეთრი, ვერცხლისფერი, წითელი

(531) 24.01.15, 25.01.01, 25.03.11, 26.04.24, 27.05.01, 29.01.14

(511)

34 – სიგარეტი; თამბაქო; თამბაქოს ნაწარმი; სანთებლები; ასანთი; მწვევლთა საკუთნო.

(260) AM 2015 76367 A

(210) AM 76367

(220) 2014 03 21

(731) გიუროკ ტურიზმ ვე მადენჯილიკ ანონიმ შირკეტი

ესკიშეხირ კარაიოლუ უზერი 5. კმ, მერკეზ, კიუთახია, თურქეთი

(740) ქეთევან წაქაძე

(540)

LAV

(591) შავი, თეთრი, ვარდისფერი

(531) 27.05.01, 29.01.12

(511)

21 – საოჯახო და სამზარეულო ჭურჭელი და ჭურჭლეული; სავარცხლები და ღრუბლები; ჯაგრისები (სახატავი ფუნჯების გარდა); მასალები ჯაგრისის ნაკეთობისათვის; სამარჯვები წმენდისა და დასუფთავებისათვის; ლი-

თონის ნეჭა; დაუმუშავებელი ან ნახევრად დაუმუშავებელი მინა (სამშენებლო მინის გარდა); მინის, ფაიფურისა და ქაშანურის ნაკეთობა, რომელიც არ მიეკუთვნება სხვა კლასებს; სინები, ქილები, ნამცხვრის კოლოფები, ჭიქები, ფინჯნები, ლანგრები, კვერცხის ჩასადებები, ეავის ფინჯნები, თიხის ქოთნები, გრაფინები, ნამცხვრის ფორმები, ჩაის დასაყენებელი ქეთლები, მაგიდის გასაწყოები ჭურჭელი, დანების, ჩანგლებისა და კოვზების გარდა, დამზადებული მინის ან ფაიფურისგან, სახელდობრ, ჯამები, ტოლჩები, თევზები, სამარიდეები და საწიწაკეები, სასაწებლები, სურები და ვაზები; სტატუეტები (ფაიფურის, კერამიკის ან მინის -); ფაიფურის, კერამიკის ან მინის ფიგურები და მხატვრული ნაწარმი.

39 – ტრანსპორტირება; საქონლის შეფუთვა და შენახვა; მოგზაურობის ორგანიზება; ტრანსპორტით უზრუნველყოფის სააგენტოს მომსახურება ტურისტებისთვის ექსკურსიების ორგანიზებისთვის; ფრახტით უზრუნველყოფის სააგენტოს მომსახურება ფრახტთან დაკავშირებული საშუალოდ საქმიანობისთვის; გემების სააგენტოს მომსახურება გემით ტვირთის გადაზიდვისთვის; ტურისტული ბიუროს მომსახურება ტურისტული სააგენტოს მომსახურებისთვის და გიდების მომსახურებისთვის; ტრანსპორტირებისა და მოგზაურობის და სამოგზაურო ბილეთების დაჯავშნა; მოგზაურობის ორგანიზების მომსახურება.

43 – საკეები პროდუქტებითა და სასმელებით უზრუნველყოფა; დროებითი საცხოვრებელი უზრუნველყოფა; დროებითი საცხოვრებელი, კერძოდ, სასტუმროებით, მოტელებით, დასასვენებელი ბანაკებით, პანსიონებით უზრუნველყოფის ორგანიზება.

- (260) AM 2015 76401 A
- (210) AM 76401
- (220) 2014 03 25
- (731) შპს „კომპანია ბესინი“
ვაკე-საბურთალოს რაიონი, გამრეკელის ქ. 19, 0160 თბილისი, საქართველო
- (740) მაია ჩაჩიბაია
- (540)



VITE VERA
ვიტე ვერა
ВИТЕ ВЕРА

- (591) შავ-თეთრი
- (531) 26.03.03
- (511)
- 33 – ალკოჰოლიანი სასმელები (ლუდის გარდა).

- (260) AM 2015 76617 A
- (210) AM 76617
- (220) 2014 04 08
- (731) ჰელენიკა კოსმეტიკის პროდაქტს ექსპლოიტეიშენ ეს.ეი
7, კიმარას ქ. 151 25 მაროუსი, საბერძნეთი
- (740) ქეთევან წაქაძე
- (540)



- (591) შავ-თეთრი
- (531) 26.04.22, 27.05.11, 27.05.24, 26.04.24
- (526) ნიშანი დაცულია მთლიანობაში. მასში შემავალი სიტყვები "professional make up" არ ექვემდებარება დამოუკიდებელ სამართლებრივ დაცვას.

- (511)
- 3 – საბნები; შამპუნები; თმის მოვლის საშუალებები; თმის საღებავები; თმის ტონიკები; კოსმეტიკური ღოსიონები; თმის ღოსიონები; თმის დასაყენებელი საშუალებები; კოსმეტიკური ზეთები; ტუალეტის ზეთები; ზეთები სუნამოსა და არომატული საშუალებებისათვის; ტალკი [ტუალეტის საშუალება]; კოსმეტიკური პუდრი; მაკიაჟის საშუალებები; ტონალური კრემები; კრემები (სახის კანის); კრემი სხეულისთვის; ფრჩხილების ლაკი; ტუჩის საცხები; პარფიუმერია; ოდეკოლონი; დეზოდორანტები ადამიანებისთვის, ცხოველებისთვის და გაოფლიანების საწინააღმდეგო ტუალეტის საშუალებები; საპარსი კრემები და გელეები; ნამზეურის მისაღები კოსმეტიკური საშუალებები; ნაოჭების საწინააღმდეგო საშუალებები; კოსმეტიკური საშუალებები.

- (260) AM 2015 76618 A
- (210) AM 76618
- (220) 2014 04 08
- (731) ჰელენიკა კოსმეტიკის პროდაქტს ექსპლოიტეიშენ ეს.ეი
7, კიმარას ქ. 151 25 მაროუსი, საბერძნეთი
- (740) ქეთევან წაქაძე
- (540)



- (591) ვარდისფერი, თეთრი

(531) 02.01.23, 02.03.23, 26.01.14, 27.05.10,
29.01.01

(511)

3 – საპნები; შამპუნები; თმის მოვლის საშუალებები; თმის საღებავები; თმის ტონიკები; კოსმეტიკური ღოსიონები; თმის ღოსიონები; თმის დასაყენებელი საშუალებები; კოსმეტიკური ზეთები; ტუალეტის ზეთები; ზეთები სუნამოსა და არომატული საშუალებებისათვის; ტალკი [ტუალეტის საშუალება]; კოსმეტიკური პუდრი; მაკიაჟის საშუალებები; ტონალური კრემები; კრემები (სახის კანის); კრემი სხეულისთვის; ფრჩხილების ლაკი; ტუჩის საცხები; პარფიუმერია; ოდეკოლონი; დეზოდორანტები ადამიანებისთვის, ცხოველებისთვის და გაოფლიანების საწინააღმდეგო ტუალეტის საშუალებები; საპარსი კრემები და გელები; ნამზეურის მისაღები კოსმეტიკური საშუალებები; ნაოჭებისსაწინააღმდეგო საშუალებები; კოსმეტიკური საშუალებები.

(260) AM 2015 76630 A

(210) AM 76630

(220) 2014 04 08

(731) ამეედ ფუდ ინდასტრი დაბლიუ

ელ. ელ.

ს/ე 1557, იორდანია

(740) ღარისა ამირხანიანი

(540)



(591) შავ-თეთრი

(531) 26.01.04, 26.01.22, 26.01.24, 27.05.24

(526) ნიშანი დაცულია მთლიანობაში. მასში შემავალი სიტყვა "coffee" არ ექვემდებარება დამოუკიდებელ სამართლებრივ დაცვას.

(511)

30 – ყავა და ყავის შემცველები.

(260) AM 2015 76639 A

(210) AM 76639

(220) 2014 04 10

(731) როკფორდ კორპორეიშნ

600 საუს როკფორდ დრაივი, ტემპე,

AZ 85281, აშშ

(740) თამარ კოჭლამაზაშვილი

(540)

LIGHTNING

(511)

9 – კომპიუტერები, კომპიუტერული პერიფერიული მოწყობილობა; კომპიუტერების აპარატული უზრუნველყოფა; პორტატიული ელ-

ექტრონული თამაშების ელემენტები, რომლებიც გამოსაყენებლად ადაპტირებულია გარე დისპლეისთან ან მონიტორთან; პორტატიული ციფრული ელექტრონული მოწყობილობა და მათთვის განკუთვნილი პროგრამული უზრუნველყოფა; ხმის ჩამწერი და აღმწარმოებელი აპარატურა; MP3 და აუდიოპლეერები სხვა ციფრული ფორმატით; ელექტრონული კომუნიკაციური მოწყობილობა და ინსტრუმენტები; ხმის, მონაცემების ან გამოსახულების გადაცემისთვის განკუთვნილი უსადენო კომუნიკაციური მოწყობილობა; კაბელები; მონაცემების შენახვისათვის განკუთვნილი აპარატურა; კომპიუტერული მოწყობილობა, რომელიც გამოიყენება ყველა ზემონახსენებულ საქონელთან; აქსესუარები ყველა ზემონახსენებულ საქონლისათვის.

(260) AM 2015 76701 A

(210) AM 76701

(220) 2014 04 14

(731) შპს „მითანა“

გ. ჭყონდიდელის ქ. 26, 0180 თბილისი, საქართველო

(540)



(591) წითელი, მოყავისფრო, ნარინჯისფერი

(531) 25.01.18, 26.04.04, 28.19, 29.01.13, 03.04.13

(526) ნიშანი დაცულია მთლიანობა, მასში შემავალი სიტყვიერი ელემენტი "პრემიუმი" და ასევე, სასაქონლო ნიშანზე განთავსებული ყველა ის ელემენტი, რომელიც წარმოადგენს საქონლის სახეობას, ხარისხს, რაოდენობას, თვისებას, ღირებულებას, დანიშნულებას და საქონლის სხვა მახასიათებლებს, არ ექვემდებარება დამოუკიდებელი სამართლებრივი დაცვის საგანს.

(511)

29 – ძეხვი.

35 – წარმოებული პროდუქციის გასაღება.

(260) AM 2015 76723 A

(210) AM 76723

(220) 2014 04 16

(731) კარნეგი მელონ იუნივერსითი

5000 ფორბს ავენიუ პიტსბურგი,

PA 15213-3890, აშშ

(740) თამარ კოჭლამაზაშვილი
(540)

CERT

(511)

16 – ბეჭდვითი გამოცემები, სახელდობრ, საინფორმაციო ფურცლები, ბიულეტენები, საინფორმაციო დაიჯესტი, ტექნიკური ინფორმაცია და სახელმძღვანელოები, ყველაფერი, რაც დაკავშირებულია კომპიუტერში შენახული ინფორმაციის დაცვასთან.

41 – მომსახურება, რომელიც დაკავშირებულია განათლებასთან, სახელდობრ, სემინარების, ტექნიკური შეხვედრების, კონფერენციების და სიმპოზიუმების ჩატარება, ყველაფერი, რაც დაკავშირებულია კომპიუტერში შენახული ინფორმაციის დაცვასთან.

42 – საკონსულტაციო მომსახურება, სახელდობრ, დახმარების, ტექნიკური რჩევების და მხარდაჭერის გაწევა, რომელიც დაკავშირებულია კომპიუტერში შენახული ინფორმაციის დაცვასთან; კომპიუტერული მომსახურება, სახელდობრ, ონ-ლაინ რეჟიმში ელექტრონული ფოსტის, საინფორმაციო ფურცლების, ბიულეტენების და საინფორმაციო დაიჯესტების გავრცელება, რომელიც დაკავშირებულია კომპიუტერში შენახული ინფორმაციის დაცვასთან.

(260) AM 2015 77309 A

(210) AM 77309

(220) 2014 05 28

(731) დი დი აი პი ჰოლდერ ელ ელ სი
130 როიალ სტრიტი, კანტონი,
მასაჩუსეტსი 02021, აშშ

(740) პაველე მეიფარიანი

(540)

DUNKIN' DONUTS

(526) ნიშანი დაცულია მთლიანობაში. მასში შემავალი სიტყვა "DONUTS" არ ექვემდებარება დამოუკიდებელ სამართლებრივ დაცვას.

(511)

29 – ხორცი, თევზი, ფრინველი და ნანადირევი; ხორცის ექსტრაქტები; დაკონსერვებული, გაყინული, გამხმარი და თბურად დამუშავებული ბოსტნეული და ხილი; ყელე, მურაბა, კომპოტი; კვერცხი; რძე და რძის პროდუქტები; საკვები ზეთები და ცხიმები; შემკვებები ხილის საფუძველზე ფუნჯულებისათვის, გალეტებისათვის, მშრალი ნამცხვარისათვის, ტკბილღვეულებსა და ღვეულებისათვის; საკვები ზეთები და ცხიმები; მოსართავები ხილის საფუძველზე; მოსართავები ნიგვის, თხილის საფუძველზე; შორტენინგი; თბურად დამუშავებული ბოსტნეული; წვნიანები; სალათები.

30 – ყავა, ჩაი, კაკაო და ყავის შემცველები; ბრინჯი, ტაპიოკა (მანიოკა), საგო; ფქვილი და მარცვლოვანი პროდუქტები; პურ-ფუნთუშეული, საკონდიტრო ნაწარმი; ნაყინი; შაქარი, თაფლი, ბადაგის ვაჟინი; საფუარი, საცხობი ფხვნილები; მარილი, მღოვკი; ძმარი, საკახემები; სანელებლები; საკვები ყონული; ფუნჯულები; პურ-ფუნთუშეული; გალეტები, მშრალი ნამცხვარი, ბისკვიტები; ტკბილღვეულები; ღვეულები; მაფინები; შემწვარი ღვეულები შიგთავსის გარეშე, მოსარკლული და შიგთავსით; ბლითები (ბუბლიკები); სენდვიჩები; პიცა; შაქარი; ფქვილი; არომატული ექსტრაქტები; საკონდიტრო ბურბუშელა ცხობისათვის; თაფლი; საფუარი; ფხვნილები ცხობისათვის; შემკვებები ტკბილღვეულებისათვის და ტორტებისათვის ნაღული კრემის საფუძველზე; შემკვებები ტკბილღვეულებისათვის და ტორტებისათვის შოკოლადის საფუძველზე; მოსართავები შოკოლადის საფუძველზე; ყავა და ყავის სასმელები; ჩაი და ჩაის სასმელები; კაკაო და კაკაოს სასმელები; თოშის სახის სასმელები ყავის არომატით.

32 – ლუდი; მინერალური და გაზიანი წყალი და სხვა უაღკოჰოლო სასმელები; ხილის სასმელები და ხილის წვენები; ვაჟინები და სხვა შედგენილობები სასმელების დასამზადებლად; უაღკოჰოლო სასმელები; ხილის სასმელები და ხილის წვენები; თოშის სახის სასმელები ხილის არომატით; სმუზი; უაღკოჰოლო სასმელები ყავის არომატით; ვაჟინები და სხვა პრეპარატები, კონცენტრატები და ფხვნილები უაღკოჰოლო და ხილის სასმელების დასამზადებლად.

43 – საკვები პროდუქტებითა და სასმელებით უზრუნველყოფა; დროებითი საცხოვრებელი უზრუნველყოფა; რესტორნებით მომსახურება, კაფეებით მომსახურება; სასაუზმეებით მომსახურება; სწრაფი კვების რესტორნებით მომსახურება.

(260) AM 2015 77357 A

(210) AM 77357

(220) 2014 05 31

(731) აღმოაჩინე საქართველო
მმ. ზუბალაშვილების ქ. 43, თბილისი,
საქართველო

(740) ნინო კეკელიძე

(540)



- (591) ლურჯი, ყვითელი
 (531) 01.05.01, 01.17.11, 02.09.15, 27.05.01, 29.01.12
 (526) ნიშანი დაცულია მთლიანობაში, მასში შემავალი სიტყვა "Georgia" არ ექვემდებარება დამოუკიდებელი სამართლებრივი დაცვის საგანს.
 (511)
 35 – რეკლამა; მართვა საქმიან სფეროში; ადმინისტრირება საქმიან სფეროში; საოფისე სა-მსახური.
 39 – ტრანსპორტირება; საქონლის შეფუთვა და შენახვა; მოგზაურობის ორგანიზება.
 41 – აღზრდა; სასწავლო პროცესის უზრუნველყოფა; გართობა; სპორტული და კულტურულ-საგანმანათლებლო ღონისძიებების ორგანიზება.

(260) AM 2015 77454 A
 (210) AM 77454
 (220) 2014 06 06

- (731) ნგკ სპარკ პლაზ კო., ლტდ.
 იაპონიის კორპორაცია
 14-18 ტაკაცუჯი-ჩო, მიზუჰო კუ, ნაგოია სიტი, 467-8525, იაპონია
 (740) თამაზ შილაკაძე
 (540)



- (591) მწვანე, თეთრი
 (531) 26.01.20, 26.01.24, 27.05.24, 29.01.12, 26.01.12, 27.05.23
 (511)
 9 – ჰაერში ან აირში (გაზში) არსებული საწვავის ორთქლის, ჟანგბადის, აზოტის, ოქსიდის, ნახშირწყალბადის, მეთანის, სპირტის და წყალბადის კონცენტრაციის გამზომი ხელსაწყოები; საწვავში ორთქლის, ჟანგბადის, აზოტის, ოქსიდის, ნახშირწყალბადის, მეთანის, სპირტის და წყალბადის კონცენტრაციის გამზომი ხელსაწყოები, და შიგა წვის ძრავებიდან, საქვაბეებიდან, ნაგავსაწვავებიდან, გაზის ტურბინებიდან, გენერატორებიდან და საწვავის საკნებიდან გამონაბოლქვ აირში ჰაერის/საწვავის კოეფიციენტის საკონტროლო (შემოწმების) ხელსაწყოები; დეტონაციური სენსორები; წნევის სენსორები; ტემპერატურის სენსორები; გარე ჰაერის სენსორები ჰაერის ხარისხის გასაზომად; დატვირთვის სენ-

სორები; წყალბადის გაჟონვის აღმოჩენის სენსორები; შარდოვანას სენსორები; ბატარეები და აქსესუარები, როგორცაა ბატარეის ყუთები, ბატარეის დამტენები და გადამყვანები; სამეცნიერო, საზღვაო, გეოდეზიური, ფოტოგრაფიული, კინემატოგრაფიული, ოპტიკური, ამწონი, გამზომი, სასიგნალო, საკონტროლო (შემოწმების), სამაშველო და სასწავლო ხელსაწყოები და ინსტრუმენტები; ელექტრობის გადაცემის, განაწილების, გარდაქმნის, დაგროვების, რეგულირების ან მართვის ხელსაწყოები და ინსტრუმენტები; ხმის ან გამოსახულების ჩამწერი, გადამცემი და აღმწარმოებელი აპარატურა; ინფორმაციის მაგნიტური მატარებლები, ხმის ჩამწერი დისკები; კომპაქტდისკების, DVD-ები და სხვა ციფრული ჩამწერი საშუალებები; მექანიზმები აპარატურისათვის წინასწარი გადახდით; საღაროს აპარატები, საანგარიშო მანქანები, ინფორმაციის დასამუშავებელი აღჭურვილობა, კომპიუტერები; კომპიუტერის პროგრამული უზრუნველყოფა; ცეცხლქრობები.

- (260) AM 2015 77573 A
 (210) AM 77573
 (220) 2014 06 17
 (731) მეი ალქოლლუ იჯქიდერ სანაიი ვე თიჯარეთ ანონიმ შირეთი აბიდე-ი ჰურრიეტ კად. N:211 ბოლკან სენტა B ბლოკი შიშლი, თურქეთი
 (740) ლილიანა დარახველიძე
 (540)



- (554) [X]
 (591) თეთრი, შავი, წითელი
 (531) 19.07.01, 19.07.16
 (511)
 33 – ალკოჰოლიანი სასმელები (ლუდის გარდა).

- (260) AM 2015 77693 A
 (210) AM 77693
 (220) 2014 06 25
 (731) ალექსანდრე გონგაძე
 იონან პეტრიწის ქ. 2, ბ. 74, თბილისი, საქართველო

(540)



(591) შავი, ლურჯი, ყვითელი, თეთრი
 (531) 01.05.02, 02.09.14, 26.01.21, 27.01.12, 28.03, 29.01.14
 (526) ნიშანი დაცულია მთლიანობაში, მასში შემავალი სიტყვები "International" და "Federation" არ ექვემდებარება დამოუკიდებელი სამართლებრივი დაცვის საგანს.
 (511)
 25 – ტანსაცმელი, ფეხსაცმელი, თავსაბურავი.
 35 – რეკლამა; მართვა საქმიან სფეროში; ადმინისტრირება საქმიან სფეროში; საოფისე სამსახური.
 41 – აღზრდა; სასწავლო პროცესის უზრუნველყოფა; გართობა; სპორტული და კულტურულ-საგანმანათლებლო ღონისძიებების ორგანიზება.

(260) AM 2015 77697 A
 (210) AM 77697
 (220) 2014 06 25
 (731) შპს „სტარი“
 აღმაშენებლის გამზ. №108, 0164,
 თბილისი, საქართველო
 (740) ზურაბ მესხი
 (540)



(591) ვერცხლისფერი
 (531) 14.03.03, 26.01.12, 27.05.17
 (511)
 9 – ტელევიზორები.

(260) AM 2015 77944 A
 (210) AM 77944
 (220) 2014 07 14
 (731) ევროდრაგ ლაბორატორის ბ.ვ.
 ლაან კოპეს ვან კატენბურხი 74, 2585
 GD ჰააგა, ნიდერლანდი
 (740) თამაზ შილაკაძე
 (540)

DIAPOCARE

(511)
 5 – კრემები საფეხებით გამოწვეული გაღიზიანებული კანისა და დერმატიტებისთვის.

(260) AM 2015 78156 A
 (210) AM 78156
 (220) 2014 07 30
 (731) ვაუბელი ბოჭორი შვილი
 სოფ. ტყაჩირი, 5416 წყალტუბოს რაიონი,
 საქართველო
 (540)

გუმი-30 უნივერსალი პასტა
GUMI-30 universal paste
ГУМИ-30 универсал паста

(511)
 1 – სამრეწველო და სამეცნიერო დანიშნულების, ფოტოგრაფიაში, მეტყვევობასა და მებაღეობაში გამოსაყენებელი ქიმიური ნაწარმი; დაუშუშავებელი სინთეზური ფისები, დაუშუშავებელი პლასტმასები; სასუქები; ცეცხლმქრობი შედგენილობები; ქიმიური ნივთიერებები წრთობისა და რჩილვისათვის; საკვები პროდუქტების დასაკონსერვებელი ქიმიური ნივთიერებები; სამრეწველო დანიშნულების მწებავი ნივთიერებები.
 35 – რეკლამა; მართვა საქმიან სფეროში; ადმინისტრირება საქმიან სფეროში; საოფისე სამსახური.

(260) AM 2015 78157 A
 (210) AM 78157
 (220) 2014 07 30
 (731) სოსიეტე დე პროდუი ნესტლე ს.ა.
 CH-1800 ვევე, შვეიცარია
 (740) თამაზ შილაკაძე
 (540)

СВІТОЧ

(511)
 30 – შოკოლადის ნაწარმი: შოკოლადის ფილა, შოკოლადის ბატონი, ასაწონი კანფეტი, კანფეტი ყუთებში, კანფეტი პაკეტებში, დრაჟე.

(260) AM 2015 78262 A
 (210) AM 78262
 (220) 2014 08 11
 (731) ჯკ თაირ & ინდასტრის ლიმიტედ
 ჯეიკეიგრამ, პო-ტაიერ ფექტორი,
 კანკროლი - 313 342, რაჯასტან,
 ინდოეთი
 (740) თამარ კოჭლამაზაშვილი
 (540)



(591) შავ-თეთრი
 (531) 26.01.18, 27.05.17

(511)
12 – საბურავები, კამერები, ფერსო და მუხლუხო.

(260) AM 2015 78263 A

(210) AM 78263

(220) 2014 08 11

(731) ჯკ თაირ & ინდასტრის ლიმიტედ
ჯეიკეიგრამ, პო-ტაიერ ფექტორი,
კანკროლი - 313 342, რაჯასტან,
ინდოეთი

(740) თამარ კოჭლამაზაშვილი

(540)



(591) შავ-თეთრი

(531) 26.03.23, 26.13.25, 27.05.01, 27.05.17

(511)

12 – საბურავები, კამერები, ფერსო და მუხლუხო.

(260) AM 2015 78268 A

(210) AM 78268

(220) 2014 08 12

(731) დავეუნგ ფარმასიუტიკალ კო., ლტდ.
244, გალმაჩი-რო, ჯუნგონ-გუ,
სეონგნამ-სი, გიეონგი-დო, კორეის
რესპუბლიკა

(740) თამაზ შილაკაძე

(540)

ABDONORM-1

(511)

5 – ფარმაცევტული პრეპარატები; ვეტერინარული პრეპარატები; მადეზინფიცირებელი საშუალებები; სამედიცინო დანიშნულების სამედიცინო პრეპარატები; სამედიცინო ან ვეტერინარული დანიშნულების დიეტური საკვები და ნივთიერებები; სიცხის დამწვევი საშუალებები; ტკივილგამაყუჩებელი საშუალებები (ანალგეტიკები); ანთების საწინააღმდეგო საშუალებები; ფარმაცევტული პრეპარატები საჭმლის მომწელებელი ორგანოებისთვის; საჭმლის მონელების ხელშემწყობი საშუალებები ფარმაცევტული მიზნებისათვის; ჭიის წამლები; ანტიბიოტიკები; ანტიციდები; მუავას რეფლუქციის სამკურნალო ფარმაცევტული პრეპარატები; წყლულის საწინააღმდეგო საშუალებები; მატონიზირებელი საშუალებები (სამკურნალო პრეპარატები); ნაღვლმდენი საშუალებები; ღვიძლის დაავადებების სამკურნალო ფარმაცევტული პრეპარატები; ნაღველკენჭოვანი დაავადებების სამკურნალო ფარმაცევტული პრეპარატები; ღვიძლის მოქმედების ხელშემწყობი ფარმაცევტული პრეპარატები; საკვები დანამატები; ვიტამინის პრეპარატები; მინერალური დანამატები.

ტები; საკვები დანამატები; ვიტამინის პრეპარატები; მინერალური დანამატები.

(260) AM 2015 78790 A

(210) AM 78790

(220) 2014 09 24

(731) სეის ფარმა ინტერნაციონალ აგ
ვალდმანშტრასე 8, 8001 ციურიხი,
შვეიცარია

(740) შალვა გვარამაძე

(540)

ТЕЛМИПОЛ НСТ

(511)

5 – ფარმაცევტული და ვეტერინარული პრეპარატები; სამედიცინო დანიშნულების ჰიგიენური პრეპარატები; სამედიცინო ან ვეტერინარული დანიშნულების დიეტური ნივთიერებები და საკვები; დიეტური დანამატები ადამიანებისათვის; მანე ცხოველების გასანადგურებელი პრეპარატები; ფუნგიციდები.

(260) AM 2015 78802 A

(210) AM 78802

(220) 2014 09 25

(731) საუთერნ კომფორტ პროპერტის, ინკ.
4040 სივიკ სენტერ დრაივი, სუიტ 528,
სან-რაფაელი, კალიფორნია 94903, აშშ

(740) შალვა გვარამაძე

(540)



(591) შავ-თეთრი

(531) 25.03.05, 01.01.13, 27.05.03

(526) ნიშანი დაცულია მთლიანობაში. მასში შემავალი სიტყვა "CATEGORY OF ONE" არ ექვემდებარება დამოუკიდებელ სამართლებრივ დაცვას.

(511)

33 – ალკოჰოლიანი სასმელები, დისტილირებული სპირტის ჩათვლით.

(260) AM 2015 78803 A

(210) AM 78803

(220) 2014 09 25

(731) ზე ჯილეტ კომპანი
უან ჯილეტ პარკი, ბოსტონი,
მასაჩუსეტსი 02127, აშშ

(740) შალვა გვარამაძე

(540)

COMPLETE DEFENSE

(511)

3 – გასაპარსი პრეპარატები, საპარსი კრემების, საპარსი გელები, საპარსი ღოსიონების და საპარსი ქაფების ჩათვლით.

თაფლი, ბადაგის ვაჟინი; საფუარი, საცხობი ფხვნილები; მარილი, მღოგვი; ძმარი, საკაზმები; სანელებლები; საკვები ყინული.

(260) AM 2015 78851 A

(210) AM 78851

(220) 2014 09 29

(731) კენტუკი ფრაიდ ჩიკენ ინტერნეშენელ
ჰოლდინგ ზ, ინკ.

1441 გარდინერ ლეინი, ლუისვილი,

კენტუკი 40213, აშშ

(740) თამარ კოჭლამაზაშვილი

(540)

SANDERS

(511)

29 – ხორცი, თევზი, ფრინველი და ნანადირევი; ხორცის ექსტრაქტები; დაკონსერვებული, გაყინული, გამხმარი და თბურად დამუშავებული ბოსტნეული და ხილი; ჟელე, მურაბა, კომპოტი; კვერცხი, რძე და რძის პროდუქტები; ზეთები და საკვები ცხიმები.

30 – ყავა, ჩაი, კაკაო და ყავის შემცველები, ბრინჯი, ტაპიოკა (მანიოკა) და საგო; ფქვილი და მარცვლოვანი პროდუქტი, პურ-ფუნთუშეული, საკონდიტრო ნაწარმი, ნაყინი; შაქარი, თაფლი, ბადაგის ვაჟინი; საფუარი, საცხობი ფხვნილები; მარილი, მღოგვი; ძმარი, საკაზმები; სანელებლები; საკვები ყინული.

(260) AM 2015 78852 A

(210) AM 78852

(220) 2014 09 29

(731) კენტუკი ფრაიდ ჩიკენ ინტერნეშენელ
ჰოლდინგ ზ, ინკ.

1441 გარდინერ ლეინი, ლუისვილი,

კენტუკი 40213, აშშ

(740) თამარ კოჭლამაზაშვილი

(540)

სანდერსი

(511)

29 – ხორცი, თევზი, ფრინველი და ნანადირევი; ხორცის ექსტრაქტები; დაკონსერვებული, გაყინული, გამხმარი და თბურად დამუშავებული ბოსტნეული და ხილი; ჟელე, მურაბა, კომპოტი; კვერცხი, რძე და რძის პროდუქტები; ზეთები და საკვები ცხიმები.

30 – ყავა, ჩაი, კაკაო და ყავის შემცველები, ბრინჯი, ტაპიოკა (მანიოკა) და საგო; ფქვილი და მარცვლოვანი პროდუქტი, პურ-ფუნთუშეული, საკონდიტრო ნაწარმი, ნაყინი; შაქარი,

რეგისტრირებული სასაქონლო ნიშნები

(111) M 2015 025760 R

(151) 2015 04 01

(181) 2025 04 01

(260) AM 2015 73136 A

(220) 2013 07 22

(732) შეფა ფრანჩაიზიზ ლტდ
7 პასოლედა სტ., ბეიტ-შემეში, 99052,
ისრაელი

(111) M 2015 025761 R

(151) 2015 04 01

(181) 2025 04 01

(260) AM 2015 73137 A

(220) 2013 07 22

(732) შეფა ფრანჩაიზიზ ლტდ
7 პასოლედა სტ., ბეიტ-შემეში, 99052,
ისრაელი

(111) M 2015 025762 R

(151) 2015 04 01

(181) 2025 04 01

(260) AM 2014 73340 A

(220) 2013 08 01

(732) ვალტრა ოი აბ
ვალმეტინკატუ 2, FI-44200 სუოლაჰტი,
ფინეთი

(111) M 2015 025763 R

(151) 2015 04 01

(181) 2025 04 01

(260) AM 2014 73877 A

(220) 2013 09 09

(732) შპს „ახალი ნათება“
აღ. ყაზბეგის გამზ. 25ა, 0160, თბილისი,
საქართველო

(111) M 2015 025764 R

(151) 2015 04 01

(181) 2025 04 01

(260) AM 2014 74169 A

(220) 2013 10 02

(732) შპს „ბარამბო“
სოფ. ნატახტარი, 3308, მცხეთა,
საქართველო

(111) M 2015 025765 R

(151) 2015 04 01

(181) 2025 04 01

(260) AM 2014 74249 A

(220) 2013 10 08

(732) ზე ჯილქეტი კომპანი
უან ჯილქეტი პარკი, ბოსტონი,
მასაჩუსეტსი 02127, აშშ

(111) M 2015 025766 R

(151) 2015 04 01

(181) 2025 04 01

(260) AM 2014 74303 A

(220) 2013 10 10

(732) შპს "EMEDICA"
გრიბოედოვის ქ. №3, 0108, თბილისი,
საქართველო

(111) M 2015 025767 R

(151) 2015 04 01

(181) 2025 04 01

(260) AM 2014 74430 A

(220) 2013 10 22

(732) ჯვ როიალ არმენია ლტდ
38 აპკ/26, დავიდაშენ 2, ერევანი,
სომხეთი

(111) M 2015 025768 R

(151) 2015 04 01

(181) 2025 04 01

(260) AM 2014 74634 A

(220) 2013 11 05

(732) დომდექს ლიმიტიდ
ინტერნეშენელ ჰაუს, კასტლ ჰილ,
ვიქტორია როად, აისლ ოფ მენ,
დოუგლას IM2 4RB, გაერთიანებული
სამეფო

(111) M 2015 025769 R

(151) 2015 04 01

(181) 2025 04 01

(260) AM 2014 74905 A

(220) 2013 11 26

(732) ლოვეე სა
კალიე გოია 4, მადრიდი 28001, ესპანეთი

(111) M 2015 025770 R

(151) 2015 04 01

(181) 2025 04 01

(260) AM 2014 74994 A

(220) 2013 12 02

(732) სვის ფარმა ინტერნაციონალ აგ
ვალდმანშტრასე 8, 8001 ციურისი,
შვეიცარია

(111) M 2015 025771 R
(151) 2015 04 01
(181) 2025 04 01
(260) AM 2014 74995 A
(220) 2013 12 02
(732) სვის ფარმა ინტერნაციონალ აგ
ვალდმანშტრასე 8, 8001 ციურისი,
შვეიცარია

(111) M 2015 025772 R
(151) 2015 04 01
(181) 2025 04 01
(260) AM 2014 75002 A
(220) 2013 12 03
(732) შპს „ქართული ბროილერი“
აკ. შანიძის ქ.21, 0179, თბილისი,
საქართველო

(111) M 2015 025773 R
(151) 2015 04 01
(181) 2025 04 01
(260) AM 2014 75219 A
(220) 2013 09 09
(732) შპს „ახალი ნათება“
აღ. ყაზბეგის გამზ. 25ა, 0160, თბილისი,
საქართველო

(111) M 2015 025776 R
(151) 2015 04 02
(181) 2025 04 02
(260) AM 2014 74495 A
(220) 2013 10 28
(732) კაპსი კოათინგს
პორტ-საიდ ინდასტრიალ ზოუნ, აღ-
რასვა, პ.ო. ბოქს 118, პორტ საიდ,
ევვიპტე

დაჩქარებული პროცედურით რეგისტრირებული სასაქონლო ნიშნები

რეგისტრაციის გაუქმების მოთხოვნით საჩივრის შეტანა შესაძლებელია საქპატენტის სააპელაციო პალატაში გამოქვეყნებიდან 3 თვის ვადაში.

- (111) M 2015 25747 R
- (151) 2015 03 18
- (181) 2025 03 18
- (210) AM 81060
- (220) 2015 03 04
- (732) შპს „უნიმედ გრუპ კორპ“
აღ. მიცკევიჩის ქ. 29, ბ. 61, 0177,
თბილისი, საქართველო
- (740) გიორგი მონიავა
- (540)

ბარალგინი
Baralgin
Баралгин

- (591) შავ-თეთრი
- (531) 27.05.05-28.05.00-28.19.00-
- (511)

5 – ფარმაცევტული და ვეტერინარული პრეპარატები; სანიტარული პრეპარატები სამედიცინო მიზნებისათვის; დიეტური ნივთიერებები სამედიცინო მიზნებისათვის, ბავშვთა კვება; საღებუნები, გადასახვევი საშუალებები; კბილის დასაბუნნი საშუალებები, კბილის ტვიფრის დასამზადებელი საშუალებები; დეზინფექტანტები; მანე ცხოველების გასანადგურებელი საშუალებები; ფუნგიციდები, ჰერბიციდები.

- (111) M 2015 25748 R
- (151) 2015 03 24
- (181) 2025 03 24
- (210) AM 81150
- (220) 2015 03 09
- (732) ზაო „მბზკ „ციტომედი“
სანქტ-პეტერბურგი 191023, მუხნო
შეს. 2, რუსეთის ფედერაცია
- (740) ვახტანგ ტოროტაძე
- (540)

ПРОСТАКАМПИН
PROSTACAMPIN

- (591) შავ-თეთრი

- (511)
- 5 – ფარმაცევტული და ვეტერინარული პრეპარატები; სანიტარული პრეპარატები სამედიცინო მიზნებისათვის; დიეტური ნივთიერებები სამედიცინო მიზნებისათვის, ბავშვთა კვება; საღებუნები, გადასახვევი საშუალებები; კბილის დასაბუნნი საშუალებები, კბილის ტვიფრის დასამზადებელი საშუალებები; დეზინფექტანტები; მანე ცხოველების გასანადგურებელი საშუალებები; ფუნგიციდები, ჰერბიციდები, მათ შორის ფარმაცევტული პრეპარატები (050069), მედიკამენტები (050125), მალამოები (050196), სამედიცინო სანთლები (050280).

- (111) M 2015 25749 R
- (151) 2015 03 25
- (181) 2025 03 25
- (210) AM 80944
- (220) 2015 02 24
- (732) შპს „ფირმა „დისნა“
ულ. ლავრსკაია, 16, 01015, ქ. კიევი, უკრაინა
- (740) დავით ზურაბიშვილი
- (540)



- (591) შავ-თეთრი
- (531) 05.03.04-05.13.08-27.05.21-
- (511)
- 33 – ალკოჰოლიანი სასმელები (ლუდის გარდა).

- (111) M 2015 25750 R
- (151) 2015 03 25
- (181) 2025 03 25
- (210) AM 80945
- (220) 2015 02 24
- (732) შპს „ფირმა „დისნა“
ულ. ლავრსკაია, 16, 01015, ქ. კიევი, უკრაინა
- (740) დავით ზურაბიშვილი

(540)



(591) შავ-თეთრი
 (531) 05.03.04-05.13.08-
 (511)
 33 – ალკოჰოლიანი სასმელები (ღუდის გარდა).

(111) M 2015 25751 R

(151) 2015 03 25

(181) 2025 03 25

(210) AM 80946

(220) 2015 02 24

(732) შპს „ფირმა „დისნა“

ულ. ლავრსკაია, 16, 01015, ქ. კიევი, უკრაინა

(740) დავით ზურაბიშვილი

(540)



(591) თეთრი, ყავისფერი, ბორდოსფერი, თამბაქოსფერი

(531) 07.01.03-25.01.19-27.05.11-29.01.14-

(526) ნიშანი დაცულია მთლიანობაში. მასში შემავალი სიტყვა "KARTUWINE" არ ექვემდებარება დამოუკიდებელ სამართლებრივ დაცვას.

(511)

33 – ღვინო (ქართული წარმოშობის).

(111) M 2015 25752 R

(151) 2015 03 26

(181) 2025 03 26

(210) AM 80833

(220) 2015 02 17

(732) სპირიტს ინტერნაციონალ ბ.გ. 3, რიუ დუ ფორტ რეინჰეიმი, L-2419, ლუქსემბურგი, ლუქსემბურგი

(740) დავით ზურაბიშვილი

(540)



(554) [X]

(591) თეთრი, შავი, წითელი, ოქროსფერი, ყვითელი

(531) 07.01.08-19.07.01-24.05.07-25.01.19-27.05.01-29.01.14-

(526) ნიშანი დაცულია მთლიანობაში. მასში შემავალი სიტყვები "STOLICHNAYA" და "Stoli" არ ექვემდებარება დამოუკიდებელ სამართლებრივ დაცვას.

(511)

33 – არაყი (რუსული წარმოშობის).

(111) M 2015 25753 R

(151) 2015 03 26

(181) 2025 03 26

(210) AM 80835

(220) 2015 02 17

(732) სპირიტს ინტერნაციონალ ბ.გ. 3, რიუ დუ ფორტ რეინჰეიმი, L-2419, ლუქსემბურგი, ლუქსემბურგი

(740) დავით ზურაბიშვილი

(540)



(554) [X]
(591) თეთრი, შავი, მწვანე, ოქროსფერი, ყვითელი
(531) 02.01.20-19.07.01-24.05.07-25.01.19-25.05.05-29.01.14-
(526) ნიშანი დაცულია მთლიანობაში. მასში შემავალი სიტყვა "MOSKOVSKAYA" არ ექვემდებარება დამოუკიდებელ სამართლებრივ დაცვას.
(511)
33 – არაყი (რუსული წარმოშობის).

(111) M 2015 25754 R
(151) 2015 03 26
(181) 2025 03 26
(210) AM 80749
(220) 2015 02 13
(732) შპს „ვესტ ინვესტ“
თეველორე მღვდლის ქ. 27, 0154, თბილისი, საქართველო
(740) ლევან მესხელი
(540)



(591) წითელი, ლურჯი
(531) 03.07.03-05.05.01-26.01.15-26.01.21-27.05.05-29.01.13-
(526) ნიშანი დაცულია მთლიანობაში. მასში შემავალი სიტყვები "UKRAINIAN" და "CHICKEN" არ ექვემდებარება დამოუკიდებელ სამართლებრივ დაცვას.
(511)
29 – ქათამი (ნაწარმოები უკრაინაში).

35 – რეკლამა; მართვა საქმიან სფეროში; ადმინისტრირება საქმიან სფეროში; საოფისე საშუალებები.

(111) M 2015 25755 R
(151) 2015 03 27
(181) 2025 03 27
(210) AM 80930
(220) 2015 02 24
(732) შპს „უნიმედ გრუპ კორპ“
ვაკე-საბურთალოს რაიონი, ად. მიცავეიჩის ქ. 29, ბ. 61, თბილისი, საქართველო
(740) გიორგი მონიავა

(540)

თიმალინი ТИМАЛИН Thymalin

(591) შავ-თეთრი
(531) 27.05.05-28.05.00-28.19.00-
(511)
5 – ფარმაცევტული და ვეტერინარული პრეპარატები; სანიტარული პრეპარატები სამედიცინო მიზნებისათვის; დიეტური ნივთიერებები სამედიცინო მიზნებისათვის, ბავშვთა კვება; საღებუნები, გადასახვევი საშუალებები; კბილის დასაბუნებელი საშუალებები, კბილის ტვიფრის დასამზადებელი საშუალებები; დეზინფექტანტები; მანე ცხოველების გასანადგურებელი საშუალებები; ფუნგიციდები, ჰერბიციდები.

(111) M 2015 25756 R
(151) 2015 03 31
(181) 2025 03 31
(210) AM 81364
(220) 2015 03 24
(732) შპს „მალტისოფტი“
ონიაშვილის ქ. 67, 0186, თბილისი, საქართველო
(540)

მარტვ MARTV

(591) შავ-თეთრი
(511)
38 – კავშირგაბმულობა.

(111) M 2015 25757 R
(151) 2015 03 31
(181) 2025 03 31
(210) AM 81365
(220) 2015 03 24
(732) შპს „მალტისოფტი“
ონიაშვილის ქ. 67, 0186, თბილისი, საქართველო
(540)



(591) ნაცრისფერი, თეთრი, წითელი
(531) 25.05.03-26.04.22-26.04.24-27.05.24-29.01.13-
(511)
38 – კავშირგაბმულობა.

(111) M 2015 25758 R
(151) 2015 03 31
(181) 2025 03 31
(210) AM 79948
(220) 2014 12 16
(732) შპს „ზღაპარი“
ჭიჭინაძის ქ. 17 , 0186, თბილისი,
საქართველო
(740) თამარ უდესიანი
(540)



(591) წითელი, ყვითელი
(531) 02.05.03-04.01.02-27.05.22-28.19.00-
29.01.12-
(511)
35 – რეკლამა; მართვა საქმიან სფეროში; ად-
მინისტრირება საქმიან სფეროში; საოფისე სა-
მსახური

(111) M 2015 25759 R
(151) 2015 03 31
(181) 2025 03 31
(210) AM 81256
(220) 2015 03 17
(732) შპს „ახალი ტექნოლოგიებისა და
ინოვაციების ჯგუფი“
კოსტავას ქ. 37/39, მე-6 სართული,
ოფისი № 505, 0179, თბილისი,
საქართველო
(740) შალვა გვარამაძე
(540)



BEST OFFER

(591) მწვანე, თეთრი
(531) 01.15.21-26.01.18-27.05.05-
(526)
ნიშანი დაცულია მთლიანობაში. მასში შე-
მაჯავლი სიტყვა "BEST OFFER" არ ექვემდებარ-
ება დამოუკიდებელ სამართლებრივ დაცვას.
(511)
35 – აუქციონით გაყიდვა ონ-ლაინ რეჟიმში;
კომერციული ადმინისტრირება მესამე პირთა-
თვის; რეკლამა; საქონლის გასაღებაში ხელ-
შეწყობა მესამე პირთათვის; საქონლის დემო-
ნსტრირება; საქონლის პრეზენტაცია მასობ-
რივი ინფორმაციის საშუალებებით საცალო
ვაჭრობისათვის; კომერციული ინფორმაცია
და რჩევები მომხმარებლებისათვის; კომერცი-

ული ინფორმაციის სააგენტოები; საშუამავ-
ლო საქმიანობა; ყველა ზემოთ ჩამოთვლილი
მომსახურება ხორციელდება ონ-ლაინ რეჟიმ-
ში.

(111) M 2014 25774 R
(151) 2015 04 01
(181) 2025 04 01
(210) AM 80605
(220) 2015 02 04
(732) შპს „ვესტ ინვესტ“
თევდორე მღვდლის ქ. 27, 0154,
თბილისი, საქართველო
(740) ლევან მესხელი
(540)



(591) მწვანე, თეთრი, იასამნისფერი, ყვითელი,
ნარინჯისფერი, წითელი
(531) 01.15.15-25.01.01-25.05.02-26.04.18-
26.04.22-27.05.21-27.05.24-29.01.15-
(511)
29 – ხორცი, თევზი, ფრინველი და ნანადირე-
ვი; ხორცის ექსტრაქტები; დაკონსერვებული,
გამხმარი და თბურად დამუშავებული ბოსტ-
ნეული და ხილი; ყვლე, მურაბა, კომპოტი;
კვერცხი, რძე და რძის ნაწარმი; ზეთები და
საკვები ცხიმები.
35 – რეკლამა; მართვა საქმიან სფეროში; ად-
მინისტრირება საქმიან სფეროში; საოფისე სა-
მსახური.

(111) M 2015 25775 R
(151) 2015 04 01
(181) 2025 04 01
(210) AM 81278
(220) 2015 03 17
(732) შპს „უნიმედ გრუპ კორპ“
ად. მიცკევიჩის ქ. №29, ბ. 61, 0177,
თბილისი, საქართველო
(740) გიორგი მონიავა
(540)

ფესტალი
Festal
фестал

(591) შავ-თეთრი

(531) 27.05.05-28.05.00-28.19.00-

(511)

5 – ფარმაცევტული და ვეტერინარული პრეპარატები; სანიტარული პრეპარატები სამედიცინო მიზნებისათვის; დიეტური ნივთიერებები სამედიცინო მიზნებისათვის, ბავშვთა კვება; საღებუნები, გადასახვევი საშუალებები; კბილის დასაბუნებელი საშუალებები, კბილის ტვიფრის დასამზადებელი საშუალებები; დეზინფექტანტები; მავნე ცხოველების გასანადგურებელი საშუალებები; ფუნგიციდები, ჰერბიციდები.

(111) M 2015 25777 R

(151) 2015 04 01

(181) 2025 04 01

(210) AM 81151

(220) 2015 03 10

(732) შპს „იდეგო გრუპი IDEGO GROUP“

ბოგდან ხმელნიცკის ქ. 44ა, კორპ. 4, ბ. 8,
0121 თბილისი, საქართველო

(540)



(591) წითელი, თეთრი, ვერცხლისფერი

(531) 01.05.02-05.07.10-24.01.10-27.95.11-
29.01.13-

(526) ნიშანი დაცულია მთლიანობაში. მასში შემავალი სიტყვა "VIN" არ ექვემდებარება დამოუკიდებელ სამართლებრივ დაცვას.

(511)

33 – ღვინო

**საერთაშორისო სასაქონლო ნიშნები, რომლებზეც
გამოტანილია გადაწყვეტილება დაცვის მინიჭების შესახებ**

გადაწყვეტილების გასაჩივრება შესაძლებელია საქპატენტის სააპელაციო პალატაში გამოქვეყნებიდან 3 თვის ვადაში ან მცხეთის რაიონული სასამართლოს ადმინისტრაციულ საქმეთა კოლეგიაში 1 თვის ვადაში (მის.: ქალაქი მცხეთა, სამხედროს ქ. №17).

(260) AM 2015 71877 A*

(800) 1153445

(731) HILTON HHONORS WORLDWIDE LLC
7930 Jones Branch Drive Suite 1100, Mclean
VA 22102, USA

(540)



(591) Black, white

(511)

43 – Hotel services; restaurant, catering, bar and cocktail lounge services; resort lodging services; provision of general purpose facilities for meetings, conferences and exhibitions; provision of banqueting and social function facilities for special occasions; and reservation service for hotel accommodations for others.

(260) AM 2015 72708 A*

(800) 1161274

(731) BLANCO ÖZTİRYAKİLER MUTFAK
DONANIMI SANAYİ VE TİCARET
ANONİM ŞİRKETİ
Cumhuriyet Mahallesi, Eski Hadimköy Yolu
No:31/B Büyükçekmece İSTANBUL, Turkey

(540)

PERA

(591) Black, white

(511)

7 – Eclectic kitchen machines for chopping, grinding, crushing, mixing and mincing foodstuff, washing machines, laundry washing machines, dishwashers, spin driers (not heated), electric cleaning machines for cleaning floors, carpets or floorings, vacuum cleaners and parts thereof.

11 – Apparatus for lighting, heating, steam generating, cooking, refrigerating, drying, ventilating, water supply and sanitary purposes.

35 – Advertising; business management; business administration; office functions.

(260) AM 2015 72726 A*

(800) 1007759

(731) ATMACA ELEKTRONİK SANAYİ VE
TİCARET ANONİM SİRKETİ
Namuk Kemal Mahallesi, 177, Sokak, No:2,
Esenyurt-Istanbul, Turkey
SUNNY ELEKTRONİK SANAYİ VE
TİCARET ANONİM SİRKETİ
Namik Kemal Mahallesi Adile Nasit Bulvarı
No:18 Esenyurt BÜYÜKÇEKMECE –
İSTANBUL, Turkey

(540)

SUNNY

(591) Black, white

(511)

7 – Machines and machine tools; motors and engines (except for land vehicles); machine coupling and transmission components (except for land vehicles); agricultural implements other than hand-operated; incubators for eggs.

9 – Apparatus for recording, transmission or reproduction of sound and images, radios, television receivers, video tape and video disk players, cameras, audio devices and parts, namely, audio cassette players, audio cassette recorders, cinematographic machines and apparatus, remote control devices for radios, televisions, headphones, audio speakers, megaphones, intercoms, slide or photograph projection apparatus; data processors, namely, computers, computer software, computer hardware, printers, laser printers, scanners, automatic cash registers, calculators, barcode scanners and their accessories; car navigation computers; all kinds of photographic cameras, parts of photographic cameras and accessories namely, photographic flashbulbs, photographic viewfinders; communication devices, namely, telephones, fax machines, telegraph machines, radio telephones, automatic telephone exchanges; antennas, satellite dishes, satellite receivers, amplifiers and their parts.

(260) AM 2015 73196 A*

(800) 1165948

(731) CITIZEN TOKEI KABUSHIKI KAISHA
(CITIZEN WATCH CO., LTD.)
1-12, 6-chome, Tanashi-Cho, Nishi-Tokyo-Shi,
Tokyo, Japan

(540)

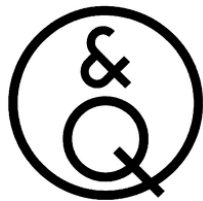

(591) Black, white

(511)

14 – Clocks and watches; movements for clock and watch making; cases for clock and watch making; watch glasses; watch bands and straps; dials for clock and watch making.

(260) AM 2015 74551 A*

(800) 1178830

(731) KIKO S.P.A.

Via Giorgio e Guido Paglia, 1/D, I-24122
BERGAMO (BG), Italy

(540)

KIKO

(591) Black, white

(511)

35 – Retail services, rendered also on-line, featuring bath salts, scissors, nail files, tweezers, manicure and pedicure sets, manicure implements, pedicure implements, nail nippers, nail polishers, nail clippers, electric or non-electric, razors, shaving brushes, nail brushes, toilet sponges, toilet brushes, combs, storage canisters, foam toe separators for use in pedicures, spectacles, sunglasses, frames for spectacles, cases and chains for spectacles, eyeglass lenses, jewellery, costume jewellery and watches, excluding services related to goods for infants and children up to 11 years old.

(260) AM 2015 75828 A

(800) 1190565

(891) 2013 07 31

(731) PAULINE

10 Impasse du Grand Jardin – ZAC de la
Moinerie, F-35400 SAINT MALO, FR

(540)



(591) Black, white

(511)

25 – Clothing; clothing for men; clothing for women; clothing for children; clothing of leather or imitation leather; clothing for sports; boots for sports; cycling shorts (leggings); sports singlets; ski clothing; ski boots; après-ski apparel; ski boots; bat-

hing apparel; bathing caps; bathing trunks; bathing suits; bath robes; bath sandals; bath slippers; hosiery; suits; combinations (clothing); dresses; skirts; petticoats; trousers; Bermuda shorts; shorts; chasubles; shirts; short-sleeve shirts; overalls; singlets; tee-shirts; tank tops; vests; sweaters; pullovers; hosiery; jackets [clothing]; gabardines; raincoats; coats, overcoats; parkas; stuff jackets [clothing]; down jackets; pajamas; nightshirts; dressing gowns (robes); dressing gowns; braces for clothing [suspenders]; belts (clothing); collar protectors; mufflers [clothing]; sashes for wear; scarves; neckties; neckerchiefs; muffs; mittens; gloves (clothing); shawls; ponchos; furs; underwear; body linen; lingerie; underwear; underpants; breeches for wear; slips (underwear); teddies (undergarments); crop tops; underpants; brassieres; layettes [clothing]; headgear; headbands (clothing); berets; caps; caps [headwear]; hats; ear muffs; cowls; cap peaks; footwear (except orthopedic footwear); sandals; boots; esparto shoes or sandals; slippers; beach shoes; flip-flops [footwear]; bedroom slippers; socks; tights; stockings.

(260) AM 2015 75829 A

(800) 1190570

(891) 2013 08 22

(731) PRIVATE JOINT STOCK COMPANY

"INDUSTRIAL ASSOCIATION "KONTI"

Bul. Shevchenko, 6-b, Donetsk 83015, UA

(540)



AMOUR

(591) Black, white

(511)

30 – Coffee, tea, cocoa and artificial coffee; rice; tapioca and sago; flour and preparations made from cereals; bread, pastry and confectionery; ices; sugar, honey, treacle; yeast, baking-powder; salt; mustard; vinegar, sauces (condiments); spices; ice; aniseed; peanut confectionery; high-protein cereal bars; baking soda (bicarbonate of soda for cooking purposes); soya bean paste (condiment); bean meal; star aniseed; tapioca flour for food; flour; flour-milling products; pastries; bread rolls; buns; sandwiches; vanillin (vanilla substitute); vanilla (flavoring); waffles; vermicelli (noodles); cream of tartar for culinary purposes; farinaceous foods; oatmeal; oat flakes; oat-based food; sea water for cooking; seaweed (condiment); binding agents for ice cream (edible ices); biscuits; cloves (spice); mustard; mustard meal; cake frosting (icing); glucose for culinary purposes; relish (condiment); gluten additives for culinary purposes; yeast; essences for foodstuffs, except etheric essences and essential oils; fruit jellies (confectionery); chewing gum; custard; leaven; rice-based snack food; cereal-based snack food; artificial cof-

fee; frozen yogurt (confectionery ices); frozen kefir (confectionery ices); flavorings, other than essential oils, for beverages; flavorings, other than essential oils, for cakes; flavorings, other than essential oils; wheat germ for human consumption; preparations for stiffening whipped cream; thickening agents for cooking foodstuffs; chips (cereal products); ginger (spice); coffee; unroasted coffee; coffee flavorings; coffee-based beverages; coffee beverages with milk; vegetal preparations for use as coffee substitutes; cocoa; cocoa beverages with milk; cocoa-based beverages; cocoa-based ingredients for confectionery products; capers; caramels (candy); lozenges (confectionery); curry (spice); potato flour for food; ketchup (sauce); gluten prepared as foodstuff; confectionery; confectionery with sugar; tortillas; cinnamon (spice); starch for food; hominy grits; groats for human food; corn, milled; corn, roasted; corn flour; pop corn; corn flakes; turmeric for food; couscous (semolina); salt for preserving foodstuffs; confectionery for decorating Christmas trees; edible ices; ice for refreshment; ice, natural or artificial; liquorice (confectionery); noodles; candy; flaxseed for human consumption; mayonnaise; macaroni; maltose; hominy; chow-chow (condiment); marinades; marzipan; royal jelly; honey; molasses for food; macarons (pastry); almond paste; almond confectionery; flour-milling products; pancakes; spring rolls; gruel, with a milk base, for food; ice-cream; dessert mousses (confectionery); chocolate mousses; nutmegs; muesli; meat gravies; meat tenderizers, for household purposes; mint for confectionery; peppermint sweets; infusions, not medicinal; husked oats; vinegar; ravioli; pepper; pesto (sauce); beer vinegar; quiches; sweetmeats (candy); pizzas; pies; fondants (confectionery); powder for edible ices; pralines; condiments; dressings for salad; seasonings; unleavened bread; bee glue; gingerbread; spices; puddings; cake powder; fruit coulis (sauces); rice; rice cakes; baking powder; ferments for pastes; sago; garden herbs, preserved (seasonings); celery salt; golden syrup; salt for preserving foodstuffs; soya flour; soya sauce; malt for human consumption; malt biscuits; malt extract for food; tomato sauce; sauces (condiments); spaghetti; noodle-based prepared meals; ham glaze; rusks; breadcrumbs; petit-beurre biscuits; sushi; tabbouleh; tacos; tapioca; petits fours (cakes); crackers; cake paste; tarts; sorbets (ices); halvah; bread; chicory (coffee substitute); sweetmeats (candy); sugar; tea; iced tea; tea-based beverages; chutneys (condiments); saffron (seasoning); chocolate; chocolate-based beverages; chocolate beverages with milk; barley meal; barley (crushed).

(260) AM 2015 76124 A
 (800) 1193068
 (891) 2013 09 02
 (731) KPO MARKETING KOMPANI LIMITED
 Egypt Street, 12, CY-1097 Nikosia, CY

(540)



(591) White, grey, blue, dark blue, black and red
 (511)

33 – Aperitifs; arrack [arak]; brandy; wine; piquette; whisky; vodka; anisette [liqueur]; kirsch; gin; digesters [liqueurs and spirits]; cocktails; curacao; anise [liqueur]; liqueurs; pre-mixed alcoholic beverages, other than beer-based; alcoholic beverages, except beer; alcoholic beverages containing fruit; spirits [beverages]; distilled beverages; mead [hydromell]; peppermint liqueurs; bitters; rum; sake; perry; cider; rice alcohol; alcoholic extracts; fruit extracts, alcoholic; alcoholic essences.

(260) AM 2015 76126 A
 (800) 1193104
 (891) 2013 11 22
 (731) GUERLAIN
 68 Avenue des Champs Elysées, F-75008
 PARIS, FR

(540)



(591) Black, green, gold
 (526) The trademark is protected as a whole. The word "PARIS" included therein shall not be subject to independent legal protection.

(511)

3 – Perfumery products, toilet water, cosmetic products, namely make-up products, body and face care products, essential oils, dentifrices; all the goods are of French origin or made in France.

(260) AM 2015 76130 A
 (800) 1193153
 (891) 2014 01 15
 (731) HENKEL AG & CO. KGaA
 Henkelstrasse 67, 40589 Düsseldorf, DE
 (540)



(591) Black, white
 (511)
 1 – Chemical products for use in industry, namely intermediary products for hair cosmetic purposes.
 3 – Preparations for the conditioning, cleaning, tinting, dyeing, bleaching, fixing and waving of hair, hair lotions and shampoos for cosmetic purposes; dentifrices.

(260) AM 2015 76134 A
 (800) 830015
 (891) 2013 11 22
 (731) WIZZ AIR HUNGARY KFT.
 BUD Nemzetközi Repulotér, (BUD International Airport) 221. ép., H-1185 Budapest, HU
 (540)

WIZZ

(511)
 12 – Vehicles; apparatus for locomotion by land, air or water.
 16 – Paper and paper products; brochures, printed matter; newspapers, magazines, books.
 21 – Household and gift articles made of glass, porcelain and earthenware, utensils and containers (not of precious metal or coated therewith); glass and porcelain ware.
 25 – Clothing, footwear, headgear.
 35 – Advertising.
 39 – Transport of passengers; transport of goods; travel arrangement.
 43 – Catering services; temporary accommodation.

(260) AM 2015 76135 A
 (800) 830763
 (891) 2013 11 22
 (731) WIZZ AIR HUNGARY KFT.
 BUD Nemzetközi Repulotér, (BUD International Airport) 221. ép., H-1185 Budapest, HU

(540)



(591) Purple and pink
 (511)
 12 – Vehicles; apparatus for locomotion by land, air or water.
 16 – Paper and paper products; brochures, printed matter; newspapers, magazines, books.
 21 – Household and gift articles made of glass, porcelain and earthenware, utensils and containers (not of precious metal or coated therewith); glass and porcelain ware.
 25 – Clothing, footwear, headgear.
 35 – Advertising.
 39 – Transport of passengers; transport of goods; travel arrangement.
 41 – Entertainment; publishing.
 43 – Catering services; temporary accommodation.

(260) AM 2015 76136 A
 (800) 850674
 (891) 2013 11 22
 (731) WIZZ AIR HUNGARY KFT.
 BUD Nemzetközi Repulotér, (BUD International Airport) 221. ép., H-1185 Budapest, HU
 (540)



(591) Purple and pink
 (511)
 12 – Vehicles; apparatus for locomotion by land, air or water.
 16 – Paper and paper products; brochures, printed matter; newspapers, magazines, books.
 21 – Household and gift articles made of glass, porcelain and earthenware, utensils and containers (not of precious metal or coated therewith); glass and porcelain ware.
 25 – Clothing, footwear, headgear.
 35 – Advertising.
 39 – Transport of passengers; transport of goods; travel arrangement.
 41 – Entertainment; publishing.
 43 – Catering services; temporary accommodation.

(260) AM 2015 76171 A

(800) 1193210

(891) 2013 06 12

(731) ALEXANDRA GOLD KUYUMCULUK
SANAYİ VE TİCARET ANONİM ŞİRKETİ
Melihpaşa Mahallesi Laleli, Caddesi No:13
Fatih, İstanbul, TR

(540)



(591) White, red, blue

(526) The trademark is protected as a whole. The word "Gold" included therein shall not be subject to independent legal protection.

(511)

14 – Jewelry goods (including their imitation); gold, jewels, precious stones and jewelries made thereof cuff links (jewelry), necktie pins, statues and figurines (statuettes); watches and time measuring devices; chronometers, pendulums and their parts, watch cordons.

35 – Services related to advertising, marketing and public relations including organization of exhibitions and fairs for commercial or advertising purposes, office services, consultancy for business management and administration, accountancy and auditing services, import export agency services, commercial and industrial management expertise services, organization of auctioneering services and auctioneering, the bringing together for the benefit of others of a variety of goods enabling customers to conveniently view and purchase those goods, namely jewelry goods (including their imitation), gold, jewels, precious stones and jewelries made thereof cuff links (jewelry), necktie pins, statues and figurines (statuettes), watches and time measuring devices, chronometers, pendulums and their parts, watch cordons, enabling customers to conveniently view and purchase those goods, the mentioned services can be provided by retail, wholesale, electronic media, catalogues and other similar methods.

(260) AM 2015 76173 A

(800) 1193251

(891) 2013 09 30

(731) Subsidiary Enterprise "BOOK CLUB"
"FAMILY LEISURE CLUB"
prospekt Haharina 20-A, Kharkiv 61140, UA

(540)

BOOK CLUB

(511)

16 – Albums; pamphlets; booklets; greeting cards; newspapers; printed matter; printed publications; magazines (periodicals); note books; calendars; catalogues; books; comic books; handbooks (manuals); posters; prospectuses.

25 – Berets; outerclothing; footwear; ready-made clothing; pelisses; hats; combinations (clothing); suits; jackets (clothing); singlets; body linen (garments); headgear for wear; overcoats; pyjamas; coats; pullovers; overalls; sweaters; shirts; cyclists' clothing; sports jerseys; dresses; aprons (clothing); tee-shirts; dressing gowns; caps (headwear); trousers.

35 – Representation in one palace for other persons of the books, what allows comfortably choose, look and buy mentioned products using special catalogue (Terms too vague in the opinion of the International Bureau – Rule 13(2)(b) of the Common Regulations).

41 – Amusements; family leisure time with the help of the books (Terms too vague in the opinion of the International Bureau – Rule 13(2)(b) of the Common Regulations).

(260) AM 2015 76180 A

(800) 1193288

(891) 2013 11 27

(731) ABENA HOLDING A/S

Egelund 35 DK-6200 Aabenraa, DK

(540)



(591) Purple and green

(511)

5 – Babies' napkins of paper.

16 – Paper for household purposes including kitchen rolls, toilet paper, towels of paper in sheets and roll form, napkins, place mats and paper covers.

(260) AM 2015 76181 A

(800) 1193293

(891) 2013 11 28

(731) VLADYSLAV YEVHENOVYCH ZELDİS
vul. Chervona, 49 A, m. Dnipropetrovsk
49069, UA

(540)



(591) Yellow and black

(511)

35 – Employment agencies; outstaffing; outplacement; psychological testing for the selection of personnel; professional business consultancy; personnel audit; personnel recruitment; professional consultancy in the field of personnel management, personnel recruitment, and personnel assessment; business organization consultancy; business management consultancy; personnel management consultancy; human resource management consultancy; professional

business consultancy; public relations; employment services; temporary personnel services; professional consultancy and advice in the field of staff recruitment and employment; secondment services; staff recruiting services; staff recruiting agencies; placing CVs in the Internet; placing vacancies in the Internet; personnel leasing.

(260) AM 2015 76247 A

(800) 1193606

(891) 2013 12 05

(731) UAB "LITRADA"

Vilniaus g. 44, LT-76251 SIAULIAI, LT

(540)



(591) White, blue, dark blue, light blue, light brown and grey

(511)

29 – Meat jellies; jellies for food; fruit jellies; edible fats; fruit-based snack food; charcuterie; raisins; yogurt; kephir [milk beverage]; milk shakes; black pudding [blood sausage]; meat, tinned [canned (Am.)]; vegetables, tinned [canned (Am.)]; fish, tinned [canned (Am.)]; fruits, tinned [canned (Am.)]; bouillon concentrates; gherkins; shrimps, not live; buttercream; margarine; butter; edible oils; milk; meat; meat, preserved; milk beverages, milk predominating; vegetables, preserved; vegetables, dried; vegetables, cooked; potato fritters; olives, preserved; nuts, prepared; milk products; foods prepared from fish; processed seeds; sausages; preparations for making soup; tripe; soups; cheese; fruit, preserved; Potato chips; eggs.

30 – Malt biscuits; mustard; rice-based snack food; pasta; ketchup [sauce]; ice for refreshment; pies; pizzas; popcorn; puddings; ravioli; sugar; cooking salt; tea.

(260) AM 2015 76250 A

(800) 1193652

(891) 2013 07 02

(731) DAF TRUCKS N.V.

Hugo van der Goeslaan 1, NL-5643 TW
Eindhoven, NL

(540)

TRP

(511)

1 – Antifreeze; brake fluid; liquids and solutions for batteries; protective gases for welding; welding chemicals; soldering fluxes; chemical cleaning additives to gasoline and other motor fuels; coolants for ve-

hicle engines; combusting preparations being chemical additives to motor fuel; glues, adhesives and sealants for the maintenance and repair of vehicles; fuel-saving preparations; transmission fluid; fluids for power steering.

6 – Sheet metal for vehicles.

9 – Coupling amplifiers for land vehicles; control mechanisms for cabins and windows of vehicles (parts of vehicles), non-electric.

11 – Apparatus for lighting; drying, air conditioning, heating, cooling and ventilation equipment including filters and cabin filters being parts of the aforementioned devices, whether or not for vehicles; electric lamps; lamps; vehicle reflectors; LED luminaries to be used with reflection bands for vehicles; lighting apparatus for vehicles; interior lighting for vehicles; lamps for vehicles, including lamps for directional signals; vehicle tail lights and headlights; high beam headlamps for vehicles; fog lamps for vehicles; pocket torches, electric; vehicle breakdown warning light; marker lamps; safety lamps; work lamps; light bulbs; microwave ovens (cooking apparatus); electrical water heaters; electric coffee percolators; cold boxes, electric, for use in trucks; blankets, electric, not for medical purposes; air driers; cartridges as components of air driers; filters for air conditioning; air filtering installations; air purifying apparatus and machines; cooling installations and machines; refrigerating cabinets and chambers with their parts; radiator caps; air conditioning and heaters for vehicles; light brackets for truck and trailer lights; anti-glare devices for vehicles (lamp fittings); parts for refrigeration equipment and machines.

12 – Vehicles; parts for vehicles, not included in other classes; trucks, buses, trailers, semi-trailers; engines for land vehicles; vehicle cabs; cab, chassis and body parts for vehicles, trailers and semi-trailers; cargo lift parts and shafts parts for vehicles, trailers and semi-trailers; spoilers, grills, bumpers, side skirts, fenders, seats, doors and steps for vehicles; foot boards for vehicles; door extensions and door windshields being parts of trucks; hoods and sunblinds specially adapted for vehicles; belts for land vehicles; transmission shafts and transmission chains for land vehicles; windscreen wipers; blades for windscreen wipers; windows for vehicles; pneumatic spring bellows for vehicles; brake shoes, brake drums, brake calipers, brake hoses, brake discs, brake couplers, brake cylinders, brake pads, brake linings, brake segments for vehicles; brakes for vehicles; air brake valves for vehicle tires; brake levers and ABS sensor cables being parts of brakes for vehicles; valves for vehicle tires; caps for vehicle petrol (gas) tanks; fuel tanks, coolant tanks, wiper fluid tanks, fluid tanks, antifreeze liquid tanks and other such tanks specially for vehicles; suspension shock absorbers for vehicles; shock absorbing

springs for vehicles; splash guards and mud flaps for vehicles; anti-skid chains; vehicle wheel tires; air pumps for vehicles; headlight wipers; clutches for land and heads therefor; gear boxes for land vehicles; couplings for land vehicles and trailers; steering parts for vehicles; covers for steering wheels; steering wheels for vehicles; vehicle covers (shaped); covers for vehicle seats; horns and air horns for vehicles; refrigerated vehicles and load carrying trailers; outriggers for vehicles; interior and outside mirrors for vehicles; safety belts for vehicle seats; wheel hubs, sockets, rings, rims, bearings and bolts for vehicle wheels for land vehicles; hydraulic cylinders for tilting truck cabins; drawbar couplings for land vehicles; hydraulic circuits for vehicles; transmission belts for land vehicles; anti-theft alarms for vehicles; lockable fuel caps for vehicles.

(260) AM 2015 76254 A

(800) 1193694

(891) 2013 11 18

(731) Obschestvo s Ogranichennoi Otvetstvennostiu "DOMANI GRUP"

Derbenevskaya naberezhnaia, 7, stroenie 5, RU-115114 Moskva, RU

(540)

DIAMANT BY MEDOFF

(511)

33 – Alcoholic beverages, except beer; aperitifs; arak [arrack]; brandy; wine; sparkling wine; whisky; anisette [liqueur]; vodka; anise [liqueur]; hydromel [mead]; kirsch; perry; gin; cognac; cocktails; curacao; liqueurs; peppermint liqueurs; distilled beverages; alcoholic beverages containing fruit; bitters; piquette; rice alcohol; rum; sake; cider; spirits [beverages]; alcoholic extracts; alcoholic essences; fruit extracts, alcoholic; digesters (liqueurs and spirits).

(260) AM 2015 76266 A

(800) 1193776

(891) 2013 10 21

(731) E.C. S.p.A.

Via Fusetti, 12, I-20143 MILANO, IT

(540)

CostumeNemutso

(591) Black, grey

(511)

3 – Perfumery, cosmetics, essential oils, hair care preparations; soaps for personal use.

18 – Leather and imitations of leather, and goods made of these materials and not included in other classes; trunks [luggage]; travelling bags, handbags; attache cases, haversacks; rucksacks; vanity cases, not fitted; leatherware, namely purses, pocket wal-

lets, briefcases, key cases; umbrellas, walking sticks; saddlery.

25 – Clothing for men and women, suits, skirts, trousers, shorts, jackets, overcoats, coats, topcoats, waterproof clothing, shirts, T-shirts, jumpers, undershirts, pullovers, sweaters, underwear; swimsuits, clothing for gymnastics and sport, scarves, shawls, neckties, belts [clothing], gloves [clothing], socks, stockings, shoes, slippers, boots, sports shoes, gymnastic shoes; headgear for wear.

(260) AM 2015 76267 A

(800) 1193820

(891) 2013 11 25

(731) DAW SE

Roßdörfer Str. 50, 64372 Ober-Ramstadt, DE

(540)



**DEUTSCHE
AMPHIBOLIN-WERKE
VON ROBERT MURJAHN**

(591) Green, white and petrol

(511)

2 – Paints, varnishes, lacquers, glazes (included in this class), anti-rust preparations for preservation; primers; colorants, dyestuffs, dye pastes, mordants; thickeners for paints; fixatives, siccatives for paints; natural resins (included in this class); thinning and binding preparations for paints and lacquers; wood preservatives, wood mordants and wood preserving oils; paints (included in this class), including structuring paints; bactericidal and/or fungicidal paints; anti-corrosive preparations; protective preparations for metals; metals in foil and powder form for painters, decorators, printers and artists.

17 – Packing, thermal protection and insulating materials (included in this class); insulating paints, varnishes, fabrics and plaster; substances for insulating buildings against moisture; artificial and synthetic resins; fiberglass fabrics for insulation; insulating tape; heat insulators; insulating boards; lattice mats of glass fabrics and/or plastics; expansion joint profiles of glass fibre and/or plastics (all the aforesaid being for heat insulation composite systems); plastic film, not for wrapping; adhesive tapes and strips for building; moisture-insulating paints for roofs, walls and floors.

19 – Building materials (non-metallic); profile rails and corner irons, in particular edging profiles (not of metal, for building); adjusting and levelling parts, not of metal, for building; spacers, not of metal, for building; sills (not of metal); natural and artificial stone; mortar and quartz (building materials); plaster (included in this class); coatings (building materials); wall and ceiling panels (non-metallic, for building); fabric embedding compounds for building; fillers being building materials.

(260) AM 2015 76269 A
 (800) 1193821
 (891) 2014 01 07
 (731) BROOKSBURNETT INVESTMENTS LTD
 BROOKSBURNETT INVESTMENTS LTD
 SOFIAS TSIROU, 9 TOULLA, COURT 3,
 2ND FL., FLAT OFFICE 22, CY-3021
 LIMASSOL, CY

(540)
EXY VALENTINE

(511)
 25 – Clothing, footwear and headgear for men, women and children, namely, belts, coats, raincoats, waistcoats, blouses and pullovers, jackets, trousers, dresses, suits, swimsuits, shirts and chemises, t-shirts, sweaters, underwear, hosiery, socks and stockings, tights, gloves, ties, scarves, hats and caps, leather shoes, rubber shoes, low shoes, sandals, straw shoes, slippers, sport shoes, shoe soles, shoe liners, bath sandals, bath slippers, boots, lace shoes, half boots, outsoles, shoe uppers.

(260) AM 2015 76272 A
 (800) 1193849
 (891) 2013 12 18
 (731) Obshchestvo s ogranichennoy
 otvetstvennostyu "PARAFARM"
 ul. Sverdlova, d. 4, RU-440026 g. Penza, RU

(540)



(591) Dark lilac, light lilac, bluish tint, white, dark purple, gray, taupe, blue, purple and black

(511)
 5 – Biologically active additives.

(260) AM 2015 76289 A
 (800) 1150049
 (891) 2013 12 06
 (731) Obshchestvo s ogranichennoy
 otvetstvennostyu "VIRSA"
 komnata 5, pomeshcheniye IX, korpus 1, dom
 N:4, Mozhayskoye sh, RU-121374 Moskva, RU

(540)
Weissgauff

(591) Black, white

(511)
 7 – Machine wheels; coffee grinders, other than hand-operated; water separators; handling machines, automatic [manipulators]; churns; blowing machines for the compression, exhaustion and transport of gases; bottle washing machines; dishwashers; grinding machines; bread cutting machines; machines and apparatus for cleaning, electric; machines and apparatus for carpet shampooing, electric; kitchen machines, electric; rinsing machines; wringing machines for laundry; stitching machines; washing machines; washing machines [laundry]; sewing machines; mills [machines]; mills for household purposes, other than hand-operated; pepper mills other than hand-operated; mixers [machines]; blenders, electric, for household purposes; vacuum cleaner bags; threshing machines; knives, electric; food processors, electric; vacuum cleaners; fruit presses, electric, for household purposes; washing apparatus; vacuum cleaner hoses.

9 – DVD players; answering machines; accumulators, electric; Global Positioning System [GPS] apparatus; diffraction apparatus [microscopy]; sound transmitting apparatus; cash registers; flashing lights [luminous signals]; blueprint apparatus; telephone apparatus; facsimile machines; anode batteries; batteries for lighting; solar batteries; batteries, electric; balances [steelyards]; electronic tags for goods; magnetic tape units for computers; computer memory devices; scales; camcorders; video cassettes; video telephones; video screens; viewfinders, photographic; circuit closers; hands free kits for phones; transparencies [photography]; diaphragms [photography]; dictating machines; floppy disks; sound recording discs; disks, magnetic; optical discs; calculating disks; disk drives for computers; juke boxes for computers; DNA chips; locks, electric; electric door bells; signal bells; acoustic conduits; mirrors for inspecting work; needles for record players; interfaces for computers; ionization apparatus not for the treatment of air or water; calculating machines; pocket calculators; decompression chambers; electronic pens [visual display units]; video game cartridges; carriers for dark plates [photography]; spools [photography]; computer keyboards; electronic agendas; push buttons for bells; mouse pads; magnetic encoders; compact discs [audio-video]; compact discs [read-only memory]; computers; laptop computers; notebook computers; flashlights [photography]; head cleaning tapes [recording]; magnetic tapes; video-tapes; surveying chains; mouse [data processing equipment]; microprocessors; modems; monitors [computer hardware]; monitors [computer programs]; sound recording carriers; magnetic data media; optical data media; computer software, recorded; weighing machines; radio pagers; electronic pocket translators; transmitters [telecommunication]; telephone transmitters; transmitters of electronic signals; switches, electric; plates for batteries; wafers

[silicon slices]; printed circuit boards; compact disc players; cassette players; sound recording strips; speed measuring apparatus [photography]; navigation apparatus for vehicles [on-board computers]; audio- and video-receivers; printers for use with computers; computer programmes [programs], recorded; computer game programs; computer programs [downloadable software]; computer operating programs, recorded; record players; processors [central processing units]; electronic publications, downloadable; vehicle radios; transmitting sets [telecommunication]; radios; frames for photographic transparencies; screens for photoengraving; walkie-talkies; washing trays [photography]; scanners [data processing equipment]; integrated circuit cards [smart cards]; personal stereos; stands for photographic apparatus; drying racks [photography]; integrated circuits; egg timers [sandglasses]; word processors; television apparatus; portable telephones; telephone receivers; amplifiers; video recorders; sound reproduction apparatus; tape recorders; data processing apparatus; drying apparatus for photographic prints; film cutting apparatus; centering apparatus for photographic transparencies; battery chargers; computer peripheral devices; photocopiers [photographic, electrostatic, thermic]; bar code readers; downloadable ring tones for mobile phones; downloadable image files; downloadable music files; animated cartoons; filters for ultraviolet rays, for photography; USB flash drives; cameras [photography]; shutters [photography]; cell phone straps; eyeglass cords; tripods for cameras; filters [photography]; screens [photography].

11 – Lamp shades; desiccating apparatus; hydromassage bath apparatus; disinfectant apparatus; air deodorising apparatus; ionization apparatus for the treatment of air or water; coffee roasters; beverage cooling apparatus; hand drying apparatus for washrooms; fruit roasters; water purifying apparatus and machines; refrigerating apparatus and machines; drying apparatus and installations; freezers; drying apparatus; expansion tanks for central heating installations; flushing tanks; bidets; bath tubs; spa baths [vessels]; bath tubs for sitz baths; waffle irons, electric; fans [air-conditioning]; fans [parts of air-conditioning installations]; electric fans for personal use; water heaters; water heaters [apparatus]; water flushing installations; air reheaters; extractor hoods for kitchens; gas condensers, other than parts of machines; burners; acetylene burners; petrol burners; gas burners; burners for lamps; germicidal burners; hot water bottles; footwarmers, electric or non-electric; bedwarmers; pocket warmers; warming pans; grills [cooking appliances]; lampshade holders; showers; refrigerating containers; gas lighters; lighters; friction lighters for igniting gas; shower cubicles [enclosures (Am.)]; refrigerating chambers; pressure cooking saucepans, electric; air conditioning apparatus; air conditioners for vehicles; coffee machines,

electric; taps [cocks, spigots] [faucets (Am.)] for pipes; taps [faucets]; mixer taps for water pipes; curling lamps; germicidal lamps for purifying air; bread baking machines; barbecues; heaters for heating irons; anti-splash tap nozzles; refrigerating appliances and installations; stoves [heating apparatus]; bakers' ovens; kitchen ranges [ovens]; microwave ovens [cooking apparatus]; urinals [sanitary fixtures]; heating plates; hot plates; heaters, electric, for feeding bottles; water filtering apparatus; air purifying apparatus and machines; ice machines and apparatus; cooling appliances and installations; cooking rings; heating apparatus, electric; hot air apparatus; steam facial apparatus [saunas]; cookers, including cooktop; roasting jacks; plate warmers; radiators [heating]; central heating radiators; radiators, electric; sinks; lamps; street lamps; ceiling lights; toilet seats; pressure cookers [autoclaves], electric; air dryers; laundry dryers, electric; hair dryers; bread toasters; toilets [water-closets]; toilets, portable; wash-hand basins [parts of sanitary installations]; toilet bowls; air conditioning installations; water purification installations; air filtering installations; ventilation [air-conditioning] installations for vehicles; water softening apparatus and installations; heating installations; air cooling apparatus; cooking utensils, electric; filters [parts of household or industrial installations]; filters for air conditioning; coffee filters, electric; filters for drinking water; bread-making machines; refrigerators; kettles, electric; refrigerating cabinets; ice boxes; bath installations.

(260) AM 2015 76331 A

(800) 1194001

(891) 2013 11 29

(731) TRUPER, S.A. DE C.V.

Parque Industrial No:1 Jilotepec, 54520
Mexico, MX

(540)

TRUPER

(511)

7 – Machines and machine tools; motors and engines (except for land vehicles); machine coupling and transmission components (except for land vehicles); agricultural implements other than hand-operated; incubators for eggs; distribution machines, automatic; welding apparatus, gas-operated; aerators; saw benches [parts of machines]; lawnmowers [machines]; soldering blow pipes, gas-operated; raking machines; stalk separators [machines]; electric hand drills; rakes for raking machines; tools [parts of machines]; hand-held tools, other than hand-operated; ditchers [ploughs]; harvesting machines; cultivators [machines]; earth moving machines; agricultural machines; clippers [machines]; pneumatic hammers; hammers [parts of machines]; tilt hammers; motorized cultivators; blades [parts of machines]; knives for mowing machines; scissors, elec-

tric; shears, electric; soldering irons, gas-operated; saws [machines]; chain saws; glue guns, electric; saw blades [parts of machines]; ploughs; knives [parts of machines]; snow ploughs; machine tools; woodworking machines; glaziers' diamonds [parts of machines]; tables for machines; brushes [parts of machines]; agricultural elevators.

8 – Hand tools and implements, hand-operated; cutlery; table cutlery [knives, forks and spoons]; side arms, other than firearms; razors; forks; weeding forks [hand tools]; lawn clippers [hand instruments]; nail extractors; rakes [hand tools]; priming irons [hand tools]; drills; edge tools [hand tools]; garden tools, hand-operated; abrading instruments [hand instruments]; tube cutting instruments; cutting tools [hand tools]; hand tools, hand-operated; centre punches [hand tools]; mallets [hand instruments]; punch pliers [hand tools]; annular screw plates; spanners [hand tools]; tap wrenches; diggers [hand tools]; scythes; hainault scythes; sledgehammers; thistle extirpators [hand tools]; tree pruners; crow bars; shovels [hand tools]; hammers [hand tools]; mattocks; files [tools]; budding knives; hunting knives; grafting tools [hand tools]; bill-hooks; knives; shears; scissors; agricultural implements, hand-operated; screwdrivers; saws [hand tools]; bow saws; guns [hand tools]; saw blades [parts of hand tools]; insecticide sprayers [hand tools]; syringes for spraying insecticides; cutters; planes; borers; secateurs; sickles; trowels [gardening]; scrapers [hand tools]; mortise chisels; hatchets; vices; adzes [tools]; hoop cutters [hand tools]; axes; squares [hand tools]; tube cutters [hand tools]; plant parasite killing apparatus.

9 – Surveying apparatus and instruments; scientific, nautical, surveying, photographic, cinematographic, optical, weighing, measuring, signalling, checking [supervision], life-saving and teaching apparatus and instruments; levelling staffs [surveying instruments]; measures; measuring instruments; mathematical instruments; surveying instruments; azimuth instruments; magnetic tapes; surveying chains; rulers [measuring instruments]; slide-rules; pressure gauges; rules [measuring instruments]; carpenters' rules; dressmakers' measures; micrometers; knee-pads for workers; transmitters of electronic signals; distance measuring apparatus; optical apparatus and instruments; measuring apparatus; measuring devices, electric; precision measuring apparatus; protractors [measuring instruments]; slope indicators; levels [instruments for determining the horizontal]; mercury levels; spirit levels; photometers; compasses [measuring instruments]; frequency meters.

35 – 35 Import-export agencies; sales promotion for others; procurement services for others [purchasing goods and services for other businesses].

(260) AM 2015 76332 A

(800) 1194037

(891) 2013 11 07

(731) TAKEDA GMBH

Byk-Gulden-Str. 2, 78467 Konstanz, DE

(540)

СелГАРА

(511)

5 – Pharmaceutical and veterinary preparations; sanitary preparations for medical purposes; dietetic food and substances adapted for medical use; dietary supplements for humans; plasters, materials for dressings; vulnerary sponges for medical or surgical purposes for use on or in the body of humans or animals; surgical implants (living tissues) made from membranes for use on or in the body of humans or animals; materials for dressings in form of membranes, foils and patches for medical or surgical use on or in the body of humans or animals; vulnerary sponges made from or incorporating collagen for use in human or veterinary medicine or in human or veterinary surgery; surgical implants (living tissues) made from membranes made from or incorporating collagen for use in human or veterinary medicine or in human or veterinary surgery; materials for dressings made from membranes, foils and patches made from or incorporating collagen for use in human or veterinary medicine or in human or veterinary surgery; disinfectants; materials for dressings made from membranes, foils and patches and fleeces for the prevention of postoperative adhesions; surgical resorbable implants (living tissues); supportive surgical and medical plasters for use in skin repair and skin improvement procedures; supportive medical compresses for use in skin repair and skin improvement procedures.

10 – Surgical, medical, dental and veterinary apparatus and instruments, artificial limbs, eyes and teeth; orthopedic articles; suture materials; implants made from artificial materials made from membranes, foils, patches and fleeces for surgical and medical use; surgical implants (artificial materials) made from membranes, foils, patches and fleeces for the use in or on the body of humans or animals; artificial skin for surgical purposes for the use on the body of humans or animals; surgical resorbable implants made from artificial materials; supportive surgical and medical compresses for use in skin repair and skin improvement procedures, supportive elastic or orthopedic bandages for use in skin repair and skin improvement procedures; sponges for surgical purposes, all for use on or in the human and non-human body; supportive bandages for use in skin repair and skin improvement procedures.

(260) AM 2015 76333 A
 (800) 1194038
 (891) 2013 11 07
 (731) TAKEDA GMBH
 Byk-Gulden-Str. 2, 78467 Konstanz, DE
 (540)

COLLGARA

(511)
 5 – Pharmaceutical and veterinary preparations; sanitary preparations for medical purposes; dietetic food and substances adapted for medical use; dietary supplements for humans; plasters, materials for dressings; vulnerary sponges for medical or surgical purposes for use on or in the body of humans or animals; surgical implants (living tissues) made from membranes for use on or in the body of humans or animals; materials for dressings in form of membranes, foils and patches for medical or surgical use on or in the body of humans or animals; vulnerary sponges made from or incorporating collagen for use in human or veterinary medicine or in human or veterinary surgery; surgical implants (living tissues) made from membranes made from or incorporating collagen for use in human or veterinary medicine or in human or veterinary surgery; materials for dressings made from membranes, foils and patches made from or incorporating collagen for use in human or veterinary medicine or in human or veterinary surgery; disinfectants; materials for dressings made from membranes, foils and patches and fleeces for the prevention of postoperative adhesions; surgical resorbable implants (living tissues); supportive surgical and medical plasters for use in skin repair and skin improvement procedures; supportive medical compresses for use in skin repair and skin improvement procedures.

10 – Surgical, medical, dental and veterinary apparatus and instruments, artificial limbs, eyes and teeth; orthopedic articles; suture materials; implants made from artificial materials made from membranes, foils, patches and fleeces for surgical and medical use; surgical implants (artificial materials) made from membranes, foils, patches and fleeces for the use in or on the body of humans or animals; artificial skin for surgical purposes for the use on the body of humans or animals; surgical resorbable implants made from artificial materials; supportive surgical and medical compresses for use in skin repair and skin improvement procedures, supportive elastic or orthopedic bandages for use in skin repair and skin improvement procedures; sponges for surgical purposes, all for use on or in the human and non-human body; supportive bandages for use in skin repair and skin improvement procedures.

(260) AM 2015 76334 A
 (800) 1194039
 (891) 2013 11 07

(731) TAKEDA GMBH
 Byk-Gulden-Str. 2, 78467 Konstanz, DE
 (540)

CELLGARA

(511)
 5 – Pharmaceutical and veterinary preparations; sanitary preparations for medical purposes; dietetic food and substances adapted for medical use; dietary supplements for humans; plasters, materials for dressings; vulnerary sponges for medical or surgical purposes for use on or in the body of humans or animals; surgical implants (living tissues) made from membranes for use on or in the body of humans or animals; materials for dressings in form of membranes, foils and patches for medical or surgical use on or in the body of humans or animals; vulnerary sponges made from or incorporating collagen for use in human or veterinary medicine or in human or veterinary surgery; surgical implants (living tissues) made from membranes made from or incorporating collagen for use in human or veterinary medicine or in human or veterinary surgery; materials for dressings made from membranes, foils and patches made from or incorporating collagen for use in human or veterinary medicine or in human or veterinary surgery; disinfectants; materials for dressings made from membranes, foils and patches and fleeces for the prevention of postoperative adhesions; surgical resorbable implants (living tissues); supportive surgical and medical plasters for use in skin repair and skin improvement procedures; supportive medical compresses for use in skin repair and skin improvement procedures.

10 – Surgical, medical, dental and veterinary apparatus and instruments, artificial limbs, eyes and teeth; orthopedic articles; suture materials; implants made from artificial materials made from membranes, foils, patches and fleeces for surgical and medical use; surgical implants (artificial materials) made from membranes, foils, patches and fleeces for the use in or on the body of humans or animals; artificial skin for surgical purposes for the use on the body of humans or animals; surgical resorbable implants made from artificial materials; supportive surgical and medical compresses for use in skin repair and skin improvement procedures, supportive elastic or orthopedic bandages for use in skin repair and skin improvement procedures; sponges for surgical purposes, all for use on or in the human and non-human body; supportive bandages for use in skin repair and skin improvement procedures.

(260) AM 2015 76335 A
 (800) 1194059
 (891) 2014 01 24
 (731) Obshchestvo s ogranichennoi
 otvetstvennostyu "INTEL"
 Varshavskoye shosse, d. 75, korp. 1,
 RU-117556 Moscow, RU

(540)

Жемчужина Колхиды

(526) The trademark is protected as a whole. The word "Колхиды" included therein shall not be subject to independent legal protection.

(511)

32 – Beers originating from Georgia; mineral and aerated waters and other non-alcoholic beverages originating from Georgia; fruit beverages and fruit juices originating from Georgia; syrups and other preparations for making beverages originating from Georgia.

33 – Alcoholic beverages (except beers) originating from Georgia.

(260) AM 2015 76339 A

(800) 1194071

(891) 2014 01 30

(731) DELL INC.

One Dell Way, Round Rock, TX 78682, US

(540)

VENUE

(511)

9 – Computer hardware, namely tablet computers and power adapters.

(260) AM 2015 76341 A

(800) 1194072

(891) 2013 07 15

(731) WORLD MEDICINE İLAÇ SANAYİ VE TİCARET LİMİTED ŞİRKETİ

Evren Mah. Camiyolu Cad. No:50 K.1B,
Zemin -4-5-6, GÜNEŞLİ/BAĞCILAR/İS-TANBUL, TR

(540)

Bimasopt**Бимасопт**

(591) Black, white

(511)

5 – Medicines for human purposes, medicines for veterinary purposes, vitamin preparations, chemical preparations for medical purposes, dietetic substances adapted for medical use; dietetic foods adapted for medical purposes; baby foods, medicinal herbs, herbal beverages adapted for medical purposes, nutritional supplements, pollen dietary supplements, mineral food supplements, protein dietary supplements; medicines for dental purposes, hygienic products for medical purposes including pads (Term too vague in the opinion of the International Bureau – Rule 13(2)(b) of the Common Regulations), wadings for medical purposes, plasters for medical purposes, dressings for medical purposes, babies' napkins, preparations for destroying noxious plants,

preparations for destroying noxious animals, fungicides, deodorants other than for human beings or for animals, disinfectants for hygiene purposes, antiseptics, detergents for medical purposes.

(260) AM 2015 76343 A

(800) 1194095

(891) 2013 08 06

(731) WORLD MEDICINE İLAÇ SANAYİ VE TİCARET LİMİTED ŞİRKETİ

Evren Mah. Camiyolu Cad. No,50 K.1B,
Zemin -4-5-6, GÜNEŞLİ/BAĞCILAR/İS-TANBUL, TR

(540)

**OTROCORT
ОТРОКОРТ**

(591) Black, white

(511)

5 – Medicines for human purposes, medicines for veterinary purposes, vitamin preparations, chemical preparations for medical purposes, dietetic substances adapted for medical use; dietetic foods adapted for medical purposes; baby foods, medicinal herbs, herbal beverages adapted for medical purposes, nutritional supplements, pollen dietary supplements, mineral food supplements, protein dietary supplements; medicines for dental purposes, hygienic products for medical purposes including pads (Term too vague in the opinion of the International Bureau – Rule 13(2)(b) of the Common Regulations), wadings for medical purposes, plasters for medical purposes, dressings for medical purposes, babies' napkins, preparations for destroying noxious plants, preparations for destroying noxious animals, fungicides, deodorants other than for human beings or for animals, air deodorising preparations, disinfectants for hygiene purposes, antiseptics, detergents for medical purposes.

(260) AM 2015 76344 A

(800) 1194109

(891) 2014 01 06

(731) SATURDAYS SURF LLC

401 Broadway, 26th Floor, New York
NY 10013, US

(540)

SATURDAYS SURF NYC

(526) The trademark is protected as a whole. The words "SURF" and "NYC" included therein shall not be subject to independent legal protection.

(511)

9 – Sunglasses.

18 – Handbags, purses and wallets.

25 – Clothing, namely, t-shirts, collared shirts, sweaters, sweatshirts, hooded sweatshirts, jackets,

shorts, pants, slacks, trousers, swimwear, gloves, scarves, socks, and shoes.

35 – Retail and on-line retail store services featuring clothing, clothing accessories, personal grooming products, coffee, and artwork.

(260) AM 2015 76348 A

(800) 1194144

(891) 2013 11 12

(731) SHENZHEN WEI DA HUI ER TECHNOLOGY CO., LTD.

Floor 1st to 4th, No:20 Building, Zhiheng strategic New Industrial Park, Guankou 2nd Road, Nanshan District, Shenzhen, CN

(540)

HOLL

(591) Black, white

(511)

9 – Data processing apparatus; computer memory devices; computers; computer programmes [programs], recorded; computer peripheral devices; computer software [recorded]; computer programs [downloadable software]; network communication equipment; portable telephones; chargers for electric batteries.

(260) AM 2015 76349 A

(800) 1194146

(891) 2013 10 17

(731) Gesellschaft mit beschränkter Haftung "EHRMANN"

pos. RAOS, 15, Ramenskiy r-n, RU-140025 Moscow Region, RU

(540)



(591) Green, light green, dark green, azure, dark azure, blue, yellow, white, light gray, red, light red, pink and beige

(511)

29 – Milk products, namely yoghurt, drinking yogurt, dessert quark, quark products with fruit, milk-based and cream-based desserts, milk-based and cream-based desserts with addition of fruit filling, milk-based and cream-based buttercream.

(260) AM 2015 76350 A

(800) 1194157

(891) 2013 10 17

(731) BILLIONAIRE TRADEMARKS B.V.

Silodam 187, NL-1013 AS AMSTERDAM, NL

(540)

BILLIONAIRE

(511)

35 – Retail services, rendered also on-line, featuring perfumery and cosmetics, spectacles, sunglasses, cases, frames, lenses and chains for spectacles, apparatus for recording, transmission or reproduction of sound or images, computer software, data processing equipment and computers, cameras, protective helmets, jewellery, imitation jewellery and horological instruments, bags, leather and leather articles, umbrellas, furniture, mirrors, picture frames, household or kitchen utensils and containers (not of precious metal or coated therewith), combs and sponges, brushes (except paint brushes), glassware, porcelain and earthenware, textiles and textile goods, curtains, household, table and bed linen, bath linen, clothing, footwear, headgear, carpets, rugs, mats and matting, linoleum and other materials for covering existing floors, wall hangings (non-textile).

(260) AM 2015 76351 A

(800) 1194178

(891) 2013 10 25

(731) YANA DMYTRIVNA MATVIICHUK

vul. Kniazhyi Zaton, 16 B, kv. 25, Kyiv 02068, UA

(540)



(591) Blue, orange and white

(511)

35 – Commercial information agencies; administrative processing of purchase orders; auctioneering; accounting; marketing studies; opinion polling; psychological testing for the selection of personnel; organization of exhibitions for commercial or advertising purposes; organization of trade fairs for commercial or advertising purposes; business management of hotels; demonstration of goods; business information; business appraisals; business management assistance; marketing research; presentation of goods on communication media, for retail purposes; compilation of information into computer databases; compilation of statistics; public relations; import-export agencies; on-line advertising on a computer network; office machines and equipment rental; commercial or industrial management assistance; advisory services for business management; commercial administration of the licensing of the goods and services of others; business management consultancy; business management and organization consultancy; business management of sports people; commercial information and advice for consumers (consumer

advice shop); systemization of information into computer databases; professional business consultancy; business organization consultancy; layout services for advertising purposes; marketing; organization of fashion shows for promotional purposes; procurement services for others (purchasing goods and services for other businesses); outsourcing services (business assistance); sponsorship search; rental of advertising space; rental of advertising time on communication media; advertising agencies; publicity material rental; dissemination of advertising matter; advertising; sales promotion for others.

39 – Motor coach rental; bus transport; car rental; rental of motor racing cars; car transport; parking place rental; railway truck rental; arranging of travel tours; arranging of cruises; chauffeur services; piloting; boat transport; pleasure boat transport; garage rental; sightseeing (tourism); railway transport; storage of goods; traffic information; transportation information; marine transport; passenger transport; transport; transport brokerage; removal services; transport of travellers; travel reservation; escorting of travellers; booking of seats for travel; transport reservation; ferry-boat transport; shipbrokerage; river transport; rental of vehicle roof racks; taxi transport; vehicle rental; railway coach rental; boat rental.

41 – Educational examination; publication of books; production of shows; rental of show scenery; educational services; presentation of live performances; organization of exhibitions for cultural or educational purposes; education information; nursery schools; videotaping; rental of videotapes; videotape film production; organization of balls; organization of shows (impresario services); organization of competitions (education or entertainment); arranging and conducting of congresses; arranging and conducting of colloquiums; arranging and conducting of conferences; arranging and conducting of concerts; arranging and conducting of workshops (training); arranging and conducting of seminars; arranging and conducting of symposiums; arranging of beauty contests; operating lotteries; organization of sports competitions; production of radio and television programmes; disc jockey services; recreation information; amusements; providing amusement arcade services; electronic desktop publishing; correspondence courses; party planning (entertainment); coaching (training); entertainment information; providing karaoke services; club services (entertainment or education); health club services (health and fitness training); microfilming; providing museum facilities (presentation, exhibitions); practical training (demonstration); religious education; providing on-line electronic publications, not downloadable; providing recreation facilities; vocational guidance (education or training advice); boarding schools; translation; organization of fashion shows for entertainment purposes; booking of seats for shows; personal

trainer services (fitness training); publication of electronic books and journals on-line; entertainer services; scriptwriting services; television entertainment; photography; photographic reporting.

43 – Tourist homes; bar services; rental of transportable buildings; hotels; hotel reservations; temporary accommodation reservations; rental of temporary accommodation; accommodation bureaux (hotels, boarding houses); canteens; cafés; cafeterias; motels; rental of tents; boarding houses; boarding house bookings; boarding for animals; providing campground facilities; food and drink catering; rental of meeting rooms; restaurants; self-service restaurants; holiday camp services (lodging).

(260) AM 2015 76352 A

(800) 1194282

(891) 2013 06 20

(731) Limited liability company "WILDBERRIES"
Milkovo village, possession 1, Leninsky
district, RU-142715 Moscow Region, RU

(540)



(591) White, black, rose, light rose, green, amarante,
violet and dark violet

(511)

25 – Wimples; bandanas [neckerchiefs]; underwear; sweat-absorbent underclothing [underwear]; berets; overalls; boas [necklets]; teddies [undergarments]; half-boots; ski boots; boots for sports; breeches for wear; trousers; football shoes; brassieres; collars [clothing]; detachable collars; shirt yokes; veils [clothing]; gabardines [clothing]; galoshes; neckties; Ascots; leggings [leg warmers]; spats; boot uppers; corselets; jerseys [clothing]; vests; singlets; hosiery; heels; pants; hoods [clothing]; hat frames [skeletons]; pockets for clothing; collar protectors; visors [headwear]; cap peaks; tights; slips [undergarments]; wet suits for water-skiing; combinations [clothing]; bodices [lingerie]; corsets [underclothing]; suits; bathing suits; masquerade costumes; beach clothes; stuff jackets [clothing]; jackets [clothing]; fishing vests; leggings [trousers]; liveries; camisoles; cuffs; short-sleeve shirts; mantillas; coats; sleep masks; furs [clothing]; mittens; miters [hats]; footmuffs, not electrically heated; muffs [clothing]; heelpieces for footwear; bibs, not of paper; fur stoles; ear muffs [clothing]; socks; footwear; beach shoes; sports shoes; clothing; paper clothing; outerclothing; ready-made clothing; motorists' clothing; cyclists' clothing; clothing for gymnastics; clothing of imitations of leather; clothing of leather; uniforms; fittings of metal for footwear; maniples; overcoats; parkas; pelerines; ski gloves; gloves [clothing]; pajamas

(Am.); bathing trunks; shirt fronts; scarfs; pocket squares; dresses; waterproof clothing; headbands [clothing]; garters; sock suspenders; stocking suspenders; ready-made linings [parts of clothing]; dress shields; soles for footwear; braces for clothing [suspenders]; lace boots; ponchos; girdles; money belts [clothing]; belts [clothing]; layettes [clothing]; non-slipping devices for footwear; jumpers [pullovers]; heelpieces for stockings; welts for footwear; chasubles; shirts; wooden shoes; sandals; bath sandals; boots; jumper dresses; saris; sarongs; sweaters; footwear uppers; inner soles; bath slippers; togas; knitwear [clothing]; underpants; shoes; gymnastic shoes; slippers; skull caps; turbans; headgear for wear; aprons [clothing]; tee-shirts; dressing gowns; bath robes; top hats; tips for footwear; stockings; sweat-absorbent stockings; shawls; paper hats [clothing]; caps [headwear]; shower caps; bathing caps; sashes for wear; studs for football boots; hats; babies' pants [clothing]; trouser straps; pelisses; esparto shoes or sandals; skirts; petticoats; skorts.

35 – Arranging subscriptions to telecommunication services for others; import-export agencies; commercial information agencies; advertising agencies; cost price analysis; rental of advertising space; business auditing; employment agencies; computerized file management; book-keeping; invoicing; demonstration of goods; transcription; opinion polling; marketing studies; business information; commercial information and advice for consumers [consumer advice shop]; business investigations; business research; marketing research; personnel recruitment; business management and organization consultancy; business organization consultancy; business management consultancy; personnel management consultancy; professional business consultancy; layout services for advertising purposes; marketing; business management of performing artists; business management of sports people; news clipping services; updating of advertising material; word processing; organization of exhibitions for commercial or advertising purposes; arranging newspaper subscriptions for others; organization of fashion shows for promotional purposes; organization of trade fairs for commercial or advertising purposes; shop window dressing; business appraisals; payroll preparation; data search in computer files for others; sponsorship search; business management assistance; commercial or industrial management assistance; presentation of goods on communication media, for retail purposes; economic forecasting; auctioneering; retail or wholesale services for pharmaceutical, veterinary and sanitary preparations and medical supplies; sales promotion for others; production of advertising films; office machines and equipment rental; rental of advertising time on communication media; publicity material rental; rental of vending machines; rental of photocopying machines; publication of publicity texts; radio advertising; bill-posting; distribution of samp-

les; dissemination of advertising matter; direct mail advertising; writing of publicity texts; advertising; on-line advertising on a computer network; advertising by mail order; television advertising; document reproduction; compilation of information into computer databases; compilation of statistics; business inquiries; systemization of information into computer databases; advisory services for business management; tax preparation; drawing up of statements of accounts; publicity columns preparation; telemarketing services; psychological testing for the selection of personnel; business management of hotels; commercial administration of the licensing of the goods and services of others; administrative processing of purchase orders; public relations; modelling for advertising or sales promotion; typing; relocation services for businesses; price comparison services; secretarial services; procurement services for others [purchasing goods and services for other businesses]; shorthand; outsourcing services [business assistance]; telephone answering for unavailable subscribers; photocopying services; retail or wholesale services using telemarkets and Internet sites.

(260) AM 2015 76353 A
 (800) 1194251
 (891) 2014 02 04
 (731) JOPEN, LLC
 14211 Ramona Avenue, Chino CA 91710,
 US
 (540)

JOPEN

(511)
 10 – Adult sexual stimulation aids, namely, vibrators.

(260) AM 2015 76375 A
 (800) 1194410
 (891) 2013 10 17
 (731) Gesellschaft mit beschränkter Haftung
 "EHRMANN"
 pos. RAOS, 15, Ramenskiy r-n, RU-140025
 Moscow Region, RU
 (540)



(591) Green, light green, dark green, azure, dark azure, blue, yellow, light yellow, light orange, light orange, red, light red, white, light gray, purple and beige

(511)
29 – Milk products, namely yoghurt, drinking yogurt, dessert quark, quark products with fruit, milk-based and cream-based desserts, milk-based and cream-based desserts with addition of fruit filling, milk-based and cream-based buttercream.

(260) AM 2015 76376 A
(800) 1194411
(891) 2013 10 17
(731) Gesellschaft mit beschränkter Haftung
"EHRMANN"
pos. RAOS, 15, Ramenskiy r-n, RU-140025
Moscow Region, RU

(540)



(591) Lilac, light lilac, dark lilac, yellow, light yellow, light orange, blue, white, light grey, red, light red, light green, dark green, purple and beige

(511)
29 – Milk products, namely yoghurt, drinking yogurt, dessert quark, quark products with fruit, milk-based and cream-based desserts, milk-based and cream-based desserts with addition of fruit filling, milk-based and cream-based buttercream.

(260) AM 2015 76377 A
(800) 1194412
(891) 2013 10 17
(731) Gesellschaft mit beschränkter Haftung
"EHRMANN"
pos. RAOS, 15, Ramenskiy r-n, RU-140025
Moscow Region, RU

(540)



(591) Azure, dark azure, light azure, blue, red, light red, pink, green, light green, dark green, black, brown, light brown, white, beige and yellow

(511)
29 – Milk products, namely yoghurt, drinking yogurt, dessert quark, quark products with fruit, milk based and cream based desserts, milk based and cream based desserts with addition of fruit filling, milk based and cream based buttercream.

(260) AM 2015 76378 A
(800) 1194413
(891) 2013 10 17
(731) Gesellschaft mit beschränkter Haftung
"EHRMANN"
pos. RAOS, 15, Ramenskiy r-n, RU-140025
Moscow Region, RU

(540)



(591) Azure, light azure, dark azure, blue, yellow, light yellow, white, light gray, beige, orange, light orange, red, light red, light green, dark green and purple

(511)
29 – Milk products, namely yoghurt, drinking yogurt, dessert quark, quark products with fruit, milk based and cream based desserts, milk based and cream based desserts with addition of fruit filling, milk based and cream based buttercream.

(260) AM 2015 76411 A
(800) 1194665
(891) 2014 01 07
(731) BAYER INTELLECTUAL PROPERTY
GMBH
Alfred-Nobel-Straße 10, 40789 Monheim am
Rhein, DE

(540)

KOTRUMIS

(511)
5 – Pharmaceutical preparations.

(260) AM 2015 76412 A
(800) 1194667
(891) 2014 01 07
(731) BAYER INTELLECTUAL PROPERTY
GMBH
Alfred-Nobel-Straße 10, 40789 Monheim am
Rhein, DE

(540)

TRUSATTO

(511)
5 – Pharmaceutical preparations.

(260) AM 2015 76414 A
(800) 1194736
(891) 2013 11 12
(731) BLUE ANT AG c/o TREUCO AG
Claridenstrasse 25, CH-8002 Zürich, CH
(540)



**NOT FOR ALL
LIFE IS DRIVE**

(591) Black, white
(511)
5 – Beverages for medical use, containing lecithin, vitamins or other tonic substances; foodstuffs and dietetic products for medical use, tonic and stimulating preparations for medical use; food supplements for medical use; lithia waters for medical use; isotonic beverages for medical use; mineral waters (Selters) for medical use; energy drinks for medical use.

32 – Isotonic and ionic waters; vitamin beverages; natural or artificial mineral waters; aerated beverages and other non-alcoholic beverages; fruit and vegetable beverages as well as fruit and vegetable juices; non-alcoholic aperitifs; lemonades; grape must; apple juices; non-alcoholic cocktails; lithia waters; milk of almonds (beverage); must; non-alcoholic beverages; whey-based beverages; non-alcoholic fruit extracts; non-alcoholic fruit nectars; syrups; non-alcoholic orgeat; beer wort; tomato juices and beverages; mineral waters (Selters); syrups for making beverages; grenadine syrups; malted beverages; malt beer; heavy and light beers; table waters; sherbets (beverages); carbonated waters; ginger lemonades; sparkling waters.

33 – Alcoholic essences; alcoholic fruit extracts; alcoholic extracts; anise (liqueur); aperitifs; arrack [arak]; arrack liqueurs; brandy; curaçao (orange liqueur); digesters (bitter, liqueurs and spirits); spirit essences; gin; cherry liqueur; alcoholic ciders; alcoholic cocktails; spirits, liqueurs; piquette; mead [hydromel]; peppermint liqueur; distilled beverages; rum; rice alcohol; sake; rice wine; wine; whisky; alcoholic beverages; vodka; peppermint liqueurs.

(260) AM 2015 76415 A
(800) 1194759
(891) 2013 12 24
(731) Obschestvo s ogranichennoy otvetstvennostyu "FISSMAN BIOEKOLISTIK"
1-y Magistralny tupik, d. 11, str.1, RU-123290
Moscow, RU

(540)
FISSMAN BIOECOLISTIC

(511)
8 – Table forks; sharpening instruments; ladles for wine; spoons; cheese slicers, non-electric; egg slicers, non-electric; pizza cutters, non-electric; scaling knives; can openers, non-electric; knives; scissors; vegetable slicers; table cutlery [knives, forks and spoons]; silver plate [knives, forks and spoons].

21 – Dishes; vases; cruets; cutting boards for the kitchen; containers for household or kitchen use; heat-insulated containers for beverages; thermally insulated containers for food; stew-pans; bread baskets, domestic; cauldrons; dish covers; pitchers; basting spoons, for kitchen use; mixing spoons [kitchen utensils]; bowls [basins]; cooking pot sets; trays for domestic purposes; pots; cooking pots; pressure cookers [autoclaves], non-electric; tableware, other than knives, forks and spoons; hot pots, not electrically heated; kitchen utensils; cooking utensils, non-electric; molds [kitchen utensils]; cake molds [moulds]; ice cube molds [moulds]; cookery molds [moulds]; deep fryers, non-electric; teapots; kettles, non-electric; frying pans.

35 – Import-export agencies; commercial information agencies; demonstration of goods; marketing studies; business investigations; marketing research; organization of exhibitions for commercial or advertising purposes; organization of trade fairs for commercial or advertising purposes; shop window dressing; data search in computer files for others; commercial or industrial management assistance; presentation of goods on communication media, for retail purposes; auctioneering; sales promotion for others; rental of vending machines; distribution of samples; compilation of information into computer databases; administrative processing of purchase orders; modelling for advertising or sales promotion; procurement services for others [purchasing goods and services for other businesses].

(260) AM 2015 76416 A
(800) 1194791
(891) 2014 02 12
(731) PHARMATON SA
Via Mulini, CH-6934 Bioggio, CH
(540)

PHARMATON VITALITY

(511)
5 – Pharmaceutical products; dietetic foodstuffs and products for medical use; dietetic foodstuffs and food supplements.

(260) AM 2015 76418 A
(800) 1194798
(891) 2013 12 17

(731) Limited liability company "ALMAZNY VENETZ"
Leninsky avenue, 4, bldg. 1A, RU-119049
Moscow, RU

(540)



(591) Black and light brown

(511)

44 – Manicuring; massage; hairdressing salons; beauty salons; tattooing; solarium services; visagists' services.

(260) AM 2015 76419 A

(800) 1194815

(891) 2013 08 27

(731) ZIMING YANG

Nieder-Ramstaedter-Str. 47, 64367 Mühlthal, DE

(540)



(591) Black, white

(511)

9 – Apparatus and instruments for conducting, switching, transforming, accumulating, regulating and controlling of electricity; electrical and electronic facilities, appliances, apparatus and equipment for the operation, regulation and control of lights, lamps, small transformers, inductors, light emitting diodes and electroluminescent foils; electronic circuits for the operation of light emitting diodes; electronic equipment for light controls and shade controls, switch modules, signal converters, sensors, motion detectors; dimmers, dimmable ballasts for fluorescent lamps, gas discharge lamps and light emitting diodes; electronic displays, as well as LED (light emitting diode) displays, as controls; or terminals of such facilities, equipment, apparatus, computers and software; constant voltage and constant current converter and controller for powering LEDs; light control installations; power connectors; organic and/or inorganic light emitting diodes; laser diodes; illuminated advertising apparatus, illuminated letters, neon signs; light guides, optical couplers, light barrier; LED panels, modules, networks, strands, lamp modules, transformers, drivers and power supplies; magnetic and electronic ballasts and ignition devices for lamps and luminaries, electronic starter for lamps and luminaries; magnetic and electronic transformers; microcontroller, integrated circuits and application specific integrated circuits; connectors;

clamps (electricity), terminal strips, sockets, switches, interrupters; cables; junction boxes, cable connection boxes, neutral bars and busbars grommets; parts and accessories of all the aforesaid goods included in class 9.

11 – Lighting apparatus, especially electric lamps and luminaries; lighting devices, lighting facilities and lighting apparatus; lighting apparatus and lighting facilities based on LED (light emitting diode), LED luminaries and LED lamps; led modules and luminaries with LEDs as illuminants; incandescent lamps, halogen lamps, fluorescent lamps, compact fluorescent lamps, discharge lamps, special spotlights, ultraviolet lamps, lamps for solariums, cosmetic irradiation equipment and lighting equipments, included in this class; luminaries and lightings of all kinds; parts and accessories of all the aforesaid goods included in this class.

35 – Wholesale services and retail sale services with all the aforesaid goods in class 9 and 11; advertising; organization of exhibitions and trade fairs for commercial and advertising purposes; distribution of leaflets, postcards, printed material and product samples for advertising purposes; business administration; business management; office functions.

(260) AM 2015 76422 A

(800) 1194844

(891) 2013 01 22

(731) J. BARBOUR & SONS LIMITED

Simonside, South Shields, Tyne and Wear
NE34 9PD, GB

(540)

BARBOUR

(511)

1 – Waterproofing preparations and compounds.

3 – Soaps; perfumery, essential oils, cosmetics, hair lotions; dentifrices; perfume; wax compositions for leather and fabric.

9 – Spectacles; sunglasses; binoculars; cases for mobile phones; cases for MP3 players; cases for laptop computers; cases for tablet computers; parts and fittings for all the aforesaid goods.

12 – Vehicles; apparatus for locomotion by land or water; parts and fittings for all the aforesaid goods.

14 – Jewellery; costume jewellery; cuff links; tie pins; horological and chronometric instruments; clocks and watches; parts and fittings for all the aforesaid goods.

16 – Books; printed matter; stationery; photographs; advertising material; brochures and printed publications; leather covers for passports.

18 – Dog coats; dog coats treated with wax; quilted dog coats; wallets (made of leather); purses (made of

leather); suit carriers; bags; cartridge bags; back packs; luggage; luggage bags; toiletry bags; handbags; wallets; purses; shoulder bags; briefcases; bags, cartridge bags, back packs, luggage, luggage bags, toiletry bags, handbags, wallets, purses, shoulder bags, briefcases, (all coated with wax); bags, cartridge bags, back packs, luggage, luggage bags, toiletry bags, handbags, wallets, purses, shoulder bags, briefcases (all made of quilted material); bags, cartridge bags, back packs, luggage, luggage bags, toiletry bags, handbags, wallets, purses, shoulder bags, briefcases (all made of leather); bags, cartridge bags, back packs, luggage, luggage bags, toiletry bags, handbags, wallets, purses, shoulder bags, briefcases (all made of suede); umbrellas.

21 – Mugs; cups; teacups; saucers; teapots; crockery; articles made of ceramics, glass, porcelain or earthenware which are not included in other classes.

24 – Handkerchiefs; textile and textile goods; travel rugs; textiles for making articles of clothing.

25 – Articles of clothing; articles of outer clothing; articles of clothing coated with wax; articles of clothing made from quilted material; articles of waterproof clothing; coats; coats coated with wax; coats made from quilted material; jackets; jackets coated with wax; jackets made from quilted material; fleeces; duffle coats; tweed coats; tweed jackets; capes; blousons; vests; liners; mackintoshes; blazers; waistcoats; waistcoats coated with wax; waistcoats made from quilted material; body warmers; body warmers coated with wax; body warmers made from quilted material; gilets; gilets coated with wax; gilets made from quilted material; sweaters; pullovers; jumpers; cardigans; shorts; jodhpurs; riding breeches; trousers; denim trousers; corduroy trousers; trousers coated with wax; leggings; leggings coated with wax; breeks; breeks coated with wax; over trousers; over trousers coated with wax; jeans; shirts; shirts (long sleeved); shirts (short sleeved); t-shirts; t-shirts (long sleeved); t-shirts (short sleeved) polo shirts; polo shirts (short sleeved); polo shirts (long sleeved); polo-necks; rugby shirts; hats; hats made of leather; hats made of wool; tweed hats; hats coated with wax; caps; caps coated with wax; hoods; hoods for jackets; hoods for coats; hoods coated with wax; scarves; rain chokers in the range of cravats; cravats; bow ties; socks; gun stockings; gun sock garters; flashes; gloves; inner gloves; gloves made of leather; mittens; fingerless gloves; belts (made of fabric); belts (made of leather); ties; ties made of silk; footwear; shoes; boots; riding boots; walking boots; waterproof boots; waterproof shoes; wellington boots; gaiters; gaiters (coated with wax); gaiter straps; bags for footwear; leather gloves; leather hats; leather jackets; leather coats; belts (made of leather); articles of clothing for sporting activity; gloves (clothing) for outdoor pursuits such as shooting, fishing and hunting.

26 – Badges; badges for wear; badges made of metal; buttons; buttons for wear; buttons being fastenings; buttons for attachment to clothing; buttons for sewing.

28 – Games; toys; sporting articles.

35 – Retail services connected with the sale of all goods mentioned above.

37 – Cleaning, repair and renovation of clothing.

39 – Transport, packaging of goods, storage of goods.

40 – Alteration and custom manufacture of clothing; waterproofing of clothing and of fabrics; re-waterproofing of clothing and of fabrics.

41 – Organising of sporting activities; organising of cultural activities.

(260) AM 2015 76423 A

(800) 1194881

(891) 2013 09 14

(731) MARINASUN CELLULOSE INDUSTRIAL CO.
No:1, T floor, 3rd Building, Eskan Complex,
Mirdamad Blvd., Valeie Asr Ave., Tehran, IR
(540)



(591) Dark blue, gray and light blue

(511)

5 – Sanitary napkins, menstruation tampons, babies' diapers of paper and cellulose.

16 – Napkins of paper, handkerchiefs of paper, toilet paper, towels of paper, scented paper; all the aforementioned goods of cellulose and paper.

(260) AM 2015 76426 A

(800) 1194899

(891) 2013 09 09

(731) Limited Liability Company "VMPAUTO"
40, lit. A, ulitsa Promyshlennaya, RU-198099
Saint-Petersburg, RU
(540)



(591) Black, white, red, grey
(511)

1 – Antifreeze; oil dispersants; detergent additives to petrol; additives, chemical, to motor fuel; chemical additives for greases, including greases for vehicles suitable for protection and renovation of metal friction surfaces; fluids for hydraulic circuits; brake fluid; transmission fluid; engine-decarbonising chemicals; fuel-saving preparations; silicones; renovating compositions and preparations for metal friction surfaces, including remetalizing agent; compositions for inner tubes of tires repairing; tire repairing compositions; purifying chemicals for radiators; oil-purifying chemicals.

2 – Protective preparations for metals; anti-corrosive preparations for metals; metals in powder form for decorators; anti-corrosive preparations; anti-rust greases; anti-tarnishing preparations for metals; anti-rust preparations for preservation.

3 – Abrasives and abrasive materials; polishing or shining preparations, including polishing pastes; rust removing preparations; cleaning agents for vehicles including car care products, namely windscreen cleaning liquids, anti-fog liquids, car lock deicers; cleaning agents for the outer surfaces vehicles, including car polishing pastes and car polishing detergents other than for use in manufacturing operations and for medical purposes, including car shampoos, products for car interior cleaning, including car leather upholstery, carburetor cleaner preparations, injector cleaners, engine cleaners; cosmetics, including cosmetic creams soap, including liquid soap; cosmetic kits; polishing pastes; toiletries; skin care cosmetic preparations; hand care cosmetic preparations, including creams, gels, beauty masks and scrubs; dry hand cleansers; perfumery; laundry bleach; bleaching preparations; degreasers; dry-cleaning preparations; lacquer and paints-removing preparations; cleaning preparations; stain-removing preparations; detergents and degreasers other than for use in manufacturing operations and for medical purposes.

4 – Additives, non-chemical, to greases for protection and renovation of metal friction surfaces; additives, non-chemical, to greases for vehicles suitable for protection and renovation of metal friction surfaces, including remetalizing agent; lubricating oil; Industrial oil; moistening oil; motor oil; lubricants; lubricants for protection and renovation of metal friction surfaces; lubricating grease; silicon grease.

(260) AM 2015 76427 A

(800) 1194900

(891) 2013 10 01

(731) CEYHUN BAHRAM OGLI

MAHARRAMOV

ap. 2, impasse 9, Ak. Shamil Azizbeyov str.,
Yasamal district, AZ-1009 Baku, AZ

(540)



(591) Red, yellow, blue, white

(511)

43 – Services for providing food and drink.

(260) AM 2015 76430 A

(800) 1194922

(891) 2013 09 26

(731) VANGUARD TRADEMARK HOLDINGS
USA LLC

600 Corporate Park Drive, St. Louis MO
63105, US

(540)



(591) Black, white

(511)

39 – Automobile rental and leasing services; reservation services for the rental and leasing of vehicles.

(260) AM 2015 76431 A

(800) 1194974

(891) 2013 12 20

(731) KRKA

tovarna zdravil, d.d. Novo mesto
Šmarješka cesta 6, SI-8501 Novo mesto, SI

(540)

MOFLAXA

(511)

5 – Pharmaceutical preparations.

(260) AM 2015 76433 A

(800) 1194995

(891) 2014 01 07

(731) BAYER INTELLECTUAL PROPERTY
GMBH

Alfred-Nobel-Straße 10, 40789 Monheim am
Rhein, DE

(540)

Стиварга

(511)

5 – Pharmaceutical preparations and substances.

- (260) AM 2015 76437 A
 (800) 1195010
 (891) 2013 12 30
 (731) Limited Liability Company "INTERNET
 COMPANY MAIL.RU"
 Leningradsky pr-kt, d. 39, str. 79, RU-125167
 Moscow, RU
 (540)



- (591) Black, white
 (511)

9 – Video cassettes; video game cartridges; compact discs [audio-video]; compact discs [read-only memory]; magnetic data media; optical data media; computer software, recorded; computer programmes [programs], recorded; computer game software; computer programs [downloadable software]; computer operating programs, recorded; downloadable image files; downloadable music files; animated cartoons; USB flash drives.

16 – Almanacs; atlases; posters; pamphlets; booklets; newsletters; newspapers; engravings; magazines [periodicals]; periodicals; printed publications; graphic representations; calendars; geographical maps; catalogues; books; comic books; lithographs; graphic prints; greeting cards; postcards; printed matter; prospectuses; manuals [handbooks]; photographs [printed].

28 – Arcade video game machines; video game machines; gaming machines for gambling; amusement machines, automatic and coin-operated; jigsaw puzzles; toys; mobiles [toys]; parlor games; board games; games; building games; playing cards; scale model kits [toys]; portable games with liquid crystal displays; apparatus for games.

35 – Rental of advertising space; computerized file management; demonstration of goods; opinion polling; marketing studies; business investigations; marketing research; news clipping services; updating of advertising material; organization of exhibitions for commercial or advertising purposes; organization of trade fairs for commercial or advertising purposes; shop window dressing; data search in computer files for others; commercial or industrial management assistance; presentation of goods on communication media, for retail purposes; auctioneering; sales promotion for others; production of advertising films; rental of advertising time on communication media; publicity material rental; publication of publicity texts; radio advertising; bill-posting; dissemination of advertising matter; direct mail advertising; advertising; on-line advertising on a computer network; advertising by mail order; television advertising; compilation of information into computer da-

tabases; systemization of information into computer databases; publicity columns preparation; administrative processing of purchase orders; public relations.

38 – News agencies; television broadcasting; cable television broadcasting; electronic bulletin board services [telecommunications services]; information about telecommunication; providing user access to global computer networks; providing access to databases; providing internet chatrooms; providing telecommunications connections to a global computer network; providing telecommunication channels for teleshopping services; transmission of greeting cards online; message sending; computer aided transmission of messages and images; transmission of digital files; electronic mail; providing online forums; rental of access time to global computer networks; radio broadcasting; communications by fiber [fibre] optic networks; cellular telephone communication; communications by computer terminals; communications by telephone; paging services [radio, telephone or other means of electronic communication]; teleconferencing services; voice mail services; telephone services.

41 – Booking of seats for shows; videotaping; gambling; publication of books; education information; recreation information; entertainment information; health club services [health and fitness training]; night clubs; layout services, other than for advertising purposes; videotape editing; game services provided on-line from a computer network; providing on-line electronic publications, not downloadable; practical training [demonstration]; organization of exhibitions for cultural or educational purposes; providing recreation facilities; arranging and conducting of colloquiums; arranging and conducting of conferences; arranging and conducting of workshops [training]; arranging and conducting of seminars; organization of competitions [education or entertainment]; operating lotteries; television entertainment; videotape film production; rental of videotapes; rental of sound recordings; publication of electronic books and journals online; publication of texts, other than publicity texts; radio entertainment; entertainer services; entertainment; writing of texts, other than publicity texts; news reporters services; party planning [entertainment]; providing casino facilities [gambling]; club services [entertainment or education]; teaching; recording studio services; photography; production of shows.

42 – Computer system analysis; recovery of computer data; computer virus protection services; installation of computer software; information technology [IT] consultancy; consultancy in the design and development of computer hardware; computer software consultancy; updating of computer software; maintenance of computer software; providing search engines for the internet; data conversion of computer

programs and data [not physical conversion]; computer system design; computer rental; rental of computer software; hosting computer sites [web sites]; server hosting; duplication of computer programs; computer software design; creating and maintaining web sites for others; computer programming.

45 – Missing person investigations; personal background investigations; dating services.

(260) AM 2015 76438 A

(800) 1195020

(891) 2014 01 15

(731) ODYSSEA PHARMA S.P.R.L.

Rue du Travail 16, B-4460 Grace-Hollogne, BE

(540)

ДОНАСЕРТ

(511)

5 – Contraceptive pharmaceutical preparations; pharmaceutical preparations in the gynecological field and for women health.

10 – Surgical and medical apparatus and instruments; intra-uterine (non-chemical) contraceptive devices, IUDs (intra-uterine contraceptive devices).

(260) AM 2015 76440 A

(800) 1195023

(891) 2014 02 17

(731) FERRING B.V.

Polarisavenue 144 NL-2132 JX Hoofddorp, NL

(540)

MISODEL

(511)

5 – Pharmaceuticals for gynaecological and obstetric use; pharmaceuticals for the treatment of women in pregnancy and labour.

(260) AM 2015 76442 A

(800) 1195040

(891) 2013 09 24

(731) PRIVATE JOINT STOCK COMPANY

"INDUSTRIAL ASSOCIATION "KONTI"

Bul. Shevchenko, 6-b Donetsk 83015,UA

(540)

Артемон

(511)

30 – Coffee, tea, cocoa and artificial coffee; rice; tapioca and sago; flour and preparations made from cereals; bread, pastry and confectionery; ices; sugar, honey, treacle; yeast, baking-powder; salt; mustard; vinegar, sauces (condiments); spices; ice; aniseed; peanut confectionery; high-protein cereal bars; baking soda (bicarbonate of soda for cooking purposes); soya bean paste (condiment); bean meal; star aniseed; tapioca flour for food; flour; flour-milling

products; bread rolls; buns; sandwiches; vanillin (vanilla substitute); vanilla (flavoring); waffles; vermicelli (noodles); cream of tartar for culinary purposes; farinaceous foods; oatmeal; oat flakes; oat-based food; sea water for cooking; seaweed (condiment); binding agents for ice cream (edible ices); biscuits; cloves (spice); mustard meal; cake frosting (icing); glucose for culinary purposes; relish (condiment); gluten additives for culinary purposes; essences for foodstuffs, except etheric essences and essential oils; fruit jellies (confectionery); chewing gum; custard; leaven; rice-based snack food; cereal-based snack food; frozen yogurt (confectionery ices); frozen kefir (confectionery ices); flavorings, other than essential oils, for beverages; flavorings, other than essential oils, for cakes; flavorings, other than essential oils; wheat germ for human consumption; preparations for stiffening whipped cream; thickening agents for cooking foodstuffs; chips (cereal products); ginger (spice); unroasted coffee; coffee flavorings; coffee-based beverages; coffee beverages with milk; vegetal preparations for use as coffee substitutes; cocoa beverages with milk; cocoa-based beverages; cocoa-based ingredients for confectionery products, cocoa, cocoa mixes, cocoa powder, cocoa spreads; capers; caramels (candy); lozenges (confectionery); curry (spice); potato flour for food; ketchup (sauce); gluten prepared as foodstuff; sugar confectionery; tortillas; cinnamon (spice); starch for food; hominy grits; groats for human food; corn, milled; corn, roasted; corn flour; pop corn; corn flakes; turmeric for food; couscous (semolina); salt for preserving foodstuffs; confectionery for decorating Christmas trees; edible ices; ice for refreshment; ice, natural or artificial; liquorice (confectionery); noodles; candy; flaxseed for human consumption; mayonnaise; macaroni; maltose; hominy; chow-chow (condiment); marinades; marzipan; royal jelly; honey; molasses for food; macaroons (pastry); almond paste; almond confectionery; pancakes; spring rolls; gruel, with a milk base, for food; ice-cream; dessert mousses (confectionery); chocolate mousses; nutmegs; muesli; meat gravies; meat tenderizers, for household purposes; mint for confectionery; peppermint sweets; infusions, not medicinal; husked oats; ravioli; pepper; pesto (sauce); beer vinegar; quiches; sweetmeats (candy); pizzas; pies; fondants (confectionery); powder for edible ices; pralines; condiments; dressings for salad; seasonings; unleavened bread; bee glue; gingerbread; puddings; cake powder; fruit coulis (sauces); rice cakes; baking powder; ferments for pastes; sago; garden herbs, preserved (seasonings); celery salt; golden syrup; salt for preserving foodstuffs; soya flour; soya sauce; malt for human consumption; malt biscuits; malt extract for food; tomato sauce; spaghetti; noodle based prepared meals; ham glaze; rusks; breadcrumbs; petit-beurre biscuits; sushi; tabbouleh; tacos; tapioca; petits fours (cakes); crackers; cake paste; tarts; sorbets (ices);

halvah; bread; chicory (coffee substitute); iced tea; tea-based beverages; chutneys (condiments); saffron (seasoning); chocolate; barley meal; crushed barley.

(260) AM 2015 76443 A

(800) 1195053

(891) 2013 12 17

(731) Auxionize OOD

10 Bogdan Tomalevski St., Mladost 4,
BG-1715 Sofia, BG

(540)

auxionize

(591) Black, white

(511)

35 – Auctioneering; arranging and conducting online auctions.

(260) AM 2015 76485 A

(800) 1090527

(891) 2013 02 28

(731) ASTELLAS PHARMA EUROPE B.V.

Sylviusweg 62 NL-2333 BE Leiden, NL

(540)

DIFICLIR

(511)

5 – Pharmaceutical preparations and substances; pharmaceutical products and substances; pharmaceutical preparations and substances for medical use; pharmaceutical products and substances for medical use.

42 – Scientific and technological services and research and design relating thereto.

44 – Medical services.

(260) AM 2015 76492 A

(800) 1195377

(891) 2013 08 02

(731) YASEMİN ERGİNO

Harmandere Mahallesi, Reyhan Caddesi,
Ekşioğlu Modern Birkent Sitesi No:54/14,
P Blok D:17, Kurtköy – İstanbul, TR

(540)

ergino

(591) Grey, black and white

(511)

9 – Apparatus and instruments used for measurement for scientific purposes and used in laboratory, apparatus for recording, transmission or reproduction of sound and images including data processing apparatus, communication devices, computer software and hardware; computer memories, computer

networks; magnetic and optical data media and exposed camera films; antennas, satellite dishes, satellite receivers, amplifiers and their parts; ticket dispensers, cash dispensers; electronic devices used in machines and devices, electronic semi-conductors, electronic integrated circuits, electronic chips; electric meters, water meters, gas meters, counters and timers used for measuring the consumption in a unit of time; protective clothing, life saving and protecting equipments; eyeglasses, sun glasses, lenses and their boxes, cases, parts and accessories; apparatus and instruments for transmitting, converting and storing electrical energy including cables and power supplies used in electric and electronic; electric plugs, electric sockets, electric junction boxes, electric switches, circuit breakers, electrical fuses, lighting ballasts, electric control panels, electronic controller panels to manage the power, movement and functions of an elevators, electric connectors and sockets; adaptors for use with portable electronic devices and battery chargers, electric wires and cables, fiber optic cables used in electrics, electronics and telephone lines, electrical power supplies, electrical accumulators batteries, solar cells, uninterruptible power supplies for computers; anodes, cathodes; electric door bells, alarms other than vehicle alarms; traffic signalization equipment; fire-extinguishing apparatus; radars, submarine radars (sonars), night vision providing and increasing devices and apparatus, namely, night vision goggles; magnets, decorative magnets.

11 – Lighting installations, lighting apparatus for vehicles, interior and exterior lights; lamps; devices for heating and vapor producing installations, stoves (heating apparatus), heating apparatus for solid, liquid or gaseous fuels, cookers; heat exchangers not being parts of machines; coils as parts of heating or cooling installations; air-conditioning installations and apparatus, fans (air-conditioning), ventilators, air-conditioning apparatus including for vehicles; air sterilisers and purifying devices, installations and their parts and accessories for residences; refrigerators, deep freezers; evaporative air coolers; electric and gas operated apparatus, machines and equipment used in cooking and boiling, namely, toasters, bread toasters, deep fryers, grills, ovens, stoves, water boilers (kettles) and their parts; clothes drying machines (electric, for household purposes), electric hair-dryers, hand drying apparatus for washrooms; bath tubs, bidets, bath installations, shower enclosures, urinals (sanitary fixtures) water closets, toilets, portable; lavatories, sinks, taps (faucets) for water and gas installations, hand-held shower heads, flexible pipes being parts of shower plumbing installations; automatic watering installations, water-pipes for sanitary installations, watering machines for agricultural purposes; water softening apparatus and installations, water purifying apparatus and machines, water purification installations, incinera-

tors, water purifiers; bedwarmers and blankets, electric, not for medical purposes; electric heating pads and cushions, not for medical purposes; electric footwarmers; footmuffs, electrically heated; hot water bottles; aquarium filters, filtration apparatus incorporating a motor device; aquarium heaters and lights; industrial type furnaces; industrial type dryer installations; industrial type cooling installations, cooling towers, air cooling apparatus; pasteurisers and sterilizers.

35 – Advertising; business management; business administration; office functions; the bringing together, for the benefit of others, of lighting apparatus and installations, chandeliers, electric plugs, electric sockets, electric cables, electric switches, control panels for electricity, electric fuses, bells, junction boxes for electricity, time switches, enabling customers to conveniently view and purchase those goods; all of the aforementioned retail services may be provided by retail stores, wholesale outlets, through mail order catalogues or by means of electronic media, including, through web sites or television shopping programmes.

(260) AM 2015 76493 A

(800) 1195406

(891) 2013 10 04

(731) WORLD MEDICINE İLAÇ SANAYİ VE TİCARET LİMİTED ŞİRKETİ
Evren Mahallesi Cami Yolu Caddesi No:50
Kat 1 B Zemin 4-5-6, Güneşli Bağcılar
İSTANBUL, TR

(540)

LEVEBRAIN
ЛЕВЕБРЕЙН

(591) Black, white

(511)

5 – Medicines for human purposes, medicines for veterinary purposes, vitamins, chemical preparations for medical purposes, dietetic substances adapted for medical use; dietetic foods adapted for medical purposes; aminoacids for medical purposes, nutritional supplements, pollen dietary substances, mineral food supplements, protein dietary supplements, baby foods, medicinal herbs, herbal beverages adapted for medical purposes; medicines for dental purposes, hygienic products for medical purposes including pads, waddings for medical purposes, plasters for medical purposes, dressings for medical purposes; preparations for destroying noxious plants, preparations for destroying noxious animals, fungicides; deodorants other than for human beings or for animals; air deodorising preparations; disinfectants for hygiene purposes, antiseptics, detergents for medical purposes.

(260) AM 2015 76494 A

(800) 1195420

(891) 2014 01 08

(731) LE VIAN CORP.

235 Great Neck Road Great Neck NY 11021, US

(540)

LE VIAN

(511)

14 – Bangles; bracelets; cufflinks; diamond jewelry; diamonds; earrings; gems; gemstone jewelry; jewelry; necklaces; pendants; pins being jewelry; rings; watches.

(260) AM 2015 76496 A

(800) 1195452

(891) 2014 01 24

(731) BAYER INTELLECTUAL PROPERTY
GMBH

Alfred-Nobel-Straße 10, 40789 Monheim am
Rhein, DE

(540)

GOTRINGO

(511)

5 – Pharmaceutical preparations.

(260) AM 2015 76502 A

(800) 1195519

(891) 2013 09 27

(731) Public Joint-Stock Company "NORD"

prosp. Zhukovskoho, 2, m. Donetsk 83112, UA

(540)

NORD

(591) Black, white

(511)

2 – Paints.

6 – Building metal panels; paint spray booths of metal.

7 – Washing machines (laundry); dishwashers; compressors for refrigerators; motors, electric, other than for land vehicles; coffee grinders, other than hand-operated; vacuum cleaners; wringing machines for laundry; fruit presses, electric, for household purposes; bread cutting machines; air suction machines; crushing machines; separators; food processors, electric; blenders, electric, for household purposes; control mechanisms for machines, engines or motors; meat choppers (machines); painting machines; ironing machines; smoothing presses.

9 – Relays, electric; television apparatus; radios; vehicle radios; cameras photography; video telephones; camcorders; video cassettes.

11 – Air conditioning apparatus; coffee machines, electric; water heaters; kettles, electric; hair driers;

heat exchangers, not parts of machines; air reheaters; lamps; bakers' ovens; kitchen ranges (ovens); cookers; water purification installations; refrigerators; freezers; refrigerating cabinets; refrigerating chambers; air conditioners for vehicles; fans (parts of air-conditioning installations); extractor hoods for kitchens; cooling installations for water; cooling installations for liquids; cooling installations and machines; refrigerating appliances and installations; heating apparatus stoves (terms too vague in the opinion of the International Bureau – Rule 13(2)(b) of the Common Regulations); gas generators (installations) (terms too vague in the opinion of the International Bureau – Rule 13(2)(b) of the Common Regulations).

21 – Refrigerating bottles; ice cube molds; food cooling devices containing heat exchange fluids, for household purposes.

37 – Freezing equipment installation and repair; electric appliance installation and repair.

39 – Storage of goods.

(260) AM 2015 76543 A
 (800) 1195983
 (891) 2014 01 07
 (731) R & D EXPRESS AUSSENHANDELS
 GMBH
 Daimler-Benz-Str. 2a 76287 Rheinstetten, DE
 (540)

Chevalier de Bur

(511)
 33 – Alcoholic beverages (except beers), especially wine and sparkling wine.

(260) AM 2015 76563 A
 (800) 1196132
 (891) 2013 12 19
 (731) Bardahl Manufacturing Corporation
 P.O. Box 70607, Seattle, Washington
 98127-0607, US
 (540)



(591) Black, white
 (511)
 1 – Chemical gasoline additives, lubricating oil additives, Chemical motor oil additives.
 4 – Motor oil and oils for industrial use.

(260) AM 2015 76565 A
 (800) 1196148
 (891) 2013 09 11
 (731) CERSANIT TRADE MARK Sp. z o.o.
 ul. Al. Solidarności 36, PL-25-323 Kielce, PL
 (540)

IVS

(511)
 11 – Sanitary and bath apparatus and installations made of ceramics, bathroom ceramics, bidets, toilets with cisterns, toilet pans, urinals; wash basins, as parts of sanitary installations; wash basin pedestals, toilet seats, water flushing installations, faucets, wash basin taps, shower cubicles, sanitary fittings, bath tubs, flushing cistern.

19 – Tiles and carpet strips not of metal, ceramic tiles, wall tiles, floor tiles, terra cotta.

20 – Shelves, mirrors, bathroom furniture.

(260) AM 2015 76571 A
 (800) 1196193
 (891) 2013 11 21
 (731) ACTAVIS GROUP PTC EHF
 Reykjavikurvegi 76-78, IS-220 Hafnarfjordur, IS
 (540)

PINFECT

(511)
 5 – Pharmaceutical preparations and substances.

(260) AM 2015 76572 A
 (800) 1196194
 (891) 2013 11 21
 (731) ACTAVIS GROUP PTC EHF
 Reykjavikurvegi 76-78, IS-220 Hafnarfjordur, IS
 (540)

PINADERE

(511)
 5 – Pharmaceutical preparations and substances.

(260) AM 2015 76573 A
 (800) 1196187
 (891) 2013 10 31
 (731) OPEN JOINT-STOCK COMPANY
 "RUSSIAN HELICOPTERS"
 Vereyskaya str., 29, 141, RU-121357
 Moscow, RU
 (540)



(591) Burgundy and grey

(511)

12 – Aircraft; aeronautical apparatus, machines and appliances; hoods for vehicle engines; hub caps; ships' hulls; ejector seats for aircraft; caps for vehicle petrol [gas] tanks; propulsion mechanisms for land vehicles; upholstery for vehicles; windows for vehicles; parachutes; head-rests for vehicle seats; vehicle running boards; chairlifts; sleeping berths for vehicles; anti-theft devices for vehicles; shock absorbing springs for vehicles; reduction gears for land vehicles; safety belts for vehicle seats; vehicle suspension springs; rudders; anti-theft alarms for vehicles; reversing alarms for vehicles; vehicle seats; safety seats for children, for vehicles; hydraulic circuits for vehicles; military vehicles for transport; air vehicles; electric vehicles; ambulances; remote control vehicles, other than toys; windscreens; windscreen wipers; hubs for vehicle wheels; brakes for vehicles; torsion bars for vehicles; aerial conveyors; seat covers for vehicles; vehicle chassis; tires; vehicle wheel tires; timbers [frames] for ships.

35 – Import-export agencies; cost price analysis; business auditing; computerized file management; business efficiency expert services; demonstration of goods; marketing studies; business information; statistics information; business investigations; business management and organization consultancy; professional business consultancy; organization of exhibitions for commercial or advertising purposes; organization of trade fairs for commercial or advertising purposes; business appraisals; business management assistance; commercial or industrial management assistance; economic forecasting; auctioneering; sales promotion for others; publicity material rental; publication of publicity texts; distribution of samples; dissemination of advertising matter; advertising; business inquiries; systemization of information into computer databases; psychological testing for the selection of personnel; business management of hotels; relocation services for businesses.

37 – Motor vehicle maintenance and repair; vehicle service stations.

42 – Computer system analysis; technical project studies; engineering; material testing; mechanical research; research and development of new products for others; technical research; quality control; design of interior decor; construction drafting; industrial design; surveying.

45 – Intellectual property consultancy; intellectual property watching services; licensing of intellectual property.

(260) AM 2015 76574 A

(800) 1196215

(891) 2014 01 14

(731) HÜSEYİN ŞAHİN

Beştelsiz Mh. 101. Sk. No:29, Zeytinburnu, İSTANBUL, TR

(540)



(591) Orange, white

(511)

25 – Clothing, namely, trousers, jackets, overcoats, coats, skirts, suits, jerseys, waistcoats, shirts, T-shirts, sweatshirts, dresses, bermuda shorts, shorts, pajamas, pullovers, jeans, tracksuits, rainwear, beachwear, bathing suits, swimming suits; articles of clothing made from cotton denim, articles of clothing made from knitted fabrics, clothing for sportswear, clothing for babies; underclothing, namely, boxer shorts, brassieres, briefs, pants, socks, footwear, namely shoes (excluding orthopedic shoes), sandals, waterproof boots, walking boots, booties, sporting shoes, slippers; shoe parts namely heelpieces, insoles for footwear, footwear uppers; headgear, namely caps, skull caps, sports caps, hats, berets; gloves (clothing), stockings, belts (clothing), camisoles, sarongs, scarves, neck scarves, shawls, collars, muffler, neckties, ties, suspender belts.

(260) AM 2015 76576 A

(800) 1196223

(891) 2013 11 18

(731) MSGM Srl

Via Adige, 17, I-20135 MILANO, IT

(540)

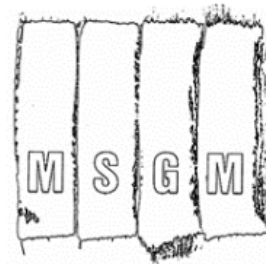

(591) Black, white

(511)

3 – Perfumes, eau de Cologne, toilet waters, preshaves and aftershave lotions, personal deodorants, face and body soaps, body lotions, shampoos, hair balm, cosmetic and make-up preparations, face and body creams, lipsticks, sunscreen creams.

9 – Eyeglasses and sunglasses and parts thereof.

14 – Rings, bracelets, brooches, necklaces, earrings, of precious metals or coated therewith; watches and clocks and parts thereof.

18 – Bags, suitcases, handbags, briefcases, backpacks, trunks, wallets, purses, waist bags, umbrellas.

25 – Clothing articles for men, women and children, namely: shirts, blouses, skirts, coats, trousers, T-shirts, pants, vests, jerseys, pajamas, socks and

stockings, singlets, corsets, garters, petticoats, hats, caps, headscarves, neckties, raincoats, overcoats, greatcoats, bathing suits, sports overalls, wind-resistant jackets, ski pants, belts, scarves, gloves, footwear, namely shoes, slippers and boots.

(260) AM 2015 76577 A

(800) 1196244

(891) 2014 02 10

(731) Zakrytoe aktsionerhoe obshchestvo
"VELES FARMA"

stroenie 1, d.6, Malaya Sukharevskaya
ploshchad, RU-127051 Moskva, RU

(540)

КАЧАЗОЛ CASPASOL

(511)

5 – Pharmaceutical preparations; sanitary preparations for medical purposes; dietetic substances adapted for medical use; dietary supplements for humans; dietetic beverages adapted for medical purposes; dietetic foods adapted for medical purposes; medical preparations for slimming purposes; appetite suppressants for medical purposes.

35 – Import-export agencies; sales promotion for others; advertising; on-line advertising on a computer network; television advertising; procurement services for others [purchasing goods and services for other businesses].

42 – Scientific and technological services and research and design relating thereto, including in the field of biology, bacteriology and pharmacy.

(260) AM 2015 76579 A

(800) 1196246

(891) 2014 02 24

(731) HERSTYLER INC.

20255 Corisco Street, Chatsworth CA 91311,
US

(540)

EVALECTRIC

(511)

8 – Electric hair curling irons; Electric hand-held hair styling irons; Electric irons for styling hair.

(260) AM 2015 76580 A

(800) 1196253

(891) 2014 01 23

(731) Obschestvo s ogranichennoy otvetstvennostyu
"LABORATORIYA SOVREMENNOGO
ZDOROVYA"

ul. Khimzavodskaya, 11/20, Berdsk,
RU-633004 Novosibirskaya oblast', RU

(540)

TRIMEGAVITALS

(511)

3 – Adhesives for cosmetic purposes; after-shave lotions; almond milk for cosmetic purposes; aloe vera preparations for cosmetic purposes; amber [perfume]; antiperspirant soap; astringents for cosmetic purposes; balms other than for medical purposes; bath salts, not for medical purposes; beauty masks; breath freshening sprays; cakes of toilet soap; cleansing milk for toilet purposes; cosmetics; cosmetic creams; cosmetic dyes; cosmetic kits; cosmetic pencils; cosmetic preparations for baths; cosmetic preparations for eyelashes; cosmetic preparations for skin care; cosmetic preparations for slimming purposes; cotton sticks for cosmetic purposes; cotton wool for cosmetic purposes; decorative transfers for cosmetic purposes; dentifrices; deodorants for human beings or for animals; deodorant soap; depilatories; douching preparations for personal sanitary or deodorant purposes [toiletries]; Eau de Cologne; eyebrow cosmetics; fumigation preparations [perfumes]; greases for cosmetic purposes; hair colorants; hair lotions; hair spray; hair waving preparations; joss sticks; lip glosses; lipsticks; lotions for cosmetic purposes; make-up; make-up removing preparations; make-up preparations; make-up powder; mascara; massage gels other than for medical purposes; medicated soap; mouth washes, not for medical purposes; nail care preparations; nail polish; neutralizers for permanent waving; oils for cosmetic purposes; oils for perfumes and scents; oils for toilet purposes; perfumery; perfumes; pomades for cosmetic purposes; potpourris [fragrances]; scented water; scented wood; shampoos; skin whitening creams; soap; sunscreen preparations; sun-tanning preparations [cosmetics]; tissues impregnated with cosmetic lotions; toiletries; toilet water.

5 – Albumin dietary supplements; albuminous food-stuffs for medical purposes; albuminous preparations for medical purposes; alginate dietary supplements; aloe vera preparations for pharmaceutical purposes; antioxidant pills; appetite suppressant pills; balms for medical purposes; bath preparations, medicated; biocides; biological preparations for medical purposes; by-products of the processing of cereals for dietetic or medical purposes; casein dietary supplements; decoctions for pharmaceutical purposes; diabetic bread adapted for medical use; dietary fiber; dietetic beverages adapted for medical purposes; dietetic substances adapted for medical use; digestives for pharmaceutical purposes; enzyme dietary supplements; enzyme preparations for medical purposes; flaxseed dietary supplements; flaxseed oil dietary supplements; flour for pharmaceutical purposes; food for babies; glucose dietary supplements; hematogen; herbal teas for medicinal purposes; lacteal flour for babies; lecithin dietary supplements; lotions for pharmaceutical purposes; liniments; malted milk beverages for medical purposes; medicinal herbs; medicinal infusions; medicinal oils; medicinal roots;

medicinal tea; milk ferments for pharmaceutical purposes; mineral food supplements; nervines; nutritional supplements; pharmaceutical preparations for skin care; pollen dietary supplements; preparations of trace elements for human and animal use; propolis dietary supplements; protein dietary supplements; royal jelly dietary supplements; royal jelly for pharmaceutical purposes; slimming pills; syrups for pharmaceutical purposes; vitamin preparations; wheat germ dietary supplements; yeast dietary supplements; yeast for pharmaceutical purposes.

(260) AM 2015 76581 A

(800) 1196258

(891) 2013 12 11

(731) YASİN AKKAYA

Adnan Kahveci Mahallesi, Alemdağ Caddesi,
Perla Vista Residans A Blok K:9 No:87,
Beylikdüzü-İstanbul, TR

(540)

freshsense

(511)

3 – Bleaching preparations and other substances for laundry use; cleaning, polishing, scouring and abrasive preparations; soaps; perfumery, essential oils, cosmetics, hair lotions; dentifrices.

5 – Pharmaceutical and veterinary preparations; sanitary preparations for medical purposes; dietetic food and substances adapted for medical or veterinary use, food for babies; dietary supplements for humans and animals; plasters, materials for dressings; material for stopping teeth, dental wax; disinfectants; preparations for destroying vermin; fungicides, herbicides; air purifying preparations, deodorants other than for personal purposes.

(260) AM 2015 76582 A

(800) 1196252

(891) 2013 12 30

(731) COMEDY CLUB PRODUCTION IP

(Cyprus) LIMITED

Theklas Lysioty, 29, Cassandra Centre,
3rd floor, CY-3030 Limassol, CY

(540)



(591) Red, white

(511)

9 – Abacuses; accumulator boxes; accumulator jars; accumulators, electric; accumulators, electric, for

vehicles; acid hydrometers; acidimeters for batteries; acoustic conduits; acoustic couplers; acoustic [sound] alarms; actinometers; adding machines; aerials; aerometers; electronic agendas; air analysis apparatus; alarm bells, electric; alarms; fire alarms; alcoholmeters; alidades; altimeters; ammeters; amplifiers; amplifying tubes; amplifying valves; anemometers; animated cartoons; anode batteries; anodes; answering machines; antennas; anticathodes; anti-dazzle shades; anti-glare glasses; anti-glare visors; anti-interference devices [electricity]; anti-theft warning apparatus; apertometers [optics]; armatures [electricity]; asbestos clothing for protection against fire; asbestos gloves for protection against accidents; asbestos screens for firemen; apparatus and instruments for astronomy; lenses for astrophotography; audiovisual teaching apparatus; automated teller machines [atm]; protective suits for aviators; azimuth instruments; precision balances; balances [steelyards]; balancing apparatus; meteorological balloons; bar code readers; barometers; batteries, electric; batteries, electric, for vehicles; batteries for lighting; battery boxes; battery chargers; battery jars; beacons, luminous; signal bells; bells [warning devices]; betatrons; binoculars; blinkers [signalling lights]; blueprint apparatus; fire boats; boiler control instruments; encoded identification bracelets, magnetic; branch boxes [electricity]; breathing apparatus, except for artificial respiration; breathing apparatus for underwater swimming; bullet-proof waistcoats; marking buoys; signalling buoys; buzzers; cabinets for loudspeakers; coaxial cables; cables, electric; junction sleeves for electric cables; calculating disks; calculating machines; calibrating rings; calipers; camcorders; cinematographic cameras; cameras [photography]; capacitors; capillary tubes; encoded magnetic cards; carpenters' rules; carriers for dark plates [photography]; cases especially made for photographic apparatus and instruments; eyeglass cases; cases fitted with dissecting instruments [microscopy]; pince-nez cases; cash registers; cassette players; cathodes; cathodic anti-corrosion apparatus; cell phone straps; cell switches [electricity]; centering apparatus for photographic transparencies; central processing units [processors]; eyeglass chains; chargers for electric batteries; chemistry apparatus and instruments; dna chips; chips [integrated circuits]; choking coils [impedance]; megaphones; mercury levels; wires of metal alloys [fuse wire]; metal detectors for industrial or military purposes; meteorological instruments; meters; metronomes; micrometer gauges; micrometer screws for optical instruments; micrometers; microprocessors; containers for microscope slides; microscopes; microtomes; milage recorders for vehicles; mirrors for inspecting work; mirrors [optics]; modems; money counting and sorting machines; monitoring apparatus, electric; monitors [computer hardware]; monitors [computer programs]; mouse [data processing equipment]; mouse

pads; coin-operated musical automata [juke boxes]; nautical apparatus and instruments; naval signalling apparatus; navigation apparatus for vehicles [on-board computers]; navigational instruments; needles for record players; neon signs; nets for protection against accidents; safety nets; nose clips for divers and swimmers; notebook computers; electronic notice boards; fire hose nozzles; objectives [lenses] [optics]; observation instruments; octants; ohmmeters; optical apparatus and instruments; optical character readers; optical condensers; optical data media; optical discs; optical fibers [fibres] [light conducting filaments]; optical glass; optical goods; optical lamps; optical lanterns; optical lenses; oscillographs; ovens for laboratory use; oxygen transvasing apparatus; ozonisers [ozonators]; parking meters; particle accelerators; pedometers; peepholes [magnifying lenses] for doors; electronic pens [visual display units]; computer peripheral devices; periscopes; personal stereos; petrol gauges; phonograph records; photocopiers [photographic, electrostatic, thermic]; drying apparatus for photographic prints; glazing apparatus for photographic prints; frames for photographic transparencies; photometers; phototelegraphy apparatus; photovoltaic cells; apparatus and instruments for physics; pince-nez; pince-nez chains; pince-nez cords; pince-nez mountings; pipettes; plane tables [surveying instruments]; planimeters; plates for batteries; DVD players; plotters; plugs, sockets and other contacts [electric connections]; plumb bobs; plumb lines; pocket calculators; light-emitting electronic pointers; polarimeters; precision measuring apparatus; pressure gauges; automatic indicators of low pressure in vehicle tires [tyres]; pressure indicator plugs for valves; pressure indicators; pressure measuring apparatus; printed circuits; printers for use with computers; prisms [optics]; probes for scientific purposes; processors [central processing units]; computer programs [downloadable software]; computer game programs; projection apparatus; projection screens; protection devices against x-rays, not for medical purposes; protection devices for personal use against accidents; protective helmets; protective helmets for sports; protective masks; voltage surge protectors; protractors [measuring instruments]; electronic publications, downloadable; punched card machines for offices; push buttons for bells; pyrometers; quantity indicators; photographic racks; radar apparatus; radio pagers; radiological apparatus for industrial purposes; radiology screens for industrial purposes; radios; vehicle radios; radiotelegraphy sets; radiotelephony sets; railway traffic safety appliances; range finders; readers [data processing equipment]; telephone receivers; apparatus for changing record player needles; record players; apparatus for recording distance; reducers [electricity]; reflecting discs for wear, for the prevention of traffic accidents; refractometers; refractors; regulating apparatus, electric; light regulators [dimmers],

electric; relays, electric; shutter releases [photography]; remote control apparatus; electric installations for the remote control of industrial operations; electro-dynamic apparatus for the remote control of railway points; electro-dynamic apparatus for the remote control of signals; resistances, electric; respirators for filtering air; respirators, other than for artificial respiration; respiratory masks, other than for artificial respiration; resuscitation mannequins [teaching apparatus]; retorts; retorts' stands; revolution counters; rheostats; riding helmets; road signs, luminous or mechanical; rods for water diviners; rods [surveying instruments]; rulers [measuring instruments]; rules [measuring instruments]; saccharometers; safety tarpaulins; salinometers; satellite navigational apparatus; satellites for scientific purposes; scales; lever scales [steelyards]; scanners [data processing equipment]; screens for photoengraving; screens [photography]; screw-tapping gauges; semiconductors; sextants; sheaths for electric cables; shoes for protection against accidents, irradiation and fire; shutters [photography]; sighting telescopes for firearms; signal lanterns; signalling panels, luminous or mechanical; signalling whistles; signals, luminous or mechanical; transmitters of electronic signals; signs, luminous; simulators for the steering and control of vehicles; sirens; apparatus for measuring the thickness of skins; slide calipers; slide projectors; slide-rules; slides [photography]; slope indicators; smart cards [integrated circuit cards]; smoke detectors; sockets, plugs and other contacts [electric connections]; socks, electrically heated; computer software, recorded; solar batteries; solderers' helmets; solenoid valves [electromagnetic switches]; sonars; sound alarms; sound locating instruments; sound recording apparatus; sound recording carriers; sound recording discs; sound recording strips; sound reproduction apparatus; sound transmitting apparatus; sounding apparatus and machines; sounding leads; sounding lines; spark-guards; speaking tubes; spectacle cases; spectacle frames; spectacles [optics]; spectrograph apparatus; spectroscopes; speed checking apparatus for vehicles; speed indicators; speed measuring apparatus [photography]; speed regulators for record players; spherometers; spirit levels; spools [photography]; goggles for sports; sprinkler systems for fire protection; stage lighting regulators; apparatus to check stamping mail; stands for photographic apparatus; starter cables for motors; steelyards [lever scales]; steering apparatus, automatic, for vehicles; step-up transformers; stereoscopes; stereoscopic apparatus; stills for laboratory experiments; styli for record players; sulphitometers; sunglasses; surveying apparatus and instruments; surveying chains; surveying instruments; surveyors' levels; switchboards; switchboxes [electricity]; switches, electric; tachometers; tape recorders; magnetic tape units for computers; demagnetizing apparatus for magnetic tapes; taximeters; teaching apparatus;

teeth protectors; telegraph wires; telemeters; telephone apparatus; telephone wires; portable telephones; teleprinters; teleprompters; telerupters; telescopes; teletypewriters; television apparatus; automated teller machines; temperature indicators; terminals [electricity]; test tubes; testing apparatus not for medical purposes; theft prevention installations, electric; theodolites; thermionic tubes; thermionic valves; thermometers, not for medical purposes; thermostats; thermostats for vehicles; thread counters; identification threads for electric wires; ticket dispensers; time clocks [time recording devices]; time recording apparatus; time switches, automatic; automatic indicators of low pressure in vehicle tires; tone arms for record players; totalizers; traffic-light apparatus [signalling devices]; transformers [electricity]; transistors [electronic]; transmitters [telecommunication]; transmitting sets [telecommunication]; transparencies [photography]; transparency projection apparatus; transponders; triodes; tripods for cameras; electric discharge tubes, other than for lighting; automatic indicators of low pressure in vehicle tyres; urinometers; vacuum gauges; vacuum tubes [radio]; variometers; vehicle breakdown warning triangles; verniers; bullet-proof vests (am.); video cassettes; video game cartridges; video recorders; video screens; video telephones; videotapes; viewfinders, photographic; viscosimeters; voltage regulators for vehicles; voltmeters; voting machines; waling glasses; walkie-talkies; washing trays [photography]; water level indicators; wavemeters; weighbridges; weighing apparatus and instruments; weighing machines; weights; whistle alarms; wind socks for indicating wind direction; wire connectors [electricity]; masts for wireless aeriels; wires, electric; workmen's protective face-shields; wrist rests for use with computers; x-ray apparatus not for medical purposes; x-ray films, exposed; x-ray photographs, other than for medical purposes; x-ray tubes not for medical purposes; chronographs [time recording apparatus]; apparatus for editing cinematographic film; cinematographic film, exposed; circuit breakers; circuit closers; cleaning apparatus for phonograph records; cleaning apparatus for sound recording discs; clinometers; clothing especially made for laboratories; clothing for protection against accidents, irradiation and fire; clothing for protection against fire; coils, electric; electromagnetic coils; holders for electric coils; mechanisms for coin-operated apparatus; coin-operated mechanisms for television sets; collectors, electric; electric apparatus for commutation; commutators; compact disc players; compact discs [audio-video]; compact discs [read-only memory]; comparators; directional compasses; compasses [measuring instruments]; computer keyboards; computer memory devices; computer operating programs, recorded; computer programmes [programs], recorded; computers; condensers [capacitors]; conductors, electric; lightning conductors; electricity

conduits; connections, electric; connections for electric lines; connectors [electricity]; contact lenses; containers for contact lenses; contacts, electric; control panels [electricity]; converters, electric; copper wire, insulated; correcting lenses [optics]; cosmographic instruments; counterfeit [false] coin detectors; mechanisms for counter-operated apparatus; counters; couplers [data processing equipment]; couplings, electric; covers for electric outlets; crash test dummies; crucibles [laboratory]; cupels [laboratory]; current rectifiers; cyclotrons; darkroom lamps [photography]; darkrooms [photography]; magnetic data media; data processing apparatus; decompression chambers; densimeters; densitometers; detectors; diagnostic apparatus, not for medical purposes; diaphragms [acoustics]; diaphragms for scientific apparatus; diaphragms [photography]; dictating machines; diffraction apparatus [microscopy]; light dimmers [regulators], electric; discharge tubes, electric, other than for lighting; disk drives for computers; disks, magnetic; distance measuring apparatus; distance recording apparatus; distillation apparatus for scientific purposes; distribution boards [electricity]; distribution boxes [electricity]; distribution consoles [electricity]; divers' masks; diving suits; dog whistles; dosage dispensers; dosimeters; drainers for use in photography; dressmakers' measures; drying racks [photography]; ducts [electricity]; dynamometers; ear plugs for divers; editing appliances for cinematographic films; egg timers [sandglasses]; egg-candlers; electric door bells; electric loss indicators; materials for electricity mains [wires, cables]; electrified fences; electrified rails for mounting spot lights; electrolyzers; electronic pocket translators; electronic tags for goods; magnetic encoders; enlarging apparatus [photography]; epidiascopes; ergometers; exposure meters [light meters]; eyeglass cords; eyeglass frames; eyeglasses; eyepieces; instruments containing eyepieces; facsimile machines; false coin detectors; apparatus for fermentation [laboratory apparatus]; fibre optic cables; film cutting apparatus; films, exposed; filters for respiratory masks; filters for ultraviolet rays, for photography; filters [photography]; fire beaters; fire blankets; fire engines; fire escapes; fire extinguishing apparatus; fire hose; flash-bulbs [photography]; flashing lights [luminous signals]; flashlights [photography]; floppy disks; fluorescent screens; fog signals, non-explosive; food analysis apparatus; apparatus to check franking; frequency meters; furnaces for laboratory use; furniture especially made for laboratories; fuse wire; fuses; galena crystals [detectors]; galvanic batteries; galvanic cells; galvanometers; garments for protection against fire; gas testing instruments; gasoline gauges; gasometers [measuring instruments]; gauges; glass covered with an electrical conductor; graduated glassware; global positioning system [gps] apparatus; gloves for divers; gloves for protection against accidents; gloves for protection against x-ra-

ys for industrial purposes; gradient indicators; grids for batteries; hands free kits for phones; head cleaning tapes [recording]; headphones; heat regulating apparatus; heliographic apparatus; hemline markers; high tension batteries; high-frequency apparatus; holograms; horns for loudspeakers; hourglasses; hydrometers; hygrometers; identification sheaths for electric wires; identity cards, magnetic; igniting apparatus, electric, for igniting at a distance; electric apparatus for remote ignition; inclinometers; incubators for bacteria culture; inductors [electricity]; integrated circuit cards [smart cards]; integrated circuits; intercommunication apparatus; interfaces for computers; inverters [electricity]; invoicing machines; ionization apparatus not for the treatment of air or water; juke boxes for computers; juke boxes, musical; junction boxes [electricity]; kilometer recorders for vehicles; knee-pads for workers; laboratory trays; lactodensimeters; lactometers; magic lanterns; lasers, not for medical purposes; appliances for measuring the thickness of leather; lens hoods; letter scales; levelling instruments; levelling staffs [surveying instruments]; levels [instruments for determining the horizontal]; life belts; life buoys; life jackets; life nets; life saving apparatus and equipment; life-saving rafts; light-emitting diodes [led]; lighting ballasts; lightning arresters; lightning conductors [rods]; limiters [electricity]; locks, electric; logs [measuring instruments]; loudspeakers; magnetic tapes; magnetic wires; magnets; decorative magnets; magnifying glasses [optics]; manometers; marine compasses; marine depth finders; marking gauges [joinery]; material testing instruments and machines; mathematical instruments; measures; measuring apparatus; measuring devices, electric; measuring glassware; measuring instruments; measuring spoons.

16 – Absorbent sheets of paper or plastic for foodstuff packaging; address plates for addressing machines; address stamps; addressing machines; adhesive bands for stationery or household purposes; adhesive tape dispensers [office requisites]; adhesive tapes for stationery or household purposes; adhesives [glues] for stationery or household purposes; advertisement boards of paper or cardboard; albums; almanacs; announcement cards [stationery]; aquarelles; architects' models; arithmetical tables; artists' watercolor [watercolour] saucers; atlases; conical paper bags; bags [envelopes, pouches] of paper or plastics, for packaging; bags for microwave cooking; garbage bags of paper or of plastics; balls for ball-point pens; bibs of paper; loose-leaf binders; binding strips [bookbinding]; biological samples for use in microscopy [teaching materials]; blackboards; blotters; blueprints; bookbinding apparatus and machines [office equipment]; bookbinding cloth; bookbinding cords; bookbinding material; bookbindings; bookends; booklets; bookmarks; books; bottle envelopes of cardboard or paper; bottle wrappers of cardboard or paper; paper bows; boxes for pens; boxes of cardboard or

paper; plastic bubble packs for wrapping or packaging; cabinets for stationery [office requisites]; calculating tables; calendars; canvas for painting; carbon paper; cardboard; cardboard articles; cardboard tubes; cards; cases for stamps [seals]; catalogues; chalk for lithography; chalk holders; marking chalk; chaplets; charcoal pencils; chart pointers, non-electronic; charts; holders for checkbooks [cheque books]; chromolithographs [chromos]; chromos; cigar bands; clipboards; clips for offices; money clips; cloth for bookbinding; coasters of paper; paper coffee filters; comic books; compasses for drawing; composing frames [printing]; composing sticks; inking ribbons for computer printers; paper tapes and cards for the recordal of computer programmes; copying paper [stationery]; cords for bookbinding; correcting fluids [office requisites]; correcting ink [heliography]; correcting tapes [office requisites]; covers of paper for flower pots; covers [stationery]; cream containers of paper; credit card imprinters, non-electric; paper cutters [office requisites]; decalcomanias; diagrams; document files [stationery]; document holders [stationery]; document laminators for office use; drawer liners of paper, perfumed or not; drawing boards; drawing instruments; drawing materials; drawing pads; drawing pens; drawing pins; drawing sets; drawing squares; drawing t-squares; duplicators; inking sheets for duplicators; painters' easels; elastic bands for offices; electrocardiograph paper; electrotypes; embroidery designs [patterns]; engraving plates; engravings; envelope sealing machines, for offices; envelopes [stationery]; writing board erasers; erasing products; erasing shields; etching needles; etchings; fabrics for bookbinding; face towels of paper; files [office requisites]; filter paper; filtering materials [paper]; finger-stalls [office requisites]; flags of paper; flower-pot covers of paper; flyers; folders for papers; folders [stationery]; forms, printed; fountain pens; franking machines for office use; french curves; galley racks [printing]; geographical maps; terrestrial globes; glue for stationery or household purposes; gluten [glue] for stationery or household purposes; graining combs; graphic prints; graphic representations; graphic reproductions; greeting cards; gummed cloth for stationery purposes; gummed tape [stationery]; gums [adhesives] for stationery or household purposes; hand labelling appliances; handbooks [manuals]; handkerchiefs of paper; hand-rests for painters; handwriting specimens for copying; hat boxes of cardboard; hectographs; histological sections for teaching purposes; holders for stamps [seals]; passport holders; house painters' rollers; humidity control sheets of paper or plastic for foodstuff packaging; hygienic paper; index cards [stationery]; indexes; indian inks; ink; ink sticks; ink stones [ink reservoirs]; inking pads; inking ribbons; inking sheets for document reproducing machines; inkstands; inkwells; isinglass for stationery or household pur-

poses; jackets for papers; perforated cards for jacquard looms; paper knives [office requisites]; labels, not of textile; ledgers [books]; letter trays; letters [type]; lithographic stones; lithographic works of art; lithographs; luminous paper; magazines [periodicals]; manifolds [stationery]; manuals [handbooks]; marking pens [stationery]; mats for beer glasses; modelling clay; molds for modelling clays [artists' materials]; moulds for modelling clays [artists' materials]; modelling materials; modelling paste; modelling wax, not for dental purposes; moisteners for gummed surfaces [office requisites]; moisteners [office requisites]; apparatus for mounting photographs; musical greeting cards; napkins of paper for removing make-up; table napkins of paper; newsletters; newspapers; nibs; nibs of gold; note books; numbering apparatus; numbers [type]; obliterating stamps; office perforators; office requisites, except furniture; oleographs; packaging material made of starches; packing paper; pads [stationery]; writing pads; paint boxes [articles for use in school]; paint trays; paintbrushes; painters' brushes; paintings [pictures], framed or unframed; palettes for painters; pamphlets; pantographs [drawing instruments]; paper; paper clasps; electro-cardiograph paper; paper for recording machines; paper knives [cutters] [office requisites]; paper ribbons; paper sheets [stationery]; paper shredders for office use; waxed paper; paperclips; paperweights; parchment paper; pastels [crayons]; pastes for stationery or household purposes; patterns for dressmaking; patterns for making clothes; pen cases; pen clips; pen wipers; pencil holders; pencil lead holders; pencil leads; pencil sharpeners, electric or non-electric; pencil sharpening machines, electric or non-electric; pencils; penholders; pens [office requisites]; periodicals; photo-engravings; photograph stands; photographs [printed]; pictures; placards of paper or cardboard; place mats of paper; plans; plastic cling film, extensible, for palletization; plastic film for wrapping; plastics for modelling; portraits; postage meters for office use; postage stamps; postcards; posters; printed matter; printed publications; printed timetables; printers' blankets, not of textile; printers' galleys; printing blocks; printing sets, portable [office requisites]; printing type; prints [engravings]; prospectuses; punches [office requisites]; paper for radiograms; rollers for typewriters; rosaries; rubber erasers; drawing rulers; square rulers; watercolor [watercolour] saucers for artists; school supplies [stationery]; scrapbooks; scrapers [erasers] for offices; sealing compounds for stationery purposes; sealing machines for offices; sealing stamps; sealing wafers; sealing wax; seals [stamps]; self-adhesive tapes for stationery or household purposes; sheets of reclaimed cellulose for wrapping; shields [paper seals]; signboards of paper or cardboard; silver paper; slate pencils; song books; spools for inking ribbons; stamp pads; stamp stands; stamps [seals]; stands for pens and pencils; staples

for offices; stapling presses [office requisites]; stationery; steatite [tailor's chalk]; steel letters; steel pens; stencil cases; stencil plates; stencils; stencils [stationery]; stickers [stationery]; table linen of paper; tablecloths of paper; tablemats of paper; tags for index cards; tailors' chalk; teaching materials [except apparatus]; thumbtacks; tickets; tissues of paper for removing make-up; toilet paper; towels of paper; tracing cloth; tracing needles for drawing purposes; tracing paper; tracing patterns; trading cards other than for games; transfers [decalcomanias]; transparencies [stationery]; trays for sorting and counting money; type [numerals and letters]; typewriter keys; typewriter ribbons; typewriters, electric or non-electric; vignetting apparatus; viscose sheets for wrapping; artists' watercolor saucers; watercolors [paintings]; artists' watercolour saucers; watercolours [paintings]; wood pulp board [stationery]; wood pulp paper; wrappers [stationery]; wrapping paper; wristbands for the retention of writing instruments; writing brushes; writing cases [sets]; writing cases [stationery]; writing chalk; writing instruments; writing materials; writing or drawing books; writing paper; writing slates; writing tablets.

35 – Commercial administration of the licensing of the goods and services of others; administrative processing of purchase orders; advertising; advertising agencies; advertising by mail order; updating of advertising material; dissemination of advertising matter; rental of advertising space; commercial information and advice for consumers [consumer advice shop]; cost price analysis; telephone answering for unavailable subscribers; business appraisals; arranging newspaper subscriptions for others; arranging subscriptions to telecommunication services for others; business management of performing artists; business management assistance; auctioneering; billposting; book-keeping; professional business consultancy; business information; business inquiries; business investigations; business management and organization consultancy; business management consultancy; business management of hotels; business management of sports people; business organization consultancy; commercial or industrial management assistance; presentation of goods on communication media, for retail purposes; price comparison services; compilation of statistics; compilation of information into computer databases; systemization of information into computer databases; data search in computer files for others; demonstration of goods; direct mail advertising; distribution of samples; document reproduction; economic forecasting; employment agencies; organization of exhibitions for commercial or advertising purposes; organization of fashion shows for promotional purposes; computerized file management; import-export agencies; commercial information agencies; invoicing; personnel management consultancy; marketing; marketing research; marketing studies; modelling for adverti-

sing or sales promotion; news clipping services; office machines and equipment rental; on-line advertising on a computer network; opinion polling; organization of trade fairs for commercial or advertising purposes; outdoor advertising; outsourcing services [business assistance]; payroll preparation; personnel recruitment; photocopying services; word processing; procurement services for others [purchasing goods and services for other businesses]; production of advertising films; psychological testing for the selection of personnel; public relations; publication of publicity texts; publicity; publicity agencies; publicity columns preparation; publicity material rental; writing of publicity texts; radio advertising; radio commercials; relocation services for businesses; rental of advertising time on communication media; rental of photocopying machines; rental of vending machines; business research; sales promotion for others; secretarial services; shop window dressing; shorthand; sponsorship search; drawing up of statements of accounts; tax preparation; telemarketing services; television advertising; television commercials; transcription; typing.

36 – Accident insurance underwriting; accommodation bureaux [apartments]; actuarial services; financial analysis; antique appraisal; apartment house management; renting of apartments; art appraisal; jewellery appraisal; numismatic appraisal; real estate appraisal; stamp appraisal; bail-bonding; banking; home banking; brokerage; brokerage of carbon credits; business liquidation services, financial; capital investments; charitable fund raising; check [cheque] verification; clearing, financial; clearing-houses, financial; rent collection; organization of collections; financial consultancy; insurance consultancy; credit bureaux; credit card services; issuance of credit cards; customs brokerage; debit card services; debt collection agencies; deposits of valuables; real estate agencies; real estate management; financial evaluation [insurance, banking, real estate]; financial evaluation of standing timber; financial evaluation of wool; repair costs evaluation [financial appraisal]; exchanging money; factoring; fiduciary; financial information; financial management; financial sponsorship; financing services; fire insurance underwriting; fiscal assessments; fund investments; electronic funds transfer; guarantees; health insurance underwriting; hire-purchase financing; housing agents; insurance information; instalment loans; insurance brokerage; insurance underwriting; capital investment; issue of tokens of value; issuing of travellers' checks [cheques]; jewelry appraisal; lease-purchase financing; leasing of farms; leasing of real estate; lending against security; life insurance underwriting; loans [financing]; marine insurance underwriting; mortgage banking; mutual funds; pawnbrokerage; provident fund services; real estate brokers; rental of offices [real estate]; renting of flats; retirement payment services; safe deposit services; savings bank

services; securities brokerage; stock exchange quotations; stocks and bonds brokerage; surety services; trusteeship; financial valuation of standing timber; fiscal valuations.

38 – Rental of access time to global computer networks; cable television broadcasting; radio broadcasting; television broadcasting; cellular telephone communication; providing internet chatrooms; communications by computer terminals; communications by fiber [fibre] optic networks; communications by telegrams; communications by telephone; computer aided transmission of messages and images; electronic bulletin board services [telecommunications services]; electronic mail; facsimile transmission; transmission of greeting cards online; information about telecommunication; message sending; news agencies; paging services [radio, telephone or other means of electronic communication]; providing access to databases; providing telecommunication channels for teleshopping services; providing telecommunications connections to a global computer network; providing user access to global computer networks; rental of facsimile apparatus; rental of message sending apparatus; rental of modems; rental of telecommunication equipment; rental of telephones; satellite transmission; telecommunications routing and junction services; teleconferencing services; transmission of telegrams; telegraph services; telephone services; telex services; transmission of digital files; voice mail services; wire service; wireless broadcasting.

41 – Academies [education]; providing amusement arcade services; amusement parks; amusements; animal training; arranging and conducting of colloquiums; arranging and conducting of concerts; arranging and conducting of conferences; arranging and conducting of congresses; arranging and conducting of seminars; arranging and conducting of symposiums; arranging and conducting of workshops [training]; arranging of beauty contests; boarding schools; booking of seats for shows; bookmobile services; publication of books; calligraphy services; holiday camp services [entertainment]; sport camp services; providing casino facilities [gambling]; rental of cine-films; cinema presentations; circuses; club services [entertainment or education]; coaching [training]; organization of competitions [education or entertainment]; organization of sports competitions; conducting fitness classes; correspondence courses; disc jockey services; discotheque services; rental of skin diving equipment; dubbing; videotape editing; education information; religious education; educational examination; educational services; electronic desktop publishing; entertainer services; entertainment; entertainment information; organization of exhibitions for cultural or educational purposes; organization of fashion shows for entertainment purposes; film production, other than advertising films;

gambling; game services provided on-line from a computer network; games equipment rental; providing golf facilities; vocational guidance [education or training advice]; gymnastic instruction; health club services [health and fitness training]; recreation information; instruction services; sign language interpretation; language interpreter services; layout services, other than for advertising purposes; lending libraries; mobile library services; presentation of live performances; operating lotteries; microfilming; modelling for artists; rental of motion pictures; rental of movie projectors and accessories; movie studios; movie theatre presentations; providing museum facilities [presentation, exhibitions]; music composition services; music-halls; news reporters services; night clubs; nursery schools; orchestra services; organization of balls; organization of shows [impresario services]; party planning [entertainment]; personal trainer services [fitness training]; photographic reporting; photography; physical education; practical training [demonstration]; production of music; production of radio and television programmes; production of shows; videotape film production; providing karaoke services; providing on-line electronic publications, not downloadable; providing sports facilities; publication of electronic books and journals on-line; publication of texts, other than publicity texts; rental of radio and television sets; radio entertainment; rental of video cassette recorders; recording studio services; providing recreation facilities; rental of audio equipment; rental of camcorders; rental of lighting apparatus for theatrical sets or television studios; rental of show scenery; rental of sound recordings; rental of sports equipment, except vehicles; rental of sports grounds; rental of stadium facilities; rental of stage scenery; rental of tennis courts; rental of video cameras; rental of videotapes; script-writing services; timing of sports events; subtitling; teaching; television entertainment; writing of texts, other than publicity texts; theatre productions; ticket agency services [entertainment]; toy rental; translation; tuition; videotaping; vocational retraining; zoological garden services.

42 – Analysis for oil-field exploitation; architectural consultation; architecture; authenticating works of art; bacteriological research; biological research; calibration [measuring]; chemical analysis; chemical research; chemistry services; cloud seeding; consultancy in the design and development of computer hardware; computer programming; duplication of computer programs; computer rental; computer software consultancy; computer software design; installation of computer software; maintenance of computer software; updating of computer software; computer system analysis; computer system design; computer virus protection services; construction drafting; consultancy in the field of energy-saving; conversion of data or documents from physical to electronic media; cosmetic research; creating and main-

taining web sites for others; data conversion of computer programs and data [not physical conversion]; design of interior decor; industrial design; packaging design services; dress designing; digitization of documents [scanning]; engineering; research in the field of environmental protection; quality evaluation of standing timber; quality evaluation of wool; underwater exploration; weather forecasting; geological prospecting; geological research; geological surveys; handwriting analysis [graphology]; hosting computer sites [web sites]; scientific laboratory services; land surveying; material testing; mechanical research; meteorological information; monitoring of computer systems by remote access; oil prospecting; oil-field surveys; oil-well testing; packaging design; physics [research]; technical project studies; providing search engines for the internet; provision of scientific information, advice and consultancy in relation to carbon offsetting; quality control; recovery of computer data; rental of computer software; rental of web servers; research and development of new products for others; styling [industrial design]; surveying; land surveys; technical research; textile testing; urban planning; quality valuation of standing timber; vehicle roadworthiness testing; water analysis.

(260) AM 2015 76624 A

(800) 1196589

(891) 2013 12 19

(731) SHANDONG LINGLING TYRE CO., LTD
No:777 Jinlong Road, Zhaoyuan City,
265400 Shangdong Province, CN

(540)



(591) Black, white

(511)

12 – Automobile tires; inner tubes for pneumatic tires; casings for pneumatic tires; treads for retreading tires; tires for airplanes; pneumatic tires, solid, for vehicle wheels; vehicle wheel tires; pneumatic tires; bicycle tires; tires for vehicle wheels.

(260) AM 2015 76635 A

(800) 1196736

(891) 2013 12 10

(731) EISAI R&D MANAGEMENT CO., LTD.
6-10, Koishikawa 4 chome, Bunkyo-ku,
Tokyo 112-8088, JP

(540)

TARGRETIN

(511)

5 – Pharmaceutical preparations.

(260) AM 2015 76636 A
 (800) 1196801
 (891) 2013 12 02
 (731) ATHENA COSMETICS, INC.
 1838 Eastman Ave., Suite 200, Ventura CA
 93003, US
 (540)

Revitalash

(591) Black, white
 (511)
 3 – Non-medicated skin care preparations, namely, moisturizers, cleansers, masks, conditioners, creams, exfoliators, toners, make-up primers, lip care products, namely, lip primers and conditioners, eye brow products, namely, eyebrow liners, conditioners and strengtheners, eyelash products, namely, mascaras, lengtheners, conditioners, strengtheners, eye-care products, namely, eye creams, concealers, highlighters, and makeup; hair care products, namely, gels, non-medicated balms, sprays, rinses, moisturizers, strengtheners, shampoos and conditioners; cosmetic accessories, namely, pencils, pads, cosmetic removers; nail care preparations, namely, strengtheners, moisturizers, conditioners, polish, hardeners, enamels, and varnish.

(260) AM 2015 76637 A
 (800) 1196811
 (891) 2013 09 13
 (731) SCOTCH & SODA B.V.
 Jacobus Spijkerdreef 20-24, NL-2132 PZ
 Hoofddorp, NL
 (540)

ATELIER SCOTCH

(526) – The trademark is protected as a whole. The word "ATELIER" included therein shall not be subject to independent legal protection.
 (511)
 25 – Clothing; men's and ladies' wear, ready-to-wear clothing, jackets, costumes, suits, custom-made suits, pants, shirts, undershirts, blouses, jumpers, sweaters, shirts, T-shirts, vests, corselets, underwear, undergarments, stocking suspenders, corsets, lingerie, brassieres, bustiers, body stockings, underpants, briefs, boxers, tights, socks, stockings, legwarmers, outerwear, coats, raincoats, jackets, parkas, pullovers, ponchos, pyjamas, bathing trunks, trousers, shorts, bermudas, leggings, skirts, underskirts, dresses, slippers, frocks; babywear, swimwear; sportswear; footwear, including shoes, sports shoes, boots, sneakers, slippers, flip-flops [footwear], espadrilles, sandals; headwear, including bathing caps, shower caps, hoods, headbands, hats, caps, berets; gloves (clothing), mittens, shawls, sashes, scarves, bandanas, ties and bow ties, suspenders, belts and waist belts.

(260) AM 2015 76638 A
 (800) 1196816
 (891) 2013 11 04
 (731) KERVAN TEKSTİL SANAYİ VE DIŞ
 TİCARET ANONİM ŞİRKETİ
 Ekmekçiöğlü Mevkii Merve Mah., Osmangazi
 Cad. No: 24, Yenidoğan-Ümraniye-İstanbul,
 TR
 (540)



(591) Green, white, light brown
 (511)
 20 – Furniture made of any kind of substances and materials.
 24 – Woven or non-woven textile fabrics, home textile goods, including flags, handkerchiefs.
 35 – Advertising; business management; business administration; office functions; the bringing together, for the benefit of others, of a variety of goods, excluding the transport thereof, enabling customers to conveniently view and purchase those goods.

(260) AM 2015 76640 A
 (800) 1196833
 (891) 2013 11 14
 (731) TEXTBROOK LIMITED
 Themistokli Dervi, 3, Julia House, CY-1066
 Nicosia, CY
 (540)

acóola

(591) Black, white
 (511)
 9 – Spectacles; sunglasses; spectacle frames; spectacle cases; eyeglass chains and straps.
 14 – Precious metals and their alloys and goods in precious metals or coated therewith, not included in other classes; jewellery, bijouterie, precious stones; watches and chronometric instruments.
 18 – Leather and imitations of leather, and goods made of these materials and not included in other classes; animal skins, hides; trunks and travelling bags; umbrellas and parasols; walking sticks; all-purpose carrying bags; purses; jitney bag; clutches [bags]; reticules; bags for campers; sport bags; backpacks; women bags, shoulder bags; wallets; wrist bags; bags for cosmetics, sold empty; leather belts [straps]; key cases [leather items].
 25 – Clothing; footwear; headgear; bandanas [neckerchiefs]; underwear; smocks; boas [necklets]; bodices [lingerie]; half-boots; breeches for wear; trousers; football shoes; brassieres; veils [clothing]; galoshes; neckties; leggings [leg warmers]; gaiters; vests; sports jerseys; hosiery; drawers [clothing]; ho-

ods [clothing]; collar protectors; tights; suits; swim-suits; masquerade costumes; beach clothes; jackets [clothing]; fishing vests; liveries; camisoles; tee-shirts; coats; furs [clothing]; mittens; muffs [clothing]; fur stoles; ear muffs [clothing]; socks; footwear; bath sandals; beach shoes; sports shoes; outer-clothing; ready-made clothing; clothing of leather; knitwear [clothing]; uniforms; topcoats; parkas; pelerines; pyjamas; gloves [clothing]; bathing trunks; scarfs; dresses; waterproof clothing; headbands [clothing]; garters; sock suspenders; stocking suspenders; belts [clothing]; money belts [clothing]; pullovers; shirts; wooden shoes; sandals; boots; saris; sweaters; togas; underpants; shoes; gymnastic shoes; slippers; aprons [clothing]; dressing gowns; stockings; shawls; bathing caps; sashes for wear; pelisses; esparto shoes or sandals; skirts; petticoats; jeans; clothing for children.

35 – Advertising; business management; business administration; office functions; the bringing together, for the benefit of others, of a variety of goods (excluding the transport thereof), enabling customers to conveniently view and purchase those goods; retail and wholesale store services, on-line retail store services; presentation of goods in Internet for retail and wholesale purposes.

42 – Scientific and technological services and research and design relating thereto; industrial analysis and research services; dress designing; designer services in the filed of fashion collections; graphic arts design; research and development of new products for others; packaging design services.

(260) AM 2015 76641 A
(800) 1196842
(891) 2013 12 31
(731) Zakrytoe aktsionerhoe obshchestvo
"Essen production AG"
Kollektivnaya St. 54 "A", Vasilyevka village,
Stavropol'skiy District, Samara Region,
RU-445142 Respublika Tatarstan, RU

(540)



(591) White, grey and black
(511)
30 – Confectionery, bread, pastry.

(260) AM 2015 76642 A
(800) 1196853
(891) 2014 01 09

(731) Limited Liability Company
"INNOVATIVE TECHNOLOGIES"
Kamennoostrovsky pr., 22, Lit. A, 3-N,
RU-197101 Saint-Petersburg, RU

(540)



(591) Orange, white and black

(511)

4 – Additives, non-chemical, to motor-fuel; cutting fluids; combustible oil; lubricating oil; industrial oil; lubricants; dust removing preparations; lubricating grease; grease for belts; vaporized fuel mixtures; dust binding compositions for sweeping.

(260) AM 2015 76643 A

(800) 450944A

(891) 2014 01 22

(731) Chanel SARL

Burgstrasse 26, CH-8750 Glarus, CH

(540)



(591) Black, white

(511)

3 – Perfumery products, beauty products, soap products, make-up, essential oils, cosmetics, hair care products, dentifrices.

(260) AM 2015 76644 A

(800) 496588

(891) 2013 12 18

(731) ASTELLAS PHARMA EUROPE B.V.

Sylviusweg 62, NL-2333 BE Leiden (NL), NL

(540)

DE-NOL

(511)

5 – Medicinal products.

(260) AM 2015 76645 A

(800) 541766

(891) 2013 07 15

(731) SPIESS-URANIA CHEMICALS GMBH

Frankenstrasse 18 b, 20097 Hamburg, DE

(540)

Funguran

(511)

1 – Chemical products, including the ones containing basic biological substances, for use in agriculture, horticulture and forestry, for spreading insecticides, soil treatment and reserve maintenance; agents for treating seeds including seed denaturing agents; fertilizers; chemical products for treating plant diseases, growth regulators.

5 – Herbicides and pesticides; chemical products for protecting plants (greenhouse maintenance), namely agents for combating plant enemies, fungus, animals and germs; insect repellents; disinfecting agents.

(260) AM 2015 76646 A

(800) 696866

(891) 2013 12 19

(731) Stoxx AG (Stoxx S.A.) (Stoxx Limited)
Selnaustrasse 30, CH-8001 Zürich, CH

(540)

STOXX

(511)

36 – Insurance underwriting; financial affairs; financial instrument issuance; banking and financial services; portfolio management; services relating to monetary and financial affairs; debit and credit card services; professional consultancy for the organisation and administration of financial and banking operations.

(260) AM 2015 76647 A

(800) 821513

(891) 2013 11 29

(731) GAYLIN HOLDINGS LTD
7 Gul Avenue, SINGAPORE 629651
(Singapore), SG

(540)

GAYLIN

(591) Black, white

(511)

6 – Wire rope slings; heavy lift slings made of wire ropes.

(260) AM 2015 76648 A

(800) 822104

(891) 2014 02 04

(731) COLTÈNE/WHALEDENT GMBH + Co. KG
Raiffeisenstrasse 30, 89129 Langenau
(Germany), DE

(540)

Stay-put

(511)

5 – Retraction cords and aids for taking impressions for dental purposes.

10 – Dental instruments.

(260) AM 2015 76649 A

(800) 851535

(891) 2014 02 06

(731) ANDREI IOSIFOVICH KOBZON
kv.15, str.1, d.12, B.Patriarshy pereulok
RU-123001 Moscow, RU

(540)

Жигули

(511)

43 – Services for providing food and drink, including coffee shops, cafeterias, restaurants (meals); bar services.

(260) AM 2015 76650 A

(800) 870216

(891) 2013 12 17

(731) SALVATORE FERRAGAMO S.P.A.
Via dei Tornabuoni, 2 I-50123 Firenze, IT

(540)

SALVATORE FERRAGAMO

(511)

35 – The bringing together, for the benefit of others, of a variety of goods excluding the transport thereof, such as soaps, perfumery, cosmetics, eyeglasses, jewellery, horological instruments, bags, wallets and other leather goods, umbrellas, fabrics, bed and table covers, towels, clothing, footwear, headgear, personal accessories, enabling customers to conveniently view and purchase those goods, as well as retail store services or wholesale services for the above mentioned products.

(260) AM 2015 76651 A

(800) 1083196

(891) 2014 01 28

(731) Cosmic, naamloze vennootschap
Schaliehoevestraat 14 a, Zone C B-2220
HEIST-OP-DEN-BERG, BE

(540)

PARK AVENUE

(511)

3 – Bleaching preparations and other substances for laundry use; cleaning, polishing, scouring and abrasive preparations; soap; perfumery, essential oils, cosmetics, hair lotions; dentifrices.

(260) AM 2015 76652 A

(800) 1084309

(891) 2014 02 24

(731) ACTELION PHARMACEUTICALS LTD
Gewerbstrasse 16 CH-4123 Allschwil, CH

(540)

IDORSIA

(511)

5 – Pharmaceutical preparations.

(260) AM 2015 76684 A
 (800) 1197073
 (891) 2013 11 07
 (731) CHINA NATIONAL HEAVY DUTY
 TRUCK GROUP CO., LTD.
 No:53, Wuyingshan Zhong Road, Jinan,
 Shandong Province, CN

(540)



(591) Black, white

(511)

12 – Automobiles; trucks; sports cars; engines for land vehicles; motors for land vehicles; propulsion mechanisms for land vehicles; automobile bodies; gear boxes for land vehicles; automobile tires; shock absorbers for automobiles.

(260) AM 2015 76689 A
 (800) 1197124
 (891) 2013 11 22
 (731) Henkel AG & Co. KGaA
 Henkelstraße 67, 40589 Düsseldorf, DE
 (540)

essence
ULTÎME

(591) Black, white

(511)

3 – Preparations for caring, cleaning, tinting, coloring, bleaching, fixing, styling and waving of hair.

(260) AM 2015 76740 A
 (800) 1197603
 (891) 2013 11 27
 (731) WEBZEN INC.
 242, Pangyo-ro, Bundang-gu, Seongnam-si,
 Gyeonggi-do, Korea (Sampyeong-Dong,
 Pangyo Digital Contents Park B Dong), KR

(540)



(591) Gun metal grey

(511)

9 – Computer game software; games cartridges for use with electronic games apparatus; computers; computer programs [downloadable software]; computer operating programs, recorded; downloadable digital music; downloadable electronic books; computer programmes [programs], recorded.

41 – Providing amusement arcade services; providing of recreation facilities; game services provided on-line from a computer network; electronic games

services provided by means of the internet or other communication network; publication of electronic books and journals on-line; providing non-downloadable on-line electronic publications; education information; instruction services.

(260) AM 2015 76744 A
 (800) 1197643
 (891) 2013 09 13
 (731) MONCLER S.P.A.
 Via Stendhal, 47, I-20144 MILANO, IT
 (540)



(591) Black, white

(511)

9 – Eyeglasses; sunglasses; anti-glare glasses, goggles for sports, swimming goggles, eyeglass and sunglass cases, eyeglass and sunglass lenses; eyeglass and sunglass frames; eyeglass and sunglass chains; eyeglass and sunglass cords; pince-nez; pince-nez cases; pince-nez chains; pince-nez cords; pince-nez mountings; correcting lenses [optics]; cases for electronic apparatus; scientific, nautical, surveying, photographic, cinematographic, optical, weighing, measuring, signalling, checking [supervision], life-saving and teaching apparatus and instruments; apparatus and instruments for conducting, switching, transforming, accumulating, regulating or controlling electricity; apparatus for recording, transmission or reproduction of sound or images; magnetic data carriers, recording discs; compact discs, DVDs and other digital recording media; mechanisms for coin-operated apparatus; cash registers, calculating machines, data processing equipment, computers; computer software; fire-extinguishing apparatus; ski goggles; spectacle cases; holders for contact lenses; optical lenses; lanyards for mobile phones; mobile phone covers; mobile phone cases; mobile phones; smartphones; smartphone covers; portable telephones; telephone card cases; cordless telephones; cordless telephone holders; mobile phone straps; mobile phone battery chargers; mobile phone battery charger cases; in-ear headphones; headphones; headphone cases; compact discs [audio-video]; DVDs; holders and cases for compact discs and digital video discs; protective carrying cases for portable music players; music and video player cases; digital audio players; loudspeakers; compact disc players; CD player cases; DVD players; DVD player cases; portable MP3 players; portable MP3 player cases; cases for tablet computers; protective covers for tablet computers; personal computer cases; computer mice; mouse pads; cases for laptops; computer carrying cases; computers; tablet computers; bags adapted for

laptops; docking stations for laptops; sleeves for laptops; electronic pagers; carrying cases for radio pagers; radios; radio cases; camera cases; lanyards for cameras; photographic cameras; digital photo frames; exposed slide film cases; video cameras; binocular cases; credit card cases [fitted holders]; magnetically encoded key cards; hands free kits for phones; hand-held computers; hand-held computers cases; slides [photography]; video screens; prerecorded magnetic tapes, cartridges and disks; wrist rests for use with computers; pocket calculators; electronic agendas; electronic agenda cases; walkie-talkies; antennas; audiovisual teaching apparatus; binoculars; telescopes; microscopes; exposed films; electronic game software for hand-held electronic devices; computer game software; computer keyboards; computer printers; home theater projectors; musical juke boxes; letter scales; rulers [measuring instruments]; decorative magnets; magic lanterns; holograms; optical discs; prisms [optics]; time clocks [time recording devices]; egg timers [sandglasses]; metronomes; protective masks; protective helmets for sports; magnifying glasses; magnifying glass cases; gloves for protection against accidents, irradiation and fire; footwear for protection against accidents, irradiation and fire; life jackets; knee and elbow pads and guards for protection against accidents; ear plugs for divers; ear plugs holders; road signs, luminous or mechanical; transmitters of electronic signals; balances [steelyards]; measures; vehicle breakdown warning triangles; reflecting discs for wear, for the prevention of traffic accidents; objectives [lenses] [optics]; altimeters; magnetic compasses for surveying; graduated glassware; petri dishes; magnetic wires; converters, electric; switches, electric; fuses; amplifiers; printed circuits; electric light regulators; remote controls; lightning conductors; igniting apparatus, electric, for igniting at a distance; electrolyzers; fire alarms; radiological apparatus for industrial purposes; safety nets; electric plugs; life buoys; safety tarpaulins; fire extinguishers; batteries, electric; magnets; teleprinters; anodes; fire engines; electric call bells; counters; electric cables; radar; sonars; automatic ticket dispensers; automated cash machines; electrical power supplies; stroboscopes; traffic cones; temperature indicator labels, not for medical purposes; pitot tubes; navigation apparatus for vehicles [on-board computers]; televisions; barometers; downloadable electronic publications; anti-theft warning apparatus; interactive whiteboards; electronic book readers; protective cases for electronic book readers.

(260) AM 2015 76747 A
 (800) 1197752
 (891) 2013 12 10
 (731) VIENNA INSURANCE GROUP AG
 Wiener Versicherung Gruppe, Schottenring
 30, A-1010 Vienna, AT

(540)



(591) Red-violet
 (511)
 36 – Insurance, financial affairs.

(260) AM 2015 76748 A
 (800) 590386
 (891) 2014 03 07
 (731) LOEWE S.A.
 Calle Goya, 4, E-28001 MADRID, ES
 (540)



(591) Black, white
 (511)
 3 – Bleaching preparations and other substances for laundry use; cleaning, polishing, degreasing and abrasive preparations; soaps; perfumery, essential oils, cosmetics, hair lotions; dentifrices.

(260) AM 2015 76749 A
 (800) 804455
 (891) 2014 02 24
 (731) SOCIETA' ITALIANA ACETILENE E
 DERIVATI S.I.A.D. S.p.A. in breve S.I.A.D.
 S.p.A.
 92, via S. Bernardino, I-24126 BERGAMO, IT
 (540)



(591) Black, white
 (511)
 4 – Combustible and lighting gases.
 5 – Gases for medical use.

(260) AM 2015 76750 A
 (800) 1002249
 (891) 2014 01 31
 (731) ITO EN, LTD.
 47-10, Honmachi 3-chome, Shibuya-ku,
 Tokyo 151-8550, JP
 (540)



(591) Black, white

(511)

30 – Tea, green tea; Chinese (oolong) tea; jasmine tea, tea beverages; green tea beverages; Chinese (oolong) tea beverages; jasmine tea beverages; coffee; coffee-based beverages; unroasted coffee; cocoa; cocoa-based beverages; seasonings; vinegar; soy sauce; ketchup (sauce); dressings; mustard; celery salt; salt; nutmegs; allspices, spices; curry (spice); peppers (seasonings); turmeric for food; weeds (condiments), aniseeds; rice; wheat flour; rice flour, crushed barley; bean meal; cake powder; corn flour; flour for food; groats for human food, husked barley; husked oats, potato flour for food; semolina; starch products for food; tapioca flour for food; edible gluten; almond paste; confectionery; almond confectionery; bread rolls; buns; cakes; liquorice (confectionery); pastries; biscuits, peppermint sweets; sugar confectionery; tarts, waffles, candy for food; chewing gum, not for medical purpose; chocolate, popcorn; crackers, edible decoration for cakes; fruit jellies (confectionery), gingerbread; peanut confectionery, meat pies; sandwiches; box lunch; cereal preparations, chips (cereal products); corn flakes; oat flakes; farinaceous foods; aromatic preparations for food (not from "essential oils"); essences for food stuffs (except etheric essences and essential oils); flavoring, other than essential oils; vanilla (flavoring); frozen yoghurt (confectionery ices); ice cream; sherbets (ices); edible ices; noodles, pasta; ravioli; natural sweeteners; honey; yeast; chrystal sugar; ice cream mixes, sherbet mixes.

32 – Carbonated drinks; mineral water beverages; isotonic beverages, fruit juice beverages; vegetable juice beverages; whey beverages.

(260) AM 2015 76751 A

(800) 1123424

(891) 2014 01 28

(731) B.I.G. Floorcoverings
Rijksweg 442, B-8710 Wielsbeke, BE

(540)



(591) Grey, white and red

(511)

23 – Yarns and threads, for textile use.

27 – Carpets, rugs, mats and matting, linoleum and other materials for covering existing floors.

(260) AM 2015 76753 A

(800) 1144360

(891) 2013 09 11

(731) Tovarishchestvo s ogranichennoy
otvetstvennostju "KAZAKHSTANSKIY
KHUDOZHESTVENNIY FOND"
ul. Ryskulova, 97, 050058 Almaty, KZ

(540)



(591) Black, white

(511)

32 – Beers; de-alcoholized beverages; mineral and aerated waters and other non-alcoholic beverages; fruit beverages and fruit juices; syrups and other preparations for making beverages.

33 – Alcoholic beverages except beers.

(260) AM 2015 76755 A

(800) 1161217

(891) 2014 01 27

(731) SHIONOGI & CO., LTD.
1-8, Doshomachi 3-chome, Chuo-ku, Osaka-shi,
Osaka 541-0045, JP

(540)

OSPHERA

(511)

5 – Pharmaceutical preparations; pharmaceutical preparations for use in the treatment of menopausal disorders and other disorders of aging women.

(260) AM 2015 76769 A

(800) 1197857

(891) 2013 11 22

(731) Zakrytoe aktsionernoe obshchestvo
"STARODVORSKIE KOLBASY"
ul. Poliny Osipenko, 41, RU-600009,
Vladimir, RU

(540)



(591) White, dark-brown, yellow and red-wine coloured

(526) – The trademark is protected as a whole. The word "КОЛБАСЫ" included therein shall not be subject to independent legal protection.

(511)

29 – Charcuterie; black pudding.

(260) AM 2015 76820 A

(800) 1198198

(891) 2013 10 26

(731) ABSTRAGAN HOLDING LIMITED
Las Suite, 5 Percy Street, London
W1T 1DG, GB

(540)

Love and Care Любовь и Забота

(591) Black, white

(511)

3 – Adhesives for cosmetic purposes; after sun lotions; after sun moisturisers; aftershave; aftershave balm; aftershave creams; after-shave gel; after-shave lotions; aftershave milk; aftershave moisturising cream; after-sun gels [cosmetics]; after-sun oils [cosmetics]; aloe vera preparations for cosmetic purposes; anti-aging creams; anti-bacterial soap; anti-freckle creams; anti-perspirant deodorants; anti-perspirant preparations; antiperspirant soap; anti-perspirants; antiperspirants [toiletries]; antistatic preparations for household purposes; anti-wrinkle cream; aromatherapy preparations; aromatic essential oils; aromatic oils; astringents for cosmetic purposes; baby lotion; baby oil; baby oils; baby powder; baby shampoo; baby shampoo mousse; baby wipes; balms other than for medical purposes; barrier creams; barrier creams for the skin; base cream; bath foam; bath gel; bath herbs; bath oil; bath salts; bath soap; cosmetic preparations for baths; beard dyes; beauty masks; flavorings [flavourings] for beverages [essential oils]; biological laundry detergents; bleaches for use on the hair; bleaching preparations; bleaching preparations and other substances for laundry use; bleaching preparations [decolorants] for cosmetic purposes; bleaching preparations for the hair; bleaching preparations [laundry]; body butter; body cream; body creams [cosmetics]; body emulsions; body glistening oil; body masks; body moisturisers; body oil; body oil spray; body paint [cosmetic]; body powder; body scrub; body shampoos; body sprays; body talcum powder; cleansing creams; cleansing foam; cleansing gels; cleansing lotions; cleansing masks; cleansing milk for toilet purposes; cold cream, other than for medical use; collagen preparations for cosmetic application; cologne; cosmetic eye gels; cosmetic eye pencils; cosmetic oils; cosmetic powder; cosmetic preparations; cosmetic preparations for slimming purposes; cosmetic preparations for use as aids to slimming; cosmetics; cosmetics for personal use; cotton balls for cosmetic purposes; cosmetic creams; soap creams for use in washing; dental bleaching gel; dental bleaching gels; dentifrices; deodorants, for personal use in the form of sticks; depilatory creams; depilatory lotions; depilatory preparations; eye crayon; eye cream; eye gels; face creams; face powder; facial cleansers; facial cleansers [cosmetic]; facial cream; facial creams [cosmetic]; facial lotions [cosmetic]; hair balm; hair cosmetics; hair gel; hair lotions; hair protection creams; hair protection gels; hair removing cream; hair spray; hand barrier creams; hand cleaner; hand cream; massage gels other than for medical purposes; medical toothpastes; medicated shampoo; medi-

cated shampoos; medicated soap; natural oils for cleaning purposes; neutralizing hair preparations; night cream; oils for cleaning purposes; oils for cosmetic purposes; oils for perfumes and scents; oils for the body [cosmetics]; oils for toilet purposes; ointments for cosmetic use; perfumery; perfumery, essential oils, cosmetics, hair lotions; perfumes; pre-shaving preparations; room fragrances; room fragrancing preparations; rust removers; rust removing preparations; scented toilet waters; scented water; shaving balm; shaving foam; shaving gel; shaving lotion; shaving mousse; shaving preparations; shaving preparations in liquid form; shaving soap; shaving sprays; shaving sticks [preparations]; shaving stones; shaving stones [astringents]; skin care creams, other than for medical use; skin care lotions [cosmetic]; skin whitening preparations [cosmetic]; slimming aids [cosmetic], other than for medical use; soap; cakes of soap; deodorant soap; disinfectant soap; soap for brightening textile; soap for foot perspiration; soap pads; soap powder; soap solutions; soaps; soaps in liquid form; liquid gel soap; bleaching soda; sun protecting creams [cosmetics]; sun screen; sun-tanning preparations [cosmetics]; washing creams; washing liquids; washing powder; washing preparations; washing preparations for household purposes; washing preparations for personal use; washing soda, for cleaning.

5 – Adhesive band for medical use; adhesive bands for medical purposes; adhesive compositions for medical use; adhesive plaster; adhesive tapes for medical purposes; alcohol for pharmaceutical purposes; allergy medications; allergy relief medication; anti-allergic medicines; antibiotics; antitussives; appetite stimulant preparations; baby foods; balms for medical purposes; balsamic preparations for medical purposes; biological preparations for medical purposes; cardiovascular preparations; chemical preparations for medical purposes; chemical preparations for pharmaceutical purposes; chemical preparations for testing blood for medical purposes; chemical preparations for the diagnosis of diabetes; cotton for medical purposes; cough syrups; court plaster; dietary supplemental drinks; dietary supplements; dietary supplements for humans and animals; dietary supplements for infants; dietary supplements for medical use; dietetic beverages adapted for medical purposes; dietetic confectionery adapted for medical purposes; dietetic food and substances adapted for medical or veterinary use, food for babies; dietetic foods adapted for infants; dietetic foods adapted for invalids; dietetic foods adapted for medical purposes; dietetic foods for medicinal purposes; dietetic foodstuffs for medical purposes; dietetic infusions for medical use; dietetic preparations adapted for medical use; dietetic products for medical purposes; dietetic substances adapted for medical use; dietetic sugar for medical use; disinfectants; disinfectants for hygiene purposes; disinfectants for medical instru-

ments; dragees [medicines]; dressing retention materials; dressings, medical; medicinal drinks; elixirs for preventing chills; elixirs for preventing colds; elixirs for relieving asthma; elixirs for relieving chills; elixirs for relieving colds; elixirs [pharmaceutical preparations]; enzyme dietary supplements; enzyme preparations for medical purposes; enzyme preparations for veterinary purposes; enzymes for medical purposes; enzymes for veterinary purposes; eye drops; eye lotions for medical use; eye ointment for medical use; food for babies; food for diabetics; food for infants; food for invalids; food supplements for dietetic use; foodstuffs for diabetics [specially made for]; medicated foot balms; medicated foot creams; gastrointestinal preparations; glucose dietary supplements; glucose for medical purposes; glucose preparations for medical purposes; hemoglobin; herbal medicine; medicinal herbs; immunoassay reagents for medical use; immunomodulators; medical preparation for slimming purposes; medicated baby powders; medicated balms; medicated plasters; medicated skin lotions; medicated sugar; medicinal beverages; medicinal creams for skin care; medicinal herbal extracts for medical purposes; medicinal infusions; medicinal oils; medicinal preparations for stimulating hair growth; medicated mineral drinks; mineral food supplements; mineral salts for medical purposes; mineral water salts; mineral waters for medical purposes; nasal decongestants; nervines; nutritional supplements; ointments for pharmaceutical purposes; ophthalmologic preparations; pain relief medication; pharmaceutical and veterinary preparations; pharmaceutical compositions; pharmaceutical creams; pharmaceutical implants; pharmaceutical lipsalves; pharmaceutical preparations; pharmaceutical preparations for animal skincare; pharmaceutical preparations for animals; pharmaceutical preparations for skin care; pharmaceutical preparations for treating dandruff; pharmaceutical preparations for veterinary use; pharmaceutical preparations in strip form; pharmaceutical skin lotions; pharmaceutical sweets; pharmaceuticals for the treatment of erectile dysfunction; plasters [dressings]; plasters for medical purposes; plasters, materials for dressings; preparations for destroying pests; preparations for destroying vermin; preparations for ocular lubrication; preparations for use as additives to food for human consumption [medicated]; sanitary knickers; sanitary pads; sanitary panties; sanitary preparations for medical purposes; sanitary tampons; sanitary towels; sanitary wear; siccatives [drying agents] for medical purposes; styptic preparations; sugar for medical purposes; sugar substitutes for diabetics; tampons [sanitary]; therapeutic creams [medical]; tonics preparations for medical purposes; vitamins for animals; medicated hand wash; eye pads for medical use; eye patches for medical use; eye shields for medical use; magnetic bracelets for medical purposes.

10 – Abdominal pads for medical use; supportive adhesive bandages; suspensory adhesive bandages; adhesive drapes for surgical use; adhesive suture materials; aerosol dispensers for medical purposes; aerosol dispensers for medical use; air inflatable garments for medical purposes; alternating pressure mattresses for medical use; ambulance stretchers; anaesthesia monitoring apparatus; anaesthesia respiration apparatus; anaesthetic apparatus; anaesthetic masks; anesthesia masks; anesthetic masks; apparatus for achieving physical fitness [for medical use]; apparatus for administering drugs by inhalation; apparatus for administering pharmaceuticals; apparatus for analysing alcohol in body fluids [for medical use]; apparatus for analysing alcohol in breath fluids [for medical use]; apparatus for blood analysis; apparatus for blood analysis [for medical use]; apparatus for blood monitoring [for medical use]; apparatus for blood tests [for medical use]; apparatus for cardiac defibrillation; apparatus for carrying-out diagnostic tests for medical purposes; apparatus for cleansing blood during surgical procedures; apparatus for dialysis for veterinary use; apparatus for echocardiography imaging; apparatus for phototherapy; apparatus for physical training for medical use; apparatus for physiotherapeutic treatment; apparatus for producing oxygen for medical use; apparatus for taking blood; apparatus for the application of laser radiation for medical purposes; apparatus for the application of laser radiation for surgical purposes; apparatus for the diagnosis of cardiovascular diseases; apparatus for the therapeutic stimulation of the body; apparatus for veterinary purposes; medical apparatus for extracting oxygen from the atmosphere; applicators for medications; artificial eyes; apparatus for artificial respiration; artificial skin for surgical purposes; artificial sponges for medical purposes; audiometers; babies' bottles; babies' feeding bottles; baby bottle nipples; baby dummies; baby nursers; back supports for medical purposes; bags [fitted] for medical instruments; bags [fitted] for use by doctors; bags [fitted] for use by surgeons; bags for collecting body fluids; bags for collecting body waste; bags for endoscopic retrieval of tissue; bags for medical use in collecting urine samples; bags for medical use in storing urine samples; bags for surgical use in collecting urine; bandage applicators; bandage clips; bandages, elastic; supportive bandages; basins for medical purposes; belts, electric, for medical purposes; belts for attaching medical monitors to patients; belts for medical purposes; belts for orthopaedic purposes; belts for surgical purposes; orthopaedic [orthopedic] belts; blood collection tubes for medical use; blood collection tubes for surgical use; blood filters; blood testing apparatus; boxes adapted for medical use; boxes adapted for medical waste products; braces for application to the human body; cardiovascular instruments; cardiovascular monitors; cardiovascular needles; cardiovas-

cular pumps; cases fitted for medical instruments; cases fitted for surgical instruments; chromatographic apparatus for medical use; chromatographic instruments for medical use; chromatography apparatus for medical use; chromatography instruments for medical use; chromatography plates for medical use; compressors for medical [treatment] purposes; computer controlled exercise apparatus for therapeutic use; computer controlled training apparatus for therapeutic use; computerised tomography apparatus; conforming bandages; dental apparatus; dental apparatus, electric; dental instruments; dental prostheses; detecting instruments for medical use; detectors for medical applications; diagnostic apparatus for medical purposes; diagnostic imaging apparatus for medical use; diagnostic instruments for medical use; diagnostic instruments for ophthalmology; diagnostic measuring apparatus for medical use; diagnostic testing apparatus for use in immunoassay procedures [medical]; diagnostic ultrasound apparatus for medical use; diagnostic ultrasound instruments for medical use; digital thermometers for medical purposes; elastic bandages; electrical nerve stimulators; electrically operated massagers; electro medical instruments; electroaesthetical apparatus; electroaesthetical instruments; electrocardiograph apparatus; electrocardiograph instruments; electrocardiograph monitoring apparatus; electrocardiograph monitors; electrocardiographs; electrocardiography apparatus; electromedical diagnostic instruments; electronic analyzers for medical purposes; electronic apparatus for medical purposes; endoscopes; endoscopes for diagnostic use; endoscopes for surgical use; endoscopic apparatus; endoscopic equipment; examination gloves for medical use; eye droppers; eye pads for surgical use; eye shields for surgical use; fibre optic instruments for medical purposes; gastroscopes; gloves for dental use; gloves for massage; gloves for medical examinations; gloves for medical purposes; gloves for medical use; gloves for use during operations; gloves for use in hospitals; gloves for veterinary use; hemostatic devices; hemostatic instruments; hemostats; ice bags for medical purposes; ice bags for medical use; injection device for pharmaceuticals; injection instruments without needles; injection needles; injection needles for medical use; injection sleeves for medical use; injection syringes for medical purposes; injection syringes [syringe barrels]; injectors for medical purposes; instrument cases for use by surgeons and doctors; instruments for applying dental filling; instruments for cardiac stimulation; instruments for extracting human body fluids; instruments for use in medical analysis; instruments for use in the fitting of artificial teeth; instruments for use in the fitting of dental prostheses; instruments for use in the preparation of artificial teeth; knife blades [surgical]; knives [corn knives for medical use; knives for surgical purposes; lamps for medical purpo-

ses; laryngoscopes; lasers for dental purposes; lasers for medical purposes; lasers for ophthalmic purposes; lasers for use in surgery; magnetic field generators for medical use; magnetic treatment apparatus for medical use; magnets for therapeutic use; manometer lines for medical use; manometers for medical use; manual massage instruments; massage apparatus; massage apparatus [for medical purposes]; medical analysis instruments; medical analytical apparatus for medical purposes; medical apparatus and instruments; medical diagnostic apparatus for medical purposes; medical diagnostic instruments; medical gloves; medical instruments; medical knives; medical lasers; medical masks; medical prostheses; medical testing instruments; medical therapy instruments; mirrors for dentists; mirrors for medical examination purposes; optical imaging for medical diagnostic use; optical instruments for medical endoscopy; optical scanners for medical inspection purposes; optometric instruments; physiological apparatus for medical use; physiological measuring apparatus for medical use; physiological monitoring apparatus for medical use; physiotherapy apparatus; plaster bandages for orthopaedic purposes [casts (Am.)]; plaster for medical or surgical purposes; prostheses; pulse meters for medical purposes; scanners for medical diagnosis; scanning instruments for medical use; surgical apparatus and instruments; tonometers; veterinary apparatus and instruments; vibromassage apparatus.

(260) AM 2015 76835 A

(800) 1198242

(891) 2013 12 10

(731) VIENNA INSURANCE GROUP AG Wiener
Versicherung Gruppe
Schottenring 30, A-1010 Vienna, AT

(540)



(591) Green

(511)

36 – Insurance, financial affairs.

(260) AM 2015 76837 A

(800) 1198274

(891) 2014 01 23

(731) Obschestvo s ogranichennoy otvetstvennostyu
"LABORATORIYA SOVREMENNOGO
ZDOROVYA"
ul. Khimzavodskaya, 11/20, Berdsk,
RU-633004 Novosibirskaya oblast', RU

(540)

MELLIVITALS

(511)

5 – Albumin dietary supplements; albuminous food-stuffs for medical purposes; albuminous preparations for medical purposes; alginate dietary supplements; aloe vera preparations for pharmaceutical purposes; antioxidant pills; appetite suppressant pills; balms for medical purposes; bath preparations, medicated; biocides; biological preparations for medical purposes; by-products of the processing of cereals for dietetic or medical purposes; casein dietary supplements; cod liver oil; decoctions for pharmaceutical purposes; dietary fiber; dietetic beverages adapted for medical purposes; dietetic foods adapted for medical purposes; dietetic substances adapted for medical use; digestives for pharmaceutical purposes; enzyme dietary supplements; flaxseed dietary supplements; flaxseed oil dietary supplements; flour for pharmaceutical purposes; food for babies; glucose dietary supplements; hematogen; lacteal flour for babies; lecithin dietary supplements; liniments; lotions for pharmaceutical purposes; medicinal herbs; medicinal infusions; medicinal oils; medicinal roots; medicinal tea; milk of almonds for pharmaceutical purposes; milk ferments for pharmaceutical purposes; mineral food supplements; nervines; nutritional supplements; pearl powder for medical purposes; pharmaceutical preparations for skin care; pollen dietary supplements; propolis for pharmaceutical purposes; preparations of trace elements for human and animal use; propolis dietary supplements; protein dietary supplements; royal jelly dietary supplements; royal jelly for pharmaceutical purposes; slimming pills; serums; sugar for medical purposes; tonics [medicines]; vitamin preparations; wheat germ dietary supplements; yeast dietary supplements; yeast for pharmaceutical purposes.

(260) AM 2015 76838 A

(800) 1198281

(891) 2014 03 03

(731) ACEITES DEL SUR-COOSUR S.A.

Carretera de la Carolina, 29 E-23220

Vilches (Jaén), ES

(540)

COOSUR

(511)

29 – Olive oils, edible oils, preserved olives.

30 – Vinegar, sauces (condiments).

(260) AM 2015 76850 A

(800) 1198315

(891) 2013 10 23

(731) MERKUR GAMING GMBH

Borsigstraße 26, 32312 Lübbecke, DE

(540)

City Crushers

(511)

9 – Scientific, nautical, surveying, photographic, cinematographic, optical, weighing, measuring, signalling, checking (supervision), life-saving and teaching apparatus and instruments; apparatus and instruments for conducting, switching, transforming, accumulating, regulating or controlling electricity; apparatus for recording, transmission or reproduction of sound or images; magnetic data carriers, recording discs; compact discs, DVDs and other digital recording media; cash registers, calculating machines, data processing equipment, computers; computer software; fire-extinguishing apparatus; musical jukeboxes and parts for the aforesaid automatic machines; automatic cash dispensers, automatic money counting and money changing machines; mechanisms for coin-operated apparatus; computer and video games software; games software for use on any computer platform, including electronic entertainment and games consoles; programs for computer games; computer games; video games (software); computer games provided through a global computer network or supplied by means of multi-media electronic broadcast or through telecommunications or electronic transmission or via the internet; computer games, electronic games, electronic entertainment, leisure and recreational software, video games and computer software, all provided in the form of storage media; programs for operating electric and electronic apparatus for games, amusement and/or entertainment purposes; automatic lottery machines; computer software for computer games on the internet; online games (software); computer software in the form of an app for mobile devices and computers; calculating apparatus in coin-operated machines and parts for the aforesaid goods; apparatus for recording, transmission, processing or reproduction of data, including sound or images, including parts for all the aforesaid goods, except radio sets, television receivers, hi-fi systems, video recorders, telephone apparatus, fax machines and telephone answering machines; computer hardware and software for casino and amusement arcade games, for gaming machines, slot machines or video lottery gaming machines or games of chance via the internet; electric, electronic, optical or automatic apparatus, for identifying data carriers, identity cards and credit cards, bank notes and coins; electric, electronic or optical alarm and monitoring installations, including video cameras and apparatus for image transmission and image processing; data processing equipment and computers, including data processing apparatus and computers being components for data networks and parts facilitating data network communications; electric wiring harnesses; circuit boards, printed circuit boards (electronic components) and combina-

tions thereof, being assemblies and parts for apparatus, included in this class.

28 – Games; toys; gymnastic and sporting articles not included in other classes; decorations for christmas trees; gaming apparatus (including coin-operated apparatus); coin-operated arcade games (machines); games for amusement arcades (included in this class); coin-operated video gaming apparatus; video games adapted for use with external screens or monitors only; casino fittings, namely roulette tables, roulette wheels; coin-operated automatic gaming machines and gaming machines, in particular for gaming arcades, with or without a prize payout; electronic or electrotechnical gaming apparatus, automatic gaming machines, gaming machines, slot machines operated by coins, tokens, banknotes, tickets or by means of electronic, magnetic or biometric storage media, in particular for commercial use in casinos and amusement arcades, with or without a prize payout; automatic gaming machines and gaming machines, in particular for commercial use in casinos and gaming arcades, with or without a prize payout; coin-operated gaming machines and/or electronic money-based gaming apparatus (machines), with or without prizes; housings adapted for gaming machines, gaming apparatus and automatic gaming machines, operated by means of coins, tokens, tickets or by means of electronic, magnetic or biometric storage media, in particular for commercial use in casinos and gaming arcades, with or without a prize payout; electronic games; electronic game entertainment apparatus and accessories; video output game machines; drawing apparatus for prize games and lotteries, draws or raffles; housings of metal, plastic and/or wood for coin-operated automatic machines; apparatus for games (including video games), other than adapted for use with external screens or monitors only; electropneumatic and electric pulling machines (gaming machines); gaming tables, in particular for table football, billiards, sliding games; quoits (playthings) and darts; electric, electronic or electromechanical apparatus for bingo games, lotteries or video lottery games and for betting offices, networked or unnetworked; lcd games consoles; automatic gaming machines; including all the aforesaid automatic machines, machines and apparatus operating in networks; apparatus and devices for accepting and storing money, being fittings for the aforesaid automatic machines, included in this class.

41 – Education; providing of training; entertainment; sporting and cultural activities; rental of automatic slot machines and entertainment machines for casinos; arranging and conducting games; gambling; operating lotteries; games on the internet, including online and being applications for smartphones; online game services (of a computer network); provision of entertainment and/or educational content for

apps for mobile devices and computers; conducting quizzes by means of smartphone applications; providing casino facilities (gambling), betting offices; operating gaming establishments, arcades and/or online internet casinos and betting platforms; gambling services via the internet.

(260) AM 2015 76855 A

(800) 1198419

(891) 2013 12 09

(731) ZHEJIANG YINGCHANG GLASSES INDUSTRIAL CO., LTD.

Duqiao, Linhai, Taizhou City, Zhejiang, CN

(540)

DONNA

(591) Black, white

(511)

9 – Spectacles [optics]; spectacle frames; pince-nez mountings, eyeglass frames; sunglasses; pince-nez, eyeglasses; spectacle cases; pince-nez, eyeglasses; contact lenses.

(260) AM 2015 76861 A

(800) 1198486

(891) 2013 10 29

(731) AVOS SYSTEMS, INC.

345 South B Street, San Mateo CA 94401, US

(540)

MIXBIT

(591) Black, white

(511)

9 – Computer software that allows users to engage in social networking and collaboratively create, edit, view, upload, post, show, display, blog, and otherwise provide and share information, photos, videos, and multimedia content over the internet and/or other communications networks; mobile computer software that allows users to engage in social networking and collaboratively create, edit, view, upload, post, show, display, blog, and otherwise provide and share information, photos, videos, and multimedia content over the internet and/or other communications networks; computer software platforms for users to create, edit, view, upload, post, show, display, bog, and otherwise provide and share information, photos, videos, and multimedia content over the internet and/or other communications networks; collaborative video creation and social networking software.

38 – Telecommunications services, namely, transmission of audio, video, and multimedia files over global computer networks and/or global communications networks; computer services, namely, providing online facilities for real-time interaction with other computer users to interact with one another,

engage in social networking, and collaboratively create, edit, view, upload, post, show, display, blog, and otherwise provide and share information, photos, videos, and multimedia content over the internet and/or other communications networks concerning topics of general interest.

42 – Providing a website featuring technology that allows users to engage in social networking and collaboratively create, edit, view, upload, post, show, display, blog, and otherwise provide and share information, photos, videos, and multimedia content over the internet and/or other communications networks; providing a non-downloadable web-based and cloud-based software that allows users to engage in social networking and collaboratively create, edit, view, upload, post, show, display, blog, and otherwise provide and share information, photos, videos, and multimedia content over the internet and/or other communications networks; platform as a service (PAAS) featuring computer software platforms that allows users to engage in social networking and collaboratively create, edit, view, upload, post, show, display, blog, and otherwise provide and share information, photos, videos, and multimedia content over the internet and/or other communications networks; platform as a service (PAAS) featuring computer software platforms featuring temporary use of online non-downloadable software that allows users to engage in social networking and collaboratively create, edit, view, upload, post, show, display, blog, and otherwise provide and share information, photos, videos, and multimedia content over the internet and/or other communications networks; application service provider featuring application programming interface (API) software for allowing data retrieval, upload, access and management; application programming interface (API) software for use in building software applications; application service provider featuring application programming interface (API) software for integration of audio, video, image, and text data onto Internet websites and applications on mobile computer devices; application service provider featuring application programming interface (API) software to ingest, process, store, manage, create, share, distribute and archive audio-visual content, namely, but not only, sound, video, text, binary, still images, graphics and multimedia files.

(260) AM 2015 76865 A
(800) 1198562
(891) 2014 01 28
(731) Tovarystvo z obmedzeniou vidpovidalnistiu "AMAKSA"
vul. Pryrichna, 27 Ye, Kyiv 04213, UA
(540)

Amagestin

(511)
5 – Medicines for human purposes, namely, medicines for urinary tract treatment.

(260) AM 2015 76866 A
(800) 827132
(891) 2014 01 29
(731) DUKTUS ROHRSYSTEME WETZLAR GMBH
Sophienstraße 52-54, 35576 Wetzlar, DE
(540)

BLS

(511)
17 – Junctions for pipes not of metal; shaped parts of junctions for pipes not of metal, included in this class.

(260) AM 2015 76867 A
(800) 1157542
(891) 2013 01 24
(731) PUR NATUR INVEST,
naamloze vennootschap
Hoogstraat 25, B-9770 KRUISSHOUTEM, BE
(540)



(591) Green, yellow and white
(511)
29 – Meat, fish, poultry and game; meat extracts; preserved, dried and cooked fruits and vegetables; fruit (cooked), fruit (frozen); fruit, preserved; tinned fruit; jellies, jams, compotes; fruit jellies, jams; eggs, milk and milk products; milk (curdled); drinks based on milk or predominantly of milk, cream (dairy products); cream; edible oils and fats; whipped cream.
30 – Coffee, tea, cocoa, artificial coffee; rice, tapioca, sago; flour and preparations made from cereals, muesli, bread, pastry and confectionery, ices, frozen yoghurt, ice cream; sugar, honey, treacle; yeast, baking-powder; salt; mustard; vinegar, sauces (condiments); spices.

(260) AM 2015 76868 A
(800) 1186532
(891) 2013 12 31
(731) LIU.JO S.P.A.
Viale John Ambrose Fleming 17, I-41012
Carpi, Modena, IT
(540)

REBELQUEEN

(511)

14 – Jewellery and imitation jewellery, namely, earrings, bracelets, necklaces, neck chains, jewelry rings, ankle bracelets, pendants, charms for collar jewelry and bracelets, jewelry brooches, cuff-links, tie pins, jewelry cases, key rings of precious metal, ornamental pins, personal ornaments of precious metal, hat ornaments of precious metal, shoe ornaments of precious metal; precious stones; clocks; watches; wristwatches; alarm clocks; pocket watches; chronometers; chronographs for use as timepieces and chronographs for use as watches; watch straps; watch chains; watch cases.

18 – Trunks; travelling bags; shoulder bags; handbags; boston bags; waist packs; reusable shopping bags; duffle bags; tote bags; evening handbags; clutch bags; wallets; purses; leather credit card cases; leather business card cases; briefcases; attache cases; pouches of leather; school bags; satchels; suitcases; garment bags for travel; leather key cases; backpacks; rucksacks; vanity cases sold empty; carry-on bags; beach bags; umbrellas; parasols; walking sticks.

25 – Pullovers; cardigans; sweaters; jumpers; jackets; parkas; swimwear; one-piece swimsuits; bikinis; pareos; kaftans; blouses; sweat pants; sweat shirts; shirts; polo shirts; trousers and pants; jeans; waistcoats; skirts; beach shorts; boxer shorts; cycling shorts; gym shorts; swimming shorts; tennis shorts; bermuda shorts; shorts; T-shirts; leisure suits; boleros; shrugs; dresses; women's dresses; men's suits; women's suits; evening gowns; wedding dresses; wedding suits; cocktail dresses; smoking jackets; tuxedos; coats; blousons; half coats; raincoats; anoraks; down jackets; overcoats; fur coats; fur jackets; clothing of leather, namely, leather coats, leather hats, leather jackets, leather trousers, leather skirts and leather shirts; tracksuits; overalls; underwear; bathrobes; brassieres; underpants; thong underwear; G-strings; knickers; camisoles; vests; tops as clothing; bustiers; corsets; night gowns; dressing gowns; pajamas; hosiery and panty-hoses; tights; stockings; chemisettes; slippers; socks; leg warmers; foulards for clothing; capes; ponchos; sashes for clothing; shawls; scarves; neckties; gloves for clothing; belts for clothing; braces for clothing; shoes; leather shoes; rubber shoes; wooden shoes; rain shoes; rain boots; gymnastic shoes; sneakers; boots; half-boots; sandals; flip-flops; slippers; clogs; hats and caps.

(260) AM 2015 76870 A

(800) 1198601

(891) 2013 12 10

(731) TIANJIN RLFD BICYCLE TRADE CO.,LTD
Hexingzhuang Waihuanxian Waice No:1#244,
Dongli, 300300 Tianjin City, CN

(540)



(591) Black, white

(511)

12 – Bicycles; saddles for bicycles, cycles or motorcycles; mudguards; vehicles for locomotion by land, air, water or rail; bicycle brakes; luggage carriers for vehicles; bicycle pumps; vehicle wheel tires [tyres]; repair outfits for inner tubes; electric vehicles.

(260) AM 2015 76875 A

(800) 1198617

(891) 2014 03 11

(731) PHILIP MORRIS PRODUCTS S.A.

Quai Jeanrenaud 3, CH-2000 Neuchâtel,
CH

(540)



(591) Black, white

(511)

34 – Tobacco, raw or manufactured; tobacco products, including cigars, cigarettes, cigarillos, tobacco for roll-your-own cigarettes, pipe tobacco, chewing tobacco, snuff tobacco, kretek; snus; tobacco substitutes (not for medical purposes); smokers' articles, including cigarette paper and tubes, cigarette filters, tobacco tins, cigarette cases and ashtrays, pipes, pocket apparatus for rolling cigarettes, lighters; matches.

(260) AM 2015 76876 A

(800) 1198619

(891) 2014 03 11

(731) JAPAN TOBACCO INC.

2-2-1 Toranomon, Minato-ku, Tokyo, JP

(540)

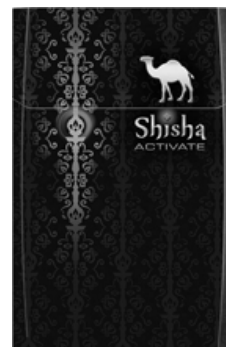

(591) Black, white

(511)

34 – Tobacco, raw or manufactured; smoking tobacco, pipe tobacco, rolling tobacco, chewing tobacco, moist tobacco powder called "snus"; cigarettes, cigars, cigarillos; snuff; smokers' articles included in

this class; cigarette paper, cigarette tubes and matches.

(260) AM 2015 76877 A
 (800) 1198622
 (891) 2014 03 12
 (731) JAPAN TOBACCO INC.
 2-2-1 Toranomom, Minato-ku, Tokyo, JP
 (540)



(591) Black, white
 (511)

34 – Tobacco, raw or manufactured; smoking tobacco, pipe tobacco, rolling tobacco, chewing tobacco, moist tobacco powder called "snus"; cigarettes, cigars, cigarillos; snuff; smokers' articles included in this class; cigarette paper, cigarette tubes and matches.

(260) AM 2015 76879 A
 (800) 1198709
 (891) 2013 11 27
 (731) Limited liability company "VIKTORIYA"
 Pobedy Street, 102, RU-352630 Belorechensk,
 Krasnodarskiy Kray, RU
 (540)

ВЫБЕРИ МЕНЯ

(511)
 30 – Sponge dough products, namely, sponge cake roll, sponge layer cake, sponge plum cake, sponge pie, sponge dough discs; waffles; pastry; caramels; candy; fruit jellies; cookies; puddings; sweetmeats; chocolate.

(260) AM 2015 76887 A
 (800) 1198838
 (891) 2014 01 31
 (731) FASHION ONE TELEVISION LLC
 246 West Broadway, New York, NY 10013,
 US
 (540)

Fazz

(511)
 38 – Internet protocol television (IPTV) transmission services; Simulcasting broadcast television over

global communication networks, the Internet and wireless networks; Television broadcasting.

(260) AM 2015 76889 A
 (800) 1198856
 (891) 2013 10 10
 (731) PRIVATE JOINT STOCK COMPANY
 "INDUSTRIAL ASSOCIATION "KONTI"
 Bul. Shevchenko, 6-b, Donetsk 83015, UA
 (540)

Сладкая магия

(511)
 30 – Confectionery; peanut confectionery; biscuits; pastries; bread rolls stuffed (confectionery); waffles; waffle cakes; products of puff pastry stuffed; glazed and not glazed candies; candied roasted nuts (confectionery); desserts (confectionery); dragee (confectionery); yeast and not yeast baking; fruit and berry jellies (confectionery); jelly confectionery; jelly candies; chewing gum; frozen kefir; frozen yogurt; frozen bakery; marshmallow; marshmallow covered with chocolate; cocoa-based ingredients for confectionery products; cocoa; cocoa mixes; cocoa spreads; cocoa powder; caramels (candy); lozenges (confectionery); cakes; brittle; crackers; starch foods; croissant; confectionery for decorating Christmas trees; liquorice (confectionery); candy for food; marzipan; marzipan candies; almond confectionery; mousses (confectionery); candy sets; chocolate beverages; paskha (Easter cake); paste; cookies; cookies glazed with chocolate; quiches (confectionery); pies; fondants (confectionery); pralines; gingerbread; gingerbread covered with chocolate; puddings; Turkish delight; rice cakes; bagel; dessert sauces (condiments); soufflé (whipped chocolate confectionery); chocolate soufflé; soufflé candies; soufflé-jelly candies; tartlets; petits fours (cakes); chocolate cakes; cakes; halvah; candy decorations for cakes; chocolate decorations for cakes; bakery products; sweetmeats (candy); candies with fillings; sugar confectionery; waffle candies; toffee candies; chocolate; chocolate desserts; chocolate cream; chocolate dragee with raisins or nuts; chocolate paste; chocolate candies; chocolate bars; chocolate beverages with milk; chocolate figurines.

(260) AM 2015 76890 A
 (800) 1198913
 (891) 2014 02 20
 (731) Obshchestvo s ogranichennoi
 otvetstvennostyu "ALEKSANDROVY
 POGREBA"
 Altufyevskoye shosse, d. 79 "A", str. 25,
 RU-127410 Moscow, RU
 (540)

Восходящее солнце Кавказа

(511)

32 – Beer; mineral and aerated waters and other non-alcoholic beverages; fruit beverages and fruit juices; syrups and other preparations for making beverages.

33 – Alcoholic beverages (except beers).

(260) AM 2015 76891 A

(800) 1198920

(891) 2014 02 24

(731) Obshchestvo s ogranichennoj otvetstvennostyu "DEVIDEND"
mkr-n Ptitsefabrika, pgt Tomilino, Lyuberskij rajon, RU-140074 Moskovskaya obl., RU

(540)

MAGIC-FLOAT

(591) Black, white

(511)

12 – Barges; dredgers [boats]; ferry boats; pontoons; vehicles for locomotion by land, air, water or rail; water vehicles; inclined ways for boats; cleats [nautical]; davits for boats.

19 – Swimming pools [structures, not of metal]; joists, not of metal; beacons, not of metal, non-luminous; diving boards, not of metal; prefabricated houses [kits], not of metal; cabanas, not of metal; framework, not of metal, for building; mooring bollards, not of metal; buildings, not of metal; buildings, transportable, not of metal; staircases, not of metal; road coating materials; building materials, not of metal; masts [poles], not of metal; duckboards, not of metal; palings, not of metal; crash barriers, not of metal, for roads; props, not of metal; fair huts; building panels, not of metal; partitions, not of metal; platforms, prefabricated, not of metal; paving slabs, not of metal; paving blocks, not of metal; floors, not of metal; floating docks, not of metal, for mooring boats; pilings, not of metal; posts, not of metal; stair-treads [steps], not of metal.

35 – Import-export agencies; demonstration of goods; organization of exhibitions for commercial or advertising purposes; organization of trade fairs for commercial or advertising purposes; presentation of goods on communication media, for retail purposes; auctioneering; sales promotion for others; production of advertising films; distribution of samples; advertising; business management of hotels; procurement services for others [purchasing goods and services for other businesses]; outsourcing services [business assistance].

(260) AM 2015 76892 A

(800) 1198967

(891) 2013 12 31

(731) YURTBAY SERAMİK SANAYİ VE TİCARET ANONİM ŞİRKETİ
Oklubali Köyü PK. 22, İNÖNÜ ESKİŞEHİR, TR

(540)



(591) Orange, blue, green, black

(511)

19 – Floor tiles not of metal, wall tiles not of metal, granite.

(260) AM 2015 76893 A

(800) 1198976

(891) 2014 02 19

(731) MERIDAN MANAGEMENT LTD
Graigmuir Chambers, Road Town, P.O. Box 71, TORTOLA, VG

(540)



(591) Blue and green

(511)

35 – Sales promotion for others, wholesale and retail store services.

(260) AM 2015 76894 A

(800) 1198981

(891) 2014 02 05

(731) Obchtchestvo s ogranitchennoj otvetstvennostyuu "MIRROLLA"
ul. Ivana Fomina, 6, RU-194295 SANKT-PETERSBURG, RU

(540)

ДОКТОР ХРАП' ЭКС

(511)

3 – Toiletries; cosmetics.

(260) AM 2015 76895 A

(800) 1198987

(891) 2013 10 28

(731) Obchtchestvo s ogranitchennoj otvetstvennostyuu "STRATEGUIYA"
8-26, oul. Aguibalova RU-443041 Samara, RU

(540)



(591) Dark beige, light beige, blue, white, red-brown, green, black, dark red and red

(511)

32 – Beers.

(260) AM 2015 76898 A
 (800) 1199020
 (891) 2014 01 10
 (731) CEVAT ÖMEROĞLU
 Laleli, Mimar Kemalettin Mah. Mithatpaşa,
 Cad. No:21/A Eminönü, İstanbul, TR
 (540)



BOGGAD

(591) Black, white
 (511)
 25 – Clothing, footwear, headgear.

(260) AM 2015 76900 A
 (800) 1199058
 (891) 2014 03 03
 (731) Obschestvo s ogranichennoy otvetstvennostyu
 "SEVERINA"
 Ladozhskaya str. 10, RU-105005 Moscow, RU
 (540)



DE'LAKRUA

(591) Black, white
 (511)
 3 – Nail polish; nail polish removers; nail care pre-
 parations.
 8 – Nail clippers, electric or non-electric; manicure
 sets; fingernail polishers, electric or non-electric;
 depilation appliances, electric and non-electric; elec-
 tric manicure sets; pedicure sets; nail files; electric
 nail files; tweezers; cuticle nippers; nail nippers;
 eyelash curlers; scissors.
 21 – Nail brushes; eyebrow brushes.

(260) AM 2015 76902 A
 (800) 1199084
 (891) 2013 10 08
 (731) SOLEN CIKOLATA GIDA SANAYI VE
 TICARET ANONIM SIRKETI
 2. Organize Sanayi Bolgesi, Nolu Cad. No:28,
 TR-83221 SEHITKAMIL GAZIANTEP, TR
 (540)



(591) Red, green, light red, blue and white
 (511)
 30 – Coffee, cocoa, coffee or cocoa-based bevera-
 ges, chocolate-based beverages, macaroni, meat

pies, vermicelli, products of patisserie and bakery,
 desserts, honey, propolis, flavourings for foods,
 yeast, baking powder, any kind of flour, semolina,
 starch, sugar, lump sugar, powdered sugar, teas, iced
 tea, confectionery, chocolates, biscuits, crackers,
 wafers, chewing gums, ice creams, edible ices.

(260) AM 2015 76904 A
 (800) 1199090
 (891) 2013 10 23
 (731) WORLD MEDICINE İLAÇ SANAYİ VE
 TİCARET LİMİTED ŞİRKETİ
 Evren Mah. Camiyolu Cad. No:50 K:1 B,
 Zemin 4-5-6, Güneşli Bağcılar İstanbul, TR
 (540)



BUDECTON

(591) Black, white
 (511)
 5 – Medicines for human purposes, medicines for
 veterinary purposes, vitamin preparations, chemical
 preparations for medical purposes, dietetic substan-
 ces adapted for medical use; dietetic foods adapted
 for medical purposes; baby foods, medicinal herbs,
 herbal beverages adapted for medical purposes, nut-
 ritional supplements, pollen dietary supplements,
 mineral food supplements, protein dietary supple-
 ments; medicines for dental purposes, hygienic pro-
 ducts for medical purposes including sanitary pads,
 breast-nursing pads and bunion pads, waddings for
 medical purposes, plasters for medical purposes,
 dressings for medical purposes, babies' napkins,
 preparations for destroying noxious plants, prepara-
 tions for destroying noxious animals, fungicides,
 deodorants other than for human beings or for ani-
 mals, air deodorising preparations, disinfectants for
 hygiene purposes, antiseptics, detergents for medical
 purposes.

(260) AM 2015 76906 A
 (800) 1199117
 (891) 2013 12 10
 (731) VIENNA INSURANCE GROUP AG Wiener
 Versicherung Gruppe
 Schottenring 30, A-1010 Vienna, AT
 (540)



(591) Blue and red
 (511)
 36 – Insurance, financial affairs (excluding debit and
 credit card services, but including arrangement of
 credit card services).

(260) AM 2015 76908 A
 (800) 1199132
 (891) 2014 01 08
 (731) ALEXANDRA ALBERTA CHIOLO S.P.A.
 Via Emilio Morosini, 22, I-20135 MILANO
 (MI), IT
 (540)



(591) Black, white
 (511)
 18 – Leather and imitations of leather, and goods made of these materials and not included in other classes; animal skins, hides; trunks and travelling bags; umbrellas and parasols; walking sticks; whips, harness and saddlery.
 25 – Clothing, footwear, headgear.

(260) AM 2015 76910 A
 (800) 1199147
 (891) 2014 01 15
 (731) Open Joint-Stock Company "REVYAKINO
 METAL ROLLING MILL"
 ul. Sovetskaya, d. 4, Yasnogorskij r-n, p.,
 Tul'skaya obl., RU-301056 Revyakino, RU
 (540)



(591) Black, white
 (511)
 6 – Steel, semi-wrought.
 7 – Rolling mills, their component parts.
 8 – Shovels [hand tools].
 19 – Concrete; parts of building structures included in class 19; planks [wood for building].

(260) AM 2015 76911 A
 (800) 1199154
 (891) 2014 01 16
 (731) KONE Corporation
 Kartanontie 1, FI-00330 Helsinki, FI
 (540)

KONE

(511)
 6 – Metal building materials or building materials predominantly of metal; building panels of metal;

small items of metal hardware; goods of common metal not included in other classes; doors of metal or predominantly of metal, including sliding doors and gates, revolving doors and gates, turnstiles, roller doors, folding doors and swing-up doors and their parts; building fittings and door, window and gate furniture of metal, including fittings for windows, doors and gates of metal, door hinges, door handles, door bolts, door knobs and door frames; metal cables (non-electric).

7 – Lifting and transporting equipment, such as elevators, elevating apparatus, escalators, moving walkways and other vertical, horizontal and inclined conveyor systems, as well as components, parts for all the aforesaid goods, hydraulic and pneumatic door openers and closers (parts of machines) and their control units, as well as components, parts and fittings for the aforesaid goods; machines, namely automatic door operators and their control units, as well as components and parts for aforesaid goods; mechanic opening and closing equipment for doors, revolving doors and gates as well as components and parts therefor; electric and electronic apparatus and installations for automatic doors and gates, namely automatic door drive gear; automatic door opening and closing apparatus for automatic doors and gates; automatic barriers and gate drive gear, as well as components and parts for all the aforesaid goods, motors to be used in lifting and transporting equipment, such as elevators, elevating apparatus, escalators, moving walkways and other vertical, horizontal and inclined conveyor systems, as well as components, parts for all the aforesaid goods, power units and motors to be used in automated doors and gates, non-metallic cables, belts and ropes for elevators, elevating apparatus, escalators, moving walkways and other vertical, horizontal and inclined conveyor systems.

9 – Measuring and control systems and their components, parts in connection with lifting and transporting equipment, such as elevators, escalators, moving walkways and other vertical, horizontal and inclined conveyor systems; apparatus and installations for access control, power units and motors to be used in lifting and transporting equipment, such as elevators, elevating apparatus, escalators, moving walkways and other vertical, horizontal and inclined conveyor systems; access control systems; electronic time keeping systems, as well as components, parts for all the aforesaid goods; computer chips and other electronic identification devices and cards; electronic indoor and outdoor guidance and navigation apparatuses and systems, as well as their components, parts; electronic equipment for advertising, such as screens, monitors, advertising signs and luminous signs; computer software; computer software for monitoring and controlling elevators, escalators, moving walkways, automated doors, turnstiles and ga-

tes; computer software for monitoring and controlling security and access control systems; computer software for indoor and outdoor guidance and navigation systems; computer software for designing conveying equipment, routes and systems; electronic alarms and emergency phones; warning devices, fire alarms, burglar alarms, emergency call devices, misuse alarms and malfunction alarms; computer software and applications for interfacing mobile phones, smart phones and mobile computers with elevators, escalators, automatic doors, turnstiles, gates, indoor and outdoor guidance and navigation systems, access control systems and time keeping systems; installations for monitoring human activity.

37 – Installation, maintenance, repair and modernization of all kinds of lifting and transporting equipment, such as elevators, elevating apparatus, escalators, moving walkways and other vertical, horizontal and inclined conveyer systems, as well as associated components for such equipment; installation, maintenance, repair and modernization of doors, turnstiles and gates and their associated components and spare parts; installation, maintenance, repair and renovation of access control, time keeping and security systems, apparatus and installations and their parts installation, maintenance, repair and renovation of electronic indoor and outdoor guidance and navigation systems, apparatus and installations and their parts; installation, maintenance, repair and modernization of electronic equipment and systems for advertising, such as advertising signs and luminous signs.

(260) AM 2015 76913 A
(800) 1199158
(891) 2014 02 11
(731) Otkrytoe aktsionernoe obshchestvo
"NIZHEGORODSKY MASLO-ZHIROVOY
KOMBINAT"
11, sh. Zhirkombinata RU-603950 g. Nizhny
Novgorod, RU
(540)

Степановна

(511)
29 – Meat, fish, poultry; meat extracts; preserved, dried and cooked fruits and vegetables; jellies, jams, compotes; eggs, milk and milk products; edible oils and fats; peanuts, processed; beans, preserved; soya beans, preserved, for food; bouillon; ginger jam; fatty substances for the manufacture of edible fats; peas, preserved; mushrooms, preserved; gelatine for food; jellies for food; fruit jellies; coconut fat; bone oil, edible; lard for food; suet for food; raisins; sauerkraut; meat, tinned [canned (Am.)]; vegetables, tinned [canned (Am.)]; fish, tinned [canned (Am.)]; fruits, tinned [canned (Am.)]; fruit and berry compotes; bouillon concentrates; gherkins; buttercream; onions, preserved; margarine; piccalilli; marmalade;

vegetable oils; peanut butter; cocoa butter; coconut butter; butter; almonds, ground; soya milk [milk substitute]; fruit pulp; meat, preserved; olives, preserved; coconut, desiccated; nuts, roasted and dried; nuts, prepared; tomato purée; liver pâté; fruit preserves; powdered eggs; prostokvasha [soured milk]; cranberry sauce [compote]; apple purée; fish, preserved; vegetable salads; fruit salads; sunflower seeds and pumpkin seeds processed, cooked, roasted, dried, salted; whipped cream; fat-containing mixtures for bread slices; tomato juice for cooking; vegetable juices for cooking; preparations for making bouillon; preparations for making soup; tripe; soups; vegetable soup preparations; cheese; tofu; rennet; dates; crystallized fruits; frozen fruits; fruit preserved in alcohol; candied fruits; potato flakes; lentils, preserved; potato chips; fruit chips.

(260) AM 2015 76914 A
(800) 1199162
(891) 2013 11 21
(731) Actavis Group PTC ehf
Reykjavikurvegi 76-78, IS-220 Hafnarfjordur,
IS
(540)

PINODRYN

(511)
5 – Pharmaceutical preparations and substances.

(260) AM 2015 76915 A
(800) 1199167
(891) 2014 01 22
(731) EGIS Gyógyszergyár Zrt.
Keresztúri út 30-38, H-1106 Budapest, HU
(540)

OGILLID

(511)
5 – Pharmaceutical preparations for human use.

(260) AM 2015 76916 A
(800) 1199168
(891) 2014 01 22
(731) EGIS Gyógyszergyár Zrt.
Keresztúri út 30-38, H-1106 Budapest, HU
(540)

GLOBIDOR

(511)
5 – Pharmaceutical preparations for human use.

(260) AM 2015 76918 A
(800) 1199170
(891) 2014 01 22
(731) EGIS Gyógyszergyár Zrt.
Keresztúri út 30-38, H-1106 Budapest, HU

(540)

SMODERIS

(591) Black, white

(511)

5 – Pharmaceutical preparations for human use.

(260) AM 2015 76919 A

(800) 1199171

(891) 2014 01 22

(731) EGIS Gyógyszergyár Zrt.

Keresztúri út 30-38, H-1106 Budapest, HU

(540)

STROMBEL

(511)

5 – Pharmaceutical preparations for human use.

(260) AM 2015 76920 A

(800) 1199172

(891) 2014 01 22

(731) EGIS Gyógyszergyár Zrt.

Keresztúri út 30-38, H-1106 Budapest, HU

(540)

LEDANID

(511)

5 – Pharmaceutical preparations for human use.

(260) AM 2015 76921 A

(800) 1199173

(891) 2014 01 22

(731) EGIS Gyógyszergyár Zrt.

Keresztúri út 30-38, H-1106 Budapest, HU

(540)

KORZENNA

(511)

5 – Pharmaceutical preparations for human use.

(260) AM 2015 76922 A

(800) 1199207

(891) 2014 03 13

(731) CENDRES+MÉTAUX HOLDING SA

Rue de Boujean 122, CH-2501 Biel/Bienne,
CH

(540)

EDELWHITE

(511)

14 – Precious metals and their alloys and goods made of these materials or coated therewith not included in other classes; jewelry, precious stones; timepieces and chronometric instruments.

(260) AM 2015 76923 A

(800) 1199245

(891) 2013 12 16

(731) HAZAL TEKSTIL GIYIM SANAYI ve

TICARET LIMITED SIRKETI

Çakmak Mah. Atay Sok. No:1, TR-34770

Ümraniye, Istanbul, TR

(540)



(591) Red and black

(511)

25 – Clothing (underwear and outerwear) made from all kinds of materials, except the ones which are used for protective purposes; socks, stockings; footwear; headgear for wear.

(260) AM 2015 76924 A

(800) 1199247

(891) 2014 02 11

(731) Nemiroff Intellectual Property Establishment

Städtle 31, FL-9490 Vaduz, LI

(540)

NEWMIROFF

(591) Black, white

(511)

33 – Alcoholic beverages (except beers).

35 – Advertising; business management; business administration; office functions; importation and exportation of alcoholic beverages; retail and wholesale services with alcoholic beverages.

(260) AM 2015 76925 A

(800) 1199262

(891) 2014 01 13

(731) ANALPA, INC.

13854 Stone Mill Way, Tampa FL 33613, US

(540)



(591) Dark brown and white

(511)

25 – Headgear; clothing; footwear.

(260) AM 2015 76926 A

(800) 1199280

(891) 2013 08 12

(731) CONTINENTAL TEVES AG & CO. OHG

Guerickestraße 7, 60488 Frankfurt, DE

(540)



(591) Black, white

(511)

1 – Brake fluid, chemical products for industrial and scientific purposes; unprocessed artificial resins; tempering and soldering preparations; adhesives for industrial purposes.

4 – Greases for motor vehicles, in particular brake paste.

6 – Metal distributors, couplings and adapters for use with hydraulic systems, particularly central hydraulic manifolds and hydraulic system components for vehicle brakes, cables and wires of common metal, ironmongery, small items of metal hardware; pipes and flexible pipes of metal; hose and pipe fittings of metal; hose and pipe couplings of metal, reinforcements included in this class; pipes of metal for ventilating and air conditioning systems.

7 – Fuel pumps for land vehicles, fuel injectors, gaskets and sealing rings made of metal and non-metal for vehicles; machines to manufacture, repair and dismantle land, air and water vehicles; machine tools; motors (except for land vehicles), engine parts of all kinds of engines, including electric motors and their parts (except for land vehicles), air filters for engines, engine mounts, control units for engines, electric starters for motors, motor-driven generators, master cylinders, electric motors (except for land vehicles) and pumps (machines), controlled adjustment of vehicle parts such as car seats, windows, mirrors, sunroofs, throttles, cam shafts; machine coupling and transmission components including clutches (except for land vehicles); engine bearings, hydraulic bearings, torsional vibration dampers, actuators; mechanical jacks; motors and pumps.

8 – Repair hand tools for motor vehicles; hand tools for working on vehicle brake calipers and brake pads, especially tools for extracting calipers, piston return devices, piston rotary tools, brake caliper guide series, socket wrench, brake caliper wrench, socket extension devices, wrench, pliers, piston clips, spring assembly tools, drum brakes mounting kit, primarily composed of adjustment keys, spring assembly tools and adjustment levers, hand tools for repairing, installing, testing and checking of vehicle braking systems.

9 – Pressure switches, brake fluid tester, controls for installation in motor vehicles, in particular regulators for electric windows, fuel pressure regulator, brake controls, electric and electronic measuring, touch, control, regulation and transmission equipment for installation in vehicles for measuring, touch, control, regulation and transmission of information in terms of speed, distance of objects, pressure, temperature, acceleration, and/or position or rate of change of vehicles, areas, or vehicle controls, including their processors and sensors for the steering and control of vehicles, to improve driving safety, stability and suspension and noise comfort; sensors for use in the

control of the drive and the operation of safety and security devices of motor vehicles; gauges to measure air, electricity, water and fuel consumption of the vehicle; tachometer; hardware and software systems for installation in land vehicles to compile operational information and statistics on vehicle and driver; hardware and software systems for installation in land vehicles to support the driver in ensuring an efficient engine operation; hardware and software systems for installation in land vehicles to ensure efficient fuel consumption; hardware and software systems for mounting in land vehicles for display of operating modes and identification of preferences to operational requirements; diagnostic equipment for testing of sensors for use in controlling the actuation and operation of vehicle safety and security devices; systems for heating, ventilation and air conditioning of passenger accommodation; accumulators and their parts; warning lights for vehicles, instruments and meters, tachometer; electrical control unit including their processors and sensors for regulation and control of brakes, transmissions, suspensions and exhaust gases; voltage regulator for vehicles; electrical and electronic measuring, testing and control devices for installation in motor vehicles, particularly to monitor and control the speed, the tire pressure and the vehicle distance, automatic parking aids; tire pressure gauge and rotational speed sensor; apparatus and instruments for conducting, switching, transforming, accumulating, regulating or controlling electricity; electrical fuses, electrical relays, transponders, sensors, actuators (included in this class); electrical access and closure devices for motor vehicles, including control devices, controls and electric motors; laser, not for medical purposes; computer programs stored and software.

12 – Vehicles for locomotion by land, air and/or water and parts and accessories included in this class; brakes for vehicles and their parts, including parking brakes, active parking brakes and immobilizer, brake force distribution, wheel brakes; brake cylinder, brake force generator, brake calipers, brake drums, brake cylinder, brake pads, brake booster, adjustable brake pedals, repair kits for car brakes, brake pressure regulator, pressure switch, brake shoes, brake pads and accessories parts, brake wear indicator, central hydraulic manifold, hydraulic system components, brake hoses, hand brake cables, brake discs, brake drums, all the aforementioned goods as parts of brake systems, mechanical and hydraulic control and regulation circuits included in this class; carrier of calipers and/or stub axles and parts thereof, regulated and unregulated electro-mechanical and electro-hydraulic steering systems and parts thereof, regulated and unregulated chassis, safety devices for motor vehicles included in this class, including airbags, seat belt parts and fittings included in this class; couplings and transmission components including clutches for land vehicles, clutch parts for land

vehicles, in particular clutch cables, clutch master and slave cylinder, electric motors for use in land vehicles, blower motors for use in engine cooling system, drives for electric windows, anti-lock braking systems for vehicles.

16 – Books, journals, repair and/or service manuals for land vehicles, paper, cardboard and goods made from these materials, included in this class; printed matter, instructional and teaching materials, including textbooks.

35 – Advertising, business management, business administration; office functions, including recruitment, personnel management consultancy, business management consultancy, public relations, radio and television advertising, consulting in the field of marketing of vehicle parts according to customer requirements; organizational and economical (and in marketing) advising car manufacturers, dealers, repair workshops and consumers of vehicle parts; implementation of trade fairs for commercial, economic and advertising purposes, exhibitions for commercial, economic and advertising purposes, promotional events.

37 – Services of a repair workshop, namely modification, repair, maintenance, assembly, disassembly, care, cleaning and paint work of vehicles and engines.

41 – Education and training, entertainment; sportive and cultural activities including arranging and conducting of colloquiums, conferences, congresses, symposia, seminars and workshops, training, all the aforementioned services only for the automobile industry.

42 – Development, project studies and technical guidance for the testing of automotive components on request of the customer and/or licensing of services regarding customised arrangements, testing and repair of automotive components; research, development, design and planning in the field of sensor, control and regulation systems, including of related processors to improve driving safety, stability, directional stability, ride comfort and noise protection, suspension and noise comfort; technological advice in relation to the automotive industry and surveying; technical consultancy and providing of expertise in the aforementioned area.

(260) AM 2015 76927 A

(800) 1199327

(891) 2013 11 29

(731) Tadeusz Ogrodnik TROPICAL
ul. Wolności 69, PL-41-500 Chorzów, PL

(540)

 Tropical
SUPERVIT

(591) Black, white

(511)

31 – Foodstuffs for fish and ornamental animals living in sweet, salty or mixed water biotypes; products and preparations for breeding of fish and ornamental animals in the form of flakes, granules, extrudates, tablets, powders, gels, pastes, liquids, grains and mixtures thereof dried, frozen and lyophilised natural food for fish and ornamental animals living in sweet, salty or mixed water biotypes, food for fish and ornamental animals living in sweet, salty or mixed water biotypes containing nutritional preparations (not for medical purposes).

(260) AM 2015 76928 A

(800) 1199328

(891) 2013 12 16

(731) OTKRYTOE AKTSIONERNOE
OBSHESTVO "AVTOVAZ"
36, Yuzhnoe Shosse, RU-445024 Tolyatti,
Samarskaya oblast, RU

(540)

PRIORA

(591) Black, white

(511)

7 – Machines and machine tools; motors and engines (except for land vehicles); machine coupling and transmission components [except for land vehicles]; bearings [parts of machines]; fans for motors; alternators; dynamos; silencers for motors; cylinder heads for engines; aeronautical engines; glow plugs for diesel engines; jacks [machines]; pressure valves [parts of machines]; injectors for engines; carburetors; universal joints [cardan joints]; crankcases for motors and engines; valves [parts of machines]; cowlings [parts of machines]; machine wheels; piston segments; grease rings [parts of machines]; crank shafts; conveyors [machines]; air pumps [garage installations]; aerocondensers; belt conveyors; igniting magnetos; machine fly-wheels; metalworking machines; rinsing machines; clutches other than for land vehicles; superchargers; pumps [machines]; lubricating pumps; hangers [parts of machines]; bearings included in this class; lifts included in this class; hoists; pistons for engines; presses [machines for industrial purposes]; springs [parts of machines]; fuel conversion apparatus for internal combustion engines; radiators [cooling] for motors and engines; robots [machines]; stuffing boxes [parts of machines]; welding machines, electric; saturators; sparking plugs for internal combustion engines; drilling machines; starters for motors and engines; transmi-

ssion shafts, other than for land vehicles; turbocompressors; machines for the compression included in this class; igniting devices for internal combustion engines; aprons [parts of machines]; filters for cleaning cooling air, for engines; cylinders for engines; universal joints [parts of machines]; connecting rods for machines, motors and engines; pulleys [parts of machines]; ejectors; electric arc cutting apparatus; electric arc welding apparatus; electrodes for welding machines.

9 – Optical, weighing, measuring, signalling, life-saving and teaching apparatus and instruments; apparatus and instruments for conducting, switching, transforming, accumulating, regulating or controlling electricity; apparatus for recording, transmission or reproduction of sound or images; magnetic data carriers, recording discs; cash registers; calculating machines; accumulators, electric, for vehicles; acoustic couplers; speaking tubes (acoustic); loudspeakers; protection devices for personal use against accidents; automatic indicators of low pressure in vehicle tires; fire engines; ammeters; anemometers; aerials; cathodic anti-corrosion apparatus; batteries for lighting; jigs [measuring instruments]; gas testing instruments; locks, electric; bells [warning devices]; pressure indicators; temperature indicators; cables, electric; anti-dazzle shades; diaphragms included in this class; diaphragms [acoustics]; vehicle breakdown warning triangles; switches, electric; plates for batteries; time recording apparatus; audio and video receivers; record players; vehicle radios, namely subwoofers; speaker systems consisting of loudspeakers and cabinets for use with loudspeakers; car audio; cassette players; CD players; power amplifiers; miniature amplifiers; voltage regulators for vehicles; speed indicators; anti-glare glasses; glass covered with an electrical conductor; kilometer recorders for vehicles; reflecting discs for wear, for the prevention of traffic accidents; tachometers; thermostats for vehicles; simulators for the steering and control of vehicles; starter cables for motors; gasoline gauges; amplifiers; steering apparatus, automatic, for vehicles; balancing apparatus; theft prevention installations, electric; chargers for electric batteries; sound alarms; life saving apparatus and equipment; anti-theft warning apparatus; signal lanterns; ducts [electricity].

12 – Vehicles; apparatus for locomotion by land, air or water; automobiles; sports cars; shock absorbers for automobiles; suspension shock absorbers for vehicles; ski carriers for cars; bumpers for automobiles; brake shoes for vehicles; valves for vehicle tires; automobile hoods; transmission shafts for land vehicles; doors for vehicles; engines for land vehicles; jet engines for land vehicles; driving motors for land vehicles; rearview mirrors; hoods for vehicle engines; vehicle wheels; steering wheels for vehicles; brake pads for automobiles; hub caps; bands for

wheel hubs; caps for vehicle petrol [gas] tanks; automobile bodies; clutches for land vehicles; repair outfits for inner tubes; upholstery for vehicles; rims for vehicle wheels; windows for vehicles; axles for vehicles; gearing for land vehicles; treads for retreading tires; head-rests for vehicle seats; vehicle running boards; air bags [safety devices for automobiles]; anti-dazzle devices for vehicles; anti-theft devices for vehicles; sun-blinds adapted for automobiles; non-skid devices for vehicle tires; balance weights for vehicle wheels; shock absorbing springs for vehicles; safety belts for vehicle seats; vehicle suspension springs; rudders; luggage nets for vehicles; anti-theft alarms for vehicles; reversing alarms for vehicles; vehicle seats; hydraulic circuits for vehicles; military vehicles for transport; cycle cars; electric vehicles; ambulances; windscreens; windscreen wipers; hubs for vehicle wheels; couplings for land vehicles; brakes for vehicles; transmissions, for land vehicles; direction signals for vehicles; vans [vehicles]; automobile chains; driving chains for land vehicles; anti-skid chains; seat covers for vehicles; luggage trucks; golf carts; vehicles for locomotion by land, air, water or rail; torsion bars for vehicles; automobile chassis; connecting rods for land vehicles, other than parts of motors and engines; axle journals; automobile tires; spikes for tires; mudguards; motors, electric, for land vehicles; cigar lighters for automobiles.

16 – Fountain pens; albums; almanacs; posters; forms, printed; note books; pads [stationery]; pamphlets; booklets; paper; writing paper; packing paper; newsletters; signboards of paper or cardboard; magazines [periodicals]; money clips; bookmarkers; printed publications; plastic or paper materials for packaging (not included in other classes); cardboard articles; graphic representations; calendars; pencils; pencil lead holders; pictures; catalogues; envelopes [stationery]; boxes of cardboard or paper; covers [stationery]; passport holders; greeting cards; post-cards; folders for papers; paper bags; seals [stamps]; mats for beer glasses; stands for pens and pencils; writing materials; printed matter; prospectuses; writing or drawing books; flags of paper; photographs [printed]; labels, not of textile.

25 – Clothing, footwear, headgear.

28 – Toy vehicles; chessboards; checkerboards; games; mobiles [toys]; radio-controlled toy vehicles; chess games; checkers [games].

35 – Rental of advertising space; demonstration of goods; marketing studies; layout services for advertising purposes; organization of exhibitions for commercial or advertising purposes; organization of trade fairs for commercial or advertising purposes; shop window dressing; presentation of goods on communication media, for retail purposes; sales promotion for others; rental of advertising time on

communication media; publicity material rental; publication of publicity texts; radio advertising; distribution of samples; dissemination of advertising matter; advertising; advertising by mail order; television advertising.

(260) AM 2015 76929 A

(800) 1199356

(891) 2014 01 24

(731) VOSSLÖH AG

Vosslohstrasse 4, 58791 Werdohl, DE

(540)

vossloh

(591) Black, white

(511)

40 – Treatment of materials; treatment and machining of metal plates; welding work for third parties; treatment of rails for railway vehicles.

(260) AM 2015 76931 A

(800) 1199391

(891) 2014 02 25

(731) Obshchestvo s ogranichennoy

otvetstvennostyu «PARAFARM»

ul. Sverdlova, d. 4, RU-440026 g. Penza, RU

(540)



(591) Dark green, light green, white, red, black, cream, bright yellow, lilac, grey, dark grey

(511)

5 – Pharmaceutical preparations; medicines; dietary supplements; balms for medical purposes; mineral water for medical purposes; thermal water; dietary fiber; hormones for medical purposes; mustard for pharmaceutical purposes; mineral food-supplements; nutritional supplements; capsules for medicines; capsules for pharmaceutical purposes; candy for medical purposes; candy, medicated; medicinal roots; medicines for alleviating constipation; medicinal oils; drugs for medical purposes; medicines for human purposes; royal jelly for medical purposes; milk ferments for pharmaceutical purposes; lacteal flour for babies; flour for pharmaceutical purposes; flaxseed meal for pharmaceutical purposes; mint for pharmaceutical purposes; medicinal infusions; tinctures for medical purposes; opium; opodeldoc;

decoctions for pharmaceutical purposes; pills for pharmaceutical purposes; leeches for medical purposes; vitamin preparations; opotherapy preparations; bath preparations, medicated; medicinal hair growth preparations; chemico-pharmaceutical preparations; albuminous foodstuffs for medical purposes; food for babies; dietetic foods adapted for medical purposes; by-products of the processing of cereals for medical purposes; flaxseed for pharmaceutical purposes; syrups for pharmaceutical purposes; soporifics; stypic preparations; anthelmintics; appetite suppressants for medical purposes; medical preparations for slimming purposes; parasiticides; mouthwashes for medical purposes; febrifuges; depuratives; laxatives; tonics [medicines]; nervines; digestives for pharmaceutical purposes; medicinal herbs; fennel for medical purposes; diabetic bread adapted for medical use; chloroform; herbal teas for medicinal purposes; slimming tea for medical purposes; extracts of hops for pharmaceutical purposes; elixirs [pharmaceutical preparations]; ethers for pharmaceutical purposes; esters for pharmaceutical purposes.

(260) AM 2015 76933 A

(800) 321926

(891) 2014 02 12

(731) BAYER INTELLECTUAL PROPERTY

GMBH

Alfred-Nobel-Straße 10, 40789 Monheim am Rhein, DE

(540)

PROGYNOVA

(511)

5 – Medicines, namely hormone preparations containing steroids.

(260) AM 2015 76934 A

(800) 561785

(891) 2014 04 01

(731) PRECA BRUMMEL SPA

Via Galliano, 21, CARNAGO, IT

(540)

BIMBUS

(591) Black, white

(511)

25 – Clothing, footwear, headgear.

(260) AM 2015 76935 A

(800) 589087

(891) 2014 02 10

(731) COLORIFICIO SAN MARCO S.P.A.

Via Alta, 10, I-30020 MARCON (VE), IT

(540)

**san
marco**

(591) Black, white

(511)

2 – Coloring substances, paints, enamels and varnishes.

17 – Insulating paints and insulating varnishes.

(260) AM 2015 76936 A

(800) 619672

(891) 2014 01 22

(731) COLTÈNE/WHALEDENT GMBH + CO. KG
Raiffeisenstrasse 30, 89129 Langenau, DE

(540)

roeko

(591) Black, white

(511)

5 – Pharmaceutical preparations, products for sanitary purposes, disinfectants, all these products for dentistry; plasters, materials for dressings, cotton rolls, cotton balls, cotton patches, gauze bandages for treating wounds, pads and bands for dental use, also impregnated with medicines or disinfectants, small absorbent compression caps for dental use; teeth filling material, material for impressions and bands for impressions for dental use; synthetic materials for making temporary crowns and bridges in the field of dentistry; absorbent paper tips for medical use; polishing and planing material for dental use.

10 – Surgical stitching material and retraction threads for dental use, also impregnated with medicines or disinfectants, dental apparatus and instruments, including aspirator tips, dental drills, files, filters for dental aspirating apparatus; protective masks for the face and mouth made of cellulose or non-woven fabric for medical use; gutta-percha tips for medical use; gloves for examinations made of rubber or synthetic materials for medical use.

16 – Paper bibs for patients.

21 – Dispensers made of synthetic materials for dental materials, particularly for cotton articles, pads and garbage bags.

25 – Bibs for patients made of non-woven fabrics.

(260) AM 2015 76943 A

(800) 954663

(891) 2014 02 14

(731) RUBUN GLOBAL CORP.
33 Porter Road, P.O. Box 3169 PMB103 Road
Town, Tortola, VG

(540)

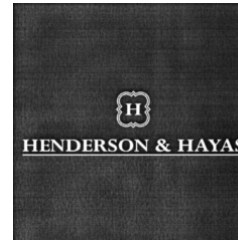

(591) Black, white

(511)

14 – Precious metals and their alloys and goods in precious metals or coated therewith, not included in other classes; jewellery, precious stones, watches and other chronometric instruments, including agates, diamonds, amulets (jewellery), anchors (clock and watch-making), barrels (clock and watchmaking), bracelets (jewellery), straps for wristwatches, charms (jewellery), key rings (trinkets or fobs), brooches (jewellery), alarm clocks, pins (jewellery), ornamental pins, tie pins, pearls made of ambroid (pressed amber), busts of precious metal; jet, unwrought or semi-wrought; pearls (jewellery), copper tokens, tie clips, cuff links, badges of precious metal; gold, unwrought or beaten; cloisonné jewellery, works of art of precious metal, jewellery of yellow amber, iridium, semi-precious stones, spun silver (silver wire), necklaces (jewellery), rings (jewellery), boxes of precious metal, watch cases, pendulums (clock and watchmaking), medals, medallions (jewellery); precious metals, unwrought or semi-wrought; clockworks, coins, threads of precious metal (jewellery), gold thread (jewellery), silver thread, osmium, palladium, platinum (metal), chronometrical instruments, watch springs, rhodium, ruthenium, stopwatches; silver, unwrought or beaten; earrings, ingots of precious metals, alloys of precious metal, statues of precious metal, statuettes of precious metal, watch glasses, paste jewellery, clock hands (clock and watchmaking), ornaments (jewellery), shoe ornaments (of precious metal), hat ornaments (of precious metal), ornaments of jet, silver ornaments, ivory (jewellery), cases for clock and watchmaking, cases for watches (presentation), jewel cases of precious metal, chronographs (watches), chronometers, chronoscopes, chains (jewellery), watch chains, dials (clock and watchmaking), clocks, watches, atomic clocks, sundials; clocks and watches, electric; control clocks (master clocks), wristwatches, spinel (precious stones).

18 – Leather and imitations of leather, and goods made of these materials and not included in other classes; animal skins, trunks and travelling bags; umbrellas, parasols and walking sticks; whips, harness and saddlery; alpenstocks, pocket wallets, card cases, reins, parts of rubber for stirrups; chamois leather, other than for cleaning purposes; briefcases, frames for umbrellas or parasols, handbag frames, valves of leather, imitation leather; leather, unwor-

ked or semi-worked; leatherboard; casings, of leather, for springs; umbrella rings, hat boxes of leather, boxes of leather or leather board, boxes of vulcanised fibre, purses, chain mesh purses, not of precious metal, fastenings for saddles, butts (parts of hides), saddle trees; bags (envelopes, pouches) of leather, for packaging; moleskin (imitation of leather), kneepads for horses, muzzles, halters, vanity cases (not fitted), leather thread, furniture coverings of leather, gut for making sausages, clothing for pets, harness fittings of iron, leather trimmings for furniture, collars for animals, dog collars, music cases, gold beaters' skin, cat o' nine tails, pads for horse saddles, bands of leather, coverings of skins (furs), horse blankets, purses, not of precious metal, bandoliers, harness fittings, not of precious metal, fur, haversacks, leather straps, straps for soldiers' equipment, harness straps, straps for skates, straps of leather (saddlery), chin straps, of leather, stirrup leathers, umbrella handles, walking stick handles, suitcase handles, backpacks, riding saddles, net bags for shopping, umbrella or parasol ribs, bags for climbers, travelling sets (leatherware), sling bags for carrying infants, garment bags for travel, handbags, tool bags of leather (empty), wheeled shopping bags, beach bags, bags for campers, shopping bags, school bags, travelling trunks; cases, of leather or leatherboard; nose bags (feed bags), bridoons, canes, umbrella sticks, walking stick seats, bits for animals (harness), bridles (harness), harness for animals, key cases (leatherware), horse collars, valises, suitcases, attaché cases, covers for horse-saddles, umbrella covers, kid, curried skins, cattle skins, leather leashes, blinders (harness), game bags (hunting accessory).

35 – Advertising; business management; business administration; office functions; on-line advertising on a computer network, radio advertising, television advertising, publication of publicity texts, demonstration of goods, auctioneering, organization of exhibitions for commercial or advertising purposes, business information, statistical information, import-export agencies, distribution of samples, sales promotion (for others) including via the Internet, procurement services for others (purchasing goods and services for other businesses) including via the Internet, sale of goods via intermediaries, wholesale and retail services.

(260) AM 2015 76952 A

(800) 1152316

(891) 2014 02 17

(731) LYAPKO

Nikolai Grigorievich m-n Sonyachny, 8,
kv. 21, Krasnogorivka, Mariinsky r-n,
Donetskaya obl. 85402, UA

(540)

LYAPKO

(511)

10 – Anaesthetic apparatus; bandages, elastic; traction apparatus for medical purposes; galvanic belts for medical purposes; galvanic therapeutic appliances; needles for medical purposes; acupuncture needles; electric acupuncture instruments; heating cushions [pads], electric, for medical purposes; corsets for medical purposes; abdominal corsets; lamps for medical purposes; beds, specially made for medical purposes; medical apparatus and instruments; massage apparatus; gloves for massage; water beds for medical purposes; childbirth mattresses; furniture especially made for medical purposes; knee bandages, orthopedic; orthopaedic footwear [shoes]; orthopaedic articles; orthopaedic soles; orthopaedic belts; draw-sheets for sick beds; suspensory bandages; supportive bandages; pads [pouches] for preventing pressure sores on patient bodies; abdominal pads; maternity belts; belts, electric, for medical purposes; belts for medical purposes; orthopaedic [orthopedic] belts; resuscitation apparatus; arch supports for footwear; thermal packs for first aid purposes; blankets, electric, for medical purposes; supports for flat feet; physical exercise apparatus, for medical purposes; physiotherapy apparatus; boots for medical purposes; splints, surgical; respirators for artificial respiration.

35 – Radio advertising; advertising by mail order; advertising; television advertising.

(260) AM 2015 76957 A

(800) 1199413

(891) 2014 01 10

(731) FUAT ÖMEROĞLU

Kartaltepe Mh. Gülseren Sk. No:3,
Bayrampaşa, Istanbul, TR

(540)



(591) Black, white

(526) The trademark is protected as a whole. The words "EXCLUSIVE", "STYLE" included therein shall not be subject to independent legal protection.

(511)

25 – Clothing, footwear, headgear.

(260) AM 2015 76958 A

(800) 1199428

(891) 2014 03 06

(731) Obschestvo s Ogranichennoy

Otvetstvennostyu "INTELLEKTUALNOE

PRAVO"
kv. 11, d. 63, ul. Stepana Rasina, RU-443099
Samara, RU

(540)

ARISTOCRAT

(511)

33 – Vodka.

(260) AM 2015 76959 A

(800) 1199442

(891) 2014 02 18

(731) MERCK SHARP & DOHME CORP.
One Merck Drive, Whitehouse Station
NJ 08889, US

(540)



(591) Black, grey, white

(511)

5 – Human vaccine preparations.

(260) AM 2015 76960 A

(800) 1199455

(891) 2014 02 10

(731) EGIS GYÓGYSZERGYÁR ZRT.
Keresztúri út 30-38, H-1106 Budapest, HU

(540)

COMFITENS

(511)

5 – Pharmaceutical preparations for human use.

(260) AM 2015 76961 A

(800) 1199470

(891) 2013 11 13

(731) KOMEK MACHINERY LIMITED
LIABILITY COMPANY
Elizavetinskoye shosse 42, RU-620024
EKATERINBURG, RU

(540)



(591) White and blue

(511)

4 – Industrial oils and greases; lubricants; dust absorbing, wetting and binding compositions; fuels, including motor spirit, and illuminants; candles and wicks for lighting; anthracite; benzene; benzene; wood briquettes; combustible briquettes; petroleum jelly for industrial purposes; wax [raw material]; ozocerite [ozokerite]; illuminating wax; industrial wax; belting wax; carnauba wax; beeswax; gas for light-

ting; oil-gas; fuel gas; gasoline; producer gas; solidified gases [fuel]; fuel; lubricating graphite; additives, non-chemical, to motor-fuel; firewood; cutting fluids; fish oil, not edible; lanolin; illuminating grease; grease for leather; grease for boots; greases for the preservation of leather; tallow; industrial grease; kerosene; coke; xylene; xylol; ligroin; mazut; combustible oil; oils for paints; oils for releasing form work [building]; oil for the preservation of masonry; textile oil; lubricating oil; industrial oil; moistening oil; coal tar oil; coal naphtha; castor oil for technical purposes; bone oil for industrial purposes; motor oil; sunflower oil for industrial purposes; rape oil for industrial purposes; naphtha; petroleum, raw or refined; nightlights [candles]; oleine; paraffin; dust removing preparations; soya bean oil preparations for non-stick treatment of cooking utensils; non-slipping preparations for belts; coal dust [fuel]; Christmas tree candles; candles; perfumed candles; grease for arms [weapons]; lubricating grease; grease for belts; vaporized fuel mixtures; dust laying compositions; alcohol [fuel]; methylated spirit; stearine; diesel oil; lighting fuel; mineral fuel; fuel with an alcoholic base; peat [fuel]; peat briquettes [fuel]; lignite; charcoal [fuel]; coal; coal briquettes; lamp wicks; wicks for candles; ceresine; electrical energy; petroleum ether.

7 – Machines and machine tools; motors and engines, except for land vehicles; machine coupling and transmission components, except for land vehicles; agricultural implements other than hand-operated; incubators for eggs; automatic vending machines; electric welding machines; aerated beverage-making machines; gas-operated soldering apparatus; vulcanisation apparatus; acetylene cleaning apparatus; apparatus for drawing up beer under pressure; aerated water making apparatus; inking apparatus for printing machines; aerators; expansion tanks [parts of machines]; drums [parts of machines]; reels, mechanical, for flexible hoses; concrete mixers [machines]; reels [parts of machines]; bobbins for weaving looms; flues for engine boilers; harrows; bulldozers; hoppers [mechanical discharging]; mine borers; truck lifts; printing rollers for machines; rolling mill cylinders; crank shafts; transmission shafts, other than for land vehicles; valves [parts of machines]; fans for motors and engines; saw benches [parts of machines]; winnowers; bearings [parts of machines]; water heaters [parts of machines]; winches; floating or non-floating drilling rigs; lawnmowers [machines]; card clothing [parts of carding machines]; emergency power generators; alternators; dynamos; bicycle dynamos; current generators; generators of electricity; exhausts for motors and engines; drilling heads [parts of machines]; drilling bits [parts of machines]; cylinder heads for engines; gas-operated soldering blow pipes; raking machines; stalk separators [machines]; mud catchers and collectors [machines]; tarring machines; motors, other than for

land vehicles; hydraulic engines and motors; aeronautical engines; aeroplane engines; engines for air cushion vehicles; compressed air engines; jet engines other than for land vehicles; engines for boats; driving motors other than for land vehicles; de-aerators for feedwater; disintegrators; tympan [parts of printing presses]; holding devices for machine tools; blade holders [parts of machines]; turf removing ploughs; pressure reducers [parts of machines]; pump diaphragms; chisels for machines; jacks [machines]; rack and pinion jacks; moving pavements [sidewalks]; electric hand drills; grinders/crushers, electric, for household purposes; reapers; reapers and binders; millstones; rakes for raking machines; shredders [machines] for industrial use; injectors for engines; tools [parts of machines]; hand-held tools, other than hand-operated; air condensers; capstans; calenders; rotary steam presses, portable, for fabrics; ditchers [ploughs]; carburetters; carriages for knitting machines; crankcases for machines, motors and engines; road rollers; pressure valves [parts of machines]; clack valves [parts of machines]; electric can openers; cowlings [parts of machines]; machine wheels; freewheels other than for land vehicles; machine boiler scale collectors; lasts for shoes [parts of machines]; brake shoes other than for vehicles; ball rings for bearings; piston segments; grease rings [parts of machines]; reapers and threshers; coalcutting machines; fittings for engine boilers; compressors [machines]; air pumps [garage installations]; compressors for refrigerators; conveyors [machines]; belt conveyors; converters for steel works; aerocondensers; steam condensers [parts of machines]; diggers [machines]; rams [machines]; thermic lances [machines]; mechanized livestock feeders; root slicers [machines]; boxes for matrices [printing]; gear boxes other than for land vehicles; grease boxes [parts of machines]; housings [parts of machines]; harvesting machines; steam engine boilers; coffee grinders, other than hand-operated; taps [parts of machines, engines or motors]; roller bridges; cranes [lifting and hoisting apparatus]; drain cocks; spray guns for paint; cranks [parts of machines]; potters' wheels; grindstones [parts of machines]; cultivators [machines]; motorized cultivators; ploughshares; belts for conveyors; igniting magnetos; igniting magnetos for engines; handling machines, automatic [manipulators]; lubricators [parts of machines]; churns; matrices for use in printing; machine flywheels; hair clipping machines for animals; machines for the textile industry; papermaking machines; vibrators [machines] for industrial use; bellows [machines]; knitting machines; bending machines; ironing machines; mineworking machines; net hauling machines [fishing]; bottle sealing machines; sealing machines for industrial purposes; embossing machines; engraving machines; finishing machines; garbage disposals; stropping machines; earth moving machines; cord making machines; lace making ma-

chines; butter machines; cigarette machines for industrial purposes; sausage machines; stereotype machines; hosiery looms; crushing machines; dyeing machines; bottle washing machines; dishwashers; bottle filling machines; racket stringing machines; leather-working machines; dairy machines; glass working machines; tobacco processing machines; corn husking machines; painting machines; oil refining machines; peeling machines; printing machines for use on sheet metal; brewing machines; colour-washing machines; leather paring machines; bitumen making machines; machines for making edible pastes; sugar making machines; weeding machines; cinder sifters [machines]; puddling machines; notchers [machine tools]; bread cutting machines; blowing machines for the compression, exhaustion and transport of gases; road making machines; railroad constructing machines; rail-laying machines; bottle capping machines; bottle stoppering machines; trash compacting machines; blowing machines for the compression, sucking and carrying of grain; die-stamping machines; stamping machines; darning machines; drainage machines; wrapping machines; grain separators; bookbinding apparatus and machines for industrial purposes; electric machines and apparatus for cleaning; electric machines and apparatus for carpet shampooing; electric machines and apparatus for polishing; sizing machines; punching machines; riveting machines; electric kitchen machines; foundry machines; smoothing presses; fleshing machines; rinsing machines; flour mill machines; hemming machines; braiding machines; wringing machines for laundry; steam engines; printing machines; rotary printing presses; typographic machines; compressed air machines; type-setting machines [printing]; apparatus for dressing; spinning machines; heel-making machines; filling machines; friezing machines; cutting machines; self-propelled road sweeping machines; satinizing machines; agricultural machines; sorting machines for industry; stitching machines; washing machines; laundry washing machines; coin-operated washing machines; clippers [machines]; drying machines; looms [machines]; kneading machines; beating machines; electric beaters; packing machines; molding machines; type-setting machines [photocomposition]; carding machines; sewing machines; typecasting machines; electromechanical machines for chemical industry; labellers [machines]; ore treating machines; milking machines; mills [machines]; mills for household purposes, other than hand-operated; pepper mills other than hand-operated; flour mills; centrifugal mills; hydraulic controls for machines, motors and engines; machine wheelwork; pneumatic controls for machines, motors and engines; feeders [parts of machines]; forge bellows; mixers [machines]; electric blenders for household purposes; agitators; vacuum cleaner bags; threshing machines; pneumatic hammers; hammers [parts of machines]; tilt hammers;

power hammers; mechanical reeling apparatus; motors for boats; clutches other than for land vehicles; meat choppers [machines]; superchargers; guides for machines; vacuum cleaner attachments for disseminating perfumes and disinfectants; pumps [machines]; pumps [parts of machines, engines or motors]; aerating pumps for aquaria; vacuum pumps [machines]; compressed air pumps; pumps for heating installations; beer pumps; lubricating pumps; centrifugal pumps; blades [parts of machines]; knives for mowing machines; chaff cutter blades; electric knives; electric shears; bearing brackets for machines; atomisers [machines]; axles for machines; steam traps; chucks [parts of machines]; drill chucks [parts of machines]; exhaust manifold for engines; gas-operated soldering irons; superheaters; gears, other than for land vehicles; reduction gears other than for land vehicles; propulsion mechanisms other than for land vehicles; drilling machines; saws [machines]; chain saws; guns [tools using explosives]; electric glue guns; compressed air guns for the extrusion of mastics; carburetter feeders; feeding apparatus for engine boilers; loading ramps; ploughs; pneumatic transporters; hangers [parts of machines]; anti-friction bearings for machines; roller bearings; self-oiling bearings; bearings for transmission shafts; ball-bearings; journal boxes [parts of machines]; elevators [lifts]; lifts, other than ski-lifts; hoists; pulleys; saw blades [parts of machines]; pistons [parts of machines or engines]; plunger pistons; pistons for engines; pistons for cylinders; catalytic converters; torque converters other than for land vehicles; fuel conversion apparatus for internal combustion engines; presses [machines for industrial purposes]; presses; fodder presses; printing presses; typographic presses; swaging machines; transmissions for machines; elevator belts; pedal drives for sewing machines; bicycle assembling machines; high pressure washers; cleaning appliances utilizing steam; electric food processors; springs [parts of machines]; spinning wheels; punches for punching machines; kick starters for motorcycles; vacuum cleaners; tambours for embroidery machines; cooling radiators for motors and engines; sewage pulverizers; air brushes for applying colour; regulators [parts of machines]; pressure regulators [parts of machines]; feedwater regulators; speed governors for machines, engines and motors; knives [parts of machines]; gas-operated cutting blow pipes; loom shafts; gears for weaving looms; belts for machines; fan belts for motors and engines; dynamo belts; belts for motors and engines; adhesive bands for pulleys; sifters; robots [machines]; stuffing boxes [parts of machines]; paper feeders [printing]; electric whisks for household purposes; sparking plugs for internal combustion engines; glow plugs for Diesel engines; tedding machines; separators; steam/oil separators; cream/milk separators; sowers [machines]; mixing machines; snow ploughs; sheaf-binding machines; joints [parts

of engines]; shaft couplings [machines]; electric fruit presses for household purposes; chaff cutters; suction cups for milking machines; stands for machines; machine tools; woodworking machines; sharpening machines; die-cutting and tapping machines; trueing machines; mortising machines; stone working machines; metalworking machines; threading machines; planing machines; looms; lathes [machine tools]; milling machines; metal drawing machines; rolling mills; starters for motors and engines; stators [parts of machines]; glaziers' diamonds [parts of machines]; tables for machines; derricks; slide rests [parts of machines]; couplings other than for land vehicles; heat exchangers [parts of machines]; grating machines for vegetables; transmissions, other than for land vehicles; control cables for machines, engines or motors; boiler tubes [parts of machines]; turbines other than for land vehicles; hydraulic turbines; turbocompressors; connecting rods for machines, motors and engines; central vacuum cleaning installations; suction machines for industrial purposes; vehicle washing installations; degreasers [machines]; dust exhausting installations for cleaning purposes; mineral water making machines; sifting installations; pneumatic tube conveyors; dust removing installations for cleaning purposes; condensing installations; air suction machines; dividing machines; igniting devices for internal combustion engines; washing apparatus; binding apparatus for hay; extractors for mines; hydraulic door openers and closers [parts of machines]; pneumatic door openers and closers [parts of machines]; anti-pollution devices for motors and engines; electrically operated curtain drawing devices; adhesive tape dispensers [machines]; electromechanical beverage preparation machines; electromechanical food preparation machines; control mechanisms for machines, engines or motors; electric shoe polishers; electric machines and apparatus for wax-polishing; air cushion devices for moving loads; handling apparatus for loading and unloading; elevating apparatus; aprons [parts of machines]; filter presses; filters [parts of machines or engines]; filtering machines; filters for cleaning cooling air, for engines; molds [parts of machines]; printing plates; brake segments other than for vehicles; journals [parts of machines]; centrifugal machines; elevator chains [parts of machines]; driving chains other than for land vehicles; cylinders for motors and engines; cylinders for machines; printing cylinders; shuttles [parts of machines]; universal joints [Cardan joints]; pulleys [parts of machines]; vacuum cleaner hoses; brushes [parts of machines]; dynamo brushes; brushes, electrically operated; carbon brushes [electricity]; ejectors; fuel economisers for motors and engines; excavators; mechanical shovels; agricultural elevators; electric motors, other than for land vehicles; electric hammers; electric parquet wax-polishers; cartridges for filtering machines; escalators; automatic grapnels for

marine purposes; distribution machines, automatic; electrical apparatus for sealing plastics [packaging]; electric arc cutting apparatus; electric arc welding apparatus; electric welding apparatus; electric soldering apparatus; gasoline pumps for service stations; self-regulating fuel pumps; fuel dispensing pumps for service stations; electroplating apparatus; electric door closers; electric door openers; elevator operating apparatus; electric soldering irons; electrodes for welding machines.

9 – Scientific, nautical, surveying, photographic, cinematographic, optical, weighing, measuring, signalling, checking (supervision), life-saving and teaching apparatus and instruments; apparatus and instruments for conducting, switching, transforming, accumulating, regulating or controlling electricity; apparatus for recording, transmission or reproduction of sound or images; magnetic data carriers, recording discs; compact discs, DVDs and other digital recording media; mechanisms for coin-operated apparatus; cash registers, calculating machines, data processing equipment, computers; computer software; fire-extinguishing apparatus; ticket dispensers; coin-operated musical automata [juke boxes]; motor fire engines; answering machines; electric accumulators; electric accumulators for vehicles; actinometers; alidades; altimeters; ammeters; anemometers; anodes; aerials; anticathodes; apertometers [optics]; high-frequency apparatus; testing apparatus not for medical purposes; remote control apparatus; electrodynamic apparatus for the remote control of railway points; electro-dynamic apparatus for the remote control of signals; electric monitoring apparatus; sound recording apparatus; distillation apparatus for scientific purposes; diffraction apparatus [microscopy]; air analysis apparatus; apparatus to check franking; sound transmitting apparatus; apparatus for fermentation [laboratory apparatus]; breathing apparatus, except for artificial respiration; breathing apparatus for underwater swimming; apparatus and installations for the production of X-rays, not for medical purposes; cash registers; electric apparatus for commutation; intercommunication apparatus; stills for laboratory experiments; projection apparatus; roentgen apparatus not for medical purposes; radiological apparatus for industrial purposes; blueprint apparatus; flashing lights [luminous signals]; stereoscopic apparatus; telegraphs [apparatus]; telephone apparatus; telephone transmitters; facsimile machines; phototelegraphy apparatus; igniting apparatus, electric, for igniting at a distance; acid hydrometers; salinometers; acidimeters for batteries; aerometers; luminous beacons; barometers; anode batteries; galvanic batteries; batteries for pocket-lamps; batteries for lighting; solar batteries; electric batteries; balances [steelyards]; betatrons; electronic tags for goods; magnetic tape units for computers; computer memories; fire hose nozzles; safety tarpaulins; signalling buoys; life buoys; marking buoys;

directional compasses; vacuum gauges; electrolyzers; variometers; scales; letter scales; weighbridges; precision balances; levelling staffs [surveying instruments]; camcorders; video cassettes; video telephones; video screens; photographic viewfinders; plugs, sockets and other contacts [electric connections]; micrometer screws for optical instruments; viscosimeters; circuit closers; wavemeters; voltmeters; mechanical signs; switchboxes [electricity]; current rectifiers; jigs [measuring instruments]; gas testing instruments; gasometers; galvanometers; heliographic apparatus; hygrometers; hydrometers; weights; peepholes [magnifying lenses] for doors; holograms; plotters; loudspeakers; sounding leads; plumb bobs; range finders; densimeters; densitometers; optical goods; detectors; galena crystals [detectors]; smoke detectors; false coin detectors; slides [photography]; slide projectors; diaphragms [photography]; dictating machines; dynamometers; floppy disks; phonograph records; magnetic disks; optical discs; calculating disks; disk drives for computers; juke boxes for computers; electronic notice boards; bullet-proof waistcoats [vests (Am.)]; life jackets; identification threads for electric wires; nose clips for divers and swimmers; electric locks; bells [warning devices]; electric alarm bells; electric door bells; signal bells; acoustic conduits; mirrors for inspecting work; luminous or mechanical road signs; luminous signs; marine depth finders; probes for scientific purposes; buzzers; electric buzzers; needles for record players; measures; pressure measuring apparatus; simulators for the steering and control of vehicles; inverters [electricity]; pressure indicators; temperature indicators; incubators for bacteria culture; measuring instruments; mathematical instruments; levelling instruments; surveying instruments; azimuth instruments; interfaces for computers; ionization apparatus not for the treatment of air; sparkguards; coaxial cables; fibre [fiber (Am.)] optic cables; electric cables; calipers; slide calipers; screw-tapping gauges; calculating machines; pocket calculators; decompression chambers; cinematographic cameras; electronic pens [visual display units]; holders for electric coils; magnetic identity cards; video game cartridges; encoded magnetic cards; protective helmets; carriers for dark plates [photography]; cathodes; choking coils [impedance]; electric coils; electromagnetic coils; spools [photography]; exposed cinematographic film; computer keyboards; solenoid valves [electromagnetic switches]; wire connectors [electricity]; electronic agendas; push buttons for bells; mouse pads; magnetic encoders; anti-dazzle shades; collectors, electric; calibrating rings; protective suits for aviators; commutators; compact discs [read-only memory]; compact discs [audio-video]; comparators; marine compasses; computers; notebook computers; capacitors; electric contacts; electric contacts of precious metal; wind socks for indicating wind direction; branch boxes [electricity];

distribution boxes [electricity]; connectors [electricity]; junction boxes [electricity]; accumulator jars; cabinets for loudspeakers; diving suits; reflecting discs for wear, for the prevention of traffic accidents; covers for electric outlets; logs [measuring instruments]; lasers, not for medical purposes; lactodensimeters; lactometers; darkroom lamps [photography]; neon signs; thermionic valves [radio]; amplifying tubes; flashlights [photography]; head cleaning tapes [recording]; magnetic tapes; videotapes; surveying chains; fire escapes; rulers [measuring instruments]; slide-rules; contact lenses; correcting lenses [optics]; optical lenses; lens hoods; optical condensers; sounding lines; electricity conduits; measuring spoons; magnifying glasses [optics]; thread counters; magnets; decorative magnets; resuscitation mannequins [teaching apparatus]; mouse [data processing equipment]; manometers; divers' masks; solderers' helmets; protective masks; materials for electricity mains [wires, cables]; voting machines; money counting and sorting machines; material testing instruments and machines; hemline markers; speaking tubes; diaphragms [acoustics]; diaphragms for scientific apparatus; metal detectors for industrial or military purposes; metronomes; rules [measuring instruments]; carpenters' rules; dressmakers' measures; mechanisms for counter-operated apparatus; coin-operated mechanisms for television sets; shutter releases [photography]; micrometer gauges; microprocessors; microscopes; microtomes; microphones; modems; lightning arresters; monitors [computer hardware]; animated cartoons; terminals [electricity]; junction sleeves for electric cables; cases fitted with dissecting instruments [microscopy]; teeth protectors; knee-pads for workers; headphones; surveyors' levels; verniers; sound recording carriers; magnetic data media; optical data media; electrically heated socks; sheaths for electric cables; identification sheaths for electric wires; weighing machines; punched card machines for offices; furniture especially made for laboratories; shoes for protection against accidents, irradiation and fire; objectives [lenses] [optics]; lenses for astrophotography; egg-candlers; fire extinguishers; electrified fences; limiters [electricity]; clothing for protection against accidents, irradiation and fire; clothing for protection against fire; asbestos clothing for protection against fire; ozonisers [ozonators]; octants; eyepieces; ohmmeters; wrist rests for use with computers; spectacle frames; eyeglass frames; oscillographs; plumb lines; mirrors [optics]; spectacles [optics]; sunglasses; goggles for sports; luminous or mechanical signalling panels; radio pagers; eyeglasses; electronic pocket translators; transmitters [telecommunication]; transmitters of electronic signals; electric switches; periscopes; gloves for divers; asbestos gloves for protection against accidents; gloves for protection against accidents; gloves for protection against X-rays for industrial purposes; furnaces for

laboratory experiments; pipettes; pyrometers; planimeters; plane tables [surveying instruments]; plates for batteries; wafers for integrated circuits; compact disc players; cassette players; sound recording strips; films, exposed; life-saving rafts; laboratory trays; semi-conductors; polarimeters; fire engines; measuring glassware; life belts; circuit breakers; fuses; electric converters; telerupters; food analysis apparatus; diagnostic apparatus, not for medical purposes; distance measuring apparatus; speed measuring apparatus [photography]; appliances for measuring the thickness of leather; apparatus for measuring the thickness of skins; speed checking apparatus for vehicles; teaching apparatus; time recording apparatus; distance recording apparatus; apparatus and instruments for astronomy; surveying apparatus and instruments; weighing apparatus and instruments; nautical apparatus and instruments; optical apparatus and instruments; apparatus and instruments for physics; chemistry apparatus and instruments; measuring apparatus; electric measuring devices; boiler control instruments; cosmographic instruments; meteorological instruments; naval signalling apparatus; observation instruments; navigation apparatus for vehicles [on-board computers]; satellite navigational apparatus; electric regulating apparatus; precision measuring apparatus; instruments containing eyepieces; audio- and video-receivers; prisms [optics]; printers for use with computers; apparatus for changing record player needles; retorts' stands; drainers for use in photography; cleaning apparatus for phonograph records; fire beaters; sighting telescopes for firearms; test tubes; pressure indicator plugs for valves; magnetic wires; telegraph wires; telephone wires; electric wires; electric conductors; insulated copper wire; fuse wire; recorded computer operating programs; computer game programs; computer programs [downloadable software]; record players; central processing units [processors]; rods for water diviners; downloadable electronic publications; distribution consoles [electricity]; control panels [electricity]; radar apparatus; vacuum tubes [radio]; masts for wireless aerials; transmitting sets [telecommunication]; radios; vehicle radios; frames for photographic transparencies; screens for photoengraving; walkie-talkies; voltage surge protectors; voltage regulators for vehicles; electric light dimmers; stage lighting regulators; speed regulators for record players; cell switches [electricity]; washing trays [photography]; marking gauges [joinery]; automatic time switches; electric relays; safety restraints, other than for vehicle seats and sports equipment; X-ray photographs, other than for medical purposes; rheostats; respirators, other than for artificial respiration; respirators for filtering air; retorts; refractometers; refractors; grids for batteries; horns for loudspeakers; saccharometers; optical fibers [fibres] [light conducting filaments]; dog whistles; whistle alarms; sextants; inductors [elec-

tricity]; life nets; nets for protection against accidents; fire alarms; luminous or mechanical signals; sirens; scanners [data processing equipment]; integrated circuit cards [smart cards]; connections for electric lines; electric connections; sonars; sound locating instruments; lighting ballasts; electric resistances; spectrograph apparatus; spectrosopes; speed indicators; alcoholmeters; satellites for scientific purposes; protection devices for personal use against accidents; audiovisual teaching apparatus; radiotelegraphy sets; radiotelephony sets; spectacle lenses; optical glass; glass covered with an electrical conductor; anti-glare glasses; personal stereos; stereoscopes; fire boats; sulphitometers; drying racks [photography]; spherometers; integrated circuits; printed circuits; counters; parking meters; kilometer recorders for vehicles; revolution counters; abacuses; taximeters; ear plugs for divers; tachometers; television apparatus; telescopes; teleprompters; teleprinters; portable telephones; theodolites; thermometers, not for medical purposes; thermostats; thermostats for vehicles; crucibles [laboratory]; tone arms for record players; totalizers; transistors [electronic]; protractors [measuring instruments]; battery chargers; transformers [electricity]; vehicle breakdown warning triangles; starter cables for motors; discharge tubes, electric, other than for lighting; capillary tubes; X-ray tubes not for medical purposes; telephone receivers; quantity indicators; automatic indicators of low pressure in vehicle tires; gasoline gauges; water level indicators; electric loss indicators; light-emitting electronic pointers; clinometers; levels [instruments for determining the horizontal]; mercury levels; spirit levels; urinometers; amplifiers; particle accelerators; sprinkler systems for fire protection; electric installations for the remote control of industrial operations; automatic steering apparatus for vehicles; balancing apparatus; video recorders; sound reproduction apparatus; invoicing machines; tape recorders; protection devices against X-rays [Roentgen rays], not for medical purposes; apparatus for railway traffic safety appliances; data processing apparatus; oxygen transvasing apparatus; electric theft prevention installations; time clocks [time recording devices]; film cutting apparatus; drying apparatus for photographic prints; optical character readers; centering apparatus for photographic transparencies; dosage dispensers; chargers for electric batteries; sound alarms; sounding apparatus and machines; life saving apparatus and equipment; editing appliances for cinematographic films; cathodic anti-corrosion apparatus; couplers [data processing equipment]; computer peripheral devices; anti-interference devices [electricity]; demagnetizing apparatus for magnetic tapes; acoustic couplers; anti-theft warning apparatus; alarms; non-explosive fog signals; adding machines; readers [data processing equipment]; heat regulating apparatus; photocopiers [photographic, electrostatic, thermic]; bar code re-

aders; filters for respiratory masks; filters for ultraviolet rays, for photography; filters [photography]; magic lanterns; optical lamps; signal lanterns; cameras [photography]; glazing apparatus for photographic prints; shutters [photography]; darkrooms [photography]; photometers; flash-bulbs [photography]; enlarging apparatus [photography]; photovoltaic cells; containers for contact lenses; spectacle cases; eyeglass cases; containers for microscope slides; cases especially made for photographic apparatus and instruments; chromatography apparatus for laboratory use; chronographs [time recording apparatus]; eyeglass chains; cyclotrons; compasses [measuring instruments]; frequency meters; egg timers [sandglasses]; fire blankets; chips [integrated circuits]; pedometers; meteorological balloons; electrified rails for mounting spot lights; protective helmets for sports; eyeglass cords; stands for photographic apparatus; switchboards; distribution boards [electricity]; workmen's protective face-shields; projection screens; radiology screens for industrial purposes; fluorescent screens; screens [photography]; exposure meters [light meters]; ducts [electricity]; galvanic cells; epidiascopes; ergometers; armatures [electricity].

12 – Vehicles; apparatus for locomotion by land, air or water; motor buses; cars; sports cars; concrete mixing vehicles; refrigerated vehicles; casings for pneumatic tires [tyres]; caravans; camping cars; brake linings for vehicles; shock absorbers for automobiles; suspension shock absorbers for vehicles; space vehicles; aircraft; aeronautical apparatus, machines and appliances; snowmobiles; air balloons; luggage carriers for vehicles; ski carriers for cars; vehicle bumpers; bumpers for automobiles; barges; buffers for railway rolling stock; dining cars [carriages]; waggons; carriages [railways]; sleeping cars; dining cars; refrigerated waggons [railroad vehicles]; transmission shafts for land vehicles; bicycles; valves for vehicle tires [tyres]; automobile hoods; hoods for baby carriages; hoods for vehicles; oars; sculls; paddles for canoes; screws [propellers] for ships; seaplanes; air cushion vehicles; flanges for railway wheel tires [tyres]; lorries; horns for vehicles; treads for vehicles [roller belts]; doors for vehicles; engines for land vehicles; motors for cycles; jet engines for land vehicles; screw-propellers; screw-propellers for boats; airships; cable cars; dredgers [boats]; hand cars; bicycle bells; rearview mirrors; portholes; rolling stock for funicular railways; cars for cable transport installations; inner tubes for bicycles, cycles; inner tubes for pneumatic tires [tyres]; hoods for vehicle engines; crankcases for land vehicle components, other than for engines; boats; vehicle wheels; wheels for bicycles, cycles; mine cart wheels; casters for trolleys [vehicles] [carts (Am.)]; brake shoes for vehicles; hub caps; baby carriages; side cars; ships; baskets adapted for cycles; panniers adapted for cycles; gear boxes for land vehicles;

ships' hulls; fenders for ships; bands for wheel hubs; ejector seats for aircraft; wheelchairs; caps for vehicle petrol [gas] tanks; boat hooks; bodies for vehicles; automobile bodies; tipping bodies for lorries [trucks]; traction engines; locomotives; sprinkling trucks; elevating tailgates (Am.) [parts of land vehicles]; propulsion mechanisms for land vehicles; mopeds; motorcycles; freewheels for land vehicles; clutches for land vehicles; repair outfits for inner tubes; adhesive rubber patches for repairing inner tubes; air pumps [vehicle accessories]; bicycle pumps; upholstery for vehicles; rims for vehicle wheels; bicycle rims; windows for vehicles; omnibuses; axles for vehicles; parachutes; ferry boats; pedals for cycles; gearing for land vehicles; treads for retreading tires [tyres]; carts; head-rests for vehicle seats; vehicle running boards; air bags [safety devices for automobiles]; ski lifts; chairlifts; vehicle covers [shaped]; sleeping berths for vehicles; pontoons; torque converters for land vehicles; anti-dazzle devices for vehicles; anti-theft devices for vehicles; sun-blinds adapted for automobiles; non-skid devices for vehicle tires [tyres]; balance weights for vehicle wheels; shock absorbing springs for vehicles; bicycle frames; spars for ships; reduction gears for land vehicles; safety belts for vehicle seats; vehicle suspension springs; rudders; bicycle handle bars; cranks for cycles; aeroplanes; amphibious airplanes; sleighs [vehicles]; kick sledges; bicycle saddles; luggage nets for vehicles; dress guards for bicycles, cycles; anti-theft alarms for vehicles; reversing alarms for vehicles; vehicle seats; safety seats for children, for vehicles; hydraulic circuits for vehicles; rolling stock for railways; bicycle spokes; vehicle wheel spokes; inclined ways for boats; undercarriages for vehicles; water vehicles; military vehicles for transport; air vehicles; cycle cars; vehicles for locomotion by land, air, water or rail; electric vehicles; ambulances; remote control vehicles, other than toys; tricycles; carrier tricycles; windcreens; windscreen wipers; cycle stands; hubs for vehicle wheels; cycle hubs; railway couplings; trailer hitches for vehicles; couplings for land vehicles; wheelbarrows; hose carts; luggage trucks; golf carts; shopping trolleys [carts (Am.)]; bogies for railway cars; casting carriages; tilting-carts; goods handling carts; fork lift trucks; cleaning trolleys; brakes for vehicles; bicycle brakes; torsion bars for vehicles; tractors; tramcars; transmissions, for land vehicles; aerial conveyors; trailers [vehicles]; funnels for locomotives; funnels for ships; cleats [nautical]; turbines for land vehicles; direction signals for vehicles; rowlocks; bicycle stands; disengaging gear for boats; ships' steering gears; cable transport apparatus and installations; spoke clips for wheels; funiculars; vans [vehicles]; caissons [vehicles]; automobile chains; bicycle chains; driving chains for land vehicles; anti-skid chains; tipping apparatus, parts of trucks and waggons; covers for baby carriages;

saddle covers for bicycles or motorcycles; seat covers for vehicles; vehicle chassis; automobile chassis; connecting rods for land vehicles, other than parts of motors and engines; axle journals; gears for cycles; tubeless tires [tyres] for bicycles, cycles; tires for bicycles, cycles; automobile tires [tyres]; tires for vehicle wheels; vehicle wheel tires [tyres]; pneumatic tires [tyres]; spikes for tires [tyres]; davits for boats; launches; timbers [frames] for ships; mudguards; cycle mudguards; electric motors for land vehicles; yachts; cigar lighters for automobiles.

35 – Advertising; business management; business administration; office functions; import-export agencies; commercial information agencies; advertising agencies; cost price analysis; rental of advertising space; business auditing; employment agencies; computerized file management; accounting; business efficiency expert services; demonstration of goods; transcription; opinion polling; marketing studies; business information; provision of business statistical information; business investigations; marketing research; personnel recruitment; business management and organization consultancy; personnel management consultancy; business organization consultancy; business management consultancy; professional business consultancy; business management of performing artists; news clipping services; updating of advertising material; word processing; secretarial services; shorthand; organization of exhibitions for commercial or advertising purposes; arranging newspaper subscriptions for others; organization of trade fairs for commercial or advertising purposes; shop window dressing; business appraisals; payroll preparation; data search in computer files for others; business management assistance; commercial or industrial management assistance; economic forecasting; auctioneering; sales promotion for others, including retail store services; office machines and equipment rental; rental of advertising time on communication media; publicity material rental; rental of vending machines; rental of photocopying machines; publication of publicity texts; typing; radio advertising; bill-posting; distribution of samples; dissemination of advertising matter; on-line advertising on a computer network; advertising by mail order; television advertising; document reproduction; compilation of information into computer databases; business inquiries; systemization of information into computer databases; tax preparation; drawing up of statements of accounts; publicity columns preparation; psychological testing for the selection of personnel; business management of hotels; public relations; modelling for advertising or sales promotion; relocation services for businesses; procurement services for others [purchasing goods and services for other businesses]; telephone answering for unavailable subscribers; photocopying.

(260) AM 2015 76962 A
 (800) 1199485
 (891) 2013 11 20
 (731) THE POLO/LAUREN COMPANY, L.P.
 650 Madison Avenue, New York, NY 10022,
 US

(540)

RALPH LAUREN

(511)

9 – Binoculars, pince-nez cases (eyeglass cases), pince-nez, pince-nez cases, pince-nez chains, pince-nez cords, pince-nez frames, pince-nez chains (eyeglass chains), pince-nez cords, (eyeglass cords), corrective glasses, spectacle cases, spectacle frames, spectacle glasses, spectacles (optics), cases for sunglasses, cords for sunglasses, frames for sunglasses, chains for sunglasses, sunglasses.

11 – Lighting apparatus.

14 – Precious metals and their alloys and goods in precious metals or coated therewith not included in other classes; jewelry articles, precious stones; timepieces and chronometric instruments.

18 – Attache cases, backpacks, beach bags, briefcases (leather goods), walking sticks, card cases (wallets), handbags, key cases, shoulder belts (straps) of leather, parasols, wallets, purses, clutches, school satchels (school bags), school satchels, saddlebags, shopping bags, carrying cases, covers for suits, travel bags, traveling trunks, suitcases, umbrellas, wallets.

20 – Furniture, mirrors, picture frames, pillows.

21 – Household or kitchen utensils and containers; combs and sponges; brushes (except paintbrushes); brush-making materials; glassware, porcelain and earthenware not included in other classes.

24 – Sheets, eiderdowns, bed blankets, duvet covers, pillow cases, pillow shams, bed covers, face towels (not of paper), table napkins of textile, table mats not of paper.

25 – Clothing for men, women and children, footwear, headgear for wear.

27 – Carpets, rugs, mats and matting, linoleum and other materials for covering existing floors, wall hangings (non-textile).

35 – Retail services and online retail store services offering clothing for men, women and children, footwear, headgear for wear, accessories and household collections.

(260) AM 2015 76964 A
 (800) 1199498
 (891) 2013 12 18
 (731) MOSCHINO S.p.A.

Via delle Querce, 51, SAN GIOVANNI IN
 MARIGNANO (Rimini), IT
 (540)

MOSCHINO

(511)

9 – Cases and covers for mobile phones, tablets and computers; keyboards, mobile phones straps, tablet, computers and their parts.

(260) AM 2015 76965 A
 (800) 1199545
 (891) 2014 02 13

(731) Obshchestvo s ogranichennoy
 otvetstvennostyu "PROIZVODSTVENNO-
 KOMMERCHESKAYA FIRMA
 "ATLANTIS-PAK"
 ul. Onuchkina, 72, kh. Lenina, Aksaisky r-n,
 RU-346703 Rostovskaya oblast, RU

(540)



(591) Black, white

(511)

6 – Bags [envelopes, pouches] of plastics for packaging, including shrinkable plastic bags for food packaging; bags for microwave cooking; flexible plastic films used as packaging for food; plastic flexible packaging films sold in bulk to industrial and commercial manufacturers.

(260) AM 2015 76966 A
 (800) 1199552
 (891) 2014 02 25

(731) "SPC "MIRA SYSTEMS GROUP" LLC
 korp. 5, d.5, 2-ya ul. Entouziastov,
 RU-111024 Moscou, UA

(540)

МИРА

(591) Black, white

(511)

9 – Coaxial cables; fibre [fiber (Am.)] optic cables; cables, electric; materials for electricity mains [wires, cables]; magnetic wires; telegraph wires; telephone wires; wires, electric; electricity conduits.

35 – Sales promotion for others; procurement services for others [purchasing goods and services for other businesses]; wholesale and retail trading.

42 – Scientific and technological services and research and design relating thereto; industrial analysis and research services; design and development of computer hardware and software; chemical analysis; analysis for oil-field exploitation; architecture; bacteriological research; chemistry services; chemical research; architectural consultation; construction drafting; technical research; oil-well testing; cosme-

tic research; design of interior decor; industrial design; packaging design, packaging design services; material testing; technical project studies; geological surveys; oil-field surveys; engineering; meteorological information, weather forecasting; land surveying, land surveys; computer rental; computer programming; oil prospecting; physics [research]; mechanical research; textile testing; geological prospecting; geological research; authenticating works of art; calibration [measuring]; computer software design; updating of computer software; consultancy in the design and development of computer hardware; dress designing; graphic arts design; quality control; rental of computer software; research and development of new products for others; styling [industrial design]; underwater exploration; recovery of computer data; maintenance of computer software; computer system analysis; biological research; urban planning; surveying; computer system design; vehicle roadworthiness testing; duplication of computer programs; conversion of data or documents from physical to electronic media; creating and maintaining web sites for others; hosting computer sites [web sites]; installation of computer software; cloud seeding; data conversion of computer programs and data [not physical conversion]; computer software consultancy; rental of web servers; computer virus protection services; consultancy in the field of energy-saving; research in the field of environmental protection; providing search engines for the Internet; digitization of documents [scanning]; handwriting analysis [graphology]; provision of scientific information, advice and consultancy in relation to carbon offsetting; quality evaluation of standing timber, quality valuation of standing timber; quality evaluation of wool; monitoring of computer systems by remote access; water analysis; scientific laboratory services; energy auditing; web site design consultancy; software as a service [SaaS]; information technology [IT] consultancy; scientific research; server hosting; clinical trials; off-site data backup; electronic data storage; providing information on computer technology and programming via a web site; cartography services; cloud computing.

(260) AM 2015 76976 A
(800) 1199560
(891) 2014 02 18
(731) BAYER INTELLECTUAL PROPERTY
GMBH
Alfred-Nobel-Straße 10, 40789 Monheim am
Rhein, DE
(540)

CIRQENTOS

(511)
5 – Pharmaceutical preparations.

(260) AM 2015 76977 A
(800) 1199587
(891) 2014 03 12
(731) JAPAN TOBACCO INC.
2-2-1 Toranomom, Minato-ku, Tokyo, JP
(540)

ACTIVATE DOUBLE

(591) Black, white
(511)
34 – Tobacco, raw or manufactured; smoking tobacco, pipe tobacco, rolling tobacco, chewing tobacco, moist tobacco powder called "snus"; cigarettes, cigars, cigarillos; snuff; smokers' articles included in this class; cigarette paper, cigarette tubes and matches.

(260) AM 2015 76978 A
(800) 1199611
(891) 2013 12 16
(731) MODECOM S.A.
Oltarzew, ul. Ceramiczna 7, PL-05-850
Ożarów, PL
(540)

MODECOM

(591) White and red
(511)
9 – Apparatus for recording, transmission or reproduction of sound or images, magnetic and optical data carriers, computers and parts thereof, tablets, laptop computers, notebook computers, mobile telephones, monitors, screens, televisions, navigation apparatus, power supply units for computers, telephones, screens for mp3 and mp4 players, speakers, UPS apparatus, automobile power supply units for notebook computers, automobile voltage regulators, batteries, accumulators, chargers, network apparatus, namely routers, switches, network cards for computers, apparatus for wireless communication, cooling apparatus for computers, memory card readers, power strips for computers (hubs), remote controls for computers and multimedia apparatus, speakers, speaker sets, wireless audio modules, headphones, microphones, digital cameras and camcorders, car video recorders and web cameras, digital telephones, palmtops, power strips with sockets, data processing equipment, housings for computers, computer mice, keyboards, bags for carrying computers, bags and cases for laptop computers, cases for navigation apparatus and tablets, pads for laptop computers, notebook computers and tablets.

(260) AM 2015 76979 A
(800) 1199616
(891) 2013 08 07

(731) Staatliches Hofbräuhaus in München
Hofbräu Allee 1, 81829 München, DE
(540)

HOFBRÄU

(511)
21 – Glassware, porcelain and earthenware (included in this class); household or kitchen utensils and containers (not of precious metal or coated therewith); bottle openers; statues of porcelain, clay or glass (included in this class); tableware (included in this class); cups of paper or plastic; glasses, pitchers (included in this class); trays; coasters, not of paper and other than table linen; all the aforesaid goods, included in this class.

25 – Clothing; headgear; footwear; belts for clothing; suspender belts; scarfs; neckties and ascots.

43 – Accommodation and catering for guests; bar services; hotel services; rental of meeting rooms; rental of tents; renting of chairs, tables, table linen, glasses; rental of portable buildings; franchising, namely rental of furniture, tableware, glasses, pitchers, table covers, furniture decorations, napkins, bottle openers and beer mats.

(260) AM 2015 76980 A
(800) 1199632
(891) 2014 02 24

(731) RICHTER GEDEON NYRT.
Gyömrői út 19-21, H-1103 Budapest,
HU

(540)

Зингидакс

(511)
5 – Pharmaceutical preparations.

(260) AM 2015 76981 A
(800) 1199647
(891) 2014 03 20
(731) BROOKSBURNETT INVESTMENTS LTD
SOFIAS TSIROU, 9 TOULLA, COURT 3,
2ND FL. FLAT OFFICE 22, CY-3021
LIMASSOL, CY

(540)

LADY GLAMOUR

(511)
25 – Stockings; socks; knitted lingerie.

(260) AM 2015 76997 A
(800) 1199779
(891) 2014 02 24
(731) IIC-INTERSPORT International Corporation
GmbH
Wölflistrasse 2, CH-3006 Bern, CH

(540)

AQUABASE

(511)
25 – Clothing, footwear, headgear, outdoor clothing and footwear for men, women and children.

(260) AM 2015 76998 A
(800) 1199808
(891) 2014 02 19
(731) FUJIFILM Corporation
26-30, Nishiazabu 2-chome, Minato-ku,
Tokyo 106-8620, JP

(540)

FUJICOLOR

(591) Black, White
(511)
1 – Unexposed photographic films; unexposed photographic papers.

(260) AM 2015 76999 A
(800) 1199834
(891) 2014 03 14
(731) JAPAN TOBACCO INC.
2-2-1 Toranomom, Minato-ku, Tokyo, JP

(540)



(591) Blue and red
(511)
34 – Tobacco, raw or manufactured; smoking tobacco, pipe tobacco, rolling tobacco, chewing tobacco, moist tobacco powder called "snus"; cigarettes, cigars, cigarillos; snuff; smokers' articles included in this class; cigarette paper, cigarette tubes and matches.

(260) AM 2015 77004 A
(800) 1199859
(891) 2013 11 05
(731) POROS LIMITED
1 Beauchamp Court, Victors Way, Barnet
HERTS EN5 5TZ, GB

(540)



(591) Black, white
(511)
29 – Meat, fish, poultry and game; meat extracts; preserved, frozen, dried and cooked fruits and vegetables; jellies, jams, compotes; eggs; milk and milk products; edible oils and fats; ajvar [preserved pep-

pers]; albumen for culinary purposes; albumin milk; alginates for culinary purposes; almonds, ground; aloe vera prepared for human consumption; anchovy; animal marrow for food; apple purée; bacon; beans, preserved; black pudding; bone oil, edible; broth; broth concentrates; butter; buttercream; caviar; charcuterie; cheese; clams [not live]; cocoa butter; coconut butter; coconut, desiccated; coconut fat; coconut oil; compotes; condensed milk; corn oil; cranberry sauce [compote]; crayfish, not live; cream [dairy products]; croquettes; crustaceans, not live; curd; dates; edible birds' nests; edible fats; edible oils; eggs; fat-containing mixtures for bread slices; fatty substances for the manufacture of edible fats; fish fillets; fish meal for human consumption; fish mousses; fish, not live; fish, preserved; fish, tinned [canned (am.)]; foods prepared from fish; frosted fruits; frozen fruits; fruit-based snack food; fruit chips; fruit jellies; fruit peel; fruit, preserved; fruit preserved in alcohol; fruit pulp; fruit salads; fruit, stewed; fruits, tinned [canned (am.)]; game, not live; gelatine; gherkins; ginger jam; ham; herrings; hummus [chickpea paste]; isinglass for food; jams; jellies for food; kefir [milk beverage]; kimchi [fermented vegetable dish]; kumys [kumyss] [milk beverage]; lard for food; lecithin for culinary purposes; lentils, preserved; linseed oil for culinary purposes; liver; liver pâté; lobsters, not live; low-fat potato chips; margarine; marmalade; meat; meat extracts; meat jellies; meat, preserved; meat, tinned [canned (am.)]; milk; milk beverages, milk predominating; milk ferments for culinary purposes; milk products; milk shakes; mushrooms, preserved; mussels, not live; non-alcoholic egg nog; nuts, prepared; olive oil for food; olives, preserved; onions, preserved; oysters, not live; palm kernel oil for food; palm oil for food; peanut butter; peanuts, processed; peas, preserved; pectin for culinary purposes; piccalilli; pickles; pollen prepared as foodstuff; pork; potato chips; potato flakes; potato fritters; poultry, not live; powdered eggs; prawns, not live; preparations for making bouillon; preparations for making soup; preserved garlic; processed fish spawn; processed seeds; processed sunflower seeds; prostokvasha [soured milk]; raisins; rape oil for food; rennet; ryazhenka [fermented baked milk]; salmon; salted fish; salted meats; sardines; sauerkraut; sausages; sausages in batter; sea-cucumbers, not live; seaweed extracts for food; sesame oil; shellfish, not live; shrimps, not live; silkworm chrysalis, for human consumption; smetana [sour cream]; snail eggs for consumption; soups; soya beans, preserved, for food; soya milk [milk substitute]; spiny lobsters, not live; suet for food; sunflower oil for food; tahini [sesame seed paste]; toasted laver; tofu; tomato juice for cooking; tomato purée; tripe; truffles, preserved; tuna fish; vegetable juices for cooking; vegetable mousses; vegetable salads; vegetable soup preparations; vegetables, cooked; vegetables, dried; vegetables, preserved; vege-

tables, tinned [canned (am.)]; whey; whipped cream; white of eggs; yogurt; yolk of eggs.

30 – Coffee, tea, cocoa and artificial coffee; rice; tapioca and sago; flour and preparations made from cereals; bread, pastry and confectionery; ices; sugar, honey, treacle; yeast, baking-powder; salt; mustard; vinegar, sauces (condiments); spices; ice; allspice; almond confectionery; almond paste; aniseed; aromatic preparations for food; artificial coffee; baking powder; baking soda [bicarbonate of soda for cooking purposes]; barley meal; bean meal; bee glue; beer vinegar; binding agents for ice cream; bread; bread rolls; breadcrumbs; buns; cake frosting [icing]; cake powder; cakes; candy; capers; caramels [candy]; celery salt; cereal bars; cereal-based snack food; cereal preparations; cheeseburgers [sandwiches]; chewing gum; chicory [coffee substitute]; chips [cereal products]; chocolate; chocolate-based beverages; chocolate beverages with milk; chocolate mousses; chow-chow [condiment]; chutneys [condiments]; cinnamon [spice]; cloves [spice]; cocoa; cocoa-based beverages; cocoa beverages with milk; coffee; coffee-based beverages; coffee beverages with milk; coffee flavorings [flavourings]; condiments; confectionery; confectionery for decorating christmas trees; cookies; cooking salt; corn flakes; corn meal; corn, milled; corn, roasted; couscous [semolina]; crackers; cream of tartar for culinary purposes; crushed barley; crushed oats; curry [spice]; custard; dessert mousses [confectionery]; dough; dressings for salad; edible ices; essences for foodstuffs, except etheric essences and essential oils; farinaceous foods; ferments for pastes; flavorings, other than essential oils; flavorings, other than essential oils, for cakes; flavorings, other than essential oils, for beverages; flour-milling products; fondants [confectionery]; frozen yogurt [confectionery ices]; fruit coulis [sauces]; fruit jellies [confectionery]; garden herbs, preserved [seasonings]; ginger [spice]; gingerbread; glucose for culinary purposes; gluten additives for culinary purposes; gluten prepared as foodstuff; golden syrup; groats for human food; gruel, with a milk base, for food; halvah; ham glaze; high-protein cereal bars; hominy; hominy grits; honey; husked barley; husked oats; ice cream; ice for refreshment; ice, natural or artificial; iced tea; infusions, not medicinal; ketchup [sauce]; leaven; linseed for human consumption; liquorice [confectionery]; lozenges [confectionery]; macaroni; macarons [pastry]; malt biscuits; malt extract for food; malt for human consumption; maltose; marinades; marzipan; mayonnaise; meal; meat gravies; meat pies; meat tenderizers, for household purposes; mint for confectionery; molasses for food; muesli; mustard; mustard meal; natural sweeteners; noodle-based prepared meals; noodles; nutmegs; oat-based food; oat flakes; oatmeal; palm sugar; pancakes; pasta; pasta sauce; pasties; pastries; pastry; peanut confectionery; pepper; peppermint sweets; peppers [se-

asonings]; pesto [sauce]; petit-beurre biscuits; petits fours [cakes]; pies; pizzas; popcorn; potato flour for food; powders for ice cream; pralines; preparations for stiffening whipped cream; puddings; quiches; ravioli; relish [condiment]; rice; rice-based snack food; rice cakes; royal jelly; rusks; saffron [seasoning]; sago; salt for preserving foodstuffs; sandwiches; sauces [condiments]; sausage binding materials; sea water for cooking; seasonings; seaweed [condiment]; semolina; sorbets [ices]; soya bean paste [condiment]; soya flour; soya sauce; spaghetti; spices; spring rolls; star aniseed; starch for food; stick liquorice [confectionery]; sugar; sushi; sweetmeats [candy]; tabbouleh; tacos; tapioca; tapioca flour for food; tarts; tea; tea-based beverages; thickening agents for cooking foodstuffs; tomato sauce; tortillas; turmeric for food; unleavened bread; unroasted coffee; vanilla [flavoring] [flavouring]; vanillin [vanilla substitute]; vegetal preparations for use as coffee substitutes; vermicelli [noodles]; vinegar; waffles; wheat flour; wheat germ for human consumption; yeast.

32 – Beers; mineral and aerated waters and other non-alcoholic beverages; fruit beverages and fruit juices; syrups and other preparations for making beverages; aerated water; aloe vera drinks, non-alcoholic; aperitifs, non-alcoholic; beer; beer wort; cider, non-alcoholic; cocktails, non-alcoholic; essences for making beverages; extracts of hops for making beer; fruit juice; fruit nectars, non-alcoholic; ginger ale; grape must, unfermented; isotonic beverages; kvass [non-alcoholic beverage]; lemonades; lithia water; malt beer; malt wort; milk of almonds [beverage]; mineral water [beverages]; must; non-alcoholic beverages; non-alcoholic fruit extracts; non-alcoholic fruit juice beverages; non-alcoholic honey-based beverages; orgeat; pastilles for effervescing beverages; peanut milk [non-alcoholic beverage]; powders for effervescing beverages; preparations for making aerated water; preparations for making beverages; preparations for making liqueurs; preparations for making mineral water; sarsaparilla [non-alcoholic beverage]; seltzer water; smoothies; soda water; sorbets [beverages]; syrups for beverages; syrups for lemonade; table waters; tomato juice [beverage]; vegetable juices [beverages]; waters [beverages]; whey beverages.

33 – Alcoholic beverages (except beers); alcoholic beverages containing fruit; alcoholic beverages, except beer; alcoholic essences; alcoholic extracts; anise [liqueur]; anisette [liqueur]; aperitifs; arak [arack]; bitters; brandy; cider; cocktails; curacao; digesters [liqueurs and spirits]; distilled beverages; fruit extracts, alcoholic; gin; hydromel [mead]; kirsch; liqueurs; nira [sugarcane-based alcoholic beverage]; peppermint liqueurs; perry; piquette; pre-mixed alcoholic beverages, other than beer-based;

rice alcohol; rum; sake; spirits [beverages]; vodka; whisky; wine.

34 – Tobacco; smokers' articles; matches; absorbent paper for tobacco pipes; ashtrays for smokers; books of cigarette papers; chewing tobacco; cigar cases; cigar cutters; cigar holders; cigarette cases; cigarette filters; cigarette holders; cigarette paper; cigarette tips; cigarettes; cigarettes containing tobacco substitutes, not for medical purposes; cigarillos; cigars; electronic cigarettes; firestones; gas containers for cigar lighters; herbs for smoking; humidors; lighters for smokers; match boxes; match holders; matches; mouthpieces for cigarette holders; pipe cleaners for tobacco pipes; pipe racks for tobacco pipes; pocket machines for rolling cigarettes; snuff; snuff boxes; spittoons for tobacco users; tips of yellow amber for cigar and cigarette holders; tobacco; tobacco jars; tobacco pipes; tobacco pouches.

35 – Advertising; business management; business administration; office functions; accounting; administrative processing of purchase orders; advertising by mail order; advisory services for business management; arranging newspaper subscriptions for others; arranging subscriptions to telecommunication services for others; auctioneering; bill-posting; business appraisals; business auditing; business efficiency expert services; business information; business inquiries; business investigations; business management and organization consultancy; business management assistance; business management consultancy; business management of hotels; business management of performing artists; business management of sports people; business organization consultancy; business research; commercial administration of the licensing of the goods and services of others; commercial information agencies; commercial information and advice for consumers [consumer advice shop]; commercial or industrial management assistance; compilation of information into computer databases; compilation of statistics; computerized file management; cost price analysis; data search in computer files for others; demonstration of goods; direct mail advertising; dissemination of advertising matter; distribution of samples; document reproduction; drawing up of statements of accounts; economic forecasting; employment agencies; import-export agencies; invoicing; layout services for advertising purposes; marketing; marketing research; marketing studies; modelling for advertising or sales promotion; news clipping services; office machines and equipment rental; on-line advertising on a computer network; opinion polling; organization of exhibitions for commercial or advertising purposes; organization of fashion shows for promotional purposes; organization of trade fairs for commercial or advertising purposes; outsourcing services [business assistance]; payroll preparation; personnel management consultancy; personnel recruitment; photoco-

pying services; presentation of goods on communication media, for retail purposes; price comparison services; procurement services for others [purchasing goods and services for other businesses]; production of advertising films; professional business consultancy; psychological testing for the selection of personnel; public relations; publication of publicity texts; publicity; publicity agencies; publicity columns preparation; publicity material rental; radio advertising; relocation services for businesses; rental of advertising space; rental of advertising time on communication media; rental of photocopying machines; rental of vending machines; retail or wholesale services for pharmaceutical, veterinary and sanitary preparations and medical supplies; sales promotion for others; secretarial services; shop window dressing; shorthand; sponsorship search; systemization of information into computer databases; tax preparation; telemarketing services; telephone answering for unavailable subscribers; television advertising; transcription; typing; updating of advertising material; word processing; writing of publicity texts.

39 – Transport; packaging and storage of goods; travel arrangement; air transport; aircraft rental; ambulance transport; armored-car transport; arranging of cruises; arranging of travel tours; barge transport; boat rental; boat storage; boat transport; booking of seats for travel; bottling services; bus transport; car parking; car rental; car transport; carting; chauffeur services; courier services [messages or merchandise]; delivery of goods; delivery of goods by mail order; distribution of energy; electricity distribution; escorting of travellers; ferry-boat transport; flower delivery; franking of mail; freight brokerage; freight forwarding; freight [shipping of goods]; freighting; garage rental; guarded transport of valuables; hauling; horse rental; ice-breaking; launching of satellites for others; lighterage services; marine transport; message delivery; motor coach rental; newspaper delivery; operating canal locks; packaging of goods; parcel delivery; parking place rental; passenger transport; physical storage of electronically-stored data or documents; piloting; pleasure boat transport; portorage; railway coach rental; railway transport; railway truck rental; refloating of ships; refrigerator rental; removal services; rental of aircraft engines; rental of diving bells; rental of diving suits; rental of freezers; rental of motor racing cars; rental of storage containers; rental of vehicle roof racks; rental of warehouses; rental of wheelchairs; rescue operations [transport]; river transport; salvage of ships; salvaging; shipbrokerage; sightseeing [tourism]; stevedoring; storage; storage information; storage of goods; taxi transport; towing; traffic information; tram transport; transport; transport and storage of trash; transport brokerage; transport by pipeline; transport of travellers; transport reservation; transportation information; transportation logistics; transporting furniture; travel reservation; underwater sal-

vage; unloading cargo; vehicle breakdown assistance [towing]; vehicle rental; water distribution; water supplying; wrapping of goods.

41 – Education; providing of training; entertainment; sporting and cultural activities; academies [education]; amusement parks; amusements; animal training; arranging and conducting of colloquiums; arranging and conducting of concerts; arranging and conducting of conferences; arranging and conducting of congresses; arranging and conducting of seminars; arranging and conducting of symposiums; arranging and conducting of workshops [training]; arranging of beauty contests; boarding schools; booking of seats for shows; bookmobile services; calligraphy services; cinema presentations; circuses; club services [entertainment or education]; coaching [training]; conducting fitness classes; correspondence courses; disc jockey services; discotheque services; dubbing; education information; educational examination; electronic desktop publishing; entertainer services; entertainment information; film production, other than advertising films; gambling; game services provided on-line from a computer network; games equipment rental; gymnastic instruction; health club services [health and fitness training]; holiday camp services [entertainment]; language interpreter services; layout services, other than for advertising purposes; lending libraries; microfilming; modelling for artists; movie studios; music composition services; music-halls; news reporters services; night clubs; nursery schools; operating lotteries; orchestra services; organization of balls; organization of competitions [education or entertainment]; organization of exhibitions for cultural or educational purposes; organization of fashion shows for entertainment purposes; organization of shows [impresario services]; organization of sports competitions; party planning [entertainment]; personal trainer services [fitness training]; photographic reporting; photography; physical education; practical training [demonstration]; presentation of live performances; production of music; production of radio and television programmes; production of shows; providing amusement arcade services; providing casino facilities [gambling]; providing golf facilities; providing karaoke services; providing museum facilities [presentation, exhibitions]; providing on-line electronic publications, not downloadable; providing recreation facilities; providing sports facilities; publication of books; publication of electronic books and journals on-line; publication of texts, other than publicity texts; radio entertainment; recording studio services; recreation information; religious education; rental of audio equipment; rental of camcorders; rental of cine-films; rental of lighting apparatus for theatrical sets or television studios; rental of movie projectors and accessories; rental of radio and television sets; rental of show scenery; rental of skin diving equipment; rental of sound recordings; rental of

sports equipment, except vehicles; rental of sports grounds; rental of stadium facilities; rental of stage scenery; rental of tennis courts; rental of video cassette recorders; rental of videotapes; scriptwriting services; services of schools [education]; sign language interpretation; sport camp services; subtitling; television entertainment; theatre productions; ticket agency services [entertainment]; timing of sports events; toy rental; translation; tuition; videotape editing; videotape film production; videotaping; vocational guidance [education or training advice]; vocational retraining; writing of texts, other than publicity texts; zoological garden services.

43 – Services for providing food and drink; temporary accommodation; accommodation bureaux [hotels, boarding houses]; bar services; boarding for animals; boarding house bookings; boarding houses; cafés; cafeterias; canteens; day-nurseries [crèches]; food and drink catering; holiday camp services [lodging]; hotel reservations; hotels; motels; providing campground facilities; rental of chairs, tables, table linen, glassware; rental of cooking apparatus; rental of drinking water dispensers; rental of lighting apparatus other than for theatrical sets or television studios; rental of meeting rooms; rental of temporary accommodation; rental of tents; rental of transportable buildings; restaurants; retirement homes; self-service restaurants; snack-bars; temporary accommodation reservations; tourist homes.

(260) AM 2015 77007 A
(800) 1199911
(891) 2014 01 28
(731) GEELY HOLDING GROUP CO., LTD.
1760 Jiangling Road, Binjiang District
Hangzhou, Zhejiang, CN
(540)



(591) Black, gray, white, yellow and red
(511)
12 – Automobiles; gear boxes for land vehicles; electric vehicles; motors for land vehicles; anti-theft devices for vehicles; tires for vehicle wheels; bodies for vehicles; motorcycles; sports cars; vehicles for locomotion by land, air, water or rail.
37 – Motor vehicle maintenance and repair; vehicle service stations (refueling and maintenance); strong room maintenance and repair; vehicle cleaning; anti-rust treatment for vehicles; burglar alarm installation and repair; airplane maintenance and repair; retreading of tires; vulcanization of tires; mending rubber tire.

(260) AM 2015 77008 A
(800) 1199912
(891) 2013 12 05
(731) HUNAN SUNNY HYDROPOWER
EQUIPMENT CORPORATION
Shanli Industry Park, Daxing West Road,
Jinshi Town, Xinning County, Hunan, CN
(540)



(591) Black, white
(511)
7 – Hydraulic turbines; hydraulic engines; hydraulic machines; dynamos; alternators; generators of electricity; valves [parts of machines].

(260) AM 2015 77009 A
(800) 1199940
(891) 2013 09 27
(731) UNION GRAND ENERGY PTE LTD
163 Penang Road, #02-03 Winsland House II,
Singapore 238463, SG
(540)



(591) Black, white
(511)
4 – Additives, non-chemical, to motor-fuel; alcohol (fuel); automobile fuels; automotive lubricants for car engines; automotive lubricating compounds; barbecue fuel made from woodchips; barbecue lighting fuel; binding preparations for solid fuels; biodiesel fuel; bitumen emulsions for fuel; blocks of peat (fuel); bone oil for industrial purposes; butane gas for use as a fuel; cable lubricants; charcoal (fuel); charcoal based products for use as a fuel; Christmas tree decorations for illumination (candles); coal based fuels; coal dust (fuel); combustible agglomerated fuels; combustible fuels; deep drawing lubricants; diesel fuel; duct lubricants; emulsions of bitumen for use as fuel; emulsions of oil for use as a fuel; ethanol (fuel); fossil fuels; fuel; fuel briquettes; fuel for lighting purposes; fuel for motor vehicles; fuel for portable fireplaces; fuel for use in barbecues; fuel gas; fuel gas cartridges; fuel in the form of briquettes; fuel in the form of briquettes; fuel mixtures; fuel oil; fuel products of pressed wood chips; fuel with an alcoholic base; fuels; fuels derived from crude oil; fuels derived from oil; fuels for cooking; fuels for heating purposes; fuels for lighters; fuels in

liquid form; fuels with an alcoholic base; gas (fuel); gas fuels; gaseous fuels; gases for use as fuel; gases for use as illuminants; graphited lubricants; greases for the lubrication of cables; greases for the lubrication of exposed gears; greases for the lubrication of joints; household fuel briquettes; hydrocarbon fuels; illuminants; illuminating grease; illuminating materials, namely illuminating grease; illuminating oil; illuminating wax; industrial fuel oil; industrial grease; industrial lubricants; industrial oil; lighter fuel; lighting fuel; liquid fuels; lubricants; lubricants being gear oils; lubricants containing low friction additives; lubricants for agricultural implements; lubricants for cables; lubricants for industrial apparatus; lubricants for machines; lubricants for metal working; lubricants for metallic surfaces; lubricants for motor vehicles; lubricants for plastic materials; lubricants for polymeric surfaces; lubricants for surgical apparatus; lubricants for use in industrial processes; lubricants for use in machine cutting; lubricants for use in the machining of metal; lubricants for use on conveyors; lubricants for use on wire ropes; lubricants for use with power cables; lubricants having cleaning properties; lubricants in the nature of oils; lubricating agents, other than for medical use; lubricating fluids; lubricating graphite; lubricating grease; lubricating oil; lubricating oils for automotive apparatus; lubricating oils for laser printers; lubricating oils for petrol engines; lubricating oils for use as a cutting fluid; lubricating oils for wheels; manufactured solid fuels; metalworking lubricants; methanol (fuel); mineral fuel; motor fuel; motor vehicle lubricants; non-chemical additive concentrates for lubricants; non-chemical additive concentrates for motor fuels; non-chemical additives for fuels; non-chemical additives for lubricants; non-chemical additives to motor fuel; non-chemical anti-freezing additives for fuels; oil based lubricants; oil well drilling lubricants; oils for use in the textile industry; blocks of peat (fuel); peat (fuel); peat briquettes (fuel); peat fuel oils; preparations for enhancing the combustion of fossil fuels; preparations for lubricating joints; propane for use as fuel; rape oil for industrial purposes; rapeseed oil for industrial purposes; smokeless compositions for use as ingredients of fuels; smokeless fuels; solid fuels; solid lubricants for textiles; solid oxygen fuel; solidified gas (fuel); solidified gases (fuel); spray-on lubricants; sunflower oil for industrial purposes; synthetic gas (fuel); synthetic linear alcohols (fuel); synthetic lubricants; synthetic lubricating oils; vaporised fuel mixtures; vaporized fuel mixtures; vegetable oils for lubricating food processing machines; liquefied petroleum gas, petrochemicals, base oils.

(260) AM 2015 77011 A
(800) 1199952
(891) 2013 12 02

(731) Zakrytoe aktsionernoe obshchestvo
"MYASNAYA GALEREYA"
ul. Poliny Osipenko, 41 RU-600009 Vladimir,
RU

(540)

МЕДВЕЖЬЕ УШКО

(591) Black, white

(511)

29 – Meat, fish, poultry and game; meat extracts; preserved, frozen, dried and cooked fruits and vegetables; jellies, jams, compotes; eggs; milk and milk products; edible oils and fats.

30 – Coffee; tea; cocoa; sugar; rice; tapioca and sago; artificial coffee; flour and preparations made from cereals; bread, pastry and confectionery; ices; honey, treacle; yeast, baking-powder; salt; mustard; vinegar; sauces (condiments); spices; ice.

43 – Services for providing food and drink; temporary accommodation; snack-bars; cafés; cafeterias; self-service restaurants.

(260) AM 2015 77012 A

(800) 1199955

(891) 2013 12 18

(731) IIC-INTERSPORT INTERNATIONAL
CORPORATION GMBH
Wölflistrasse 2, CH-3006 Bern, CH

(540)



(591) Black, white

(511)

9 – Protective helmets and vests for sports; helmets for skiing, helmets for hockey; sunglasses, ski goggles, swimming goggles; ski masks, diving masks; life jackets; suits, gloves and earplugs for divers; buoys and snorkels for swimming and diving.

18 – Backpacks, all-purpose sports bags, belt bags, namely belt bags for skiing, backpacks for skiing in both Alpine and Nordic disciplines, rucksacks and backpacks, particularly backpacks made of waterproof textile materials specially designed for skiing; sticks for walking, for sports or other purposes, backpacks for hiking.

25 – Clothing, footwear, headgear, including boots, shoes, gloves, hats; one-piece suits, gloves, shoes and boots for skiing and other snow sports; after-ski boots, ski trousers adaptable to boots, gaiters; boots and gloves for skiing; clothing and footwear for indoor and outdoor racket sports; clothing and footwear for tennis; bathing caps; sports underwear.

28 – Sports articles included in this class; table tennis, badminton and tennis nets; racket-ball, table tennis, badminton, squash and tennis rackets; covers and bags for rackets; strings for rackets; racket handles; balls and shuttlecocks, tables for table tennis; skis, bindings and poles for Alpine skiing and Nordic skiing, ski brakes; custom designed cases for skis; sledges; protective padding (parts of sports suits); hockey sticks and pucks; ice skates; bags for carrying sporting articles; protective covers for table tennis tables; flippers for swimming and diving; protective knee pads and elbow pads for sports; belts, buoyancy devices, vests and belts for swimming.

(260) AM 2015 77014 A
 (800) 1199995
 (891) 2014 02 19
 (731) FUJIFILM Corporation
 26-30, Nishiazabu 2-chome, Minato-ku,
 Tokyo 106-8620, JP

(540)
F U J I C H R O M E

(591) Black, white
 (511)
 1 – Unexposed photographic films; unexposed photographic papers.

(260) AM 2015 77015 A
 (800) 1200023
 (891) 2014 02 10
 (731) TRICOMED, SPÓŁKA AKCYJNA
 Świętojańska 5/9, PL-93-493 Łódź, PL
 (540)

tromboguard

(511)
 5 – Hemostatic dressings.

(260) AM 2015 77016 A
 (800) 1200035
 (891) 2013 11 21
 (731) ACTAVIS GROUP PTC EHF
 Reykjavikurvegi 76-78, IS-220
 Hafnarfjordur, IS

(540)
P I N E D E R E

(511)
 5 – Pharmaceutical preparations and substances.

(260) AM 2015 77017 A
 (800) 1200067
 (891) 2013 10 22
 (731) ZENTIVA GROUP, A.S.
 U Kabelovny 130, CZ-102 37 Praha
 10 – Dolní Měcholupy, CZ

(540)

EVERIO

(511)
 5 – Pharmaceuticals, pharmaceutical preparations for human use.

(260) AM 2015 77018 A
 (800) 1200068
 (891) 2013 10 22
 (731) ZENTIVA GROUP, A.S.
 U Kabelovny 130, CZ-102 37 Praha
 10 – Dolní Měcholupy, CZ

(540)

DIVIDIS

(511)
 5 – Pharmaceuticals, pharmaceutical preparations for human use.

(260) AM 2015 77019 A
 (800) 1200069
 (891) 2013 10 22
 (731) ZENTIVA GROUP, A.S.
 U Kabelovny 130, CZ-102 37 Praha
 10 – Dolní Měcholupy, CZ

(540)

HAERTIN

(511)
 5 – Pharmaceuticals, pharmaceutical preparations for human use.

(260) AM 2015 77020 A
 (800) 1200070
 (891) 2013 10 31
 (731) ZENTIVA GROUP, A.S.
 U Kabelovny 130, CZ-102 37 Praha
 10 – Dolní Měcholupy, CZ

(540)

ZENMEM

(511)
 5 – Pharmaceuticals, pharmaceutical preparations for human use.

(260) AM 2015 77022 A
 (800) 1200071
 (891) 2013 10 22
 (731) ZENTIVA GROUP, A.S.
 U Kabelovny 130, CZ-102 37 Praha
 10 – Dolní Měcholupy, CZ

(540)

HAERTON

(511)
 5 – Pharmaceuticals, pharmaceutical preparations for human use.

(260) AM 2015 77026 A
 (800) 1200097
 (891) 2013 11 28
 (731) SANLIUYIDU (FUJIAN) SPORTS GOODS CO., LTD.
 Jiangtuo Industrial Zone, Chendai Town,
 Jinjiang City, 362211 Fujian, CN
 (540)

361°

(591) Black, white
 (511)
 18 – Animal skins; clothing for pets; travelling bags; pocket wallets; umbrellas; walking sticks; fur; school bags; gut for making sausages; bags for sports.

25 – Waterproof clothing; clothing; trousers; neckties; hats; leather belts (clothing); gloves [clothing]; children's clothing; hosiery; theatrical costumes; shoes; layettes [clothing]; swimsuits; shower caps; sports jerseys; sports shoes; football shoes; sweat bands.

28 – Apparatus for games; toys; board games; balls for games; body-building apparatus; archery implements; machines for physical exercises; sweat absorbing bands for rackets' grips; fishing tackle; roller skates; swimming pools [play articles]; ornaments for Christmas trees [except illumination articles and confectionery].

(260) AM 2015 77027 A
 (800) 1200104
 (891) 2013 11 27
 (731) ETI GIDA SANAYI VE TICARET ANONIM SIRKETI
 Organize Sanayi Bolgesi 11 Cadde,
 ESKISEHIR, TR
 (540)



(591) Black, red, dark brown, light brown, white, pink, purple, green, blue, orange and yellow
 (511)
 30 – Biscuits, chocolates, pastries, crackers, wafers, cakes, products of patisserie and bakery, chocolate bars, tarts, pies, breakfast cereals, bread, popcorn and rice crisps.

(260) AM 2015 77035 A
 (800) 1200161
 (891) 2013 10 14
 (731) ABDINOV AYAZ
 Rm 502, No:7 Tao Jin Dong Heng Lu, Yuexiu District, Guangzhou City, Guangdong Province, CN
 (540)

AGEA

(591) Black, white
 (511)
 18 – Purses; traveling bags; briefcases; backpacks; imitation leather; animal pelts; pocket wallets; traveling trunks; school bags.

(260) AM 2015 77036 A
 (800) 1200196
 (891) 2014 01 22
 (731) EGIS GYÓGYSZERGYÁR ZRT.
 Keresztúri út 30-38, H-1106 Budapest; HU
 (540)

ANPECTIS

(511)
 5 – Human pharmaceutical preparations for the treatment of cardiovascular diseases.

(260) AM 2015 77037 A
 (800) 1200202
 (891) 2014 02 06
 (731) CHARIOT MOTORS AD
 10 Tsar Osvoboditel Blvd., floor 3, BG-1000 Sofia, BG
 (540)



(591) Grey, white
 (511)
 12 – Electric vehicles; electric motors for land vehicles; electric drives for vehicles; parts and fittings for the aforesaid goods, all included in this class.

16 – Printed matter; handbooks [manuals]; catalogues; pamphlets; posters; calendars; graphic representations; greeting cards; printed publications; periodicals; newspapers; magazines [periodicals]; newsletters; stationery; writing pads [stationery]; envelopes [stationery]; pens; pencils; stands for pens and pencils; stickers [stationery]; all of the mentioned goods being used for promotion of electric vehicles.

37 – Repair and installation services related to electric vehicles.

(260) AM 2015 77038 A
 (800) 1200203
 (891) 2014 02 06
 (731) CHARIOT MOTORS AD
 10 Tsar Osvoboditel Blvd., floor 3, BG-1000
 Sofia, BG

(540)
Chariot e

(591) Black, white
 (511)
 12 – Electric vehicles; electric motors for land vehicles; electric drives for vehicles; parts and fittings for the aforesaid goods, all included in this class.

16 – Printed matter; handbooks [manuals]; catalogues; pamphlets; posters; calendars; graphic representations; greeting cards; printed publications; periodicals; newspapers; magazines [periodicals]; newsletters; stationery; writing pads [stationery]; envelopes [stationery]; pens; pencils; stands for pens and pencils; stickers [stationery]; all of the mentioned goods being used for promotion of electric vehicles.

37 – Repair and installation services related to electric vehicles.

(260) AM 2015 77039 A
 (800) 1200204
 (891) 2014 02 06
 (731) CHARIOT MOTORS AD
 10 Tsar Osvoboditel Blvd., floor 3, BG-1000
 Sofia, BG

(540)
CHARIOT MOTORS

(526) The trademark is protected as a whole. The word "MOTORS" included therein shall not be subject to independent legal protection.

(511)
 12 – Electric vehicles; electric motors for land vehicles; electric drives for vehicles; parts and fittings for the aforesaid goods, all included in this class.

16 – Printed matter; handbooks [manuals]; catalogues; pamphlets; posters; calendars; graphic representations; greeting cards; printed publications; periodicals; newspapers; magazines [periodicals]; newsletters; stationery; writing pads [stationery]; envelopes [stationery]; pens; pencils; stands for pens and pencils; stickers [stationery]; all of the mentioned goods being used for promotion of electric vehicles.

37 – Repair and installation services related to electric vehicles.

(260) AM 2015 77040 A
 (800) 1200218
 (891) 2014 02 25
 (731) Obshchestvo s ogranichennoy
 otvetstvennostyu "PARAFARM"
 ul. Sverdlova, d. 4, RU-440026 g. Penza, RU

(540)



(591) Green-yellow, white, green, yellow, light green and bright yellow

(526) The trademark is protected as a whole. The word "Одуванчик" included therein shall not be subject to independent legal protection.

(511)
 5 – Dietary supplements.

(260) AM 2015 77041 A
 (800) 1200233
 (891) 2014 02 10
 (731) Obshchestvo s ogranichennoy
 otvetstvennost'yu "Koordinirovushchy
 raspredelitel'ny tsentr "EFKO-Kaskad"
 ul. Frunze 4, RU-309850 Belgorodskaya obl.,
 g. Alekseevka, RU

(540)



(591) Black, white
 (511)

29 – Meat, fish, poultry and game; meat extracts; preserved, dried and cooked vegetables, fruits, nuts and mushrooms; jellies, jams, compotes; eggs; milk and milk products; edible oils, including vegetable oil and sunflower seed oil; butter; edible fats.

30 – Coffee, tea, cocoa and artificial coffee; rice; tapioca and sago; flour and preparations made from cereals; bread, pastry and confectionery; ices; sugar, honey, treacle; yeast, baking-powder; salt; mustard; vinegar, sauces, including condiments, including mayonnaise and ketchup; spices; ice.

35 – Advertising; business management; business administration; office functions; sales promotion for others, including wholesaling and retailing of food-stuffs.

43 – Services for providing food and drink; temporary accommodation.

(260) AM 2015 77042 A
 (800) 1200243
 (891) 2014 03 20
 (731) BROOKSBURNETT INVESTMENTS LTD
 SOFIAS TSIROU, 9 TOULLA, COURT 3,
 2ND FL. FLAT OFFICE 226 CY-3021
 LIMASSOL, CY

(540)

MISS GLAMOUR

(511)
25 – Stockings; socks; knitted lingerie.

(260) AM 2015 77043 A
(800) 1200265
(891) 2014 01 14
(731) JAPAN TOBACCO INC.
2-2-1 Toranomon, Minato-ku, Tokyo, JP
(540)



(591) Black, white
(511)
34 – Tobacco, raw or manufactured; smoking tobacco, pipe tobacco, rolling tobacco, chewing tobacco, moist tobacco powder called "snus"; cigarettes, cigars, cigarillos; smoking substances sold separately or blended with tobacco for non-medical and non-therapeutic purposes; snuff; smokers' articles included in class 34; cigarette paper, cigarette tubes and matches.

(260) AM 2015 77044 A
(800) 1200274
(891) 2014 01 29
(731) NISSAN JIDOSHA KABUSHIKI KAISHA
(also trading as NISSAN MOTOR Co., LTD.)
No:2 Takaracho, Kanagawa-ku, Yokohama-shi,
Kanagawa-ken 220-8623, JP
(540)



(591) Black, white
(511)
12 – Non-electric prime movers for land vehicles (not including parts therefor); shafts, axles or spindles [for land vehicles]; bearings [for land vehicles]; shaft couplings or connectors [for land vehicles]; power transmissions and gearing [for land vehicles]; shock absorbers [for land vehicles]; springs [for land vehicles]; brakes [for land vehicles]; ac motors or DC motors for land vehicles (not including parts therefor); automobiles and their parts and fittings; electric automobiles and their parts and fittings; fuel cell automobiles and their parts and fittings.

(260) AM 2015 77045 A
(800) 1200324
(891) 2013 12 03
(731) DONGYING FANGXING RUBBER CO.,
LTD.
Dawang Economic Development Zone,
Dongying City, 257000 Shandong Province,
CN

(540)

AMIR

(591) Black, white
(511)
12 – Vehicle wheel tires; tires for vehicle wheels; tires, solid, for vehicle wheels; automobile tires; inner tubes for pneumatic tires; tires for bicycles and cycles; casings for pneumatic tires; inner tubes for bicycles and cycles; tubeless tires for bicycles and cycles; airplane tires.

(260) AM 2015 77046 A
(800) 1200346
(891) 2013 10 16
(731) Obshchestvo s ogranichennoy
otvetstvennostyu "TRIVES"
ul. Chaykovskogo, d.65, pom. 7n., RU-191123
Saint-Petersburg, RU

(540)

ТРИБЕС

(591) Black, white
(511)
10 – Orthopedic articles including prenatal bandages, including prenatal support panties; postnatal bandages, including postnatal support panties; post-surgical bandages; bandages for pelvic prolapses; bandages for visceroptosis; postsurgical bandages for chest, including male and female bandages; ventral hernia bandages; inguinal bandages, including spring inguinal bandages; umbilical bandages, including children umbilical bandages; suspensory bandages; anti-radiculitis bandages; anti-radiculitis calefacient bandages; anti-radiculitis thermotaxic bandages; orthopedic corsets; orthopedic thoracolumbar corsets; orthopedic hyperextension corsets; orthopedic retractors; immobilizing bandages for supporting hands after traumas; immobilizing bandages for shoulder joints; compression bandages for elbow joints; compression bandages for wrist joints; immobilizing bandages for hip joints; immobilizing bandages for knee joints; immobilizing bandages for ankle joints; medical and preventive universal compression bandages; removable joint immobilizers; plaster bandages for orthopedic purposes [casts]; orthopedic bandages for joints; orthopedic belts, including supportive bandages; immobilizing bandages for cervical spine; orthopedic mattresses and mattresses for preventing pressure sores, including mattresses with compressors; orthopedic pillows and pillows for preventing pressure sores, including pillows with compressors; air pillows; soporific pillows for insomnia; heating cushions [pads], electric; orthopedic automatic systems; orthopedic balls; massage apparatus and devices, including vibromassage apparatus, rollers, masseurs; arterial blood pressure measuring apparatus (tonometers) and its parts; stethoscopes; phonendoscopes; medical manometers; compression

cuffs; thermometers; medical compressive hosiery, including tights, stockings, knee-socks, medicinal surgical socks, anti-varicose socks; orthopedic articles for preventive treatment and rehabilitation of disabled persons, including rollators, rollator walkers, canes, crutches, wheelchairs, commode chairs; armchairs for medical purposes; devices for cleansing; special medical devices for rehabilitation of disabled persons; invalid's hoists; immobilizing orthopedic devices; orthopedic footwear; medical footwear; orthopedic soles; arch supports for footwear; orthopedic soles, including half insoles; relieving and correcting orthopedic devices; devices for correction of foot deficiency.

25 – Clothing and underwear for adults and children, including thermal underwear; stockings, tights, knee-socks, socks for adults and children; footwear for adults and children, including footwear of special purpose.

35 – Sales promotion for others; wholesale and retail sale of goods, also via the Internet.

(260) AM 2015 77047 A

(800) 1200355

(891) 2013 10 29

(731) Aktsionernoe obshchestvo "EURASIAN FOODS CORPORATION"

ul. Baizakova, d. 69, 050026 g. Almaty, KZ

(540)



(591) Blue, white and gold

(511)

29 – Meat, fish, poultry and game; meat extracts; preserved, dried and cooked fruits and vegetables including tomato puree, canned beans, canned peas, canned mushrooms, gherkins; piccalilli; jellies, jams, compotes; eggs, milk, condensed milk, milk products; edible oils and fats, including vegetable oils, blend of vegetable oils, oils for deep-fry, butter, margarines, spreads, edible creams and pastes based on vegetable fats and suet for food, edible creams and pastes based on vegetable oils; fat-containing mixtures for bread slices; sunflower seeds prepared, prepared nuts; potato chips; cutlets.

30 – Coffee, tea, cocoa, sugar, rice, tapioca (manioc); sago; artificial coffee; flour and preparations made from cereals, groats for human food (including buckwheat), bread, pastry and confectionery, ices; honey, treacle; yeast, baking-powder; salt, mustard, vinegar, sauces (condiments), including horseradish sauce, prepared mustard, sauces including soya sau-

ces, tomato sauces, pepper sauces, vegetable sauces, sauces based on vegetable puree, fruit sauces, fruit coulis (sauces), fat and milk based sauces, mayonnaise sauce, vegetable oils based sauces, dressings for salad; mayonnaise, ketchup; spices, edible ice; popcorn; semi-finished products included in this class, particularly ravioli, manty (dumplings), vareniki (dumplings); marinade based on tomato puree.

43 – Services for providing food and drink including snack-bars, cafes, cafeterias, restaurants, self-service restaurants, canteens, bar services; food and drink catering; temporary accommodation.

(260) AM 2015 77048 A

(800) 1200409

(891) 2014 01 13

(731) SANA Hotels and Resorts Limited

93, Mill Street, Qormi QRM 3102, MT

(540)

SANA

(511)

36 – Holding company services (financing and financial shareholdings); financial affairs relating to franchising (real estate rental, financing, financial appraisals), except services of all kinds relating to the medical sector.

39 – Transport brokerage; tourist agencies, except services of all kinds relating to the medical sector.

(260) AM 2015 77049 A

(800) 1200444

(891) 2014 01 24

(731) Otkrytoe aktsionernoe obshchestvo

"RUSSKIY PRODUCT"

Moskovskaja ul, 77, Malojaroslaveckij rajon,

RU-249080 s. Detchino, Kaluzhskaja oblast',

RU

(540)



(591) Red, yellow, blue, pale blue, white, purple, black, brown, green

(526) The trademark is protected as a whole. The words "РУССКИЙ ПРОДУКТ", "ГЕРКУЛЕС", "ТРАДИЦИОННЫЙ", "ОВСЯНЫЕ ХЛОПЬЯ" and "НОВЫЙ ДИЗАЙН" included therein shall not be subject to independent legal protection.

(511)
30 – Pancakes; gruel, with a milk base, for food; oat-meal; crushed barley; groats for human food; barley meal; muesli; crushed oats; husked oats; cereal preparations; oat-based food; chips [cereal products]; oat flakes; chicory [coffee substitute]; husked barley.

(260) AM 2015 77050 A
(800) 1200449
(891) 2014 02 04
(731) BAYER INTELLECTUAL PROPERTY GMBH
Alfred-Nobel-Straße 10B 40789 Monheim am Rhein, DE

(540)



(591) Yellow, blue and red
(511)
5 – Pharmaceutical preparations.

(260) AM 2015 77051 A
(800) 732200
(891) 2014 02 13
(731) MESSE MÜNCHEN GMBH
Am Messesee 2B 81829 München, DE

(540)

drinktec

(511)
16 – Printed matter.
35 – Organisation of exhibitions and fairs for business and advertising purposes.
41 – Arranging of exhibitions and fairs for cultural and teaching purposes; organisation and arranging of congresses and meetings; publication and issuing of printed matter.

(260) AM 2015 77052 A
(800) 820320
(891) 2014 01 27
(731) COLTÈNE/WHALEDENT GMBH + CO. KG
Raiffeisenstrasse 30B 89129 Langenau, DE

(540)

COMPRECORD

(511)
5 – Retraction cords for dental purposes (included in this class); aids for taking impressions for dental purposes (included in this class).

(260) AM 2015 77054 A
(800) 826327
(891) 2014 01 27
(731) COLTÈNE/WHALEDENT GMBH + CO. KG
Raiffeisenstrasse 30, 89129 Langenau, DE

(540)

COMPRECAP

(511)
5 – Compression caps for dental purposes (as far as included in this class); aids for taking impressions for dental purposes (as far as included in this class).

(260) AM 2015 77055 A
(800) 875058
(891) 2014 02 06
(731) NAF NAF
6/10, Boulevard Foch, F-93800 EPINAY-SUR-SEINE, FR

(540)

NAF NAF

(511)
25 – Clothing, footwear, headgear.

(260) AM 2015 77056 A
(800) 964566
(891) 2014 02 04
(731) HOUSEDIET, S.L.
Pasaje Pedro Rodríguez, 4-6, E-08028 Barcelona, ES

(540)



(591) Green
(511)
35 – Retailing services in stores and/or via global communications networks, of all types of foodstuffs, perfumery, cosmetics, beauty products, sanitary products, books, magazines and printed publications.

(260) AM 2015 77057 A
(800) 1103098A
(891) 2014 02 12
(731) COPPOLA INDUSTRIA ALIMENTARE SRL
Via Macello, 3/9 I-84085 Mercato San Severino (Salerno), IT

(540)



(591) Red and white
(511)
29 – Preserved, dried, cooked, frozen and deep-frozen fruits, vegetables and pulses; preserved toma-

toes; pickles and preserves in oil; compotes; fruit purees; preserved, dried, cooked and stewed fruits; edible oils, olive oils, edible fats.

30 – Rice, tapioca; flour and preparations made from cereals, bread, pastry and confectionery; pizzas; pasta (plain or flavoured and/or filled); prepared meals totally or partially composed of pasta; mustard; vinegar, sauces (condiments); pasta sauces, cooking sauces; spices.

(260) AM 2015 77059 A

(800) 1183446

(891) 2014 02 18

(731) HODARA S.R.L.

Via Morone, 8, I-20121 Milano (MI), IT

(540)

HODARA

(511)

20 – Furniture, mirrors, picture frames; goods [not included in other classes] of wood, cork, reed, cane, wicker, horn, bone, ivory, whalebone, shell, amber, mother-of-pearl, meerschaum and substitutes for all these materials, or of plastics; bed fittings, not of metal; furniture fittings, not of metal; door fittings, not of metal; cupboards; medicine cabinets; coatstands; chests, not of metal; trolleys [furniture]; lockers; chests of drawers; mobiles [decoration]; containers, not of metal [storage, transport]; picture frames; cushions; divans; edgings of plastic for furniture; mirror tiles; door handles, not of metal; works of art, of wood, wax, plaster or plastic; wickerwork; keyboards for hanging keys; furniture partitions of wood; screens [furniture]; table tops; armchairs; towel closets [furniture]; hat stands; book rests [furniture]; umbrella stands; magazine racks; bottle racks; doors for furniture; furniture shelves; shelves for storage; racks [furniture]; filing cabinets; ladders of wood or plastics; boxes of wood or plastic; writing desks; desks; easy chairs; chairs [seats]; seats of metal; stools; sofas; stakes for plants or trees; mirrors [looking glasses]; draughtman's tables; dressing tables; tables of metal; washstands [furniture]; carts for computers [furniture]; showcases [furniture].

21 – Household or kitchen utensils and containers; combs and sponges; brushes [except paint brushes]; brush-making materials; articles for cleaning purposes; steelwool; unworked or semi-worked glass [except glass used in building]; glassware, porcelain and earthenware not included in other classes; towel rails and rings; bottle openers; drinking glasses; tankards; bottles; mugs; candelabra [candlesticks]; decanters; corkscrews; epergnes; bread baskets, domestic; baskets for domestic use; waste paper baskets; fruit cups; cheese-dish covers; tea cosies; covers, not of paper, for flower pots; plate glass [raw material]; crystal [glassware]; toilet paper dispensers; soap dispensers; salad bowls; majolica; toilet

cases; works of art of porcelain, ceramic, earthenware or glass; oil cruets; porcelain ware; knife rests for the table; menu card holders; shaving brush stands; soap holders; sponge holders; toothpick holders; napkin holders; powder compacts; toilet paper holders; egg cups; ceramics for household purposes; drinking vessels; lunch boxes; bread bins; containers for household or kitchen use; kitchen containers; salt cellars; piggy banks; boxes of glass; boxes for dispensing paper towels; cookie jars; tea caddies; soap boxes; coolers [ice pails]; coffee services [tableware]; liqueur sets; tea services [tableware]; spice sets; services [dishes]; trivets [table utensils]; statues of porcelain, ceramic, earthenware or glass; holders for flowers and plants [flower arranging]; kitchen utensils; utensils for household purposes; toilet utensils; tableware, other than knives, forks and spoons; pottery; pots; vases; cabarets [trays]; glass [receptacles]; sugar bowls; soup bowls.

42 – Scientific and technological services and research and design relating thereto; industrial analysis and research services; design and development of computer hardware and software: consultancy in the field of design; design of models concerning furniture, mirrors, picture frames; goods (not included in other classes) of wood, cork, reed, wicker, horn, bone, ivory, whalebone, shell, amber, mother-of-pearl, meerschaum and substitutes for all these materials, or of plastics; bed fittings not of metal; furniture fittings, not of metal; door fittings, not of metal; cupboards; medicine cabinets; coatstands; chests, not of metal; trolleys (furniture); lockers; chests of drawers; mobiles (decoration); containers, not of metal (storage, transport); picture frames; cushions; divans; edgings of plastic for furniture; mirror tiles; door handles, not of metal; works of art, of wood, wax, plaster or plastic; wickerwork; keyboards for hanging keys; furniture partition of wood; screens (furniture); tables tops; armchairs; towel closets (furniture); hat stands; book rests (furniture); umbrella stands; magazine racks; bottle racks; doors for furniture; furniture shelves; shelves for storage; racks (furniture); filing cabinets; ladders of wood or plastics; boxes of wood or plastic; writing desks; desks; easy chairs; chairs (seats); seats of metal; stools; sofas; stakes for plants or trees; mirrors (looking cups); cheese-dish covers; tea cosies; covers, not of papers, for flower pots; plate glass (raw material); crystal (glassware); toilet paper dispenser; soap dispensers; salad bowls; majolica; toilet cases; works of art of porcelain, ceramic, earthenware or glass; oil cruets; porcelain ware; knife rests for the table; menu card holders; shaving brush stands; soap holders; sponge holders; toothpick holders; napkin holders; powder compacts, toilet paper holders; egg cups; ceramics for household purposes; drinking vessels; lunch boxes; bread bins; containers for household or kitchen use; kitchen containers; salt cellars; piggy banks; boxes of glass; boxes for dispensing paper to-

wels; cookie jars; tea caddies; soap boxes; coolers (ice pails); coffee services (tableware); liqueur sets; tea services (tableware); spice sets; services (dishes); trivets (table utensils); statues of porcelain, ceramic, earthenware or glass; holders for flowers and plants (flower arranging); knives, forks and spoons; pottery; pots; vases; cabarets (trays); glass (receptacles); sugar bowls; soup bowls; furniture design concerning furniture included in class 20; graphic design; design of household or kitchen utensils, instruments and containers included in class 21; design services; interior design; design and interior decoration.

(260) AM 2015 77061 A
 (800) 1083463
 (891) 2014 03 24
 (731) F.LLI CAMPAGNOLO S.P.A.
 Via Merlo, 2, ROMANO D'EZZELINO
 (Vicenza), IT
 (540)



(591) Black, white
 (511)
 25 – Trousers; leggings [trousers]; leg warmers; skirts; jackets [clothing]; heavy jackets; jerkins; shirts; sport shirts; clothing for gymnastics; dress shirts; polo shirts; undershirts; vests; waistcoats; track suits; dungarees; blouses; jeans; panties; underpants; sweat pants; heelpieces for stockings; boxer shorts; G-strings; bermuda shorts; shorts; T-shirts; sweatshirts; tank tops; cardigans; jerseys [clothing]; sweaters; twin sets; shawls; suits; dresses; one-piece dresses; evening dresses; cloaks; windcheaters; overcoats; anoraks; coats; raincoats; waterproof clothing; belts [clothing]; suspenders; babies' pants [clothing]; bibs, not of paper; layettes [clothing]; underwear; brassieres; corsets; bodies [clothing]; petticoats; nightgowns; pyjamas; dressing gowns; bath robes; bikinis; bathing suits; bathing drawers; bathing caps; gloves [clothing]; neckties; bow-ties; neckerchiefs; neck warmers; foulards [clothing articles]; sarongs; beach pareos; sashes for wear; wristbands [clothing]; headbands [clothing]; ear muffs [clothing]; muffs [clothing]; scarves; socks; stockings; tights; hats; berets; caps [headwear]; visors [headwear]; cap peaks; bandanas [neckerchiefs]; garters; overalls; ski wear; hosiery; ski suits; ski pants; ski gloves; ski boots; after ski boots; golf shirts; golf shoes; snowboard suits; snowboard pants; snowboard gloves; spats; snowboard boots; shoes; sports shoes; gymnastic shoes; beach shoes; overshoes; boots; slippers; bath slippers; sandals; bath sandals; sneakers; cycling shoes; cyclists' clothing; bicycling gloves; sweat-absorbent underclothing [underwear]; sports wear; booties; knickers; sports singlets; pullovers; fleece pullovers; fleece shorts; fleece vests; trekking jackets; trekking trou-

sers; dance costumes; masquerade costumes; heels; heelpieces for footwear; inner soles; tips for footwear; soles for footwear; footwear uppers; ascots; shower caps; swimming caps; pocket squares; pockets for clothing; detachable collars; dancing clothing; fittings of metal for footwear; non-slipping devices for footwear; girdles; sleep masks; wedding clothes.

(260) AM 2015 77082 A
 (800) 1200719
 (891) 2013 10 30
 (731) Swissôtel Management GmbH
 Balz-Zimmermannstrasse 7, CH-8302 Kloten,
 CH
 (540)

swissôtel

(511)
 35 – Advertising and marketing services; business management and consultancy services; business administration; administrative services; commercial business management and administration for hotels, offices and business centers; commercial business advice relating to franchising; strategic business planning; market research and analysis services; distribution of advertising materials; brand strategy; brand positioning services; organization of trade fairs and exhibitions for business and commercial purposes; administrative management of customer loyalty programs; public relation services; retail services; compilation of mailing lists and direct mail advertising; sales promotion; procurement and ordering services for others; information and consultancy relating to the above mentioned services.

41 – Arranging and conducting of conventions for business and commercial purposes.

(260) AM 2015 77102 A
 (800) 1200896
 (891) 2014 01 27
 (731) ARISTON THERMO S.p.A.
 Viale Aristide Merloni, 45, I-60044
 FABRIANO (AN), IT
 (540)

ANDRIS

(511)
 11 – Heating boilers, water heaters, boilers, central heating boilers.

(260) AM 2015 77103 A
 (800) 1200898
 (891) 2014 01 30
 (731) LOUSTRON SERVICES LIMITED
 Geneva Places, Waterfront Drive, P.O. Box
 3469, Road Town, TORTOLA, VG

(540)

Desheli

(511)

3 – Bleaching preparations and other substances for laundry use; cleaning, polishing, scouring and abrasive preparations; soaps; perfumery, essential oils, cosmetics, hair lotions; dentifrices.

35 – Import-export agencies; commercial information agencies; cost price analysis; rental of advertising space; business auditing; employment agencies; computerized file management; book-keeping; business efficiency expert services ; demonstration of goods; transcription; opinion polling; marketing studies; on-line advertising on a computer network; business information; compilation of statistical information; business investigations; personnel recruitment; business management and organization consultancy; personnel management consultancy; professional business consultancy; business management of performing artists; news clipping services; updating of advertising material; word processing; organization of exhibitions for commercial or advertising purposes; arranging newspaper subscriptions for others; organization of trade fairs for commercial or advertising purposes; shop window dressing; business appraisals; payroll preparation; data search in computer files for others; business management assistance; commercial or industrial management assistance; economic forecasting; auctioneering; sales promotion for others; office machines and equipment rental; rental of advertising time on communication media; publicity material rental; publication of publicity texts; typing; radio advertising; billposting; distribution of samples; dissemination of advertising matter; advertising; advertising by mail order; television advertising; advertising agencies; document reproduction; compilation of information into computer databases; business inquiries; systemization of information into computer databases; procurement services for others [purchasing goods and services for other businesses]; tax preparation; drawing up of statements of accounts; copywriting; shorthand; psychological testing for the selection of personnel; public relations.

(260) AM 2015 77104 A

(800) 1200906

(891) 2014 01 23

(731) FM LOGISTIC CORPORATE

Rue de l'Europe – Zone Industrielle, F-57370
PHALSBOURG, FR

(540)

FM Fresh

(511)

39 – Transport, packaging and storage of goods.

(260) AM 2015 77107 A

(800) 1200969

(891) 2013 11 01

(731) WORLD MEDICINE İLAÇ SANAYİ VE
TİCARET LİMİTED ŞİRKETİ

Evren Mah. Camiyolu Cad. No:50 K.1B,
Zemin -4-5-6, GÜNEŞLİ/BAĞCILAR/İS-
TANBUL, TR

(540)

VENTACORT

(591) Black, white

(511)

5 – Medicines for human purposes, medicines for veterinary purposes, vitamin preparations, chemical preparations for medical purposes, dietetic substances adapted for medical use; dietetic foods adapted for medical purposes; baby foods, medicinal herbs, herbal beverages adapted for medical purposes, nutritional supplements, pollen dietary supplements, mineral food supplements, protein dietary supplements; medicines for dental purposes, hygienic products for medical purposes including sanitary pads, breast-nursing pads and bunion pads, wadings for medical purposes, plasters for medical purposes, dressings for medical purposes, babies' nappkins, preparations for destroying noxious plants, preparations for destroying noxious animals, fungicides, deodorants other than for human beings or for animals, air deodorising preparations, disinfectants for hygiene purposes, antiseptics, detergents for medical purposes.

(260) AM 2015 77138 A

(800) 1201287

(891) 2014 03 13

(731) ASTELLAS PHARMA EUROPE B.V.

Sylviusweg 62, NL-2333 BE Leiden, NL

(540) LOCID LIPOCREAM

(511)

5 – Medicines and pharmaceutical preparations for human use.

(260) AM 2015 77139 A

(800) 1201298

(891) 2014 03 17

(731) Nemiroff Intellectual Property Establishment
Städtle 31, FL-9490 Vaduz, LI

(540)



(591) Auburn, yellow, white and brown

(511)
33 – Alcoholic beverages (except beers).
35 – Advertising; business management; business administration; office functions; importation and exportation of alcoholic beverages; retail and wholesale services with alcoholic beverages.

(260) AM 2015 77140 A
(800) 1201311
(891) 2014 03 28
(731) HANGZHOU BEST CHEMICAL FIBRE CO., LTD.
Chun'an Village, Lushan Street, Fuyang, Zhejiang, CN

(540)



(591) Black, white

(511)
22 – Raw fibrous textile; raw cotton; cotton tow; silk floss; silk flock; textile fibres; textile fibers; textile fibers; carbon fibers [fibres] for textile use; plastic fibers [fibres] for textile use; linters.

(260) AM 2015 77141 A
(800) 334390
(891) 2014 03 10
(731) SOCIÉTÉ DES PRODUITS NESTLÉ S.A.
CH-1800 Vevey, CH

(540)

CHOKELLA

(511)
29 – Chocolate-flavored yogurt.
30 – Cream products and spreads based on chocolate; cocoa, chocolate; products made with chocolate, namely: candy and sweetmeats, confectionery and pastry, dessert puddings, sauces, powders and essences for making edible ices.
32 – Non-alcoholic beverages, extracts and essences for making non-alcoholic beverages.

(260) AM 2015 77142 A
(800) 397151
(891) 2014 04 11
(731) AMSTEL BROUWERIJ B.V.
Tweede Weteringplantsoen 21, NL-1017 ZD Amsterdam, NL

(540)

AMSTEL

(511)
32 – Beer and other beverages not included in other classes.

(260) AM 2015 77143 A
(800) 416168
(891) 2014 04 11
(731) HEINEKEN BROUWERIJEN B.V.
Tweede Weteringplantsoen 21, NL-1017 ZD Amsterdam, NL

(540)

HEINEKEN

(511)
3 – Bleaching preparations and other substances for laundry use; cleaning, polishing, scouring and abrasive preparations; soaps; perfumery, essential oils, cosmetics, hair lotions; dentifrices.

4 – Industrial oils and greases (other than edible oils and fats and essential oils); lubricants; dust-binding compositions; fuel compositions (including gasoils for engines) and lighting fuel; tallow candles, candles, nightlights and wicks.

8 – Hand tools and instruments; cutlery, forks and spoons; side arms, other than firearms.

9 – Scientific, nautical, surveying, electric not included in other classes, (including wireless), photographic, cinematographic, optical, weighing, measuring, signaling, monitoring (inspection), rescue (life-saving) and teaching apparatus and instruments; coin or token-operated automatic apparatus; talking machines; cash registers, calculating machines; fire extinguishers.

11 – Lighting, heating, steam generating, cooking, refrigerating, drying, ventilating, water supply and sanitary installations.

14 – Precious metals and their alloys and goods in precious metals or coated therewith (excluding cutlery, forks and spoons); jewelry, precious stones; clocks and watches and other chronometric instruments.

15 – Musical instruments (excluding talking machines and wireless apparatus).

16 – Paper, cardboard, paper or cardboard goods (not included in other classes); printed matter, newspapers and periodicals, books; bookbinding material; photographs; adhesive materials (for stationery purposes); artists' materials; paintbrushes; typewriters and office requisites (except furniture); instructional or teaching material (excluding apparatus); playing cards; printing types; printing blocks.

18 – Leather and imitation leather, articles made thereof, not included in other classes; skins, hides and pelts; trunks and suitcases; umbrellas, parasols and walking sticks; whips, harnesses and saddlery.

20 – Furniture, mirrors, picture frames; goods (not included in other classes) of wood, cork, reed, cane, wicker, horn, bone, ivory, whalebone, shell, amber, mother-of-pearl, meerschaum, celluloid and substitutes of all these materials or of plastic materials.

21 – Small portable household and kitchen utensils and containers (neither of precious metals, nor coated therewith); combs and sponges; brushes (except paintbrushes); brush-making materials; cleaning implements and equipment; steel wool; unworked or semi-worked glass (except building glass), glassware, porcelain and earthenware not included in other classes.

22 – Rope, string, nets, tents, awnings, sails, bags; padding and stuffing materials (animal hair, kapok, feathers, seaweed, etc.); raw fibrous textile materials.

24 – Textile fabrics; bed and table covers; textile articles not included in other classes.

25 – Clothing, including boots, shoes and slippers.

28 – Games, toys; gymnastic and sporting articles (except clothing); Christmas tree ornaments and decorations.

31 – Agricultural, horticultural and forestry products and grains, not included in other classes; live animals; fresh fruit and vegetables; seeds, living plants and natural flowers; animal feed, malt.

32 – Beer, ale and porter's ale; mineral and sparkling water and other non-alcoholic beverages; syrups and other preparations for making beverages.

33 – Wines, spirits and liqueurs.

34 – Raw or manufactured tobacco; smokers' articles; matches.

(260) AM 2015 77144 A

(800) 632838

(891) 2014 02 17

(731) HEINEKEN ENTREPRISE

2, rue des Martinets, F-92500 Rueil-Malmaison, FR

(540)

DESPERADOS

(511)

32 – Beers; mineral and aerated waters and other non-alcoholic drinks (excluding those based on coffee, tea, cocoa, chocolate or milk beverages); fruit beverages and fruit juices; syrups and other preparations for making beverages.

33 – Alcoholic beverages (except beers).

(260) AM 2015 77145 A

(800) 693922

(891) 2014 03 14

(731) ABBOTT PRODUCTS OPERATIONS AG

Hegenheimermattweg 127, CH-4123

Allschwil, CH

(540)

PHYSIOTENS

(511)

5 – Medicines, namely cardiovascular and antihypertonic preparations.

(260) AM 2015 77146 A

(800) 808664

(891) 2014 02 20

(731) Obchtchestvo s ogranichennoi

otvetstvennostyou "ALEKSANDROVY

POGREBA"

str. 25, Altufievskoe chosse 79a, RU-127410

Moscou, RU

(540)

АРПИИ

(591) Black, white

(511)

33 – Alcoholic beverages (except beers); distilled alcoholic beverages; alcoholic beverages containing fruit; anisette; anise (liqueur); aperitifs; arrack; eaux-de-vie; wine; whisky; kirsch; gin (eau-de-vie); hydromel; pears; bitters (liqueurs); alcoholic cocktails; liqueurs; peppermint liqueurs; spirits; digestives (alcohol and liqueurs); piquette; sake; rum; alcoholic essences; alcoholic extracts; cider; alcoholic fruit extracts.

(260) AM 2015 77147 A

(800) 832122

(891) 2014 02 18

(731) BAYER AKTIENGESELLSCHAFT

Kaiser-Wilhelm-Allee, 51373 Leverkusen, DE

(540)

XOFIGO

(511)

5 – Pharmaceutical preparations and substances; diagnostic preparations and reagents for medical use.

(260) AM 2015 77148 A

(800) 890222

(891) 2014 03 28

(731) APPLE INC.

1 Infinite Loop, Cupertino, CA 95014, US

(540)

GENIUS BAR

(526) The trademark is protected as a whole. The word "BAR" included therein shall not be subject to independent legal protection.

(511)

35 – Retail store services featuring computers, computer software, computer peripherals and consumer

electronic devices, and demonstration of products relating thereto.

37 – Maintenance, installation and repair of computer hardware, computer peripherals and consumer electronic devices; support services, namely, troubleshooting of computer peripheral and consumer electronic devices.

42 – Support services, namely, troubleshooting of computer hardware and software; maintenance, installation and repair of computer software.

(260) AM 2015 77149 A
 (800) 1088825
 (891) 2014 03 12
 (731) H.B. Health and Beauty Limited
 19, Halechi Street, 51200 Bnei Brak, IL
 (540)



(591) Black, white
 (511)
 3 – Colognes, perfumes and cosmetics; body and beauty care cosmetics; creams, lotions, milks, masks and gels for the face, body and hands; bath soaps in liquid, solid or gel form; ointments (cosmetic) not for medical use; bath and shower salts not for medical purposes; lotions for cosmetic purposes; after-shave; massage oils, body oils, self-tanning preparations (cosmetics), cosmetic preparations for protecting the skin from the sun's rays; hair care preparations, non-medicated hair treatment preparations for cosmetic purposes, hair shampoos and conditioners, hair masks, hair gels; deodorant for personal use; shaving creams; room fragrances.

(260) AM 2015 77150 A
 (800) 1124476
 (891) 2014 02 25
 (731) ITO EN, LTD.
 47-10, Honmachi 3-chome, Shibuya-ku,
 Tokyo 151-8550, JP
 (540)



(591) Black, white

(511)
 30 – Tea; green tea; Chinese tea; jasmine tea; brown rice tea; roasted tea; tea-based beverage; green tea based beverage; Chinese tea based beverage; jasmine tea based beverage; tea-flavored candies; tea-flavored sweets; tea-flavored bread; tea-flavored ice; tea-flavored aromatic preparations for food; tea-flavored bean paste; tea-flavored soy sauce; tea-flavored vinegar; tea-flavored mustard; tea-flavored honey; tea-flavored sugar; tea-flavored salt; tea-flavored rice; tea-flavored flour; tea-flavored tapioca.

32 – Tea-flavored carbonated drinks; tea-flavored vegetable juices; tea-based whey beverages.

(260) AM 2015 77151 A
 (800) 1174749
 (891) 2014 01 06
 (731) CHEN LONG
 Tavas utca 1/C/A/5/54, H-1108 Budapest, HU
 (540)



(591) Black, white
 (511)
 25 – Jeans wear.

(260) AM 2015 77159 A
 (800) 1181825
 (891) 2014 04 01
 (731) ELLIOTT AUTO SUPPLY CO., INC.
 Suite 200, 1380 Corporate Center Curve,
 Eagan MN 55121, US
 (540)

FVP

(511)
 1 – Chemical treatments and additives for motor oils, gasoline and diesel fuels, transmission fluids and cooling systems fluids; tire inflator sealants; fuel injection cleaner chemical additives; brake fluid; power steering fluid; fuel injection cleaner chemical additives; automotive care chemicals, namely, chemical additives for use in gas treatment and octane treatment; chemical treatments and additives to stop leaks in radiators; chemical treatments and additives to stop leaks in transmissions; chemical sealers and conditioners for transmissions, chemical sealers for radiators; starting fluid; transmission fluid; automotive tire inflator sealers.

3 – Cleaners for engines, motors, carburetors, fuel injectors, and brakes; cleaning solvents for automotive parts; engine cleaners and degreasers.

4 – Automotive lubricants; motor oil; engine oils; non-chemical additives for oils and fuels.

9 – Batteries.

(260) AM 2015 77170 A

(800) 1201175

(891) 2013 09 26

(731) TOP CONNECT OU

Vaike-Paala 1, EE-11415 Tallinn 11415, EE

(540)



(591) Red, white

(511)

35 – Direct marketing; marketing; product marketing; promotional marketing; arranging subscriptions to telecommunication services (for others); advertising; advertising services provided over the Internet; business advice and consultancy relating to franchising services (group purchasing, group advertising); online advertising on a computer network; organisation of exhibitions for commercial or advertising purposes; organisation of trade fairs for commercial or advertising purposes; promotion of fairs for trade purposes; promotional marketing.

(260) AM 2015 77172 A

(800) 1189895

(891) 2013 12 17

(731) BROOKSBURNETT INVESTMENTS LTD
SOFIAS TSIROU, 9 TOULLA, COURT 3,
2ND FL., FLAT OFFICE 22, CY-3021
LIMASSOL, CY

(540)



(591) Black, white

(511)

25 – Underwear, hosiery, socks, stockings and tights.

(260) AM 2015 77177 A

(800) 1201509

(891) 2014 01 24

(731) Limited Liability Company "INTERNET
COMPANY MAIL.RU"

Leningradsky pr-kt, d. 39, str. 79, RU-125167
Moscow, RU

(540)



(591) Black, white

(511)

9 – Video cassettes; video game cartridges; compact discs [audio-video]; compact discs [read-only memory]; magnetic data media; optical data media; computer software, recorded; computer programmes [programs], recorded; computer game software; computer programs [downloadable software]; computer operating programs, recorded; downloadable image files; downloadable music files; animated cartoons; USB flash drives.

16 – Almanacs; atlases; posters; pamphlets; booklets; newsletters; newspapers; engravings; magazines [periodicals]; periodicals; printed publications; graphic representations; calendars; geographical maps; catalogues; books; comic books; lithographs; graphic prints; greeting cards; postcards; printed matter; prospectuses; manuals [handbooks]; photographs [printed].

28 – Arcade video game machines; video game machines; gaming machines for gambling; amusement machines, automatic and coin-operated; jigsaw puzzles; toys; mobiles [toys]; parlor games; board games; games; building games; playing cards; scale model kits [toys]; portable games with liquid crystal displays; apparatus for games.

35 – Rental of advertising space; computerized file management; demonstration of goods; opinion polling; marketing studies; business investigations; marketing research; news clipping services; updating of advertising material; organization of exhibitions for commercial or advertising purposes; organization of trade fairs for commercial or advertising purposes; shop window dressing; data search in computer files for others; commercial or industrial management assistance; presentation of goods on communication media, for retail purposes; auctioneering; sales promotion for others; production of advertising films; rental of advertising time on communication media; publicity material rental; publication of publicity texts; radio advertising; bill-posting; dissemination of advertising matter; direct mail advertising; advertising; on-line advertising on a computer network; advertising by mail order; television advertising; compilation of information into computer databases; systemization of information into computer databases; publicity columns preparation; administrative processing of purchase orders; public relations.

38 – News agencies; television broadcasting; cable television broadcasting; electronic bulletin board services [telecommunications services]; information about telecommunication; providing user access to

global computer networks; providing access to databases; providing internet chatrooms; providing telecommunications connections to a global computer network; providing telecommunication channels for teleshopping services; transmission of greeting cards online; message sending; computer aided transmission of messages and images; transmission of digital files; electronic mail; providing online forums; rental of access time to global computer networks; radio broadcasting; communications by fiber [fibre] optic networks; cellular telephone communication; communications by computer terminals; communications by telephone; paging services [radio, telephone or other means of electronic communication]; teleconferencing services; voice mail services; telephone services.

41 – Booking of seats for shows; videotaping; gambling; publication of books; education information; recreation information; entertainment information; health club services [health and fitness training]; night clubs; layout services, other than for advertising purposes; videotape editing; game services provided on-line from a computer network; providing on-line electronic publications, not downloadable; practical training [demonstration]; organization of exhibitions for cultural or educational purposes; providing recreation facilities; arranging and conducting of colloquiums; arranging and conducting of conferences; arranging and conducting of workshops [training]; arranging and conducting of seminars; organization of competitions [education or entertainment]; operating lotteries; television entertainment; videotape film production; rental of videotapes; rental of sound recordings; publication of electronic books and journals online; publication of texts, other than publicity texts; radio entertainment; entertainer services; entertainment; writing of texts, other than publicity texts; news reporters services; party planning [entertainment]; providing casino facilities [gambling]; club services [entertainment or education]; teaching; recording studio services; photography; production of shows.

42 – Computer system analysis; recovery of computer data; computer virus protection services; installation of computer software; information technology [IT] consultancy; consultancy in the design and development of computer hardware; computer software consultancy; updating of computer software; maintenance of computer software; providing search engines for the internet; data conversion of computer programs and data [not physical conversion]; computer system design; computer rental; rental of computer software; hosting computer sites [web sites]; server hosting; duplication of computer programs; computer software design; creating and maintaining web sites for others; computer programming.

45 – Missing person investigations; personal background investigations; dating services.

(260) AM 2015 77179 A
(800) 1201511
(891) 2013 12 26
(731) WORLD MEDICINE İLAÇLARI LİMİTED ŞİRKETİ
Evren Mah. Camiyolu Cad. No:50 K:2,
Güneşli Bağcılar İstanbul, TR

(540)

Rotafen

(591) Black, white

(511)

5 – Medicines for human purposes, medicines for veterinary purposes, vitamin preparations, chemical preparations for medical purposes, dietetic substances adapted for medical use; dietetic foods adapted for medical purposes; baby foods, medicinal herbs, herbal beverages adapted for medical purposes, nutritional supplements, pollen dietary supplements, mineral food supplements, protein dietary supplements; dietary supplements for animals; fodder supplements for veterinary purposes; medicines for dental purposes, hygienic products for medical purposes including sanitary pads, breast-nursing pads and bunion pads, waddings for medical purposes, plasters for medical purposes, dressings for medical purposes, babies' napkins, preparations for destroying noxious plants, preparations for destroying noxious animals, fungicides, deodorants other than for human beings or for animals, air deodorising preparations, disinfectants for hygiene purposes, antiseptics, detergents for medical purposes.

(260) AM 2015 77180 A
(800) 1201521
(891) 2014 04 02
(731) SHENZHEN SUNTAK CIRCUIT TECHNOLOGY CO., LTD.
3/F, Block 3 Xinyu Rd, Henggang Industry Dist, Xinqiao, Shajing Street, Bao'an, Shenzhen, Guangdong, CN

(540)

SUNTAK

(591) Black, white

(511)

9 – Electronic chips; integrated circuits; chips [integrated circuits]; printed circuits.

(260) AM 2015 77181 A
(800) 1201549
(891) 2013 10 17
(731) INDUSTRIA DE DISEÑO TEXTIL, S.A. (INDITEX, S.A.)
Avenida de la Diputación, Edificio Inditex, E-15142 ARTEIXO (A CORUÑA), ES

(540)

LFT

(511)

3 – Bleaching preparations and other substances for laundry use; cleaning, polishing, degreasing and abrasive preparations; soaps; perfumery products, essential oils, cosmetics, hair lotions; dentifrices; shoe polish, cream and wax; tailors' wax; shoemakers' wax; wax for leather; depilatory wax; laundry wax; parquet floor wax; shampoos; cosmetic kits; depilatory products; make-up removing preparations; deodorants for personal use (perfumery); lipstick; cosmetic pencils; hair spray and nail polish; nail polish removing agents; tissues impregnated with cosmetic lotions; cloths impregnated with a detergent for cleaning; after-shave lotions; lotions for cosmetic use; make-up products; pomades for cosmetic use; stain removers; sachets for perfuming linen; nail care products; bleaches for cosmetic use; flower extracts (perfumery); incense; scented wood; decorative patterns for cosmetic use; false eyelashes and nails; pumice stone; fragrant potpourris; cosmetic preparations for slimming; cosmetic preparations for baths; hair waving preparations; laundry preparations; non-medicated toiletries; articles for oral hygiene, not for medical purposes; bath salts, not for medical use; oils for toiletry purposes; sunscreen preparations; eau de cologne; deodorant soaps; talcum powder for toiletry purposes; adhesives for cosmetic use; greases for cosmetic use; abrasive cardboard for finger nail use; abrasive paper; abrasive glass paper; abrasive granules; shaving products; brightening chemicals for household use (washing of linen); cotton sticks for cosmetic use; beauty masks; mustache wax; bleaching products for laundry use; leather bleaching products; dental bleaching gels; products for whitening (bleach); hair colorants; eyebrow cosmetics; cleaning chalk; shampoos for pets; cosmetics for animals; cosmetic creams; disinfectant soaps; bars of soap; soap for preventing foot perspiration; detergents other than for use in manufacturing operations and for medical purposes; laundry starch; cleansing milk for toilet purposes; Javelle water; dry-cleaning products; scented water; perfumes; cosmetic preparations for eyelashes; cosmetic products for skin care; make-up powder; adhesives for affixing hairpieces; fabric softeners for laundry use; cosmetic dyes; dye-removing agents; toilet water.

9 – Scientific, nautical, surveying, photographic, cinematographic, optical, weighing, measuring, signaling, checking (supervision), life-saving and teaching apparatus and instruments; apparatus and instruments for conducting, switching, transforming, accumulating, regulating or controlling electricity; apparatus for recording, transmission or reproduction of sound or images; magnetic recording media, sound recording disks; compact disks, DVDs and other digital recording media; software; mechanisms for coin-operated apparatus; cash registers, calculating machines, data processing equipment and com-

puters; extinguishers; computer peripherals; anti-glare glasses; pince-nez; optical lenses; chains for pince-nez; contact lenses; cords for pince-nez; rules [measuring instruments]; spectacles (optics); spectacle lenses; spectacle cases; eyeglass [pince-nez] frames; spectacle frames; sunglasses; eyeglass cases; containers for contact lenses; shoes for protection against accidents, irradiation and fire; bullet-proof vests; life jackets; garments for protection against fire; clothing for protection against fire; gloves for divers; gloves for divers; gloves for protection against accidents; diving suits; encoded magnetic cards; magnetic identity cards; clothing for protection against accidents, irradiation and fire; protective suits for aviators; electronic agendas; telephone apparatus; weighbridges; directional compasses; accounting machines; protective helmets; protective helmets for sports; telescopes; chronographs [time recording apparatus]; measuring spoons; pedometers; pedometers; compact disks (audio-video); optical compact disks; mirrors (optics); binoculars (optics); temperature indicators; chains for spectacles; eyeglass cords; computer game programs; cassette players; bar-code readers; signal lanterns; magnifying glasses (optics); dictating machines; mechanisms for counter-operated apparatus; bathroom scales; belts with weights (for underwater use); electric batteries; galvanic batteries; solar batteries; recorded computer programs; electronic pocket translators; transistors (electronics); thermometers not for medical use; intercommunication apparatus; video cassettes; animated cartoons; portable radio-telephones (walkie-talkies); electronic publications (electronically downloadable); egg timers [sandglasses]; acoustic sound alarms; anti-theft warning apparatus; fire alarms; computer mouse pads; loudspeakers; sound amplifiers; antennas; anti-glare visors; telephone apparatus; headsets (for music); answering machines; counterfeit (false) coin detectors; teeth protectors; money counting and sorting machines; apparatus for measuring the thickness of skins; electronic tags for goods; goggles for sports; magnets; light-emitting electronic pointers; mobile telephones; enlarging apparatus (photography); apparatus and instruments for astronomy; thermionic valves; coin-operated musical automata [juke boxes]; scales; life-saving rafts; magnetic tape recorders; head cleaning tapes; video tapes; magnetic tapes; demagnetizing apparatus for magnetic tapes; barometers; ticket dispensers; thermostats; cinematographic cameras; video cameras; video game cartridges; magnetic encoders; measuring glassware; revolution counters; transparencies; slide projection apparatus; dynamometers; reflecting disks for wear, for the prevention of traffic accidents; hemline markers; dosage dispensers; covers for electric outlets; radiotelephony sets; scanners [data processing equipment]; flash-bulbs (photography); photocopying apparatus and machines (also including electrostatic and thermal apparatus and

machines); holograms; compact disk players; luminous signs; neon signs; solid state video recorders; electric measuring apparatus; megaphones; memories for use with computers; microphones; microprocessors; modems; buoyancy bladders (breathing apparatus for divers); objectives (lenses) (optics); ozonizers; projection screens; electric switches; dog whistles; push buttons for bells; radios; receivers (audio, video); wrist rests for use with computers; balances (steelyards); television apparatus; record players; data processing software for processing text; video telephones; carrying cases for portable computers; cases for mobile phones; portable music players.

14 – Precious metals and their alloys and goods in precious metals or coated therewith not included in other classes; jewelry articles, jewelry, precious stones; timepieces and chronometric instruments; ornamental pins; tie pins; works of art of precious metal; key rings [trinkets or fobs]; medals; coins; badges of precious metal; footwear ornaments of precious metal; hat ornaments of precious metal; cuff links; watch chains; watch cases; wire of precious metal [jewelry]; jewelry cases; ornaments [jewelry]; jewelry of yellow amber; pins [jewelry], amulets [jewelry]; rings (jewelry); ornaments of jet; bracelets (jewelry); brooches (jewelry); chains [jewelry]; boxes of precious metal; necklaces [jewelry]; tie clasps; watch glasses; chronographs (watches); alarm clocks; diamonds; charms [jewelry]; costume jewelry; cases for watches [presentation]; ivory [jewelry articles]; medallions [jewelry]; earrings; pearls (jewelry); watch straps; watches; tiaras (diadems).

16 – Paper, cardboard and goods made from these materials not included in other classes; printed matter; bookbinding material; photographs; stationery; adhesives (glues) for stationery or household use; artists' materials; paintbrushes; typewriters and office requisites (except furniture); instructional material or teaching material (except apparatus); plastic materials for packaging (not included in other classes); printing type; printing blocks; works of art (engravings); boxes of cardboard or paper; patterns for dressmaking; tissues of paper for removing make-up; stencil cases; labels not of textile; table linen of paper; table napkins of paper; handkerchiefs (of paper); pen cases; covers for checkbooks; writing cases [sets]; inking sheets for document reproducing machines; bags (envelopes, pouches) for packaging (of paper or plastic); tailor's chalk; face towels of paper; hatboxes; tracing cloth and paper; bookbinding cloth; canvas for painting; towels of paper; albums; almanacs; hand labelling apparatus; loose-leaf binders; writing instruments; transfers (decals); calendars; posters; document files; catalogs; trading cards; drawing sets; newspapers; lithographs; wrapping paper; toilet paper; paperweights; mats for beer glasses; bookmarkers; book ends; ink; inkwells; bibs

of paper; drawing materials; graphic prints; school supplies [stationery]; writing slates; comic books; trays for placing and counting coins; embroidery designs; garbage bags of paper or of plastics; geographical maps; Earth globes; moisteners [office requisites]; plastics for modeling; plans; stencils (stationery); paper or cardboard placards; cards; steel letters and nibs; aquarelles; adhesive tape dispensers (stationery); adhesive tapes and bands for stationery or household purposes; stickers (stationery goods); cigar bands (vitolas); files (office requisites); modeling clay; arithmetical tables; drawer liners of paper, perfumed or not; architects' models; atlases; flags of paper; tickets; pads (paper and writing materials); ball-point pens; bags for microwave cooking; writing board erasers; rubber erasers; erasing products; bottle packaging and sleeves of cardboard or paper; painters' easels; song books; charcoal pencils; letter paper; advertisement boards of paper or cardboard; booklets; ink sticks; modeling wax not for dental use; sealing wax; thumbtacks; paper tapes and ribbons; inking ribbons for computer printers; inking ribbons for typewriters; clip boards (office requisites); stationery sets (office requisites); compasses for drawing; paper clasps; paper knives (cutters) (office requisites); writing or drawing books; paintings (pictures), framed or unframed; finger-stalls (office requisites); bookbinding material; gummed cloth for stationery purposes; ink pads; square rulers; shields (paper seals); cards for special occasions; filter paper; book covers (stationery); photograph stands; rubber bands for office use; staplers (stationery); staples for offices; paper clips [stationery]; loose leaf paper (stationery); pencil sharpeners; pencil holders; luminous paper; palettes for painters; silver paper; waxed paper; modeling paste; office hole punchers; painters' brushes; house painters rollers; postcards; rosaries; blotters; envelopes (stationery); stickers.

24 – Textiles and textile goods not included in other classes; bed and table linen; bath linen (except clothing); textile napkins for removing make-up; labels of cloth; linings [textile]; wall hangings of textile; handkerchiefs of textile; curtains of textile or plastic materials; household linen; towels of textile; traveling rugs (lap robes); net curtains; curtain holders of textile; banners and flags (not of paper); duvets (down coverlets); covers [loose] for furniture; covers for cushions; mattress covers; pillowcases; mosquito nets; glass cloths [towels]; billiard cloth; tablecloths, not of paper; traced cloths for embroidery; face towels of textile; sheets sewn in the shape of sleeping bags; cotton fabrics; long-pile fabric (sackcloth), sackcloth; brocades; lining fabric for footwear; fabric for footwear; bed covers; bed blankets; trellis (hemp cloth); zephyr (cloth); cheviots (textiles); covers for mattresses, mattress covers (other than for incontinence); shower curtains of textile or plastic; crepe fabric; crepon; coverlets [bedsp-

reads]; damask; elastic woven material; oil cloths (tablecloth); gummed cloth other than for stationery; esparto fabric; chenille fabric; felt; flannel (fabric); fitted toilet lid covers (fabric); gauze (cloth); jersey; woolen cloth, woolen fabric; lingerie fabric; linen fabrics (not for insulation); place mats, not of paper; non-paper tablecloths; printer's blankets of textile; marabout (cloth); upholstery fabrics; fabrics for furniture in sections; fabric of imitation animal skins; knitted fabric; cheese cloth; ramie fabric; rayon fabric; silk [cloth]; taffeta (cloth); fiberglass fabrics, for textile use; adhesive fabric for application by heat; fabric with printed motifs for embroidery; velvet; tulle; table runners.

26 – Lace and embroidery, ribbons and braid; buttons, hooks and eyes, pins and needles; artificial flowers; boxes for needles; pin and needle cushions; ornaments for footwear and hats (not of precious metal); haberdashery (except thread); hair bands; armbands; reins for guiding children; brooches (clothing accessories); sewing boxes; belt clasps; shoe laces; wreaths of artificial flowers; ornamental novelty badges; thimbles (for sewing); needle cases; buckles (clothing accessories); buckles (for footwear); shoulder pads for clothing; hair pins; badges for wear not of precious metal; tinsels (trimmings for clothing); numerals or letters for marking linen; bodkins; barrettes (hair slides); lace trimmings; feathers (clothing accessories); top-knots (pompoms); picot (lace); zip fasteners; competitors' numbers; heat adhesive patches for decoration of textile articles (haberdashery); rug hooks; snap fasteners; ostrich feathers (clothing accessories); whalebones for corsets; prize ribbons; rimming cords for clothing; tassels (haberdashery); expanding bands for holding sleeves; hair ornaments; false hair; hair nets; shoe eyelets; chenille (passementerie); frills (lacework); pant clips for cyclists; fastenings for clothing; hook-and-pile fastening tapes; elastic ribbons; tapes for curtain headings; cords for clothing; collar supports; false hems; rosettes (passementerie); festoons (embroidery); fringes; artificial fruit; braids; hair coloring caps; artificial garlands; darning eggs; trimmings for clothing; tresses of hair; wigs; silver embroidery; edgings for clothing; rosettes (haberdashery); brace clips (fasteners); skirt flounces; braids; toupees; shoe hooks.

28 – Games, toys; gymnastic and sporting articles not included in other classes; decorations for Christmas trees; fishing tackle; rods for fishing; toy masks and theatrical masks, dolls' houses; climbers' harness; novelties for parties, dances [party favors, favours]; gloves (accessories for play); baseball, boxing, fencing and golf gloves; puppets; machines for physical exercises; Christmas trees made of synthetic materials; bladders of balls for games; elbow and knee guards (sports articles); kites; rattles; kaleidoscopes; rocking horses; building games; amuse-

ment machines, automatic and coin-operated; playing cards; teddy bears; dolls; dolls' clothes; air pistols [toys]; chess games; flippers for swimming; ring games; Christmas tree stands; archery implements; water wings; practical jokes [novelties]; balls for games; dolls' feeding bottles; building blocks [toys]; body boards; bowling games; stationary exercise bicycles; golf bags, with and without wheels; dolls' beds; marbles for games; butterfly nets; swings; confetti; cups for dice; dice; checkers [games]; checkerboards; darts; discuses (sports items); flying discs [toys]; dominoes; counters [discs] for games; skis; bags especially designed for skis and surfboards; tables for indoor table football [babyfoot]; appliances for gymnastics; horseshoe games; hockey sticks; soap bubbles (toys); board games; toys for domestic pets; scale model vehicles; skateboards; mobiles [toys]; paintballs (ammunition for paintball guns); artificial snow for Christmas trees; golf clubs; billiard cues; billiard tables; skating boots with skates attached; in-line roller skates; ice skates; roller skates; scooters [toys]; stuffed toys; spinning tops [toys]; piñatas; swimming pools [sports or play articles]; punching bags; puzzles; conjuring apparatus; rackets; parlor games; sail and surf boards; chessboards; slingshots [sports articles]; slides [games]; trampolines [sports articles]; sleighs [sports articles]; vehicles [toys]; radio-controlled toy vehicles; shuttlecocks.

(260) AM 2015 77182 A

(800) 1201550

(891) 2013 10 17

(731) INDUSTRIA DE DISEÑO TEXTIL, S.A.
(INDITEX, S.A.)

Avenida de la Diputación, Edificio Inditex,
E-15142 ARTEIXO (A CORUÑA), ES

(540)

LEFTIES

(511)

3 – Bleaching preparations and other substances for laundry use; cleaning, polishing, degreasing and abrasive preparations; soaps; perfumery products, essential oils, cosmetics, hair lotions; dentifrices; shoe polish, cream and wax; tailors' wax; shoemakers' wax; wax for leather; depilatory wax; laundry wax; parquet floor wax; shampoos; cosmetic kits; depilatory products; make-up removing preparations; deodorants for personal use (perfumery); lipstick; cosmetic pencils; hair spray and nail polish; nail polish removing agents; tissues impregnated with cosmetic lotions; cloths impregnated with a detergent for cleaning; after-shave lotions; lotions for cosmetic use; make-up products; pomades for cosmetic use; stain removers; sachets for perfuming linen; nail care products; bleaches for cosmetic use; flower extracts (perfumery); incense; scented wood; decorative patterns for cosmetic use; false eyelashes

and nails; pumice stone; fragrant potpourris; cosmetic preparations for slimming; cosmetic preparations for baths; hair waving preparations; laundry preparations; non-medicated toiletries; articles for oral hygiene, not for medical purposes; bath salts, not for medical use; oils for toiletry purposes; sunscreen preparations; eau de cologne; deodorant soaps; talcum powder for toiletry purposes; adhesives for cosmetic use; greases for cosmetic use; abrasive cardboard for finger nail use; abrasive paper; abrasive glass paper; abrasive granules; shaving products; brightening chemicals for household use (washing of linen); cotton sticks for cosmetic use; beauty masks; mustache wax; bleaching products for laundry use; leather bleaching products; dental bleaching gels; products for whitening (bleach); hair colorants; eyebrow cosmetics; cleaning chalk; shampoos for pets; cosmetics for animals; cosmetic creams; disinfectant soaps; bars of soap; soap for preventing foot perspiration; detergents other than for use in manufacturing operations and for medical purposes; laundry starch; cleansing milk for toilet purposes; Javelle water; dry-cleaning products; scented water; perfumes; cosmetic preparations for eyelashes; cosmetic products for skin care; make-up powder; adhesives for affixing hairpieces; fabric softeners for laundry use; cosmetic dyes; dye-removing agents; toilet water.

9 – Scientific, nautical, surveying, photographic, cinematographic, optical, weighing, measuring, signaling, checking (supervision), life-saving and teaching apparatus and instruments; apparatus and instruments for conducting, switching, transforming, accumulating, regulating or controlling electricity; apparatus for recording, transmission or reproduction of sound or images; magnetic recording media, sound recording disks; compact disks, DVDs and other digital recording media; software; mechanisms for coin-operated apparatus; cash registers, calculating machines, data processing equipment and computers; extinguishers; computer peripherals; anti-glare glasses; pince-nez; optical lenses; chains for pince-nez; contact lenses; cords for pince-nez; rules [measuring instruments]; spectacles (optics); spectacle lenses; spectacle cases; eyeglass [pince-nez] frames; spectacle frames; sunglasses; eyeglass cases; containers for contact lenses; shoes for protection against accidents, irradiation and fire; bullet-proof vests; life jackets; garments for protection against fire; clothing for protection against fire; gloves for divers; gloves for divers; gloves for protection against accidents; diving suits; encoded magnetic cards; magnetic identity cards; clothing for protection against accidents, irradiation and fire; protective suits for aviators; electronic agendas; telephone apparatus; weighbridges; directional compasses; accounting machines; protective helmets; protective helmets for sports; telescopes; chronographs [time recording apparatus]; measuring spoons; pedometers;

pedometers; compact disks (audio-video); optical compact disks; mirrors (optics); binoculars (optics); temperature indicators; chains for spectacles; eyeglass cords; computer game programs; cassette players; bar-code readers; signal lanterns; magnifying glasses (optics); dictating machines; mechanisms for counter-operated apparatus; bathroom scales; belts with weights (for underwater use); electric batteries; galvanic batteries; solar batteries; recorded computer programs; electronic pocket translators; transistors (electronics); thermometers not for medical use; intercommunication apparatus; video cassettes; animated cartoons; portable radio-telephones (walkie-talkies); electronic publications (electronically downloadable); egg timers [sandglasses]; acoustic sound alarms; anti-theft warning apparatus; fire alarms; computer mouse pads; loudspeakers; sound amplifiers; antennas; anti-glare visors; telephone apparatus; headsets (for music); answering machines; counterfeit (false) coin detectors; teeth protectors; money counting and sorting machines; apparatus for measuring the thickness of skins; electronic tags for goods; goggles for sports; magnets; light-emitting electronic pointers; mobile telephones; enlarging apparatus (photography); apparatus and instruments for astronomy; thermionic valves; coin-operated musical automata [juke boxes]; scales; life-saving rafts; magnetic tape recorders; head cleaning tapes; video tapes; magnetic tapes; demagnetizing apparatus for magnetic tapes; barometers; ticket dispensers; thermostats; cinematographic cameras; video cameras; video game cartridges; magnetic encoders; measuring glassware; revolution counters; transparencies; slide projection apparatus; dynamometers; reflecting disks for wear, for the prevention of traffic accidents; hemline markers; dosage dispensers; covers for electric outlets; radiotelephony sets; scanners [data processing equipment]; flash-bulbs (photography); photocopying apparatus and machines (also including electrostatic and thermal apparatus and machines); holograms; compact disk players; luminous signs; neon signs; solid state video recorders; electric measuring apparatus; megaphones; memories for use with computers; microphones; microprocessors; modems; buoyancy bladders (breathing apparatus for divers); objectives (lenses) (optics); ozonizers; projection screens; electric switches; dog whistles; push buttons for bells; radios; receivers (audio, video); wrist rests for use with computers; balances (steelyards); television apparatus; record players; data processing software for processing text; video telephones; carrying cases for portable computers; cases for mobile phones; portable music players.

14 – Precious metals and their alloys and goods in precious metals or coated therewith not included in other classes; jewelry articles, jewelry, precious stones; timepieces and chronometric instruments; ornamental pins; tie pins; works of art of precious metal;

key rings [trinkets or fobs]; medals; coins; badges of precious metal; footwear ornaments of precious metal; hat ornaments of precious metal; cuff links; watch chains; watch cases; wire of precious metal [jewellery, jewelry [Am.]]; jewelry cases; ornaments [jewelry]; jewelry of yellow amber; pins [jewelry], amulets [jewelry]; rings (jewelry); ornaments of jet; bracelets (jewelry); brooches (jewelry); chains [jewelry]; boxes of precious metal; necklaces [jewelry]; tie clasps; watch glasses; chronographs (watches); alarm clocks; diamonds; charms [jewelry]; costume jewelry; cases for watches [presentation]; ivory [jewelry articles]; medallions [jewelry]; earrings; pearls (jewelry); watch straps; watches; tiaras (diadems).

16 – Paper, cardboard and goods made from these materials not included in other classes; printed matter; bookbinding material; photographs; stationery; adhesives (glues) for stationery or household use; artists' materials; paintbrushes; typewriters and office requisites (except furniture); instructional material or teaching material (except apparatus); plastic materials for packaging (not included in other classes); printing type; printing blocks; works of art (engravings); boxes of cardboard or paper; patterns for dressmaking; tissues of paper for removing make-up; stencil cases; labels not of textile; table linen of paper; table napkins of paper; handkerchiefs (of paper); pen cases; covers for checkbooks; writing cases [sets]; inking sheets for document reproducing machines; bags (envelopes, pouches) for packaging (of paper or plastic); tailor's chalk; face towels of paper; hatboxes; tracing cloth and paper; bookbinding cloth; canvas for painting; towels of paper; albums; almanacs; hand labelling apparatus; loose-leaf binders; writing instruments; transfers (decals); calendars; posters; document files; catalogs; trading cards; drawing sets; newspapers; newspapers; magazines (periodicals); books; lithographs; wrapping paper; toilet paper; paperweights; mats for beer glasses; bookmarkers; book ends; ink; inkwells; bibs of paper; drawing materials; graphic prints; school supplies [stationery]; writing slates; comic books; trays for placing and counting coins; embroidery designs; garbage bags of paper or of plastics; geographical maps; Earth globes; moisteners [office requisites]; plastics for modeling; plans; stencils (stationery); paper or cardboard placards; cards; steel letters and nibs; aquarelles; adhesive tape dispensers (stationery); adhesive tapes and bands for stationery or household purposes; stickers (stationery goods); cigar bands (vitolas); files (office requisites); modeling clay; arithmetical tables; drawer liners of paper, perfumed or not; architects' models; atlases; flags of paper; tickets; pads (paper and writing materials); ball-point pens; bags for microwave cooking; writing board erasers; rubber erasers; erasing products; bottle packaging and sleeves of cardboard or paper; painters' easels; song books; charcoal pencils; letter

paper; advertisement boards of paper or cardboard; booklets; ink sticks; modeling wax not for dental use; sealing wax; thumbtacks; paper tapes and ribbons; inking ribbons for computer printers; inking ribbons for typewriters; clip boards (office requisites); stationery sets (office requisites); compasses for drawing; paper clasps; paper knives (cutters) (office requisites); writing or drawing books; paintings, pictures, framed or unframed; finger-stalls (office requisites); bookbinding material; gummed cloth for stationery purposes; ink pads; square rulers; shields (paper seals); cards for special occasions; filter paper; book covers (stationery); photograph stands; rubber bands for office use; staplers (stationery); staples for offices; paper clips [stationery]; loose leaf paper (stationery); pencil sharpeners; pencil holders; luminous paper; palettes for painters; silver paper; waxed paper; modeling paste; office hole punchers; painters' brushes; house painters rollers; postcards; publications; rosaries; blotters; envelopes (stationery); stickers.

24 – Textiles and textile goods not included in other classes; bed and table linen; bath linen (except clothing); textile napkins for removing make-up; labels of cloth; linings [textile]; wall hangings of textile; handkerchiefs of textile; curtains of textile or plastic materials; household linen; towels of textile; traveling rugs (lap robes); net curtains; curtain holders of textile; banners and flags (not of paper); duvets (down coverlets); covers [loose] for furniture; covers for cushions; mattress covers; pillowcases; mosquito nets; glass cloths [towels]; billiard cloth; tablecloths, not of paper; traced cloths for embroidery; face towels of textile; sheets sewn in the shape of sleeping bags; cotton fabrics; long-pile fabric (sackcloth), sackcloth; brocades; lining fabric for footwear; fabric for footwear; bed covers; bed blankets; trellis (hemp cloth); zephyr (cloth); cheviots (textiles); covers for mattresses, mattress covers (other than for incontinence); shower curtains of textile or plastic; crepe fabric; crepon; coverlets [bedspreads]; damask; elastic woven material; oil cloths (tablecloth); gummed cloth other than for stationery; esparto fabric; chenille fabric; felt; flannel (fabric); fitted toilet lid covers (fabric); gauze (cloth); jersey; woolen cloth, woolen fabric; lingerie fabric; linen fabrics (not for insulation); place mats, not of paper; non-paper tablecloths; printer's blankets of textile; Marabout (cloth); upholstery fabrics; fabrics for furniture in sections; fabric of imitation animal skins; knitted fabric; cheese cloth; ramie fabric; rayon fabric; silk [cloth]; taffeta (cloth); fiberglass fabrics, for textile use; adhesive fabric for application by heat; fabric with printed motifs for embroidery; velvet; tulle; table runners.

26 – Lace and embroidery, ribbons and braid; buttons, hooks and eyes, pins and needles; artificial flowers; boxes for needles; pin and needle cushions;

ornaments for footwear and hats (not of precious metal); haberdashery (except thread); hair bands; armbands; reins for guiding children; brooches (clothing accessories); sewing boxes; belt clasps; shoe laces; wreaths of artificial flowers; ornamental novelty badges; thimbles (for sewing); needle cases; buckles (clothing accessories); buckles (for footwear); shoulder pads for clothing; hair pins; badges for wear not of precious metal; tinsels (trimmings for clothing); numerals or letters for marking linen; bodkins; barrettes (hair slides); lace trimmings; feathers (clothing accessories); top-knots (pompoms); picot (lace); zip fasteners; competitors' numbers; heat adhesive patches for decoration of textile articles (haberdashery); rug hooks; snap fasteners; ostrich feathers (clothing accessories); whalebones for corsets; prize ribbons; ridding cords for clothing; tassels (haberdashery); expanding bands for holding sleeves; hair ornaments; false hair; hair nets; shoe eyelets; chenille (passementerie); frills (lace-work); pant clips for cyclists; fastenings for clothing; hook-and-pile fastening tapes; elastic ribbons; tapes for curtain headings; cords for clothing; collar supports; false hems; rosettes (passementerie); festoons (embroidery); fringes; artificial fruit; braids; hair coloring caps; artificial garlands; darning eggs; trimmings for clothing; tresses of hair; wigs; silver embroidery; edgings for clothing; rosettes (haberdashery); brace clips (fasteners); skirt flounces; braids; toupees; shoe hooks.

28 – Games, toys; gymnastic and sporting articles not included in other classes; decorations for Christmas trees; fishing tackle; rods for fishing; toy masks and theatrical masks, dolls' houses; climbers' harness; novelties for parties, dances [party favors, favours]; gloves (accessories for play); baseball, boxing, fencing and golf gloves; puppets; machines for physical exercises; Christmas trees made of synthetic materials; bladders of balls for games; elbow and knee guards (sports articles); kites; rattles; kaleidoscopes; rocking horses; building games; amusement machines, automatic and coin-operated; playing cards; teddy bears; dolls; dolls' clothes; air pistols [toys]; chess games; flippers for swimming; ring games; Christmas tree stands; archery implements; water wings; practical jokes [novelties]; balls for games; dolls' feeding bottles; building blocks [toys]; body boards; bowling games; stationary exercise bicycles; golf bags, with and without wheels; dolls' beds; marbles for games; butterfly nets; swings; confetti; cups for dice; dice; checkers [games]; checkerboards; darts; discs (sports items); flying discs [toys]; dominoes; counters [discs] for games; skis; bags especially designed for skis and surfboards; tables for indoor table football [babyfoot]; appliances for gymnastics; horseshoe games; hockey sticks; soap bubbles (toys); board games; toys for domestic pets; scale model vehicles; skateboards; mobiles [toys]; paintballs (ammunition for paintball guns);

artificial snow for Christmas trees; golf clubs; billiard cues; billiard tables; skating boots with skates attached; in-line roller skates; ice skates; roller skates; scooters [toys]; stuffed toys; spinning tops [toys]; piñatas; swimming pools [sports or play articles]; punching bags; puzzles; conjuring apparatus; rackets; parlor games; sail and surf boards; chessboards; slingshots [sports articles]; slides [games]; trampolines [sports articles]; sleighs [sports articles]; vehicles [toys]; radio-controlled toy vehicles; shutlecocks.

(260) AM 2015 77183 A

(800) 1201568

(891) 2013 12 18

(731) EXAMONE ENTERPRISES LTD

155 Archiepiskopou Makariou III Avenue,
Proteas House, 5 floor, CY-3026 CY-3026
LIMASSOL, CY

(540)



(591) Black, white

(511)

3 – Make-up removing milk; cosmetics for suntanning; skincare cosmetics; body creams [cosmetics]; make-up removing preparations; facial wipes impregnated with cosmetics; make-up remover; make-up for the face; make-up removing preparations; skin make-up; sun-tanning preparations [cosmetics]; cosmetics all for sale in kit form; cosmetics preparations; cosmetics; make-up; make-up preparations; sun blocking lipsticks [cosmetics]; cosmetics for eye-brows; eyebrow cosmetics; moisturisers [cosmetics]; powder compact refills [cosmetics]; cosmetics in the form of milks; cosmetics for use on the skin; cosmetics for use in the treatment of wrinkled skin; cosmetics in the form of lotions; cosmetics in the form of oils; cosmetics in the form of creams; oils for the body [cosmetics]; cosmetics in the form of eye shadow; night creams [cosmetics]; sun protecting creams [cosmetics]; self-tanning preparations [cosmetics]; non-medicated toiletries; toiletries; perfumes; extracts of flowers [perfumes]; balms other than for medical purposes; scented water; massage gels other than for medical purposes; perfumery; perfumes; eyebrow pencils; cosmetic pencils; cosmetics in the form of creams; skin whitening creams; nail polish; lotions for cosmetic purposes; douching preparations for personal sanitary or deodorant purposes [toiletries]; beauty masks; oils for cosmetic purposes; cleansing milk for toilet purposes; soaps; oils for cleaning purposes; cosmetic kits; lipsticks, not for medical purposes; mouth was-

hes, not for medical purposes; sunscreen preparations; aloe vera preparations for cosmetic purposes; cosmetic preparations for baths; make-up powder; tissues impregnated with cosmetic lotions; bath salts, not for medical purposes; fumigation preparations [perfumes]; potpourris [fragrances]; eyebrow cosmetics; hair colorants; sun-tanning preparations [cosmetics]; cosmetic preparations for eyelashes; cosmetic preparations for skin care; mascara; antiperspirants [toiletries]; shampoos; dry shampoos; extracts of flowers [perfumes]; ethereal essences; massage gels other than for medical purposes; perfumery, essential oils, cosmetics, hair lotions; perfumery.

(260) AM 2015 77184 A

(800) 1201592

(891) 2013 11 26

(731) BYBA BABY FOOD FACTORY, S.L.
C/ Baleares, 3, E-46394 RIBA-ROJA DE
TURIA (Valencia), ES

(540)



(591) Green

(511)

5 – Dietetic substances and foodstuffs for medical use; food for babies; pharmaceutical and veterinary products; sanitary products for medical use; plasters, materials for dressings; teeth filling and dental impression materials; disinfectants; products for destroying vermin; fungicides, herbicides.

35 – Sales promotion services for others; advertising; business management; business administration; office functions; commercial or industrial company management or operation assistance services; import-export and commercial representation agencies; market research and analysis services, conducting of studies on business organization, planning, monitoring, management and experts' reports on companies and auditing; retail sale and wholesale and sale services via global computer networks; exclusive sales services; franchising services relating to the operation and/or management of a commercial company for all kinds of foodstuffs and beverages.

39 – Transport services; packaging and storage of goods; distribution (delivery) of all kinds of foodstuffs and beverages.

(260) AM 2015 77185 A

(800) 1201599

(891) 2013 12 25

(731) OLEKSANDR OLEYNYKOV
47 Dniprobudivska St., Dniprodzerzhynsk
51918, UA

(540)

ATOLL

(591) Black, white

(511)

1 – Chemicals used in industry, science and photography, as well as in agriculture, horticulture and forestry; unprocessed artificial resins, unprocessed plastics; manures; fire extinguishing compositions; tempering and soldering preparations; chemical substances for preserving foodstuffs; tanning substances; adhesives used in industry; kaolin; gums (adhesives), other than for stationery or household purposes; water-based dispersion adhesives; adhesives for billposting; cement for mending broken articles; leather glues; adhesives for wall tiles; adhesives for paperhanging; adhesives for industrial purposes; glue for industrial purposes; solvents for varnishes; oil cement; chemical preparations for the manufacture of pigments and paints; additives, chemical, to fungicides; water glass (soluble glass); fillers for automobile bodies.

2 – Paints, varnishes, lacquers; preservatives against rust and against deterioration of wood; colorants; mordants; raw natural resins; metals in foil and powder form for painters, decorators, printers and artists; aluminium paints; bactericidal paints; colorants; wood stains; dyewood; white lead; whites (colorants or paints); fireproof paints; water-based dispersion primers; water-based dispersion paints; primers; undercoating for vehicle chassis; dyewood extracts; oils for the preservation of wood; wood coatings (paints); wood preservatives; wood mordants; titanium dioxide (pigment); printing compositions (ink); printers' pastes; enamels for painting; enamels (varnishes); protective preparations for metals; thickeners for paints; carbonyl (wood preservative); ceramic paints; binding preparations for paints; badi-geon; lacquers; thinners for lacquers; colorants for butter; mastic (natural resin); zinc oxide (pigment); pigments; coatings (paints); glazes (paints, lacquers); anti-fouling paints; anti-rust preparations for preservation; mordants; thinners for paints; white-wash; siccatives (drying agents) for paints; prussian blue; turpentine (thinner for paints); distempers; paints for use in the manufacture of ceramics; fixatives (varnishes); blacks (colorants or paints).

19 – Building materials (non-metallic); non-metallic rigid pipes for building; asphalt, pitch and bitumen; non-metallic transportable buildings; monuments, not of metal; alabaster; reinforcing materials, not of metal, for building; bituminous products for building; lime; refractory construction materials, not of metal; gypsum; clay; raw chalk; silica (quartz); sand, except foundry sand; cement; water-soluble filling cement; water-soluble plasters.

(260) AM 2015 77197 A

(800) 1201637

(891) 2014 03 12

(731) BEIQI FOTON MOTOR CO., LTD.

Laoniuan Village North, Shayang Road,
Shahe Town, Changping District,
102206 Beijing, CN

(540)

BORGWARD

(511)

12 – Motor vehicles by land, air, water or rail; fork lift trucks; lifting vehicles; coaches; cycle cars; cars; automobiles; concrete mixing vehicles; engines for land vehicles; automobile tires.

(260) AM 2015 77198 A

(800) 1201672

(891) 2014 01 20

(731) AZERI TRADE HOLDING GMBH
Renngasse 14/52, A-1010 Wien, AT

(540)

FRESCO MARKET

(511)

16 – Plastic materials for packaging (not included in other classes); paper bags, all the aforesaid goods only for merchandise and transportation of purchased products.

21 – Containers for household or kitchen use; combs and sponges; brushes (except paint brushes); brush-making materials; articles for cleaning purposes; steelwool; glassware, porcelain and earthenware not included in other classes.

24 – Textiles and textile goods, not included in other classes; bed and table covers.

25 – Clothing, footwear, headgear.

28 – Games and playthings; gymnastic and sporting articles not included in other classes; decorations for Christmas trees.

34 – Tobacco; smokers' articles; matches.

35 – Advertising; business management; business administration; office functions.

39 – Storage, transportation and delivery of goods.

(260) AM 2015 77200 A

(800) 1201673

(891) 2014 01 20

(731) AZERI TRADE HOLDING GMBH
Renngasse 14/52 A-1010 Wien; AT

(540)

FRESCO HYPERMARKET

(511)

16 – Plastic materials for packaging (not included in other classes); paper bags, all the aforesaid goods only for merchandise and transportation of purchased products.

21 – Containers for household or kitchen use; combs and sponges; brushes (except paint brushes); brush-making materials; articles for cleaning purposes; steelwool; glassware, porcelain and earthenware not included in other classes.

24 – Textiles and textile goods, not included in other classes; bed and table covers.

25 – Clothing, footwear, headgear.

28 – Games and playthings; gymnastic and sporting articles not included in other classes; decorations for Christmas trees.

34 – Tobacco; smokers' articles; matches.

35 – Advertising; business management; business administration; office functions.

39 – Storage, transportation and delivery of goods.

(260) AM 2015 77201 A

(800) 1201676

(891) 2014 03 26

(731) SERGEANT'S PET CARE PRODUCTS,
INC.

515 Eastern Avenue, Allegan MI 49010, US

(540)

PETARMOR

(511)

5 – Pharmaceutical preparations for use on animals; flea and tick control products.

(260) AM 2015 77203 A

(800) 1201749

(891) 2013 12 30

(731) SOGRAPE VINHOS, S.A.

Lugar de Aldeia Nova, P-4430-771 Avintes,
Vila Nova de Gaia, PT

(540)



(591) Brown, green, pink and black

(554) [X]

(511)

33 – Wines; alcoholic beverages (except beers).

- (260) AM 2015 77204 A
 (800) 1201777
 (891) 2014 01 29
 (731) ŠKODA AUTO a.s.
 Tř. Václava Klementa 869, CZ-293 60 Mladá
 Boleslav, CZ
 (540)

CITIFUN

- (511)
 12 – Automobiles and their parts, all included in this class.

- (260) AM 2015 77215 A
 (800) 1201787
 (891) 2013 07 05
 (731) COOPER & HUNTER International Corp.
 8130 SW Beaverton-Hillsdale, Highway,
 Portland Oregon 97225, US
 (540)



- (591) Black, white
 (511)

11 – Apparatus for lighting, heating, steam generating, cooking, refrigerating, drying, ventilating, water supply and sanitary purposes, including: acetylene burners; acetylene flares; acetylene generators; air conditioners for vehicles; air conditioning apparatus; air conditioning installations; air cooling apparatus; air deodorising apparatus; air driers; air driers [dryers]; air dryers; air filtering installations; air purifying apparatus and machines; air reheaters; air sterilisers; air valves for steam heating installations; alcohol burners; anti-dazzle devices for automobiles [lamp fittings]; anti-dazzle devices for vehicles [lamp fittings]; anti-glare devices for vehicles [lamp fittings]; anti-splash tap nozzles; apparatus for dehydrating food waste; aquarium filtration apparatus; aquarium heaters; aquarium lights; arc lamps; ash conveyor installations, automatic; ash pits for furnaces; atomic piles; autoclaves [electric pressure cookers]; automobile lights; bakers' ovens; barbecues; bath fittings; bath installations; bath linings; bath plumbing fixtures; bath tubs; bath tubs for sitz baths; bath tubs for sitz-baths; bedwarmers; beverage cooling apparatus; bicycle lights; bidets; blankets, electric, not for medical purposes; boiler pipes [tubes] for heating installations; boilers, other than parts of machines; brackets for gas burners; bread baking machines; bread toasters; bread-making machines; burners; burners for lamps; carbon for arc lamps; ceiling lights; central heating radiators; chandeliers; chimney blowers; chimney flues; Chinese lanterns; chromatography apparatus for industrial purposes; clean chambers [sanitary installations]; co-

ffee filters, electric; coffee machines, electric; coffee percolators, electric; coffee roasters; coils [parts of distilling, heating or cooling installations]; cookers; cooking apparatus and installations; cooking rings; cooking utensils, electric; coolers for furnaces; cooling appliances and installations; cooling installations and machines; cooling installations for liquids; cooling installations for tobacco; cooling installations for water; cooling vats for furnaces; curling lamps; cycle lights; dampers [heating]; deep fryers, electric; defrosters for vehicles; dental ovens; deodorising apparatus, not for personal use; desalination plants; desiccating apparatus; discharge tubes, electric, for lighting; disinfectant apparatus; disinfectant dispensers for toilets; disinfectant distributors for toilets; disposable sterilization pouches; distillation apparatus; distillation columns; diving lights; drip irrigation emitters [irrigation fittings]; drying apparatus; drying apparatus and installations; drying apparatus for fodder and forage; electric appliances for making yogurt; electric appliances for making yogurt; electric fans for personal use; electric lamps; electric lights for Christmas trees; electrically heated carpets; evaporators; expansion tanks for central heating installations; extractor hoods for kitchens; fabric steamers; fairy lights for festive decoration; fans [air-conditioning]; fans [parts of air-conditioning installations]; faucets for pipes (Am.); feeding apparatus for heating boilers; filaments for electric lamps; filters [parts of household or industrial installations]; filters for air conditioning; filters for drinking water; fire bars; fireplaces, domestic; fittings shaped, for furnaces; fittings, shaped, for ovens; flare stacks for use in oil refineries; flare stacks for use in the oil industry; flares; flashlights [torches]; flues for heating boilers; flushing apparatus; flushing tanks; footmuffs, electrically heated; footwarmers, electric or non-electric; forage drying apparatus; forges, portable; fountains; framework of metal for ovens; freezers; friction lighters for igniting gas; fruit roasters; fuel economisers; fuel economizers; fumigation apparatus, not for medical purposes; furnace ash boxes; furnace grates; furnaces, other than for laboratory use; gas boilers; gas burners; gas condensers, other than parts of machines; gas lamps; gas lighters; gas scrubbers [parts of gas installations]; gas scrubbing apparatus; germicidal burners; germicidal lamps for purifying air; globes for lamps; glue-heating appliances; griddles [cooking appliances]; grills [cooking appliances]; hair driers; hair driers [dryers]; hair dryers; hand drying apparatus for washrooms; headlights for automobiles; hearths; heat accumulators; heat exchangers, not parts of machines; heat pumps; heat regenerators; heaters for baths; heaters for heating irons; heaters for vehicles; heaters, electric, for feeding bottles; heating apparatus; heating apparatus for defrosting windows of vehicles; heating apparatus for solid, liquid or gaseous fuels; heating apparatus, electric;

heating boilers; heating cushions [pads], electric, not for medical purposes; heating elements; heating filaments, electric; heating installations; heating installations [water]; heating pads [cushions], electric, not for medical purposes; heating plates; hot air apparatus; hot air bath fittings; hot air ovens; hot plates; hot water bottles; hot water heating installations; humidifiers for central heating radiators; hydrants; hydromassage bath apparatus; ice boxes; ice chests; ice machines and apparatus; immersion heaters; incandescent burners; incinerators; installations for conditioning air; installations for processing nuclear fuel and nuclear moderating material; ionization apparatus for the treatment of air or water; kettles, electric; kiln furniture [supports]; kilns; kitchen ranges [ovens]; laboratory burners; laboratory lamps; lamp casings; lamp chimneys; lamp glasses; lamp globes; lamp mantles; lamp reflectors; lamp shades, lamps; lamps for directional signals of automobiles; lampshade holders; lanterns for lighting; laundry dryers, electric; laundry room boilers; lava rocks for use in barbecue grills; level controlling valves in tanks; light bulbs; light bulbs for directional signals for vehicles; light bulbs, electric; light diffusers; light-emitting diodes [led] lighting apparatus; gas lighters; lighting apparatus and installations; lighting apparatus for vehicles; lighting installations for air vehicles; lighting installations for air vehicles; lights for automobiles; lights for vehicles; lights, electric, for Christmas trees; loading apparatus for furnaces; luminous house numbers; luminous tubes for lighting; magnesium filaments for lighting; malt roasters; microwave ovens [cooking apparatus]; microwave ovens for industrial purposes; milk cooling installations; miners' lamps; mixer taps for water pipes; nuclear reactors; oil burners; oil lamps; oil-scrubbing apparatus; ornamental fountains; oven fittings made of fireclay; ovens, other than for laboratory use; oxhydrogen burners; pasteurisers; petrol burners; pipe line cocks [spigots]; pipes [parts of sanitary installations]; plate warmers; pocket searchlights; pocket torches, electric; pocket warmers; polymerisation installations; pressure cookers [autoclaves], electric; pressure cooking saucepans, electric; pressure water tanks; processing installations for fuel and nuclear moderating material; projector lamps; purification installations for sewage; radiator caps; radiators [heating]; radiators, electric; refining towers for distillation; refrigerating apparatus and machines; refrigerating appliances and installations; refrigerating cabinets; refrigerating chambers; refrigerating containers; refrigerating display cabinets [display cases]; refrigerators; regulating accessories for water or gas apparatus and pipes; regulating and safety accessories for gas apparatus; regulating and safety accessories for gas pipes; regulating and safety accessories for water apparatus; roasters; roasting apparatus; roasting jacks; roasting spits; rotisseries; safety accessories for water or gas apparatus

and pipes; safety lamps; sanitary apparatus and installations; sauna bath installations; scrubbers [parts of gas installations]; searchlights; shaped fittings for furnaces; shaped fittings for ovens; shower cubicles [enclosures (Am.)]; showers; sinks; sockets for electric lights; solar furnaces; solar thermal collectors [heating]; spa baths [vessels]; standard lamps; steam accumulators; steam boilers, other than parts of machines; steam facial apparatus [saunas]; steam generating installations; sterilizers; stills; stoves; stoves [heating apparatus]; street lamps; structural plates for ovens; swimming pool chlorinating apparatus; tanning apparatus [sun beds]; taps [cocks, spigots] [faucets (Am.)] for pipes; taps [faucets]; thermostatic valves [parts of heating installations]; toasters; tobacco roasters; toilet bowls; toilet seats; toilets [water-closets]; toilets, portable; torches for lighting; turkish bath cabinets, portable; ultraviolet ray lamps, not for medical purposes; urinals [sanitary fixtures]; vehicle headlights; vehicle reflectors; ventilation [air-conditioning] installations and apparatus; ventilation [air-conditioning] installations for vehicles; ventilation hoods; ventilation hoods for laboratories; waffle irons; electric walk-in refrigerators; warming pans; washers for water taps; wash-hand basins [parts of sanitary installations]; wash-hand bowls [parts of sanitary installations]; washing coppers; water closets; water conduits installations; water distribution installations; water filtering apparatus; water flushing installations; water heaters; water heaters [apparatus]; water intake apparatus; water purification installations; water purifying apparatus and machines; water softening apparatus; water softening apparatus and installations; water sterilizers; water supply installations; watering installations, automatic; watering machines for agricultural purposes; water-pipes for sanitary installations; whirlpool-jet apparatus.

37 – Building construction; repair; installation services, including: air conditioning apparatus installation and repair; airplane maintenance and repair; anti-rust treatment for vehicles; artificial snow-making services; asphaltting; boiler cleaning and repair; bricklaying; building construction supervision; building insulating; building sealing; damp-proofing (building); building of fair stalls and shops; rental of bulldozers; burglar alarm installation and repair; burner maintenance and repair; car wash; motor vehicle wash; carpentry services; chimney sweeping; cleaning of buildings (exterior surface); cleaning of buildings (interior); rental of cleaning machines; cleaning of clothing; clock and watch repair; clothing repair; construction; construction information; construction consultation; rental of construction equipment; rental of cranes (construction equipment); demolition of buildings; diaper cleaning; disinfecting; rental of drainage pumps; drilling of wells; drilling of deep oil or gas-wells; dry cleaning; electric appliance installation and repair; elevator installation and repair; lift

installation and repair; rental of excavators; factory construction; film projector repair and maintenance; fire alarm installation and repair; freezing equipment installation and repair; fur care, cleaning and repair; furnace installation and repair; furniture maintenance; furniture restoration; harbour construction; heating equipment installation and repair; installation, maintenance and repair of computer hardware; installation of doors and windows; interference suppression in electrical apparatus; irrigation devices installation and repair; kitchen equipment installation; knife sharpening; laundering; rental of laundry washing machines; leather care, cleaning and repair; linen ironing; machinery installation, maintenance and repair; masonry; mending clothing; mining extraction; motor vehicle maintenance and repair; office machines and equipment installation, maintenance and repair; painting or repair of signs; painting, interior and exterior; paper hanging; wallpapering; parasol repair; photographic apparatus repair; pier breakwater building; pipeline construction and maintenance; plastering; plumbing; pressing of clothing; pumicing; pump repair; quarrying services; rat exterminating; re-tinning; rebuilding engines that have been worn or partially destroyed; rebuilding machines that have been worn or partially destroyed; refilling of toner cartridges; renovation of clothing; repair of security locks; repair information; repair of power lines; restoration of works of art; restoration of musical instruments; retreading of tires (tyres); retreading of tires; retreading of tyres; riveting; road paving; rental of road sweeping machines; roofing services; rustproofing; safe maintenance and repair; sanding; scaffolding; shipbuilding; shoe repair; street cleaning; strong-room maintenance and repair; swimming-pool maintenance; telephone installation and repair; umbrella repair; underwater construction; underwater repair; upholstering; upholstery repair; varnishing; vehicle cleaning; vehicle wash; vehicle lubrication (greasing); vehicle greasing; vehicle lubrication; vehicle polishing; vehicle service stations (refuelling and maintenance); vehicle maintenance; vehicle breakdown assistance (repair); vehicle battery charging; vermin exterminating, other than for agriculture; vulcanization of tires (tyres) (repair); vulcanization of tires (repair); vulcanization of tyres (repair); warehouse construction and repair; washing of linen; washing; window cleaning.

(260) AM 2015 77216 A

(800) 1201835

(891) 2013 11 22

(731) AKITA KAIHATSU JAPAN RTE. LTD.

30 Bideford Road, 18-01 Thong Sia Building,
Singapore 229922, SG

(540)

LYNXAUTO

(511)

7 – Machines and machine tools; motors and engines (except for land vehicles); machine coupling and transmission components (except for land vehicles); incubators for eggs; electric welding machines; aerated beverage-making machines; gas-operated soldering apparatus; vulcanisation apparatus; acetylene cleaning apparatus; apparatus for drawing up beer under pressure; aerated water making apparatus; inking apparatus for printing machines; aerators; expansion tanks [parts of machines]; reels, mechanical, for flexible hoses; concrete mixers [machines]; reels [parts of machines]; bobbins for weaving looms; flues for engine boilers; harrows; bulldozers; hoppers [mechanical discharging]; mine borers; truck lifts; printing rollers for machines; rolling mill cylinders; fans for motors and engines; saw benches [parts of machines]; winnowers; water heaters [parts of machines]; winches; floating or non-floating drilling rigs; lawnmowers [machines]; card clothing [parts of carding machines]; emergency power generators; alternators; dynamos; bicycle dynamos; current generators; generators of electricity; drilling heads [parts of machines]; drilling bits [parts of machines]; gas-operated soldering blow pipes; raking machines; stalk separators [machines]; sieves [machines or parts of machines]; mud catchers and collectors [machines]; tarring machines; engines, other than for land vehicles; hydraulic engines and motors; aeronautical engines; aeroplane engines; engines for air cushion vehicles; compressed air engines; jet engines other than for land vehicles; engines for boats; driving motors other than for land vehicles; de-aerators for feedwater; disintegrators; tympan [parts of printing presses]; holding devices for machine tools; blade holders [parts of machines]; turf removing ploughs; pressure reducers [parts of machines]; pump diaphragms; chisels for machines; jacks [machines]; rack and pinion jacks; moving pavements [sidewalks]; electric hand drills; domestic crushers/grinders, electric; reapers; reapers and binders; millstones; rakes for raking machines; shredders [machines] for industrial use; injectors for engines; tools [parts of machines]; hand-held tools, other than hand-operated; air condensers; capstans; calenders; portable rotary steam presses for fabrics; ditchers [ploughs]; carburetters; carriages for knitting machines; crankcases for machines, motors and engines; road rollers; pressure valves [parts of machines]; clack valves [parts of machines]; electric can openers; cowlings [parts of machines]; machine wheels; freewheels other than for land vehicles; machine boiler scale collectors; lasts for shoes [parts of machines]; brake shoes other than for vehicles; reapers and threshers; coalcutting machines; fittings for engine boilers; compressors [machines]; air pumps [garage installations]; compressors for refrigerators; conveyors [machines]; belt conveyors; converters for steel works; aerocondensers; condensers [steam]

[parts of machines]; diggers [machines]; rams [machines]; thermic lances [machines]; mechanized livestock feeders; root slicers [machines]; boxes for matrices [printing]; housings [parts of machines]; harvesting machines; steam engine boilers; coffee grinders, other than hand-operated; taps [parts of machines, engines or motors]; roller bridges; cranes [lifting and hoisting apparatus]; drain cocks; spray guns for paint; cranks [parts of machines]; potters' wheels; grindstones [parts of machines]; cultivators [machines]; motorized cultivators; ploughshares; belts for conveyors; igniting magnetos; automatic handling machines [manipulators]; lubricators [parts of machines]; churns; matrices for use in printing; machine fly-wheels; hair clipping machines for animals; machines for the textile industry; paper machines; vibrators [machines] for industrial use; bellows [machines]; knitting machines; bending machines; ironing machines; mineworking machines; net hauling machines [fishing]; bottle sealing machines; sealing machines for industrial purposes; embossing machines; engraving machines; finishing machines; garbage disposals; blade sharpening [stropping] machines; earth moving machines; cord making machines; lace making machines; butter machines; cigarette machines for industrial purposes; sausage machines; stereotype machines; hosiery looms; crushing machines; dyeing machines; bottle washing machines; dishwashers; bottle filling machines; racket stringing machines; leather-working machines; dairy machines; glass working machines; tobacco processing machines; corn husking machines; painting machines; oil refining machines; peeling machines; printing machines for use on sheet metal; brewing machines; colour-washing machines; leather paring machines; bitumen making machines; machines for making edible pastes; sugar making machines; weeding machines; cinder sifters [machines]; puddling machines; notchers [machine tools]; bread cutting machines; blowing machines for the compression, exhaustion and transport of gases; road making machines; railroad constructing machines; rail-laying machines; bottle capping machines; bottle stoppering machines; trash compacting machines; blowing machines for the compression, sucking and carrying of grain; die-stamping machines; stamping machines; darning machines; drainage machines; wrapping machines; grain separators; bookbinding apparatus and machines for industrial purposes; electric machines and apparatus for cleaning; electric machines and apparatus for carpet shampooing; machines and apparatus for polishing [electric]; sizing machines; punching machines; riveting machines; electric kitchen machines; foundry machines; smoothing presses; fleshing machines; rinsing machines; flour mill machines; hemming machines; braiding machines; wringing machines for laundry; steam engines; printing machines; rotary printing presses; typographic machines; compressed air machines;

type-setting machines [printing]; apparatus for dressing; spinning frames; heel-making machines; filling machines; friezing machines; cutters [machines]; road sweeping machines [self-propelled]; satinizing machines; agricultural machines; sorting machines for industry; stitching machines; washing machines; washing machines [laundry]; coin-operated washing machines; clippers [machines]; spin driers [not heated]; looms; kneading machines; beating machines; electric beaters; packaging machines; molding machines; typesetting machines [photocomposition]; carding machines; sewing machines; typecasting machines; electromechanical machines for chemical industry; labellers [machines]; ore treating machines; milking machines; mills [machines]; mills for household purposes, other than hand-operated; pepper mills other than hand-operated; flour mills; centrifugal mills; hydraulic controls for machines, motors and engines; machine wheelwork; pneumatic controls for machines, motors and engines; feeders [parts of machines]; forge bellows; mixers [machines]; electric blenders for household purposes; agitators; vacuum cleaner bags; threshing machines; pneumatic hammers; hammers [parts of machines]; tilt hammers; power hammers; mechanical reeling apparatus; motors for boats; meat choppers [machines]; superchargers; guides for machines; vacuum cleaner attachments for disseminating perfumes and disinfectants; pumps [machines]; pumps [parts of machines, engines or motors]; aerating pumps for aquaria; vacuum pumps [machines]; compressed air pumps; pumps for heating installations; beer pumps; lubricating pumps; centrifugal pumps; blades [parts of machines]; knives for mowing machines; chaff cutter blades; electric knives; electric scissors; bearing brackets for machines; atomisers [machines]; axles for machines; steam traps; chucks [parts of machines]; drill chucks [parts of machines]; exhaust manifold for engines; superheaters; gears, other than for land vehicles; reduction gears other than for land vehicles; propulsion mechanisms other than for land vehicles; drilling machines; saws [machines]; chain saws; guns [tools using explosives]; electric glue guns; compressed air guns for the extrusion of mastics; carburetter feeders; feeding apparatus for engine boilers; loading ramps; ploughs; pneumatic transporters; roller bearings; self-oiling bearings; bearings for transmission shafts; ball-bearings; journal boxes [parts of machines]; elevators [lifts]; lifts, other than ski-lifts; hoists; pulleys; saw blades [parts of machines]; catalytic converters; torque converters other than for land vehicles; fuel conversion apparatus for internal combustion engines; presses [machines for industrial purposes]; wine presses; fodder presses; printing presses; typographic presses; swaging machines; transmissions for machines; elevator belts; pedal drives for sewing machines; high pressure washers; cleaning appliances utilizing steam; electric food processors; springs [parts of machines];

separators; steam/oil separators; spinning wheels; punches for punching machines; kick starters for motorcycles; vacuum cleaners; tambours for embroidery machines; radiators [cooling] for motors and engines; sewage pulverizers; air brushes for applying colour; regulators [parts of machines]; pressure regulators [parts of machines]; feedwater regulators; speed governors for machines, engines and motors; knives [parts of machines]; gas-operated cutting blow pipes; loom shafts; gears for weaving looms; belts for machines; fan belts for motors and engines; dynamo belts; belts for motors and engines; adhesive bands for pulleys; sifters; robots [machines]; stuffing boxes [parts of machines]; paper feeders [printing]; electric whisks for household purposes; sparking plugs for internal combustion engines; tedding machines; steam/oil separators; cream/milk separators; sowers [machines]; mixing machines; snow ploughs; sheaf-binding machines; joints [parts of engines]; shaft couplings [machines]; electric fruit presses for household purposes; chaff cutters; suction cups for milking machines; stands for machines; machine tools; woodworking machines; sharpening machines; die-cutting and tapping machines; trueing machines; bicycle assembling machines; mortising machines; stone working machines; metalworking machines; threading machines; planing machines; lathes [machine tools]; milling machines; metal drawing machines; rolling mills; starters for motors and engines; stators [parts of machines]; glaziers' diamonds [parts of machines]; tables for machines; dericks; slide rests [parts of machines]; couplings other than for land vehicles; heat exchangers [parts of machines]; grating machines for vegetables; transmissions, other than for land vehicles; control cables for machines, engines or motors; boiler tubes [parts of machines]; turbines other than for land vehicles; hydraulic turbines; turbocompressors; connecting rods for machines, motors and engines; central vacuum cleaning installations; suction machines for industrial purposes; vehicle washing installations; degreasers [machines]; dust exhausting installations for cleaning purposes; mineral water making machines; sifting installations; pneumatic tube conveyors; dust removing installations for cleaning purposes; condensing installations; air suction machines; dividing machines; igniting devices for internal combustion engines; washing apparatus; binding apparatus for hay; extractors for mines; hydraulic door openers and closers [parts of machines]; pneumatic door openers and closers [parts of machines]; anti-pollution devices for motors and engines; electrically operated curtain drawing devices; adhesive tape dispensers [machines]; electromechanical beverage preparation machines; electromechanical food preparation machines; control mechanisms for machines, engines or motors; electric shoe polishers; electric machines and apparatus for wax-polishing; air cushion devices for moving loads; handling ap-

paratus for loading and unloading; elevating apparatus; aprons [parts of machines]; filters for cleaning cooling air, for engines; molds [parts of machines]; printing plates; brake linings other than for vehicles; journals [parts of machines]; centrifugal machines; elevator chains [parts of machines]; driving chains other than for land vehicles; cylinders for motors and engines; cylinders for machines; printing cylinders; shuttles [parts of machines]; universal joints [cardan joints]; pulleys [parts of machines]; vacuum cleaner hoses; brushes [parts of machines]; dynamo brushes; carbon brushes [electricity]; ejectors; fuel economisers for motors and engines; excavators; mechanical shovels; agricultural elevators; electric motors, other than for land vehicles; electric hammers; electrodes for welding machines; electric parquet wax-polishers; cartridges for filtering machines; escalators; automatic grapnels for marine purposes.

9 – 9 Scientific, nautical, surveying, photographic, cinematographic, weighing, measuring, signaling, checking supervision, lifesaving and teaching apparatus and instruments; apparatus and instruments for conducting, switching, transforming, accumulating, regulating or controlling electricity; apparatus for recording, transmission or reproduction of sound or images; magnetic data carriers, recording discs; cash registers, calculating machines, data processing equipment and computers; fire-extinguishing apparatus; DVD players; ticket dispensers; musical juke boxes; motor fire engines; answering machines; electric accumulators; electric accumulators for vehicles; actinometers; alidades; altimeters; ammeters; anemometers; anodes; aerials; anticathodes; high-frequency apparatus; testing apparatus not for medical purposes; remote control apparatus; electro-dynamic apparatus for the remote control of railway points; electro-dynamic apparatus for the remote control of signals; electric monitoring apparatus; sound recording apparatus; distillation apparatus for scientific purposes; air analysis apparatus; apparatus to check franking; sound transmitting apparatus; apparatus for fermentation [laboratory apparatus]; breathing apparatus, except for artificial respiration; breathing apparatus for underwater swimming; Xrays producing apparatus and installations, not for medical purposes; cash registers; electric apparatus for commutation; intercommunication apparatus; stills for laboratory experiments; projection apparatus; roentgen apparatus not for medical purposes; radiological apparatus for industrial purposes; blueprint apparatus; blinkers [signalling lights]; stereoscopic apparatus; telegraphs [apparatus]; telephone apparatus; telephone transmitters; facsimile machines; phototelegraphy apparatus; electric igniting apparatus for igniting at a distance; acid hydrometers; salinometers; acidimeters for batteries; aerometers; luminous beacons; barometers; anode batteries; galvanic batteries; batteries for pocketlamps; batteries for lighting; solar batteries; electric batteries; balances [steelyards]; be-

tatrons; binoculars; electronic tags for goods; magnetic tape units for computers; computer memories; fire hose nozzles; magnetic encoded identification bracelets; safety tarpaulins; signalling buoys; life buoys; marking buoys; directional compasses; vacuum gauges; electrolyzers; variometers; scales; letter scales; weighbridges; precision balances; levelling staffs [surveying instruments]; camcorders; video cassettes; video telephones; video screens; photographic viewfinders; plugs, sockets and other contacts [electric connections]; viscosimeters; circuit closers; wavemeters; voltmeters; mechanical signs; switch-boxes [electricity]; current rectifiers; jigs [measuring instruments]; gas testing instruments; gasometers; galvanometers; heliographic apparatus; hygrometers; hydrometers; weights; holograms; plotters; loudspeakers; sounding leads; plumb bobs; range finders; densimeters; densitometers; detectors; galena crystals [detectors]; smoke detectors; false coin detectors; slides [photography]; slide projectors; diaphragms [photography]; dictating machines; dynamometers; floppy disks; magnetic phonograph records; disks, magnetic; optical discs; calculating disks; disk drives for computers; juke boxes for computers; phonograph records; magnetic disks; dna chips; electronic notice boards; bullet-proof waistcoats [vests (Am.)]; life jackets; identification threads for electric wires; nose clips for divers and swimmers; electric locks; bells [warning devices]; electric alarm bells; electric door bells; signal bells; acoustic conduits; mirrors for inspecting work; luminous or mechanical road signs; luminous signs; marine depth finders; probes for scientific purposes; electric buzzers; buzzers; needles for record players; gauges; pressure measuring apparatus; simulators for the steering and control of vehicles; inverters [electricity]; pressure indicators; temperature indicators; incubators for bacteria culture; measuring instruments; mathematical instruments; levelling instruments; surveying instruments; azimuth instruments; interfaces for computers; ionisation apparatus, not for the treatment of air; spark-guards; coaxial cables; fibre [fiber (Am.)] optic cables; electric cables; calipers; slide calipers; screw-tapping gauges; calculating machines; pocket calculators; decompression chambers; cinematographic cameras; electronic pens [visual display units]; holders for electric coils; magnetic identity cards; video game cartridges; encoded magnetic cards; riding helmets; protective helmets; carriers for dark plates [photography]; automated teller machines [atm]; cathodes; choking coils [impedance]; electric coils; electromagnetic coils; spools [photography]; exposed cinematographic film; computer keyboards; solenoid valves [electromagnetic switches]; wire connectors [electricity]; electronic agendas; push buttons for bells; mouse pads; magnetic encoders; anti-dazzle shades; collectors, electric; calibrating rings; protective suits for aviators; commutators; compact discs [audio- video]; compact

discs [read-only memory]; comparators; marine compasses; computers; notebook computers; capacitors; electric contacts; electric contacts of precious metal; wind socks for indicating wind direction; branch boxes [electricity]; distribution boxes [electricity]; connectors [electricity]; junction boxes [electricity]; accumulator boxes; cabinets for loudspeakers; diving suits; reflecting discs for wear, for the prevention of traffic accidents; covers for electric outlets; logs [measuring instruments]; lasers, not for medical purposes; lactodensimeters; lactometers; darkroom lamps [photography]; neon signs; thermionic valves [radio]; amplifying tubes; flashlights [photography]; head cleaning tapes [recording]; magnetic tapes; videotapes; surveying chains; fire escapes; rulers [measuring instruments]; slide-rules; sounding lines; electricity conduits; measuring spoons; thread counters; magnets; decorative magnets; resuscitation mannequins [teaching apparatus]; mouse [data processing equipment]; manometers; divers' masks; solderers' helmets; protective masks; materials for electricity mains [wires, cables]; accounting machines; voting machines; money counting and sorting machines; material testing instruments and machines; hemline markers; megaphones; diaphragms [acoustics]; diaphragms for scientific apparatus; metal detectors for industrial or military purposes; metronomes; rules [measuring instruments]; carpenters' rules; dressmakers' measures; mechanisms for coin-operated apparatus; coinoperated mechanisms for television sets; shutter releases [photography]; micrometer gauges; microprocessors; microtomes; microphones; modems; lightning arresters; monitors [computer hardware]; animated cartoons; terminals [electricity]; junction sleeves for electric cables; cases fitted with dissecting instruments [microscopy]; teeth protectors; kneepads for workers; headphones; surveyors' levels; verniers; sound recording carriers; magnetic data media; optical data media; electrically heated socks; sheaths for electric cables; identification sheaths for electric wires; weighing machines; punched card machines for offices; furniture especially made for laboratories; shoes for protection against accidents, irradiation and fire; egg-candlers; extinguishers; electrified fences; limiters [electricity]; clothing for protection against accidents, irradiation and fire; clothing for protection against fire; asbestos clothing for protection against fire; clothing especially made for laboratories; ozonisers [ozonators]; octants; eyepieces; ohmmeters; wrist rests for use with computers; spectacle frames; eyeglass frames; oscillographs; plumb lines; mirrors [optics]; sunglasses; goggles for sports; luminous or mechanical signalling panels; radio pagers; eyeglasses; electronic pocket translators; transmitters [telecommunication]; transmitters of electronic signals; electric switches; gloves for divers; asbestos gloves for protection against accidents; gloves for protection against accidents; gloves for protection against

X-rays for industrial purposes; furnaces for laboratory experiments; pipettes; pyrometers; planimeters; plane tables [surveying instruments]; plates for batteries; wafers [silicon slices]; compact disc players; cassette players; sound recording strips; roentgen films, exposed; exposed films; life-saving rafts; laboratory trays; semi-conductors; polarimeters; fire engines; measuring glassware; life belts; circuit breakers; fuses; electric converters; telerupters; food analysis apparatus; diagnostic apparatus, not for medical purposes; distance measuring apparatus; speed measuring apparatus [photography]; appliances for measuring the thickness of leather; apparatus for measuring the thickness of skins; speed checking apparatus for vehicles; teaching apparatus; time recording apparatus; distance recording apparatus; apparatus and instruments for astronomy; surveying apparatus and instruments; weighing apparatus and instruments; nautical apparatus and instruments; apparatus and instruments for physics; chemistry apparatus and instruments; measuring apparatus; electric measuring devices; boiler control instruments; cosmographic instruments; meteorological instruments; naval signalling apparatus; observation instruments; navigation apparatus for vehicles [on-board computers]; satellite navigational apparatus; electric regulating apparatus; precision measuring apparatus; audio and video receivers; prisms [optics]; printers for use with computers; apparatus for changing record player needles; drainers for use in photography; retorts' stands; cleaning apparatus for phonograph records; fire beaters; sighting telescopes for firearms; test tubes; pressure indicator plugs for valves; magnetic wires; telegraph wires; telephone wires; electric wires; electric conductors; insulated copper wire; fuse wire; record players; central processing units [processors]; rods for water diviners; distribution consoles [electricity]; control panels [electricity]; radar apparatus; vacuum tubes [radio]; masts for wireless aerials; transmitting sets [telecommunication]; radios; vehicle radios; frames for photographic transparencies; screens for photoengraving; walkie-talkies; voltage surge protectors; voltage regulators for vehicles; light dimmers [regulators], electric; stage lighting regulators; speed regulators for record players; cell switches [electricity]; washing trays [photography]; marking gauges [joinery]; automatic time switches; electric relays; safety restraints, other than for vehicle seats and sports equipment; X-ray photographs, other than for medical purposes; rheostats; respirators, other than for artificial respiration; respirators for filtering air; retorts; refractometers; refractors; grids for batteries; horns for loudspeakers; saccharometers; light conducting filaments [optical fibers [fibres]]; traffic-light apparatus [signalling devices]; dog whistles; signalling whistles; sextants; inductors [electricity]; life nets; nets for protection against accidents; fire alarms; luminous or mechanical signals; sirens; sca-

nners [data processing equipment]; integrated circuit cards [smart cards]; connections for electric lines; electric connections; sonars; sound locating instruments; lighting ballasts; electric resistances; spectrograph apparatus; spectrometers; speed indicators; alcoholmeters; satellites for scientific purposes; protection devices for personal use against accidents; audiovisual teaching apparatus; radiotelegraphy sets; radiotelephony sets; glass covered with an electrical conductor; personal stereos; stereoscopes; fire boats; sulphitometers; hands free kits for phones; drying racks [photography]; spherometers; integrated circuits; printed circuits; counters; parking meters; apparatus to check stamping mail; kilometer recorders for vehicles; revolution counters; abacuses; taximeters; ear plugs for divers; tachometers; television apparatus; teleprompters; teleprinters; portable telephones; theodolites; thermometers, not for medical purposes; thermostats; thermostats for vehicles; crucibles [laboratory]; tone arms for record players; totalizers; transistors [electronic]; protractors [measuring instruments]; battery chargers; transformers [electricity]; vehicle breakdown warning triangles; starter cables for motors; electric discharge tubes, other than for lighting; capillary tubes; X-ray tubes not for medical purposes; telephone receivers; quantity indicators; automatic indicators of low pressure in vehicle tires [tyres]; gasoline gauges; water level indicators; electric loss indicators; light-emitting electronic pointers; clinometers; levels [instruments for determining the horizontal]; mercury levels; spirit levels; urinometers; amplifiers; particle accelerators; sprinkler systems for fire protection; electric installations for the remote control of industrial operations; automatic steering apparatus, for vehicles; balancing apparatus; video recorders; sound reproduction apparatus; invoicing machines; tape recorders; protection devices against X-rays [roentgen rays], not for medical purposes; railway traffic safety appliances; data processing apparatus; oxygen transvasing apparatus; electric theft prevention installations; time clocks [time recording devices]; film cutting apparatus; drying apparatus for photographic prints; optical character readers; centering apparatus for photographic transparencies; dosage dispensers; chargers for electric batteries; sound alarms; sounding apparatus and machines; life saving apparatus and equipment; editing appliances for cinematographic films; cathodic anti-corrosion apparatus; couplers [data processing equipment]; computer peripheral devices; anti-interference devices [electricity]; demagnetizing apparatus for magnetic tapes; acoustic couplers; anti-theft warning apparatus; alarms; non-explosive fog signals; adding machines; readers [data processing equipment]; heat regulating apparatus; photocopiers [photographic, electrostatic, thermic]; bar code readers; filters for respiratory masks; filters for ultraviolet rays, for photography; filters [photography]; magic lanterns;

optical lamps; signal lanterns; cameras [photography]; glazing apparatus for photographic prints; shutters [photography]; darkrooms [photography]; photometers; flash-bulbs [photography]; enlarging apparatus [photography]; photovoltaic cells; cases especially made for photographic apparatus and instruments; chromatography apparatus for laboratory use; chronographs [time recording apparatus]; eyeglass chains; cyclotrons; compasses [measuring instruments]; frequency meters; egg timers [sandglasses]; fire blankets; chips [integrated circuits]; pedometers; meteorological balloons; electrified rails for mounting spot lights; asbestos screens for firemen; protective helmets for sports; eyeglass cords; stands for photographic apparatus; switchboards; distribution boards [electricity]; workmen's protective face-shields; projection screens; radiology screens for industrial purposes; fluorescent screens; screens [photography]; exposure meters [light meters]; ducts [electricity]; galvanic cells; epidiascopes; ergometers; armatures [electricity].

11 – Apparatus for lighting, heating, steam generating, cooking, refrigerating, drying, ventilating, water supply and sanitary purposes; lamp shades; steam accumulators; heat accumulators; defrosters for vehicles; water heaters [apparatus]; distillation apparatus; desiccating apparatus; disinfectant apparatus; air deodorising apparatus; tanning apparatus [sun beds]; ionization apparatus for the treatment of air or water; coffee roasters; beverage cooling apparatus; hand drying apparatus for washrooms; water purifying apparatus and machines; refrigerating apparatus and machines; drying apparatus and installations; freezers; drying apparatus; fruit roasters; framework of metal for ovens; coolers for furnaces; expansion tanks for central heating installations; refining towers for distillation; bidets; boilers, other than parts of machines; bath tubs; spa baths [vessels]; bath tubs for sitz baths; electric waffle irons; fans [air-conditioning]; fans [parts of air-conditioning installations]; electric fans for personal use; roasting spits; refrigerating display cabinets [display cases]; water heaters; flushing apparatus; air reheaters; extractor hoods for kitchens; gas condensers, other than parts of machines; acetylene generators; hydrants; burners; acetylene burners; petrol burners; gas burners; burners for lamps; germicidal burners; incandescent burners; oxhydrogen burners; laboratory burners; oil burners; alcohol burners; hot water bottles; electric or non-electric footwarmers; bedwarmers; pocket warmers; lampshade holders; stills; showers; chimney flues; refrigerating containers; gas lighters; friction lighters for igniting gas; chimney blowers; coils [parts of distilling, heating or cooling installations]; ash pits for furnaces; evaporators; flares; shower cubicles [enclosures (Am.)]; portable turkish bath cabinets; heating apparatus; refrigerating chambers; domestic fireplaces; autoclaves [electric pressure cookers]; air valves for steam heating installations;

level controlling valves in tanks; thermostatic valves [parts of heating installations]; electrically heated carpets; light bulbs; electric light bulbs; solar collectors [heating]; distillation columns; lamp globes; air conditioning apparatus; gas boilers; laundry room boilers; heating boilers; electric coffee machines; pipe line cocks [spigots]; taps [faucets]; mixer taps for water pipes; portable forges; lava rocks for use in barbecue grills; electric lights for Christmas trees; acetylene flares; safety lamps; gas lamps; curling lamps; germicidal lamps for purifying air; projector lamps; lamps for directional signals of automobiles; lamps; light bulbs for directional signals for vehicles; arc lamps; laboratory lamps; oil lamps; ultraviolet ray lamps, not for medical purposes; miners' lamps; electric lamps; chandeliers; barbecues; disposable sterilization pouches; electrically heated foot-muffs; heaters, electric, for feeding bottles; heaters for baths; heaters for heating irons; immersion heaters; brackets for gas burners; anti-splash tap nozzles; heat pumps; filaments for electric lamps; electric heating filaments; magnesium filaments for lighting; luminous house numbers; bath linings; heating apparatus for defrosting windows of vehicles; hot air bath fittings; bath fittings; loading apparatus for furnaces; kiln furniture [supports]; sauna bath installations; refrigerating appliances and installations; electric blankets, not for medical purposes; lamp reflectors; vehicle reflectors; clean chambers [sanitary installations]; steam boilers, other than parts of machines; pasteurisers; lamp casings; sockets for electric lights; electric coffee percolators; furnaces, other than for experimental purposes; stoves [heating apparatus]; bread baking machines; bakers' ovens; hot air ovens; microwave ovens [cooking apparatus]; microwave ovens for industrial purposes; incinerators; kilns; solar furnaces; urinals [sanitary fixtures]; feeding apparatus for heating boilers; heating plates; cookers; kitchen ranges [ovens]; aquarium heaters; aquarium lights; electric heating cushions [pads], not for medical purposes; electric cooking utensils; water intake apparatus; deodorising apparatus, not for personal use; apparatus for dehydrating foodstuffs organic materials; griddles [cooking appliances]; fumigation apparatus, not for medical purposes; gas scrubbing apparatus; oil-scrubbing apparatus; glue-heating appliances; drying apparatus for fodder and forage; water filtering apparatus; air purifying apparatus and machines; ice machines and apparatus; cooling appliances and installations; cooking apparatus and installations; lighting apparatus and installations; sanitary apparatus and installations; cooking rings; lighting apparatus for vehicles; heating apparatus for solid, liquid or gaseous fuels; electric heating apparatus; hot air apparatus; steam facial apparatus [saunas]; safety accessories for water or gas apparatus and pipes; regulating and safety accessories for gas apparatus; regulating accessories for water or gas apparatus and pipes; regulating and safety

accessories for water apparatus; regulating and safety accessories for gas pipes; roasting jacks; anti-dazzle devices for automobiles [lamp fittings]; plate warmers; electric appliances for making yogurt; rotisseries; radiator caps; diving lights; searchlights; washers for water taps; anti-glare devices for vehicles [lamp fittings]; radiators [heating]; central heating radiators; electric radiators; sinks; disinfectant dispensers for toilets; drip irrigation emitters [irrigation fittings]; light diffusers; atomic piles; heat regenerators; flushing tanks; pressure water tanks; fire bars; roasters; standard lamps; ceiling lights; toilet seats; lighting installations for air vehicles; gas scrubbers [parts of gas installations]; lamp glasses; sterilizers; water sterilizers; air sterilisers; air driers [dryers]; electric laundry dryers; hair driers [dryers]; malt roasters; tobacco roasters; heat exchangers, not parts of machines; bread toasters; discharge tubes, electric, for lighting; lamp chimneys; luminous tubes for lighting; flues for heating boilers; boiler pipes [tubes] for heating installations; water-pipes for sanitary installations; water closets; portable toilets; humidifiers for central heating radiators; wash-hand basins [parts of sanitary installations]; toilet bowls; water conduits installations; bath installations; air conditioning installations; air conditioners for vehicles; desalination plants; processing installations for fuel and nuclear moderating material; automatic watering installations; cooling installations for water; cooling installations for liquids; milk cooling installations; cooling installations for tobacco; water purification installations; purification installations for sewage; steam generating installations; water distribution installations; air filtering installations; swimming pool chlorinating apparatus; ventilation [air-conditioning] installations and apparatus; water softening apparatus and installations; cooling installations and machines; heating installations; heaters for vehicles; heating installations [water]; polymerisation installations; water supply installations; automatic ash conveyor installations; whirlpool-jet apparatus; air cooling apparatus; stoves; aquarium filtration apparatus; flare stacks for use in the oil industry; headlights for automobiles; vehicle headlights; filters [parts of household or industrial installations]; electric filters for air conditioning; coffee filters; filters for drinking water; lanterns; automobile lights; bicycle lights; lights for vehicles; pocket searchlights; lanterns for lighting; Chinese lanterns; fountains; ornamental fountains; electric deep fryers; oven fittings made of fireclay; fittings, shaped, for furnaces; refrigerators; chromatography apparatus for ventilation hoods; ventilation hoods for laboratories; dental ovens; refrigerating cabinets; ice boxes; fuel economisers; carbon for arc lamps; heating elements.

12 – Casings for pneumatic tires [tyres]; brake linings for vehicles; vehicle bumpers; bumpers for automobiles; transmission shafts for land vehicles;

valves for vehicle tires [tyres]; horns for vehicles; doors for vehicles; rearview mirrors; inner tubes for pneumatic tires [tyres]; hoods for vehicle engines; crankcases for land vehicle components, other than for engines; vehicle wheels; brake segments for vehicles; hub caps; gear boxes for land vehicles; bands for wheel hubs; caps for vehicle petrol [gas] tanks; bodies for vehicles; automobile bodies; tipping bodies for lorries [trucks]; freewheels for land vehicles; clutches for land vehicles; repair outfits for inner tubes; adhesive rubber patches for repairing inner tubes; air pumps [vehicle accessories]; upholstery for vehicles; rims for vehicle wheels; windows for vehicles; axles for vehicles; gearing for land vehicles; head-rests for vehicle seats; vehicle running boards; air bags [safety devices for automobiles]; torque converters for land vehicles; anti-glare devices for vehicles; anti-theft devices for vehicles; sun-blinds adapted for automobiles; non-skid devices for vehicle tires [tyres]; balance weights for vehicle wheels; reduction gears for land vehicles; safety belts for vehicle seats; vehicle suspension springs; rudders; anti-theft alarms for vehicles; reversing alarms for vehicles; vehicle seats; safety seats for children, for vehicles; hydraulic circuits for vehicles; windcreens; hubs for vehicle wheels; trailer hitches for vehicles; couplings for land vehicles; brakes for vehicles; turbines for land vehicles; direction signals for vehicles; spoke clips for wheels; automobile chains; driving chains for land vehicles; anti-skid chains; covers for vehicle steering wheels; seat covers for vehicles; automobile chassis; connecting rods for land vehicles, other than parts of motors and engines; axle journals; automobile tires [tyres]; tires for vehicle wheels; vehicle wheel tires [tyres]; pneumatic tires [tyres]; spikes for tires [tyres]; mudguards; motors, electric, for land vehicles.

35 – Advertising; business management; business administration; office functions; arranging subscriptions to telecommunication services for others; import-export agencies; commercial information agencies; advertising agencies; cost price analysis; rental of advertising space; auditing; employment agencies; computerized file management; accounting; invoicing; efficiency experts; demonstration of goods; transcription; opinion polling; marketing studies; business information; commercial information and advice for consumers [consumer advice shop]; business investigations; marketing research; personnel recruitment; business management and organization consultancy; personnel management consultancy; business organization consultancy; business management consultancy; professional business consultancy; layout services for advertising purposes; business management of performing artists; news clipping services; updating of advertising material; word processing; secretarial services; shorthand; organization of exhibitions for commercial or advertising purposes; arranging newspaper subscriptions for ot-

hers; organization of trade fairs for commercial or advertising purposes; shop window dressing; business appraisals; payroll preparation; data search in computer files for others; sponsorship search; business management assistance; commercial or industrial management assistance; presentation of goods on communication media, for retail purposes; economic forecasting; auctioneering; sales promotion for others; office machines and equipment rental; rental of advertising time on communication media; publicity material rental; rental of vending machines; rental of photocopying machines; publication of publicity texts; typing; radio advertising; bill-posting; distribution of samples; direct mail advertising; writing of publicity texts; on-line advertising on a computer network; advertising by mail order; television advertising; document reproduction; compilation of statistics; compilation of information into computer databases; business inquiries; systemization of information into computer databases; tax preparation; drawing up of statements of accounts; publicity columns preparation; psychological testing for the selection of personnel; business management of hotels; commercial administration of the licensing of the goods and services of others; administrative processing of purchase orders; public relations; modelling for advertising or sales promotion; relocation services for businesses; price comparison services; procurement services for others [purchasing goods and services for other businesses]; outsourcing services [business assistance]; telephone answering for unavailable subscribers; photocopying.

(260) AM 2015 77217 A
 (800) 1201847
 (891) 2013 12 30
 (731) PRIVATE JOINT STOCK COMPANY
 "INDUSTRIAL ASSOCIATION "KONTI"
 Bul. Shevchenko, 6-b, Donetsk 83015, UA
 (540)

Маджента

(511)
 30 – Coffee, tea, cocoa, sugar, rice, tapioca, sago, artificial coffee, flour and preparations made from cereals, bread, pastry and confectionery, ices, honey, treacle, yeast, baking-powder; salt, mustard; vinegar, sauces (condiments); spices; edible ices; farinaceous foods; waffles; waffles with various fillings; cereal products; dragee (confectionery); chewing gum; custard; frozen kefir; frozen yogurt; cocoa-based ingredients for confectionery products; cocoa; cocoa mixes; cocoa powder; cocoa spreads; caramels (candy); crackers; confectionery for decorating Christmas trees; candy for food; marzipan; almond confectionery; flour-milling products; muesli; cookies; cookies glazed with chocolate; quiches (confectionery); chips (cereal products); fondants (confectionery); gingerbread; puddings; cakes; fruit jellies (confectionery);

tionery); halvah; sweetmeats (candy); sugar confectionery; waffle candies; chocolate; chocolate bars.

(260) AM 2015 77220 A
 (800) 1201920
 (891) 2014 03 27
 (731) ROCHE DIAGNOSTICS GMBH
 Sandhofer Str. 116, 68305 Mannheim, DE
 (540)

GUIDE

5 – Pharmaceutical and veterinary products; in-vitro diagnostics for medical purposes; test strips for determining levels of blood glucose.

(260) AM 2015 77221 A
 (800) 1201969
 (891) 2014 01 30
 (731) APPLE INC.
 1 Infinite Loop, Cupertino CA 95014, US
 (540)

TOUCH ID

(591) Black, white
 (511)
 35 – Business consulting services; advertising agency services; advertising, marketing, and promotion services; advertising and marketing consultation; sales promotion services; the bringing together, for the benefit of others, of a variety of goods for review and purchase; promoting the goods and services of others; analysis of advertising response and market research; administration of consumer loyalty programs; arranging and conducting incentive rewards programs to promote the sale of goods and services of others; providing business, consumer, and commercial information over computer networks and global communication networks; business services, namely, information regarding the purchase and sale of a wide variety of products and services of others from computer databases; retail store services; on-line retail store services provided via the Internet and other electronic and communications networks; retail store services in the field of books, magazines, periodicals, newsletters, journals and other publications on a wide range of topics of general interest; retail store services in the field of entertainment featuring audio and video recordings relating to movies, television programs, cultural events, sporting events, electronic games, computer software applications, musical works, and audio and audiovisual works; retail store services featuring computers, consumer electronics, telecommunications apparatus, mobile phones, handheld digital electronic devices, computer software, and accessories, peripherals, and carrying cases for such products; information, advisory and consultancy services relating to all the aforesaid.

(260) AM 2015 77223 A
 (800) 1201976
 (891) 2014 03 14
 (731) TAKEDA GMBH
 Byk-Gulden-Str. 2, 78467 Konstanz, DE
 (540)

MYORIX

(511)
 5 – Pharmaceutical preparations.

(260) AM 2015 77224 A
 (800) 1202029
 (891) 2014 03 14
 (731) TAKEDA GMBH
 Byk-Gulden-Str. 2, 78467 Konstanz, DE
 (540)

МИОРИКС

(511)
 5 – Pharmaceutical preparations.

(260) AM 2015 77225 A
 (800) 557305
 (891) 2014 02 21
 (731) TECHNOLOGIE ALPINE DE
 SECURITE – TAS
 Parc d'activités Alpespace, 74 voie Magellan,
 F-73800 Sainte-Hélène-du-Lac, FR
 (540)

GAZEX

(511)
 9 – Apparatus for triggering avalanches by means of
 an explosive mixture.

(260) AM 2015 77226 A
 (800) 581886
 (891) 2014 02 05
 (731) ANDROS
 Zone Industrielle, F-46131 BIARS SUR
 CERE, FR
 (540)



(591) Black, grey
 (511)
 29 – Meat, fish, poultry and game; meat extracts;
 preserved, dried and cooked fruit and vegetables;
 jellies, jams; eggs, milk and dairy products; edible
 oils and fats; tinned foodstuffs.

30 – Coffee, tea, cocoa, chocolate, sugar, rice, tapio-
 ca, sago, coffee substitutes; flour and preparations
 made from cereals, bread, pastry and confectionery,
 edible ice; honey, molasses; yeast, baking powder;
 salt, mustard, vinegar, sauces, salad creams and dre-
 ssings, spices; cooling ice.

31 – Agricultural, horticultural and forestry products
 and grains, not included in other classes; live ani-
 mals; fresh fruits and vegetables; natural seeds,
 plants and flowers; animal feed, malt.

(260) AM 2015 77227 A
 (800) 684902
 (891) 2014 01 03
 (731) BEIJING XING WEI SPORTS GOODS CO.,
 LTD
 8 Minhe Road, Niantan Industrial
 Development Zone, Huangcun Town, Daxing
 District, BEIJING CITY, CN

(540)



(591) Black, white
 (511)
 28 – Table for billiard.

(260) AM 2015 77228 A
 (800) 986364
 (891) 2014 04 15
 (731) MOUFARRIGE Mounir
 Place of Residence located, Immeuble
 Soprano, Rue des Saints Coeurs, Tabaris,
 Beirut, LB

(540)



L. KENDALL

(591) Black, white
 (511)
 14 – Precious metals and their alloys and goods in
 precious metals or coated therewith, not included in
 other classes; jewellery, precious stones; horological
 and chronometric instruments.

(260) AM 2015 77229 A
 (800) 1003253
 (891) 2014 02 21
 (731) TECHNOLOGIE ALPINE DE
 SECURITE-TAS
 Parc d'Activités Alpespace, 74 voie Magellan,
 F-73800 SAINTE-HELENE-DU-LAC, FR

(540)

DaisyBell

(511)

9 – Apparatus for triggering avalanches.

(260) AM 2015 77230 A

(800) 1050515

(891) 2014 03 21

(731) BOX INTERNATIONAL KFT

Vaci Ucta 81.4 EM, H-1056 BUDAPEST, HU

(540)

STAMPERIA

(511)

2 – Paints; oil paints; varnishes, lacquers; pigments; preservatives against rust and against deterioration of wood; colorants; mordants; raw natural resins; purpurin and metals in foil and powder form for painters, decorators, printers and artists; rubber mastic; putties, fixatives; thinners; mediums; paint mixture.

16 – Paper, cardboard, stationery; packing paper; household goods made of paper; rice paper; thermo adhesive rice paper; voile paper; organza paper; cotton paper; corrugated paper; three-dimensional decoupage paper; rice paper napkins; wood pulp paper; printed matter; magazines; catalogues; manuals; bookbinding material; photographs; stationery; adhesives for stationery or household purposes; adhesive tapes; artists' materials; paint brushes (flat brushes, drop-shaped brushes, fan-shaped brushes, circle brushes, brushes with slanting tip, sponge brushes); paint rollers; desk sets; typewriters and office requisites (except furniture); instructional and teaching materials (except apparatus); plastic materials for packaging (not included in other classes) namely envelopes, bags and films; printers' types; printing blocks; stamps; tampons; moulds; transfers (decalcomanias); stencils; engravings; watercolours for wood and paper; glue for stationery or households purposes, paper holder tubes.

41 – Education; providing of training; entertainment; arranging and conducting of courses, competitions, trade fairs and exhibitions, all the aforesaid services rendered also via the Internet.

(260) AM 2015 77231 A

(800) 1053750

(891) 2014 03 21

(731) BOX INTERNATIONAL KFT

Vaci Ucta 81.4 EM, H-1056 BUDAPEST, HU

(540)



(591) Black, white

(511)

2 – Paints; oil paints; varnishes; lacquers; pigments; preservatives against rust and against deterioration of wood; colorants; mordants; raw natural resins; purpurin and metals in foil and powder form for painters, decorators, printers and artists; rubber mastic; putties, fixatives; thinners; mediums; paint mixture.

16 – Paper, cardboard, and goods made from these materials, not included in other classes; packing paper; household goods made of paper; rice paper; thermo adhesive rice paper; voile paper; organza paper; cotton paper; corrugated paper; three-dimensional decoupage paper; rice paper napkins; wood pulp paper; printed matter; magazines; catalogues; manuals; bookbinding material; photographs; stationery; adhesives for stationery or household purposes; artists' materials; paint brushes; sponge brushes; paint rollers; pencils; roller ball pens; pens with synthetic tip; rollerballs; colour markers; highlighter pens; fountain pens; pastels; wax and oil pastels (crayons); black and colour pencils; blackboard and colour chalk; fibre-tipped pens; erasers; oil and acquerello paints; inks; wax; modelling clay; clay; colour modelling paste; engraving inking plates; blackboards; drawing boards; adhesive tapes; desk sets; typewriters and office requisites (except furniture); instructional and teaching materials (except apparatus); plastic materials for packaging (not included in other classes) in the form of envelopes, bags and films; printers' types; printing blocks; stamps; pads; moulds; transfers (decalcomanias); stencils; engravings; watercolours for wood and paper; glue for stationery or households use, paper tubes.

41 – Education; providing of training; entertainment; arranging and conducting of courses, competitions, trade fairs and exhibitions, all the aforesaid services rendered also via Internet.

(260) AM 2015 77232 A

(800) 1053857

(891) 2014 02 21

(731) TECHNOLOGIE ALPINE DE

SECURITE-TAS

Parc d'Activités Alpespace, 74 voie Magellan,

F-73800 SAINTE-HELENE-DU-LAC, FR

(540)

O'Bellx

(511)

9 – Apparatus for triggering avalanches.

(260) AM 2015 77233 A

(800) 1063999

(891) 2014 02 17

(731) KAREN MILLEN FASHIONS LIMITED

The Triangle, Stanton Harcourt Industrial Estate, Stanton Harcourt, Witney, Oxfordshire OW29 5UT, GB

(540)

KAREN MILLEN

(511)

9 – Optical apparatus; sunglasses.

14 – Precious metals and their alloys and goods in precious metals or coated therewith, not included in other classes; jewellery; imitation jewellery; costume jewellery; precious stones; horological and chronometric instruments; watches; straps for watches; cuff links.

18 – Leather and imitation leather and goods made from these materials; bags, handbags.

25 – Articles of clothing, footwear and headgear; belts.

35 – Retail services in connection with the sale of cosmetics and fragrances, perfumery, cologne, toilet water, eau de toilette, aftershave, aftershave balm, perfume, eau de parfum, creams, lotions and powders for the hands, face and body (non-medicated), skin moisturisers (non-medicated toilet preparations), body wash, skin conditioning cream, hand cream, body soaks, body rubs, non-medicated preparations for the hair, shampoo, hair conditioner, mousse (cosmetic), styling gel, anti-perspirants (toilettries) and deodorants for personal use, shower gel, soap, sun screen, bath oil (non-medicated), sunglasses, spectacles, spectacle cases, chains and eyeglass frames, eyeshades, lenses, contact lenses, cameras, cases for cameras, precious metals and their alloys and goods in precious metals or coated therewith, jewellery, imitation jewellery, costume jewellery, precious stones, horological and chronometric instruments, watches, straps for watches, cuff links, leather and imitations of leather, and goods made of these materials, trunks and travelling bags, umbrellas, parasols and walking sticks, handbags, wallets, suitcases, attaché cases, rucksacks, cosmetic bags and cases, purses, textiles and textile goods, bed and table covers, bed linen, plastic coverings for furniture, pillow or cushion covers, curtains of textile, net curtains, mattress covers, upholstery fabrics, woollen fabric, eiderdowns, place mats, coasters (table linen), table linen, table runners, towels of textile, face towels of textile, wall hangings of textile, clothing, footwear, headgear, lingerie, nightwear, underwear, slippers and boots.

(260) AM 2015 77234 A

(800) 1157548

(891) 2014 04 10

(731) FYFE CO. LLC

8380 Miralani Drive, San Diego CA 92126, US

(540)

TYFO

(511)

19 – Construction and civil engineering material in the nature of hybrid fiber/epoxy composites used for retrofitting or repairing structures.

(260) AM 2015 77235 A

(800) 1157549

(891) 2014 04 10

(731) FYFE CO. LLC

8380 Miralani Drive San Diego CA 92126, US

(540)

FIBRWRAP

(511)

19 – Construction and civil engineering material in the nature of hybrid fiber/epoxy composites used for retrofitting or repairing structures.

(260) AM 2015 77236 A

(800) 1160966

(891) 2014 02 27

(731) ITO EN, LTD.

47-10, Honmachi 3-chome, Shibuya-ku, Tokyo 151-8550, JP

(540)

伊藤園

(591) Black, white

(511)

30 – Tea; tea with milk; green tea; Chinese (oolong) tea; jasmine tea; roasted tea; barley tea; brown rice tea; tea beverages; green tea beverages; Chinese (oolong) tea beverages; jasmine tea beverages; roasted tea beverages; barley tea beverages; brown rice tea beverages; coffee; coffee-based beverages; cocoa; cocoa-based beverages.

32 – Carbonated drinks; mineral water beverages; isotonic beverages; fruit juice beverages; whey beverages; vegetable juices beverages.

(260) AM 2015 77237 A

(800) 1183591

(891) 2014 02 18

(731) IRISH DISTILLERS LIMITED

Simmons Court House, Simmons Court Road – Ballsbridge, Dublin 4, IE

(540)



(591) Cream, green, red, black, white and gold
 (554) [X]
 (526) The trademark is protected as a whole. The words Triple Distilled Irish Whiskey, Product of Ireland included therein shall not be subject to independent legal protection.
 (511)
 33 – Distilled spirits; Irish whiskey; alcoholic beverages all containing Irish whiskey; liqueurs.

(260) AM 2015 77240 A
 (800) 1202110
 (891) 2014 02 13
 (731) FIDIA FARMACEUTICI S.p.A.
 ia Ponte della Fabbrica, 3/A, I-35031 ABANO TERME (PD), IT
 (540)

CAMELIV

(511)
 5 – Pharmaceutical and veterinary preparations; sanitary preparations for medical purposes; dietetic food and substances adapted for medical or veterinary use, food for babies; enzyme food supplements and enzyme dietary supplements; dietary supplements for humans and animals; plasters, materials for dressings; material for stopping teeth, dental wax; disinfectants; preparations for destroying vermin; fungicides, herbicides.

(260) AM 2015 77243 A
 (800) 1202176
 (891) 2014 01 28
 (731) RECORD INTERNATIONAL AG
 Allmendstrasse 24, CH-8320 Fehraltorf, CH
 (540)

KOS

(511)
 6 – Metal doors, roller doors of metal; revolving doors of metal; doors of metal for clean rooms and medical rooms; doors of metal for damp rooms; telescope roller doors of metal; fire doors, smoke control doors, radiation shield doors, sound insulating doors (all of metal); metal door frames; substructures of metal for wall panel systems.

7 – Electrical drives for doors.

9 – Sensing and switch systems; sensors.

19 – Doors (not of metal); roller doors (not of metal); revolving doors (not of metal); doors (not of metal) for clean rooms and medical rooms; doors (not of metal) for damp rooms; telescope roller doors (not of metal); fire doors, smoke control doors, radiation shield doors, sound insulating doors (not of metal), door frames (not of metal); wall panels (not of metal), wall panel systems for use in medical rooms and clean rooms, panel systems for

operating rooms, HPL panel systems, substructures (not of metal) for wall panel systems.

37 – Assembling, repair and maintenance of doors and door systems.

(260) AM 2015 77248 A
 (800) 1202244
 (891) 2014 03 14
 (731) BAYER AKTIENGESELLSCHAFT
 Kaiser-Wilhelm-Allee, 51373 Leverkusen, DE
 (540)

myBETAapp

(511)
 44 – Medical services and information for patient support within the framework of the treatment of multiple sclerosis.

(260) AM 2015 77302 A
 (800) 1202911
 (891) 2013 11 06
 (731) Monsieur Robert NAHMANI
 8 rue Léon Vaudoyer, F-75007 PARIS, FR
 (540)

OXYPROLANE

(511)
 3 – Hair lotions; beauty masks; cosmetic products, namely sunscreen products, anti-wrinkle and anti-aging creams; all these goods excluding products for treating acne, skin care products or face cleansers for acne or problem skins, slimming products.

5 – Pharmaceutical products for dermatological use, namely creams for healing and treating burns; dietetic beverages and substances for medical use for anti-aging and anti-wrinkle purposes; dietetic substances for medical use based on proteins, plants, fish, vitamins and mineral salts, including slimming products; food supplements for medical use based on proteins, vitamins, mineral salts, extracts of plants and fish; dietetic substances for non-medical use based on proteins, plants and fish; food supplements for non-medical use based on proteins, extracts of plants and fish; all these products excluding products for treating acne, skin care products or face cleansers for acne or problem skins.

(260) AM 2015 77304 A
 (800) 1202960
 (891) 2014 02 03
 (731) ITX SA
 47 Route des Acacias, CH-1227 Les Acacias, CH
 (540)

ITX

(511)

35 – Personnel assistance and coaching in companies; consulting with regard to personnel; personnel management consultancy; personnel placement services; personnel recruitment; personnel management assistance services; advertisement services for the recruitment of personnel; evaluation of personnel requirements; commercial or industrial management assistance; assistance for commercial or industrial company management; company audits (commercial analyses); business organization advice; business marketing consultancy; relocation services for businesses; business networking services; advertising of commercial or residential real property; information compilation and systematization in computer databases; data search in computer files for others; professional consulting for the organization and administration of means of computer data recording, transcription, conversion, composition, compilation and systematization; analysis of market research data and statistics; interpretation of market research data; arranging of contracts, for others, for the provision of services; corporate strategic planning services.

42 – Design of software, firmware; development, installation and maintenance of software; design and development of software for importing and managing data; configuration, installation, fault diagnosis, repair, upgrading and maintenance of software; computer software consultancy; rental of software; technical consultancy services relating to the application and use of software; consultancy and information services relating to the design, programming and maintenance of software; provision of advice and development services relating to software; provision of temporary use of online non-downloadable software for importing and managing data; software engineering services.

45 – Personal advice to meet the needs of individuals, namely personal development consultancy; matchmaking services (personal services); legal services; legal assistance in the drawing up of contracts; legal services relating to company formation and registration; licensing of computer software (legal services).

(260) AM 2015 77305 A

(800) 1202963

(891) 2013 12 30

(731) Volodymyr Vikentiovych PETRASH

vul. Bilorichenska, bud. 7, kv. 2,

Dnipropetrovsk 49035, UA

(540)



(591) Black, white

(511)

3 – Bleaching preparations and other substances for laundry use; cleaning, polishing, scouring and abrasive preparations; soaps; perfumery, essential oils, cosmetics, hair lotions; dentifrices; breath freshening sprays; balms other than for medical purposes; joss sticks; cotton wool for cosmetic purposes; cotton sticks for cosmetic purposes; cotton disks for cosmetic purposes; cotton pads for cosmetic purposes; cotton rolls for cosmetic purposes; cotton wads for cosmetic purposes; decorative transfers for cosmetic purposes; washing gels; shower gels; gels for intimate hygiene; disinfectant soap; deodorant soap; deodorants for human beings or for animals; depilatory preparations; conditioners for laundry use; cosmetic kits; cosmetic preparations; lotions for cosmetic purposes; detergents other than for use in manufacturing operations and for medical purposes; cleansing milk for toilet purposes; fabric softeners for laundry use; rinsing preparations for laundry use; perfumery and cosmetic preparations for hygiene purposes; air fragrancing preparations; shaving preparations; aloe vera preparations for cosmetic purposes; toiletries; sachets for perfuming linen; tissues impregnated with cosmetic lotions; potpourris (fragrances); swabs (toiletries); facial tonics; shampoo.

5 – Pharmaceutical and veterinary preparations; sanitary preparations for medical purposes; dietetic food and substances adapted for medical or veterinary use, food for babies; dietary supplements for humans and animals; plasters, materials for dressings; material for stopping teeth, dental wax; disinfectants; preparations for destroying vermin; fungicides, herbicides; cotton for medical purposes; menstruation bandages; aseptic cotton; wadding for medical purposes; absorbent cotton; panty liners (sanitary); sanitary napkins; sanitary towels; menstruation knickers; menstruation tampons; sanitary panties; sanitary pads; sanitary tampons; disinfectants for hygiene purposes; deodorants for clothing and textiles; babies' napkin-pants; babies' diaper-pants; diapers (babies' napkins); medicinal cosmetics; air purifying preparations; sulphur sticks (disinfectants); pants, absorbent, for incontinents; napkins for incontinents; diapers for pets; air deodorising preparations; eye-washes.

(260) AM 2015 77306 A

(800) 1202971

(891) 2014 01 10

(731) ORIGINAL PARQUET S.p.A.

Via dell'Artigianato, 18, I-48011

ALFONSINE (RAVENNA), IT

(540)



(591) Black, white
(511)
19 – Wood paving; parquet flooring of wood; parquet flooring of cork; parquet floor boards; parquet flooring and parquet slabs; wood panelling.
27 – Carpet tiles for covering floors.
35 – Retail services of floor coverings in shops, department stores, outlet, as well as on the internet, by mail order; promotion services of exhibitions for commercial and publicity purposes.

(260) AM 2015 77307 A
(800) 1202982
(891) 2014 02 11
(731) Obschestvo s ogranichennoy otvetstvennostiu "PANORAMA"
ul. Borisovskie prudy, 24/2, RU-115612
Moscow, RU

(540)

GREENBET

(591) Black, green, white
(511)
36 – Reward payment services; Internet banking; electronic funds transfer.
41 – Operating lotteries; game betting services; providing casino facilities [gambling]; gaming; entertainment information; club services [entertainment or education]; night clubs; game services provided on-line from a computer network; practical training [demonstration]; organization of exhibitions for cultural or educational purposes; providing recreation facilities; arranging and conducting of workshops [training]; organization of competitions [education or entertainment]; holiday camp services [entertainment]; organization of sports competitions; providing amusement arcade services; rental of show scenery; rental of sports equipment, except vehicles; electronic desktop publishing; publication of electronic books and journals on-line; publication of texts, other than publicity texts; radio entertainment; entertainer services; entertainment; production of shows; services of bookmaker offices [gambling].

(260) AM 2015 77308 A
(800) 1202983
(891) 2014 02 11
(731) Obschestvo s ogranichennoy otvetstvennostiu "PANORAMA"
ul. Borisovskie prudy, 24/2, RU-115612
Moscow, RU

(540)



(591) Black, green, white
(511)
36 – Reward payment services; Internet banking; electronic funds transfer.

41 – Operating lotteries; game betting services; providing casino facilities [gambling]; gaming; entertainment information; club services [entertainment or education]; night clubs; game services provided on-line from a computer network; practical training [demonstration]; organization of exhibitions for cultural or educational purposes; providing recreation facilities; arranging and conducting of workshops [training]; organization of competitions [education or entertainment]; holiday camp services [entertainment]; organization of sports competitions; providing amusement arcade services; rental of show scenery; rental of sports equipment, except vehicles; electronic desktop publishing; publication of electronic books and journals on-line; publication of texts, other than publicity texts; radio entertainment; entertainer services; entertainment; production of shows; services of bookmaker offices [gambling].

(260) AM 2015 77310 A
(800) 1202984
(891) 2014 02 11
(731) Obschestvo s ogranichennoy otvetstvennostiu "PANORAMA"
ul. Borisovskie prudy, 24/2, RU-115612
Moscow, RU

(540)

ГРИНБЕТ

(591) Black, white, green
(511)
36 – Reward payment services; Internet banking; electronic funds transfer.

41 – Operating lotteries; game betting services; providing casino facilities [gambling]; gaming; entertainment information; club services [entertainment or education]; night clubs; game services provided on-line from a computer network; practical training [demonstration]; organization of exhibitions for cultural or educational purposes; providing recreation facilities; arranging and conducting of workshops [training]; organization of competitions [education or entertainment]; holiday camp services [entertainment]; organization of sports competitions; providing amusement arcade services; rental of show scenery; rental of sports equipment, except vehicles; electronic desktop publishing; publication of electronic books and journals on-line; publication of texts, other than publicity texts; radio entertainment; entertainer services; entertainment; production of shows; services of bookmaker offices [gambling].

(260) AM 2015 77311 A
 (800) 1203004
 (891) 2014 03 03
 (731) KEYSIGHT TECHNOLOGIES, INC.
 1400 Fountaingrove Parkway, Santa Rosa
 CA 95403, US
 (540)

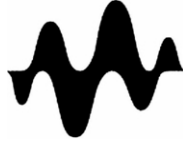

(591) Black, white
 (511)
 37 – Maintenance, repair and installation services relating to electronic, opto-electronic, photonic, and nano-scale test, signaling, analysis, imaging, measurement, scientific, and optical apparatus, instruments, parts, systems, equipment, and accessories; repair and refurbishing of electronic, opto-electronic, photonic, and nano-scale test, signaling, analysis, imaging, measurement, scientific, and optical, apparatus, instruments, parts, systems, equipment, and accessories.

(260) AM 2015 77312 A
 (800) 1203074
 (891) 2014 03 21
 (731) HOLY INTERNATIONAL
 ZI Les Parties, F-01120 MONTLUEL, FR
 (540)

GLOBBER

(511)
 9 – Protective helmets.
 12 – Two-wheeled vehicles, cycles, bicycles, tricycles, scooters, their spare parts and components.
 28 – Roller skates, particularly in-line roller skates; elbow guards, knee guards, ankle guards, knee pads, elbow pads, shin guards; scooters [toys].

(260) AM 2015 77317 A
 (800) 826735
 (891) 2014 02 25
 (731) B.R.
 32 avenue des Champs Elysées, F-75008
 PARIS, FR
 (540)

P 50

(511)
 3 – Soaps; perfumery, essential oils, cosmetics, creams for body and skin care, hair lotions.

(260) AM 2015 77319 A
 (800) 901864
 (891) 2014 03 18

(731) BioGaia AB
 Box 3242, SE-103 64 Stockholm, SE
 (540)

BioGaia

(511)
 29 – Milk, milk based drinks, yoghurt, milk products, dietary supplements in the form of lactic acid bacteria.

(260) AM 2015 77333 A
 (800) 1203129
 (891) 2013 10 18
 (731) GREE ELECTRIC APPLIANCES, INC. OF
 ZHUHAI
 Jinji West Road, Qianshan Zhuhai,
 Guangdong, CN
 (540)

TOSOT

(591) Black, white
 (511)
 7 – Cooking oil presses; meat choppers [machines]; electric dough makers; electromechanical food preparation machines, namely tofu making machines; bean sprout growing machines; sugar cane presses; vegetable washing machines; noodle making machines; dish washers; agitators (mixers) for kitchen use; mixing machines; electric crushers for household use; electric fruit presses for household use; electric food processors; vegetable slicers for household use, electric; meat slicers for household use, electric; soy milk makers for kitchen use; vacuum cleaners; garbage disposals; steam cleaning machines; food waste disposals.

10 – Aesthetic massage apparatus; massage apparatus; medical apparatus and instruments; cases fitted for medical instruments; hearing protectors; hot air therapeutic apparatus; electric blankets for medical use; ultraviolet ray lamps for medical use; lasers for medical use; electric acupuncture instruments; ultrasonic device for medical use; hearing aids.

11 – Lighting apparatus and installations; electric space heaters; electric rice cookers; induction stoves; drinking water dispensers; electric kettles; extractor hoods for kitchens; electric dish sterilizers; electric pressure cookers; water purifying apparatus; electric coffee machines; germicidal lamps for purifying air; ultraviolet ray lamps not for medical use; electric cooking utensils; electric cook tops; kitchen ovens; electric coffee filters; freezers; thermoelectric wine cellars; cooling installations for water; refrigerating containers; ice machines and apparatus; ice cream making machines; air filtering installations; air conditioners for vehicles; gas purifying apparatus; air purifying apparatus and machines; ionization devices for air or water treatment; electric hair driers; electric laundry driers; Turkish baths appa-

ratus; bath tubs; wash-hand basins being parts of sanitary installations; steam facial saunas; desalination equipment; installations for purification of waste water; filters being parts of household or industrial installations; portable foot baths; sterilizers, not for medical purposes; water softening apparatus; oil purifying installations; waste water treatment devices; electric yogurt makers; sterilizing and disinfecting instruments for medical use.

(260) AM 2015 77358 A

(800) 1203452

(891) 2014 01 20

(731) RECKITT BENCKISER N.V.

Siriusdreef 14, NL-2132 WT Hoofddorp, NL

(540)

CILLIT BANG

(511)

3 – Cloths impregnated with a detergent for cleaning, polishing, scouring or bleaching.

5 – Sanitary preparations; disinfectants; disinfectant preparations; disinfectant solutions for use in wiping surfaces; disinfectants for household use or for hygiene or sanitary purposes; disinfecting agents and preparations having disinfecting properties; antibacterial preparations; air freshening or air purifying preparations or substances; fungicides; preparations or substances having sanitary, disinfecting, air freshening, air purifying or fungicidal properties.

21 – Household or kitchen utensils and containers; combs and sponges; brushes (except paint brushes); brooms; carpet sweepers; mops; scrubbing brushes; articles for cleaning purposes; cleaning rags, dusters, cloths for cleaning; steelwool; polishing materials; polishing leather.

(260) AM 2015 77359 A

(800) 1203462

(891) 2014 03 05

(731) VITAL IMAGES, INC.

5850 Opus Parkway, Suite 300, Minnetonka
MN 553434414, US

(540)

VITREAEXTEND

(511)

9 – Computer software, namely, medical imaging software for use by medical professionals to capture, store, retrieve, read, process, manipulate and analyze digital internal images of a human body for use in diagnosing and treating medical conditions.

(260) AM 2015 77360 A

(800) 1203468

(891) 2013 10 09

(731) VERTU CORPORATION LIMITED

Beacon Hill Road, Church Crookham,
Hampshire GU52 8DY, GB

(540)

VERTU

(511)

37 – Building construction; repair; installation services; repair of mobile phones and smart phones.

(260) AM 2015 77361 A

(800) 1203500

(891) 2013 10 25

(731) NINGBO YOURLITE IMPORT & EXPORT
LIMITED COMPANY

Room 404, 5th Building, No:22 Henghe
Road, Beilun District, Ningbo City, Zhejiang
Province, CN

(540)



(591) Black, white

(511)

9 – Transformers [electricity]; converters, electric; switches, electric; light dimmers [regulators], electric; current rectifiers; junction boxes [electricity]; lighting ballasts; voltage surge protectors; low voltage power supply; fuse ware (terms considered too vague by the International Bureau – rule 13.2.b) of the Common Regulations).

11 – Lamps; lighting apparatus and installations; lighters; pocket torches, electric; cooking utensils, electric; cooking apparatus and installations; oil lamps; luminous house numbers; flushing apparatus; sockets for electric lights.

(260) AM 2015 77362 A

(800) 1203509

(891) 2013 11 27

(731) ETI GIDA SANAYI VE TICARET
ANONIM SİRKETİ

Organize Sanayi Bolgesi 11 Cadde,
ESKİSEHIR, TR

(540)



(591) Black, red, orange, brown and white

(511)
30 – Biscuits, chocolates, pastries, crackers, wafers, cakes, pastry and bakery products, chocolate bars, tarts, pies, breakfast cereals, bread, popcorn and rice crisp.

(260) AM 2015 77364 A

(800) 1203540

(891) 2014 02 26

(731) FUJIAN DALIYA GARMENT TECHNOLOGY CO., LTD.

Shenhukeren Industrial Zone, Jinjiang City
Fujian Province, CN

(540)

大力亚

DALIYA

(591) Black, white

(511)

25 – Clothing; layettes (clothing); waterproof clothing; bathing suits; gloves (clothing); shoes; hats; hosiery; neckties.

(260) AM 2015 77365 A

(800) 1203546

(891) 2014 03 03

(731) KEYSIGHT TECHNOLOGIES, INC.

1400 Fountaingrove Parkway, Santa Rosa
CA 95403, US

(540)

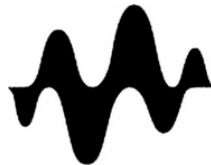

(591) Black, white

(511)

42 – Design and development of computer software; computer programming services; software programming services; software maintenance services; troubleshooting and maintenance of computer software; engineering services; testing, analysis and evaluation of materials; calibration of scientific, electronic, opto-electronic, photonic, and nano-scale test, signaling, analysis, imaging, measurement, and optical, apparatus, instruments, systems, equipment, parts, components, and accessories; technical support services, namely, providing information, consultation, design and diagnostic services in the fields of electronic, opto-electronic, photonic, and nano-scale test, signaling, imaging, and measurement apparatus, instruments, systems, equipment, parts, components and accessories, and providing an Internet website related thereto; technical support services, namely, providing information, start-up assistance, consulting and analysis of test, measurement, and system

requirements, system design, systems integration, and systems installation; computer services, namely, hosting online forums for users to obtain information in the fields of electronic test, signaling and measurement equipment; providing a website that gives users the ability to generate and share software script and plug-ins and to share software and data with other users.

(260) AM 2015 77367 A

(800) 1203582

(891) 2014 04 04

(731) OPEN GARDEN INC.

Bldg. 264, 751 13th St., Treasure Island,
San Francisco CA 94130, US

(540)

FIRECHAT

(511)

9 – Computer application software for mobile phones, computers, netbooks, tablets, wearable devices, and handheld computers, namely, software for voice, text, picture and video messaging.

(260) AM 2015 77368 A

(800) 1203583

(891) 2014 04 02

(731) Shenzhen Oneplus Technology Corp., Ltd.

Room A201, Complex Building of Qianhai,
SZ-HK Cooperation Zone Administration
Bureau, 1 Liyumen Street, 1 Qianwan Road,
Shenzhen, Guangdong, CN

(540)



(591) Black, white

(511)

9 – Computer peripheral devices; computer software, recorded; laptop computers; computer game programs; phototelegraphy apparatus; weighing apparatus and instruments; electronic notice boards; telephone apparatus; portable telephones; satellite navigational apparatus; cabinets for loudspeakers; television apparatus; DVD players; portable media players; headphones; surveying apparatus and instruments; cameras [photography]; optical apparatus and instruments; telephone wires; materials for electricity mains [wires, cables]; integrated circuits; plugs, sockets and other contacts [electric connections]; connections, electric; light conducting filaments [optical fibers [fibres]]; protection devices for personal use against accidents; theft prevention installations, electric; eyeglasses; galvanic cells; battery chargers.

(260) AM 2015 77372 A
 (800) 1203623
 (891) 2014 02 04
 (731) PHILIP MORRIS BRANDS SÀRL
 Quai Jeanrenaud 3, CH-2000 Neuchâtel, CH
 (540)



(591) Black, white
 (526) The trademark is protected as a whole. The word "SELECTED PREMIUM TOBACCOS" included therein shall not be subject to independent legal protection.
 (511)
 34 – Tobacco, raw or manufactured; tobacco products, including cigars, cigarettes, cigarillos, tobacco for roll-your-own cigarettes, pipe tobacco, chewing tobacco, snuff tobacco, kretek; snus; tobacco substitutes (not for medical purposes); smokers' articles, including cigarette paper and tubes, cigarette filters, tobacco tins, cigarette cases and ashtrays, pipes, pocket apparatus for rolling cigarettes, lighters; matches.

(260) AM 2015 77373 A
 (800) 1203625
 (891) 2014 02 04
 (731) PHILIP MORRIS BRANDS SÀRL
 Quai Jeanrenaud 3, CH-2000 Neuchâtel, CH
 (540)



(591) Black, white
 (526) The trademark is protected as a whole. The word "SELECTED PREMIUM TOBACCOS" included therein shall not be subject to independent legal protection.
 (511)
 34 – Tobacco, raw or manufactured; tobacco products, including cigars, cigarettes, cigarillos, tobacco

for roll-your-own cigarettes, pipe tobacco, chewing tobacco, snuff tobacco, kretek; snus; tobacco substitutes (not for medical purposes); smokers' articles, including cigarette paper and tubes, cigarette filters, tobacco tins, cigarette cases and ashtrays, pipes, pocket apparatus for rolling cigarettes, lighters; matches.

(260) AM 2015 77374 A
 (800) 1203630
 (891) 2013 12 04
 (731) Union des Associations Européennes de Football (UEFA)
 Route de Genève 46, CH-1260 Nyon, CH
 (540)



(591) Black, white, grey
 (511)
 4 – Lubricants; engine oils and fuels, including gasoline, diesel oil, gases and bio-fuels; candles; waxes; greases; natural gas; liquid gases; industrial oils and greases; lubricating oils and greases; carburants; liquefied petroleum gas; non-chemical additives for fuel, lubricants and greases; dust absorbing, wetting and binding compositions; lighting fuel; lubricants, oils and greases, and lubricating preparations for industrial use; cutting oils for industrial purposes; milling oils; all the aforementioned goods specifically from France.

9 – Exposed films, slides, video game disks; software (recorded programs), including game software; computer databases and programs; video game accessories; recorded or downloaded sounds, images or data; videotapes, magnetic tapes, magnetic disks, DVDs, mini-disks, diskettes, optical discs, compact discs, CD-ROMs, videodiscs, memory cards, USB flash drives, blank or prerecorded with music, sound or images (possibly including animated cartoons); holograms; electronic publications provided by means of CD-ROMs, databases and the Internet; spectacles, sunglasses, diving and swimming goggles; cases, cords and chains for sunglasses and spectacles; binoculars; magnets and decorative magnets; directional compasses; apparatus for the recording, transmission and reproduction of sound and images; satellite dishes; decoders, namely electronic hardware and software enabling the converting, providing and transmitting of sound and visual data; television sets; flat screens, liquid crystal display screens, high-definition screens and plasma screens; radios; home

cinema systems; video recorders; CD players; DVD drives; MP3 players; cassette players; mini disk players; digital music players; loudspeakers; headphones, earphones; computers, including laptop computers and electronic tablets; karaoke systems; systems for editing sounds and for mixing sounds; systems for editing video images, and for mixing video images; apparatus for computer data processing; computer keyboards; computer screens; modems; accessories for computers included in this class; computer mice, mouse pads; navigation systems; personal digital assistants (PDAs); electronic pocket translators; dictating machines; electronic agendas; scanners; printers; photocopiers; facsimile machines; telephones; answering machines; video telephones; cellular telephones; accessories for cellular telephones, included in this class, namely cases for cellular telephones, hands-free kits for cellular telephones, earphones and headsets for cellular telephones, keypads for cellular telephones, lanyards for cellular telephones, special cases for carrying cellular telephones, photographic cameras and video cameras integrated in cellular telephones; remote controls for television sets and video systems; teleconferencing systems; calculating machines; card readers for credit cards; currency converting machines; automated teller machines; video cameras, portable video cameras with built-in videocassette recorders (camcorders); photographic equipment, photographic apparatus, cameras (cinematographic apparatus), projectors, flash lamps, special cases and cords for photographic apparatus and instruments, electric cells and batteries; screen saver programs for computers; magnetic, digital or analog recording media, recorded or not, for sounds or images; magnetic cards (encoded); memory cards; integrated circuit cards (smart cards); microchip or magnetic credit cards, microchip or magnetic telephone cards, microchip or magnetic cards for cash dispensers, microchip or magnetic cards for automated teller machines and money exchange machines, prepaid microchip or magnetic cards for cellular telephones, microchip or magnetic travel and show admission cards, microchip or magnetic check guarantee cards and microchip or magnetic debit cards; alarms; wind socks (for indicating wind direction); distance measuring equipment; equipment for measuring and displaying speed; gloves for protection; audio receivers, sound amplifiers; television tubes; cathode ray tubes; decoders, namely computer software and hardware capable of converting, supplying and transmitting audio and video data; disk drives for computers; protected semi-conductors; integrated circuits containing programs for processing audio, visual or computer data; rechargeable batteries; audio and video data processors and converters; cables for data transmission; payment apparatus for electronic commerce; protective helmets for sports; magnetic encoded identification bracelets; electronic instrument assemblies; fuel/air coefficient analyzers;

remote control devices for locking cars; photovoltaic cells; video game cassettes; all the aforementioned goods specifically from France.

12 – Bicycles, motorcycles, motor cars, trucks, vans, utility vehicles, buses, camper vans, refrigerated vehicles; airplanes and boats; air balloons, dirigible balloons [airships]; vehicle accessories, namely sun visors, pneumatic tires, tire covers, luggage racks, ski racks, rims and hub caps for wheels; seat linings, vehicle covers, baby carriages, strollers, safety seats for infants and children (for vehicles); engines and motors for land vehicles; safari bars; headlamp covers; steering wheels for vehicles; trailers; all the aforementioned goods specifically from France.

14 – Jewelry, necklaces; jewelry products; watches; wristwatches, clocks; chronographs; wall clocks; medallions, pendants, brooches; bracelets; pins (jewelry); lapel pins (jewelry); tie clips and tie pins; cuff links; commemorative medals of precious metal; prize cups, commemorative plates, trophies, statues, sculptures, all of precious metal; decorative hat pins, key rings (trinkets or fobs), printed metal disks for collection purposes (pogs), all made of precious metals; decorative key holders; coins; medals for clothing; cases for watches; badges of precious metal; alarm clocks; badges and pins (jewelry); leather bracelets; bracelets of plastic materials; ornamental key rings of plastic materials; ornament pins for hats not of precious metal; all the aforementioned goods specifically from France.

16 – Coloring and drawing books; activity books; magazines; newspapers; books and journals, including those concerning sportsmen, sportswomen or sports events; bookmarks; printed teaching material; score sheets; event programs; albums for events; photograph albums; autograph books; printed timetables; pamphlets; collectible photographs of players; bumper stickers, stickers, scrapbooks, sticker albums; posters; photographs; tablecloths of paper; paper napkins; paper bags; invitation cards; greeting cards; gift wrapping paper; coasters and place mats of paper; garbage bags of paper or of plastics; food wrapping paper; small bags for preserving foodstuffs; coffee filters of paper; labels (not of textile); towels of paper; wet hand-wipes of paper; toilet paper; napkins for removing make-up; handkerchief boxes of paper and cardboard; tissues of paper; stationery and instructional and teaching material (except apparatus); typewriter paper; copying paper; envelopes; notepads; folders for papers; tissue paper; writing books; paper sheets for note-taking; writing paper; binder paper; files; covering paper; luminous paper; adhesive paper for notes; paperweights; crêpe paper; tissue paper; badges or insignia of paper; flags of paper; pennants (flags) of paper; writing instruments; fountain pens; pencils; ballpoint pens; ball-point pen and pencil sets; felt-tip pens (marking pens); fiber-tip pens and felt-tip pens; marking pens;

ink, inking pads, rubber stamps; typewriters (electric or non-electric); lithograph prints, lithographic works of art; paintings (pictures), framed or unframed; paint boxes, paints and colored pencils; chalks; pencil ornaments [stationery]; printing blocks; address books; diaries; personal organizers of paper; road maps; tickets, entry tickets; checks; comic books; calendars; postcards; advertising boards, banners and material included in this class; transfers [decalcomanias]; sticking labels; office requisites (except furniture); correction fluids; rubber erasers; pencil sharpeners; paper clips; thumbtacks; rulers; adhesive tapes for stationery purposes, adhesive tape dispensers; staples; stencils; document holders (stationery); paper-clips; holders for notepads; bookends; stamps (seals); postage stamps; credit cards, telephone cards, ATM cards, cards for traveling and for shows, check guarantee cards and debit cards, non-magnetic, and of paper or cardboard; baggage tags of paper; passport cases; travelers' checks; holders for checkbooks; money clips of metal; letter trays; identity card holders; all the aforementioned goods specifically from France.

18 – Leathers and imitation leathers; thongs [straps] of leather; umbrellas, parasols; sports bags (other than those adapted for products they are designed to contain); leisure bags; travel bags, backpacks; school bags; bags for hanging on belts; handbags, leather bags; beach bags; garment bags; suitcases; document holders; belts for suitcases; briefcases (leather goods); unfitted vanity cases; toiletry sets; key cases (leather goods); wallets; purses (coin purses); business card cases; whips; collars for animals; luggage tags of leather; all the aforementioned goods specifically from France.

25 – Clothing; shoes and footwear; headgear; shirts; knitwear (clothing); pullovers; slipovers; Tee shirts; vests; singlets; sleeveless jerseys, dresses; skirts; underwear; swimsuits; bath robes; shorts; trousers; sweaters; caps; caps [headwear]; hats; sashes for wear; scarves, shawls; caps with visors; tracksuits; sweatshirts; jackets, sports jackets, stadium jackets (bibs); blazers; waterproof clothing; coats; uniforms; neckties; bandanas; wrist bands; headbands; gloves; aprons; bibs (not of paper); pajamas; play suits for infants and children; socks and stockings; garters; belts; suspenders; all the aforementioned goods specifically from France.

28 – Games and toys; sports balls; play balloons; board games; tables for indoor football; dolls and plush toys; vehicles (toys); jigsaw puzzles; balloons; inflatable toys; play disks (pogs); playing cards; confetti; articles for gymnastics and sports; football equipment, namely balls for football, gloves, knee guards, elbow guards, shoulder guards, shin guards; football goals; sports bags and containers (adapted to objects) for carrying sports articles; party hats (toys); small electronic games designed for use with a tele-

vision set; apparatus for video games; game consoles; video game apparatus; electronic games other than those designed to be used only with a television set; steering wheels for video games and mats for video games (for dancing upon); hands made of rubber or foam (toys); entertainment robots; appliances for gymnastics; kites; roller skates; scooters [toys]; skateboards; arcade games; electronic games with liquid crystal display; lottery tickets; scratch cards; joysticks, voice-activated or manually operated joysticks; all the aforementioned goods specifically from France.

29 – Meat; fish; poultry; game; meat extracts; canned fish and meat; cooked fruits and vegetables; canned fruits and vegetables; edible oils and fats; potato chips; French fries; prepared walnuts; jams; marmalades and jellies; milk; milk products (milk predominating), dairy products; cheeses; soya milk (milk substitute); all the aforementioned goods specifically from France.

30 – Coffee; tea; cocoa; chocolates; sugar; honey; coffee substitutes; flour; cereal preparations; cereals; bread; pastry; pastes (pastry); pasta (for food); cakes; biscuits, cookies; crackers; candy; edible ices; confectionery; rice; dried cereal flakes; mustard; vinegar; sauces (condiments); spices; salt; honey, molasses, yeast, salt, mustard, vinegar or spices; products with added vitamins for culinary use and food additives for culinary use based on coffee, tea, cocoa, sugar, rice, tapioca, sago, flour or cereal preparations, honey, molasses, yeast, salt, mustard, vinegar or spices; salt and salt-based products for preserving foodstuffs; sandwiches, cheeseburgers, pizzas; all the aforementioned goods specifically from France.

32 – Non-alcoholic beverages; syrups and powders for making non-alcoholic beverages; mineral and aerated waters; isotonic beverages; fruit and vegetable beverages; fruit and vegetable juices; frozen fruit beverages; beers; strong dark beers; lagers and ales; non-alcoholic or low-alcohol beers; all the aforementioned goods specifically from France.

35 – Employment agencies; personnel recruitment; advertising services; services provided by an agency publishing advertising texts; advertising agency services; advertising agency services on a global computer network (the Internet) or via wireless electronic communication devices; dissemination of advertisements; rental of advertising space; rental of advertising time in film credits; television advertising, radio advertising; advertising in the form of animated cartoons; promotion agency services, promotion agency services for sports and public relations; promotion of football events; market study services; market research services; opinion polling services; organization of exhibitions for commercial or advertising purposes; organization of advertising for trade

fairs; compilation and systematization of data in data banks; data bank management services; compilation of statistics; advertising for sports events in the field of football; retail sale services for and bringing together of various goods for the benefit of others (excluding the transport thereof), namely clothing, footwear, headgear, sports articles, stationery, apparatus for recording, transmission and reproduction of sound and images, books, newspapers, magazines, publications, video games, toys, dolls, badges of all kinds, key rings, watches and jewelry, souvenir items in connection with football, bags, luggage, briefcases, umbrellas, flags and pennants, alcoholic and non-alcoholic beverages, confectionery, medical apparatus and instruments, vehicles and accessories for motor cars; retail sale services for solvents, paraffin, waxes, bitumen and petroleum; bringing together of the following goods for the benefit of others (excluding transport thereof) to enable customers to conveniently view and purchase these goods in a store or on a global computer network (the Internet) or via wireless electronic communication devices, namely clothing, footwear, headgear, sports articles, stationery, apparatus for recording, transmission and reproduction of sound and images, books, newspapers, magazines, publications, video games, toys, dolls, badges of all kinds, key rings, tickets, watches and jewelry, souvenir items in connection with football, bags, luggage, briefcases, umbrellas, flags and pennants, alcoholic and non-alcoholic beverages, confectionery, medical apparatus and instruments, vehicles and accessories for motor cars; advertising and promotion services, information services with regard to advertising and promotion, commercial information agencies, all the aforesaid services provided on-line from a computer database or via a global computer network (the Internet) or via wireless electronic communication devices; design and compilation of advertisements for use as a web site on a global computer network (the Internet) or via wireless electronic communication devices; provision of space on web sites, for advertising of goods and services; auctioneering on a global computer network (the Internet) or via wireless electronic communication devices; collection of directories for publication on the Internet and on a wireless electronic communication network; business administration services for processing commercial services on a global computer network (Internet) or via wireless electronic communication devices; compilation, creation and management of databases, namely collection of domain names in a register; promotion of sales, namely creation of preferential programs for customers; implementation of bonus programs for customers in stadiums by distributing encoded loyalty and membership cards able to contain the personal data of the user; development, launch and administration of loyalty programs, namely issuing loyalty cards to fans, conta-

ining personal information on the identity of the card holder; electronic commerce (e-commerce) services, namely provision of information on goods via telecommunication networks for advertising or sales purposes; compilation of data into a computer database, especially still or animated images; e-commerce services, namely online services for providing contracts for the purchase and sale of goods on behalf of others; promotion of football-related sports events; promotion of the goods and services of others, through contractual agreements, particularly partnership (sponsoring) and licensing agreements, providing them with increased notoriety and enhanced image derived from cultural and sporting events, particularly international events; compilation and recording of data and information on sporting performances; provision of personnel, particularly for selling beverages and foods; promotion of football events; retail sale of interactive educational and entertainment products, interactive compact disks, CD-ROMs and computer games; retail sale services, particularly on a global computer network, of interactive entertainment and education products, interactive compact disks, CD-ROMs and computer games; presentation of computer programs for retail sale purposes; procurement services for others [purchasing goods and services for other businesses]; procurement services for others [purchasing goods and services for other businesses] for entertainment or sports events; promotion of the goods and services of others via contractual agreements, particularly partnerships (sponsoring) and licenses, providing them with increased notoriety and/or image and/or affinity derived from cultural and sporting events, particularly international events; financial sponsorship search for football competitions.

36 – Issuance and management of credit cards and travelers' checks; financial services; banking, credit and investment services; insurance underwriting; hire-purchase financing; hire-purchase services; financial sponsorship of sports events; information services related to finance and insurance, provided online from a computer database or the Internet or on wireless electronic communication networks; home banking services; banking services over the Internet or over wireless electronic communication networks; payment services, including services provided on-line from a computer database or via the Internet or via mobile telephones; safe deposit services; issue of vouchers, namely issue of loyalty cards to fans, which contain personal data on the identity of the cardholder and are used for access control at sports stadiums; financial promotion of in the field of football; financial payment services for electronic commerce, namely transfer of funds, all via electronic communication networks; financial payment services for electronic commerce in connection with the purchase of goods and services provided by others, all via electronic communication

networks, and clearing and settlement of financial transactions via electronic communication networks; issue of vouchers in the form of travel vouchers.

38 – Telecommunication services; communication by mobile telephones; communication by telex; communication via electronic computer terminals linked to telecommunications networks, data banks and the Internet or via wireless electronic communication devices; communication by telegraphs; communication by telephones; communications by facsimile; paging services; telephone or video conferencing services; television broadcasting; broadcasting of cable television programs; broadcasting of radio programs; radio and television broadcasting of sports and sporting events; news and press agency services; other message transmission services; rental of telephones, facsimile machines and other telecommunication apparatus; transmission of commercial Internet pages online or via wireless electronic communication devices; services for transmitting and broadcasting television and radio programs provided via the Internet or via any wireless electronic communication network; electronic transmission of messages; simultaneous broadcasting of film recordings and sound and video recordings; provision of access to telematic servers and real-time chat forums; computer-aided transmission of messages and images; telecommunication via fiber-optic networks; provision of access to a global computer network or interactive communication technologies for access to private and commercial purchasing and ordering services; transmission of information and other data via websites and computers; transmission of information (including sites by data transmission means) via telecommunication, computer programs and other data; transmission of information, computer programs and other data by data transmission means; electronic mail services; provision of access via the Internet or on any wireless electronic communication network (telecommunication services); providing connections for telecommunications with a global computer network (the Internet) or data banks; provision of access to websites offering digital music on the Internet by means of a global computer network or via wireless electronic communication devices; rental of access time to MP3 websites on the Internet, via a global computer network or via wireless electronic communication devices; rental of access time to a database server center (telecommunication services); rental of access time to a computer database (telecommunication services); transmission of digital music by telecommunications; online transmission of electronic publications; digital music transmission via the Internet or on any wireless electronic communication network; digital music transmission via MP3 Internet sites; simultaneous broadcasting and/or netcasting of film recordings and sound and video recordings (telecommu-

nications); simultaneous broadcasting and/or netcasting of interactive educational and entertainment products, interactive compact disks, CD-ROMs, computer programs and computer games (telecommunications); provision of access to blackboards (notice and advertisement boards) and chat rooms in real time via a global computer network; rental and provision of access time to blackboards (boards for displaying information and advertisements) and to chat rooms in real time by means of a global computer network (communication services); telecommunication services dedicated to retail sale by means of interactive communications with customers; multimedia telecommunication; transmission of videotext and teletext; information transmission via communication satellite, microwave or by electronic, digital or analog means; transmission of digital information by cable, wire or fiber; transmission of information by mobile telephones, telephones, fax machines and telex; telecommunication services for receiving and exchanging information, messages, images and data; telecommunication services for setting up discussion groups on the Internet and on any wireless electronic communication network; provision of access to search engines for obtaining data and information on global networks.

39 – Operating travel agencies, namely travel arrangement and reservations; ticket reservation and information services for travel; transport by airplane, railway, bus and truck; boat transport; boat travel services; tourist travel services; vehicle rental; rental of parking spaces; taxi services; boat transport services for goods; distribution of water, heat, gas or electricity; distribution of newspapers, magazines and books; postal services, mail delivery and courier services; storage of goods; delivery of solvents, paraffins, waxes, bitumens and oil products, excluding liquid gas; distribution (delivery) of films and sound and image recordings; distribution (delivery) of interactive educational and entertainment products, interactive compact disks, CD-ROMs, computer programs and computer games; advice relating to power and electricity distribution.

41 – Education; training; entertainment; organization of lotteries, raffles and competitions; betting and gaming services in connection with sports; services involving placement and hospitality (sports, entertainment), namely providing entry tickets and information brochures for sports for VIPs, as well as guiding and gathering VIPs during sports or entertainment events; services involving placement and hospitality, namely client hospitality (entertainment services), including providing access tickets during sports or entertainment events; entertainment services relating to sporting events; entertainment services in the form of public gatherings during the transmission of sports events; sporting and cultural activities; organization of sporting and cultural

events and activities; organization of sports competitions; organization of events in the field of football; sports camp services; operation of sports facilities; rental of video and audiovisual installations; production, presentation, distribution and/or rental of film recordings and sound and video recordings; presentation, distribution and/or rental of interactive educational and entertainment products, interactive compact disks, CD-ROMs, and computer games; radio and television coverage of sporting events; production services for radio, television programs and video films; ticket reservation services and information services for sports or entertainment events; sports events timing services; organization of beauty contests; interactive entertainment; on-line betting and gaming services on the Internet or on any wireless electronic communication network; information in the field of entertainment (including in the field of sports), provided on-line from a computer database or via the Internet or via any wireless electronic communication network; electronic game services transmitted via the Internet or on mobile telephones; book publishing; publication of books and electronic journals on-line; audio and video recording services; production of animated cartoons for movies, production of animated cartoons for television; rental of sound and image recordings for entertainment purposes; information in the field of education provided on-line from a computer database or via the Internet or any wireless electronic communication network; translation services; photography services; provision of entertainment infrastructure; ticket agencies in connection with sports events.

43 – Providing food and drink, snack-bars; hospitality services, namely providing of food and drink; food and drink catering; hotel services; providing accommodation and food and drink, booking hotels and temporary accommodation; reception services, namely providing of food, namely providing of food and drink during sports or entertainment events.

(260) AM 2015 77379 A

(800) 1203660

(891) 2014 03 19

(731) ŠKODA AUTO a.s.

Tr. Václava Klementa 869, CZ-293 60 Mladá Boleslav, CZ

(540)

S-BREAK

(511)

12 – Automobiles and their parts, all included in this class.

(260) AM 2015 77380 A

(800) 500460

(891) 2013 12 18

(731) ASTELLAS PHARMA EUROPE B.V.

Sylviusweg 62, NL-2333 BE Leiden, NL

(540)

CONDYLINE

(511)

5 – Pharmaceutical preparations and medicines for human use.

(260) AM 2015 77381 A

(800) 659891

(891) 1993 12 18

(731) ASTELLAS PHARMA EUROPE B.V.

Sylviusweg 6,2 NL-2333 BE Leiden, NL

(540)

КОНДИЛИН

(511)

5 – Pharmaceutical preparations and medicines for human use.

(260) AM 2015 77382 A

(800) 687422

(891) 2014 05 02

(731) PARFUMS CHRISTIAN DIOR

33 avenue Hoche, F-75008 PARIS, FR

(540)

J'ADORE

(511)

3 – Bleaching preparations and other substances for laundry use; cleaning, polishing, scouring and abrasive preparations; soaps; perfumery, essential oils, cosmetics, hair lotions; dentifrices.

25 – Clothes, shoes, headwear.

(260) AM 2015 77384 A

(800) 970928

(891) 2014 03 26

(731) SOCIÉTÉ DES PRODUITS NESTLÉ S.A.

CH-1800 Vevey, CH

(540)

ALFARÉ

(511)

5 – Dietetic substances and foodstuffs for clinical and medical use; formulated milk for babies, food and food substances for babies; food and food substances for medical use for children and the sick; foods and food substances for nursing mothers for medical use; nutritional and dietetic supplements for medical use; vitamin preparations, preparations made with minerals; dietetic confectionery products for medical use.

29 – Milk and milk products; milk substitutes; milk beverages, with milk predominating; soya milk (milk substitutes).

(260) AM 2015 77386 A
 (800) 1037823
 (891) 2014 03 19
 (731) Festina – Candino Watch AG
 (Festina – Candino Watch SA) (Festina –
 Candino Watch Ltd)
 Hauptstrasse 136, CH-4715 Herbetswil, CH
 (540)



(591) Black, white
 (511)
 14 – Precious metals and their alloys and key rings
 (trinkets or fobs) of precious metals or coated there-
 with; jewelry and precious stones; timepieces and
 chronometric instruments and their parts included in
 this class.

(260) AM 2015 77389 A
 (800) 1178380
 (891) 2014 03 27
 (731) NOVARTIS AG
 CH-4002 Basel, CH
 (540)

ZYKADIA

(511)
 5 – Pharmaceutical preparations for use in oncology,
 hematology and tissue and organ transplantation.

(260) AM 2015 77392 A
 (800) 1186551
 (891) 2014 03 05
 (731) ASTEOS EOOD
 15 Trakia Str., Sofia, BG
 (540)

RICH SENSATION

(511)
 34 – Tobacco; smokers' articles; matches.

(260) AM 2015 77393 A
 (800) 1203700
 (891) 2014 04 01
 (731) B.I.G. Floorcoverings, naamloze
 vennootschap
 Rijksweg 442, B-8710 Wielsbeke, BE
 (540)



(591) Red, white and black
 (511)
 1 – Chemicals used in industry, science and photog-
 raphy, as well as in agriculture, horticulture and fo-

restry (excluding fungicides and herbicides and ver-
 min destroying preparations); unprocessed plastics.

24 – Textiles and textile goods, not included in other
 classes; bed covers and table covers.

(260) AM 2015 77394 A
 (800) 1203703
 (891) 2013 12 18
 (731) Obshchestvo s ogranichennoy
 otvetstvennostyu "PARAFARM"
 ul. Sverdlova, d. 4, RU-440026 g. Penza, RU
 (540)



(591) White, black, red, light red, dark red, gray and
 orange

(526) The trademark is protected as a whole. The
 word "R" included therein shall not be subject to
 independent legal protection.

(511)
 5 – Acaricides; aconitine; alkaloids for medical pur-
 poses; alginates for pharmaceutical purposes; algici-
 des; aldehydes for pharmaceutical purposes; dental
 amalgams of gold; dental amalgams; amino acids for
 veterinary purposes; amino acids for medical purpo-
 ses; analgesics; anaesthetics; antibiotics; antiseptics;
 medicine cases, portable, filled; first-aid boxes, fil-
 led; aluminium acetate for pharmaceutical purposes;
 acetates for pharmaceutical purposes; germicides;
 balms for medical purposes; bandages for dressings;
 biologically active additives; biocides; bracelets for
 medical purposes; anti-rheumatism bracelets; bromi-
 ne for pharmaceutical purposes; paper for mustard
 plasters; fly catching paper; mothproofing paper;
 petroleum jelly for medical purposes; vaccines; oxy-
 gen baths; antiseptic cotton; aseptic cotton; absor-
 bent cotton; wadding for medical purposes; cotton
 for medical purposes; dietetic substances adapted for
 medical use; radiological contrast substances for
 medical purposes; nutritive substances for microor-
 ganisms; radioactive substances for medical purpo-
 ses; bismuth subnitrate for pharmaceutical purposes;
 melissa water for pharmaceutical purposes; sea
 water for medicinal bathing; mineral waters for medi-
 cal purposes; thermal water; dietary fiber; molding
 wax for dentists; gases for medical purposes; guaia-
 col for pharmaceutical purposes; hematogen; hemo-
 globin; hydrastine; hydrastinine; glycerine for medi-
 cal purposes; glycerophosphates; glucose for medi-
 cal purposes; gentian for pharmaceutical purposes;
 hormones for medical purposes; mustard for phar-
 maceutical purposes; mustard plasters; mud for
 baths; medicinal mud; gamboge for medical purpo-

ses; gurjun [gurjon, gurjan] balsam for medical purposes; air deodorising preparations; deodorants, other than for human beings or for animals; deodorants for clothing and textiles; diastase for medical purposes; digitalin; mineral food supplements; nutritional supplements; albumin dietary supplements; dietary supplements for animals; alginate dietary supplements; glucose dietary supplements; casein dietary supplements; lecithin dietary supplements; linseed oil dietary supplements; propolis dietary supplements; protein dietary supplements; protein supplements for animals; royal jelly dietary supplements; pollen dietary supplements; wheat germ dietary supplements; linseed dietary supplements; enzyme dietary supplements; yeast for pharmaceutical purposes; gelatine for medical purposes; cod liver oil; isotopes for medical purposes; insecticides; iodine for pharmaceutical purposes; iodides for pharmaceutical purposes; alkaline iodides for pharmaceutical purposes; iodoform; calomel; cream of tartar for pharmaceutical purposes; tartar for pharmaceutical purposes; camphor for medical purposes; capsules for medicines; cachets for pharmaceutical purposes; hemostatic pencils; wart pencils; caustic pencils; carbolineum [parasiticide]; headache pencils; caustics for pharmaceutical purposes; cachou for pharmaceutical purposes; quassia for medical purposes; quebracho for medical purposes; oxygen for medical purposes; gallic acid for pharmaceutical purposes; acids for pharmaceutical purposes; adhesives for dentures; stem cells for veterinary purposes; stem cells for medical purposes; cocaine; colloidion for pharmaceutical purposes; corn rings for the feet; anti-rheumatism rings; candy, medicated; angostura bark for medical purposes; barks for pharmaceutical purposes; cedar wood for use as an insect repellent; condurango bark for medical purposes; croton bark; mangrove bark for pharmaceutical purposes; myrobalan bark for pharmaceutical purposes; quinquina for medical purposes; medicinal roots; rhubarb roots for pharmaceutical purposes; lint for medical purposes; starch for dietetic or pharmaceutical purposes; creosote for pharmaceutical purposes; blood for medical purposes; cultures of microorganisms for medical and veterinary use; curare; dental lacquer; liquorice for pharmaceutical purposes; lactose for pharmaceutical purposes; candy for medical purposes; adhesive plasters; medicines for alleviating constipation; adhesive tapes for medical purposes; lecithin for medical purposes; lotions for veterinary purposes; dog lotions; lotions for pharmaceutical purposes; personal sexual lubricants; lupulin for pharmaceutical purposes; magnesia for pharmaceutical purposes; liniments; ointments for pharmaceutical purposes; sunburn ointments; frostbite salve for pharmaceutical purposes; mercurial ointments; gauze for dressings; medicinal oils; mustard oil for medical purposes; camphor oil for medical purposes; castor oil for medical purposes; oil of turpentine for

pharmaceutical purposes; dill oil for medical purposes; dental mastics; dental abrasives; dental impression materials; teeth filling material; dressings, medical; surgical dressings; drugs for medical purposes; medicines for veterinary purposes; serotherapeutic medicines; medicines for human purposes; medicines for dental purposes; menthol; medicinal drinks; moleskin for medical purposes; milk of almonds for pharmaceutical purposes; royal jelly for pharmaceutical purposes; milk ferments for pharmaceutical purposes; Irish moss for medical purposes; flour for pharmaceutical purposes; linseed meal for pharmaceutical purposes; fish meal for pharmaceutical purposes; fly glue; mint for pharmaceutical purposes; dietetic beverages adapted for medical purposes; malted milk beverages for medical purposes; narcotics; medicinal infusions; tincture of iodine; eucalyptol for pharmaceutical purposes; tinctures for medical purposes; opium; opodeldoc; decoctions for pharmaceutical purposes; antiparasitic collars for animals; stick liquorice for pharmaceutical purposes; sulphur sticks [disinfectants]; pastilles for pharmaceutical purposes; pectin for pharmaceutical purposes; pepsins for pharmaceutical purposes; peptones for pharmaceutical purposes; hydrogen peroxide for medical purposes; food for babies; leeches for medical purposes; blood plasma; medical plasters; eye-patches for medical purposes; poultices; compresses; scapulars for surgical purposes; diapers [babies' napkins]; breast-nursing pads; bunion pads; pomades for medical purposes; powder of cantharides; pyrethrum powder; belts for sanitary napkins [towels]; anti-uric preparations; bacterial preparations for medical and veterinary use; bacteriological preparations for medical and veterinary use; balsamic preparations for medical purposes; albuminous preparations for medical purposes; biological preparations for veterinary purposes; biological preparations for medical purposes; veterinary preparations; bismuth preparations for pharmaceutical purposes; vitamin preparations; diagnostic preparations for medical purposes; therapeutic preparations for the bath; hemorrhoid preparations; preparations for callouses; preparations to facilitate teething; preparations for the treatment of burns; fumigation preparations for medical purposes; opotherapy preparations; air purifying preparations; eye-washes; bronchodilating preparations; preparations for reducing sexual activity; sterilising preparations; soil-sterilising preparations; corn remedies; pharmaceutical preparations for treating dandruff; preparations for destroying noxious animals; herbicides; preparations for destroying dry rot fungus; larvae exterminating preparations; fly destroying preparations; preparations for destroying mice; slug exterminating preparations; vermin destroying preparations; pharmaceutical preparations for skin care; contact lens cleaning preparations; preparations of lime for pharmaceutical purposes; bath preparations, medicated; medicinal hair growth

preparations; opiates; anticryptogamic preparations; aloe vera preparations for pharmaceutical purposes; preparations of trace elements for human and animal use; sulphonamides [medicines]; pharmaceutical preparations; sunburn preparations for pharmaceutical purposes; enzyme preparations for veterinary purposes; enzyme preparations for medical purposes; chemico-pharmaceutical preparations; chemical preparations for medical purposes; chemical preparations for the diagnosis of pregnancy; chemical preparations for medical purposes; chemical preparations to treat wheat blight [smut]; vine disease treating chemicals; chemical preparations to treat mildew; chemical preparations for treating phylloxera; chemical preparations for pharmaceutical purposes; mothproofing preparations; collyrium; lead water; chemical conductors for electrocardiograph electrodes; albuminous foodstuffs for medical purposes; dietetic foods adapted for medical purposes; by-products of the processing of cereals for dietetic or medical purposes; sanitary towels; napkins for incontinents; sanitary pads; panty liners [sanitary]; propolis for pharmaceutical purposes; pearl powder for medical purposes; radium for medical purposes; solvents for removing adhesive plasters; vaginal washes; solutions for contact lenses; chemical reagents for medical or veterinary purposes; gum for medical purposes; rubber for dental purposes; chewing gum for medical purposes; insect repellents; insect repellent incense; repellents for dogs; tissues impregnated with pharmaceutical lotions; sarsaparilla for medical purposes; sugar for medical purposes; asthmatic tea; fumigating sticks; linseed for pharmaceutical purposes; tobacco-free cigarettes for medical purposes; siccatives [drying agents] for medical purposes; syrups for pharmaceutical purposes; turpentine for pharmaceutical purposes; milking grease; greases for veterinary purposes; greases for medical purposes; lacteal flour for babies; soporifics; bicarbonate of soda for pharmaceutical purposes; bath salts for medical purposes; salts for mineral water baths; salts for medical purposes; potassium salts for medical purposes; sodium salts for medical purposes; smelling salts; mineral water salts; malt for pharmaceutical purposes; semen for artificial insemination; medicinal alcohol; alloys of precious metals for dental purposes; ergot for pharmaceutical purposes; cooling sprays for medical purposes; adjuvants for medical purposes; styptic preparations; vermifuges; disinfectants for hygiene purposes; disinfectants for chemical toilets; douching preparations for medical purposes; appetite suppressants for medical purposes; medical preparations for slimming purposes; parasiticides; mouthwashes for medical purposes; febrifuges; depuratives; animal washes; cattle washes; detergents for medical purposes; dog washes; vesicants; articles for headache; purgatives; remedies for perspiration; remedies for foot perspiration; chemical contraceptives; antiparasitic

preparations; sedatives; laxatives; tonics [medicines]; nervines; digestives for pharmaceutical purposes; media for bacteriological cultures; steroids; strychnine; suppositories; serums; tanning pills; appetite suppressant pills; slimming pills; yeast dietary supplements; antioxidant pills; sanitary tampons; vulnery sponges; thymol for pharmaceutical purposes; biological tissue cultures for veterinary purposes; biological tissue cultures for medical purposes; surgical cloth [tissues]; smoking herbs for medical purposes; medicinal herbs; surgical implants [living tissues]; pants, absorbent, for incontinents; sanitary panties; babies' napkin-pants [diaper-pants]; charcoal for pharmaceutical purposes; fennel for medical purposes; porcelain for dental prostheses; phenol for pharmaceutical purposes; enzymes for veterinary purposes; enzymes for medical purposes; ferments for pharmaceutical purposes; formic aldehyde for pharmaceutical purposes; phosphates for pharmaceutical purposes; fungicides; quinine for medical purposes; chinoline for medical purposes; diabetic bread adapted for medical use; chloroform; flowers of sulphur for pharmaceutical purposes; cement for animal hooves; bone cement for surgical and orthopaedic purposes; dental cements; medicinal tea; herbal teas for medicinal purposes; eucalyptus for pharmaceutical purposes; tobacco extracts [insecticides]; extracts of hops for pharmaceutical purposes; elixirs [pharmaceutical preparations]; ethers for pharmaceutical purposes; esters for pharmaceutical purposes; cellulose esters for pharmaceutical purposes; cellulose ethers for pharmaceutical purposes; rat poison; poisons; bacterial poisons; jalap; jujube, medicated.

(260) AM 2015 77403 A
 (800) 1203784
 (891) 2014 03 25
 (731) SANOFI
 54 rue La Boétie, F-75008 Paris, FR
 (540)

ALIRIDUC

(511)
 5 – Pharmaceutical products.

(260) AM 2015 77408 A
 (800) 1203877
 (891) 2014 03 07
 (731) MW HANDEL GMBH
 Lyonerstraße 14, 60528 Frankfurt am Main,
 DE
 (540)



(591) Blue, red, light blue and light red
(511)
11 – Lighting apparatus and installations; lamps; ceiling lights; lanterns for lighting; lamp shades.

35 – Import-export agencies; commercial information agencies; marketing studies; marketing research; sales promotion for others; procurement services for others [purchasing goods and services for other businesses]; commercial or industrial management assistance; demonstration of goods; organization of exhibitions for commercial or advertising purposes.

37 – Electric appliance installation and repair; installation of lighting apparatus; repair of lighting apparatus.

39 – Wrapping of goods; delivery of goods; delivery of goods by mail order; storage of goods; storage.

(260) AM 2015 77428 A
(800) 1204091
(891) 2014 01 22
(731) EGIS GYÓGYSZERGYÁR ZRT.
Keresztúri út 30-38, H-1106 Budapest, HU
(540)

THROSUG

(511)
5 – Pharmaceutical preparations for human use.

(260) AM 2015 77433 A
(800) 1204103
(891) 2014 02 06
(731) EGIS GYÓGYSZERGYÁR ZRT.
Keresztúri út 30-38, H-1106 Budapest, HU
(540)

НОФЛЮКС

(511)
5 – Pharmaceutical preparations for human use.

(260) AM 2015 77439 A
(800) 1204243
(891) 2014 02 13
(731) FIDIA FARMACEUTICI S.p.A.
ia Ponte della Fabbrica, 3/A, I-35031 ABANO
TERME (PD), IT
(540)

ФИДАТО

(511)
5 – Pharmaceutical and veterinary preparations; sanitary preparations for medical purposes; dietetic substances adapted for medical use, food for babies; plasters, materials for dressings; material for stopping teeth, dental wax; disinfectants; preparations for destroying vermin; fungicides, herbicides.

(260) AM 2015 77442 A
(800) 629055
(891) 2013 12 18
(731) ASTELLAS PHARMA EUROPE B.V.
Sylviusweg 62, NL-2333 BE Leiden, NL
(540)

ЛОКОИД

(511)
5 – Pharmaceutical preparations and substances for human use.

(260) AM 2015 77449 A
(800) 938706
(891) 2014 04 18
(731) NOVILAB AG
c/o Unitreu, Gartenstrasse 4, CH-6300 Zug,
CH
(540)



(591) Black, white
(511)
3 – Cosmetic preparations for babies, bath and shower preparations, baby oils; body, leg and foot creams, shampoos, lotions, massage gels, powder and liquid talcs, preparations for teeth cleaning.

5 – Sanitary articles for babies, baby cotton buds, disposable breast pads.

8 – Scissors, clippers, metal cutlery, plastic cutlery.

9 – Anti-electric shock safety covers for electric sockets, electronic devices for supervising babies; thermometers not for medical purposes.

10 – Hygienic latex articles for infants, breast pumps, nipple protectors, breast shells, latex and silicone teats and soothers, gum massage apparatus, teething rings, thermometers for medical purposes; nasal aspirators; baby bottles (glass and plastic).

11 – Baby food warmers, steam sterilizers, bottle warmers, battery lamps.

16 – Paper and cellulose dry nappy liners.

18 – Baby accessory bags with insulated pockets, baby accessory travel bags.

20 – Advertising furniture, ordinary and insulated non-metallic containers, styrofoam packaging containers; edgings of plastics for furniture for protecting babies from injury, in particular, corner cushions, fittings for furniture used to prevent children from opening the furniture; baby changing mats.

21 – Hairbrushes, bottle brushes, teat brushes, toothbrushes, combs, sponges, melamine plastic utensils and containers for household purposes, cups, canteens (container used to carry drinking water or

other liquids), tumblers, food dispensers for kitchen use, household or kitchen thermo-insulated containers.

24 – Textile goods for children not included in other classes, infant bedding, sheets for baby beds, fitted stretch terry sheets, soft baby blankets, sleeping bags.

25 – Clothing and footwear for mothers and infants, plastic and cotton bibs, tie pants, textile dry nappy liners, towelling robes called "cuddle and dry robes", bath robes (dressing gowns), maternity underwear; hair wash hoops (brims) preventing baby's eyes and face against soap and water.

26 – Safety pins, in particular safety pins with protection.

27 – Bathroom and bath mats, anti-slip mats.

28 – Toys for infants and children not included in other classes.

(260) AM 2015 77453 A

(800) 1038068

(891) 2014 05 08

(731) CAFLON LIMITED

Unit 19, Park Street Industrial Estate, Osier Way, Aylesbury, Buckinghamshire HP20 1EB, GB

(540)

CAFLON

(511)

8 – Apparatus and instruments for piercing ears; parts and fittings for all the aforesaid goods.

10 – Surgical apparatus and instruments, all for piercing ears; parts and fittings for all the aforesaid goods.

14 – Precious metals and their alloys and goods in precious metals or coated therewith, not included in other classes; jewellery, precious stones; horological and chronometric instruments.

(260) AM 2015 77456 A

(800) 1119715

(891) 2014 04 01

(731) Zakrytoe aktsionerno obshchestvo

"SHUPET"

d. 15, korp. 8, ul. Nagornaya, RU-117186 Moscow, RU

(540)

Choupette

(591) Black, white

(511)

24 – Textiles and textile goods, not included in other classes; bed covers; table covers; bed linen; sleeping bags [sheeting]; pillowcases; mattress covers; bed blankets; bed covers; gummed cloth, other than for stationery; mosquito nets; lingerie fabric.

25 – Clothing, footwear, headgear.

(260) AM 2015 77457 A

(800) 1146494

(891) 2014 03 05

(731) ARETEX, S.A.

Rial de sa Clavella, 89, E-08350 ARENYS DE MAR (Barcelona), ES

(540)

CND

(511)

25 – Clothing, footwear, headgear, hosiery.

(260) AM 2015 77479 A

(800) 1204519

(891) 2014 04 09

(731) OPEL SPECIAL VEHICLES GMBH

Mainzer Str. (Adam Opel AG – M55), 65428 Rüsselsheim, DE

(540)

KARL

(511)

12 – Motor vehicles, their parts and spare parts, included in this class.

27 – Foot mats for vehicles.

28 – Games and playthings, sporting articles, toy cars, model cars, plush toys, teddy bears, electronic games (including video games); playing cards; flying discs, footballs, basketballs, softballs; all aforesaid goods included in this class.

(260) AM 2015 77484 A

(800) 1204569

(891) 2014 04 03

(731) SCA CAPITAL NV

Culliganlaan 1 D, B-1831 Machelen (Brabant), BE

(540)



(591) Blue, dark blue, white, light grey and pink

(511)

16 – Paper for household, sanitary and cosmetic use.

(260) AM 2015 77488 A
 (800) 1204688
 (891) 2014 03 04
 (731) BULBASH, SIA
 Terbatas iela 14-2, LV-1011 Riga, LV
 (540)

TRIPLE SEVEN



(591) Black, white
 (511)
 33 – Alcoholic beverages (except beer) including aperitifs, vodka, gin, digesters, alcoholic cocktails, liqueurs, alcoholic beverages containing fruits, spirits (beverages), mead, peppermint alcoholic beverages, bitters.

(260) AM 2015 77497 A
 (800) 1204795
 (891) 2014 02 03
 (731) PHILIP MORRIS BRANDS SÀRL
 Quai Jeanrenaud 3, CH-2000 Neuchâtel, CH
 (540)



(591) Red, dark red and gray
 (526) The trademark is protected as a whole. The word "SELECTED PREMIUM TOBACCOS" included therein shall not be subject to independent legal protection.
 (511)
 34 – Tobacco, raw or manufactured; tobacco products, including cigars, cigarettes, cigarillos, tobacco for roll-your-own cigarettes, pipe tobacco, chewing tobacco, snuff tobacco, kretek; snus; tobacco substitutes (not for medical purposes); smokers' articles, including cigarette paper and tubes, cigarette filters, tobacco tins, cigarette cases and ashtrays, pipes, pocket apparatus for rolling cigarettes, lighters; matches.

(260) AM 2015 77505 A
 (800) 1204868
 (891) 2014 01 20
 (731) Madame Eka IUKURIDZE
 35 avenue Pierre 1er, F-75008 PARIS, FR
 (540)

Les Suites

(511)
 14 – Jewelry; precious stones; timepieces and chronometric instruments; precious metals and their alloys; works of art of precious metal; jewelry cases [caskets]; watch cases, bracelets, chains, springs or glasses; key rings [trinkets or fobs]; statues or figurines (statuettes) of precious metals; cases or presentation cases for timepieces; medals.

25 – Clothing; footwear; headgear; shirts; leather or imitation leather clothing; belts (clothing); furs (clothing); gloves (clothing); scarves, neckties; hosiery; socks; bedroom slippers; footwear for the beach; footwear for skiing or sports; underwear.

43 – Services for providing food and drink; bar services; food and drink catering.

(260) AM 2015 77506 A
 (800) 1204892
 (891) 2013 11 06
 (731) EGIS GYÓGYSZERGYÁR ZRT.
 Keresztúri út 30-38, H-1106 Budapest, HU
 (540)



(591) Green and blue
 (511)
 5 – Pharmaceutical and sanitary preparations; dietetic preparations adapted for medical purposes; vitamin preparations, mineral food supplements, dietetic food supplements, plasters, surgical dressings; material for stopping teeth and dental wax; disinfectants.

35 – Marketing relating to pharmaceutical and diagnostic products; medical advertising through communication media to different target groups, business consultancy, provision of commercial information or advertising consultation in the field of pharmaceuticals, medicine or diagnostics; processing of computerized data; organization of exhibitions for commercial or advertising purposes; all kinds of advertising provided on-line by computer network, including the Internet; administrative services relating to the registration of medicines and medicinal

substances, marketing; sale of laboratory diagnostic services.

41 – Education, professional training relating to medicine, pharmaceuticals and diagnostics, arranging and conducting of conferences, congresses, seminars in the field of medicine and diagnostics, publishing of publications, books, handbooks and databases in the field of medicine, pharmaceuticals and diagnostics, providing information in the field of health care; arranging, conducting, making of exhibitions in the field of medicine and diagnostics for educational or training purposes.

42 – Pharmaceutical, chemical and diagnostic research, research and development and clinical testing of medicines, provision of information and data relating to the research and development for medicines and medicinal substances, consultancy in the field of medicine, diagnostics or biotechnology, development of diagnostic kits, development and operation of laboratory diagnostic services.

44 – Medical and diagnostic services, diagnosing of various diseases, genetic diagnosis, determination of medicine responsiveness with genetic methods, recognizing, measuring and classifying oncologic and chronic inflammatory diseases by IT and laboratory methods.

(260) AM 2015 77508 A
(800) 1204908
(891) 2014 04 02
(731) EGIS GYÓGYSZERGYÁR ZRT.
Keresztúri út 30-38, H-1106 Budapest, HU
(540)

ANGIRAZIN

(511)
5 – Pharmaceutical preparations for human use.

(260) AM 2015 77548 A
(800) 937816
(891) 2013 12 24
(731) Obschestvo s ogranichennoi otvetstvennostyu
"Coffe House "HORS"
2, Droboliteiniy side-street, RU-129626
Moscow, RU
(540)

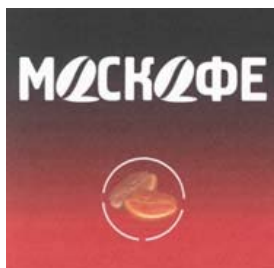

(591) Red, crimson, terracotta, dark brown, white, yellow, light brown and brown

(511)
30 – Coffee; artificial coffee; bread, pastry and confectionery, ice-cream on the basis of coffee additives (terms considered too vague by the International Bureau (Rule 13(2)(b) of the Common Regulations).

(260) AM 2015 77549 A
(800) 943962
(891) 2014 03 21
(731) Joint Stock Company
"AEROFLOT-RUSSIAN AIRLINES"
house 10, Arbat Street, RU-119002 Moscow,
RU
(540)



(591) White, dark blue, red and orange
(511)
39 – Transport; packaging and storage of goods; travel arrangement, including air transport; boat rental; booking of seats for travel; travel reservation; transport reservation; towing; vehicle towing; water distribution; message delivery; parcel delivery; delivery of goods; delivery of goods by mail order; launching of satellites for others; transportation information; storage information; arranging of cruises; arranging of tours; hauling; carting; transport and storage of trash; transporting furniture; removal services; barge transport; ferry-boat transport; transport of travelers; freight; armored-car transport; bus transport; car transport; boat transport; railway transport; marine transport; passenger transport; river transport; portage; refloating of ships; shipbrokerage; transport brokerage; freight brokerage; operating canal locks; car rental; truck rental; rental of diving bells; rental of diving suits; rental of motor racing cars; rental of wheelchairs; rental of storage containers; horse rental; coach rental; frozen-food locker rental; vehicle rental; stevedoring; unloading cargo; electricity distribution; distribution of energy; delivery of newspapers; packaging of goods; ambulance transport; garage rental; rental of vehicle roof racks; rental of warehouses; ice-breaking; piloting; water supplying; escorting of travelers; underwater salvage; salvage of ships; taxi transport; streetcar transport; transport by pipeline; rescue operations (transport); wrapping of goods; car parking; chauffeur services; pleasure boat transport; courier services (messages or merchandise); salvaging; tourist offices (except for hotel reservation); freighting; storage of electronically-stored data or documents; boat storage; storage of goods; storage; sightseeing; freight forwarding; location of freight-cars by computer.

(260) AM 2015 77550 A

(800) 1002149

(891) 2014 05 13

(731) AKOS KOZMETİK SAN. VE TİC. LTD.
ŞTİ.

Çobançeşme Mah. Mithatpaşa, Cad. Yaprak
Sk. No:5, Bahçelievler 034, TR

(540)

CHIMERA

(591) Black, white

(511)

3 – Bleaching preparations and other substances for laundry use; cleaning, polishing, scouring and abrasive preparations; soaps; perfumery, essential oils, cosmetics hair lotions; dentifrices.

(260) AM 2015 77551 A

(800) 1180372

(891) 2014 03 31

(731) CONSOLIDATED ARTISTS B.V.

Lijnbaan 68, NL-3012 EP ROTTERDAM, NL

(540)

violeta

BY MANGO

(591) Black, white

(511)

14 – Timepieces, watches, alarm clocks, wall clocks and chronometric instruments; jewelry, rings, bracelets, chains, necklaces, pendants, brooches, earrings, medals, medallions (jewelry), cuff links, tie pins, clasps; precious stones; key rings [trinkets or fobs]; jewelry for mobile telephones; mobile telephone charms, key rings (trinkets or fobs) for mobile telephones and other fancy accessories for mobile telephones as decorations for mobile telephones, portable jewelry, pendants for mobile telephones; precious metals and their alloys (other than for dental use) and goods made from these materials (precious metals and their alloys) or coated therewith and not included in other classes, namely figurines, works of art, statues, statuettes, boxes, jewelry cases, presentation cases, insignia, coins; cases or presentation cases for timepieces.

18 – Leather and imitations of leather; articles of leather or imitation leather (except cases fitted to the goods for which they are intended, gloves and belts); trunks and suitcases; cases and boxes of leather or leather board; travel trunks; attaché cases; document holders; handbags; briefcases; bags, satchels and school bags; mesh bags and shopping bags; pouches and bags (envelopes, small bags) for packaging (made of leather); sling bags for carrying infants; backpacks; wheeled shopping bags; bags for climbers; bags for campers; beach bags; travel bags; garment bags (for travel); card cases (wallets); wallets;

coin purses (not of precious metal); purses; chain mesh purses not of precious metal; key cases (leather goods); hat boxes of leather; vanity cases; shoulder belts (straps) of leather; leather laces, straps, lines, strips, belts and loops; collars and clothing for animals; dog collars; leashes, muzzles; pelts (furs); animal skins; umbrellas, parasols and walking sticks; umbrella covers; whips, harness and saddlery.

25 – Outerwear and underwear for men, women and children; leather and imitation leather clothing; clothing of fur; sportswear (other than for diving); blousons (jackets); gabardines (clothing); raincoats; coats; mantillas; mittens; overcoats; trench coats; parkas; pelerines; pelisses; stuff jackets; suits; costumes for fancy dress; jackets; overalls; aprons (clothing); combinations (clothing and underclothing); cross-over tops; cardigans; pullovers; sweaters; knitwear (clothing); tank tops; vests; skirts; petticoats; trousers; dresses; saris; shirts; short-sleeve shirts; tee-shirts; sweatshirts; shorts; Bermuda shorts; top coats; ready-made clothing; paper clothing; muffs; pajamas; dressing gowns (robes); dressing gowns; briefs, including bathing trunks; bathing suits and beachwear; jerseys, including swimsuits; bath robes; body linen (underwear); leotards; bustiers; underwear; breeches for wear; underpants; brassieres; corsets; stocking suspenders; socks; stockings; tights; hosiery; neckerchiefs; scarves; shawls; neckwear; sashes for wear; fur stoles; gloves (clothing); belts (clothing); suspenders; neckties; bow ties; pocket squares; collar protectors; romper suits, crop tops, layettes; bibs (not of paper); shoes; footwear, including beach footwear; sports and ski footwear; boots; half-boots; clogs (wooden shoes); esparto shoes or sandals; sandals; bath sandals; slippers; bedroom slippers; headgear; hats; half veils; caps (headgear); cap peaks; berets; caps, including bathing caps; headbands (clothing); turbans.

(260) AM 2015 77554 A

(800) 1205196

(891) 2013 11 06

(731) EGIS GYÓGYSZERGYÁR ZRT.

Keresztúri út 30-38, H-1106 Budapest, HU

(540)



(591) Black, white

(511)

5 – Pharmaceutical and sanitary preparations; dietetic preparations adapted for medical purposes; vitamin preparations, mineral food supplements, dietetic food supplements, plasters, surgical dressings; material for stopping teeth and dental wax; disinfectants.

35 – Marketing relating to pharmaceutical and diagnostic products; medical advertising through communication media to different target groups, business consultancy, provision of commercial information or advertising consultation in the field of pharmaceuticals, medicine or diagnostics; processing of computerized data; organization of exhibitions for commercial or advertising purposes; all kinds of advertising provided on-line by computer network, including the Internet; administrative services relating to the registration of medicines and medicinal substances, marketing; sale of laboratory diagnostic services.

41 – Education, professional training relating to medicine, pharmaceuticals and diagnostics, arranging and conducting of conferences, congresses, seminars in the field of medicine and diagnostics, publishing of publications, books, handbooks and databases in the field of medicine, pharmaceuticals and diagnostics, providing information in the field of health care; arranging, conducting, making of exhibitions in the field of medicine and diagnostics for educational or training purposes.

42 – Pharmaceutical, chemical and diagnostic research, research and development and clinical testing of medicines, provision of information and data relating to the research and development for medicines and medicinal substances, consultancy in the field of medicine, diagnostics or biotechnology, development of diagnostic kits, development and operation of laboratory diagnostic services.

44 – Medical and diagnostic services, diagnosing of various diseases, genetic diagnosis, determination of medicine responsiveness with genetic methods, recognizing, measuring and classifying oncologic and chronic inflammatory diseases by IT and laboratory methods.

(260) AM 2015 77555 A

(800) 1205281

(891) 2014 03 04

(731) JULIE SELF

Leith House, South Harting, Hampshire
GU31 5PH, GB

(540)



(591) White, red, and black

(511)

4 – Lubricants contained in aerosol containers, all included this class.

(260) AM 2015 77556 A

(800) 1205290

(891) 2014 02 18

(731) C. STEINWEG-HANDELSVEEM B.V.

Parmentierplein 1, NL-3088 GN
Rotterdam, NL

(540)



C. STEINWEG

(591) Black, white

(511)

39 – Transport, packaging and storage of goods, freight and containers; ferry cargoes (transport of goods by ship); rental of ships; ship chartering; boat transport and navigation agencies online; freight consolidation services; loading and unloading of goods, freight and containers; delivery of goods, goods forwarding, stevedoring services; towing, unloading, dock and port activities, refloating of ships in difficulty and cargo thereof; packaging of goods for dispatch purposes; rental of storage space; storage in warehouses; rental of warehouses; container terminal services; delivery of installations and infrastructure for container terminals; container rental; provision of information relating to tariffs, timetables and means of transport; charter agencies and brokerage in the field of transport and cargo; checking of vehicles, ships and goods prior to transport; advice and consultancy on all the aforementioned services, also provided via the Internet.

(260) AM 2015 77557 A

(800) 1205311

(891) 2014 04 29

(731) Limited Liability Company

"MARCHE PRIVATE"

Via Cadorna, 13, I-20123 Milan (MI), IT

(540)

BOOM

(591) Black, white

(511)

18 – Attaché cases; bags for sports; briefcases; card cases [notecases]; cases, of leather or leatherboard; garment bags for travel; handbags; haversacks; key cases; music cases; pocket wallets; purses; rucksacks; school bags; suitcases; travelling bags; travelling sets [leatherware]; trunks [luggage]; umbrella covers; valises; vanity cases, not fitted.

28 – Board games; building games; confetti; dolls; dolls' clothes; games; jigsaw puzzles; kaleidoscopes; marbles for games; mobiles [toys]; ornaments for

Christmas trees, except illumination articles and confectionery; parlor games; play balloons; plush toys; soap bubbles [toys]; stuffed toys; teddy bears; toy pistols; toys.

(260) AM 2015 77559 A

(800) 1205336

(891) 2014 01 08

(731) GUERLAIN S.A.

68 avenue des Champs-Élysées, F-75008
PARIS, FR

(540)



(591) Black, white

(511)

3 – Perfumery products; perfumes; toilet water; eaux de parfums; extracts of perfumes; soaps; bath or shower gels and salts for non-medical use; cosmetics for skin, body, face, nail and hair care; creams; milks; lotions; gels and powders for the face; body and hands; essential oils; make-up products; dentifrices; shampoos; body deodorants.

(260) AM 2015 77560 A

(800) 1205343

(891) 2013 11 21

(731) DR. SERTUS İLAÇ SANAYİ VE TİCARET
LİMİTED ŞİRKETİ

Evren Mah. Camiyolu Cad. No:50 K.2,
Güneşli, Bağcılar, İstanbul, TR

(540)

LANGENA
ЛАНГЕНА

(591) Black, white

(511)

5 – Medicines for human purposes, medicines for veterinary purposes, vitamin preparations, chemical preparations for medical purposes, dietetic substances adapted for medical use; dietetic foods adapted for medical purposes; baby foods, medicinal herbs, herbal beverages adapted for medical purposes, nutritional supplements, pollen dietary supplements, mineral food supplements, protein dietary supplements; medicines for dental purposes, hygienic products for medical purposes including sanitary pads,

breast-nursing pads and bunion pads, wadding for medical purposes, plasters for medical purposes, dressings for medical purposes, babies' napkins, preparations for destroying noxious plants, preparations for destroying noxious animals, fungicides, deodorants other than for human beings or for animals, air deodorising preparations, disinfectants for hygiene purposes, antiseptics, detergents for medical purposes.

(260) AM 2015 77561 A

(800) 1205433

(891) 2014 03 04

(731) PHILIP MORRIS PRODUCTS S.A.

Quai Jeanrenaud 3, CH-2000 Neuchâtel, CH

(540)



(591) Black, white

(511)

34 – Tobacco, raw or manufactured; tobacco products, including cigars, cigarettes, cigarillos, tobacco for roll-your-own cigarettes, pipe tobacco, chewing tobacco, snuff tobacco, kretek; snus; tobacco substitutes (not for medical purposes); smokers' articles, including cigarette paper and tubes, cigarette filters, tobacco tins, cigarette cases and ashtrays, pipes, pocket apparatus for rolling cigarettes, lighters; matches.

(260) AM 2015 77562 A

(800) 1205451

(891) 2014 03 05

(731) ALTONA COSMETICS TECHNOLOGY

SANAYİ VE TİCARET ANONİM ŞİRKETİ

Avrupa Serbest Bölgesi 111, Ada 14. Parsel,
ÇORLU TEKİRDAĞ, TR

(540)

Note

(591) Black, white

(511)

3 – Bleaching preparations and other substances for laundry use; cleaning, polishing, scouring and abrasive preparations; soaps; perfumery, essential oils, cosmetics, hair lotions; dentifrices.

(260) AM 2015 77563 A
 (800) 1205461
 (891) 2014 04 11
 (731) LEONICE SOCIETE ANONYME TRADING
 AND MANUFACTURING COMPANY OF
 VARNISHES AND PAINTS
 1, Koletti Street, Penteli, GR-152 36 Attica,
 GR

(540)

ECOTINT

(511)
 2 – Paints; varnishes; lacquers; preservatives against
 rust and against deterioration of wood; colorants;
 mordants; raw natural resins; metals in foil and pow-
 der form for painters, decorators, printers and artists.

(260) AM 2015 77565 A
 (800) 1205477
 (891) 2013 11 21
 (731) DR. SERTUS İLAÇ SANAYİ VE TİCARET
 LİMİTED ŞİRKETİ
 Evren Mah. Camiyolu Cad. No:50 K.2,
 Güneşli, Bağcılar, İstanbul, TR

(540)

ESTADEL ЭСТАДЕЛ

(591) Black, white
 (511)
 5 – Medicines for human purposes, medicines for
 veterinary purposes, vitamin preparations, chemical
 preparations for medical purposes, dietetic substan-
 ces adapted for medical use; dietetic foods adapted
 for medical purposes; baby foods, medicinal herbs,
 herbal beverages adapted for medical purposes, nu-
 tritional supplements, pollen dietary supplements,
 mineral food supplements, protein dietary supple-
 ments; medicines for dental purposes, hygienic pro-
 ducts for medical purposes including sanitary pads,
 breast-nursing pads and bunion pads, wadding for
 medical purposes, plasters for medical purposes,
 dressings for medical purposes, babies' napkins, pre-
 parations for destroying noxious plants, preparations
 for destroying noxious animals, fungicides, deodo-
 rants other than for human beings or for animals, air
 deodorising preparations, disinfectants for hygiene
 purposes, antiseptics, detergents for medical pur-
 poses.

(260) AM 2015 77568 A
 (800) 1205508
 (891) 2014 02 26
 (731) ISOLIN IP LTD
 9, Karaiskaki, Agias Triadas, CY-3022
 Limassol, CY

(540)



(591) Red
 (511)
 9 – Computers and computer hardware; computer
 accessories and spare parts; computer operating sys-
 tems.

35 – Stationery shop retail services connected with
 the sale of stationery, printed matter, computer equi-
 pment and peripherals and home entertainment
 *products.

37 – Installation, repair and maintenance of compu-
 ters and computer peripherals; computer hardware
 and telecommunication apparatus installation, main-
 tenance and repair.

38 – Telecommunications services between compu-
 ter networks; communication services over computer
 networks.

41 – Training relating to computer hardware; tra-
 ining relating to computer software; training relating
 to computer programs; education services relating to
 computers.

42 – Computer software and hardware services;
 computer hardware development; computer software
 development; installing computer programs; compu-
 ter software maintenance services; computer soft-
 ware design and development; rental of computer
 hardware and facilities.

(260) AM 2015 77587 A
 (800) 1205524
 (891) 2013 08 15
 (731) LINE CORPORATION
 2-21-1, Shibuya, Shibuya-ku Tokyo
 150-8510, JP

(540)

LINE FRIENDS

(511)
 9 – Game programs for arcade video game machi-
 nes; portable telephones; monitoring apparatus, elec-
 tric; facsimile machines; phototelegraphy apparatus;
 television apparatus; radios; video telephones; wal-
 kie-talkies; navigation apparatus for vehicles (on-
 board computers); satellite navigational apparatus;
 global positioning system (GPS) apparatus; portable
 audio players; compact disc players; tape recorders;
 record players; sound recording carriers; DVD pla-
 yers; DVD recorders; digital cameras; digital photo
 frames; camcorders; videodisc players; portable me-
 dia players; cell phone straps; cell phone battery
 chargers; cell phone covers; cell phone cases; car-
 rying cases for cell phones; cell phones straps with
 screen cleaners; hands-free kits for cell phones;

headphones; loudspeakers; microphones; personal stereos; other telecommunication machines and apparatus; optical data media; modems; computers; laptop computers; sleeves for laptops; bags adapted for laptops; tablet computers; protective cases for tablet computers; monitors (computer hardware); computer screens; computer touch screens; electronic pens (visual display units); computer keyboards; printers for use with computers; computer peripheral devices; computer programs, recorded; computer programs (downloadable software); computer game programs; downloadable computer programs used for cell phones; encoded magnetic cards; USB flash drives; mouse (data processing equipment); mouse pads; optical character readers; scanners (data processing equipment); bar code readers; electronic agendas; electronic dictionaries; pocket calculators; electronic pocket translators; integrated circuit cards (smart cards); chips (integrated circuits); electronic tags for goods; semi-conductors; electron microscopes; other electronic machines and apparatus; contact lenses; containers for contact lenses; sunglasses; goggles for sports; eyeglasses; spectacle cases; eyeglass cords; eyeglass cases; eyeglass frames; swimming goggles; video game cartridges; computer game software; downloadable music files; phonograph records; downloadable ring tones for cell phones; exposed cinematographic films; exposed slide films; slide film mounts; animated cartoons; downloadable image files; compact discs (audio-video); electronic publications, downloadable.

16 – Pastes and other adhesives for stationery or household purposes; packaging containers of paper; paper bags; wrapping paper; packing paper; cardboard tubes; cardboard; cardboard articles; packaging containers of cardboard; banners of cardboard; flags of cardboard; printed matter of cardboard; cardboard stationery; banners of paper; flags of paper; hygienic hand towels of paper; towels of paper; table napkins of paper; hand towels of paper; handkerchiefs of paper; tissues of paper for removing make-up; hygienic paper; paper; toilet paper; tissue paper; writing paper; stationery; address stamps; bookmarkers; pencil point protectors; crayons; greeting cards; felt writing pens; seals (stationery); pencil lead holders; scrapbooks; sketch books; stamps (seals); stickers (stationery); note books; pastels (crayons); felt marking pens; paper knives (office requisites); pen clips; ball-point pens; loose-leaf pads; stamp cases; seal ink pads; pencils; thumbtacks; paper stationery; pocket memorandum books; correcting tapes (office requisites); folders for papers; rubber erasers; terrestrial globes; writing materials; stands for pens and pencils; envelopes (stationery); protractors as drawing instruments; paperweights; writing pads; Indian inks; fountain pens; writing brushes; postcards; picture postcards; sheet music; catalogues; calendars; tickets; trading cards other than for games; pamphlets; posters; printed

matter; magazines (periodicals); printed publications; books; booklets; newspapers; blueprints; plans; prospectuses; geographical maps; periodicals; almanacs; comic books; other printed matter; lithographs; calligraphic works; paintings (pictures), framed or unframed; photographs (printed); photograph stands.

25 – Clothing; sleep masks; undershirts; overcoats; cardigans; shower caps; jackets (clothing); jogging pants; sweat pants; scarves; ski jackets; ski trousers; trousers; sweaters; night gowns; nightcaps; neckties; parkas; pajamas; panties and briefs; blouses; vests; waistcoats; polo shirts; ponchos; mufflers (clothing); mantles (clothing); hosiery; raincoats; shirts for suits; underwear; school uniforms; socks; nightwear; swim wear; swim caps; hats; headgear for wear; uniforms; sports jerseys; clothing for gymnastics; stockings; spats; stocking suspenders; sock suspenders; belts (clothing); footwear; sandals; slippers; half-boots; beach shoes; boots; inner soles; fittings of metal for footwear; shoe protective metal members for shoes and boots; boot uppers; bath slippers; non-slipping devices for footwear; sports shoes; masquerade costumes; full body suit (costumes); cyclists' clothing; ski gloves; headbands (clothing); motorists' clothing; wetsuits for water-skiing; ski boots; football shoes; studs for football boots.

28 – Amusement machines and apparatus for use in amusement parks; fairground ride apparatus; arcade video game machines; amusement machines, automatic and coin-operated; controllers for game consoles; home video game machines; hand-held games with liquid crystal displays; dolls; dolls' clothes; toys; building games; mobiles (toys); musical toys; toy clocks; toy watches; toy vehicles; toy masks; rattles (playthings); spinning tops (toys); kites; stuffed toys; cosques (toy fireworks); ornaments for Christmas trees, except illumination articles and confectionery; soap bubbles (toys); jigsaw puzzles; flying discs (toys); radio-controlled toy vehicles; scooters (toys); paper party hats; scale model vehicles; swimming pools (play articles); building blocks (toys); kaleidoscopes; scale model kits (toys); play balloons; rocking horses; ring games; go board games; Japanese chess (shogi games); scratch cards for playing lottery games; dice; counters (discs) for games; cups for dice; Chinese checkers; chessboards; chess games; checkerboards; draughts (games); playing cards; dominoes; backgammon games; bingo cards; mah-jong; conjuring apparatus; board games; tables for indoor football; roulette wheels; playing balls; parlour games; games; game machines and apparatus; pachinkos; slot machines (gaming machines); darts; billiard equipment; sports equipment; machines for physical exercises; slides (playthings); sleighs (sports articles); shin guards (sports articles); knee guards (sports articles); elbow guards (sports articles); swings; archery implements; ice

skates; golf clubs; skis; skateboards; snowboards; hang gliders; twirling batons; paragliders; fencing weapons; boxing gloves; rackets; body rehabilitation apparatus; roller skates; stationary exercise bicycles; swimming kick boards; floats for bathing and swimming; appliances for gymnastics; tables for table tennis; baseball gloves; climbers' harness; surfboards; surf skis; swimming webs (flippers); fishing tackle; insect collecting implements; butterfly nets; printed lottery tickets (other than toys).

30 – Tea; tea-based beverages; oolong tea (Chinese tea); black tea (English tea); mugi-cha (roasted barley tea); Japanese green tea; infusions, not medicinal; coffee; coffee-based beverages; cocoa; cocoa-based beverages; chocolate-based beverages; pastries; confectionery; candies with giveaway toys; ice cream; sherbets (ices); caramels (candy); candy; pastilles (confectionery); cookies; crackers; biscuits; confectionery for decorating Christmas trees; macarons (pastry); marzipan; chewing gum; chocolate; tortillas; pies; bread; pancakes; popcorn; meat pies; rusks; waffles; sandwiches; tacos; tarts; steamed buns stuffed with minced meat (Chinese-manjuh); hamburgers (sandwiches); cheeseburgers (sandwiches); hot dogs (sandwiches); pizzas; fruit jellies (confectionery); frozen yogurt (confectionery ices); puddings; sugar confectionery; edible ices; cakes; dessert mousses (confectionery); rice cakes; chips (cereal products); oat-based food; seasonings (other than spices); soya sauce; honey; soya bean paste (condiment); meat gravies; ketchup (sauce); dressings for salad; sauces (condiments); chutneys (condiments); tomato sauce; mayonnaise; natural sweeteners; sugar; cooking salt; vinegar; salt for preserving foodstuffs; molasses for food; beer vinegar; maltose; ice cream mixes; sherbet mixes; noodles; oat flakes; oatmeal; corn flakes; cereal bars; spaghetti; pasta; breadcrumbs; macaroni; cake paste; cereal preparations; Chinese stuffed dumplings; Chinese steamed dumplings; sushi; fried balls of batter mix with small pieces of octopus (takoyaki); box lunches consisting of rice, with added meat, fish or vegetables; ravioli; spring rolls; noodle-based prepared meals; instant doughnut mixes; instant pudding mixes; pancake mixes; instant jelly mixes; instant pastry mixes; pasta sauce; cake powder; corn flour; wheat flour.

41 – Educational and instruction services relating to arts, crafts, sports or general knowledge; correspondence courses; club services (entertainment or education); providing online electronic publications and documentary records, not downloadable; providing copyrighted works in the nature of animated cartoons by means of communications by computer terminals; providing online non-downloadable comic books and graphic novels; providing online non-downloadable electronic publications in the field of games; book rental; art exhibition services; publica-

tion of books; publication of electronic books and journals on-line; recreation information; amusements; entertainment; entertainment information; arranging and organizing of showing movies, shows, plays or musical performances; arranging and organizing of concerts; cinema presentations, cinema film production, and movie film distribution; providing music and/or images via communication networks; providing animation pictures and images via the Internet; providing pictures, images and/or sounds of cartoon characters and game characters via the Internet; presentation of live performances; presentation of plays; presentation of musical performances; production of radio or television programs; planning and production of cartoon programs; production of video tape film in the fields of education, culture, entertainment or sports (not for movies and television programs and not for advertising and publicity); production of music; organizing, arranging and conducting of sports competitions; organizing, arranging and conducting of entertainment (excluding movies, shows, plays, musical performances, sports, horse races, bicycle races, boat races and auto races); holiday camp services (entertainment); sport camp services; arranging and organizing of fashion shows for entertainment purposes; organization of competitions for education or entertainment; organizing, arranging and conducting of live performances by a costumed character; entertainment in the nature of live performances by a costumed character; organization, arrangement and conducting of horse races; organization, arrangement and conducting of bicycle races; organization, arrangement and conducting of boat races; organization, arrangement and conducting of auto races; providing amusement facilities; providing karaoke services; providing amusement arcade services; amusement parks; rental of records or recorded magnetic audio tapes; rental of recorded magnetic video tapes; game services provided on-line from a computer network; information relating to computer gaming entertainment provided online via communication network.

(260) AM 2015 77598 A

(800) 1205759

(891) 2014 03 18

(731) PEPSICO, INC.

(a North Carolina corporation)

700 Anderson Hill Road, Purchase NY 10577,
US

(540)



(591) White, blue

(511)

16 – Albums; scrapbook albums; sketch books; banners of paper; forms, printed; announcement cards

[stationery]; note books; pads [stationery]; booklets; paper stationery; writing paper; day planners; calendars; writing materials; printed matter; writing or drawing books; stationery.

18 – Bags [envelopes, pouches] of leather, for packaging; travelling sets [leatherware]; souvenir bags; briefcases; haversacks; rucksacks; bags; valises; handbags.

21 – Mugs; containers for household or kitchen use; works of art of porcelain, ceramic, earthenware or glass; beer mugs; crystal [glassware]; drinking glasses; glasses [receptacles].

25 – Clothing; outerclothing; water-resistant clothing; ready-made clothing; denim clothing; motorists' clothing; cyclists' clothing; clothing for children; loungewear; outdoor clothing; clothing for sports; leisure wear; clothing, footwear, headgear.

(260) AM 2015 77599 A

(800) 1205778

(891) 2014 04 09

(731) ERECYCLING GROUP, INC.

909 Hidden Ridge, Suite 440, Irving TX

75038-3813, US

(540)

HYLA

(511)

9 – Portable electronic devices, namely mobile phones, tablet computers, modems and handheld computers.

35 – Retail store services featuring portable electronic devices.

37 – Collection of portable electronic devices for the purpose of recycling, refurbishing and repair; refurbishing and repair of portable electronic devices for others.

40 – Recycling of portable electronic devices for others.

(260) AM 2015 77837 A

(800) 1152716

(891) 2014 04 07

(731) GOLD KILI TRADING ENTERPRISE,

(SINGAPORE) PTE LTD

9 Woodlands Link, SINGAPORE 738723, SG

(540)



The logo for Gold Kili features the words "gold kili" in a stylized, lowercase font. "gold" is in a bold, black, sans-serif font, and "kili" is in a similar font but with a more rounded, script-like feel. The letters are white with a thick black outline, set against a black rectangular background.

金麒麟

(591) Black, white

(511)

30 – Coffee, tea, cocoa and artificial coffee; rice; tapioca and sago; flour and preparations made from cereals; bread, pastry and confectionery; ices; sugar, honey, treacle; yeast, baking-powder; salt; mustard; vinegar, sauces (condiments); spices; ice; coffee substitutes, coffee powder, coffee essences, mixtures of coffee essence and coffee extracts, instant coffee, coffee extracts, coffee mixtures, coffee drinks, coffee concentrates, coffee products, chocolate coffee, flavoured coffee, preparations with a coffee and tea base, preparations for making beverages (coffee based), coffee beverages, coffee based beverages, ice beverages with a coffee base, tea powder, tea essence, herbal tea (other than for medicinal use), fruit flavoured tea (other than medicinal), herb tea-based beverages not for medicinal purposes, artificial tea (other than for medicinal use), iced tea, instant tea (other than for medicinal purposes), non-medicated tea products, tea-based beverages, preparations for making beverages (tea based), beverages made of tea, packaged tea (other than for medicinal use), non-medicated tea beverages, non-medicated tea bags, non-medicated tea products, tea-based beverages, preparations for making beverages (tea based), beverages made of tea, packaged tea (other than for medicinal use), non-medicated tea beverages, non-medicated tea bags, non-medicated tea extracts, instant milk tea, Khuree instant milk tea, 3 in 1 instant tea mix, double shot instant white milk tea, jasmine green tea bags, red date tea, green tea bags, osmanthus green tea bags, instant osmanthus green tea, instant green tea, iron buddha tea bags, oolong tea bags; Matcha ginger latte, Matcha tea, 2 in 1 black coffee bags, 2 in 1 black coffee bags (less sugar), 3 in 1 instant coffee mix latte mocha, caffe latte mocha, cappuccino, caffe cappuccino, caffe latte cappuccino, 2 in 1 traditional coffee, 2 in 1 espresso (no cane sugar), espresso (no cane sugar), espresscino (no cane sugar), chocolate latte, double shot instant white coffee, kopi-o kosong (black coffee), 2 in 1 black coffee bags (less sugar), Khuree instant coffee mix, instant mocha, instant cappuccino, coffee in filter bags; preparations for use in creaming coffee and beverages (glucose syrup based); beverages made from cereals, preparations made from cereals, breakfast cereals, instant oats cereal, porridge oats, processed oats for food for human consumption, rolled oats; syrup for food; chocolate syrups for the preparation of chocolate based beverages, sweet spreads, namely kaya; candy, non-medicated candies, ginger candy, ginger lemon candy, ginger latte.

32 – Beers; mineral and aerated waters and other non-alcoholic beverages; fruit beverages and fruit juices; syrups and other preparations for making beverages; frozen concentrated fruit drinks; frozen concentrated fruit juices; syrup powder for beverages; powders for effervescing beverages; functional

beverages, non-alcoholic drinks (other than for medical use); fruit flavored non-alcoholic drinks; non-alcoholic fruit juice beverages; lemon juice (beverage); lemon squash; isotonic drinks (not for medical purposes); non-alcoholic carbonated drinks; non-medicated mineral drinks; liquid mixtures for making soft drinks; fruit drinks, instant ginger drink, instant honeyed chrysanthemum drinks and concentrated chrysanthemum syrup; aerated beverages (non-alcoholic); aerated drinks (non-alcoholic); aerated fruit juices; aerated water; aloe vera drinks, non-alcoholic; beverages made from fruit concentrates; bottled fruit drinks; bottled fruit juices; concentrates for use in the preparation of fruit juice drinks; concentrates for use in the preparation of soft drinks; hop concentrates for use in the preparation of beverages; hop essences for use in the preparation of beverages; hop extracts for use in the preparation of beverages; edible essences for making beverages; essences for making beverages; extracts of vegetables (beverages); fresh fruit juices; fresh vegetable juices; fruit based drinks; fruit juice beverages; fruit juice concentrates; fruit concentrates for making beverages; fruit juice extracts (beverages or for making beverages); fruit juice nectar (beverages or for making beverages); herbal beverages (other than for medicinal use); mixtures of fruit flavored drinks; nectars of fruit; fruit nectars (non-alcoholic); vegetable drinks; vegetable extracts (beverages); vegetable juice concentrates (beverages); vegetable juices (beverages); isotonic beverages; whey beverages.

(260) AM 2015 77923 A
(800) 1207717
(891) 2014 03 06
(731) BEIJING WEST INDUSTRIES CO., LTD.
No:1 Jiao Dao Dong Xi Da Jie, Doudian
Town, Fangshan District, Beijing, CN
(540)

de Carbon

(511)
12 – Braking devices for land vehicles (parts of land vehicles); suspension devices for land vehicles (parts of land vehicles); suspension shock absorbers for vehicles; shock absorbers for vehicles; shock absorbers for motor vehicles; shock absorbers for automobiles; brakes for land vehicles; anti-lock brake apparatus for vehicles (parts of vehicles); vehicle disc brakes; vehicle brake calipers.

(260) AM 2015 77925 A
(800) 1207734
(891) 2014 04 18
(731) BALTIKA BREWERIES
3, 6-th Verkhny pereulok, RU-194292
Saint-Petersburg, RU

(540)
КОЛЛЕКЦИЯ ПИВОВАРА
(511)
32 – Non-alcoholic beverages; beer-based beverages; beer; de-alcoholized beer; ginger beer; malt beer; preparations for making beverages; beer wort; malt wort; extracts of hops for making beer.

(260) AM 2015 78335 A
(800) 1211070
(891) 2014 05 30
(731) BEIERSDORF AG
Unnastrasse 48, 20253 Hamburg, DE
(540)

NIVEA CARE & COLOR

(511)
3 – Soaps, perfumery, cosmetics, cosmetic lip care preparations.

(260) AM 2015 78336 A
(800) 1211071
(891) 2014 05 05
(731) EGIS GYÓGYSZERGYÁR Zrt.
Keresztúri út 30-38, H-1106 Budapest, HU
(540)

EVERALL

(511)
5 – Pharmaceutical preparations for human use.

(260) AM 2015 80600 A
(800) 519618B
(891) 2013 08 09
(731) DECOR Sociedad de Responsabilidad
Limitada
Calle Lesnaya, n° 12, inmueble 7, distrito
Chejovskiy, pueblo Ivachkovo, RU-142350
Region de Moscú, RU
(540)

GAUDI

(511)
2 – Paints, varnishes, lacquers; preservatives against rust and against deterioration of wood; dyestuffs; mordants; raw natural resins; metals in foil and powder form for painters, decorators, printers and artists.
19 – Non-metallic building materials; rigid pipes, not of metal, for building; asphalt, pitch and bitumen; transportable buildings, not of metal; monuments, not of metal.

**საერთაშორისო სასაქონლო ნიშნები,
რომლებსაც მიენიჭა დაცვა საქართველოში**

(260) AM 2014 72500 A
(800) 1095003
(151) 2011 07 11
(891) 2013 03 26
(181) 2021 07 11
(511) 12

(260) AM 2014 74384 A
(800) 1177229
(151) 2013 07 11
(181) 2023 07 11
(511) 35, 36, 41

(260) AM 2014 72937 A
(800) 1163329
(151) 2013 05 02
(181) 2023 05 02
(511) 05

(260) AM 2014 74408 A
(800) 1177543
(151) 2013 08 09
(181) 2023 08 09
(511) 03

(260) AM 2014 73193 A
(800) 1165890
(151) 2013 04 25
(181) 2023 04 25
(511) 19

(260) AM 2014 74409 A
(800) 1177545
(151) 2013 08 29
(181) 2023 08 29
(511) 05

(260) AM 2014 73259 A
(800) 1167184
(151) 2013 04 10
(181) 2023 04 10
(511) 34, 35

(260) AM 2014 74410 A
(800) 1177572
(151) 2013 07 09
(181) 2023 07 09
(511) 05

(260) AM 2014 73504 A
(800) 1169696
(151) 2013 01 24
(181) 2023 01 24
(511) 32, 33

(260) AM 2014 74411 A
(800) 1177573
(151) 2013 07 09
(181) 2023 07 09
(511) 05

(260) AM 2014 74084 A
(800) 1174590
(151) 2013 01 29
(181) 2023 01 29
(511) 03

(260) AM 2014 74412 A
(800) 1177574
(151) 2013 07 09
(181) 2023 07 09
(511) 05

(260) AM 2014 74338 A
(800) 1128193
(151) 2012 08 06
(891) 2013 07 04
(181) 2022 08 06
(511) 03, 14, 18, 25

(260) AM 2014 74413 A
(800) 1177575
(151) 2013 09 04
(181) 2023 09 04
(511) 05

(260) AM 2014 74414 A
(800) 1177576
(151) 2013 07 09

(181) 2023 07 09
(511) 05

(260) AM 2014 74415 A
(800) 1177577
(151) 2013 07 09
(181) 2023 07 09
(511) 05

(260) AM 2014 74416 A
(800) 1177611
(151) 2012 11 28
(181) 2022 11 28
(511) 09, 35, 38, 42

(260) AM 2014 74417 A
(800) 1177624
(151) 2013 03 19
(181) 2023 03 19
(511) 12

(260) AM 2014 74418 A
(800) 1177626
(151) 2013 05 10
(181) 2023 05 10
(511) 29, 30, 32

(260) AM 2014 74419 A
(800) 1177629
(151) 2013 05 17
(181) 2023 05 17
(511) 33

(260) AM 2014 74420 A
(800) 1177632
(151) 2013 04 03
(181) 2023 04 03
(511) 05

(260) AM 2014 74421 A
(800) 1177647
(151) 2013 07 04
(181) 2023 07 04
(511) 34

(260) AM 2014 74520 A
(800) 946987
(151) 2007 11 12
(891) 2013 03 18
(181) 2017 11 12
(511) 19, 37

(260) AM 2014 74523 A
(800) 1112236
(151) 2012 03 05
(891) 2013 06 19
(181) 2022 03 05
(511) 05, 10, 35, 42

(260) AM 2014 74526 A
(800) 1127873
(151) 2012 02 08
(891) 2013 04 19
(181) 2022 02 08
(511) 30, 35

(260) AM 2014 74626 A
(800) 1079662
(151) 2011 01 24
(181) 2021 01 24
(511) 06, 17, 19

(260) AM 2014 74627 A
(800) 1179723
(151) 2013 07 16
(181) 2023 07 16
(511) 10

(260) AM 2014 74628 A
(800) 1179729
(151) 2013 06 14
(181) 2023 06 14
(511) 09, 36, 42

(260) AM 2014 74629 A
(800) 1179734
(151) 2013 08 07
(181) 2023 08 07
(511) 25

(260) AM 2014 74631 A
(800) 1179757
(151) 2013 08 05
(181) 2023 08 05
(511) 05, 10

(260) AM 2014 74633 A
(800) 1179775
(151) 2013 08 23
(181) 2023 08 23
(511) 05

(260) AM 2014 74635 A
 (800) 1179777
 (151) 2013 08 23
 (181) 2023 08 23
 (511) 05

(260) AM 2014 74839 A
 (800) 1181313
 (151) 2013 09 16
 (181) 2023 09 16
 (511) 04

(260) AM 2014 74638 A
 (800) 1179778
 (151) 2013 08 23
 (181) 2023 08 23
 (511) 05

(260) AM 2014 74840 A
 (800) 1181325
 (151) 2013 09 19
 (181) 2023 09 19
 (511) 01, 02, 03, 04, 05

(260) AM 2014 74639 A
 (800) 1179779
 (151) 2013 08 23
 (181) 2023 08 23
 (511) 05

(260) AM 2014 74841 A
 (800) 1181408
 (151) 2013 03 08
 (181) 2023 03 08
 (511) 16, 28

(260) AM 2014 74640 A
 (800) 1179794
 (151) 2013 08 27
 (181) 2023 08 27
 (511) 30

(260) AM 2014 74842 A
 (800) 1181455
 (151) 2013 08 27
 (181) 2023 08 27
 (511) 29, 30, 43

(260) AM 2014 74643 A
 (800) 1179832
 (151) 2013 08 13
 (181) 2023 08 13
 (511) 43

(260) AM 2014 74843 A
 (800) 1181476
 (151) 2013 09 20
 (181) 2023 09 20
 (511) 18, 20, 22

(260) AM 2014 74644 A
 (800) 1179852
 (151) 2013 08 22
 (891)
 (181) 2023 08 22
 (511) 09, 10

(260) AM 2014 74844 A
 (800) 1181513
 (151) 2013 08 20
 (181) 2023 08 20
 (511) 01, 17, 19, 22

(260) AM 2014 74676 A
 (800) 1180248
 (151) 2012 11 26
 (181) 2022 11 26
 (511) 03, 35, 44

(260) AM 2014 74845 A
 (800) 1181551
 (151) 2013 09 20
 (181) 2023 09 20
 (511) 05

(260) AM 2014 74696 A
 (800) 1180402
 (151) 2013 09 14
 (181) 2023 09 14
 (511) 07

(260) AM 2014 74848 A
 (800) 1181552
 (151) 2013 09 20
 (181) 2023 09 20
 (511) 05

(260) AM 2014 74858 A
 (800) 1181553
 (151) 2013 09 20

(181) 2023 09 20
(511) 05

(260) AM 2014 74859 A
(800) 1181554
(151) 2013 09 20
(181) 2023 09 20
(511) 05

(260) AM 2014 74860 A
(800) 1181560
(151) 2013 01 31
(181) 2023 01 31
(511) 01, 03, 05, 09, 21, 37, 40, 42, 44

(260) AM 2014 74861 A
(800) 1181561
(151) 2013 03 01
(181) 2023 03 01
(511) 03

(260) AM 2014 74862 A
(800) 1181580
(151) 2013 08 30
(181) 2023 08 30
(511) 05

(260) AM 2014 74863 A
(800) 1181622
(151) 2013 05 14
(181) 2023 05 14
(511) 05

(260) AM 2014 74864 A
(800) 1181642
(151) 2013 05 14
(181) 2023 05 14
(511) 05

(260) AM 2014 74865 A
(800) 1181654
(151) 2013 06 18
(181) 2023 06 18
(511) 05, 09

(260) AM 2014 74866 A
(800) 1181655
(151) 2013 06 18
(181) 2023 06 18
(511) 05, 09

(260) AM 2014 74867 A
(800) 1181658
(151) 2013 07 17
(181) 2023 07 17
(511) 05

(260) AM 2014 74871 A
(800) 1181683
(151) 2013 09 12
(181) 2023 09 12
(511) 03

(260) AM 2014 74872 A
(800) 1181691
(151) 2013 08 08
(181) 2023 08 08
(511) 05

(260) AM 2014 74876 A
(800) 1181704
(151) 2013 08 02
(181) 2023 08 02
(511) 29, 30

(260) AM 2014 74877 A
(800) 1181717
(151) 2013 09 04
(181) 2023 09 04
(511) 33

(260) AM 2014 74878 A
(800) 1181732
(151) 2013 09 04
(181) 2023 09 04
(511) 03

(260) AM 2014 74879 A
(800) 1181817
(151) 2013 07 06
(181) 2023 07 06
(511) 09, 25, 41

(260) AM 2014 74880 A
(800) 1181858
(151) 2013 07 25
(181) 2023 07 25
(511) 03, 04, 05, 11, 21

(260) AM 2014 74881 A
(800) 1181873
(151) 2013 08 13

(181) 2023 08 13
(511) 11, 20, 21

(260) AM 2014 74882 A
(800) 1181894
(151) 2013 10 03
(181) 2023 10 03
(511) 09

(260) AM 2014 74884 A
(800) 1181933
(151) 2013 07 08
(181) 2023 07 08
(511) 07, 09, 37, 42

(260) AM 2014 74885 A
(800) 1181935
(151) 2012 12 13
(181) 2022 12 13
(511) 10, 20, 24, 35

(260) AM 2014 74886 A
(800) 1181941
(151) 2013 09 30
(181) 2023 09 30
(511) 16, 25, 41

(260) AM 2014 74887 A
(800) 1181979
(151) 2013 06 04
(181) 2023 06 04
(511) 01, 02, 03, 09, 14, 25, 29, 32, 35, 36, 38, 41, 43

(260) AM 2014 74888 A
(800) 1181984
(151) 2013 07 04
(181) 2023 07 04
(511) 09, 28, 41

(260) AM 2014 74891 A
(800) 1181985
(151) 2013 06 12
(181) 2023 06 12
(511) 05

(260) AM 2014 74892 A
(800) 1182006
(151) 2013 09 19
(181) 2023 09 19
(511) 09

(260) AM 2014 74893 A
(800) 1182022
(151) 2013 10 02
(181) 2023 10 02
(511) 09

(260) AM 2014 74894 A
(800) 1182037
(151) 2013 08 13
(181) 2023 08 13
(511) 09, 16, 41

(260) AM 2014 74895 A
(800) 356682
(151) 1969 04 09
(891) 2013 06 21
(181) 2019 04 09
(511) 03

(260) AM 2014 74897 A
(800) 521972
(151) 1988 03 14
(891) 2013 01 23
(181) 2018 03 14
(511) 05

(260) AM 2014 74898 A
(800) 541657
(151) 1989 07 20
(891) 2012 07 24
(181) 2019 07 20
(511) 03, 05

(260) AM 2014 74906 A
(800) 610307
(151) 1993 10 06
(891) 2013 10 07
(181) 2023 10 06
(511) 30

(260) AM 2014 74907 A
(800) 638240
(151) 1995 06 12
(891) 2013 07 24
(181) 2015 06 12
(511) 03, 05

(260) AM 2014 74908 A
(800) 682277
(151) 1997 10 23
(891) 2013 07 24

(181) 2017 10 23
(511) 25

(260) AM 2014 74909 A
(800) 748120
(151) 2000 11 08
(891) 2013 10 18
(181) 2020 11 08
(511) 34

(260) AM 2014 74910 A
(800) 770027
(151) 2001 11 05
(891) 2013 09 20
(181) 2021 11 05
(511) 07, 12

(260) AM 2014 74911 A
(800) 809597
(151) 2003 07 25
(891) 2013 07 30
(181) 2023 07 25
(511) 05, 10

(260) AM 2014 74913 A
(800) 868940
(151) 2005 09 30
(891) 2013 08 08
(181) 2015 09 30
(511) 25

(260) AM 2014 74914 A
(800) 973104
(151) 2008 06 11
(891) 2013 10 09
(181) 2018 06 11
(511) 09

(260) AM 2014 74915 A
(800) 1061373
(151) 2010 11 27
(891) 2013 10 09
(181) 2020 11 27
(511) 30

(260) AM 2014 74916 A
(800) 1109930
(151) 2011 11 11
(891) 2013 10 04
(181) 2021 11 11
(511) 05

(260) AM 2014 74917 A
(800) 1117930
(151) 2012 02 28
(891) 2013 08 13
(181) 2022 02 28
(511) 09, 16, 35, 36, 38, 41, 42

(260) AM 2014 74918 A
(800) 1138351
(151) 2012 05 22
(181) 2022 05 22
(511) 08

(260) AM 2014 74919 A
(800) 1138353
(151) 2012 05 22
(891) 2013 09 20
(181) 2022 05 22
(511) 43

(260) AM 2014 74943 A
(800) 1182355
(151) 2013 06 14
(181) 2023 06 14
(511) 05

(260) AM 2014 75051 A
(800) 1183430
(151) 2013 10 14
(181) 2023 10 14
(511) 09

(260) AM 2014 75054 A
(800) 1183453
(151) 2013 04 23
(181) 2023 04 23
(511) 11, 19, 20, 21

(260) AM 2014 75058 A
(800) 1183525
(151) 2013 08 23
(181) 2023 08 23
(511) 05

(260) AM 2014 75059 A
(800) 1183526
(151) 2013 08 28
(181) 2023 08 28
(511) 05

(260) AM 2014 75060 A
 (800) 1183527
 (151) 2013 08 23
 (181) 2023 08 23
 (511) 05

(260) AM 2014 75063 A
 (800) 1013583
 (151) 2009 07 17
 (891) 2009 10 23
 (181) 2019 07 17
 (511) 11, 21

(260) AM 2014 75067 A
 (800) 1068258
 (151) 2011 02 09
 (891) 2013 10 29
 (181) 2021 02 09
 (511) 09

(260) AM 2014 75072 A
 (800) 1145421
 (151) 2012 12 05
 (891) 2013 10 18
 (181) 2022 12 05
 (511) 09

(260) AM 2014 75160 A
 (800) 608854
 (151) 1993 07 30
 (181) 2023 07 30
 (891) 2013 09 30
 (511) 35, 36, 41, 42

(260) AM 2014 75161 A
 (800) 723616
 (151) 1999 10 26
 (181) 2019 10 26
 (891) 2013 09 30
 (511) 35, 36, 41, 42

(260) AM 2014 75163 A
 (800) 882927
 (151) 2006 02 10
 (181) 2016 02 10
 (891) 2013 10 18
 (511) 09, 16, 35, 36

(260) AM 2014 75165 A
 (800) 955296
 (151) 2008 01 25
 (181) 2018 01 25

(891) 2013 10 21
 (511) 12

(260) AM 2014 75166 A
 (800) 955488
 (151) 2008 02 26
 (181) 2018 02 26
 (891) 2013 10 03
 (511) 06, 07, 20

(260) AM 2014 75167 A
 (800) 1006702
 (151) 2009 04 16
 (181) 2019 04 16
 (891) 2013 12 17
 (511) 36, 42

(260) AM 2014 75168 A
 (800) 1009354
 (151) 2009 03 20
 (181) 2019 03 20
 (891) 2013 10 04
 (511) 01, 02, 03, 17, 19, 37, 41

(260) AM 2014 75169 A
 (800) 1124223
 (151) 2012 05 14
 (181) 2022 05 14
 (891) 2013 11 12
 (511) 09, 12

(260) AM 2014 75170 A
 (800) 1129175
 (151) 2012 07 25
 (181) 2022 07 25
 (891) 2013 10 28
 (511) 03

(260) AM 2014 75171 A
 (800) 1160226
 (151) 2013 03 06
 (181) 2023 03 06
 (891) 2013 08 13
 (511) 03

(260) AM 2014 75172 A
 (800) 1160448
 (151) 2013 04 25
 (181) 2023 04 25
 (891) 2013 11 07
 (511) 30

(260) AM 2014 75174 A
 (800) 1075367
 (151) 2010 07 19
 (181) 2020 07 19
 (891) 2013 09 04
 (511) 29, 30

(260) AM 2014 75175 A
 (800) 1057611
 (151) 2010 08 05
 (181) 2020 08 05
 (891) 2013 10 17
 (511) 29, 30, 31

(260) AM 2014 75205 A
 (800) 1184605
 (151) 2013 08 09
 (181) 2023 08 09
 (891) 2013 08 09
 (511) 28

(260) AM 2014 75253 A
 (800) 1184944
 (151) 2013 06 06
 (181) 2023 06 06
 (891) 2013 06 06
 (511) 14, 18, 20, 21

(260) AM 2014 75254 A
 (800) 1184970
 (151) 2013 09 18
 (181) 2023 09 18
 (891) 2013 09 18
 (511) 30

(260) AM 2014 75256 A
 (800) 1184978
 (151) 2013 09 20
 (181) 2023 09 20
 (891) 2013 09 20
 (511) 20

(260) AM 2014 75266
 (800) 1185108
 (151) 2013 07 24
 (181) 2023 07 24
 (891) 2013 07 24
 (511) 06

(260) AM 2014 75269 A
 (800) 1185136
 (151) 2013 09 03
 (181) 2023 09 03

(891) 2013 09 03
 (511) 05, 16, 35, 39

(260) AM 2014 75278 A
 (800) 1185246
 (151) 2013 11 11
 (181) 2023 11 11
 (891) 2013 11 11
 (511) 02

(260) AM 2014 75287 A
 (800) 1185302
 (151) 2013 07 29
 (181) 2023 07 29
 (891) 2013 07 29
 (511) 25, 28

(260) AM 2014 75289 A
 (800) 1185341
 (151) 2013 10 01
 (181) 2023 01 10
 (891) 2013 10 01
 (511) 05

(260) AM 2014 75290 A
 (800) 1185421
 (151) 2013 11 01
 (181) 2023 11 01
 (891) 2013 11 01
 (511) 32, 33

(260) AM 2014 75291 A
 (800) 1185498
 (151) 2013 10 16
 (181) 2023 10 16
 (891) 2013 10 16
 (511) 43

(260) AM 2014 75293 A
 (800) 1185506
 (151) 2013 09 20
 (181) 2023 09 20
 (891) 2013 09 20
 (511) 07, 17, 20

(260) AM 2014 75294 A
 (800) 1185531
 (151) 2013 10 09
 (181) 2023 10 09
 (891) 2013 10 09
 (511) 05

(260) AM 2014 75295 A
 (800) 1185542
 (151) 2013 10 21
 (181) 2023 10 21
 (891) 2013 10 21
 (511) 01, 02, 17, 19

(891) 2012 11 21
 (511) 01, 02, 06, 09, 11, 19, 27

(260) AM 2014 75296 A
 (800) 1185544
 (151) 2013 09 16
 (181) 2023 09 16
 (891) 2013 09 16
 (511) 30

(260) AM 2014 75328 A
 (800) 1185682
 (151) 2013 07 08
 (181) 2023 07 08
 (891) 2013 07 08
 (511) 34, 35, 43

(260) AM 2014 75298 A
 (800) 1185560
 (151) 2013 10 18
 (181) 2023 10 18
 (891) 2013 10 18
 (511) 05

(260) AM 2014 75329 A
 (800) 1185685
 (151) 2013 06 18
 (181) 2023 06 18
 (891) 2013 06 18
 (511) 03

(260) AM 2014 75308 A
 (800) 1185600
 (151) 2013 11 20
 (181) 2023 11 20
 (891) 2013 11 20
 (511) 03, 10, 21

(260) AM 2014 75330 A
 (800) 1185687
 (151) 2013 07 24
 (181) 2023 07 24
 (891) 2013 07 24
 (511) 34, 39, 41, 43

(260) AM 2014 75310 A
 (800) 1185602
 (151) 2013 11 01
 (181) 2023 11 01
 (891) 2013 11 01
 (511) 32, 33

(260) AM 2014 75333 A
 (800) 1185705
 (151) 2013 08 20
 (181) 2023 08 20
 (891) 2013 08 20
 (511) 03, 09, 14, 18, 25

(260) AM 2014 75312 A
 (800) 1185603
 (151) 2013 11 01
 (181) 2023 11 01
 (891) 2013 11 01
 (511) 32, 33

(260) AM 2014 75334 A
 (800) 1185723
 (151) 2013 10 04
 (181) 2023 10 04
 (891) 2013 10 04
 (511) 03

(260) AM 2014 75313 A
 (800) 1185604
 (151) 2013 11 01
 (181) 2023 11 01
 (891) 2013 11 01
 (511) 32, 33

(260) AM 2014 75335 A
 (800) 1185729
 (151) 2013 10 16
 (181) 2023 10 16
 (891) 2013 10 16
 (511) 01

(260) AM 2014 75327 A
 (800) 1185663
 (151) 2012 11 21
 (181) 2022 11 21

(260) AM 2014 75336 A
 (800) 1185747
 (151) 2013 09 03
 (181) 2025 03 31
 (891) 2013 09 03
 (511) 05

(260) AM 2014 75355 A
(800) 1186028
(151) 2013 09 20
(181) 2023 09 20
(891) 2013 09 20
(511) 05

(260) AM 2014 75356 A
(800) 1186029
(151) 2013 09 20
(181) 2023 09 20
(891) 2013 09 20
(511) 05

(260) AM 2014 75357 A
(800) 1186030
(151) 2013 09 20
(181) 2023 09 20
(891) 2013 09 20
(511) 05

(260) AM 2014 75358 A
(800) 1186053
(151) 2013 10 02
(181) 2023 10 02
(891) 2013 10 02
(511) 33

(260) AM 2014 75359 A
(800) 1186060
(151) 2013 09 20
(181) 2023 09 20
(891) 2013 09 20
(511) 05

(260) AM 2014 75422 A
(800) 1186467
(151) 2013 10 31
(181) 2023 10 31
(891) 2013 10 31
(511) 33

(260) AM 2014 75433 A
(800) 1186573
(151) 2013 10 08
(181) 2023 10 08
(891) 2013 10 08
(511) 09

(260) AM 2014 75621 A
(800) 1188852
(151) 2013 10 08
(181) 2023 10 08

(891) 2013 10 08
(511) 03, 18, 25

(260) AM 2014 75939 A
(800) 1191188
(151) 2013 11 08
(181) 2023 11 08
(891) 2013 11 08
(511) 12, 35

(260) AM 2014 76095 A
(800) 1192722
(151) 2013 04 09
(181) 2023 04 09
(891) 2013 04 09
(511) 06, 07, 11, 37

(260) AM 2014 76907 A
(800) 1199125
(151) 2014 01 30
(181) 2024 01 30
(891) 2014 01 30
(511) 32

საქონლის ადგილწარმოშობის დასახელებები და გეოგრაფიული აღნიშვნები

რეგისტრირებული ადგილწარმოშობის დასახელება

ეროვნული რეგისტრაციის №849
ეროვნული რეგისტრაციის თარიღი: 2015-03-23
საერთაშორისო რეგისტრაციის №925
საერთაშორისო რეგისტრაციის თარიღი: 2014 05 05
საქონლის ადგილწარმოშობის დასახელება: **CACIOCAVALLO SILANO**
ქვეყნის კოდი: IT იტალია
საქონელი: 29 - Cheese.

ეროვნული რეგისტრაციის №850
ეროვნული რეგისტრაციის თარიღი: 2015-03-23
საერთაშორისო რეგისტრაციის №926
საერთაშორისო რეგისტრაციის თარიღი: 2014 05 05
საქონლის ადგილწარმოშობის დასახელება: **COTECHINO MODENA**
ქვეყნის კოდი: IT იტალია
საქონელი: 29 - Meat products.

ეროვნული რეგისტრაციის №851
ეროვნული რეგისტრაციის თარიღი: 2015-03-23
საერთაშორისო რეგისტრაციის №927
საერთაშორისო რეგისტრაციის თარიღი: 2014 05 05
საქონლის ადგილწარმოშობის დასახელება: **GORGONZOLA**
ქვეყნის კოდი: IT იტალია
საქონელი: 29 - Cheese.

ეროვნული რეგისტრაციის №852
ეროვნული რეგისტრაციის თარიღი: 2015-03-23
საერთაშორისო რეგისტრაციის №928
საერთაშორისო რეგისტრაციის თარიღი: 2014 05 05
საქონლის ადგილწარმოშობის დასახელება: **MELA ALTO ADIGE/SÜDTIROLER APFEL**
ქვეყნის კოდი: IT იტალია
საქონელი: 29 - Fruit, vegetables and cereals, fresh or processed.

ეროვნული რეგისტრაციის №853
ეროვნული რეგისტრაციის თარიღი: 2015-03-23
საერთაშორისო რეგისტრაციის №930
საერთაშორისო რეგისტრაციის თარიღი: 2014 05 05
საქონლის ადგილწარმოშობის დასახელება: **MORTADELLA BOLOGNA**
ქვეყნის კოდი: IT იტალია
საქონელი: 29 - Meat products.

მოქონალური შეცხოვნიებები

გამომონები

უფლებების გადაცემა

(2015 წლის I კვარტალი)

კატანტის ნომერი	ყოფილი კატანტაფლოზი (უფლების გადაცემა)	ახალი კატანტაფლოზი (უფლების მიმღები)	გადაცემის თარიღი
1	2	3	4
1842/2	<p>ობშესტვო ს ოგრანიჩენი ოტვეტსტვენოსტიუ „ედაპს-ლაზერი“ ულ. ლენინა, დ. 64, გ. კიევ, 02088, UA; გეორგი ვლადიმროვი ბეილინი ულ. დრაიზერა, დ. 20-a, კვ. 80, გ. კიევ, 02222, UA; ვლადიმირ ლეონიდოვი ვოზნი პრ-ტ პეტრა გრიგორენკო, დ. 28, კვ. 69, გ. კიევ, 02095, UA; ანდრეი ნიკოლაევი ტიმოშენკო ულ. პავლოვსკაია, დ. 26/41, კვ. 80, გ. კიევ, 01135, UA; იური გრიგორიევი სიდორენკო ულ. საკსაგანსკოვო, დ. 112ა, კვ. 8, გ. კიევ, 01033, UA</p>	<p>ობშესტვო ს ოგრანიჩენი ოტვეტსტვენოსტიუ „სპეციალიზიროვანოი პრედპრიატიუ „გოლოგრაფია“ ულ. გრუშევსკოვო, 34/1, ოფის 29, გ. კიევ, 01021, UA; გეორგი ვლადიმროვი ბეილინი ულ. დრაიზერა, დ. 20-a, კვ. 80, გ. კიევ, 02222, UA; ანდრეი ნიკოლაევი ტიმოშენკო ულ. პავლოვსკაია, დ. 26/41, კვ. 80, გ. კიევ, 01135, UA; იური გრიგორიევი სიდორენკო ულ. საკსაგანსკოვო, დ. 112-a, კვ. 8, გ. კიევ, 01033, UA; ვლადიმირ ლეონიდოვი ვოზნი პრ-ტ პეტრა გრიგორენკო, დ. 28, კვ. 69, გ. კიევ, 02095, UA</p>	1/12/2015
2678/1	<p>გლაქსო გრუპ ლიმიტედ 980 გრეიტ უესტ როუდი, ბრენტფორდი, მიდლსექსი TW8 9GS, GB</p>	<p>გლაქსოსმიოკლაინ ლლკ კორპორაციის მომსახურების კომპანია 2711 სენტერვილე როუდ, სუიტ 400, უილმინგტონი, დელავერის შტატი, 19808, US</p>	2/3/2015
5749/1	<p>პაატა გოგოლაძე კუტუხოვის ქ. 3, 0194, თბილისი, GE</p>	<p>შპს „ბაზალტ ფაიბერს“ გორგასალის ქ. 61, თბილისი, GE</p>	2/3/2015
4887/1	<p>მედარექს, ლ.ლ.კ. როუტ 206 ენდ პროვინს ლაინ როუდ პრინსტონი, ნიუ-ჯერსი 08540, US</p>	<p>ი. არ. სქუიბ & სანს, ლ.ლ.კ. როუტ 206 ენდ პროვინს ლაინ როუდ, პრინსტონი, ნიუ-ჯერსი 08540, US</p>	2/26/2015
3810/1	<p>სადია ს/ა. რუა სენადორ ატილიო F.X., ფონტანა, 86, 89700-კონკორდია-SC, BR</p>	<p>ბრფ-ბრაზილ ფუდს ს.ა. რუ ჟორჯი ტაშელ, 475 ფაზენდა, სითი ოვ იტაუაი, სანტა-კატარინას შტატი, BR</p>	3/30/2015
5149/1	<p>დოიხე ამპიბოლინ-ვერკე ფონ რობერტ მურიან სტიფტუნგ & კო კგ როსდორფერ შტრასე 50, 64372 ობერ-რამშტადტი, DE</p>	<p>დავ სე როსდორფერ შტრასე 50, 64372, ობერ-რამშტადტი, DE</p>	3/30/2015

კატენდოლოზების და/ან მისამართის ცვლილებები
(2015 წლის I კვარტალი)

კატენდის ნომერი	ძველი სახელწოდება და/ან მისამართი	ახალი სახელწოდება და/ან მისამართი	ცვლილების თარიღი
5432/1	იუნიმედ ფარმასიუტიკალს, ლლკ 901 სოიერ როად, მარიეტა, ჯორჯია 30062, US; ბესინს ჰელზქეარ ლუქსემბურგ 67, ბულვარდ გრანდუ-დუჩესე შარლოტ ლ-1331 ლუქსემბურგი, ლუქსემბურგის დიდი საგრაფო, LU	იუნიმედ ფარმასიუტიკალს, ლლკ 901 სოიერ როად, მარიეტა, ჯორჯია 30062, US; ბესინს ჰელზქეარ ლუქსემბურგ სარლ 67, ბულვარდ გრანდუ-დუჩესე შარლოტ ლ-1331 ლუქსემბურგი, ლუქსემბურგის დიდი საჰერცოგო, LU	1/6/2015
2678/1	გლაქსო გრუპ ლიმიტიდ გლაქსო ველქამ ჰაუს ბერკლი ავენიუ, გრინფორდი, მიდლსექსი UB6 ONN, GB	გლაქსო გრუპ ლიმიტიდ 980 გრეიტ უესტ როუდი, ბრენტფორდი, მიდლსექსი TW8 9GS, GB	2/3/2015
3412/1	კერ-მაკჯი ქემიკალ ლლკ კერ-მაკჯი სენტრ, ოკლაჰომა სიტი, OK 73125, US	ტრონოქს ლლკ კერ-მაკჯი სენტრ, ოკლაჰომა სიტი, OK 73125, US	2/23/2015
4804/1	ბრისტოლ-მაიერს სკუიბ ჰოლდინგს აირლენდ ნეუჰოფშტრასე 6, CH-6340 ბერი, CH	ბრისტოლ-მაიერს სკუიბ ჰოლდინგს აირლენდ ჰინტერბერგშტრასე 16, 6312 შტაინჰაუსენ, CH	3/30/2015
3810/1	ბრფ-ბრაზილ ფუდზ ს.ა. რუ ჟორჯი ტზაშელ, 475 ფაზენდა, სითი ოვ იტაჟაი, სანტა-კატარინას შტატი, BR	ბრფ ს.ა. რუ ჟორჯი ტზაშელ 475 ფაზენდა, სითი ოვ იტაჟაი, სანტა-კატარინას შტატი, BR	3/31/2015

კატენდების მოქმედების ვადის ამონაწერა
გამოზონებები

№	რეგისტრაციის ნომერი	ვადის გასვლის თარიღი
1.	1765	2/16/2014
2.	1773	4/27/2014
3.	1956	9/13/2014
4.	2209	10/7/2014
5.	2387	12/22/2014
6.	2421	5/9/2014
7.	2513	9/7/2014
8.	2581	3/18/2014
9.	3548	11/19/2014

სასარგებლო მოდელები

№	რეგისტრაციის ნომერი	ვადის განვლის თარიღი
1.	1208	2/17/2014
2.	1267	8/4/2014
3.	1299	2/15/2014
4.	1331	6/27/2014
5.	1341	7/7/2014
6.	1346	4/12/2014

ბალანსვეტილება კატეგორიის გაუქმების შესახებ
გამოგონებები

№	რეგისტრაციის ნომერი	გაუქმების თარიღი
1	2	3
1.	1226	11/10/2014
2.	1435	11/10/2014
3.	1515	11/10/2014
4.	1611	11/10/2014
5.	1778	11/10/2014
6.	1780	11/10/2014
7.	1818	5/22/2014
8.	1848	11/10/2014
9.	1966	11/10/2014
10.	2009	11/10/2014
11.	2015	11/10/2014
12.	2050	11/10/2014
13.	2095	11/10/2014
14.	2188	11/10/2014
15.	2238	11/10/2014
16.	2247	11/10/2014
17.	2385	11/10/2014
18.	2488	3/13/2014
19.	2492	11/10/2014
20.	2499	11/10/2014
21.	2720	11/10/2014
22.	2725	12/29/2014
23.	2887	3/12/2014
24.	2910	11/10/2014
25.	2977	11/10/2014
26.	3088	11/10/2014
27.	3104	11/10/2014
28.	3120	11/10/2014
29.	3178	1/15/2014
30.	3295	11/10/2014
31.	3379	11/10/2014
32.	3408	11/10/2014
33.	3444	3/11/2014
34.	3487	11/10/2014
35.	3491	11/10/2014

1	2	3
36.	3534	7/31/2014
37.	3539	11/10/2014
38.	3594	12/29/2014
39.	3606	11/10/2014
40.	3636	11/10/2014
41.	3648	11/10/2014
42.	3726	11/10/2014
43.	3772	11/10/2014
44.	3805	11/10/2014
45.	3841	2/28/2014
46.	3883	11/10/2014
47.	3896	11/10/2014
48.	3958	12/29/2014
49.	3964	11/10/2014
50.	3973	11/10/2014
51.	4005	11/10/2014
52.	4006	11/10/2014
53.	4035	11/10/2014
54.	4044	11/10/2014
55.	4056	11/10/2014
56.	4082	11/10/2014
57.	4091	11/10/2014
58.	4103	11/10/2014
59.	4114	11/10/2014
60.	4120	11/10/2014
61.	4159	11/10/2014
62.	4194	11/10/2014
63.	4210	11/10/2014
64.	4219	11/10/2014
65.	4250	11/10/2014
66.	4276	11/10/2014
67.	4292	11/10/2014
68.	4293	11/10/2014
69.	4304	11/10/2014
70.	4307	11/10/2014
71.	4318	11/10/2014
72.	4321	11/10/2014
73.	4348	11/10/2014
74.	4357	11/10/2014
75.	4373	11/10/2014
76.	4392	11/10/2014
77.	4406	11/10/2014
78.	4417	11/10/2014
79.	4419	12/29/2014
80.	4421	11/10/2014
81.	4423	11/10/2014
82.	4452	11/10/2014
83.	4455	11/10/2014
84.	4488	11/10/2014
85.	4499	11/10/2014
86.	4502	11/10/2014

1	2	3
87.	4514	8/19/2014
88.	4519	11/10/2014
89.	4527	11/10/2014
90.	4544	11/10/2014
91.	4557	11/10/2014
92.	4566	11/10/2014
93.	4572	11/10/2014
94.	4583	11/10/2014
95.	4590	9/30/2014
96.	4602	11/10/2014
97.	4620	11/10/2014
98.	4638	11/10/2014
99.	4644	12/29/2014
100.	4676	11/10/2014
101.	4682	11/10/2014
102.	4699	11/10/2014
103.	4700	12/29/2014
104.	4713	12/29/2014
105.	4728	9/30/2014
106.	4749	12/29/2014
107.	4754	1/30/2014
108.	4755	1/30/2014
109.	4760	11/10/2014
110.	4761	11/10/2014
111.	4775	1/30/2014
112.	4785	12/29/2014
113.	4801	11/10/2014
114.	4822	9/30/2014
115.	4824	12/10/2014
116.	4826	11/10/2014
117.	4841	11/10/2014
118.	4844	11/10/2014
119.	4848	11/10/2014
120.	4849	11/10/2014
121.	4868	1/30/2014
122.	4875	11/10/2014
123.	4878	6/30/2014
124.	4912	6/30/2014
125.	4913	1/30/2014
126.	4919	1/30/2014
127.	4926	11/10/2014
128.	4928	1/30/2014
129.	4930	1/30/2014
130.	4937	12/29/2014
131.	4946	1/30/2014
132.	4947	1/30/2014
133.	4956	12/29/2014
134.	4959	11/10/2014
135.	4967	1/30/2014
136.	4968	1/30/2014
137.	4975	12/29/2014

1	2	3
138.	4991	12/29/2014
139.	4996	1/30/2014
140.	5005	1/30/2014
141.	5013	12/29/2014
142.	5020	7/30/2014
143.	5022	11/10/2014
144.	5035	1/30/2014
145.	5045	1/30/2014
146.	5065	1/30/2014
147.	5073	9/30/2014
148.	5076	12/29/2014
149.	5087	1/30/2014
150.	5097	11/10/2014
151.	5099	6/30/2014
152.	5102	1/30/2014
153.	5107	1/30/2014
154.	5111	11/10/2014
155.	5114	1/30/2014
156.	5115	12/29/2014
157.	5116	1/30/2014
158.	5123	9/30/2014
159.	5124	9/30/2014
160.	5129	1/30/2014
161.	5130	2/21/2014
162.	5138	9/30/2014
163.	5141	12/29/2014
164.	5151	1/30/2014
165.	5154	11/10/2014
166.	5162	1/30/2014
167.	5164	1/30/2014
168.	5165	1/30/2014
169.	5172	1/30/2014
170.	5173	1/30/2014
171.	5174	1/30/2014
172.	5188	1/30/2014
173.	5192	1/30/2014
174.	5202	1/30/2014
175.	5211	12/29/2014
176.	5213	1/30/2014
177.	5214	3/2/2014
178.	5216	12/29/2014
179.	5219	1/30/2014
180.	5230	9/30/2014
181.	5233	1/30/2014
182.	5234	1/30/2014
183.	5236	1/30/2014
184.	5237	12/29/2014
185.	5238	1/30/2014
186.	5239	12/29/2014
187.	5240	1/30/2014
188.	5242	1/30/2014

1	2	3
189.	5250	1/30/2014
190.	5254	12/29/2014
191.	5257	1/30/2014
192.	5260	12/29/2014
193.	5262	1/30/2014
194.	5269	12/29/2014
195.	5271	12/29/2014
196.	5275	3/25/2014
197.	5285	12/29/2014
198.	5295	3/25/2014
199.	5303	1/30/2014
200.	5307	1/30/2014
201.	5312	1/30/2014
202.	5315	5/30/2014
203.	5328	1/30/2014
204.	5329	1/30/2014
205.	5334	1/30/2014
206.	5339	12/29/2014
207.	5352	1/30/2014
208.	5358	12/29/2014
209.	5365	12/29/2014
210.	5368	12/29/2014
211.	5370	12/29/2014
212.	5371	12/29/2014
213.	5374	1/30/2014
214.	5376	3/25/2014
215.	5379	12/29/2014
216.	5381	1/30/2014
217.	5384	11/10/2014
218.	5386	1/30/2014
219.	5389	12/29/2014
220.	5390	12/29/2014
221.	5393	12/29/2014
222.	5399	6/30/2014
223.	5400	1/30/2014
224.	5401	12/29/2014
225.	5415	1/30/2014
226.	5417	3/10/2014
227.	5419	1/30/2014
228.	5421	12/29/2014
229.	5422	2/17/2014
230.	5423	5/30/2014
231.	5434	1/30/2014
232.	5437	12/29/2014
233.	5442	12/29/2014
234.	5443	12/29/2014
235.	5453	12/29/2014
236.	5457	12/30/2014
237.	5468	12/29/2014
238.	5477	1/30/2014
239.	5478	1/30/2014

1	2	3
240.	5479	12/29/2014
241.	5482	1/30/2014
242.	5483	1/30/2014
243.	5484	1/30/2014
244.	5486	1/30/2014
245.	5490	7/22/2014
246.	5493	2/17/2014
247.	5494	3/25/2014
248.	5496	3/25/2014
249.	5497	3/25/2014
250.	5507	1/30/2014
251.	5510	12/29/2014
252.	5513	1/30/2014
253.	5516	11/10/2014
254.	5523	7/22/2014
255.	5527	12/29/2014
256.	5529	1/30/2014
257.	5536	3/25/2014
258.	5542	11/10/2014
259.	5544	12/29/2014
260.	5545	12/29/2014
261.	5549	12/29/2014
262.	5551	12/29/2014
263.	5553	11/10/2014
264.	5554	9/30/2014
265.	5557	1/30/2014
266.	5558	12/29/2014
267.	5560	12/29/2014
268.	5581	12/29/2014
269.	5587	5/30/2014
270.	5588	12/29/2014
271.	5590	12/29/2014
272.	5598	3/10/2014
273.	5601	5/30/2014
274.	5606	12/29/2014
275.	5607	1/30/2014
276.	5613	12/29/2014
277.	5614	1/30/2014
278.	5616	12/29/2014
279.	5617	7/22/2014
280.	5619	5/30/2014
281.	5623	2/17/2014
282.	5628	12/29/2014
283.	5632	1/30/2014
284.	5633	3/25/2014
285.	5634	3/25/2014
286.	5635	12/29/2014
287.	5639	2/17/2014
288.	5641	12/29/2014
289.	5644	12/29/2014
290.	5645	12/29/2014

1	2	3
291.	5647	12/29/2014
292.	5654	12/29/2014
293.	5655	9/30/2014
294.	5659	12/29/2014
295.	5662	6/23/2014
296.	5663	6/21/2014
297.	5665	12/29/2014
298.	5667	12/29/2014
299.	5670	1/30/2014
300.	5675	3/11/2014
301.	5683	12/29/2014
302.	5692	12/29/2014
303.	5694	12/29/2014
304.	5695	12/29/2014
305.	5696	5/14/2014
306.	5698	2/17/2014
307.	5699	12/29/2014
308.	5705	5/30/2014
309.	5706	11/10/2014
310.	5713	12/29/2014
311.	5717	9/10/2014
312.	5728	12/29/2014
313.	5733	12/29/2014
314.	5777	12/29/2014
315.	5797	12/29/2014
316.	5799	12/29/2014
317.	5823	12/29/2014
318.	5825	6/23/2014
319.	5834	12/29/2014
320.	5835	12/29/2014
321.	5836	12/29/2014
322.	5837	12/29/2014
323.	5854	12/29/2014
324.	5868	12/29/2014
325.	5869	12/29/2014
326.	5894	12/29/2014
327.	5905	12/29/2014
328.	5948	12/29/2014

სასარგებლო მოდელები

№	რეგისტრაციის ნომერი	გაუქმების თარიღი
1	2	3
1.	1329	11/10/2014
2.	1339	11/10/2014
3.	1366	11/10/2014
4.	1369	12/29/2014
5.	1386	11/10/2014
6.	1405	11/10/2014
7.	1410	11/10/2014
8.	1422	11/10/2014
9.	1439	11/10/2014
10.	1443	11/10/2014
11.	1444	12/29/2014
12.	1465	11/10/2014
13.	1500	9/30/2014
14.	1504	1/30/2014
15.	1510	11/10/2014
16.	1516	6/30/2014
17.	1536	12/29/2014
18.	1544	7/30/2014
19.	1548	1/30/2014
20.	1553	12/29/2014
21.	1554	12/29/2014
22.	1557	1/30/2014
23.	1568	1/30/2014
24.	1583	12/29/2014
25.	1585	1/30/2014
26.	1589	12/29/2014
27.	1591	12/29/2014
28.	1595	1/30/2014
29.	1610	1/30/2014
30.	1612	12/29/2014
31.	1620	12/29/2014
32.	1623	12/29/2014
33.	1625	1/30/2014
34.	1628	1/30/2014
35.	1632	1/30/2014
36.	1641	1/30/2014
37.	1644	1/30/2014
38.	1646	1/30/2014
39.	1648	1/30/2014
40.	1652	1/30/2014
41.	1666	1/30/2014
42.	1677	12/29/2014
43.	1678	5/30/2014
44.	1680	5/30/2014
45.	1686	5/30/2014
46.	1687	1/30/2014
47.	1693	12/29/2014
48.	1696	12/29/2014
49.	1698	5/30/2014
50.	1713	12/29/2014
51.	1717	12/29/2014
52.	1718	12/29/2014
53.	1719	1/30/2014

1	2	3
54.	1721	1/30/2014
55.	1722	1/30/2014
56.	1726	1/30/2014
57.	1729	12/29/2014
58.	1735	12/29/2014
59.	1736	12/29/2014
60.	1739	12/29/2014
61.	1742	12/29/2014
62.	1749	1/30/2014
63.	1752	12/29/2014
64.	1754	12/29/2014

შეცდომების განხილვა

ბიულეტენის ნომერი	გამოქვეყნების ნომერი (10)	გვ.	სვეტი	თემა	უნდა იყოს
19(407) 2014წ.	AU 2014 13321 U	13	I	(31) 13321/2-GE (32) 2012 11 23 (33) GE	– – –
20(408) 2014წ.	AP 2014 12809 A	5	I	შეხვეტი: 7 დამო- კიდებული	შეხვეტი: 5 დამო- კიდებული
21(409) 2014წ.	AP 2014 12896 A	5	I	(32) 2011 04 10	(32) 2011 04 20

სასაქონლო ნიშნები

რეგისტრაციის მოქმედების ვადის გაგრძელება

(111) M 2005 15885 R1
(156) 2015 03 17
(186) 2025 03 01
(732) შპს „ბასტი-ბუბუ“
ვაჟა-ფშაველას გამზ. 76ბ, 0186,
თბილისი, საქართველო

(111) M 2005 15980 R1
(156) 2015 06 06
(186) 2025 06 06
(732) პფაიზერ ინკ.
დელავერის კორპორაცია
235 ისტ 42 სტრიტი, ნიუ-იორკი,
ნიუ-იორკი 10017, აშშ

(111) M 2005 16090 R1
(156) 2015 07 14
(186) 2025 07 14
(732) მარს, ინკორპორეტიდ
(დელავერის შტატის კორპორაცია)
6885 ელმ სტრიტი, მაკ-ლინი, ვირჯინია
22101-3883, აშშ

(111) M 2005 16161 R1
(156) 2015 08 16
(186) 2025 08 16
(732) მარს, ინკორპორეტიდ
(დელავერის შტატის კორპორაცია)
6885 ელმ სტრიტი, მაკ-ლინი, ვირჯინია
22101-3883, აშშ

(111) M 2005 16162 R1
(156) 2015 08 16
(186) 2025 08 16
(732) მარს, ინკორპორეტიდ
(დელავერის შტატის კორპორაცია)
6885 ელმ სტრიტი, მაკ-ლინი, ვირჯინია
22101-3883, აშშ

(111) M 2005 16171 R1
(156) 2015 08 30
(186) 2025 08 30
(732) მიქაელ ვარდანიანი
ბაირონის ქ. 3, ბ. 38, ერევანი, სომხეთი

(111) M 2005 16172 R1
(156) 2015 08 30
(186) 2025 08 30
(111) M 2007 017405 R
(732) მიქაელ ვარდანიანი
ბაირონის ქ. 3, ბ. 38, ერევანი, სომხეთი

(111) M 2005 16173 R1
(156) 2015 08 30
(186) 2025 08 30
(732) მიქაელ ვარდანიანი
ბაირონის ქ. 3, ბ. 38, ერევანი, სომხეთი

(111) M 2005 16174 R1
(156) 2015 08 30
(186) 2025 08 30
(732) მიქაელ ვარდანიანი
ბაირონის ქ. 3, ბ. 38, ერევანი, სომხეთი

(111) M 2005 16175 R1
(156) 2015 08 30
(186) 2025 08 30
(732) მიქაელ ვარდანიანი
ბაირონის ქ. 3, ბ. 38, ერევანი, სომხეთი

(111) M 2005 16176 R1
(156) 2015 08 30
(186) 2025 08 30
(732) მიქაელ ვარდანიანი
ბაირონის ქ. 3, ბ. 38, ერევანი, სომხეთი

(111) M 2005 16177 R1
(156) 2015 08 30
(186) 2025 08 30
(732) მიქაელ ვარდანიანი
ბაირონის ქ. 3, ბ. 38, ერევანი, სომხეთი

(111) M 2005 16178 R1
(156) 2015 08 30
(186) 2025 08 30
(732) მიქაელ ვარდანიანი
ბაირონის ქ. 3, ბ. 38, ერევანი, სომხეთი

(111) M 2005 16179 R1
(156) 2015 08 30
(186) 2025 08 30
(732) მიქაელ ვარდანიანი
ბაირონის ქ. 3, ბ. 38, ერევანი, სომხეთი

(111) M 2005 16180 R1
(156) 2015 08 30
(186) 2025 08 30
(732) მიქაელ ვარდანიანი
ბაირონის ქ. 3, ბ. 38, ერევანი, სომხეთი

(111) M 2005 16181 R1
(156) 2015 08 30
(186) 2025 08 30
(732) მიქაელ ვარდანიანი
ბაირონის ქ. 3, ბ. 38, ერევანი, სომხეთი

(111) M 2005 16182 R1
(156) 2015 08 30
(186) 2025 08 30
(732) მიქაელ ვარდანიანი
ბაირონის ქ. 3, ბ. 38, ერევანი, სომხეთი

(111) M 2005 16183 R1
(156) 2015 08 30
(186) 2025 08 30
(732) მიქაელ ვარდანიანი
ბაირონის ქ. 3, ბ. 38, ერევანი, სომხეთი

(111) M 2005 16184 R1
(156) 2015 08 30
(186) 2025 08 30
(732) მიქაელ ვარდანიანი
ბაირონის ქ. 3, ბ. 38, ერევანი, სომხეთი

(111) M 2005 16185 R1
(156) 2015 08 30
(186) 2025 08 30
(732) მიქაელ ვარდანიანი
ბაირონის ქ. 3, ბ. 38, ერევანი, სომხეთი

(111) M 2005 16234 R1
(156) 2015 09 28
(186) 2025 09 28
(732) მარს, ინკორპორეტიდ
(დელავერის შტატის კორპორაცია)
6885 ელმ სტრიტი, მაკ-ლინი, ვირჯინია
22101-3883, აშშ

(111) M 2005 16238 R1
(156) 2015 09 28
(186) 2025 09 28
(732) მიქაელ ვარდანიანი
ბაირონის ქ. 3, ბ. 38, ერევანი, სომხეთი

(111) M 1995 556 R2
(156) 2015 04 27
(186) 2025 04 27
(732) გაბა ინტერნაციონალ ჰოლდინგ აგ
გრაბეტსმათევე, CH-4106 თერვილი,
შვეიცარია

(111) M 1995 571 R2
(156) 2015 05 01
(186) 2025 05 01
(732) გაბა ინტერნაციონალ ჰოლდინგ აგ
გრაბეტსმათევე, CH-4106 თერვილი,
შვეიცარია

(111) M 1995 592 R2
(156) 2015 05 02
(186) 2025 05 02
(732) კოლეგიტ-პალმოლივ კომპანი
დელავერის შტატის კორპორაცია
300 პარკ ავენიუ, ნიუ-იორკი, ნიუ-იორკი
10022, აშშ

(111) M 1995 687 R2
(156) 2015 07 06
(186) 2025 07 06
(732) დაინერზ კლაბ ინტერნეშენელ ლტდ.,
ნიუ-იორკის კორპორაცია
2500 დეიკ ქუჩა როუდი, რივერვუდზი,
ილინოისი 60015, აშშ

(111) M 1995 980 R2
(156) 2015 09 21
(186) 2025 09 21
(732) როლექს სს
რიუ ფრანსუა-დიუსო 3-5-7, უენევა,
შვეიცარია

უფლებების სრული გადასვლა

(111) M 1999 012291 R1
 (732) ჰილტონ უორლდვაიდ ჰოლდინგ ლღპ
 მეიპლ ქორტ სენტრალ პარკი, რიდს
 ქრესენტი, უოტფორდი, WD24 4QQ,
 გაერთიანებული
 სამეფო
 (770) ჰლტ ინტერნეშენელ იპ ლღკ
 7930 ჯონს ბრენჩ დრაივი, სუიტი 1100
 მაკლინი, ვირჯინია 22102, აშშ
 (580) 2015 03 31

(111) M 2012 022831 R
 (732) ჰილტონ უორლდვაიდ ჰოლდინგ ლღპ
 მეიპლ ქორტ სენტრალ პარკი, რიდს
 ქრესენტი, უოტფორდი, WD24 4QQ,
 გაერთიანებული სამეფო
 (770) ჰლტ ინტერნეშენელ იპ ლღკ
 (დელავერის კორპორაცია)
 7930 ჯონს ბრენჩ დრაივი, სუიტი 1100
 მაკ-ლინი, ვირჯინია 22102, აშშ
 (580) 2015 03 31

(111) M 2010 020905 R
 (732) ფრილაბ ს.ა.
 რიუ დე პიერ-დიუ-ნიტონი 17, CH-1207
 ქენევა, შვეიცარია
 (770) ველფარ ილაჯ თიჯარეთ ლიმიტიდ სთი
 ათათურქ ჰავა აღანი ბოლგესი ფლაზა
 N319, იესილქოი/ისტანბულ ბაქირქოი
 ვ.დ. 801 064 2555, თურქეთი
 (580) 2015 03 31

(111) M 2013 024029 R
 (732) ზელმერ პრო სპ.ზ.ო.ო.
 ულ. ჰოფმანოვეი 19, 35-016 რზეკოვი,
 პოლონეთი
 (770) ზელმერ მარკეტ სპ.ზ.ო.ო.
 ულ. ჰოფმანოვეი 19, 35-016 რზეკოვი,
 პოლონეთი
 (580) 2015 03 23

(111) M 2011 021154 R
 (732) პაკშუ ინდუსტრიალ გრუპ კომპანი
 პაკისტანი მეორე ქ. 29, ბეჰეშთის ქ.
 ს.ყ. 15745/713 თეირანი, ირანის
 ისლამური რესპუბლიკა
 (770) ჰამიდ შარიათი
 ყიფშიდის ქ. 3ბ, I სად., ბ. 19, 0162,
 თბილისი, საქართველო
 (580) 2015 03 31

(111) M 2014 025268 R
 (732) პოლ ინტერნასიონალ სა
 რიუ დე სენ-ლევგერ 2, კ/ო პოლ სუის სა,
 1205 ქენევა, შვეიცარია
 (770) პოლ სუის სა
 2 რიუ სან-ლევგერი, CH-1205 ქენევა,
 შვეიცარია
 (580) 2015 03 25

(111) M 2011 021831 R
 (732) კრონოტექს გმბჰ & კო.კგ
 ვიტშტოკერ შოსე 1, 16909
 ჰაილიგენგრაბე, გერმანია
 (770) შპს ქაჰვეჯი პარკეტი
 ვანის ქ.4 (ნაკვეთი N4/51, ბ. 266),
 თბილისი, საქართველო
 (580) 2015 03 31

(111) M 1996 004211 R1
 (732) ჰილტონ უორლდვაიდ ჰოლდინგ ლღპ
 მეიპლ ქორტ სენტრალ პარკი, რიდს
 ქრესენტი, უოტფორდი, WD24 4QQ,
 გაერთიანებული სამეფო
 (770) ჰლტ დომესტიკ იპ, ლღკ,
 7930 ჯონს ბრენჩ დრაივი, სუიტი 1100,
 მაკლინი, VA 22102, აშშ
 (580) 2015 03 31

(111) M 2012 022784 R
 (732) ჰილტონ უორლდვაიდ ჰოლდინგ ლღპ
 მეიპლ ქორტ სენტრალ პარკი, რიდს
 ქრესენტი, უოტფორდი, WD24 4QQ,
 გაერთიანებული სამეფო
 (770) ჰლტ ინტერნეშენელ იპ ლღკ
 (დელავერის კორპორაცია)
 7930 ჯონს ბრენჩ დრაივი, სუიტი 1100
 მაკ-ლინი, ვირჯინია 22102, აშშ
 (580) 2015 03 31

(111) M 1997 007505 R1
 (732) ნოვარტის აგ
 ბაზელი 4002, შვეიცარია,
 (770) ნოვარტის ინტერნეშენელ
 ფარმასიუტიკალ ლტდ
 ს/ყ HM 2899, ჰამილტონი HM LX,
 ბერმუდის კუნძულები
 (580) 2015 03 31

(111) M 1995 000951 R1

(732) ჰილტონ უორლდვაიდ ჰოლდინგ ლღპ
მეიპლ ქორტ სენტრალ პარკი, რიდს
ქრესენტი, უოტფორდი, WD24 4QQ,
გაერთიანებული სამეფო

(770) ჰელტ ინტერნეშენელ იპ ლღკ
7930 ჯონს ბრენ დრაივი, სუიტი 1100
მაკლინი, ვირჯინია 22102, აშშ

(580) 2015 03 31

სისტემური საძიებლები გამოგონებები

საერთაშორისო კლასიფიკაციის ინდექსის და განაცხადის
გამოქვეყნების ნომრის შესაბამისობის ცხრილი

საერთაშორისო კლასიფიკაციის ინდექსი (51)	განაცხადის გამოქვეყნების ნომერი (10)
A 01 D 46/26	AP 2015 13392 A
A 61 K 9/16; A 61 K 9/20; A 61 K 9/28; A 61 K 31/55	AP 2015 12505 A
B 29 C 51/36	AP 2015 13329 A
B 42 D 15/10; B 42 D 25/00	AP 2015 13187 A
B 60 B 37/10	AP 2015 13165 A
C 07 D 221/10; C 07 D 401/06; C 07 D 401/12; C 07 D 417/06; C 07 D 471/04; A 61 K 31/473; A 61 K 31/497; A 61 K 31/498; A 61 K 31/5377; A 61 P 3/00; C 07 D 401/14; C 07 D 405/14; C 07 D 498/04	AP 2015 12734 A
C 07 D 403/12; C 07 D 407/12; C 07 D 409/12; A 61 K 31/4155; A 61 P 29/00	AP 2015 13204 A
C 07 D 487/04; A 61 K 31/519; A 61 P 25/00	AP 2015 13211 A
C 07 H 21/04; C 12 N 15/11	AP 2015 12527 A
E 02 F 5/32	AP 2015 13388 A
F 03 G 4/00; F 24 J 3/08	AP 2015 13395 A
H 01 S 3/067	AP 2015 11917 A

განაცხადის გამოქვეყნების ნომრის და საერთაშორისო
კლასიფიკაციის ინდექსის შესაბამისობის ცხრილი

განაცხადის გამოქვეყნების ნომერი (10)	საერთაშორისო კლასიფიკაციის ინდექსი (51)
AP 2015 11917 A	H 01 S 3/067
AP 2015 12505 A	A 61 K 9/16; A 61 K 9/20; A 61 K 9/28; A 61 K 31/55
AP 2015 12527 A	C 07 H 21/04; C 12 N 15/11
AP 2015 12734 A	C 07 D 221/10; C 07 D 401/06; C 07 D 401/12; C 07 D 417/06; C 07 D 471/04; A 61 K 31/473; A 61 K 31/497; A 61 K 31/498; A 61 K 31/5377; A 61 P 3/00; C 07 D 401/14; C 07 D 405/14; C 07 D 498/04
AP 2015 13165 A	B 60 B 37/10
AP 2015 13187 A	B 42 D 15/10; B 42 D 25/00
AP 2015 13204 A	C 07 D 403/12; C 07 D 407/12; C 07 D 409/12; A 61 K 31/4155; A 61 P 29/00
AP 2015 13211 A	C 07 D 487/04; A 61 K 31/519; A 61 P 25/00
AP 2015 13329 A	B 29 C 51/36
AP 2015 13388 A	E 02 F 5/32
AP 2015 13392 A	A 01 D 46/26
AP 2015 13395 A	F 03 G 4/00; F 24 J 3/08

საერთაშორისო კლასიფიკაციის ინდექსის, პატენტის ნომრის და გამოქვეყნების ნომრის შესაბამისობის ცხრილი

საერთაშორისო კლასიფიკაციის ინდექსი (51)	პატენტის ნომერი (11)	ბანაცხადის გამოქვეყნების ნომერი (10)
A 01 N 25/04; A 01 N 25/32	P 2015 6268 B	AP 2014 12698 A
A 01 N 43/90; C 07 D 211/94; C 07 D 471/10	P 2015 6266 B	AP 2014 12291 A
A 23 C 9/13	P 2015 6274 B	AP 2014 13192 A
A 23 C 19/076; A 01 J 25/00	P 2015 6275 B	AP 2014 13193 A
B 61 B 12/04	P 2015 6276 B	AP 2014 13313 A
C 07 D 215/48; C 07 D 401/12; C 07 D 407/12; C 07 D 409/12; C 07 D 413/12; C 07 D 417/12; A 61 K 31/4709; A 61 P 31/10	P 2015 6269 B	AP 2014 12811 A
C 07 D 471/04; C 07 D 471/14; A 61 K 31/437; A 61 K 31/4375; A 61 P 35/00	P 2015 6267 B	AP 2014 12484 A
F 02 B 75/32	P 2015 6271 B	AP 2014 13107 A
F 03 B 3/00, 3/12	P 2015 6272 B	AP 2014 13108 A
F 03 D 5/02	P 2015 6273 B	AP 2014 13132 A
H 02 J 3/18	P 2015 6270 B	AP 2014 12943 A

პატენტის ნომრის, ბანაცხადის გამოქვეყნების ნომრის და საერთაშორისო კლასიფიკაციის ინდექსის შესაბამისობის ცხრილი

პატენტის ნომერი (11)	ბანაცხადის გამოქვეყნების ნომერი (10)	საერთაშორისო კლასიფიკაციის ინდექსი (51)
P 2015 6266 B	AP 2014 12291 A	A 01 N 43/90; C 07 D 211/94; C 07 D 471/10
P 2015 6267 B	AP 2014 12484 A	C 07 D 471/04; C 07 D 471/14; A 61 K 31/437; A 61 K 31/4375; A 61 P 35/00
P 2015 6268 B	AP 2014 12698 A	A 01 N 25/04; A 01 N 25/32
P 2015 6269 B	AP 2014 12811 A	C 07 D 215/48; C 07 D 401/12; C 07 D 407/12; C 07 D 409/12; C 07 D 413/12; C 07 D 417/12; A 61 K 31/4709; A 61 P 31/10
P 2015 6270 B	AP 2014 12943 A	H 02 J 3/18
P 2015 6271 B	AP 2014 13107 A	F 02 B 75/32
P 2015 6272 B	AP 2014 13108 A	F 03 B 3/00, 3/12
P 2015 6273 B	AP 2014 13132 A	F 03 D 5/02
P 2015 6274 B	AP 2014 13192 A	A 23 C 9/13
P 2015 6275 B	AP 2014 13193 A	A 23 C 19/076; A 01 J 25/00
P 2015 6276 B	AP 2014 13313 A	B 61 B 12/04

**ბანაცხადის ნომრის, ბანაცხადის გამოქვეყნების ნომრის
და პატენტის ნომრის შესაბამისობის ცხრილი**

ბანაცხადის ნომერი (21)	ბანაცხადის გამოქვეყნების ნომერი (10)	პატენტის ნომერი (11)
AP 2009 012291	AP 2014 12291 A	P 2015 6266 B
AP 2010 012484	AP 2014 12484 A	P 2015 6267 B
AP 2010 012698	AP 2014 12698 A	P 2015 6268 B
AP 2010 012811	AP 2014 12811 A	P 2015 6269 B
AP 2012 012943	AP 2014 12943 A	P 2015 6270 B
AP 2013 013107	AP 2014 13107 A	P 2015 6271 B
AP 2013 013108	AP 2014 13108 A	P 2015 6272 B
AP 2013 013132	AP 2014 13132 A	P 2015 6273 B
AP 2013 013192	AP 2014 13192 A	P 2015 6274 B
AP 2013 013193	AP 2014 13193 A	P 2015 6275 B
AP 2013 013313	AP 2014 13313 A	P 2015 6276 B

სასარგებლო მოდელები

**საერთაშორისო კლასიფიკაციის ინდექსის, პატენტის ნომრის
და გამოქვეყნების ნომრის შესაბამისობის ცხრილი**

საერთაშორისო კლასიფიკაციის ინდექსი (51)	პატენტის ნომერი (11)	ბანაცხადის გამოქვეყნების ნომერი (10)
E 02 B 3/06	U 2015 1856 Y	AU 2014 13209 U

**პატენტის ნომრის, ბანაცხადის გამოქვეყნების ნომრის
და საერთაშორისო კლასიფიკაციის ინდექსის შესაბამისობის ცხრილი**

პატენტის ნომერი (11)	ბანაცხადის გამოქვეყნების ნომერი (10)	საერთაშორისო კლასიფიკაციის ინდექსი (51)
U 2015 1856 Y	AU 2014 13209 U	E 02 B 3/06

**ბანაცხადის ნომრის, ბანაცხადის გამოქვეყნების ნომრისა
და პატენტის ნომრის შესაბამისობის ცხრილი**

ბანაცხადის ნომერი (21)	ბანაცხადის გამოქვეყნების ნომერი (10)	პატენტის ნომერი (11)
AU 2013 013209	AU 2014 13209 U	U 2015 1856 Y

ღიზინები

საერთაშორისო კლასიფიკაციის ინდექსის, პატენტის ნომრის
და გამოქვეყნების ნომრის შესაბამისობის ცხრილი

საერთაშორისო კლასიფიკაციის ინდექსი (51)	პატენტის ნომერი (11)	ბანაცხადის გამოქვეყნების ნომერი (10)
12-08	D 2015 624 S	AD 2014 816 S

პატენტის ნომრის, ბანაცხადის გამოქვეყნების ნომრის
და საერთაშორისო კლასიფიკაციის ინდექსის შესაბამისობის ცხრილი

პატენტის ნომერი (11)	ბანაცხადის გამოქვეყნების ნომერი (10)	საერთაშორისო კლასიფიკაციის ინდექსი (51)
D 2015 624 S	AD 2014 816 S	12-08

ბანაცხადის ნომრის, ბანაცხადის გამოქვეყნების ნომრისა
და პატენტის ნომრის შესაბამისობის ცხრილი

ბანაცხადის ნომერი (21)	ბანაცხადის გამოქვეყნების ნომერი (10)	პატენტის ნომერი (11)
AD 2014 000816	AD 2014 816 S	D 2015 624 S

სასაქონლო ნიშნები

რეგისტრაციის ნომრის, განაცხადის ნომრის,
განაცხადის გამოქვეყნების ნომრისა და ბიულეტენის ნომრის
შესაბამისობის ცხრილი

რეგისტრაციის ნომერი (111)	განაცხადის ნომერი (210)	განაცხადის გამოქვეყნების ნომერი (260)	ბიულეტენის ნომერი
M 2015 25747 R	AM 2015 81060	-	7(419) 2015
M 2015 25748 R	AM 2015 81150	-	7(419) 2015
M 2015 25749 R	AM 2015 80944	-	7(419) 2015
M 2015 25750 R	AM 2015 80945	-	7(419) 2015
M 2015 25751 R	AM 2015 80946	-	7(419) 2015
M 2015 25752 R	AM 2015 80833	-	7(419) 2015
M 2015 25753 R	AM 2015 80835	-	7(419) 2015
M 2015 25754 R	AM 2015 80749	-	7(419) 2015
M 2015 25755 R	AM 2015 80930	-	7(419) 2015
M 2015 25756 R	AM 2015 81364	-	7(419) 2015
M 2015 25757 R	AM 2015 81365	-	7(419) 2015
M 2015 25758 R	AM 2015 79948	-	7(419) 2015
M 2015 25759 R	AM 2015 81256	-	7(419) 2015
M 2015 25760 R	AM 2013 73136	AM 2015 73136 A	4(416) 2015
M 2015 25761 R	AM 2013 73137	AM 2015 73137 A	4(416) 2015
M 2015 25762 R	AM 2013 73340	AM 2014 73340 A	22(410) 2014
M 2015 25763 R	AM 2013 73877	AM 2014 73877 A	18(406) 2014
M 2015 25764 R	AM 2013 74169	AM 2014 74169 A	18(406) 2014
M 2015 25765 R	AM 2013 74249	AM 2014 74249 A	18(406) 2014
M 2015 25766 R	AM 2013 74303	AM 2014 74303 A	18(406) 2014
M 2015 25767 R	AM 2013 74430	AM 2014 74430 A	17(405) 2014
M 2015 25768 R	AM 2013 74634	AM 2014 74634 A	20(408) 2014
M 2015 25769 R	AM 2013 74905	AM 2014 74905 A	18(406) 2014
M 2015 25770 R	AM 2013 74994	AM 2014 74994 A	18(406) 2014
M 2015 25771 R	AM 2013 74995	AM 2014 74995 A	18(406) 2014
M 2015 25772 R	AM 2013 75002	AM 2014 75002 A	18(406) 2014
M 2015 25773 R	AM 2013 75219	AM 2014 75219 A	18(406) 2014
M 2015 25774 R	AM 2015 80605	-	7(419) 2015
M 2015 25775 R	AM 2015 81278	-	7(419) 2015
M 2015 25776 R	AM 2013 74495	AM 2014 74495 A	21(409) 2014
M 2015 25777 R	AM 2015 81151	-	7(419) 2015

ბანაცხადის გამოქვეყნების ნომრის და ბანაცხადის ნომრის შესაბამისობის ცხრილი

ბანაცხადის გამოქვეყნების ნომერი (260)	ბანაცხადის ნომერი (210)	1	2
1	2		
AM 2015 75892 A	AM 75892	AM 2015 77357 A	AM 77357
AM 2015 76187 A	AM 76187	AM 2015 77454 A	AM 77454
AM 2015 76223 A	AM 76223	AM 2015 77573 A	AM 77573
AM 2015 76367 A	AM 76367	AM 2015 77693 A	AM 77693
AM 2015 76401 A	AM 76401	AM 2015 77697 A	AM 77697
AM 2015 76617 A	AM 76617	AM 2015 77944 A	AM 77944
AM 2015 76618 A	AM 76618	AM 2015 78156 A	AM 78156
AM 2015 76630 A	AM 76630	AM 2015 78157 A	AM 78157
AM 2015 76639 A	AM 76639	AM 2015 78262 A	AM 78262
AM 2015 76701 A	AM 76701	AM 2015 78263 A	AM 78263
AM 2015 76723 A	AM 76723	AM 2015 78268 A	AM 78268
AM 2015 77309 A	AM 77309	AM 2015 78790 A	AM 78790
		AM 2015 78802 A	AM 78802
		AM 2015 78803 A	AM 8803
		AM 2015 78851 A	AM 78851
		AM 2015 78852 A	AM 78852

ბანაცხადის გამოქვეყნების ნომრის საძიებელი საქონლისა და/ან მომსახურების კლასის მიხედვით

საქონლისა და/ან მომსახურების კლასი (511)	ბანაცხადის გამოქვეყნების ნომერი (260)	1	2
1	2		
1	AM 2015 78156 A	29	AM 2015 78852 A
3	AM 2015 76187 A	30	AM 2015 76630 A
3	AM 2015 76617 A	30	AM 2015 77309 A
3	AM 2015 76618 A	30	AM 2015 78157 A
3	AM 2015 78803 A	30	AM 2015 78851 A
3	AM 2015 75892 A	30	AM 2015 78852 A
5	AM 2015 77944 A	32	AM 2015 75892 A
5	AM 2015 78268 A	32	AM 2015 77309 A
5	AM 2015 78790 A	33	AM 2015 76401 A
9	AM 2015 76639 A	33	AM 2015 77573 A
9	AM 2015 77454 A	33	AM 2015 78802 A
9	AM 2015 77697 A	34	AM 2015 76223 A
12	AM 2015 78262 A	35	AM 2015 75892 A
12	AM 2015 78263 A	35	AM 2015 76701 A
16	AM 2015 76723 A	35	AM 2015 77357 A
21	AM 2015 76367 A	35	AM 2015 77693 A
25	AM 2015 77693 A	35	AM 2015 78156 A
29	AM 2015 76701 A	39	AM 2015 76367 A
29	AM 2015 77309 A	39	AM 2015 77357 A
29	AM 2015 78851 A	41	AM 2015 76723 A
		41	AM 2015 73357 A
		41	AM 2015 77693 A
		41	AM 2015 77693 A
		42	AM 2015 76723 A
		43	AM 2015 76367 A
		43	AM 2015 77309 A

დაჩქარებული პროცედურით რეგისტრირებული სასაქონლო ნიშნის
ნომრის საძიებელი საქონლისა და/ან მომსახურების კლასის მიხედვით

საქონლისა და/ან მომსახურების კლასი (511)	დაჩქარებული პროცედურით რეგისტრირებული სასაქონლო ნიშნის ნომერი (111)
5	M 2015 25747 R
5	M 2015 25748 R
5	M 2015 25755 R
29	M 2015 25754 R
29	M 2015 25774 R
33	M 2015 25749 R
33	M 2015 25750 R
33	M 2015 25751 R
33	M 2015 25752 R
33	M 2015 25753 R
33	M 2015 25775 R
33	M 2015 25777 R
35	M 2015 25754 R
35	M 2015 25758 R
35	M 2015 25759 R
35	M 2015 25777 R
38	M 2015 25756 R
38	M 2015 25757 R

სამრეწველო საკუთრების ოფისიალური ბიულეტენი

7(419)

ბიულეტენების ქართული და ინგლისურენოვანი გამოცემების ელექტრონული ვერსიის გაცნობა შესაძლებელია საქპატენტის ვებგვერდზე (www.sakpatenti.org.ge).

შენიშვნა:

ბიულეტენებში გამოქვეყნებული ობიექტების ზუსტი გამოსახულებები იხილეთ საქპატენტის ვებგვერდზე განთავსებულ ელექტრონულ ვერსიაში.

მთავარი რედაქტორი:	ნ. ბებრიშვილი
პორექტორი:	ლ. ჭანტურია
დამაბაბალონებელი:	მ. ორდენიძე
	ქ. სვანიძე
პოლიგრაფიული ჯგუფი:	მ. მეჩტიშვილი
	ი. გოგოლაშვილი
	ლ. დოლიძე

ხელმოწერილია გამოსაცემად: 2015 04 08

ტირაჟი: 25
შეკვეთა №7