

საქართველოს ინტელექტუალური საკუთრების
ეროვნული ცენტრი
საქპატენტი

სამრეწველო საკუთრების
ო ფ ი ს ი ა ლ უ რ ი
ბიულეტენი

12(496)

გამოგონებები

სასარგებლო მოდელები

დიზაინები

სასაქონლო ნიშნები

საერთაშორისო კოდეზი ბიბლიოგრაფიული მონაცემების იდენტიფიკაციისთვის

გამოგონებები, სასარგებლო მოდელები

- (10) – ექსპერტიზაგადასმული განაცხადის გამოქვეყნების ნომერი
- (11) – პატენტის ნომერი და სახეობის კოდი
- (21) – განაცხადის სარეგისტრაციო ნომერი
- (22) – განაცხადის შეტანის თარიღი
- (23) – სავაჭრო ნიშნის პრიორიტეტის თარიღი ან ადრინდელი პრიორიტეტის მქონე განაცხადის შეტანის თარიღი და, თუ შესაძლებელია, განაცხადის ომერი
- (24) – თარიღი, რომლიდანაც იწყება პატენტის მოქმედება
- (31) – საპრიორიტეტო განაცხადის ნომერი
- (32) – საპრიორიტეტო განაცხადის შეტანის თარიღი
- (33) – კოდი ქვეყნის ან რეგიონული ორგანიზაციისა, რომლის უწყებამაც მიანიჭა ნომერი საპრიორიტეტო განაცხადს
- (44) – დამავი სახეობის კური ანონსი, მაგრამ ექსპერტიზაგადასმული განაცხადის გამოქვეყნების თარიღი და ბიულეტენის ნომერი
- (45) – რეგისტრაცია გათვლილი საპატენტო სახეობის გამოქვეყნების თარიღი
- (51) – საერთაშორისო საპატენტო კლასიფიკაციის ინდექსი

- (54) – გამოგონების დასახელება
- (57) – რეფერატის ტექსტი
- (60) – სრულ ექსპერტიზაგადასმული გამოგონებაზე უცხოური საპატენტო უწყების მიერ გაცემული დამავი სახეობის ნომერი, თარიღი, რომლიდანაც იწყება ამ დამავი სახეობის მოქმედება, და კოდი ქვეყნის ან რეგიონული ორგანიზაციისა, რომლის უწყებამაც გასცა ეს დამავი სახეობა
- (62) – უფრო ადრინდელი განაცხადის ნომერი და, თუ შესაძლებელია, წარდგენის თარიღი გამოცალკევებული განაცხადის შემთხვევაში
- (71) – განმცხადებლის სახელი, გვარი (ქვეყნის კოდი)
- (72) – გამოგონებულის სახელი, გვარი (ქვეყნის კოდი)
- (73) – პატენტმფლობელის სახელი, გვარი (ქვეყნის კოდი), მისამართი
- (74) – წარმომადგენლის ან პატენტმფლობელის სახელი, გვარი
- (85) – საერთაშორისო განაცხადის უროვნული ფაზის დაწყების თარიღი
- (86) – საერთაშორისო განაცხადის ნომერი და შეტანის თარიღი
- (87) – საერთაშორისო განაცხადის გამოქვეყნების ნომერი და თარიღი

ლიზინი

- (10) – განაცხადის გამოქვეყნების ნომერი
- (11) – პატენტის ნომერი და სახეობის კოდი ან რეგისტრაციის ნომერი
- (15) – რეგისტრაციის თარიღი/პატენტის გაგრძელების თარიღი
- (18) – პატენტის ან რეგისტრაციის მოქმედების ვადის გასვლის სავარაუდო თარიღი
- (21) – განაცხადის ნომერი
- (22) – განაცხადის შეტანის თარიღი
- (23) – სავაჭრო ნიშნის პრიორიტეტის თარიღი ან ადრინდელი პრიორიტეტის მქონე განაცხადის შეტანის თარიღი და, თუ შესაძლებელია, განაცხადის ნომერი
- (24) – თარიღი, რომლიდანაც იწყება პატენტის მოქმედება
- (28) – ღიზანების რაოდენობა განაცხადში
- (30) – საპრიორიტეტო მონაცემები (განაცხადის ნომერი, განაცხადის შეტანის თარიღი და ორასლიანი კოდი იმ ორგანიზაციის იდენტიფიკაციისათვის, სადაც იყო წარდგენილი საპრიორიტეტო განაცხადი)
- (31) – საპრიორიტეტო განაცხადის ნომერი
- (32) – საპრიორიტეტო განაცხადის შეტანის თარიღი
- (33) – კოდი ქვეყნის ან რეგიონული ორგანიზაციისა, რომლის უწყებამაც მიანიჭა ნომერი საპრიორიტეტო განაცხადს
- (34) – IASO-ს სტანდარტის (ST.3) შესაბამის ორასლიანი კოდი იმ ორგანიზაციის იდენტიფიკაციისათვის, სადაც იყო წარდგენილი საპრიორიტეტო განაცხადი
- (44) – ღიზანის გამოქვეყნების თარიღი და ბიულეტენის ნომერი (პირველი პუბლიკაცია)

- (45) – საერთაშორისო ბიუროს მიერ დარეგისტრირებული ღიზანის გამოქვეყნების თარიღი და ბიულეტენის ნომერი
- (51) – ღიზანის საერთაშორისო კლასიფიკაცია (ლოკარნოს კლასიფიკაციის კლასი და ქვეკლასი)
- (54) – ღიზანის დასახელება
- (55) – ღიზანის გამოცხადება
- (57) – ღიზანის არსებითი ნიშნების აღწერა, ფერის ჩათვლით
- (58) – ყველა სახის ცვლილების შესახებ რეესტრში ჩანაწერის შეტანის თარიღი
- (62) – ადრინდელი განაცხადის, რეგისტრაციის ან სახეობის ნომერი და, თუ შესაძლებელია, წარდგენის თარიღი, გამოცალკევებული განაცხადის შემთხვევაში
- (71) – განმცხადებლის სახელი, გვარი (ქვეყნის კოდი), მისამართი
- (72) – ავტორის სახელი, გვარი ან დასახელება (ქვეყნის კოდი)
- (73) – პატენტმფლობელის სახელი, გვარი (ქვეყნის კოდი), მისამართი
- (74) – წარმომადგენლის სახელი, გვარი და მისამართი
- (81) – შესაბამისი მონაწილე მხარეები:
 - II. მონაწილე მხარეები, აღნიშნული 1960 წლის აქტის თანახმად
 - III. მონაწილე მხარეები, აღნიშნული 1999 წლის აქტის თანახმად
- (85) – მფლობელის მუდმივი საცხოვრებელი ადგილი
- (86) – მფლობელის მოქალაქეობა
- (87) – მფლობელის საცხოვრებელი ადგილი
- (88) – ქვეყანა, სადაც მფლობელს აქვს ნამდვილი და მოქმედი სამრეწველო ან სავაჭრო სანარმო

სასაქონლო ნიშნები

- (111) – რეგისტრაციის ნომერი
- (151) – რეგისტრაციის თარიღი
- (156) – რეგისტრაციის ვადის გაგრძელების თარიღი
- (181) – რეგისტრაციის ვადის გასვლის სავარაუდო თარიღი
- (186) – ვადის გაგრძელების გასვლის სავარაუდო თარიღი
- (141) – რეგისტრაციის მოქმედების ვადის გაუქმების თარიღი
- (210) – განაცხადის ნომერი
- (220) – განაცხადის შეტანის თარიღი
- (230) – სავაჭრო ნიშნის მონაცემები
- (260) – ნომერი განაცხადისა, რომელზედაც გამოკანონდა ექსპერტიზის დადებითი გადაწყვეტილება რეგისტრაციის შესახებ (გამოქვეყნების ნომერი)
- (310) – პირველი განაცხადის ნომერი
- (320) – პირველი განაცხადის შეტანის თარიღი
- (330) – პირველი განაცხადის მიმღები უროვნული ან რეგიონული უწყების ან ორგანიზაციის საიდენტიფიკაციო კოდი
- (51) – საქონლისა და მომსახურების საერთაშორისო კლასიფიკაცია სასაქონლო ნიშნის რეგისტრაციისათვის და/ან კლასიფიკირებული საქონლისა და/ან მომსახურების ჩამონათვალი
- (531) – სასაქონლო ნიშნის გამოცხადების თარიღი და/ან სასაქონლო ნიშნის გამოცხადების თარიღი ელემენტების საერთაშორისო კლასიფიკაციის (ვენის კლასიფიკაცია) მიხედვით

- (540) – ნიშნის გამოცხადება
- (550) – სასაქონლო ნიშნის ტიპი ან სახეობა
- (580) – განაცხადსა და ნიშნის რეგისტრაციისთან დაკავშირებული ყველა სახის ცვლილებაზე ჩანაწერის შეტანის თარიღი
- (591) – ინფორმაცია განცხადებულ ფერებზე
- (731) – განმცხადებლის სახელი და მისამართი
- (732) – მფლობელის სახელი და მისამართი
- (740) – წარმომადგენლის სახელი და მისამართი
- (750) – მიმონწერის მისამართი
- (770) – ცვლილებაზე განმცხადებლის ან მფლობელის სახელი და მისამართი უფლების გადაცემის შემთხვევაში
- (771) – ცვლილებაზე განმცხადებლის ან მფლობელის სახელი და მისამართი უფლების გადაცემის გარეშე
- (791) – ლიცენზიაციის სახელი და მისამართი
- (793) – ლიცენზიის პირობები და/ან შეზღუდვაზე მიწინებვა (ლიცენზიის სახე, სალიცენზიო ხელშეკრულების ნომერი, სალიცენზიო ხელშეკრულების თარიღი, სალიცენზიო ხელშეკრულების მოქმედების ვადა)
- (800) – სასაქონლო ნიშნის რეგისტრაციის მონაცემები ნიშნის საერთაშორისო რეგისტრაციის მდრიდის ხელშეკრულებასთან დაკავშირებული პროტოკოლის მიხედვით (საერთაშორისო რეგისტრაციის ნომერი)

- (21) AP 0000 000000 – გამოგონებაზე განაცხადის ნომერი
- (10) AP 0000 0000 A – გამოგონებაზე განაცხადის გამოქვეყნების ნომერი (პირველი პუბლიკაცია)
- (11) P 0000 0000 B – გამოგონების პატენტის ნომერი (მეორე პუბლიკაცია)
- (21) API 0000 000000 – შემოტანილ პატენტზე განაცხადის ნომერი
- (11) PI 0000 0000 A – შემოტანილი პატენტის ნომერი (პირველი პუბლიკაცია)
- (21) AU 0000 000000 – სასარგებლო მოდელებზე განაცხადის ნომერი
- (10) AU 0000 0000 U – სასარგებლო მოდელებზე განაცხადის გამოქვეყნების ნომერი (პირველი პუბლიკაცია)
- (11) U 0000 0000 Y – სასარგებლო მოდელების პატენტის ნომერი (მეორე პუბლიკაცია)
- (21) AD 0000 000000 – ღიზანზე განაცხადის ნომერი
- (10) AD 0000 0000 S – ღიზანზე განაცხადის გამოქვეყნების ნომერი (პირველი პუბლიკაცია)
- (11) D 0000 0000 S – ღიზანის პატენტის ნომერი (მეორე პუბლიკაცია)

- M – სასაქონლო ნიშანი
- (210) AM 0000 000000 – განაცხადის ნომერი
- (260) AAM 0000 00000 A – განაცხადის გამოქვეყნების ნომერი
- (111) M 0000 00000 R – რეგისტრაციის ნომერი
- MMM0000 00000 Rn – მომდევნო ვადით რეგისტრაციის ნომერი, სადაც n=1, 2, 3...
- M 0000 00000 R(P) – რეგისტრაციის ნომერი ნიშანზე უფლების ნაწილობრივი გადაცემისას
- * – საქპატენტის საპატენტო პალარის გადაწყვეტილების შემდეგ გამოქვეყნებული განაცხადის ნომერი
- ** – სასამართლოს გადაწყვეტილების შემდეგ გამოქვეყნებული განაცხადის ნომერი

გამოგონებებისა და სასარგებლო მოდელების საერთაშორისო კლასიფიკაციის იდენტიფიკაცია

- განყოფილება A – ადამიანის პირველადი მოთხოვნილების საგნები
- განყოფილება B – ტექნოლოგიური პროცესები; ტრანსპორტირება
- განყოფილება C – ქიმიკა; მეტალურგია
- განყოფილება D – საფეიქრო ნაწარმი; ქალაქი
- განყოფილება E – მშენებლობა; საბითონ საქმი; სტაციონარული ნაგებობები
- განყოფილება F – მექანიკა; განათება; გათბობა; იარაღი; ასაფეთქებელი საშუალებები
- განყოფილება G – ფიზიკა
- განყოფილება H – ელექტრონა

**ისმო-ს წევრი სახელმწიფოებისა და ორგანიზაციების აღნიშვნის
ორასწორიანი კოდეზი
(ისმოს სტანდარტი ST.3)**

AD	ანდორა	GD	გრენადა	MY	მალაიზია
AE	არაბთა გაერთიანებული საამიროები	GE	საქართველო	MZ	მოზამბიკი
AF	ავღანეთი	GG	გენზი	NA	ნამიბია
AG	ანტიგუა და ბარბუდა	GH	განა	NE	ნიგერი
AI	ანგილია	GI	გიბრალტარი	NG	ნიგერია
AL	ალბანეთი	GL	გრენლანდია	NI	ნიჟარაგუა
AM	სომხეთი	GM	გამბია	NL	ნიდერლანდები
AN	ანტილის კუნძულები (ნიდერლანდები)	GN	გვინეა	NO	ნორვეგია
AO	ანგოლა	GQ	ეკვატორული გვინეა	NP	ნეპალი
AP	ინტელექტუალური საკუთრების აფრიკის რეგიონალური ორგანიზაცია (ARIPO)	GR	საბერძნეთი	NR	ნაურუ
AR	არგენტინა	GS	სამხრეთი ჯორჯია და სამხრეთი სენდვიჩის კუნძულები	NZ	ახალი ზელანდია
AT	ავსტრია	GT	გვატემალა	OA	აფრიკის ინტელექტუალური საკუთრების ორგანიზაცია (OAPI)
AU	ავსტრალია	GW	გვინეა-ბისაუ	OM	ომანი
AW	არუბა	GY	გაიანა	PA	პანამა
AZ	აზერბაიჯანი	HK	ჰონგ კონგი	PE	პერუ
BA	ბოსნია და ჰერცეგოვინა	HN	ჰონდურასი	PG	პაპუა-ახალი გვინეა
BB	ბარბადოსი	HR	ხორვატია	PH	ფილიპინები
BD	ბანგლადეში	HT	ჰაიტი	PK	პაკისტანი
BE	ბელგია	HU	უნგრეთი	PL	პოლონეთი
BF	ბურკინა-ფასო	IB	ინტელექტუალური საკუთრების მსოფლიო ორგანიზაციის (ისმო, WIPO) საერთაშორისო ბიურო	VE	ვენესუელა
BG	ბულგარეთი	ID	ინდონეზია	VG	ვირჯინის კუნძულები (ბრიტანეთი)
BH	ბაჰრეინი	IE	ირლანდია	PY	პარაგვაი
BI	ბურუნდი	IL	ისრაელი	QA	კატარი
BJ	ბენინი	IM	მენის კუნძული	QZ	ეკვადორის თანამეგობრობის მცენარეთა ჯიშების უწყება (CPVO)
BM	ბერმუდის კუნძულები	IN	ინდოეთი	RO	რუმინეთი
BN	ბრუნეი-დარუსალამი	IQ	ირაკი	RS	სერბია
BO	ბოლივია	IR	ირანის ისლამური რესპუბლიკა	RU	რუსეთის ფედერაცია
BR	ბრაზილია	IS	ისლანდია	RW	რუანდა
BS	ბაჰამის კუნძულები	IT	იტალია	SA	საუდის არაბეთი
BT	ბჰუტანი	JE	ჯეზი	SB	სოლომონის კუნძულები
BV	ბუვეტის კუნძულები	JM	იამაიკა	SC	სეიშელის კუნძულები
BW	ბოტსვანა	JO	იორდანია	SD	სუდანი
BX	ბენელუქსის ინტელექტუალური საკუთრების უწყება (BOIP)	JP	იაპონია	SE	შვედეთი
BY	ბელორუსია	KE	კენია	SG	სინგაპური
BZ	ბელისი	KG	ყირგიზეთი	SH	წმინდა ჰელენის კუნძული
CA	კანადა	KH	კამბოჯა	SI	სლოვენია
CD	კონგოს დემოკრატიული რესპ.	KI	კირიბატი	SK	სლოვაკია
CF	ცენტრალური აფრიკის რესპ.	KM	კომორის კუნძულები	SL	სიერა-ლეონე
CG	კონგო	KN	სენტ კიტსი და ნევისი	SM	სან-მარინო
CH	შვეიცარია	KP	კორეის სახალხო დემოკრატიული რესპუბლიკა	SN	სენეგალი
CI	კოტ-დ'ივუარი	KR	კორეის რესპუბლიკა	SO	სომალი
CK	კუკის კუნძულები	KW	კუვეიტი	SR	სურინამი
CL	ჩილე	KY	კაიმენის კუნძულები	ST	სან-ტომე და პრინსიპი
CM	კამერუნი	KZ	ყაზახეთი	SV	სალვადორი
CN	ჩინეთი	LA	ლაოსი	SY	სირია
CO	კოლუმბია	LB	ლიბანი	SZ	სვაზილენდი
CR	კოსტა-რიკა	PT	პორტუგალია	TC	თურქის და კაიკოსის კუნძულები
CU	კუბა	PW	პალაუ	TD	ჩადი
CV	მწვანე კონცხის კუნძულები	LC	სენტ-ლუსია	TG	ტოგო
CY	კვიპროსი	LI	ლიხტენშტაინი	TH	ტაილანდი
CZ	ჩეხეთის რესპუბლიკა	LK	შრი-ლანკა	TJ	ტაჯიკეთი
DE	გერმანია	LR	ლიბერია	TL	ტიმოლ-ლესტე
DJ	ჯიბუტი	LS	ლესოტო	TM	თურქმენეთი
DK	დანია	LT	ლიტვა	TN	ტუნისი
DM	დომინიკა	LU	ლუქსემბურგი	TO	ტონგა
DO	დომინიკელთა რესპუბლიკა	LV	ლატვია	TR	თურქეთი
DZ	ალჟირი	LY	ლიბია	TT	ტრინიდადი და ტობაგო
EA	ევრაზიის საპატენტო ორგანიზაცია (EAPO)	MA	მაროკო	TV	ტუვალუ
EC	ეკვადორი	MC	მონაკო	TW	ტაივანი, ჩინეთის პროვინცია
EE	ესტონეთი	MD	რესპუბლიკა მოლდოვა	TZ	ტანზანია
EG	ეგვიპტე	ME	ჩერნოგორია (მონტენეგრო)	UA	უკრაინა
EH	დასავლეთი საჰარა	MG	მადაგასკარი	UG	უგანდა
EM	მინაგანი ბაზრის ჰარმონიზაციის უწყება (სასაქონლო ნიშნები და სამრეწველო ნიშნები (OHIM) ევროპის საპატენტო უწყება (EPO))	MK	მაკედონია ყოფილი იუგოსლავიის რესპუბლიკა	US	აშშ
EP	ევროპის საპატენტო უწყება (EPO)	ML	მალი	UY	ურუგვაი
ER	ერიტრეა	MM	მიანმა	UZ	უზბეკეთი
ES	ესპანეთი	MN	მონღოლეთი	VA	ვატიკანი
ET	ეთიოპია	MO	მაკაო	VC	სანტ-ვინსენტი და გრენადინები
FI	ფინეთი	MP	ჩრდ. მარიანას კუნძულები	VN	ვიეტნამი
FJ	ფიჯი	MR	მავრიტანია	VU	ვანუატუ
FK	ფოლკლენდის კუნძულები	MS	მონსერატი	WO	WIPO-ინტელექტუალური საკუთრების მსოფლიო ორგანიზაცია
FO	ფარერის კუნძულები	MT	მალტა	WS	სამოა
FR	საფრანგეთი	MU	მავრიკია	XN	ნორდული საპატენტო ინსტიტუტი (NPI)
GA	გაბონი	MV	მალდივის კუნძულები	YE	იემენი
GB	დიდი ბრიტანეთი	MW	მალავი	ZA	სამხრეთ აფრიკა
GC	სპარსეთის ყურის არაბული სახელმწიფოების თანამშრომლობის საბჭოს უწყება (GCC)	MX	მექსიკა	ZM	ზამბია
				ZW	ზიმბაბვე

შ ი ნ ა ა რ ს ი

გამოქვეყნებული ოქმი	3
გამოგონება	
• განაცხადები, რომლებზეც გამოტანილია გადაწყვეტილება პატენტის გაცემის შესახებ	4
• გამოგონების პატენტები	8
სასარგებლო მოდელები	
• განაცხადები, რომლებზეც გამოტანილია გადაწყვეტილება პატენტის გაცემის შესახებ	11
• სასარგებლო მოდელების პატენტი	13
დიზაინები	
• რეგისტრირებული დიზაინები	14
სასაქონლო ნიშნები	
• ეროვნული პროცედურით შემოტანილი განაცხადები, რომლებზეც გამოტანილია გადაწყვეტილება რეგისტრაციის შესახებ	15
• რეგისტრირებული სასაქონლო ნიშნები	35
• დაჩქარებული პროცედურით რეგისტრირებული სასაქონლო ნიშნები	41
• საერთაშორისო სასაქონლო ნიშნები, რომლებზეც გამოტანილია გადაწყვეტილება დაცვის მინიჭების შესახებ	45
• საერთაშორისო სასაქონლო ნიშნები, რომლებსაც მიენიჭათ დაცვა საქართველოში	166
საქონლის ადგილწარმოშობის დასახელება	
• რეგისტრირებული ადგილწარმოშობის დასახელება	177
ოფიციალური შეტყობინებები	
გამოგონება	
• პატენტების მოქმედების აღდგენა	178
• პატენტების გაუქმება	180
სასარგებლო მოდელები	
• პატენტების მოქმედების აღდგენა	183
• პატენტების გაუქმება	183
დიზაინები	
• რეგისტრაციის მოქმედების გაგრძელება	185
• რეგისტრაციის გაუქმება	186
სასაქონლო ნიშნები	
• რეგისტრაციის მოქმედების ვადის გაგრძელება	187
• უფლებების სრული გადაცემა	191
• მფლობელის სახელის და/ან მისამართის ცვლილება	194
• რეგისტრაციის ბათილად ცნობა	197
• საქონლის და/ან მომსახურების ჩამონათვალის ცვლილება	198
სისტემური საძიებლები	
გამოგონება	199
სასარგებლო მოდელები	201
დიზაინები	202
სასაქონლო ნიშნები	203

გამოქვეყნებული ობიექტები

გამომცემები

- განაცხადები, რომლებზეც გამოტანილია გადაწყვეტილება პატენტის გაცემის შესახებ: 14056; 13599; 14150; 13584; 13881; 13579; 13634; 14227
- პატენტები: 6864-6874

სასარგებლო მოდელები

- განაცხადები, რომლებზეც გამოტანილია გადაწყვეტილება პატენტის გაცემის შესახებ: 14589; 14429; 14654; 14575
- პატენტები: 1970

ღიზინები

- რეგისტრირებული ღიზინები: 765, 766

სასაქონლო ნიშნები

- ეროვნული პროცედურით გამოტანილი განაცხადები: 91940*; 92481; 92586; 93782; 93834-93836; 94378; 94398; 4441; 94454; 94471; 94490; 94534; 94544; 94547; 94563-94566; 94568; 94571; 94575; 94577; 94597; 94601; 94604; 94608-94610; 94615; 94674; 94677; 94679; 94680; 94690; 94710-4712; 94721; 94776; 94777; 94792; 94821; 94829; 94830; 94976; 95069-95071; 95120-95129; 95182; 95224; 95306
- რეგისტრირებული სასაქონლო ნიშნები: 29771-29933
- ღაქარებული პროცედურით რეგისტრირებული სასაქონლო ნიშნები: 29758-29770; 29834
- საერთაშორისო სასაქონლო ნიშნები, რომლებზეც გამოტანილია გადაწყვეტილება ღაცვის მინიჭების შესახებ: 92687; 92689; 92809; 93242; 93244; 93271; 93405; 93590; 93626; 93640-93644; 93647; 93648; 93655; 93657; 93658; 93667-93671; 93686; 93687; 93698-93703; 93723-93728; 93731; 93733-93738; 93740; 93744; 93748; 93750-93752; 93754; 93758; 93759; 93761; 93762; 93764; 93765; 93773; 93774; 93776-93781; 93789; 93793-93801; 93803; 93805; 93807; 93808; 93812; 93813; 93816; 93821; 93823-93825; 93849-93851; 93853-93856; 93860-93868; 93871-93874; 93878-93881; 93883-93885; 93893; 93895; 93898; 93899; 93903-93905; 93907-93909; 93911; 93912; 93915; 93917; 93918; 93920; 93922; 93924-93930; 93932; 93935-93937; 93939-93944; 93948; 93950-93952; 93954; 93959; 93961; 93964; 93965; 93967; 93971-93977; 93989-93995; 93998; 94000; 94003; 94005-94008; 94022; 94024; 94027-94030; 94032; 94033; 94036; 94037; 94040-94047; 94049; 94050; 94052; 94058; 94060-94062; 94064-94067; 94069; 94070; 94073; 94074; 94081; 94083-94086; 94089; 94091; 94094; 94095; 94117-94120; 94122; 94123; 94126; 94128; 94220; 94221; 94223; 94225; 94227; 94229; 94230; 94232; 94297-94305; 94425; 94437; 94438; 94443; 94480; 94482; 94484; 94527-94529; 94531; 94532; 94538-94541; 94647; 94648; 94769-94773; 94775; 94780
- საერთაშორისო სასაქონლო ნიშნები, რომლებსაც მიენიჭა ღაცვა საქართველოში: 88867; 90397; 90704; 90707; 91122; 91313; 91639; 91653; 91654; 91664; 91666; 91669; 91709; 91712; 91727; 91765; 91766; 91770; 91778-91780; 91784; 91785; 91789; 91881; 91896; 91904; 91905; 91907; 91930; 91936; 91966; 91968; 91979; 91992; 91995; 92003; 92034; 92051; 92053; 92054; 92056; 92060-92062; 92082; 92107; 92131; 92133; 92134; 92136; 92147; 92148; 92150; 92152-92154; 92162; 92168; 92170; 92197; 92278; 92286; 92287; 92289-92297; 92299-92302; 92305; 92307; 92318; 92321; 92323-92325; 92327; 92401; 92402; 92405; 92409; 92416; 92417; 92426-92429; 92431-92434; 92443; 92448; 92449; 92451; 92454; 92512; 92513; 92524; 92526-92529; 92532; 92533; 92546-92549; 92551; 92555; 92558; 92560; 92562; 92582; 92593-92594; 92596-92598; 92609; 92614; 92630-92632; 92634; 92636; 92699; 92701-92703; 92714; 92718; 92719; 92722; 92832; 92833; 92841; 92843; 92846; 92890; 93051; 93052; 93184; 93186-93188; 93193; 93194; 93199; 93213; 93215; 93218

საქონლის ადგილწარმოშობის დასახელება

- რეგისტრირებული ადგილწარმოშობის დასახელება: 975

გამოგონებები

ბანასხადები, რომლებზეც გამოტანილია ბალანსვატილება პატენტის გასემის შესახებ

გადაწყვეტილების გასაჩივრება შესაძლებელია საქპატენტის სააპელაციო პალატაში გამო-
ქვეყნებიდან 3 თვის ვადაში ან მცხეთის რაიონული სასამართლოს ადმინისტრაციულ საქმეთა
კოლეგიაში 1 თვის ვადაში (მის.: ქ. მცხეთა, სამხედროს ქ. №17).

ბანყოფილება A

A 61

(10) AP 2018 14056 A (51) Int. Cl. (2006)

A 61 K 9/20

A 61 K 9/48

A 61 K 36/537

A 61 P 9/10

A 61 P 9/00

A 61 P 7/02

(21) AP 2014 014056 (22) 2014 07 11

(31) 201310290967.3; 201310290966.9;
201310290968.8; 201310291465.2

(32) 2013 07 11; 2013 07 11; 2013 07 11;
2013 07 11

(33) CN; CN; CN; CN

(71) ტასლი ფარმასიუტიკალ
გრუპ კო. ლტდ (CN)
ტასლი მოდერნ TCM გარდენ, პუ ჯიპაი
ისტ როუდ No. 2, ბაიკენ დისტრიქტ,
ტიანჯინი 300410 (CN)

(72) სიცზიუნ იან (CN);

ნაიფენ უ (CN);

კაიცზინ იან (CN);

სიაობინ სუნ (CN);

შუნნან ჩუან (CN);

ჩუნლიან ე (CN);

ჰაი'ოუ დუნ (CN);

ჰუნბო ჩუან (CN);

ვეშენ ჩუან (CN);

ლიძუნ ჩუაუ (CN);

ჩენმინ ლი (CN);

ცუნ ჩენ (CN);

სიაოფენ ლიუ (CN);

შიცინ ვან (CN);

ჩანშენ ჟუნ (CN);

იუნფენ ჩუნ (CN);

ლიცზიუნ ფან (CN)

(74) ლარისა ამირხანიანი

(85) 2016 02 10

(86) PCT/CN2014/082104, 2014 07 11

(54) შიამაღბენლობა ჯვეთოვანი

მიკრობის ფორმით და მისი მიღების
ხერხი

(57) წვეთოვანი მიკრობის მიღების ხერხი,
რომელიც მოიცავს შემდეგ ეტაპებს:

(1) მასალის ღლობის სტადია; (2) წვეთოვანი
ჩამოსხმის სტადია; (3) კონდენსაციის სტადია.

მუხლები: 4 დამოუკიდებელი

32 დამოკიდებული

ცხრილი: 5

(10) AP 2018 13599 A (51) Int. Cl. (2006)

A 61 K 31/337

A 61 K 31/551

A 61 K 35/00

(21) AP 2013 013599 (22) 2013 03 19

(31) 61/613,258

(32) 2012 03 20

(33) US

(71) მილენიუმ ფარმასიუტიკალზ ინკ. (US)

40 ლენდსლოუნ სტრიტ, კემბრიჯი,
MA 02139 (US)

(72) არიჯიტ ჩაკრავარტი (US);

ჯეფრი, ა. ეკსიდი (US);

რობერტ, ვ. კლეინფილდი (US);

კხა, ნ. ლი (US);

ვენ, ჩუი შიუ (US);

კარტხიკ ვენკატაკრიშნანი (US)

(74) თამარ კოჭლამაზაშვილი

(85) 2014 10 17

(86) PCT/US2013/032962, 2013 03 19

(54) ავრორა კინაზას ინჰიბიტორების
გამოყენება კიბოს სამკურნალოდ

(57) გამოგონება ეხება ავრორა A კინაზას
შერჩევითი ინჰიბიტორის გამოყენებას პაკლი-
ტაქსელთან კომბინაციაში ფილტვის კიბოს
სამკურნალოდ, განსაზღვრული დოზური რე-
ჟიმით.

მუხლები: 2 დამოუკიდებელი

8 დამოკიდებული

ფიგურა: 3

ბანყოფილება C

C 02

(10) AP 2018 14150 A (51) Int. Cl. (2006)
 C 02 F 9/00
 C 02 F 103/42
 C 02 F 103/00
 C 02 F 1/00
 C 02 F 1/52
 C 02 F 1/40
 C 02 F 1/76

(21) AP 2014 014150 (22) 2014 12 29
 (31) 14/564,957; 61/915,331
 (32) 2014 12 09; 2031 12 12
 (33) US; US

(71) კრისტალ ლაუნს (კურასო) ბ.ვ. (NL)
 კაია ვ.ფ.გ. (ჯომბი) მენსინგ, 14, კურასო,
 ნიდერლანდები (NL)

(72) ფერნანდო, ბენჯამინ ფიშმანი
 ტორესი (CL)

(74) შალვა გვარამაძე
 (85) 2016 05 20

(86) PCT/IB2014/002891, 2014 12 29

(54) **სისტემა და ხერხი დიდ წყალსა-
 ტემპერატურაზე წყლის ხარისხის
 შესანარჩუნებლად**

(57) ხერხი ითვალისწინებს: ა) წყალსაცავში წყალთან ფლოკულანტის ეფექტური რაოდენობის დამატებას წყლის სიმღვრივის 2 NTU-ს ქვევით შესანარჩუნებლად, სადაც ფლოკულანტი წყალში შეტივტივებულ მყარ ნაწილაკებს გარდაქმნის ფლოკულებად, რომლებიც წყალსაცავის ფსკერზე იდექება, ბ) მობილური შემწოვი მოწყობილობის ამუშავებას ფსკერის ფერის მუქი კომპონენტების ზრდის CMYK სკალის მიხედვით 30%-ის ქვევით შესანარჩუნებლად, სადაც მობილური შემწოვი მოწყობილობა წყალსაცავის ფსკერიდან იწოვს შეტივტივებული ნაწილაკების შემცველ წყლის ნაწილს და სადაც მოწყობილობა ქმედითუნარიანია 24 საათში გაწმინდოს 10000 მ² ზომის ზედაპირი; გ) მობილური შემწოვი მოწყობილობით შეწოვილი წყლის გაფილტრვას და გაფილტრული წყლის დაბრუნებას წყალსაცავში, სადაც მობილური შემწოვი მოწყობილობით 24 საათის ინტერვალში შეწოვილი წყალი არ აჭარბებს წყალსაცავში წყლის მთლიანი მოცულობის 10%-ს, დ) ცხიმგამცლელი სისტემის ამუშავებას წყლის, სულ მცირე, 1 სმ ზედაპირული წყლის შრეში მცურავი ცხიმების შემცველობის 20 მგ/ლ ნაკლებ რაოდენობაზე შესანარჩუნებლად, სადაც ზედაპირული წყლიდან ცხიმგამცლელ სისტემაში გადინებული ცხიმების ამოღებას ახდენენ სეპარატორით და ქიმიურად დამუშავებულ წყალს აბრუნებენ წყალსაცავში.

მუსხლები: 2 დამოუკიდებელი
 41 დამოკიდებული
 ფიგურა: 4

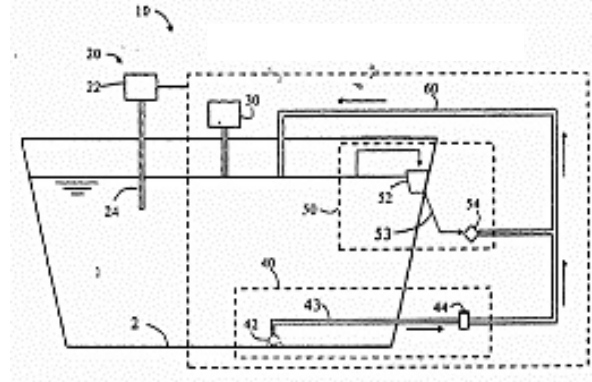

ფიგ. 2

C 07

(10) AP 2018 13584 A (51) Int. Cl. (2006)
 C 07 D 213/75
 C 07 D 217/22
 C 07 D 401/04
 C 07 D 401/06
 C 07 D 401/14
 C 07 D 405/14
 C 07 D 407/06
 C 07 D 407/12
 C 07 D 409/04
 C 07 D 409/06
 C 07 D 409/14
 C 07 D 413/04
 C 07 D 413/14
 C 07 D 417/04
 C 07 D 417/06

(21) AP 2013 013584 (22) 2013 02 25
 (31) 12157199.6
 (32) 2012 02 27
 (33) EP

(71) ბოერინგერ ინგელჰაიმ ინტერნაციონალ გმბჰ (DE)
 ბინგერ შტრასე 173, 55216 ინგელჰაიმ ამ რაინ (DE)

(72) ულრის რაიხერი (DE);
 გერდ ბადერი (DE);
 ვალტერ სპევაკი (DE);
 ანდრეას შტეფენი (DE);
 ელასტეირ ლ. პარკესი (DE)

(74) თამარ კოჭლამაზაშვილი
 (85) 2014 09 26

(86) PCT/EP2013/053689, 2013 02 25

(54) **6 - ალკინილპირიფინები, რომორც
 SMAC იმიტატორები**

(57) განაცხადში აღწერილია 6-ალკინილპირიდინები, მათი გამოყენება SMAC მიმეტიკების სახით. მათი შემცველი ფარმაცევტული კომპოზიციები და მათი გამოყენება სამკურნა-

ლო საშუალებების სახით, რომლებიც გამოი-
ნულია ისეთი დაავადებების სამკურნალოდ
და/ან პრევენციისთვის, რომლებიც ხასიათდ-
ება უჯრედების ჭარბი ან ანომალური პროლი-
ფერაციით.

მუხლები: 4 დამოუკიდებელი
18 დამოკიდებული

(10) AP 2018 13881 A (51) Int. Cl. (2006)
C 07 D 241/26
A 61 K 31/4965
A 61 P 11/12

(21) AP 2013 013881 (22) 2013 12 13
(31) 61/738,248
(32) 2012 12 17
(33) US
(71) პერიონ საიენსის, ინკ. (US)
2800 მერიდიან პარკევი, სვიტ 195,
დურჰამი, ჩრდილოეთ კაროლინა
27713 (US)

(72) მაიკლ, რ. ჯონსონი (US)

(74) შალვა გვარამაძე

(85) 2015 07 10

(86) PCT/US2013/075108, 2013 12 13

(54) **ქლორ-პირაზინი პარბოქსამიდური**
წარმოებულები ლორწოვანის არასა-
კმარისი ჰიდრატაციით გამოწვეული
დაავადებების სამკურნალოდ
გამოსაყენებლად

(57) ნაერთი ფორმულით (I),

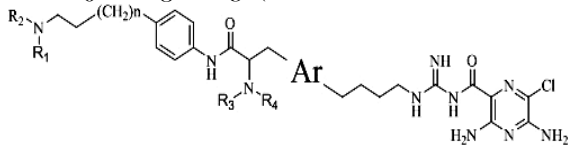

ფარმაცევტული კომპოზიციები მათ საფუძ-
ველზე და მათი გამოყენება ნატრიუმის არსე-
ბის ბლოკირებისთვის.

მუხლები: 31 დამოუკიდებელი
20 დამოკიდებული

ფიგურა: 14

(10) AP 2018 13579 A (51) Int. Cl. (2006)
C 07 D 311/58
A 61 K 31/353
A 61 K 31/40025
A 61 P 5/00
A 61 P 19/00

(21) AP 2013 013579 (22) 2013 02 22
(31) 178/KOL/2012; 1030/KOL/2012
(32) 2012 02 24; 2012 09 07
(33) IN; IN

(71) ლუპინ ლიმიტედ (IN)

კალპატარუ ინსფაირ, 3რდ ფლურ,
ოფ ვესთერნ ექსფრესს ჰაივეი,

სანტაკრუს (ისთ), მუგზაი 400 055,
მაჰარაშის სახელმწიფო, ინდოეთი (IN)
(72) მანოჯკუმარ, რამპრასად შუკლა (IN);
ანკუს, განგრა სარდე (IN);
რაჯეშკუმარ, მაგანდალ ლორია (IN);
ვიპულ, დილიფ პანპუტ (IN);
ნაენას, ბაჯირაო ვალკე (IN);
ტალპა, პუსსეინ ხან (IN);
სანჯივ, ანანთ კულკარნი (IN);
ვენკატა, პ. პალლე (IN);
რაჯენდერ, კუმარ კამბოჯ (IN)

(74) ლარისა ამირხანიანი

(85) 2014 09 23

(86) PCT/IB2013/051445, 2013 02 22

(54) **ჩანაცვლებული ქრომანის**
ნაერთები, რომლებიც კალციუმ-
მგბრებობიარე რეცეპტორის
მოდულატორები

(57) გამოგონებაში წარმოდგენილია კალ-
ციუმმგბრებობიარე რეცეპტორის მოდულატო-
რები (CaSR), კერძოდ, აქ აღწერილია ნაერთე-
ბი ფორმულით I

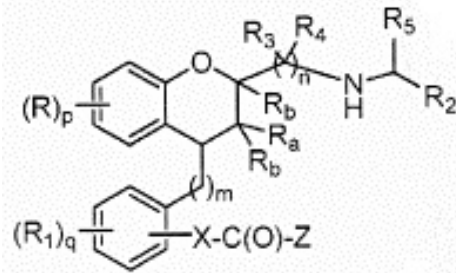

(I)

მათი შემცველი ფარმაცევტული კომპოზი-
ციები და მათი მიღების ხერხები.

მუხლები: 5 დამოუკიდებელი
19 დამოკიდებული

(10) AP 2018 13634 A (51) Int. Cl. (2006)
C 07 D 401/06
A 61 K 31/454
A 61 P 3/04

(21) AP 2013 013634 (22) 2013 04 18
(31) 61/636,108
(32) 2012 04 20

(33) US

(71) ჰელსინ ჰელთქეა სა (CH)
ვია პიან სკაიროლო 9, CH-6912
ლუგანო/პაცალო (CH)

(72) შინ-იუ კუვაბე (JP);

ტაკეჰიკო იანაგიმაჩი (JP);

ჰიდეიუკი იოშიიამა (JP);

სიმონ პაინსი (US);

ელეონორ დე გროტი (US);

სილვინა გარსია რუბიო (US);

პიტერ მანინი (CH)

(74) შალვა გვარამაძე

(85) 2014 11 17

(86) PCT/US2013/037159, 2013 04 18

(54) **ქლორიდის რეგულირებადი
შემცველობის მქონე ანამორფიის
ჰიდროქლორიდის მიღების ხერხები**

(57) ანამორფიის მონოჰიდროქლორიდის მიღების ხერხი ქლორიდის რეგულირებადი შემცველობით და ფარმაცევტული კომპოზიციები, რომელიც შეიცავს ანამორფიის მონოჰიდროქლორიდს.

მუხლები: 5 დამოუკიდებელი
11 დამოკიდებული

ცხრილი: 4

ფიგურა: 2

ფიგურა: 6

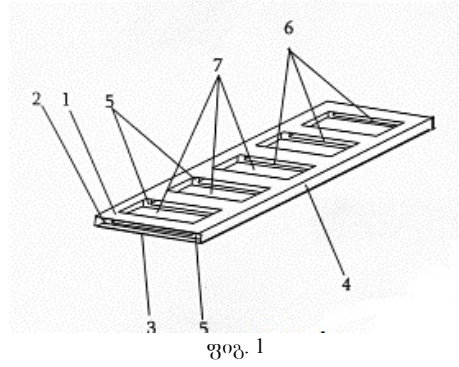

ბანყოფილება E

E 04

(10) AP 2018 14227 A (51) Int. Cl. (2006)
E 04 C 2/296

(21) AP 2016 014227 (22) 2016 07 28

(71) ვახტანგ დვალიშვილი (GE)
ი. პეტრიწის ქ. 31, 4600, ქუთაისი (GE);
თეიმურაზ გოგოლაძე (GE)
ნუცუბიძის ქ. 26ა, ბ. 89, 4600,
ქუთაისი (GE);
მარიამ დვალიშვილი (GE)
როდზევის ქ. 7, 4600, ქუთაისი (GE)

(72) ვახტანგ დვალიშვილი (GE);
თეიმურაზ გოგოლაძე (GE);
მარიამ დვალიშვილი (GE)

(74) არჩილ გეგუჩაძე

(54) **სტრუქტურული სენდვიჩ-პანელი**

(57) სენდვიჩ-პანელი შეიცავს ფურცლოვანი მასალის დამზადებულ შიგა კედელს 1, შიგა მხრიდან თბოსაიზოლაციო ფენით 2 დაფარულ გარე კედელს 3, მათ შორის განთავსებულ განივ დიაფრაგმებს 5, რომლებშიც შესრულებულია ღიობები 6, და გვერდით კედლებს 4, რომლებიც შესრულებულია გარე კედლის გვერდით წიბოებზე გადანაკეცების სახით. გვერდით კედლებსა და შიგა კედელს გვერდით წიბოებზე აქვს სამონტაჟო გადანაკეცები ერთმანეთთან დასაკავშირებლად, დიაფრაგმებს მთელ პერიმეტრზე წიბოებზე აქვს სამონტაჟო გადანაკეცები ყველა კედელთან დასაკავშირებლად, შიგა კედელზე, დიაფრაგმებს შორის შესრულებულია სამონტაჟო ღიობები 7, რომლებსაც აქვს აღნიშნული კედლის სისქის შესაბამისი რელიეფურად ჩაზნექილი წიბოები 11 და მათში მოთავსებულია მათივე იდენტურკონტურიანი სახსნელი ხუფები 12.

მუხლები: 1 დამოუკიდებელი

ბამომონების კატეგორიები

ბანყოფილება A

A 61

- (11) P 2018 6869 B** **(51) Int. Cl. (2006)**
A 61 K 8/362
A 61 K 8/41
A 61 Q 5/00
A 61 Q 5/04
A 61 Q 5/08
A 61 Q 5/10
- (10) AP 2018 14045 A (44) 5(489)/2018
 (21) AP 2014 014045
 (22) 2014 08 01
 (24) 2014 08 01
 (31) 61/867,872; 61/861,281; 61/885,898;
 61/903,239; 14/257,089; 14/257,056;
 14/257,076; 62/000,340
 (32) 2013 08 20; 2013 08 01; 2013 10 02;
 2013 11 12; 2014 04 21; 2014 04 21;
 2014 04 21; 2014 05 19
 (33) US; US; US; US; US; US; US; US
 (86) PCT/US2014/049388, 2014 08 01
 (73) ლიკვლი, ინკ. (US)
 1482 ისტ ველი როუდ, N701,
 სანტა-ბარბარა, კალიფორნია 93108 (US)
 (72) ერიკ დ. პრესლი (US);
 კრეიგ ჯ. სოკერი (US)
 (74) თამარ კოჭლამაზაშვილი
 (54) **თმის და კანის ზიზღის ხერხი**

- (11) P 2018 6870 B** **(51) Int. Cl. (2006)**
A 61 K 9/00
A 61 M 15/00
A 61 K 31/167
A 61 K 31/40
B 65 D 83/54
A 61 K 31/573
- (10) AP 2018 14192 A (44) 4(488)/2018
 (21) AP 2014 014192
 (22) 2014 12 23
 (24) 2014 12 23
 (31) 13199783.5
 (32) 2013 12 30
 (33) EP
 (86) PCT/EP2014/079258, 2014 12 23
 (73) ჩიესი ფარმასეუტიჩი ს.პ.ა. (IT)
 ვია პალერმო, 26/A, I-43100 პარმა (IT)
 (72) საურო ბონელი (IT);
 დიეგო კოპელი (IT);
 მასიმელიანო დავლი ალბერი (IT);
 ფრანჩესკა უსბერტი (IT);
 ენრიკო ძამბელი (IT)

- (74) შალვა გვარამაძე
 (54) **გლიკოპროტინომის პრომიდის და ფორმოტეროლის კომბინაციის დაწესილი სტაბილური ანტიბიოტიკის ხსნარის კომპოზიცია**

- (11) P 2018 6872 B** **(51) Int. Cl. (2006)**
A 61 K 31/7048
A 61 P 31/04
- (10) AP 2018 14327 A (44) 4(488)/2018
 (21) AP 2015 014327
 (22) 2015 05 11
 (24) 2015 05 11
 (31) 14075031.6
 (32) 2014 05 09
 (33) EP
 (86) PCT/EP2015/000965, 2015 05 11
 (73) ასტელას ფარმა იუროპ ლტდ (GB)
 2000 ჰილსვუდ დრაივ, ჩერტსი, სარეი
 KT16 ORS (GB)
 (72) ანდრეას, იოჰანის კარასი (NL);
 ქრისტოფერ, მარკ ლონგუო (NL)
 (74) შალვა გვარამაძე
 (54) **ტიპოპროტინომის ნაერთით მკურნალობა**

- (11) P 2018 6874 B** **(51) Int. Cl. (2006)**
A 61 K 38/14
A 61 K 31/545
C 07 D 501/00
C 07 K 9/00
- (10) AP 2018 13957 A (44) 2(486)/2018
 (21) AP 2014 013957
 (22) 2014 03 06
 (24) 2014 03 06
 (31) 61/779,065
 (32) 2013 03 13
 (33) US
 (86) PCT/US2014/021064, 2014 03 06
 (73) ტერეფანს ბაიოფარმა ანტიბაიოტიკს
 აპ, ლლკ (US)
 901 გეითვეი ბუდვარ, საუთ სან ფრან-
 ცისკო, კალიფორნია 94080 (US)
 (72) ვეიცზიან ჩუანგი (US);
 რონი ჩუენგი (US);
 დიმიტარ ფილიპოვი (US);
 ჯეკ გრინი (US);
 ცუენინ ლი (US)
 (74) თამაზ შილაკაძე
 (54) **ანტიბიოტიკური ნაერთის ჰიდროქლორიდის მარილები**

- (11) P 2018 6866 B** **(51) Int. Cl. (2006)**
A 61 K 39/395
 (10) AP 2018 13302 A (44) 4(488)/2018
 (21) AP 2012 013302
 (22) 2012 05 02
 (24) 2012 05 02
 (31) 61/481,522; 61/544,054
 (32) 2011 05 02; 2011 10 06
 (33) US; US
 (86) PCT/US2012/036069, 2012 05 02
 (73) მილენიუმ ფარმასეუტიკალს ინკ. (US)
 40 ლენდსლოუნ სტრიტ, კემბრიჯი,
 მასაჩუსეტსი 02139 (US)
 (72) უილოუ დოლუზიო (US);
 ფჰონგ მ. ნგუენი (US);
 კსანად მ. ვარგა (US);
 ვაიტჰიანატჰან პაღანიანი (US);
 ჯეისონ ბრაუნი (US);
 ირვინგ ჰ. ფოქსი (US);
 კეტრინ სკოლზი (US);
 ერიკა ჰელენ ჯენკინსი (GB);
 მარია როზარიო (PT)
 (74) შალვა გვარამაძე
 (54) **ანტი-αβ7 ანტისხეულის შემადგენლობა**

- (11) P 2018 6865 B** **(51) Int. Cl. (2006)**
A 61 M 15/00
 (10) AP 2018 14377 A (44) 4(488)/2018
 (21) AP 2015 014377
 (22) 2015 06 19
 (24) 2015 06 19
 (31) 141755021.6
 (32) 2014 06 30
 (33) EP
 (86) PCT/EP2015/063803, 2015 06 19
 (73) კიეზი ფარმაჩეუტიკი ს.პ. ა. (IT)
 ვია პალერმო, 26/ა, I-43122 პარმა (IT)
 (72) ვალერიო ტამპიერი (IT);
 ლორენცო ზუჩერი (IT);
 ემილიანო ილანდი (IT);
 ელის კამპანინი (IT);
 ირენე პასკუალი (IT);
 პატრიკ ჯერარდ ლინანე (IT);
 ნიკოლას ლი პაუსონი (IT);
 დევიდ გეილი (IT);
 ჯოან გარადი (IT)
 (74) ალექსანდრე გეგეჰკორი
 (54) **ფხვნილოვანი ინჰალატორი**
და მისთვის განკუთვნილი შესუნთქვით
აქტივირებადი მემბრანა

ბანყოფილება B

B 28

- (11) P 2018 6867 B** **(51) Int. Cl. (2006)**
B 28 B 19/00
 (10) AP 2018 13882 A (44) 5(489)/2018
 (21) AP 2012 013882
 (22) 2012 12 12
 (24) 2012 12 12
 (31) PCT/EP2012/075266
 (32) 2012 12 12
 (33) EP
 (86) PCT/EP2012/075266, 2012 12 12
 (73) კნაუფ გიპს კგ (DE)
 ამ ბანჰოფ 7, 97346 იჰჰოფენი (DE)
 (72) მარტინ ხალბახი (DE);
 იურგენ მარტინი (DE);
 გოსბერტ გრეგენერი (DE);
 ანდრეას ხანაუერი (DE)
 (74) თამარ კოჭლამაზაშვილი
 (54) **საბათქაში ფილის წარმოების**
ხერხი და მოწყობილობა ფილის
დასამზადებლად

ბანყოფილება C

C 07

- (11) P 2018 6871 B** **(51) Int. Cl. (2006)**
C 07 C 237/22
 (10) AP 2018 14220 A (44) 5(489)/2018
 (21) AP 2014 014220
 (22) 2014 12 23
 (24) 2014 12 23
 (31) 61/920,672
 (32) 2013 12 24
 (33) US
 (86) PCT/US2014/072150, 2014 12 23
 (73) ონკოტარტის, ინკ. (US)
 სუიტ 480, 640 ელიკოტ სტრიტ, ბუფალო,
 NY 14203 (US)
 (72) ალექსანდრ პოლინსკი (US);
 ლიუბოვ კოროჩკინა (US);
 სლავოლიუბ ვუჟიკი (US);
 ოლგა ჩერნოვა (US)
 (74) თამარ კოჭლამაზაშვილი
 (54) **პენზამილის და ნიკოტინამიდის**
ნაერთები და მათი გამოყენება

(11) P 2018 6864 B (51) Int. Cl. (2006)
C 07 D 401/14
C 07 D 413/14
C 07 D 401/04
A 61 K 31/506
A 61 K 31/4545
A 61 K 31/5377
A 61 P 3/00
C 07 D 491/08
C 07 D 487/04

(10) AP 2018 14268 A (44) 3(487)/2018
(21) AP 2015 014268
(22) 2015 03 03
(24) 2015 03 03
(31) 61/954,351
(32) 2014 03 17
(33) US

(86) PCT/IB2015/051560, 2015 03 03

(73) პუაიზერ ინკ. (US)
235 ისტ 42 სტრიტ, ნიუ-იორკი,
ნიუ-იორკი 10017 (US)

(72) შონ კაბრალი (US);
კენტარო ფუტაცუგი (US);
დევიდ ჰეპვორტი (US);
კიმ ჰუარდი (US);
დანიელ ვეიშუნ კუნი (US);
სუვი ტულა მარიუკა ორი (US);
კუნ სუნი (US)

(74) თამარ კოჭლამაზაშვილი

(54) დიაცილიბრიციმროლ აცილიტრანს-
ფერაზა 2 ნიპიბიტოტრანს ბამონენება
მეტაბოლური და მათთან დაკავშირებ-
ბული დარღვევების სამკურნალოდ

(11) P 2018 6868 B (51) Int. Cl. (2006)
C 07 F 9/45
A 61 P 35/04
A 61 K 31/662

(10) AP 2018 13996 A (44) 5(489)/2018

(21) AP 2015 013996

(22) 2015 04 07

(24) 2015 04 07

(31) PV 2013-308; PV 2014-66

(32) 2013 04 24; 2014 01 29

(33) CZ; CZ

(86) PCT/CZ2014/000035, 2015 04 07

(73) სმარტ ბრეინ ს.რ.ო. (CZ)
ვიდენსკა 1083, 14220 პრალა 4 (CZ);
ბიოტექნოლოგიკი უსტავ ავ ჩრ,
ვ.ვ.ო. (CZ)
ვიდენსკა 1083, 14220 პრალა 4 (CZ);
ირჟი ნეუჟილ (CZ)
პოლიანოვოვა 3158/5, 14300 პრალა 4 (CZ);
კეცე ავ (CH)
კაპელგასსე 21, 6004 ლუცერნი (CH);

(72) ირჟი ნეუჟილ (CZ);
იან შტურსა (CZ);

ლუკაშ ვერნერ (CZ)

(74) ლარისა ამირხანიანი

(54) ტამონენების წარმოებები
სიმსივნური დაავადებების სამკურ-
ნალოდ, განსაკუთრებით კი ოსთეოსის,
რომლებსაც HER2 პროტეინის მაღალი
ღონე აქვთ

ბანყოფილება G

G 06

(11) P 2018 6873 B (51) Int. Cl. (2006)
G 06 T 15/00
A 63 F 13/00
G 06 T 17/00
G 06 T 19/00
H 04 N 5/272

(10) AP 2018 14351 A (44) 4(488)/2018

(21) AP 2015 014351

(22) 2015 05 20

(24) 2015 05 20

(31) 20140637

(32) 2014 05 21

(33) NO

(86) PCT/NO2015/050085, 2015 05 20

(73) ზი ფიუნერ გრუპ ას (NO)
სერკელაღსვეინ 6, N-0369 ოსლო (NO)

(72) ბორდ-ანდერს კაზინი (NO)

(74) შალვა გვარამაძე

(54) სისტემა სტრუქტურული წარმოსახვი-
თი მოდელირებული ბამონენების
რეალურ ვიდეოკატან შმსათავ-
სებლად

სასარგებლო მოდელები

ბანასხალაზი, რომელზეც გამოტანილია გადაწყვეტილება პატენტის ბასემის შესახებ

გადაწყვეტილების გასაჩივრება შესაძლებელია საქპატენტის სააპელაციო პალატაში გამოქვეყნებიდან 3 თვის ვადაში ან მცხეთის რაიონული სასამართლოს ადმინისტრაციულ საქმეთა კოლეგიაში 1 თვის ვადაში (მის.: ქ. მცხეთა, სამხედროს ქ. №17).

ბანყოფილება A

A 23

(10) AU 2018 14589 U (51) Int. Cl. (2006)

A 23 L 1/06

(21) AU 2017 14589 (22) 2017 09 18

(71) დავით შავგულიძე (GE)

გოგებაშვილის I შესახვევი 7, თბილისი,
საქართველო (GE)

(72) დავით შავგულიძე (GE)

(54) საკვები პროდუქტის „პომი“

დამზადების ხერხი

(57) ხერხი ითვალისწინებს პომიდვრის გარეცხვას, დახარისხებას, დაქუცმაცებას, ბლანშირებას ორთქლის ქვაბში, მასში სუნელსანელებლების შერევას და სიმინდის ან ხორბლის ფქვილის დამატებას, მიღებულ მასაში თხილის ან მიწის თხილის შერევას და ჩურჩხელის ფორმის მიცემას, შრობას, დაფასობას და შეფუთვას.

მუხლები: 1 დამოუკიდებელი

1 დამოკიდებული

A 43

(10) AU 2018 14429 U (51) Int. Cl. (2006)

A 43 B 17/00

(21) AU 2017 014429 (22) 2017 02 20

(71) მაია გრძელიძე (GE)

გელათის ქ. 117, 4600, ქუთაისი (GE);

ავთანდილ ქათამაძე (GE)

ჯავახიშვილის ქ. 49/14, 4616,

ქუთაისი (GE)

(72) მაია გრძელიძე (GE);

ავთანდილ ქათამაძე (GE)

(54) ეკოლოგიური ორთოპედიული

ჩასაფენი ღაბაში

(57) ჩასაფენი ღაბაში შედგება ორი ფენისაგან. მისი ერთი ფენა შესრულებულია პერფორირებული ბუნებრივი ტყავისაგან, ხოლო მეორე – ნახევრადმოთელილი შალის ბოჭკოს ფენისაგან. ფენები ერთმანეთთან დაკავშირებულია ძაფური გვირისტის საშუალებით.

მუხლები: 1 დამოუკიდებელი

ფიგურა: 2

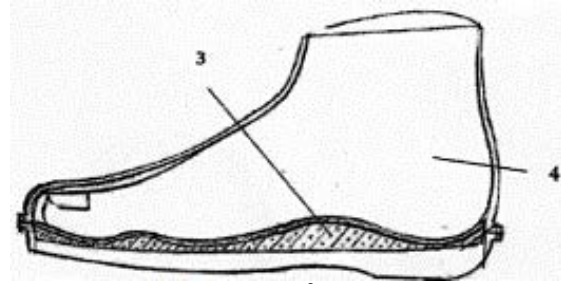

A 47

(10) AU 2018 14654 U (51) Int. Cl. (2006)

A 47 G 21/00

(21) AU 2017 14654 (22) 2017 12 20

(31) AU 2017 14573

(32) 2017 08 17

(33) GE

(71) ვლადიმერ საანიშვილი (GE)

ი. აბაშიძის ქ. 31, ბ. 19, 0179, თბილისი,

საქართველო (GE)

(72) ვლადიმერ საანიშვილი (GE)

(74) შალვა გვარამაძე

(54) შიბთაშვიანი ცომეული ნაწარმის -
ხინკლის დასაპაგებელი სამარჯვი

(57) სამარჯვი შეიცავს კორპუსს, რომელიც შედგება ორი იდენტური ფორმის დრუ ნახევარცილინდრისებრი ნაწილისაგან 1, რომლებიც ერთი ბოლოთი დაკავშირებულია ერთმანეთთან მაერთებელი ელემენტით 2, ხოლო მის მოპირდაპირედ, თითოეული ნახევარცილინდრისებრი ნაწილის შიგა მხარეს რადიალურ სიბრტყეში დამაგრებულია ორი კბილი 3. თითოეული ნახევარცილინდრისებრი ნაწილის მეორე ბოლოსთან კი მათ გარე ზედაპირზე ფორმირებულია ფრთების 4 წყვილი სამარჯვის გახსნის უზრუნველსაყოფად.

მუხლები: 1 დამოუკიდებელი

3 დამოკიდებული

ფიგურა: 5

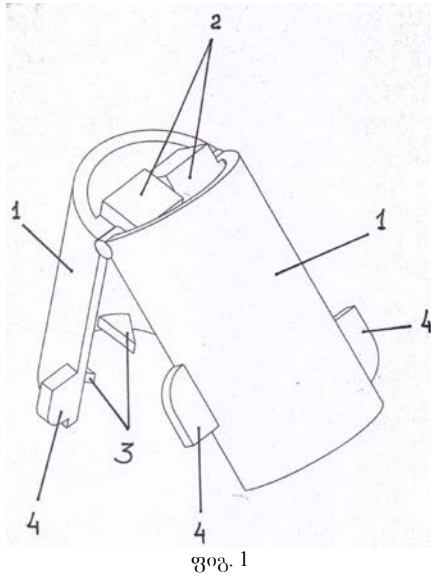

ბანყოფილება B

B 44

(10) AU 2018 14575 U (51) Int. Cl. (2006)
B 44 C 5/00

(21) AU 2017 14575 (22) 2017 08 18

(71) ელგუჯა შენგელია (GE)
დიმიტრი ბაქრაძის ქ. 9-14, 0179, თბილისი,
საქართველო (GE)

(72) ელგუჯა შენგელია (GE)

(74) ალექსანდრე გეგეჭკორი

(54) მხატვრული ნაკეთობის
დამზადების ხერხი

(57) ხერხი ითვალისწინებს გამოსახულების დატანას გამოსახულების მატარებელ ფენაზე ბეჭდვის კომპიუტერული ტექნოლოგიის გამოყენებით, მაგალითად, პრინტერით, პლოტერით ან ოფსეტური ხერხით, გამოსახულების მატარებელი ფენის დაწებებას ფუძის მასალაზე და გამოსახულების მატარებელი ფენის მუშა ზედაპირის ლამინირებას, სადაც ფუძის მასალის სახით გამოიყენება ფურცლოვანი მაგნიტური ვინილი.

მუხლები: 1 დამოუკიდებელი

2 დამოკიდებული

ფიგურა: 4

სასარგებლო მოდელის კატეგორია

განყოფილება A

A 01

- (11) U 2018 1970 Y (51) Int. Cl. (2006)
A 01 B 51/00
B 62 D 21/00
- (10) AU 2018 14476 U (44) 4(488)/2018
(21) AU 2017 014476
(22) 2017 04 18
(24) 2017 04 18
(73) ვასილ ჩხიკვაძე (GE)
ირ. აბაშიძის ქ. 57, 0162, თბილისი (GE)
(72) ვასილ ჩხიკვაძე (GE)
(54) ნიადაგის დამფრთხაველი მოტოვლო-
კისა და მცირეზაბარიტიანი შასის
პირითაღი ჩარჩო
-

დიზაინები

რეგისტრირებული დიზაინები

(11) D 2018 765 S **(51) 19-04**
(10) AD 2018 985 S (44) 5(489) 2018
(21) AD 2017 985
(22) 2017 09 06
(24) 2017 09 06
(28) 1
(18) 2022 09 06
(73) ლევან სმიადაშვილი (GE)
კავთისხევის ქ. 16, 0180, თბილისი, საქართველო (GE)
(72) ლევან სმიადაშვილი (GE)
(54) **წიბნის ჩასაღები**

(11) D 2018 766 S **(51) 32-00**
(10) AD 2018 995 S (44) 5(489) 2018
(21) AD 2017 995
(22) 2017 10 04
(24) 2017 10 04
(28) 10
(18) 2022 10 04
(73) შპს ბატონო (GE)
გოთუას ქ. 8, 0139, თბილისი, ვაკე-საბურთალოს რ-ნი, საქართველო (GE)
(72) ზვიად მათიაშვილი (GE)
(74) ზვიად მათიაშვილი (GE)
(54) **1.-10. ღობო**

სასაქონლო ნიშნები

ეროვნული პროცედურით შემოტანილი განაცხადები, რომლებზეც გამოტანილია გადაწყვეტილება რიზისტრაციის შესახებ

გადაწყვეტილების გასაჩივრება შესაძლებელია საქპატენტის სააპელაციო პალატაში გამო-
ქვეყნებიდან 3 თვის ვადაში ან მცხეთის რაიონული სასამართლოს ადმინისტრაციულ საქმეთა
კოლეგიაში 1 თვის ვადაში (მის.: ქ. მცხეთა, სამხედროს ქ. №17).

(260) AM 2018 91940 A*

(210) AM 91940

(220) 2017 05 02

(731) ზაკრიტოე აკციონერნოე ობშესტვო
„კანონფარმა პროდაკშნ“
ულ. ზარენაია 105, მოსკოვი, 141100,
შელკოვო მ.ო., რუსეთის ფედერაცია

(740) დავით ჩქოფოია

(540)

ტობიზილი

TOBIZIL

ТОБИЗИЛ

(511)

5 – მავნე ცხოველების გასანადგურებელი სა-
შუალებები; პერბიციდები.

(260) AM 2018 92481 A

(210) AM 92481

(220) 2017 05 30

(731) ბავი პროფეშნლ პროდაქტს ლტლ
194 დერეს აკკო სტ. 27000 კირიატ ბიალიკ,
ისრაელი

(740) შალვა გვარამაძე

(540)



(591) თეთრი, წითელი, მუქი წითელი

(531) 26.01.01; 26.01.20; 26.15.01; 29.01.12

(511)

3 – აბრაზივები; მინაღულის მოსაცილებელი სა-
ყოფაცხოვრებო დანიშნულების პრეპარატები;
ანტისტატიკები, საყოფაცხოვრებო მიზნებისათ-
ვის; შეკუმშული ჰაერის ბალონები დაღაგებისა

და მტვრის მოცილებისათვის; გასაპრიალებელი
ძელაკები; აბრაზიული ქაღალდები; ზუმფარის
ქაღალდები; გასაპრიალებელი ქაღალდი; თეთ-
რეულისათვის სურნელის მიმნიჭებელი არომა-
ტული ნივთიერებები; ტენის მშთანთქმელი ნივ-
თიერებები ჭურჭლის სარეცხი მანქანებისათვის;
იატაკის ცვილი; იატაკის ცვილი გასრიალების
თავიდან ასაცილებლად; ავეჯისა და იატაკის
გასაპრიალებელი ცვილები; საპრიალებელი
ცვილები; იატაკის სითხეები გასრიალების თა-
ვიდან ასაცილებლად; სითხეები მინის გასაწ-
მენდად, მათ შორის, საქარე მინების; სახეხი ქე-
ბი; ლითონის კარბიდი (აბრაზიული მასალები);
საპრიალებელი დიატომური მინა (კიზელგური);
საპნის ხის ქერქი რეცხვისათვის; კორუნდი (აბ-
რაზივი); თეთრეულის საღებავები; საღებავები
ტუალეტში ჩამდინარე წყლისათვის; სახამებე-
ლი (აპრეტი); თეთრეულისათვის ბზინგარების
მიმნიჭებელი სახამებელი; კანის კრემები, ცვი-
ლი კანისათვის; გასაპრიალებელი კრემები; წი-
თელი კროკუსი გაპრიალებისათვის; გამწმენდი
ზეთები; სკიპიდარის ზეთი განცხიმვისათვის;
შესათეთრებელი ცარცი; გამწმენდი ცარცი; საპ-
ნები; მადეზინფიცირებელი საპნები; მადეზოდი-
რებელი საპნები; ქსოვილის ფერების გამახალი-
სებელი საპნები; ზუმფარა; სამართებლის საღე-
სი ღვედების პასტები; აბრაზიული ტილო; მინის
აბრაზივიანი ზუმფარის ტილო; სარეცხის ჩასა-
ღობი პრეპარატები; პრეპარატები ინსტრუმენ-
ტების აღესვისათვის; პეწის მიმცემი პრეპარა-
ტები (გასახამებელი); გაუფერულების პრეპარა-
ტები; გასაპრიალებელი პრეპარატები; თეთრეუ-
ლისათვის ბრწყინვალეების მიმნიჭებელი პრეპა-
რატები; პეწის (კრიალის) მიმნიჭებელი პრეპარა-
ტები; თეთრეულის რეცხვისათვის დამარბილე-
ბელი პრეპარატები; პრეპარატები რეცხვისათ-
ვის; მშრალი წმენდის პრეპარატები; საღებავის
მოსაცილებელი პრეპარატები; ღაკის მოსაცი-
ლებელი პრეპარატები; იატაკის ცვილის მოსა-
ცილებელი პრეპარატები (გამწმენდი პრეპარა-
ტები); პოლიტურას მოსაცილებელი პრეპარატე-
ბი; ჟანგის მოსაცილებელი პრეპარატები; გამ-
წმენდი პრეპარატები; შალერის გასაწმენდი
პრეპარატები; ჩასადენი მილების გამწმენდი პრე-

პარატები; რეცხვისათვის მათეთრებელი პრეპარატები; სარეცხის რეცხვისას შეფერილობის (ფერების) გამახალისებელი საყოფაცხოვრებო დანიშნულების ქიმიური პრეპარატები; ბრწყინვალეების მიმნიჭებელი პრეპარატები (საპრიალებელი); ალმასის მტვერი (აბრაზივი); ლაქების ამოსაყვანი საშუალებები; გამწმენდი ხსნარები; თეთრეულის დასამუშავებელი ლილა; სკიპიდარი განცხიმივისათვის; მათეთრებელი სოდა; რეცხვისათვის გამოსაყენებელი სოდა; გამწმენდი სოდა; მათეთრებელი მარილები; ტყავის დამცავი შემადგენლობები (გასაპრიალებელი საშუალებები); ნიშადურის სპირტი (სარეცხი, გამწმენდი საშუალება); ფესხაცმლის მოსაგლედი საშუალებები; სარეცხი საშუალებები, სამრეწველო და სამედიცინო დანიშნულების გარდა; განცხიმივის საშუალებები სამრეწველო დანიშნულების გარდა; ზუმფარის ქსოვილი (ტილო); ჩვრები დალაგებისათვის, რომელიც გაუღენთილია სარეცხი საშუალებებით; შამპუნები; შამპუნები შინაური ცხოველების დასაბანად გამოსაყენებელი; მშრალი (ფხვიერი) შამპუნები; მინის ზუმფარა; ნატრიუმის თუთქი.

21 – აბრაზიული ღრუბლები კანისათვის; ღრუბლები საყოფაცხოვრებო მიზნებისათვის; ტუალეტის ღრუბლები; საწმენდი ზამში; ჯაგრისის ნაწარმი; გასაპრიალებელი ტყავი; კაუმიწა (ნაწილობრივ დამუშავებული) სამშენებლო მიზნებისათვის განკუთვნილის გარდა; ბრწყინვალეების მისაცემი გასაპრიალებელი მასალა, პრეპარატების, ქადადის და ქვის გარდა; ბუმბულის საწმენდები; ცოცხები; ლითონის ნეჭა სამზარეულოს ჭურჭლის გასაწმენდად; ბამბულის ნარჩენები დასუფთავებისათვის; შალის ნარჩენები დასუფთავებისათვის; სელის ანაძენი დასუფთავებისათვის; საყოფაცხოვრებო ხელთათმანები; გასაპრიალებელი ხელთათმანები; ბაღბოსტანში სამუშაო ხელთათმანები; აბრაზიული (სახეხი) ბალიშები სამზარეულოსათვის; ცვილით გაპრიალების მოწყობილობები, არაელექტრული; ლითონის ნეჭა იატაკის საწმენდად; სამურველები; ჩვრები იატაკის მოსარეცხად; ჩვრები დასასუფთავებლად; ჩვრები მტვრის მოსაცილებლად; ჩვრები ავეჯიდან მტვრის გადასაწმენდად; ჭურჭლის სარეცხი ჯაგრისები; ჯაგრისები ტევადობების გასაწმენდად; ლამპის შუშის გასაწმენდი ჯაგრისები; ხეში ჯაგრისები; მექანიკური ჯაგრისები ხალიჩებისათვის; ფესხაცმლის ჯაგრისები; იატაკის ჯაგრისები; ტუალეტის ჯაგრისები; ჯაგრისები.

35 – საქონლის დემონსტრირება; კომერციული ინფორმაცია და რჩევები მომხმარებლისათვის (სასაქონლო სამომხმარებლო ინფორმაცია); საქონლის პრეზენტაცია ყველა მასობრივი ინფორმაციის საშუალებებით საცალო ვაჭრობისათვის; საქონლის გასაღებაში ხელშეწყობა მესამე

პირთათვის; ნიმუშების გავრცელება; მომარაგების მომსახურება მესამე პირთათვის (საქონლის შესყიდვა და უზრუნველყოფა მეწარმეებისათვის); საქონლის საცალო და საბითუმო სავაჭრო მაღაზიების მომსახურება, მათ შორის, ვაჭრობაში საფოსტო კატალოგების და ინტერნეტის საშუალებით.

- (260) AM 2018 92586 A
- (210) AM 92586
- (220) 2017 06 06
- (731) შპს „ვიგო მედიკალ გრუპი“
ლუბლიანას ქ. 5, 0159, თბილისი,
საქართველო
- (740) ნათია კახეთელიძე
- (540)



- (591) შავი და ცისფერი
- (531) 26.01.01; 26.01.03; 26.01.19; 26.01.24; 28.19;
29.01.12
- (511)

44 – სამედიცინო მომსახურება; ვეტერინარული მომსახურება; მომსახურება ცხოველებისა და ადამიანების ჰიგიენისა და კოსმეტიკის სფეროში.

- (260) AM 2018 93782 A
- (210) AM 93782
- (220) 2017 08 16
- (731) შპს „ტეუპების საღვინე სახლი
ნაფარეულში“
სოფ. ნაფარეული, თელავის რაიონი,
საქართველო
- (740) შალვა გვარამაძე
- (540)



- (591) ღია ყავისფერი, მუქი ყავისფერი, თეთრი
- (531) 19.01.06; 19.01.07; 19.09.01; 19.09.02; 26.04.02;
26.04.09; 26.04.22; 26.04.24; 27.05.01;
27.05.10; 27.05.24; 28.19; 29.01.13

(511)
33 – ღვინო, სახელდობრ, ქვევრის ღვინო, მათ შორის, ქვევრის ტკბილი ღვინო, ქვევრის შემაგრებული ღვინო, ქვევრის ტკბილი და შემაგრებული ღვინო.

(260) AM 2018 93834 A
(210) AM 93834
(220) 2017 08 21
(731) შპს „ალიანსი“
კობალაძის ქ. 2, 6004, ბათუმი,
საქართველო
(740) გიორგი კვიციანი
(540)



(591) შინდისფერი, თეთრი
(531) 07.01.24; 26.11.08; 26.11.13; 27.05.10; 27.05.11;
27.05.24; 29.01.12

(511)
37 – მშენებლობა; რემონტი; დანადგარების დაყენება.

39 – ტრანსპორტირება; საქონლის შეფუთვა და შენახვა.

41 – აღზრდა; სასწავლო პროცესის უზრუნველყოფა; გართობა; სპორტული და კულტურულ-საგანმანათლებლო ღონისძიებების ორგანიზება.

42 – სამეცნიერო და ტექნოლოგიური მომსახურება და მასთან დაკავშირებული სამეცნიერო კვლევა და დამუშავება; სამრეწველო ანალიზისა და სამეცნიერო კვლევასთან დაკავშირებული მომსახურება; კომპიუტერების ტექნიკური და პროგრამული უზრუნველყოფის დამუშავება და სრულყოფა.

43 – საკვები პროდუქტებითა და სასმელებით უზრუნველყოფა; დროებითი საცხოვრებელი უზრუნველყოფა.

44 – სამედიცინო მომსახურება; ვეტერინარული მომსახურება; მომსახურება ცხოველებისა და ადამიანების ჰიგიენისა და კოსმეტიკის სფერო-

ში; მომსახურება სოფლის მეურნეობის, მებაღეობისა და მეტყვეობის სფეროში.

(260) AM 2018 93835 A
(210) AM 93835
(220) 2017 08 21
(731) შპს „ალიანსი“
კობალაძის ქ. 2, 6004, ბათუმი,
საქართველო
(740) გიორგი კვიციანი
(540)



(591) შინდისფერი, თეთრი
(531) 07.01.24; 26.11.08; 26.11.13; 27.05.11; 27.05.24;
29.01.12

(511)
37 – მშენებლობა; რემონტი; დანადგარების დაყენება.

39 – ტრანსპორტირება; საქონლის შეფუთვა და შენახვა.

41 – აღზრდა; სასწავლო პროცესის უზრუნველყოფა; გართობა; სპორტული და კულტურულ-საგანმანათლებლო ღონისძიებების ორგანიზება.

42 – სამეცნიერო და ტექნოლოგიური მომსახურება და მასთან დაკავშირებული სამეცნიერო კვლევა და დამუშავება; სამრეწველო ანალიზისა და სამეცნიერო კვლევასთან დაკავშირებული მომსახურება; კომპიუტერების ტექნიკური და პროგრამული უზრუნველყოფის დამუშავება და სრულყოფა.

43 – საკვები პროდუქტებითა და სასმელებით უზრუნველყოფა; დროებითი საცხოვრებელი უზრუნველყოფა.

44 – სამედიცინო მომსახურება; ვეტერინარული მომსახურება; მომსახურება ცხოველებისა და ადამიანების ჰიგიენისა და კოსმეტიკის სფეროში; მომსახურება სოფლის მეურნეობის, მებაღეობისა და მეტყვეობის სფეროში.

(260) AM 2018 93836 A
(210) AM 93836
(220) 2017 08 21
(731) შპს „ალიანსი“
კობალაძის ქ. 2, 6004, ბათუმი,
საქართველო
(740) გიორგი კვირიკაშვილი
(540)



(591) შინდისფერი, თეთრი
(531) 07.01.24; 26.11.08; 26.11.12; 27.05.01; 27.05.11;
27.05.24; 29.01.12
(511)
37 – მშენებლობა; რემონტი; დანადგარების და-
ყენება.
39 – ტრანსპორტირება; საქონლის შეფუთვა და
შენახვა.
41 – აღზრდა; სასწავლო პროცესის უზრუნველ-
ყოფა; გართობა; სპორტული და კულტურულ-
საგანმანათლებლო ღონისძიებების ორგანიზე-
ბა.
42 – სამეცნიერო და ტექნოლოგიური მომსახუ-
რება და მასთან დაკავშირებული სამეცნიერო
კვლევა და დამუშავება; სამრეწველო ანალიზსა
და სამეცნიერო კვლევასთან დაკავშირებული
მომსახურება; კომპიუტერების ტექნიკური და
პროგრამული უზრუნველყოფის დამუშავება და
სრულყოფა.
43 – საკვები პროდუქტებითა და სასმელებით
უზრუნველყოფა; დროებითი საცხოვრებელი
უზრუნველყოფა.
44 – სამედიცინო მომსახურება; ვეტერინარული
მომსახურება; მომსახურება ცხოველებისა და
ადამიანების ჰიგიენისა და კოსმეტიკის სფერო-
ში; მომსახურება სოფლის მეურნეობის, მებაღე-
ჩეობისა და მეტყვეობის სფეროში.

(260) AM 2018 94378 A
(210) AM 94378
(220) 2017 10 02
(731) კარენ ვარდანიანი
ბაირონის ქ. 3, ბ. 36, ერევანი, სომხეთი

(740) გიორგი თაქთაქიშვილი
(540)



(591) თეთრი, წითელი, ვარდისფერი, ბეჟი, ყავის-
ფერი, ყვითელი, რძისფერი, ფორთოხლის-
ფერი, ცისფერი, ლურჯი, მწვანე, ატმისფე-
რი, ოქროსფერი, შავი, ლურჯი, იისფერი,
იასამნისფერი, ხაკი, ნაცრისფერი
(531) 05.01.03; 05.01.09; 05.01.16; 08.01.23; 24.01.10;
27.05.01; 29.01.15
(511)
30 – ყავა, ჩაი, კაკაო, შაქარი, ბრინჯი, ტაპიოკა
(მანიოკა), საგო, ყავის შემცველები; ფქვილი
და მარცვლოვანი პროდუქტი, პურ-ფუნთუშეუ-
ლი, საკონდიტრო ნაწარმი, ნაყინი; თაფლი, ბა-
დაგის ვაჟინი; საფუარი, საცხობი ფხენილები;
მარილი, მდოგვი; ძმარი, საკაზმები; სანელებ-
ლები; საკვები ყინული.

(260) AM 2018 94398 A
(210) AM 94398
(220) 2017 10 02
(731) შპს „თიბისი ფეი“
მარჯანიშვილის ქ. 7, 0102, თბილისი,
საქართველო
(540)

გადაგეხადოს

(531) 28.19
(511)
36 – დაზღვევა; ფინანსებთან დაკავშირებული
საქმიანობა; ფულად-საკრედიტო ოპერაციები;
უძრავ ქონებასთან დაკავშირებული ოპერაციე-
ბი.

(260) AM 2018 94441 A
(210) AM 94441
(220) 2017 10 04
(731) შპს „სენსო ვიტა ფარმასი“
ნიკოლოზ ყიფშიძის ქ. 12ბ, ბ. 51,
თბილისი, საქართველო

(540)

Ceftriovita

(511)

5 – ფარმაცევტული და ვეტერინარული პრეპარატები; სანიტარული პრეპარატები სამედიცინო მიზნებისათვის; დიეტური ნივთიერებები სამედიცინო მიზნებისათვის, ბავშვთა კვება; სალბუნები, გადასახვევი საშუალებები; კბილის დასაბუნჯი საშუალებები, კბილის ტვიფრის დასამზადებელი საშუალებები; დეზინფექტანტები; მავნე ცხოველების გასანადგურებელი საშუალებები; ფუნგიციდები, ჰერბიციდები.

(260) AM 2018 94454 A

(210) AM 94454

(220) 2017 10 05

(731) კაპსი კოათინგს

პორტ-საიდ ინდასტრიალ ზონა, ალ-რასვა,
პ.ო. ბოქს 118, პორტ-საიდ, ეგვიპტე

(740) მერაბ კვიმსაძე

(540)



(591) წითელი, მუქი ლურჯი, ყავისფერი, ნარინჯისფერი, თეთრი, ლურჯი, ცისფერი, ყვითელი, მუქი ყვითელი

(531) 03.07.24; 26.13.25; 27.05.24; 29.01.14

(511)

2 – საფარები [საღებავები]; საღებავები; საგრუნტავები; საღებავის განმზავებლები; ლაკები.

(260) AM 2018 94471 A

(210) AM 94471

(220) 2017 10 06

(731) მერკ შარპ & დომე კორპ.

უან მერკ დრაივი, უაიტჰაუს-სტეიშენი,
ნიუ-ჯერსი, 08889, აშშ

(740) თამაზ შილაკაძე

(540)



MSD

INVENTING FOR LIFE

(591) შავი, თეთრი, ფირუზისფერი

(531) 05.05.20; 26.01.06; 27.05.10; 29.01.13

(511)

16 – ნაბეჭდი მასალა, კერძოდ, სარეკლამო განცხადებები, საინფორმაციო ბიულეტენები, ბროშურები, აფიშები, პლაკატები, საკანცელარიო საქონელი და ბანერები დაკავშირებული ჯანმრთელობის, მედიცინის, ფარმაცევტული პრეპარატების და ფარმაცევტული მრეწველობის სფეროსთან.

44 – ჯანმრთელობის, მედიცინის, ფარმაცევტული პრეპარატების და ფარმაცევტული მრეწველობის სფეროსთან დაკავშირებული ინფორმაციით უზრუნველყოფა.

(260) AM 2018 94490 A

(210) AM 94490

(220) 2017 10 09

(731) შპს „გალერია ქიდს“

რუსთაველის გამზ., 2/4, (ნაკვ. 065/009),
0105, თბილისი, საქართველო

(740) გიორგი თაქთაქიშვილი

(540)

რია-რია

Ria-Ria

(591) შავ-თეთრი

(511)

35 – საცალო გაჭრობის მომსახურება.

41 – ბავშვთა გასართობი ცენტრი.

43 – ბარები; კაფეები; კაფეტერიები; საკვების შეკვეთით დამზადება და შინ მიტანა; რესტორნები; თვითმომსახურების რესტორნები; სასაუბმეები.

(260) AM 2018 94534 A

(210) AM 94534

(220) 2017 10 09

(731) სანოფი-ავენტის დოინლანდ გმბჰ

ბრიუნინგშტრასე 50, 65926 ფრანკფურტი
მაინზე, გერმანია

(740) შალვა გვარამაძე

(540)

ФЕСТАЛ

(591) შავ-თეთრი

(511)

5 – ფარმაცევტული პროდუქტები, სამედიცინო დანიშნულების კვების დანამატები და საკვები დანამატები, სამედიცინო დანიშნულების დიეტური ნივთიერებები, ვიტამინები.

(260) AM 2018 94544 A
(210) AM 94544
(220) 2017 10 10
(731) შპს „გეომოტ“
მელაშვილის ქ. / მაზნიაშვილის ქ. 12/8,
6000, ბათუმი, საქართველო
(540)



(591) შავ-თეთრი
(531) 27.05.22
(511)

9 – სამეცნიერო, საზღვაო, გეოდეზიური, ფოტო-გრაფიული, კინემატოგრაფიული, ოპტიკური, ამ-წონი, გამზომი, სასიგნალო, საკონტროლო (შემოწმების), სამაშველო და სასწავლო ხელსაწყოები და ინსტრუმენტები; ელექტრობის გადაცემის, განაწილების, გარდაქმნის, დაგროვების, რეგულირების ან მართვის ხელსაწყოები და ინსტრუმენტები; ხმის ან გამოსახულების ჩამწერი, გადამცემი და აღმწარმოებელი აპარატურა; ინფორმაციის მაგნიტური მატარებლები, ხმის ჩამწერი დისკები; სავაჭრო ავტომატები და მექანიზმები აპარატებისათვის წინასწარი გადახდით; სალაროს აპარატები, საანგარიშო მანქანები, ინფორმაციის დასამუშავებელი აღჭურვილობა და კომპიუტერები; ცეცხლმქრობები.

35 – რეკლამა; მართვა საქმიან სფეროში; ადმინისტრირება საქმიან სფეროში; საოფისე სამსახური.

38 – კავშირგაბმულობა.

41 – აღზრდა; სასწავლო პროცესის უზრუნველყოფა; გართობა; სპორტული და კულტურულ-საგანმანათლებლო ღონისძიებების ორგანიზება.

42 – სამეცნიერო და ტექნოლოგიური მომსახურება და მასთან დაკავშირებული კვლევა და დამუშავება; სამრეწველო ანალიზსა და სამეცნიერო კვლევასთან დაკავშირებული მომსახურება; კომპიუტერის ტექნიკური და პროგრამული უზრუნველყოფის დამუშავება და სრულყოფა

(260) AM 2018 94547 A
(210) AM 94547
(220) 2017 10 10
(731) შპს „ტრეიდ იმპექსი“
ც. დადიანის ქ.261/30, 0180, თბილისი,
საქართველო

(740) გიორგი თაქთაქიშვილი
(540)

ASNAF

(591) შავ-თეთრი
(511)
29 – კარაქი, ზეთი.
30 – ბრინჯი, ჩაი.

(260) AM 2018 94563 A
(210) AM 94563
(220) 2017 10 11
(731) კრაფტ ფულს გრუპ ბრენდს ლღკ
200 ისტ რენდოლფ სტრიტ, ჩიკაგო,
ილინოისი 60601, აშშ
(740) ნათელა ოთარიძე
(540)



(591) შავი, თეთრი, ყვითელი - ბაცი ყავისფერი
(531) 02.01.23; 09.07.25; 10.03.01
(511)

29 – ხორცი, თევზი, ფრინველი და ნანადირევი; ხორცის ექსტრაქტები; დაკონსერვებული, გაყინული, გამხმარი და თბურად დამუშავებული ბოსტნეული და ხილი; ყელე, მურაბა, კომპოტი; კვერცხი, რძე და რძის პროდუქტები; ზეთები და საკვები ცხიმები; დამუშავებული არაქისი და სხვა დამუშავებული თხილი (კაკალი); საკვები თესლი; გამომშრალი ხილისა და დამუშავებული თხილისგან შემდგარი საუზმეულის ნარევი.

30 – ყავა, ჩაი, კაკაო და ყავის შემცველები; ბრინჯი; ტაპიოკა (მანიოკა) და საგო; ფქვილი და მარცვლოვანი პროდუქტი; პურ-ფუნთუშეული, საკონდიტრო ნაწარმი; ნაყინი; შაქარი, თაფლი, ბადაგის ვაჟინი; საფუარი, საცხობი ფხენილები; მარილი, მდოგვი; ძმარი, საკაზმები; სანელებლები; საკვები ყინული; მზა საკვები და სანელებლებიანი საუზმეული; შოკოლადის შემცველი საუზმეულის ნარევი.

31 – მარცვლოვნები და სოფლის მეურნეობის, ბაღჩა-ბაღისა და ტყის პროდუქტები (ნედლი და დაუმუშავებელი); მარცვლოვნები და თესლი (ნედლი და დაუმუშავებელი); ახალი ხილი, ბოსტნეული და არომატული მწვანილები; ცოცხალი მცენარეები და ყვავილები; ბოლქვები, ჩითიღები და თესლი; ცოცხალი ცხოველები; ცხოველთა საკვები და სასმელი; ალაო; მარცვლეულისა და თხილის (კაკლი) შემცველი საუზმეულის ნარევი; ნედლი თხილი (კაკალი); ახალი თხილი (კაკალი); დაუმუშავებელი თხილი (კაკალი).

(260) AM 2018 94564 A

(210) AM 94564

(220) 2017 10 11

(731) საბგეი აი.ფი. ინკ.

ფლორიდა, 33166, მაიაში სპრინგს, ოთახი 500, როიალ პოინსიანა ბულ. 700, აშშ

(740) მარეხ ამირაშვილი

(540)



(591) ყვითელი და თეთრი

(531) 24.15.02; 24.15.17; 27.05.01; 27.05.17; 29.01.13

(511)

43 – სარესტორნო მომსახურება, მათ შორის, საკვები პროდუქტებითა და სასმელებით უზრუნველყოფა როგორც შენობაში, ასევე მის გარეთ, სარესტორნო მომსახურება, რომელიც გულისხობს სენდვიჩებით უზრუნველყოფას, საზოგადოებრივი კვების ორგანიზება (კატერინგი), ისეთი სარესტორნო მომსახურება, რომელიც გულისხმობს როგორც ადგილზე კვებას, აგრეთვე, თან წადების სერვისს, ადგილზე მიტანის სერვისს.

(260) AM 2018 94565 A

(210) AM 94565

(220) 2017 10 11

(731) საბგეი აი.ფი. ინკ.

33166, ფლორიდა, 33166, მაიაში სპრინგს, ოთახი 500, როიალ პოინსიანა ბულ. 700, აშშ

(740) მარეხ ამირაშვილი

(540)



(591) ყვითელი და მწვანე

(531) 24.15.02; 24.15.17; 28.19; 29.01.12

(511)

43 – სარესტორნო მომსახურება, მათ შორის, საკვები პროდუქტებითა და სასმელებით უზრუნველყოფა როგორც შენობაში, ასევე მის გარეთ, სარესტორნო მომსახურება, რომელიც გულისხობს სენდვიჩებით უზრუნველყოფას, საზოგადოებრივი კვების ორგანიზება (კატერინგი), ისეთი სარესტორნო მომსახურება, რომელიც გულისხმობს როგორც ადგილზე კვებას, აგრეთვე, თან წადების სერვისს, ადგილზე მიტანის სერვისს.

(260) AM 2018 94566 A

(210) AM 94566

(220) 2017 10 11

(731) შპს „სენსო ვიტა ფარმასი“

ნიკოლოზ ყიფშიძის ქ.12ბ, ბ.51, ვაკე-საბურთალო, თბილისი, საქართველო

(540)

Azitrosens

(511)

5 – ფარმაცევტული და ვეტერინარული პრეპარატები; სანიტარული პრეპარატები სამედიცინო მიზნებისათვის; დიეტური ნივთიერებები სამედიცინო მიზნებისათვის, ბავშვთა კვება; საღებუნები, გადასახვევი საშუალებები; კბილის დასაბუნნი საშუალებები, კბილის ტვიფრის დასამზადებელი საშუალებები; დეზინფექტანტები; მავნე ცხოველების გასანადგურებელი საშუალებები; ფუნგიციდები, ჰერბიციდები.

(260) AM 2018 94568 A

(210) AM 94568

(220) 2017 10 11

(731) შპს „სენსო ვიტა ფარმასი“

ნიკოლოზ ყიფშიძის ქ. 12ბ, ბ. 51, ვაკე-საბურთალო, თბილისი, საქართველო

(540)

Flusevit

(511)

5 – ფარმაცევტული და ვეტერინარული პრეპარატები; სანიტარული პრეპარატები სამედიცინო მიზნებისათვის; დიეტური ნივთიერებები სამედიცინო მიზნებისათვის, ბავშვთა კვება; საღებუნები, გადასახვევი საშუალებები; კბილის დასაბუნნი საშუალებები, კბილის ტვიფრის დასამზადებელი საშუალებები; დეზინფექტანტები; მავნე ცხოველების გასანადგურებელი საშუალებები; ფუნგიციდები, ჰერბიციდები.

- (260) AM 2018 94571 A
- (210) AM 94571
- (220) 2017 10 12
- (731) „ფრიჯ სოვაილეს რესტორანტ ბრანჩ ოფ საფირ ნილაა ფორ ჯენერალ ტრეიდინგ“ საღმია, ბლოკ 34, საღემ ალ-მუბარაკ სტრიტ, ბილდინგ 5, ალი ალ-მულა კომ-პლექს, ფლორ 4, ოფისის 7ენდ, ქუევიითი
- (740) მერაბ კვიმსაძე
- (540)



- (591) წითელი, შავი, თეთრი, ყვითელი
- (531) 28.01; 29.01.14
- (511)
- 43 – საკვების შეკვებით დამზადება და საკვებისა და სასმელის ადგილზე მიტანა (წვეულებების მომსახურება); რესტორნებით მომსახურება; თვითმომსახურების რესტორნები; კაფეებით მომსახურება.

- (260) AM 2018 94575 A
- (210) AM 94575
- (220) 2017 10 12
- (731) ფილიპ მორის პროდაქტს ს. ა. კე ჟანრენო 3, 2000 ნევშატელი, შვეიცარია
- (740) შალვა გვარამაძე
- (540)

ON THE ROAD SINCE 1896

- (591) შავ-თეთრი
- (511)
- 34 – დამუშავებული ან დაუმუშავებელი თამბაქო; თამბაქოს პროდუქტები; სიგარები, სიგარეტები, სიგარილოები, საკუთარ სიგარეტში გასახვევი თამბაქო, ჩიბუხის თამბაქო, საღეჭი თამბაქო, საბურნუთე თამბაქო, კრეტეკი; თამბაქო „სნუსი“; თამბაქოს შემცველები (არასამედიცინო დანიშნულების); ელექტრონული სიგარეტები; თამბაქოს პროდუქტები, მათი შემდგომი გათბობის მიზნით; ელექტრონული მოწყობილობები და მათი ნაწილები სიგარეტების ან თამბაქოს ინჰალაციისათვის ნიკოტინის შემცველი აეროზოლის გამოყოფის მიზნით; თხევადი ნიკოტინის ხსნარები ელექტრონულ სიგარეტებში გამოყენებისათვის; მწვევლთა საკუთვნოები, სიგარეტის ქაღალდი, სიგარეტის მილაკები (მუნდ-შტუკები), სიგარეტის ფილტრები, თამბაქოს ქილები, სიგარეტის კოლოფები, საფერფლები, ჩიბუხები, სიგარეტის გადასახვევი ჯობის მოწყობილობები, სანთებლები, ასანთები.

- (260) AM 2018 94577 A
- (210) AM 94577
- (220) 2017 10 12
- (731) ბიმ სანტორი უკ ლიმიტიდ 2 ლონგუოკ როუდი, სტოკლი პარკი, აქსბრიჯი, მიდლსექს, ინგლისი, UB11 1BA, გაერთიანებული სამეფო
- (740) შალვა გვარამაძე
- (540)

ARDMORE

- (591) შავ-თეთრი
- (511)
- 33 – ალკოჰოლიანი სასმელები (ლუდის გარდა); ვისკი.

- (260) AM 2018 94597 A
- (210) AM 94597
- (220) 2017 10 13
- (731) აიდიფ ჰოლდინგ ლტდ კირიაკუ მათსი 16, იგლ ჰაუს, 10 სართ. აგიოი ომლოგიტეს, 1082 ნიქოსია, კვიპროსი
- (740) მერაბ კვიმსაძე
- (540)



- (591) ყვითელი, თეთრი, ნაცრისფერი.
- (531) 02.01.01; 02.01.23; 02.03.01; 02.03.23; 27.05.05; 29.01.13
- (511)
- 36 – საკრედიტო სააგენტოების მომსახურება; დავალიანების ამოღების სამსახურის მომსახურება; უძრავი ქონების სააგენტოების მომსახურება; ფინანსური ანალიზი; განვადება-იჯარის დაფინანსება; შემნახველი ბანკების მომსახურება; იჯარის საფასურის ამოღება; სამგზავრო ჩეკების გამოშვება; საკრედიტო ბარათების გამოშვება; ფასიანი ქაღალდების გამოშვება; კაპიტალის ინვესტიცია; დაზღვევასთან დაკავშირებული ინფორმაცია; ფინანსებთან დაკავშირებული ინფორმაცია; კლირინგი; დაზღვევასთან დაკავშირებული კონსულტაციები; ფინანსებთან დაკავშირებული კონსულტაციები; დავალიანების საკონსულტაციო მომსახურება; საბირჟო კოტირება; სესხის გაცემა გირაოთი; ფინანსური საქმიანობის ლიკვიდაციის სამსახური; საბროკერო საქმიანობა; ფინანსების მართვა; ფულის გადაცემა; ონლაინ საბანკო მომსახურება; სადებეტო ბარათებით გადახდის დამუშავება; საკრედიტო ბარათებით გადახდის დამუშავება; ფატორინგი [დავალიანების ყიდვა-გაყიდვის მომსახურება]; ფულადი სახსრების შეგროვების ორგანიზება; ფინანსების ორგანიზება სამშენებლო პროექტებისთვის; ფინანსური შეფასება [დაზღვევა, სა-

ბანკო ოპერაციები, უძრავი ქონება; რემონტის დანახარჯების ფინანსური შეფასება; ფულადი სახსრების გადარიცხვა ელექტრონული ანგარიშგების სისტემაში; თავდებობა; საბირჟო შუამავლობა; უძრავი ქონების საბროკერო საქმიანობა; კარბონ კრედიტების საბროკერო მომსახურება; დაზღვევასთან დაკავშირებული საშუაშაველო საქმიანობა; სესხები [დაფინანსება]; სესხის გაცემა გირაოთი; ფინანსური ინფორმაციის მიწოდება ვებ საიტების მეშვეობით; ჩეკების ნამდვილობის დადგენა; საქველმოქმედო სახსრების შეგროვება; ფინანსური სპონსორობა; იპოთეკური სესხები; სესხები განვადებით; გადაზღვევა; სიცოცხლის დაზღვევა; ჯანმრთელობის დაზღვევა; დაზღვევა უბედური შემთხვევებისაგან; საზღვაო შემთხვევებისაგან დაზღვევა; დაზღვევა ხანძრისაგან; საბინაო ფონდის მართვა; უძრავი ქონების მართვა; აქტუარის სამსახური; საბანკო მომსახურება; საფონდო ბირჟის საბროკერო მომსახურება; პენსიების გაცემა; მინდობილობით მართვის მომსახურება; სადანაზოგო ფონდების მომსახურება; ფინანსური საბაჟოების საბროკერო მომსახურება; თანაზიარი ფონდები; დაფინანსება; სეიფში შენახვა; ფასეულობის შენახვა; საგადასახადო ექსპერტიზა.

(260) AM 2018 94601 A
(210) AM 94601
(220) 2017 10 13
(731) ჯიმ ბიმ ბრენდს კო.

222 ვ. მერჩანდისე მარტ პლაზა, სუიტ
1600. ჩიკაგო, ილინოისის შტატი, 60654,
აშშ

(740) შალვა გვარამაძე
(540)

RED STAG

(591) შავ-თეთრი
(511)

33 – ალკოჰოლიანი სასმელები. სახელდობრ, არომატიზირებული ვისკი.

(260) AM 2018 94604 A
(210) AM 94604
(220) 2017 10 13
(731) ქული დისტილერი

რივერსთაუნ, დანდეელქ, ქაუნთი ლოუის,
ირლანდია

(740) შალვა გვარამაძე
(540)

KILBEGGAN

(591) შავ-თეთრი

(511)

33 – ალკოჰოლიანი სასმელები (ღუდის გარდა), ვისკი.

(260) AM 2018 94608 A

(210) AM 94608

(220) 2017 10 16

(731) ნადეჟდა კაკაბაძე

მცხეთის ქ. მე-2 შეს. 4, 0179, თბილისი,
საქართველო

(740) ნადეჟდა კაკაბაძე

(540)



(591) მწვანე და თეთრი

(531) 05.01.16; 27.03.11; 29.01.03

(511)

32 – ღუდი, მინერალური და გაზიანი წყალი და სხვა უალკოჰოლო სასმელები; ხილის სასმელები და ხილის წვენები; ვაჟინები და სასმელების დასამზადებელი სხვა შედგენილობები

(260) AM 2018 94609 A

(210) AM 94609

(220) 2017 10 16

(731) ნადეჟდა კაკაბაძე

მცხეთის ქ. მე-2 შეს. 4, 0179, თბილისი,
საქართველო

(740) ნადეჟდა კაკაბაძე

(540)



(591) მწვანე და თეთრი

(531) 05.01.16; 27.05.01; 29.01.12

(511)

32 – ღუდი, მინერალური და გაზიანი წყალი და სხვა უალკოჰოლო სასმელები; ხილის სასმელები

ბი და ხილის წვენები; ვაჟინები და სასმელების დასამზადებელი სხვა შედგენილობები.

- (260) AM 2018 94610 A
- (210) AM 94610
- (220) 2017 10 16
- (731) ნადეჟდა კაკაბაძე
მცხეთის ქ. მე-2 შეს. 4, 0179, თბილისი, საქართველო
- (740) ნადეჟდა კაკაბაძე
- (540)



- (591) მწვანე და თეთრი
- (531) 05.01.16; 28.05; 29.01.12
- (511)
- 32 – ლუდი, მინერალური და გაზიანი წყალი და სხვა უაღკოპოლო სასმელები; ხილის სასმელები და ხილის წვენები; ვაჟინები და სასმელების დასამზადებელი სხვა შედგენილობები.

- (260) AM 2018 94615 A
- (210) AM 94615
- (220) 2017 10 16
- (731) სს „ლიბერთი ბანკი“
ილია ჭავჭავაძის გამზ. 74, 0162, თბილისი, საქართველო
- (740) მიხეილ ქვარაია
- (540)



- (591) ყავისფერი, მწვანე, ყვითელი (ნარინჯისფერი), წითელი, მეწამული, ნაცრისფერი, ცისფერი, იასამნისფერი
- (531) 26.02.08; 26.11.03; 26.11.12; 28.19; 29.01.15
- (511)
- 36 – დაზღვევა; ფინანსებთან დაკავშირებული საქმიანობა; ფულად-საკრედიტო ოპერაციები; უძრავ ქონებასთან დაკავშირებული ოპერაციები.

- (260) AM 2018 94674 A
- (210) AM 94674
- (220) 2017 10 18
- (731) შპს „ავერსი-ფარმა“
დავით აღმაშენებლის გამზ. 148/2, 0112, თბილისი, საქართველო
- (540)

აქვიპლატინი Аквиплатин Aqviplatin

- (591) შავ-თეთრი
- (511)
- 5 – სამკურნალწამლო საშუალება (ფარმაცევტული პროდუქტი, მედიკამენტი).

- (260) AM 2018 94677 A
- (210) AM 94677
- (220) 2017 10 18
- (731) შპს „ავერსი-ფარმა“
დავით აღმაშენებლის გამზ. 148/2, 0112, თბილისი, საქართველო
- (540)

აქვიდოქსი Аквидокс Aqvinox

- (591) შავ-თეთრი
- (511)
- 5 – სამკურნალწამლო საშუალება (ფარმაცევტული პროდუქტი, მედიკამენტი).

- (260) AM 2018 94679 A
- (210) AM 94679
- (220) 2017 10 18
- (731) შპს „ავერსი-ფარმა“
დავით აღმაშენებლის გამზ. 148/2, 0112, თბილისი, საქართველო
- (540)

აქვიპაქსელი Аквипаксел Aqvipaxel

- (591) შავ-თეთრი
- (511)
- 5 – სამკურნალწამლო საშუალება (ფარმაცევტული პროდუქტი, მედიკამენტი).

- (260) AM 2018 94680 A
- (210) AM 94680
- (220) 2017 10 18

(731) შპს „ავერსი-ფარმა“
დავით აღმაშენებლის გამზ. 148/2, 0112,
თბილისი, საქართველო
(540)

აქვითეკანი
Аквитекан
Aqvitecan

(591) შავ-თეთრი
(511)
5 – სამკურნალწამლო საშუალება (ფარმაცევტული პროდუქტი, მედიკამენტი).

(260) AM 2018 94690 A
(210) AM 94690
(220) 2017 10 18

(731) კუმიაი ქემიკალ ინდასტრი კო., ლტდ
4-26, იკენოპატა 1-ჩომე, ტაიტო-კუ, ტოკიო
110-8782, იაპონია

(740) თამაზ შილაკაძე
(540)

VALBON

(591) შავ-თეთრი
(511)
5 – პესტიციდები, ინსექტიციდები, ფუნგიციდები, ინსექტიციდური ფუნგიციდები და პერბიციდები.

(260) AM 2018 94710 A
(210) AM 94710
(220) 2017 10 19

(731) აბდი იბრაჰიმ ილაჩ სანაი ვე თიჯარეთ
ანონიმ შირქეთი
რეშითფაშა მაჰალესი ესქი ბიუიუქდერე
ჯადესი No:4 34467 მასლაქი სარიერი
სტამბოლი, თურქეთი

(740) თამაზ შილაკაძე
(540)

ბენეტი ვიტაცილი

(591) შავ-თეთრი
(511)
5 – ფარმაცევტული პრეპარატები.

(260) AM 2018 94711 A
(210) AM 94711
(220) 2017 10 19

(731) აბდი იბრაჰიმ ილაჩ სანაი ვე თიჯარეთ
ანონიმ შირქეთი
რეშითფაშა მაჰალესი ესქი ბიუიუქდერე
ჯადესი No:4 34467 მასლაქი სარიერი
სტამბოლი, თურქეთი

(740) თამაზ შილაკაძე
(540)

Benet Vitacid

(591) შავ-თეთრი
(511)
5 – ფარმაცევტული პრეპარატები.

(260) AM 2018 94712 A
(210) AM 94712
(220) 2017 10 19

(731) შპს „მზისა“
ოცხელების ქ. 34, ბ. 18, 0145, თბილისი,
საქართველო

(540)

Mzisa
მზისა

(591) შავ-თეთრი
(511)
29 – ზეთები და საკვები ცხიმები

(260) AM 2018 94721 A
(210) AM 94721
(220) 2017 10 20

(731) მერკ შარპ & დომე კორპ.
უან მერკ დრაივი, უაიტჰაუზ-სტეიშენი,
ნიუ-ჯერსი, 08889, აშშ

(740) თამაზ შილაკაძე
(540)



(591) შავი, თეთრი, ფირუზისფერი
(531) 05.05.20; 05.05.21; 26.01.06; 27.05.01; 27.05.10;
29.01.13

(511)
16 – ნაბუჭდი მასალა, კერძოდ, სარეკლამო განცხადებები, საინფორმაციო ბიულეტენები, ბროშურები, აფიშები, პლაკატები, საკანცელარიო საქონელი და ბანერები დაკავშირებული ჯანმრთელობის, მედიცინის, ფარმაცევტული პრეპარატების და ფარმაცევტული მრეწველობის სფეროსთან.

44 – ჯანმრთელობის, მედიცინის, ფარმაცევტული პრეპარატების და ფარმაცევტული მრეწველობის სფეროსთან დაკავშირებული ინფორმაციით უზრუნველყოფა.

- (260) AM 2018 94776 A
 (210) AM 94776
 (220) 2017 10 25
 (731) დავით სოფრომაძე
 მერაბ კოსტავას ქ. 58, 4600, ქუთაისი,
 საქართველო
 (740) შალვა გვარამაძე
 (540)



- (591) შავ-თეთრი
 (531) 05.07.10; 24.01.13; 24.09.08; 24.13.01; 24.13.09;
 24.13.22; 24.13.24; 27.05.01
 (526) "IMERETI", "GEORGIA"
 (511)
 33 – ღვინო.

- (260) AM 2018 94777 A
 (210) AM 94777
 (220) 2017 10 25
 (731) დავით სოფრომაძე
 მერაბ კოსტავას ქ. 58, 4600, ქუთაისი,
 საქართველო
 (740) შალვა გვარამაძე
 (540)



- (591) შავ-თეთრი
 (531) 26.01.04; 26.01.18; 26.01.22; 27.05.21
 (511)
 33 – არაყი.

- (260) AM 2018 94792 A
 (210) AM 94792
 (220) 2017 10 30
 (731) შპს „საქართველოს ცემენტის კომპანია“
 ალ. ყაზბეგის გამზ. 34 (ნაკვეთი 37), 0177,
 თბილისი, საქართველო
 (540)



- (591) ღია ნაცრისფერი, თეთრი
 (531) 26.04.09; 26.04.18; 26.04.24; 27.05.10; 27.05.11;
 27.05.24
 (511)
 19 – არალითონური სამშენებლო მასალა; სამშენებლო დანიშნულების ხისტი მიღები; ასფალტი, ფისები და ბიტუმი; არალითონური მოძრავი კონსტრუქციები და ნაგებობები; არალითონური ძეგლები.

- (260) AM 2018 94821 A
 (210) AM 94821
 (220) 2017 10 31
 (310) 72703
 (320) 2017 06 15
 (330) JM
 (731) ეფლ ინკ.
 1, ინფინიტ ლუპი, კალიფორნია,
 კუპერტინო, 95014, აშშ
 (740) თამარ კოჭლამაზაშვილი
 (540)



- (591) მწვანე, ყვითელი, ნარინჯისფერი, წითელი, იასამნისფერი, ლურჯი
 (531) 05.07.13; 29.01.15
 (511)
 9 – კომპიუტერები; კომპიუტერის აპარატურული მოწყობილობა; გადასატანი კომპიუტერული მოწყობილობა; პორტატიული კომპიუტერები; პლანშეტური კომპიუტერები; სატელეკომუნიკაციო მოწყობილობები და აპარატურა; ტელეფონები, მობილური ტელეფონები; სმარტფონები; უსადენო სატელეკომუნიკაციო მოწყობილობები ხმის, მონაცემების, გამოსახულების, აუდიო-ვიდეო და მულტიმედია კონტენტის გადაცემისათვის; ქსელური სატელეკომუნიკაციო მოწყობილობები და აპარატურა; პორტატიული, ციფრული ელექტრონული მოწყობილობები ინტერნეტში შესვლის უზრუნველსაყოფად, აგრეთვე, სატელეფონო ზარების, ფაქსიმილური შეტყობინებების, ელექტრონული ფოსტის და სხვა ციფრული მონაცემების გადაცემის, მიღებისა და შენახვისათვის; გადასატანი ციფრული ელექტრონული მოწყობილობები ინტერნეტში შესვლის უზრუნველსაყოფად, აგრეთვე, სატელეფონო ზარების, ფაქსიმილური შეტყობინებების, ელექტრონული

ფოსტის და სხვა ციფრული მონაცემების გადაცემის, მიღებისა და შენახვისათვის; სმარტ-საათები; გადასატანი (ტანზე მისამაგრებელი) აქტივობის ტრეკერები; ელექტრონული სამაჯურები (საზომი მოწყობილობები); ელექტრონული წიგნები; კომპიუტერის პროგრამული უზრუნველყოფა; კომპიუტერის პროგრამული უზრუნველყოფა მობილური მოწყობილობების, მობილური ტელეფონების, სმარტ-საათების, სმარტ-სათვალებების, გადასატანი მოწყობილობების, კომპიუტერების, კომპიუტერის პერიფერიული მოწყობილობების, ტელევიზორის მისადგამების, აუდიო და ვიდეოფლეიერების დაყენების, კონფიგურაციის, კონტროლისა და მართვისათვის; პროგრამული უზრუნველყოფა დანართების შემუშავებისთვის; კომპიუტერული თამაშების პროგრამული უზრუნველყოფა; ჩატვირთვადი წინასწარ ჩაწერილი აუდიო, ვიდეო და მულტიმედიაური კონტენტი; კომპიუტერის პერიფერიული მოწყობილობები; პერიფერიული მოწყობილობები კომპიუტერების, მობილური ტელეფონების, მობილური ელექტრონული მოწყობილობების, გადასატანი ელექტრონული მოწყობილობების, სმარტ-საათების, სმარტ-სათვალებების, თავზე მისამაგრებელი საყურისების, ყურსასმენების, ტელევიზორის მისადგამებისა და აუდიო ვიდეოფლეიერებისათვის; გადასატანი (ტანზე მისამაგრებელი) კომპიუტერული პერიფერიული მოწყობილობები; გადასატანი კომპიუტერული პერიფერიული მოწყობილობები კომპიუტერების, მობილური ტელეფონების, მობილური ელექტრონული მოწყობილობების, გადასატანი ელექტრონული მოწყობილობების, სმარტ-საათების, სმარტ-სათვალებების, ტელევიზორების, ტელევიზორების მისადგამებისა და აუდიო ვიდეოფლეიერებისათვის; აქსელერომეტრები; სიმაღლის საზომები; მანძილის საზომი ხელსაწყოები; დისტანციური ჩაწერის მოწყობილობები; ბიჯ-საზომები; წნევის საზომი მოწყობილობები; წნევის ინდიკატორები; მონიტორები, დისფლექსიის ეკრანები, ვირტუალური რეალობის ჩაფხუტები და თავზე გასაკეთებელი მიკროტელეფონის გარნიტურები კომპიუტერთან, სმარტფონებთან, მობილურ ელექტრონულ მოწყობილობებთან, გადასატანი ელექტრონულ მოწყობილობებთან, სმარტ-საათებთან, სმარტ-სათვალებთან, ტელევიზორებთან, აუდიო ვიდეოფლეიერებთან და ჩამწერი მოწყობილობებთან გამოსაყენებლად; სმარტ-სათვალებები; 3D-სათვალებები; სათვალებები; მზის საათვალებები; მინები სათვალებებისათვის; ოპტიკური მინები; ოპტიკური დეტალები; ოპტიკური ხელსაწყოები და იარაღები; ფოტოაპარატები; ციმციმები ფოტოაპარატებისათვის; დისფლექსიის კომპიუტერების, მობილური ტელეფონების, მობილური ელექტრონული მოწყობილობების, გადასატანი (ტანზე მისამაგრებელი) ელექტრონული მოწყობილობების, სმარტ-

საათების, სმარტ-სათვალებების, ტელევიზორების, აუდიო ვიდეოფლეიერებისა და ჩამწერი მოწყობილობებისათვის; კლავიატურები; თავის ტიპის მანიპულატორები; ქვესადებები თავის ტიპის მანიპულატორებისათვის; პრინტერები; დისკური მაგროვებლები და მყარი დისკები; ხმის ჩამწერი და აღმწარმოებელი აპარატურა; ციფრული აუდიო-ვიდეოფლეიერები და ჩამწერი მოწყობილობები; აუდიო დინამიკები; მიმღებები (აუდიო-ვიდეო) და ხმის გამაძლიერებლები; აუდიომოწყობილობები სატრანსპორტო საშუალებებისათვის; ხმის ჩამწერი და ხმის ამომცნობი მოწყობილობები; საყურის-სადებები; ყურსასმენები; მიკროფონები; ტელევიზორები; სატელევიზიო გადაცემები და მონიტორები; ტელევიზორის დეკოდერები; რადიო; რადიოგადამცემები და რადიომიმღებები; გლობალური პოზიციონირების მოწყობილობები (GPS მოწყობილობები); სანავიგაციო მოწყობილობები; დისტანციური მართვის პულტები კომპიუტერების, მობილური ტელეფონების, მობილური ელექტრონული მოწყობილობების, გადასატანი (ტანზე მისამაგრებელი) ელექტრონული მოწყობილობების, სმარტ-საათების, სმარტ-სათვალებების, აუდიო-ვიდეოფლეიერების, ჩამწერი მოწყობილობების, ტელევიზორების, დინამიკების, ხმის გამაძლიერებლების, სახლის კონთაქტრის სისტემებისა და გასართობი სისტემებისათვის; გადასატანი (ტანზე მისამაგრებელი) მოწყობილობები კომპიუტერების, მობილური ტელეფონების, მობილური ელექტრონული მოწყობილობების, სმარტ-საათების, სმარტ-სათვალებების, საყურისების, აუდიო ვიდეოფლეიერებისა და ჩამწერი მოწყობილობების, ტელევიზორების, ტელევიზორის დინამიკების, ხმის გამაძლიერებლების, სახლის კონთაქტრებისა და გასართობი სისტემების მონაცემთა შენახვისათვის; კომპიუტერის ჩიპები; აკუმულატორები; დამტენი მოწყობილობები აკუმულატორებისათვის; ელექტრონული და ელექტრონული კონექტორები, საკომუნიკაციო მოწყობილობები, სადენები, კაბელები, დამტენი მოწყობილობები, დოკ-სადგურები და ადაპტორები ზემოთ აღნიშნული ყველა მოწყობილობებისათვის; ინტერფეისები კომპიუტერის, კომპიუტერის პერიფერიული მოწყობილობების, მობილური ტელეფონების, მობილური ციფრული ელექტრონული მოწყობილობების, გადასატანი (ტანზე მისამაგრებელი) ელექტრონული მოწყობილობების, სმარტ-საათების, სმარტ-სათვალებების, ტელევიზორების, ტელევიზორის კომპიუტერული მისადგამების, აუდიო ვიდეოფლეიერებისა და ჩამწერი მოწყობილობებისათვის; კომპიუტერის ეკრანის დამცავი აფსკები; შალითები, ჩანთები, ბუდეები, გარეკნები (ყდები), ღვედები და თასები კომპიუტერების, მობილური ტელეფონების, მობილური ციფრული ელექტრონული

მოწვობილობების, გადასატანი ელექტრონული მოწვობილობების, სმარტ-საათების, სმარტ-სათვალებების, საყურისების, ყურსასმენების, ტელევიზორის კომპიუტერული მისადგამების, აუდიოვიდეო ფლექსებისა და ჩამწერი მოწვობილობებისათვის; მონოპოდები (ხელის შტატივები); დამტენი მოწვობილობები ელექტრონული სიგარეტებისათვის; ელექტრონული საყელოები ძაღლების (ცხოველების) გაწვრთნისათვის; ელექტრონული უბის წიგნაკები; აპარატები საფოსტო მარკებით გადახდის კონტროლისათვის; სალარო აპარატები; მექანიზმები წინასწარი გადახდის აპარატებისათვის; დიქტოფონები; ხელსაწყოები კუთხეებისა და ნაწიბურების მომრეგალებისათვის; არჩევნების დროს გამოსაყენებელი ხმის დამთვლელი მანქანები; ელექტრონული საჭდეები საქონლისათვის; {ფაქსიმელის აპარატები}; საწონი ხელსაწყოები და იარაღები; საზომები; ელექტრონული დაფები განცხადებებისათვის; საზომი ხელსაწყოები; სილიციუმის პლატები (სილიციუმის ფირფიტები); ინტეგრალური სქემები; ხმის გამაძლიერებლები; ფლუორესენციურებული ეკრანები; დისტანციური მართვის პულტები; ოპტიკური შუქსატარები (ბოჭკოვანი); ელექტროდანადგარები საწარმოო პროცესების დისტანციური მართვისათვის; მეხამრიდები; ელექტროლიზური აბაზანები; ცეცხლმაქრობები; რენდგენის აპარატები სამრეწველო მიზნებისათვის; სამაშველო აღჭურვილობა; ავარიული სასიგნალო მოწვობილობები; მულტიპლიკაციური ფილმები; ოვოსკოპები; სასტვენები ძაღლებისათვის ბრძანების მისაცემად; დეკორატიული მაგნიტები; ელექტროფიცირებული ღობეები; სიჩქარის შემნელებელი გადასატანი მოწვობილობა დისტანციური მართვით; წინდები ელექტროგაბრუნებით; ელექტრონული მოწვობილობები, რომლებიც იმართება ხმით და ამოიცნობს ხმას, რომლებიც განკუთვნილია საყოფაცხოვრებო მოწვობილობებისა და სახლის სისტემების მართვისათვის; პერსონალური ციფრული დამხმარეები; სითბოს მარეგულირებელი მოწვობილობები; თერმოსტატები; სენსორები და მართვის პულტები ჰაერის კონდიციონერის, გათბობის, სავენტილაციო მოწვობილობებისა და სისტემებისათვის; ელექტრონული მარეგულირებელი ხელსაწყოები; განათების მარეგულირებელი ელექტრონული მოწვობილობები; ელექტროროზეტები; ელექტრონული და ელექტრონული გამომრთველები; სიგნალიზაციები, სიგნალიზაციის გადაძვევა და საავარიო სიგნალის მონიტორინგის სისტემები; ბოლის დეტექტორები; ელექტრონული და ელექტრონული საკეტები და საკეტელები კარებისა და ფანჯრებისათვის; ელექტრონული და ელექტრონული მართვის პულტები ფარეხის კარისათვის; სახლის დაცვის სათვალთვალ სისტემები.

14 – საათები და სხვა ქრონომეტრული ხელსაწყოები; მაჯის საათები; საათები; ქრონომეტრები; ქრონოგრაფები, რომლებსაც იყენებენ როგორც ქრონომეტრებს; ქრონომეტრები; საათის თასები; საათის სამაჯურები; ბუდეები მაჯის საათების, საათების, ქრონოგრაფებისა და ქრონომეტრული ხელსაწყოებისათვის; ნაწილები მაჯის საათების, საათების, ქრონოგრაფებისა და ქრონომეტრული ხელსაწყოებისათვის; საიუველირო ნაწარმი.

25 – ტანსაცმელი, ფეხსაცმელი, თავსაბურავი.
 28 – სათამაშოები; თამაშები, სათამაშოები; ბანქო; ელექტრონული ჯობის სათამაშო მოწვობილობები; კომპიუტერული და ვიდეოთამაშები, აგრეთვე, მოწვობილობები კომპიუტერული და ვიდეოთამაშებისთვის სატელევიზიო მიმღებებთან და წინასწარი გადახდის ავტომატებთან გამოყენებისთვის განკუთვნილის გარდა; ბოლიბილდინგის ტრენაჟერები; ფიტნესისა და ვარჯიშისათვის განკუთვნილი მოწვობილობა და აღჭურვილობა.

- (260) AM 2018 94829 A
- (210) AM 94829
- (220) 2017 10 31
- (731) ებოტ ლაბორატორის
 100 ებოტ პარკ როუდი, ილინოისი, ებოტ პარკი, 60064, აშშ
- (740) თამარ კოჭლამაზაშვილი
- (540)

Малоежка

- (591) შავ-თეთრი
- (511)
- 5 – საკვები ნარევეები ბავშვებისათვის; დიეტური ნივთიერებები სამედიცინო მიზნებისათვის; ბავშვთა კვება; ბავშვთა კვებისათვის განკუთვნილი მშრალი რძე.
- 29 – რძე და რძის ნაწარმი; მშრალი რძე და რძის საფუძველზე დამზადებული სასმელები.

- (260) AM 2018 94830 A
- (210) AM 94830
- (220) 2017 10 31
- (731) ებოტ ლაბორატორის
 100 ებოტ პარკ როუდი, ილინოისი, ებოტ პარკი, 60064, აშშ
- (740) თამარ კოჭლამაზაშვილი
- (540)

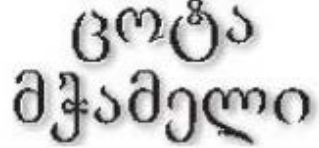

(591) შავ-თეთრი
(511)
5 – საკვები ნარევი ბავშვებისათვის; დიეტური ნივთიერებები სამედიცინო მიზნებისათვის; ბავშვთა კვება; ბავშვთა კვებისათვის განკუთვნილი მშრალი რძე.
29 – რძე და რძის ნაწარმი; მშრალი რძე და რძის საფუძველზე დამზადებული სასმელები.

(260) AM 2018 94976 A
(210) AM 94976
(220) 2017 11 07
(731) შპს „გლობალფარმი“
აღმასიანის ქ. 13ა/ ბერბუთის ქ. 8, 0171,
თბილისი, საქართველო
(540)

ველ ჰაუს
ВЕЛl ХOУC
WELL HOUSE

(591) შავ-თეთრი
(511)
35 – რეკლამა, მართვა საქმიან სფეროში, აღმინისტრირება საქმიან სფეროში, სოფისე სამსახური.
37 – მშენებლობა, რემონტი, დანადგარების დაკვება.

(260) AM 2018 95069 A
(210) AM 95069
(220) 2017 11 15
(731) სს „გეფა“
სანაპიროს ქ. 6, 0108, თბილისი,
საქართველო
(740) სალომე ჯვალაძე
(540)

Ovunit
ოვუნიტი
ОВУНИТ

(511)
5 – ფარმაცევტული და ვეტერინარული პრეპარატები; სანიტარული პრეპარატები სამედიცინო მიზნებისათვის; დიეტური ნივთიერებები სამედიცინო მიზნებისათვის, ბავშვთა კვება; სალბუნები, გადასახვევი საშუალებები; კბილის დასაბუნჯი საშუალებები, კბილის ტვიფრის დასამზადებელი საშუალებები; დეზინფექტანტები; მავნე ცხოველების გასანადგურებელი საშუალებები; ფუნგიციდები, პერბიციდები.

(260) AM 2018 95070 A
(210) AM 95070
(220) 2017 11 15
(731) სს „გეფა“
სანაპიროს ქ. 6, 0108, თბილისი,
საქართველო
(740) სალომე ჯვალაძე
(540)

Nevroxine Forte
ნევროქსინ ფორტე
Невроксин Форте

(511)
5 – ფარმაცევტული და ვეტერინარული პრეპარატები; სანიტარული პრეპარატები სამედიცინო მიზნებისათვის; დიეტური ნივთიერებები სამედიცინო მიზნებისათვის, ბავშვთა კვება; სალბუნები, გადასახვევი საშუალებები; კბილის დასაბუნჯი საშუალებები, კბილის ტვიფრის დასამზადებელი საშუალებები; დეზინფექტანტები; მავნე ცხოველების გასანადგურებელი საშუალებები; ფუნგიციდები, პერბიციდები.

(260) AM 2018 95071 A
(210) AM 95071
(220) 2017 11 15
(731) სს „გეფა“
სანაპიროს ქ. 6, 0108, თბილისი,
საქართველო
(740) სალომე ჯვალაძე
(540)

Nevroxine
ნევროქსინი
Невроксин

(511)
5 – ფარმაცევტული და ვეტერინარული პრეპარატები; სანიტარული პრეპარატები სამედიცინო მიზნებისათვის; დიეტური ნივთიერებები სამედიცინო მიზნებისათვის, ბავშვთა კვება; სალბუნები, გადასახვევი საშუალებები; კბილის დასაბუნჯი საშუალებები, კბილის ტვიფრის დასამზადებელი საშუალებები; დეზინფექტანტები; მავნე ცხოველების გასანადგურებელი საშუალებები; ფუნგიციდები, პერბიციდები.

(260) AM 2018 95120 A
(210) AM 95120
(220) 2017 11 17
(731) სილქ როუდ გრუპ ეს. ეი
აკარა ბილდინგი 24 დეკასტრო სთრ.,
ტორტოლა, ვირჯინის კუნძულები
(ბრიტანეთის)

(740) ნინო ხელაძე
(540)

სილქ როუდ სი თაუერ Silk Road Sea Tower Силк Роуд Си Тауер

(591) შავ-თეთრი
(511)

35 – რეკლამა; მართვა საქმიან სფეროში; ადმინისტრირება საქმიან სფეროში; საოფისე სამსახური.

36 – დაზღვევა; ფინანსებთან დაკავშირებული საქმიანობა; ფულად-საკრედიტო ოპერაციები; უძრავ ქონებასთან დაკავშირებული ოპერაციები.

37 – მშენებლობა; რემონტი; დანადგარების დაყენება.

39 – ტრანსპორტირება; საქონლის შეფუთვა და შენახვა; მოგზაურობის ორგანიზება.

41 – აღზრდა; სასწავლო პროცესის უზრუნველყოფა; გართობა; სპორტული და კულტურულ-საგანმანათლებლო ღონისძიებების ორგანიზება.

43 – საკვები პროდუქტებითა და სასმელებით უზრუნველყოფა; დროებითი საცხოვრებელი უზრუნველყოფა.

44 – სამედიცინო მომსახურება; ვეტერინარული მომსახურება; მომსახურება ცხოველებისა და ადამიანების ჰიგიენისა და კოსმეტიკის სფეროში; მომსახურება სოფლის მეურნეობის, მებაღეობისა და მეტყვეობის სფეროში.

(260) AM 2018 95121 A
(210) AM 95121
(220) 2017 11 17

(731) სილქ როუდ გრუპ ეს. ეი
აკარა ბილდინგი 24 დეკასტრო სთრ.,
ტორტოლა, ვირჯინის კუნძულები
(ბრიტანეთის)

(740) ნინო ხელაძე
(540)

სილქ ბლექ სე თაუერ Silk Black Sea Tower Силк Блек Си Тауер

(511)

35 – რეკლამა; მართვა საქმიან სფეროში; ადმინისტრირება საქმიან სფეროში; საოფისე სამსახური.

36 – დაზღვევა; ფინანსებთან დაკავშირებული საქმიანობა; ფულად-საკრედიტო ოპერაციები; უძრავ ქონებასთან დაკავშირებული ოპერაციები.

37 – მშენებლობა; რემონტი; დანადგარების დაყენება.

39 – ტრანსპორტირება; საქონლის შეფუთვა და შენახვა; მოგზაურობის ორგანიზება.

41 – აღზრდა; სასწავლო პროცესის უზრუნველყოფა; გართობა; სპორტული და კულტურულ-საგანმანათლებლო ღონისძიებების ორგანიზება.

43 – საკვები პროდუქტებითა და სასმელებით უზრუნველყოფა; დროებითი საცხოვრებელი უზრუნველყოფა.

44 – სამედიცინო მომსახურება; ვეტერინარული მომსახურება; მომსახურება ცხოველებისა და ადამიანების ჰიგიენისა და კოსმეტიკის სფეროში; მომსახურება სოფლის მეურნეობის, მებაღეობისა და მეტყვეობის სფეროში.

(260) AM 2018 95122 A
(210) AM 95122
(220) 2017 11 17

(731) სილქ როუდ გრუპ ეს. ეი
აკარა ბილდინგი 24 დეკასტრო სთრ.,
ტორტოლა, ვირჯინის კუნძულები
(ბრიტანეთის)

(740) ნინო ხელაძე
(540)

სილქ სი თაუერ Silk Sea Tower Силк Си Тауер

(511)

35 – რეკლამა; მართვა საქმიან სფეროში; ადმინისტრირება საქმიან სფეროში; საოფისე სამსახური.

36 – დაზღვევა; ფინანსებთან დაკავშირებული საქმიანობა; ფულად-საკრედიტო ოპერაციები; უძრავ ქონებასთან დაკავშირებული ოპერაციები.

37 – მშენებლობა; რემონტი; დანადგარების დაყენება.

39 – ტრანსპორტირება; საქონლის შეფუთვა და შენახვა; მოგზაურობის ორგანიზება.

41 – აღზრდა; სასწავლო პროცესის უზრუნველყოფა; გართობა; სპორტული და კულტურულ-საგანმანათლებლო ღონისძიებების ორგანიზება.

43 – საკვები პროდუქტებითა და სასმელებით უზრუნველყოფა; დროებითი საცხოვრებელი უზრუნველყოფა.

44 – სამედიცინო მომსახურება; ვეტერინარული მომსახურება; მომსახურება ცხოველებისა და ადამიანების ჰიგიენისა და კოსმეტიკის სფეროში; მომსახურება სოფლის მეურნეობის, მებაღეობისა და მეტყვევობის სფეროში.

(260) AM 2018 95123 A

(210) AM 95123

(220) 2017 11 17

(731) სილქ როუდ გრუპ ეს. ეი
აკარა ბილდინგი 24 დეკასტრო სთრ.,
ტორტოლა, ვირჯინის კუნძულები
(ბრიტანეთის)

(740) ნინო ხელაძე

(540)

სილქ თაუერ
Silk Tower
Силк Тауер

(511)

35 – რეკლამა; მართვა საქმიან სფეროში; ადმინისტრირება საქმიან სფეროში; საოფისე სამსახური.

36 – დაზღვევა; ფინანსებთან დაკავშირებული საქმიანობა; ფულად-საკრედიტო ოპერაციები; უძრავ ქონებასთან დაკავშირებული ოპერაციები.

37 – მშენებლობა; რემონტი; დანადგარების დაყენება.

39 – ტრანსპორტირება; საქონლის შეფუთვა და შენახვა; მოგზაურობის ორგანიზება.

41 – აღზრდა; სასწავლო პროცესის უზრუნველყოფა; გართობა; სპორტული და კულტურულ-საგანმანათლებლო ღონისძიებების ორგანიზება.

43 – საკვები პროდუქტებითა და სასმელებით უზრუნველყოფა; დროებითი საცხოვრებელი უზრუნველყოფა.

44 – სამედიცინო მომსახურება; ვეტერინარული მომსახურება; მომსახურება ცხოველებისა და ადამიანების ჰიგიენისა და კოსმეტიკის სფეროში; მომსახურება სოფლის მეურნეობის, მებაღეობისა და მეტყვევობის სფეროში.

(260) AM 2018 95124 A

(210) AM 95124

(220) 2017 11 17

(731) სილქ როუდ გრუპ ეს. ეი
აკარა ბილდინგი 24 დეკასტრო სთრ.,
ტორტოლა, ვირჯინის კუნძულები
(ბრიტანეთის)

(740) ნინო ხელაძე

(540)

სილქ როუდ თაუერ
Silk Road Tower
Силк Роуд Тауер

(511)

35 – რეკლამა; მართვა საქმიან სფეროში; ადმინისტრირება საქმიან სფეროში; საოფისე სამსახური.

36 – დაზღვევა; ფინანსებთან დაკავშირებული საქმიანობა; ფულად-საკრედიტო ოპერაციები; უძრავ ქონებასთან დაკავშირებული ოპერაციები.

37 – მშენებლობა; რემონტი; დანადგარების დაყენება.

39 – ტრანსპორტირება; საქონლის შეფუთვა და შენახვა; მოგზაურობის ორგანიზება.

41 – აღზრდა; სასწავლო პროცესის უზრუნველყოფა; გართობა; სპორტული და კულტურულ-საგანმანათლებლო ღონისძიებების ორგანიზება.

43 – საკვები პროდუქტებითა და სასმელებით უზრუნველყოფა; დროებითი საცხოვრებელი უზრუნველყოფა.

44 – სამედიცინო მომსახურება; ვეტერინარული მომსახურება; მომსახურება ცხოველებისა და ადამიანების ჰიგიენისა და კოსმეტიკის სფეროში; მომსახურება სოფლის მეურნეობის, მებაღეობისა და მეტყვევობის სფეროში.

(260) AM 2018 95125 A

(210) AM 95125

(220) 2017 11 17

(731) სილქ როუდ გრუპ ეს. ეი
აკარა ბილდინგი 24 დეკასტრო სთრ.,
ტორტოლა, ვირჯინის კუნძულები
(ბრიტანეთის)

(740) ნინო ხელაძე

(540)

სილქ როუდ სანი თაუერ
Silk Road Sunny Tower
Силк Роуд Сани Тауер

(511)

35 – რეკლამა; მართვა საქმიან სფეროში; ადმინისტრირება საქმიან სფეროში; საოფისე სამსახური.

36 – დაზღვევა; ფინანსებთან დაკავშირებული საქმიანობა; ფულად-საკრედიტო ოპერაციები; უძრავ ქონებასთან დაკავშირებული ოპერაციები.

37 – მშენებლობა; რემონტი; დანადგარების დაყენება.

39 – ტრანსპორტირება; საქონლის შეფუთვა და შენახვა; მოგზაურობის ორგანიზება.

41 – აღზრდა; სასწავლო პროცესის უზრუნველყოფა; გართობა; სპორტული და კულტურულ-საგანმანათლებლო ღონისძიებების ორგანიზება.

43 – საკვები პროდუქტებითა და სასმელებით უზრუნველყოფა; დროებითი საცხოვრებელი უზრუნველყოფა.

44 – სამედიცინო მომსახურება; ვეტერინარული მომსახურება; მომსახურება ცხოველებისა და ადამიანების ჰიგიენისა და კოსმეტიკის სფეროში; მომსახურება სოფლის მეურნეობის, მებაღეობისა და მეტყვეობის სფეროში.

(260) AM 2018 95126 A

(210) AM 95126

(220) 2017 11 17

(731) სილქ როუდ გრუპ ეს. ეი

აკარა ბილდინგი 24 დეკასტრო სთრ.,
ტორტოლა, ვირჯინის კუნძულები
(ბრიტანეთის)

(740) ნინო ხელაძე

(540)

სილქ როუდ ფერლ თაუერ

Silk Road Pearl Tower

Силк Роуд Перл Тауер

(511)

35 – რეკლამა; მართვა საქმიან სფეროში; ადმინისტრირება საქმიან სფეროში; საოფისე სამსახური.

36 – დაზღვევა; ფინანსებთან დაკავშირებული საქმიანობა; ფულად-საკრედიტო ოპერაციები; უძრავ ქონებასთან დაკავშირებული ოპერაციები.

37 – მშენებლობა; რემონტი; დანადგარების დაყენება.

39 – ტრანსპორტირება; საქონლის შეფუთვა და შენახვა; მოგზაურობის ორგანიზება.

41 – აღზრდა; სასწავლო პროცესის უზრუნველყოფა; გართობა; სპორტული და კულტურულ-საგანმანათლებლო ღონისძიებების ორგანიზება.

43 – საკვები პროდუქტებითა და სასმელებით უზრუნველყოფა; დროებითი საცხოვრებელი უზრუნველყოფა.

44 – სამედიცინო მომსახურება; ვეტერინარული მომსახურება; მომსახურება ცხოველებისა და ადამიანების ჰიგიენისა და კოსმეტიკის სფეროში; მომსახურება სოფლის მეურნეობის, მებაღეობისა და მეტყვეობის სფეროში.

(260) AM 2018 95127 A

(210) AM 95127

(220) 2017 11 17

(731) სილქ როუდ გრუპ ეს. ეი

აკარა ბილდინგი 24 დეკასტრო სთრ.,
ტორტოლა, ვირჯინის კუნძულები
(ბრიტანეთის)

(740) ნინო ხელაძე

(540)

სილქ ფერლ თაუერ

Silk Pearl Tower

Силк Перл Тауер

(511)

35 – რეკლამა; მართვა საქმიან სფეროში; ადმინისტრირება საქმიან სფეროში; საოფისე სამსახური.

36 – დაზღვევა; ფინანსებთან დაკავშირებული საქმიანობა; ფულად-საკრედიტო ოპერაციები; უძრავ ქონებასთან დაკავშირებული ოპერაციები.

37 – მშენებლობა; რემონტი; დანადგარების დაყენება.

39 – ტრანსპორტირება; საქონლის შეფუთვა და შენახვა; მოგზაურობის ორგანიზება.

41 – აღზრდა; სასწავლო პროცესის უზრუნველყოფა; გართობა; სპორტული და კულტურულ-საგანმანათლებლო ღონისძიებების ორგანიზება.

43 – საკვები პროდუქტებითა და სასმელებით უზრუნველყოფა; დროებითი საცხოვრებელი უზრუნველყოფა.

44 – სამედიცინო მომსახურება; ვეტერინარული მომსახურება; მომსახურება ცხოველებისა და ადამიანების ჰიგიენისა და კოსმეტიკის სფეროში; მომსახურება სოფლის მეურნეობის, მებაღეობისა და მეტყვეობის სფეროში.

(260) AM 2018 95128 A

(210) AM 95128

(220) 2017 11 17

(731) სილქ როუდ გრუპ ეს. ეი

აკარა ბილდინგი 24 დეკასტრო სთრ.,
ტორტოლა, ვირჯინის კუნძულები
(ბრიტანეთის)

(740) ნინო ხელაძე

(540)

სილქ როუდ ბლექ სი თაუერ
Silk Road Black Sea Tower
Силк Роуд Блек Си Тауер

(511)

35 – რეკლამა; მართვა საქმიან სფეროში; ადმინისტრირება საქმიან სფეროში; საოფისე სამსახური.

36 – დაზღვევა; ფინანსებთან დაკავშირებული საქმიანობა; ფულად-საკრედიტო ოპერაციები; უძრავ ქონებასთან დაკავშირებული ოპერაციები.

37 – მშენებლობა; რემონტი; დანადგარების დაყენება.

39 – ტრანსპორტირება; საქონლის შეფუთვა და შენახვა; მოგზაურობის ორგანიზება.

41 – აღზრდა; სასწავლო პროცესის უზრუნველყოფა; გართობა; სპორტული და კულტურულ-საგანმანათლებლო ღონისძიებების ორგანიზება.

43 – საკვები პროდუქტებითა და სასმელებით უზრუნველყოფა; დროებითი საცხოვრებელი უზრუნველყოფა.

44 – სამედიცინო მომსახურება; ვეტერინარული მომსახურება; მომსახურება ცხოველებისა და ადამიანების ჰიგიენისა და კოსმეტიკის სფეროში; მომსახურება სოფლის მეურნეობის, მებაღეობისა და მეტყვეობის სფეროში.

(260) AM 2018 95129 A

(210) AM 95129

(220) 2017 11 17

(731) სილქ როუდ გრუპ ეს.

ეი აკარა ბილდინგი 24 დეკასტრო სთრ.,
 ტორტოლა, ვირჯინის კუნძულები (ბრიტანეთის)

(740) ნინო ხელაძე

(540)

სილქ სანი თაუერ
Silk Sunny Tower
Силк Сани Тауер

(511)

35 – რეკლამა; მართვა საქმიან სფეროში; ადმინისტრირება საქმიან სფეროში; საოფისე სამსახური.

36 – დაზღვევა; ფინანსებთან დაკავშირებული საქმიანობა; ფულად-საკრედიტო ოპერაციები; უძრავ ქონებასთან დაკავშირებული ოპერაციები.

37 – მშენებლობა; რემონტი; დანადგარების დაყენება.

39 – ტრანსპორტირება; საქონლის შეფუთვა და შენახვა; მოგზაურობის ორგანიზება.

41 – აღზრდა; სასწავლო პროცესის უზრუნველყოფა; გართობა; სპორტული და კულტურულ-საგანმანათლებლო ღონისძიებების ორგანიზება.

43 – საკვები პროდუქტებითა და სასმელებით უზრუნველყოფა; დროებითი საცხოვრებელი უზრუნველყოფა.

44 – სამედიცინო მომსახურება; ვეტერინარული მომსახურება; მომსახურება ცხოველებისა და ადამიანების ჰიგიენისა და კოსმეტიკის სფეროში; მომსახურება სოფლის მეურნეობის, მებაღეობისა და მეტყვეობის სფეროში.

(260) AM 2018 95182 A

(210) AM 95182

(220) 2017 11 22

(731) შპს „ჯეოსელი“

გოთუას ქ. 3, მტკვრის მარჯვენა
 სანაპირო, 0163, თბილისი, საქართველო

(740) მარიამ ღუბიანური

(540)



(591) იასამნისფერი, წითელი

(531) 26.11.03; 26.11.06; 26.11.07; 27.05.01; 27.05.17; 29.01.05

(511)

16 – ქაღალდი, მუყაო და მათი ნაკეთობა, რომელიც არ მიეკუთვნება სხვა კლასებს; ნაბეჭდი პროდუქცია; მასალები საამკინძაო სამუშაოებისათვის; ფოტოსურათები; საწერ-ქაღალდის საქონელი; საკანცელარიო და საყოფაცხოვრებო დანიშნულების მწებავი ნივთიერებები; მხატვართა საკუთნო; ფუნჯები; საბეჭდი მანქანები და ოფისის საკუთნო (ავეჯის გარდა); სასწავლო მასალა და თვალსაჩინოება (ხელსაწყოების გარდა); პლასტმასის შესაფუთი მასალა (რომელიც არ მიეკუთვნება სხვა კლასებს); შრიფტი; ტიპოგრაფიული კლიშე.

36 – დაზღვევა; ფინანსებთან დაკავშირებული საქმიანობა; ფულად-საკრედიტო ოპერაციები; უძრავ ქონებასთან დაკავშირებული ოპერაციები.

38 – კავშირგაბმულობა.

(260) AM 2018 95224 A

(210) AM 95224

(220) 2017 11 29

- (310) 56621/2017
- (320) 2017 05 31
- (330) CH
- (731) ფილიპ მორის ბრენდზ სარლ
კე უანრენო 3 , ნევშატელი, 2000, შვეიცარია
- (740) შალვა გვარამაძე
- (540)

CRUISE

(511)
34 – დამუშავებული ან დაუმუშავებელი თამბაქო; თამბაქოს პროდუქტები; სიგარები, სიგარეტები, სიგარილოები, საკუთარ სიგარეტში გასახვევი თამბაქო, ჩიბუხის თამბაქო, საღებავი თამბაქო, საბურნუთე თამბაქო, კრეტეკი; თამბაქო „სნუსი“; თამბაქოს შემცველები (არასამედიცინო დანიშნულების); ელექტრონული სიგარეტები; თამბაქოს პროდუქტები, მისი შემდგომი გათბობის მიზნით; ელექტრონული მოწყობილობები და მათი ნაწილები სიგარეტების ან თამბაქოს გასათბობად ინჰალაციისათვის ნიკოტინის შემცველი აეროზოლის გამოყოფის მიზნით; თხევადი ნიკოტინის ხსნარები ელექტრონულ სიგარეტებში გამოყენებისთვის; მწველთა საკუთვნობი, სიგარეტის ქაღალდი, სიგარეტის მილაკები (მუნდშტუკები), სიგარეტის ფილტრები, თამბაქოს ქილები, სიგარეტის კოლოფები, საფერფლები, ჩიბუხები, სიგარეტის გადასახვევი ჯიბის მოწყობილობები, სანთებლები, ასანთები.

- (260) AM 2018 95306 A
- (210) AM 95306
- (220) 2017 11 30
- (731) დინ & დელუკა ბრენდს, ინკ.
დელავერის კორპორაცია
2402 ისტ 37-ე სტრიტ ნორთ, კანზასი,
უიჩიტა, 67219, აშშ
- (740) თამარ კოჭლამაზაშვილი
- (540)

DEAN & DELUCA

(591) შავ-თეთრი
(511)
29 – დაკონსერვებული ზეთისხილი; ზეთისხილის პასტა; ზეთისხილის ზეთი; დაკონსერვებული ხილი; დაკონსერვებული წაბლი; დაკონსერვებული პომიდორი; წასასმელი კაკლის პასტა; კაკლის ზეთი; მარინადში ჩადებული კორნიშონები; დაკონსერვებული თირკმელა სოკო; დაკონსერვებული სოკო; გამომშრალი სოკო; ხილის ჯემები; ყველა სახის დაკეპილი პროდუქტი; მათ შორის, ხორცის ყოველგვარი ნაირსახეობების ფარში; გამომშრალი პარკოსნები; ხიზილალა; შებოლილი თევზი; ყველი; გამომშრალი ხილი; გამომშრალი კაკალი; შებოლილი ძეხვეული; საქონლის ხორცი შემწვარი; ქათ-

მის ღვიძლის მუსი; იხვის ხორცის მუსი; ღვიძლის პაშტეტი; იხვის ღვიძლი; ძეხვეული; ქათმის მკერდი შებოლილი; ინდაურის მკერდი შებოლილი; პეკინური იხვის მკერდი შებოლილი; სირაქლემას ხორცი; მწვერის ხორცი; ხოხბის ხორცი; კამეჩის ხორცის ბურგერები; ხბოს ხორცის სოსისი; ღორის ხორცის შესაწვავი სოსისი; სარდელი; ვენური სოსისი; შინაური ფრინველის ხორცი; ხორცეული; თევზეული; ზღვის პროდუქტები; ყველანაირი კაკლის კარაქი; ზეთი, საკვები კარაქი, მარგარინი, კულინარიული ცხიმები; ბოსტნეულის საღებავი; წვნიანები; ბულიონები და სქელი შეჭამანდები; ბოსტნეული, ნედლად დაჭრილი, ბოთლში ან ქილაში შენახული, დაკონსერვებული, გამომშრალი, გაყინული; ქილაში დაკონსერვებული ხილი; ქილაში დაკონსერვებული ხორცი; დაკონსერვებული ლობიო; დაკონსერვებული ოსპი; ხორცის ცივი საუზმეული; რძის პროდუქტები, მათ შორის, კარაქი, ნაღები, იოგურტი; კვერცხი; საკვები ცხიმები, ტოფუ, ბატის ღვიძლის პაშტეტი; კარტოფილის ჩიფსი; დამუშავებული კაკალი.

30 – ბრინჯი, პასტა (მაკარონის ნაწარმი); გამომშრალი და დაკონსერვებული მწვანილი; სუნელები; მოხალული ყავის მარცვლები; დაფქვილი ყავა; ჩაი; მდოგვი; ძმარი; თაფლი; ხილის სიროფი, რომელიც გამოიყენება საკვების მოსართავად ან საკვები არომატიზატორის სახით, ფხვიერი ნამცხვარი, საკონდიტრო ნაწარმი, ბისკვიტები, შოკოლადის სოუსი; ქლიავის პუდინგი; სოუსები მაკარონის ნაწარმისათვის; კაკაო; შოკოლადის კანფეტები; მდოგვი; სალსას სოუსი; სოუსები; სიმინდი; სოუსი „ვორჩესტერი“; კეტჩუპი; სოიოს სოუსი; სალათის საკაზმები; მაიონეზი; შაქარი; სუფრის მარილი; დაფქვილი სეზამის მარცვალი; სენდვიჩები; პიცა; საკონდიტრო ნაწარმი და პურ-ფუნთუშეული; სწრაფი მომზადების ნამცხვრები და სადესერტე ნარევები; სწრაფი მომზადების ნაყინის და შერბეთის ნარევები; ნუშის პასტა; საფუარი; საცხობი ფხვნილები; პური; მარცვლეული; ფქვილი; შაქარი; სალათები, კერძოდ, მაკარონის, ბრინჯის და პასტის შემცველი სალათები; შოკოლადის, ყავის, ჩაის და კაკოს საფუძველზე დამზადებული სასმელები. კრეკერები; გვირილაზე დამზადებული სასმელები; მაჭკატები; კაპარი; დამუშავებული მარცვლეული, საწებლები; სუში.

43 – ვაფების და რესტორნების მომსახურება.

რეგისტრირებული სასაქონლო ნიშნები

(111) M 2018 29771 R
(151) 2018 06 20
(181) 2028 06 20
(260) AM 2016 89279 A
(220) 2016 11 03
(732) ზაქრიტოე აკციონერნოე ობშესტვო
„კანონფარმა პროდაკშნ“
ულ. ზარეჩნაია 105, 141100, შელკოვო
მ.ო., მოსკოვი, რუსეთის ფედერაცია

(111) M 2018 29772 R
(151) 2018 06 20
(181) 2028 06 20
(260) AM 2016 89285 A
(220) 2016 11 03
(732) ზაქრიტოე აკციონერნოე ობშესტვო
„კანონფარმა პროდაკშნ“
ულ. ზარეჩნაია 105, 141100, შელკოვო
მ.ო., მოსკოვი, რუსეთის ფედერაცია

(111) M 2018 29773 R
(151) 2018 06 20
(181) 2028 06 20
(260) AM 2016 89288 A
(220) 2016 11 03
(732) ზაქრიტოე აკციონერნოე ობშესტვო
„კანონფარმა პროდაკშნ“
ულ. ზარეჩნაია 105, 141100, შელკოვო
მ.ო., მოსკოვი, რუსეთის ფედერაცია

(111) M 2018 29774 R
(151) 2018 06 20
(181) 2028 06 20
(260) AM 2017 90306 A
(220) 2017 01 06
(732) შპს „ლაბორატორია კოლხიკა“
სანაპიროს ქ. 10, თბილისი, საქართველო

(111) M 2018 29775 R
(151) 2018 06 20
(181) 2028 06 20
(260) AM 2017 90391 A
(220) 2017 01 11
(732) შპს „თაშრე“
ა. ბელიაშვილის ქ. 88, 0159, თბილისი,
საქართველო

(111) M 2018 29776 R
(151) 2018 06 20
(181) 2028 06 20
(260) AM 2017 91531 A
(220) 2017 03 31
(732) გრემ სპულკა ზ ოგრანიჩონონ ოდპოვედ-
ზიალნოსცენ სპულკა კომანდიტოვა
მაიდან 88 D, 05-462 ვენზოვნა, პოლონეთი

(111) M 2018 29777 R
(151) 2018 06 20
(181) 2028 06 20
(260) AM 2017 91737 A
(220) 2017 04 18
(732) თენგიზ აბესაძე
მ. დვალისშვილის ქ. 15, 4600, ქუთაისი,
საქართველო

(111) M 2018 29778 R
(151) 2018 06 20
(181) 2028 06 20
(260) AM 2017 91783 A
(220) 2017 04 20
(732) ბლუ პროდაქტს ინკ.
10814 ნორზეესტ 33-ე სტრიტ 100,
დორალი, ფლორიდა 33172, აშშ

(111) M 2018 29779 R
(151) 2018 06 20
(181) 2028 06 20
(260) AM 2017 91857 A
(220) 2017 04 26
(732) შპს „ვოლი“
სოფ. წინუბანი, 0901, დიდი ლილო,
საქართველო

(111) M 2018 29780 R
(151) 2018 06 20
(181) 2028 06 20
(260) AM 2017 91858 A
(220) 2017 04 26
(732) შპს „ვოლი“
(732) შპს „ვოლი“
სოფ. წინუბანი, 0901, დიდი ლილო,
საქართველო

(111) M 2018 29781 R
 (151) 2018 06 20
 (181) 2028 06 20
 (260) AM 2017 91860 A
 (220)
 (732) შპს „ვოლი“
 სოფ. წინუბანი, 0901, დიდი ლილო,
 საქართველო

(111) M 2018 29787 R
 (151) 2018 06 20
 (181) 2028 06 20
 (260) AM 2017 92141 A
 (220) 2017 05 16
 (732) შპს „ვოლი“
 სოფ. წინუბანი, 0901, დიდი ლილო,
 საქართველო

(111) M 2018 29782 R
 (151) 2018 06 20
 (181) 2028 06 20
 (260) AM 2017 91861 A
 (220) 2017 04 26
 (732) შპს „ვოლი“
 სოფ. წინუბანი, 0901, დიდი ლილო,
 საქართველო

(111) M 2018 29788 R
 (151) 2018 06 20
 (181) 2028 06 20
 (260) AM 2017 92143 A
 (220) 2017 05 16
 (732) შპს „ვოლი“
 სოფ. წინუბანი, 0901, დიდი ლილო,
 საქართველო

(111) M 2018 29783 R
 (151) 2018 06 20
 (181) 2028 06 20
 (260) AM 2017 91889 A
 (220) 2017 05 02
 (732) სს „თბილღვინო“
 სარაჯიშვილის გამზ. 2, 0153, თბილისი,
 საქართველო

(111) M 2018 29789 R
 (151) 2018 06 20
 (181) 2028 06 20
 (260) AM 2017 92182 A
 (220) 2017 05 17
 (732) სს „მ² უძრავი ქონება“
 ი. ჭავჭავაძის გამზ. 29, სართ. 3,
 თბილისი, საქართველო

(111) M 2018 29784 R
 (151) 2018 06 20
 (181) 2028 06 20
 (260) AM 2017 92103 A
 (220) 2017 05 12
 (732) მაილან კონსიუმერ ჰელსკეა, ინკ.
 781 ჩენსნატ რიჯ როუდი, EOB 245,
 მორგანტაუნი, WV 26505, აშშ

(111) M 2018 29790 R
 (151) 2018 06 20
 (181) 2028 06 20
 (260) AM 2017 92193 A
 (220) 2017 07 27
 (732) შპს „იბერკომპანი“
 ალ. ყაზბეგის გამზ. 12ა, 0160, თბილისი,
 საქართველო

(111) M 2018 29785 R
 (151) 2018 06 20
 (181) 2028 06 20
 (260) AM 2017 92112 A
 (220) 2017 05 15
 (732) შპს „სასწავლო უნივერსიტეტი გეომედი“
 მეფე სოლომონ II-ის ქ. 4, 0114, თბილისი,
 საქართველო

(111) M 2018 29791 R
 (151) 2018 06 20
 (181) 2028 06 20
 (260) AM 2017 92194 A
 (220) 2017 07 27
 (732) შპს „იბერკომპანი“
 ალ. ყაზბეგის გამზ. 12ა, 0160, თბილისი,
 საქართველო

(111) M 2018 29786 R
 (151) 2018 06 20
 (181) 2028 06 20
 (260) AM 2017 92126 A
 (220) 2017 05 15
 (732) სს „მ² უძრავი ქონება“
 ი. ჭავჭავაძის გამზ. 29, სართ. 3,
 თბილისი, საქართველო

(111) M 2018 29792 R
 (151) 2018 06 20
 (181) 2028 06 20
 (260) AM 2017 92202 A
 (220) 2017 05 18
 (732) ანესტას ელ მური
 ელ მურ რეზიდენს - პარკ ელ დეირი,
 კვარჩიმა - ბაბდა, ლიბანი

(111) M 2018 29793 R
 (151) 2018 06 20
 (181) 2028 06 20
 (260) AM 2017 92226 A
 (220) 2017 05 19
 (732) გიორგი ბეგიზაშვილი
 ქველიძის ქ. 32, 0102, თბილისი,
 საქართველო

(111) M 2018 29794 R
 (151) 2018 06 20
 (181) 2028 06 20
 (260) AM 2017 92340 A
 (220) 2017 05 24
 (732) საქართველოში INPHA LLP-ის
 წარმომადგენლობითი ოფისი
 ბესიკის ქ. 4-ის მიმდებარედ (ნაკვეთი
 46/10), 0108, თბილისი, საქართველო

(111) M 2018 29795 R
 (151) 2018 06 20
 (181) 2028 06 20
 (260) AM 2017 92341 A
 (220) 2017 05 24
 (732) საქართველოში INPHA LLP-ის
 წარმომადგენლობითი ოფისი
 ბესიკის ქ. 4-ის მიმდებარედ (ნაკვეთი
 46/10), 0108, თბილისი, საქართველო

(111) M 2018 29796 R
 (151) 2018 06 20
 (181) 2028 06 20
 (260) AM 2017 92365 A
 (220) 2017 05 25
 (732) საქართველოში INPHA LLP-ის
 წარმომადგენლობითი ოფისი
 ბესიკის ქ. 4-ის მიმდებარედ (ნაკვეთი
 46/10), 0108, თბილისი, საქართველო

(111) M 2018 29797 R
 (151) 2018 06 20
 (181) 2028 06 20
 (260) AM 2017 92367 A
 (220) 2017 05 25
 (732) საქართველოში INPHA LLP-ის
 წარმომადგენლობითი ოფისი
 ბესიკის ქ. 4-ის მიმდებარედ (ნაკვეთი
 46/10), 0108, თბილისი, საქართველო

(111) M 2018 29798 R
 (151) 2018 06 20
 (181) 2028 06 20

(260) AM 2017 92368 A
 (220) 2017 05 25
 (732) საქართველოში INPHA LLP-ის
 წარმომადგენლობითი ოფისი
 ბესიკის ქ. 4-ის მიმდებარედ (ნაკვეთი
 46/10), 0108, თბილისი, საქართველო

(111) M 2018 29799 R
 (151) 2018 06 20
 (181) 2028 06 20
 (260) AM 2017 92376 A
 (220) 2017 05 25
 (732) საქართველოში INPHA LLP-ის
 წარმომადგენლობითი ოფისი
 ბესიკის ქ. 4-ის მიმდებარედ (ნაკვეთი
 46/10), 0108, თბილისი, საქართველო

(111) M 2018 29800 R
 (151) 2018 06 20
 (181) 2028 06 20
 (260) AM 2017 92377 A
 (220) 2017 05 25
 (732) საქართველოში INPHA LLP-ის
 წარმომადგენლობითი ოფისი
 ბესიკის ქ. 4-ის მიმდებარედ (ნაკვეთი
 46/10), 0108, თბილისი, საქართველო

(111) M 2018 29801 R
 (151) 2018 06 20
 (181) 2028 06 20
 (260) AM 2017 92378 A
 (220) 2017 05 25
 (732) საქართველოში INPHA LLP-ის
 წარმომადგენლობითი ოფისი
 ბესიკის ქ. 4-ის მიმდებარედ (ნაკვეთი
 46/10), 0108, თბილისი, საქართველო

(111) M 2018 29802 R
 (151) 2018 06 20
 (181) 2028 06 20
 (260) AM 2017 92385 A
 (220) 2017 05 25
 (732) საქართველოში INPHA LLP-ის
 წარმომადგენლობითი ოფისი
 ბესიკის ქ. 4-ის მიმდებარედ (ნაკვეთი
 46/10), 0108, თბილისი, საქართველო

(111) M 2018 29803 R
 (151) 2018 06 20
 (181) 2028 06 20
 (260) AM 2017 92536 A
 (220) 2017 06 05

(732) ჰანვა კორპორეიშნ
86 ჩხონგიეჩხონ-რო, ჩუნგ-გუ, სეული, კორეის რესპუბლიკა

ბესიკის ქ. 4-ის მიმდებარედ (ნაკვეთი 46/10), 0108, თბილისი, საქართველო

(111) M 2018 29804 R

(151) 2018 06 20

(181) 2028 06 20

(260) AM 2017 92541 A

(220) 2017 06 05

(732) პარინგტონ დეველოპმენტ ინკ.
ელვირა მენდესის სტრიტი, ვალარინო
ბლდგ, მე-3 სართ. პანამა, პანამის
რესპუბლიკა

(111) M 2018 29809 R

(151) 2018 06 20

(181) 2028 06 20

(260) AM 2017 92711 A

(220) 2017 06 09

(732) საქართველოში INPHA LLP-ის
წარმომადგენლობითი ოფისი
ბესიკის ქ. 4-ის მიმდებარედ (ნაკვეთი 46/10), 0108, თბილისი, საქართველო

(111) M 2018 29805 R

(151) 2018 06 20

(181) 2028 06 20

(260) AM 2017 92653 A

(220) 2017 06 08

(732) ე. ი. დიუ პონ დე ნემურ ენდ კომპანი
ჩესტნატ რან პლაზა, 974 სენტერ
როუდი, უილმინგტონი, დელავერის
შტატი 19805, აშშ

(111) M 2018 29810 R

(151) 2018 06 20

(181) 2028 06 20

(260) AM 2017 92713 A

(220) 2017 06 09

(732) საქართველოში INPHA LLP-ის
წარმომადგენლობითი ოფისი
ბესიკის ქ. 4-ის მიმდებარედ (ნაკვეთი 46/10), 0108, თბილისი, საქართველო

(111) M 2018 29806 R

(151) 2018 06 20

(181) 2028 06 20

(260) AM 2017 92654 A

(220) 2017 06 08

(732) ე. ი. დიუ პონ დე ნემურ ენდ კომპანი
ჩესტნატ რან პლაზა, 974 სენტერ
როუდი, უილმინგტონი, დელავერის
შტატი 19805, აშშ

(111) M 2018 29811 R

(151) 2018 06 20

(181) 2028 06 20

(260) AM 2017 92715 A

(220) 2017 06 09

(732) საქართველოში INPHA LLP-ის
წარმომადგენლობითი ოფისი
ბესიკის ქ. 4-ის მიმდებარედ (ნაკვეთი 46/10), 0108, თბილისი, საქართველო

(111) M 2018 29807 R

(151) 2018 06 20

(181) 2028 06 20

(260) AM 2017 92655 A

(220) 2017 06 08

(732) ე. ი. დიუ პონ დე ნემურ ენდ კომპანი
ჩესტნატ რან პლაზა, 974 სენტერ
როუდი, უილმინგტონი, დელავერის
შტატი 19805, აშშ

(111) M 2018 29812 R

(151) 2018 06 20

(181) 2028 06 20

(260) AM 2017 92716 A

(220) 2017 06 09

(732) საქართველოში INPHA LLP-ის
წარმომადგენლობითი ოფისი
ბესიკის ქ. 4-ის მიმდებარედ (ნაკვეთი 46/10), 0108, თბილისი, საქართველო

(111) M 2018 29808 R

(151) 2018 06 20

(181) 2028 06 20

(260) AM 2017 92708 A

(220) 2017 06 09

(732) საქართველოში INPHA LLP-ის
წარმომადგენლობითი ოფისი

(111) M 2018 29813 R

(151) 2018 06 20

(181) 2028 06 20

(260) AM 2017 92720 A

(220) 2017 06 09

(732) საქართველოში INPHA LLP-ის
წარმომადგენლობითი ოფისი

ბესიკის ქ. 4-ის მიმდებარედ (ნაკვეთი 46/10), 0108, თბილისი, საქართველო	(111) M 2018 29819 R (151) 2018 06 20 (181) 2028 06 20 (260) AM 2017 92921 A (220) 2017 06 23 (732) სს „ნოვა ტექნოლოჯი“ უზნადის ქ. 37, 0102, თბილისი, საქართველო
(111) M 2018 29814 R (151) 2018 06 20 (181) 2028 06 20 (260) AM 2017 92721 A (220) 2017 06 09 (732) საქართველოში INPHA LLP-ის წარმომადგენლობითი ოფისი ბესიკის ქ. 4-ის მიმდებარედ (ნაკვეთი 46/10), 0108, თბილისი, საქართველო	(111) M 2018 29820 R (151) 2018 06 20 (181) 2028 06 20 (260) AM 2017 92923 A (220) 2017 06 23 (732) სს „ნოვა ტექნოლოჯი“ უზნადის ქ. 37, 0102, თბილისი, საქართველო
(111) M 2018 29815 R (151) 2018 06 20 (181) 2028 06 20 (260) AM 2017 92725 A (220) 2017 06 09 (732) საქართველოში INPHA LLP-ის წარმომადგენლობითი ოფისი ბესიკის ქ. 4-ის მიმდებარედ (ნაკვეთი 46/10), 0108, თბილისი, საქართველო	(111) M 2018 29821 R (151) 2018 06 20 (181) 2028 06 20 (260) AM 2017 92924 A (220) 2017 06 23 (732) სს „ნოვა ტექნოლოჯი“ უზნადის ქ. 37, 0102, თბილისი, საქართველო
(111) M 2018 29816 R (151) 2018 06 20 (181) 2028 06 20 (260) AM 2017 92726 A (220) 2017 06 09 (732) საქართველოში INPHA LLP-ის წარმომადგენლობითი ოფისი ბესიკის ქ. 4-ის მიმდებარედ (ნაკვეთი 46/10), 0108, თბილისი, საქართველო	(111) M 2018 29822 R (151) 2018 06 20 (181) 2028 06 20 (260) AM 2017 92925 A (220) 2017 06 23 (732) სს „ნოვა ტექნოლოჯი“ უზნადის ქ. 37, 0102, თბილისი, საქართველო
(111) M 2018 29817 R (151) 2018 06 20 (181) 2028 06 20 (260) AM 2017 92731 A (220) 2017 06 09 (732) საქართველოში INPHA LLP-ის წარმომადგენლობითი ოფისი ბესიკის ქ. 4-ის მიმდებარედ (ნაკვეთი 46/10), 0108, თბილისი, საქართველო	(111) M 2018 29823 R (151) 2018 06 20 (181) 2028 06 20 (260) AM 2017 92926 A (220) 2017 06 23 (732) სს „ნოვა ტექნოლოჯი“ უზნადის ქ. 37, 0102, თბილისი, საქართველო
(111) M 2018 29818 R (151) 2018 06 20 (181) 2028 06 20 (260) AM 2017 92884 A (220) 2017 06 21 (732) ეფლ ინკ. 1, ინფინიტ ლუპი, კუპერტინო., კალიფორნია, 95014, აშშ	(111) M 2018 29824 R (151) 2018 06 20 (181) 2028 06 20 (260) AM 2017 92986 A (220) 2017 06 26 (732) ნაბროს ფარმა პეტ. ლტდ. ნაბროს ჰაუზი, 3რდ ფლორი, ბიპაინდ ბრიტიშ ლაიბრარი, ოპპ. არტ გელერი,

ლო გარდენი, ელისბრიჯი, აჰმედაბადი - 380006, გუჯარათი, ინდოეთი	(260) AM 2017 93485 A (220) 2017 07 25 (732) ბრიტიშ ამერიკენ ტობაკო (ბრენდს) ინკ. (დელავერის კორპორაცია) 2711 სენტერვილ როუდი, სუით 300, დელავერი, უილმინგტონი, 19808, აშშ
(111) M 2018 29825 R (151) 2018 06 20 (181) 2028 06 20 (260) AM 2017 92992 A (220) 2017 06 26 (732) შპს „ნიუ ფარმ გრუპი“ დ. აღმაშენებლის ხეივ. XII კმ, კორპ. 2, ბ. 43, ვაკე-საბურთალოს რ-ნი, 0131, თბილისი, საქართველო	(111) M 2018 29831 R (151) 2018 06 20 (181) 2028 06 20 (260) AM 2017 93492 A (220) 2017 07 26 (732) ირინა მჭედლიძე მოსკოვის გამზ. 37, ბ. 25, 0137, თბილისი, საქართველო
(111) M 2018 29826 R (151) 2018 06 20 (181) 2028 06 20 (260) AM 2017 93139 A (220) 2017 07 05 (732) შპს „ანაგი“ კოსტავას ქ. 37/39, 0171, თბილისი, საქართველო	(111) M 2018 29832 R (151) 2018 06 20 (181) 2028 06 20 (260) AM 2017 93530 A (220) 2017 07 27 (732) შპს „კახური ტრადიციული მეღვინეობა“ ს. ცინცაძის ქ.12, სართ. 3, არასაცხოფ- რებელი ფართი 3-6, 0160, თბილისი, საქართველო
(111) M 2018 29827 R (151) 2018 06 20 (181) 2028 06 20 (260) AM 2017 93143 A (220) 2017 07 05 (732) შპს „ანაგი“ კოსტავას ქ. 37/39, 0171, თბილისი, საქართველო	(111) M 2018 29833 R (151) 2018 06 20 (181) 2028 06 20 (260) AM 2016 88769 A (220) 2016 09 29 (732) შპს „ვილასეტი“ ცოტნე დადიანის ქ. 87, 0101, თბილისი, საქართველო
(111) M 2018 29828 R (151) 2018 06 20 (181) 2028 06 20 (260) AM 2017 93146 A (220) 2017 07 05 (732) შპს „ანაგი“ კოსტავას ქ. 37/39, 0171, თბილისი, საქართველო	
(111) M 2018 29829 R (151) 2018 06 20 (181) 2028 06 20 (260) AM 2017 93149 A (220) 2017 07 05 (732) შპს „ანაგი“ კოსტავას ქ. 37/39, 0171, თბილისი, საქართველო	
(111) M 2018 29830 R (151) 2018 06 20 (181) 2028 06 20	

დაჩქარებული პროცედურით რეგისტრირებული სასაქონლო ნიშნები

რეგისტრაციის გაუქმების მოთხოვნით საჩივრის შეტანა შესაძლებელია საქაბტენტის სააპელაციო პალატაში გამოქვეყნებიდან 3 თვის ვადაში.

(111) M 2018 29758 R

(151) 2018 06 06

(181) 2028 06 06

(210) AM 97786

(220) 2018 05 23

(732) შპს „აგრონომი“

ღ. გოთუას ქ. 12ა, 0160, თბილისი,
საქართველო

(540)



(591) ყავისფერი, თეთრი, შავი

(531) 19.11.07; 26.04.16; 26.11.13; 27.05.10;
27.05.11; 27.05.17; 29.01.13

(511)

5 – პესტიციდი.

(111) M 2018 29760 R

(151) 2018 06 08

(181) 2028 06 08

(210) AM 97784

(220) 2018 05 23

(732) შპს „აგრონომი“

ღ. გოთუას ქ. 12ა, 0160, თბილისი,
საქართველო

(540)



(591) ლურჯი, მწვანე

(531) 26.11.02; 26.11.12; 27.05.01; 27.05.08;
27.05.23; 29.01.12

(511)

5 – პესტიციდი.

(111) M 2018 29759 R

(151) 2018 06 08

(181) 2028 06 08

(210) AM 97417

(220) 2018 04 27

(732) ბადრი ვანაძე

სოფ. ვანაძეები, 6500, ხულოს რაიონი,
საქართველო

(540)



(591) წითელი, ლურჯი, თეთრი

(531) 26.01.01; 26.01.03; 26.01.21; 28.01; 28.19;
29.01.13

(526) „მეკა“

(511)

43 – რესტორანი.

(111) M 2018 29761 R

(151) 2018 06 12

(181) 2028 06 12

(210) AM 79963

(220) 2014 12 19

(732) შპს „მარშე“

თორნიკე ერისთავის ქ. 5, 0192, თბილისი,
საქართველო

(540)



(591) წითელი, თეთრი

(531) 26.13.25; 28.19.00; 29.01.12

(511)

35 – მართვა საქმიან სფეროში; საოფისე სამ-
სახური.

39 – ტრანსპორტირება. საქონლის შეფუთვა
და შენახვა; მოგზაურობის ორგანიზება.

- (111) M 2018 29762 R
- (151) 2018 06 14
- (181) 2028 06 14
- (210) AM 97452
- (220) 2018 05 04
- (732) ტი ვი ჯი შიპინგ ლიმიტიდ
140 ბ ფრანკლინ რუზველტ, CY-3011
ლიმასოლი, კვიპროსი
- (740) შალვა გვარამაძე
- (540)

BUKA

- (511)
- 25 – ტანსაცმელი, ფეხსაცმელი, თავსაბურავი.

- (111) M 2018 29763 R
- (151) 2018 06 14
- (181) 2028 06 14
- (210) AM 97769
- (220) 2018 05 21
- (732) შპს „ერგოლაინ საქართველო“
პეკინის გამზ. 29, ბ.8, 0160, თბილისი,
საქართველო
- (540)



- (591) შავი, ჟოლოსფერი
- (531) 26.04.01; 26.04.22; 26.04.24; 27.05.01;
27.05.19; 27.05.24; 29.01.12
- (511)
- 11 – გასარუჯი მანქანა-დანადგარი (სოლარიუმი).

- (111) M 2018 29764 R
- (151) 2018 06 15
- (181) 2028 06 15
- (210) AM 97978
- (220) 2018 06 07
- (732) ნელი ბაბუნაშვილი
თ. მუჯირიშვილის ქ. 7,
(ყოფილი ბაბისხევი), 0103,
თბილისი, საქართველო

(540)



- (591) მწვანე, წითელი, ყვითელი, შავი, თეთრი,
ნაცრისფერი
- (531) 01.15.03; 01.15.07; 01.15.09; 03.13.07;
03.13.17; 03.13.21; 03.13.23; 25.01.01;
26.03.23; 27.05.01; 27.05.03; 27.05.24;
29.01.15
- (511)
- 5 – მწერების საწინააღმდეგო აეროზოლი (ინსექტიციდი).

- (111) M 2018 29765 R
- (151) 2018 06 15
- (181) 2028 06 15
- (210) AM 97890
- (220) 2018 05 29
- (732) შპს „დოლფინ სოფტვეა“
ნიუპორტის ქ. 4, 4600, ქუთაისი,
საქართველო
- (740) ალექსანდრე ქართველიშვილი
- (540)



(591) თეთრი, შავი, ცისფერი
(531) 03.09.04; 27.05.10; 28.19; 29.01.12
(511)

9 – პროგრამული უზრუნველყოფა და მონაცემთა ბაზების მართვის სისტემები, რომლებიც განკუთვნილია საკრედიტო, ფინანსური და ბუღალტრული ოპერაციების აღრიცხვის, დამუშავების, ანალიზისა და ანგარიშგებისთვის.

(111) M 2018 29766 R

(151) 2018 06 15

(181) 2028 06 15

(210) AM 97891

(220) 2018 05 29

(732) შპს „დოლფინ სოფტვეა“

ნიუპორტის ქ. 4, 4600, ქუთაისი,

საქართველო

(740) ალექსანდრე ქართველიშვილი

(540)

დოლფინ სოფტვეა
Dolphin Software

(591) შავ-თეთრი

(511)

9 – პროგრამული უზრუნველყოფა და მონაცემთა ბაზების მართვის სისტემები, რომლებიც განკუთვნილია საკრედიტო, ფინანსური და ბუღალტრული ოპერაციების აღრიცხვის, დამუშავების, ანალიზისა და ანგარიშგებისთვის

(111) M 2018 29767 R

(151) 2018 06 15

(181) 2028 06 15

(210) AM 97399

(220) 2018 04 24

(732) სს „მეტრო ბიზნეს ცენტრი“

გოგოლის ქ. 1, ბათუმი, საქართველო

(540)



Legend Business Hotel
BATUMI

(591) მწვანე, სტაფილოსფერი, თეთრი

(531) 26.01.18; 27.05.01; 27.05.10; 27.05.15;

27.05.21; 29.01.12

(511)

43 – საკვები პროდუქტებითა და სასმელებით უზრუნველყოფა; დროებითი საცხოვრებელი უზრუნველყოფა.

(111) M 2018 29768 R

(151) 2018 06 15

(181) 2028 06 15

(210) AM 97881

(220) 2018 05 28

(732) შპს „როსსოფტ კონსალტინგი“

შალვა ნუცუბიძის ფერდობი, IV მკრ.,

კორპ. 11, ბ. 90, 0183, თბილისი,

საქართველო

(540)

ბესინი
BESINI

(591) შავ-თეთრი

(511)

33 – ალკოჰოლიანი სასმელები (ლეუდის გარდა).

(111) M 2018 29769 R

(151) 2018 06 19

(181) 2028 06 19

(210) AM 97961

(220) 2018 06 04

(732) შპს „ნიუ ფარმ გრუპი“

იროდიონ ევლოშვილის ქ.18, საოფისე

ფართი 2, დიდუბის რაიონი, 0154,

თბილისი, საქართველო

(540)

ნიუროქსიმი
Newroxime
Ньюроксим

(511)

5 – ფარმაცევტული პრეპარატები; სამედიცინო დანიშნულების ჰიგიენური პრეპარატები; სამედიცინო დანიშნულების დიეტური საკვები და ნივთიერებები, ბავშვთა საკვები; დიეტური დანამატები ადამიანებისათვის; კბილის დასაბუენი და კბილის ტვიფრის დასამზადებელი მასალა.

(111) M 2018 29770 R

(151) 2018 06 19

(181) 2028 06 19

(210) AM 97962

(220) 2018 06 04

(732) შპს „ნიუ ფარმ გრუპი“
იროლიონ ევლოშვილის ქ. 18, ს-ფ 2,
დიდუბის რ-ნი, 0154, თბილისი,
საქართველო

(540)

ნიუვასტი
Newvast
Ньюваст

(511)

5 – ფარმაცევტული პრეპარატები; სამედიცინო დანიშნულების ჰიგიენური პრეპარატები; სამედიცინო დანიშნულების დიეტური საკვები და ნივთიერებები, ბავშვთა საკვები; დიეტური დანამატები ადამიანებისათვის; კბილის დასაბჟენი და კბილის ტვიფრის დასამზადებელი მასალა.

(111) M 2018 29834 R

(151) 2018 06 20

(181) 2028 06 20

(210) AM 97967

(220) 2018 06 05

(732) შპს „ჯეფერინი“
დიდმის მას., I კვ., კორპ. 11, ბ. 71, 0159,
თბილისი, საქართველო
(540)



GEPHERRINI

(591) შავ-თეთრი

(531) 26.04.01; 26.04.05; 26.04.18; 27.05.01;
27.05.22

(511)

18 – ტყავი და ტყავის იმიტაცია; ცხოველთა ტყავი, ბეწვეული; სამგზავრო სკივრები, ჩემოდნები; წვიმისა და მზის ქოლგები; ხელჯოხები; შოლტები, მათრახები, ცხოველთა აღკაზმულობა და უნაგირები; საყელურები, საბეჭები და ცხოველთა სამოსი.

35 – რეკლამა; მართვა საქმიან სფეროში; ადმინისტრირება საქმიან სფეროში; საოფისე საშუალებები.

საერთაშორისო სასაქონლო ნიშნები, რომლებზეც ბამოტანილია გადაწყვეტილება დაცვის მინიჭების შესახებ

გადაწყვეტილების გასაჩივრება შესაძლებელია საქპატენტის სააპელაციო პალატაში გამოქვეყნებიდან 3 თვის ვადაში ან მცხეთის რაიონული სასამართლოს ადმინისტრაციულ საქმეთა კოლეგიაში 1 თვის ვადაში (მის.: ქალაქი მცხეთა, სამხედროს ქ. №17).

(260) AM 2018 92687 A

(800) 1284048

(151) 2015 11 17

(891) 2017 03 02

(731) Otkrytoe aktsionernoe obshchestvo

"PUSHKINSKIY ZAVOD"

Yaroslavskoe sh., 1-A RU-141200

g. Pushkino, Moskovskaya oblast, Russian

Federation

(540)

NAVIGATOR

(591) Black and white

(531) 27.05.01

(511)

1 – Anti-knock substances for internal combustion engines; antifreeze; acetates [chemicals]; acetone; water-softening preparations; surface-active chemical agents; chemicals for the manufacture of paints; distilled water; acidulated water for recharging accumulators; glycerine for industrial purposes; oil dispersants; petroleum dispersants; detergent additives to gasoline [petrol]; chemical additives for oils; additives, chemical, to motor fuel; fluids for hydraulic circuits; liquids for removing sulfates from accumulators; power steering fluid; brake fluid; transmission fluid; fillers for automobile bodies; oil cement [putty]; filtering materials [unprocessed plastics]; filtering materials [mineral substances]; filtering materials [chemical preparations]; combusting preparations [chemical additives to motor fuel]; anti-boil preparations for engine coolants; engine-decarbonising chemicals; solvents for varnishes; anti-frothing solutions for accumulators; water-purifying chemicals; oil-purifying chemicals; radiator flushing chemicals; industrial chemicals; coolants for vehicle engines; fissionable chemical elements; glycol ether; ethers.

4 – Benzine; benzene; benzol; petroleum jelly for industrial purposes; wax [raw material]; oil-gas; fuel gas; solidified gases [fuel]; fuel; additives, non-chemical, to motor-fuel; cutting fluids; grease for leather; tallow; industrial grease; xylene; xylo; mazut; oils for paints; lubricating oil; industrial oil; motor oil; sunflower oil for industrial purposes; lubricants; naphtha; petroleum, raw or refined; oleine; non-slipping preparations for belts; grease for arms [weapons]; lubricating grease; grease for belts; vaporized fuel mixtures; dust binding compositions for sweeping; dust laying compositions; alcohol [fuel];

diesel oil; mineral fuel; carburants; fuel with an alcoholic base; petroleum ether.

(260) AM 2018 92689 A

(800) 1285502

(151) 2015 11 17

(891) 2017 03 02

(731) Otkrytoe aktsionernoe obshchestvo

"PUSHKINSKIY ZAVOD"

Yaroslavskoe shosse, 1a Moskovskaya obl.,

RU-141200 Pushkino, Russian Federation

(540)

НАВИГАТОР

(591) Black and white

(531) 28.05

(511)

1 – Anti-knock substances for internal combustion engines; antifreeze; acetates [chemicals]; acetone; water-softening preparations; surface-active chemical agents; chemicals for the manufacture of paints; distilled water; acidulated water for recharging accumulators; glycerine for industrial purposes; oil dispersants; petroleum dispersants; detergent additives to gasoline [petrol]; chemical additives for oils; additives, chemical, to motor fuel; fluids for hydraulic circuits; liquids for removing sulfates from accumulators; power steering fluid; brake fluid; transmission fluid; fillers for automobile bodies; oil cement [putty]; filtering materials [unprocessed plastics]; filtering materials [mineral substances]; filtering materials [chemical preparations]; combusting preparations [chemical additives to motor fuel]; anti-boil preparations for engine coolants; engine-decarbonising chemicals; solvents for varnishes; anti-frothing solutions for accumulators; water-purifying chemicals; oil-purifying chemicals; radiator flushing chemicals; industrial chemicals; coolants for vehicle engines; fissionable chemical elements; glycol ether; ethers.

4 – Benzine; benzene; benzol; petroleum jelly for industrial purposes; wax [raw material]; oil-gas; fuel gas; solidified gases [fuel]; fuel; additives, non-chemical, to motor-fuel; cutting fluids; grease for leather; tallow; industrial grease; xylene; xylo; mazut; oils for paints; lubricating oil; industrial oil; motor oil; sunflower oil for industrial purposes; lubricants; naphtha; petroleum, raw or refined; oleine; non-slipping preparations for belts; grease for arms [wea-

pans]; lubricating grease; grease for belts; vaporized fuel mixtures; dust binding compositions for sweeping; dust laying compositions; alcohol [fuel]; diesel oil; mineral fuel; carburants; fuel with an alcoholic base; petroleum ether.

(260) AM 2018 92809 A

(800) 1349107

(151) 2017 03 13

(891) 2017 03 13

(731) BEYAZ KAĞIT VE HİJYENİK ÜRÜNLER
TEMİZLİK İNŞAAT SANAYİ TİCARET
ANONİM ŞİRKETİ

Hacı Sabancı Organize Sanayi Bölgesi,
Anavarza Caddesi No:3 Sarıçam, Adana,
Turkey

(540)

SEV

(591) Black, white

(531) 27.05.17; 27.05.23

(511)

5 – Pharmaceutical preparations for medical purposes; chemical preparations for medical purposes; chemical reagents for pharmaceutical purposes; dietary supplements for pharmaceutical purposes; dietary supplements; nutritional supplements; medical preparations for slimming purposes; food for babies; herbs and herbal beverages adapted for medicinal purposes; dental preparations and articles; teeth filling material, dental impression material, dental adhesives and material for repairing teeth; sanitary preparations for medical use; hygienic pads; hygienic tampons; plasters; materials for dressings; diapers, including those made of paper and textiles; fungicides, herbicides.

(260) AM 2018 93242 A

(800) 1353663

(151) 2017 03 21

(891) 2017 03 21

(731) Montres Jaquet Droz SA

(Montres Jaquet Droz AG) (Montres Jaquet
Droz Ltd)

Allée du Tourbillon 2, CH-2300 La Chaux-de-
Fonds, Switzerland

(540)

THE LOVING BUTTERFLY AUTOMATON

(591) Black, white

(511)

14 – Precious metals and their alloys and goods made of these materials or coated therewith included in this class namely split rings for keys, busts, statues, figurines, trophies, badges, medals, medallions,

ornamental pins, hat ornaments (of precious metals), footwear ornaments; jewelry, namely rings, earrings, cuff links, bracelets, charms, brooches, chains, necklaces, tie pins, tie clips, jewelry caskets, jewelry cases; precious stones, semi-precious stones; timepieces and chronometric instruments, namely, chronometers, chronographs, clocks, watches, wristwatches, wall clocks, alarm clocks and parts and accessories for the aforesaid goods, namely, hands, anchors, pendulums, barrels, watch cases, watch straps, watch dials, clockworks, watch chains, movements for timepieces, rough watch movements, watch springs, watch glasses, presentation cases for timepieces, cases for timepieces.

28 – Toy automatons, art automatons, animated automatons, particularly so-called "androids" for entertainment, as well as parts and components of the aforesaid goods included in this class.

(260) AM 2018 93244 A

(800) 1353748

(151) 2017 05 19

(891) 2017 05 19

(731) CODAN Holding GmbH

Stig Husted-Andersen Straße 11, 23738
Lensahn, Germany

(540)

Guard

(591) Black, white

(511)

10 – Drip chambers; infusion sets with drip chambers.

(260) AM 2018 93271 A

(800) 579805

(151) 1991 12 20

(891) 2016 07 28

(731) COMPAGNIE LAITIÈRE EUROPEENNE

société anonyme

F-50890 CONDE SUR VIRE, France

(540)

ELVOR

(591) Black, white

(511)

31 – Food substances for animals.

(260) AM 2018 93405 A

(800) 1355227

(151) 2017 04 25

(891) 2017 04 25

(731) LAARA ENTERPRISES LIMITED

Suite 1003, Khalid Al Attar Tower, P.O. Box
No.71241, Sheikh Zayed Road Dubai (AE),
United Arab Emirates

(540)

Mister Volt

Мистер Вольт

(591) Black and white

(531) 27.05.17; 28.05

(511)

5 – Fly catching paper; mothproofing paper; deodorants, other than for human beings or for animals; deodorants for clothing and textiles; insecticides; fly glue; air purifying preparations; preparations for destroying noxious animals; larvae exterminating preparations; fly destroying preparations; vermin destroying preparations; insect repellent incense; insect repellents; sanitary towels; tissues impregnated with pharmaceutical lotions; parasiticides.

35 – Presentation of goods on communication media, for retail purposes; sales promotion for others; publication of publicity texts; distribution of samples; dissemination of advertising matter; advertising; on-line advertising on a computer network; advertising by mail order; television advertising; procurement services for others [purchasing goods and services for other businesses]; outsourcing services [business assistance].

(260) AM 2018 93590 A

(800) 1357555

(151) 2016 11 08

(891) 2016 11 08

(731) KLOCHKO VITALII PETROVYCH

vyl. Hryzodubovoi, 82 A, kv. 38, m. Bila

Tserkva Kyivska obl. 09100, Ukraine

(540)

bcguma

(591) Black and white

(511)

3 – Bleaching preparations and other substances for laundry use; cleaning, polishing, scouring and abrasive preparations; soaps; perfumery; essential oils; cosmetics; hair lotions; dentifrices; abrasives; abrasive cloth; glass cloth; abrasive paper; breath freshening sprays; diamantine (abrasive); alum stones (astringents); amber (perfume); antistatic preparations for household purposes; air fragrancing preparations; balms other than for medical purposes; colorants for toilet purposes; colour-brightening chemicals for household purposes (laundry); bergamot oil; sachets for perfuming linen; joss sticks; preparations to make shiny the leaves of plants; lip glosses; nail polish; laundry glaze; shining preparations; badian essence; beard dyes; pastes for razor strops; shaving stones (astringents); shaving soap; shaving preparations; eyebrow cosmetics; eyebrow pencils; astringents for cosmetic purposes; petroleum jelly for cosmetic pur-

poses; cosmetic preparations for baths; bath salts, not for medical purposes; cotton wool for cosmetic purposes; cotton sticks for cosmetic purposes; shoe wax; bleaching soda; cream for whitening the skin; bleaching salts; dental bleaching gels; bleaching preparations (decolorants) for cosmetic purposes, decorative transfers for cosmetic purposes; cosmetic preparations for eyelashes; false eyelashes; adhesives for affixing false eyelashes; moustache wax; waxes for belts (leather); tailors' wax; polishing wax; laundry wax; shoemakers' wax; windscreen cleaning liquids; hair colorants; depilatory preparations; hair waving preparations; volcanic ash for cleaning; cloths impregnated with a detergent for cleaning; galtheria oil; heliotropine; geraniol; make-up; make-up preparations; make-up removing preparations; lipsticks; disinfectant soap; deodorants for pets; deodorants for human beings or for animals; deodorant soap, depilatory cream; shampoo for pets; scented water; scented wood; extracts of flowers (perfumes); ethereal essences; javelle water; jasmine oil; greases for cosmetic purposes; preparations for soaking laundry; aromatics (essential oils); flavorings for beverages (essential oils); cake flavorings (essential oils); preservatives for leather; color-removing preparations; scale removing preparations for household purposes; denture polishes; preparations for cleaning dentures; ionone (perfumery); rust removing preparations; silicon carbide (abrasive); carbides of metal (abrasives); bases for flower perfumes; essential oils of cedarwood; adhesives for affixing false hair; adhesives for cosmetic purposes; quillaia bark for washing; corundum (abrasive); cosmetics for animals, make-up powder; beauty masks; cosmetic kits; cosmetic preparations for slimming purposes; whitening; cleaning chalk; cosmetic creams; starch for laundry purposes; starch glaze for laundry purposes; cakes of toilet soap; lavender water; lavender oil; incense, lacquer-removing preparations; hair spray; essential oils of lemon; polishing paper; polishing stones, polishing creams; polish for furniture and flooring; medicated soap; lotions for cosmetic purposes; tissues impregnated with cosmetic lotions; after-shave lotions; smoothing preparations, (starching); fabric softeners for laundry use; mint for perfumery; mint essence (essential oil); massage gels other than for medical purposes; floor wax; non-slipping wax for floors; almond oil; almond soap; almond milk for cosmetic purposes; washing soda for cleaning; detergents other than for use in manufacturing operations and for medical purposes; soap for brightening textile; soap for foot perspiration; antiperspirant soap; cleansing milk for toilet purposes; musk (perfumery); emery; emery cloth; emery paper; ammonia (detergent); neutralizers for permanent waving; nail art stickers; nail care preparations; false nails; fumigation preparations (perfumes); eau de Cologne; oils for cosmetic purposes; oils for perfumes and scents; oils for cosmetic purposes; oils for

toilet purposes; oils for cleaning purposes; oil of turpentine for degreasing; breath freshening strips; drying agents for dishwashing machines; refurbishing preparations; perfumery; pumice stone; hydrogen peroxide for cosmetic purposes; non-slipping liquids for floors; floor wax removers (scouring preparations); stain removers; canned pressurized air for cleaning and dusting purposes; polishing rouge; varnish-removing preparations; mouthwashes, not for medical purposes; pomades for cosmetic purposes, dry-cleaning preparations; aloe vera preparations for cosmetic purposes; antiperspirants (toiletries); safrol; laundry blueing; turpentine, for degreasing; glass paper; sun-tanning preparations (cosmetics); soda lye; sunscreen preparations; douching preparations for personal sanitary or deodorant purposes (toiletries); preparations for unblocking drain pipes; potpourris (fragrances); dry shampoos; talcum powder, for toilet use; terpenes (essential oils); grinding preparations; tripoli stone for polishing; rose oil; toiletries, toilet water; mascara; color-removing preparations, cosmetic dyes; cleaning preparations; shampoos, shoemakers' wax; cosmetic preparations for skin care; smoothing stones; wallpaper cleaning preparations.

7 – Machines and machine tools; motors and engines (except for land vehicles); machine coupling and transmission components (except for land vehicles); agricultural implements other than hand-operated; incubators for eggs; automatic grapnels for marine purposes; air brushes for applying colour; aerocondensers; aerating pumps for aquaria; glaziers' diamonds (parts of machines); dashpot plungers (parts of machines); anti-friction bearings for machines; bitumen making machines; acetylene cleaning apparatus; drums (parts of machines); dyeing machines; concrete mixers (machines); whitewashing machines; pulleys (parts of machines); reels (parts of machines); harrows; flour mill machines; blade sharpening [stropping] machines; brewing machines; journal boxes (parts of machines); bulldozers; hoppers (mechanical discharging); mine borers; drilling machines; drilling bits (parts of machines); waggon lifts; vacuum pumps (machines); axles for machines; bearings for transmission shafts; printing rollers for machines; bearings (parts of machines); handling apparatus for loading and unloading; loading ramps; derricks; bicycle dynamos; bicycle assembling machines; fans for motors and engines; fan belts for motors and engines; machine tools; shoe polishers, electric; haulage apparatus (mining); blowing machines; apparatus for dressing; molds (parts of machines); exhaust manifold for engines; embossing machines; vibrators (machines) for industrial use; wringing machines for laundry; clack valves (parts of machines); trash compacting machines; centrifugal mills; centrifugal pumps; freewheels other than for land vehicles; winnowers; water separators; water heaters (parts of machines); metal drawing machi-

nes; winches; friezing machines; suction machines for industrial purposes; carbon brushes (electricity); vulcanisation apparatus; blowing machines for the compression, exhaustion and transport of gases; apparatus for aerating water; apparatus for aerating beverages; lawnmowers (machines); nut-tapping machines; electroplating machines; brake pads other than for vehicles; brake shoes other than for vehicles; brake segments other than for vehicles; alternators; dynamos; dynamo belts; dynamo brushes; current generators; door closers, hydraulic; door openers, hydraulic; hydraulic engines and motors; hydraulic turbines; torque converters other than for land vehicles; mineworking machines; mufflers for motors and engines; bending machines; carriages for knitting machines; cylinder heads for engines; card clothing (parts of carding machines); potters' wheels; sharpening wheels (parts of machines); sharpening machines; rakes for raking machines; engraving machines; stalk separators (machines); mud catchers and collectors (machines); door openers, electric; door closers, electric; door openers, pneumatic; door closers, pneumatic; motors for boats; engines for boats; de-aerators for feedwater; disintegrators; tympan (parts of printing presses); woodworking machines; turf removing ploughs; pump diaphragms; dividing machines; punching machines; tin openers, electric; mortising machines; milking machines; suction cups for milking machines; chisels for machines; moving pavements (sidewalks); road building machines; road sweeping machines, self-propelled; road rollers; drainage machines; electric hand drills; grinders; typographic presses; boxes for matrices (printing); printing machines; printing cylinders; printing machines for use on sheet metal; ejectors; excavators; electric welding apparatus; electric hammers; generators of electricity, emergency power generators; motors, electric, other than for land vehicles; electrodes for welding machines; electric arc welding apparatus; electric arc cutting apparatus; electromechanical machines for chemical industry; escalators; labellers (machines); flues for engine boilers; feeding apparatus for engine boilers; reapers; harvesting machines; reapers and binders; millstones; joints (parts of engines); shaft couplings (machines); sealing machines for industrial purposes; railroad constructing machines; igniting magnetos; igniting devices for internal combustion engines; curtain drawing devices, electrically operated; whisks, electric, for household purposes; soldering apparatus, gas-operated; raking machines; earth moving machines; blowing machines for the compression, sucking and carrying of grain; grain separators; reapers and threshers; corn and grain husking machines; blenders, electric, for household purposes; degreasers (machines); machine wheelwork; stitching machines; injectors for engines; hand-held tools, other than hand-operated; food preparation machines, electromechanical; capstans; coffee grinders, other

than hand-operated; calenders; rotary steam presses, portable, for fabrics; sizing machines; stone-working machines; ditchers (ploughs); control cables for machines, engines or motors; hoods (parts of machines); carburettors; carburetter feeders; crankcases for machines, motors and engines; catalytic converters; hydraulic controls for machines, motors and engines; control mechanisms for machines, engines or motors; pneumatic controls for machines, motors and engines; ball rings for bearings; grease rings (parts of machines); piston rings; valves (parts of machines); pressure reducers (parts of machines); glue guns, electric; riveting machines; bookbinding apparatus and machines for industrial purposes; machine wheels; crank shafts; compressors (machines); conveyors (machines); converters for steelworks; steam condensers (parts of machines); air condensers; condensing installations; diggers (machines); lasts for shoes (parts of machines); rams (machines); fodder presses; mechanized livestock feeders; gear boxes other than for land vehicles; housings (parts of machines); knives for mowing machines; bobbins for weaving looms; reels, mechanical, for flexible hoses; scale collectors for machine boilers; basket presses; taps (parts of machines, engines or motors); roller bridges; cranes (lifting and hoisting apparatus); hangers (parts of machines); tilt hammers; ball-bearings; cultivators (machines); food processors, electric; kitchen machines, electric; gas-operated blow torches; elevator chains (parts of machines); driving chains other than for land vehicles; chain saws; blade holders (parts of machines); ploughshares; foundry machines; adhesive tape dispensers (machines); machines and apparatus for polishing (electric); machines and apparatus for wax-polishing, electric; type-setting machines (printing); aeroplane engines; elevators (lifts); elevator operating apparatus; hoists; blades (parts of machines); corn husking machines; meat choppers (machines); machines for making pasta; handling machines, automatic (manipulators); churns; butter machines; grease boxes (parts of machines); lubricating pumps; lubricators (parts of machines); matrices for use in printing; machine flywheels, garbage (waste) disposals; machines for the textile industry; machines and apparatus for carpet shampooing, electric; notchers (machine tools); lace making machines; metalworking machines; power hammers; vehicle washing installations; washing apparatus; high pressure washers; washing machines (laundry); fleshing machines; mixers (machines); machines for the production of mineral water; mixing machines; bellows (parts of machines); forge bellows; agitators; mills (machines); mills for household purposes, other than hand-operated; threshing machines; hammers (parts of machines); pneumatic hammers; dairy machines; cream/milk separators; motorized cultivators; kick starters for motorcycles; cord making machines; clutches other than for land vehicles; pressure valves (parts of machines); super-

chargers; brake linings other than for vehicles; reeling apparatus, mechanical; beverage preparation machines, electromechanical; guides for machines; threading machines; pumps (machines); pumps (parts of machines, engines or motors); pumps for heating installations; oil refining machines; shears, electric; scissors, electric; knives (parts of machines); chaff cutter blades; knives, electric; wrapping machines; rotary printing presses; hemming machines; braiding machines; atomisers (machines); bearing brackets for machines; finishing machines; cleaning appliances utilizing steam; anti-pollution devices for motors and engines; tambours for embroidery machines; packing machines; self-regulating fuel pumps; fuel dispensing pumps for service stations; fuel conversion apparatus for internal combustion engines; fuel economisers for motors and engines; hosiery looms; papermaking machines; parquet wax-polishers, electric; boiler tubes (parts of machines); steam engines; steam engine boilers; steam/oil separators; steam traps; belts for machines; belts for conveyors; adhesive bands for pulleys; belts for motors and engines; chucks (parts of machines); soldering irons, gas-operated; soldering irons, electric; soldering apparatus, electric; soldering blow pipes, gas-operated; soldering lamps; pedal drives for sewing machines; superheaters; transmission shafts, other than for land vehicles; gears, other than for land vehicles; transmission chains other than for land vehicles; pepper mills other than hand-operated; apparatus for drawing up beer under pressure; beer pumps; saws (machines); saw blades (parts of machines); dust removing installations for cleaning purposes; dust exhausting installations for cleaning purposes; vacuum cleaners; vacuum cleaner bags; vacuum cleaner hoses; saw benches (parts of machines); spray guns for paint; feedwater regulators (machines); lifting apparatus; elevating apparatus; elevator belts; lifts, other than ski-lifts; jacks (machines); roller bearings; guns (tools using explosives); knitting machines; ploughs; bottle sealing machines; bottle capping machines; bottle stoppering machines; bottle washing machines; bottle filling machines; compressed air machines; compressed air guns for the extrusion of mastics; pneumatic transporters; pneumatic tube conveyors; air suction machines; aeronautical engines; engines for air cushion vehicles; air cushion devices for moving loads; air pumps (garage installations); feeders (parts of machines); paper feeders (printing); electric crushers for household purposes; cinder sifters (machines); pistons (parts of machines or engines); pistons for engines; pistons for cylinders; dishwashers; washing machines (laundry); coin-operated washing machines; ironing machines; smoothing presses; presses (machines for industrial purposes); wine presses; swaging machines; trueing machines; vacuum cleaner attachments for disseminating perfumes and disinfectants; punches for punching machines; rolling mills; rolling mill

cylinders; rinsing machines; weeding machines; sifting installations; tarring machines; springs (parts of machines); spinning frames; spinning machines; spinning wheels; puddling machines; radiators (cooling) for motors and engines; racket stringing machines; jet engines other than for land vehicles; regulators (parts of machines); speed governors for machines, engines and motors; pressure regulators (parts of machines); reduction gears other than for land vehicles; rack and pinion jacks; rail-laying machines, gears for weaving looms; loom shafts; cutting blow pipes, gas-operated; cutters (machines); holding devices for machine tools; tools (parts of machines); cutting machines; robots (machines); sewage pulverisers; filling machines; distribution machines, automatic; expansion tanks (parts of machines); ore treating machines; propulsion mechanisms other than for land vehicles; stuffing boxes (parts of machines); self-oiling bearings; satinizing machines; drilling heads (parts of machines); drilling rigs, floating or non-floating; drill chucks (parts of machines); glow plugs for Diesel engines; sparking plugs for internal combustion engines; separators; cigarette machines for industrial purposes; sieves (machines or parts of machines); sowers (machines); agricultural elevators; agricultural machines; trussing apparatus for hay; tedding machines; net hauling machines (fishing); chaff cutters; glass-working machines; snow ploughs; sheaf-binding machines; fruit presses, electric, for household purposes; sorting machines for industry; sausage making machines; stands for machines; starters for motors and engines; stators (parts of machines); stereotype machines; compressed air engines; tables for machines; clippers (machines); hair clipping machines for animals; belt conveyors; planing machines; slide rests (parts of machines); spin driers (not heated); heat exchangers (parts of machines); thermic lances (machines); grating machines for vegetables; beating machines; beaters, electric; kneading machines; looms; lathes (machine tools); transmissions for machines; transmissions, other than for land vehicles; wind turbines; turbines other than for land vehicles; turbocompressors; tobacco processing machines; driving motors other than for land vehicles; driving motors other than for land vehicles; universal joints (cardan joints); packaging machines; electrical apparatus for sealing plastics (packaging); painting machines; aprons (parts of machines); filters (parts of machines or engines); filters for cleaning cooling air, for engines; cartridges for filtering machines; filter presses; filtering machines; fittings for engine boilers; molding machines; stereotype machines; milling machines; bread cutting machines; journals (parts of machines); central vacuum cleaning installations; centrifugal machines; cylinders for motors and engines; cylinders for machines; galvanizing machines; machines for the production of sugar; carding machines; machines and apparatus for cleaning, electric; shuttles (parts of machines);

inking apparatus for printing machines; sewing machines; leather paring machines; leather-working machines; typecasting machines; die-stamping machines; stamping machines; darning machines; brushes (parts of machines); brushes, electrically operated (parts of machines).

17 – Rubber, gutta-percha, gum, asbestos, mica and goods made from these materials and not included in other classes; plastics in extruded form for use in manufacture; packing, stopping and insulating materials; flexible pipes, not of metal; shock-absorbing buffers of rubber; asbestos felt; asbestos cloth; asbestos paper; asbestos millboards; asbestos slate; asbestos fibers; asbestos safety curtains; asbestos sheets; asbestos packing; asbestos coverings; asbestos fabrics; acrylic resins (semi-finished products); shock-absorbing buffers of rubber; fittings, not of metal, for compressed air lines; reinforcing materials, not of metal, for pipes; cellulose acetate, semi-processed; balata; rubber seals for jars; canvas hose pipes; slag wool (insulator); cotton wool for packing (caulking); mineral wool (insulator); anti-dazzle films for windows (tinted films); viscose sheets, other than for wrapping; substances for insulating buildings against moisture; insulating refractory materials; stuffing rings; waterproof packings; threads of plastic materials, not for textile use; vulcanized fiber (fibre); fiberglass for insulation; carbon fibers (fibres), other than for textile use; brake lining materials, partly processed; rubber stoppers; rubber material for recapping tires, rubber sleeves for protecting parts of machines; dielectrics (insulators); ebonite (vulcanite); ebonite molds; insulators for electric mains; junctions, not of metal, for pipes; connecting hose for vehicle radiators; floating anti-pollution barriers; insulators for railway tracks; lute; joint packings; sealant compounds for joints; expansion joint fillers; weatherstripping compositions; draught excluder strips; soundproofing materials; insulators; foils of metal for insulating; insulating felt; insulating paper; insulating plaster; insulating varnish; insulating oils; insulating gloves; insulating bands; insulating fabrics; insulating paints; insulators for cables; liquid rubber; synthetic rubber; rubber, raw or semi-worked; foam supports for flower arrangements (semi-finished products); rings of rubber; clack valves of rubber; valves of india-rubber or vulcanized fiber (fibre); rubber solutions; self-adhesive tapes, other than stationery and not for medical or household purposes; paper for electrical capacitors; caulking materials; bark coverings for sound insulation; boiler composition to prevent the radiation of heat; latex (rubber); foil of regenerated cellulose, other than for wrapping; compositions to prevent the radiation of heat; joint packings for pipes; cylinder jointings, bags (envelopes, pouches) of rubber, for packaging; pipe jackets, not of metal; clutch linings; padding materials of rubber or plastics; elastic threads, not for use in textiles; threads of rubber, not

for use in textiles; soldering threads of plastic; threads of plastic materials, not for textile use; plastic substances, semi-processed; plastic sheeting for agricultural purposes; plastic film, other than for wrapping; watering hose; washers of rubber or vulcanized fiber (fibre); artificial resins (semi-finished products); glass wool for insulation; mica, raw or partly processed; stops of rubber; non-conducting materials for retaining heat; fiberglass fabrics for insulation, insulating oil for transformers; filtering materials (semi-processed foams or films of plastic); chemical compositions for repairing leaks; hoses of textile material; cords of rubber.

35 – Advertising; business management; business administration; office functions; the bringing together, for the benefit of other, of a variety of goods of 1, 2, 3, 4, 5, 6, 7, 8, 9, 10, 11, 12, 13, 14, 15, 16, 17, 18, 19, 20, 21, 22, 23, 24, 25, 26, 27, 28, 29, 30, 31, 32, 33, 34 classes, excluding the transport thereof, and information related to services of 35, 36, 37, 38, 39, 40, 41, 42, 43, 44, 45 classes, enabling customers to conveniently view and purchase those goods and services in supermarkets, shopping malls, retail stores, through web-pages, via the Internet; commercial information agency services; cost price analysis; auctioneering; book-keeping; market studies; opinion polling; psychological testing for the selection of personnel; organization of exhibitions for commercial or advertising purposes; telephone answering for unavailable subscribers; organization of trade fairs for commercial or advertising purposes; arranging newspaper subscriptions for others; business management of hotels; demonstration of goods; business information; business efficiency expert services; business inquiries; document reproduction; business management assistance; economic forecasting; transcription of communications [office functions]; presentation of goods on communication media, for retail purposes; compilation of information into computer databases; compilation of statistics; public relations; drawing up of statements of accounts; distribution of samples; import-export agency services; invoicing; on-line advertising on a computer network; commercial or industrial management assistance; advisory services for business management; business management and organization consultancy; business management consultancy; personnel management consultancy; commercial administration of the licensing of the goods and services of others; business management of sports people; commercial information and advice for consumers [consumer advice shop]; systemization of information into computer databases; personnel recruitment; layout services for advertising purposes; modelling for advertising or sales promotion; marketing; typing; script-writing for advertising purposes; updating of advertising material; design of advertising materials; dissemination of advertising matter; shop window dressing; business auditing; payroll preparation; tax

preparation; tax filing services; organization of fashion shows for promotional purposes; price comparison services; procurement services for others [purchasing goods and services for other businesses]; secretarial services; shorthand; photocopying services; publication of publicity texts; radio advertising; advertising by mail order; provision of an on-line marketplace for buyers and sellers of goods and services; rental of advertising time on communication media; advertising agency services; publicity material rental; rental of billboards [advertising boards]; production of advertising films; bill-posting; commercial intermediation services; television advertising; telemarketing services; rental of vending machines; rental of photocopying machines; data search in computer files for others.

(260) AM 2018 93626 A

(800) 1358771

(151) 2017 02 20

(891) 2017 02 20

(731) Limited Liability Company "TRAVEL LINE SYSTEMS"
Leninskiy pr-kt, 56 A, g. Yoshkar-Ola,
RU-424003 Respublika Mariy El, Russian
Federation

(540)



(591) White, black, blue and dark blue

(531) 26.01.06; 26.04.04; 26.04.10; 26.04.16;
27.05.01; 28.05; 29.01.13

(526) онлайн бронирование гостиниц

(511)

39 – Transport services by air, rail, taxi, bus, sea and river; transport services for sightseeing tours; travel arrangement, namely, booking of seats for travel, arranging of cruises, escorting of travellers.

42 – Technological services namely, providing information on computer technology and programming via a web site; conversion of computer programs and data, other than physical conversion; rental of computer software; hosting computer sites, namely web sites; server hosting; duplication of computer programs; consulting services in the field of cloud computing; electronic data storage; technical research in the field of systems of intellectualization processes of management of objects of hospitality industry and related systems, new principles of construction of distributed information systems based on cloud computing, development of cloud platforms; industrial analysis namely web site design consultancy, information technology consultancy, monitoring of computer systems by remote access; computer technology consultancy; design and development of computer hardware and software, namely updating

of computer software, software as a service namely business process automation for hotels, maintenance of computer software, creating and maintaining web sites for others, computer programming.

(260) AM 2018 93640 A
 (800) 1358889
 (151) 2017 06 01
 (891) 2017 06 01
 (731) DRONE RACING LEAGUE, INC.
 40 W. 27th St. New York NY 10001, USA
 (540)

DRL RACER3

(591) Black, white
 (511)
 28 – Toys and sporting goods in the nature of drones and unmanned aerial vehicles (UAVs).

(260) AM 2018 93641 A
 (800) 1358936
 (151) 2017 04 18
 (891) 2017 04 18
 (731) BIOFARMA
 50 rue Carnot, F-92284 Suresnes cedex,
 France
 (540)

КАРДИОСКИН

(591) Black, white
 (531) 28.05
 (511)
 9 – Scientific, optical, weighing, measuring, signaling, checking (supervision), life-saving and teaching apparatus and instruments; apparatus and instruments for conducting, switching, transforming, accumulating, regulating or controlling electricity; sound or image recording, transmission, reproduction apparatus; magnetic recording media; sound recording disks; data and information processing apparatus and equipment; software; computer programs; software recorded on magnetic media or downloaded from a remote computer network; software for monitoring physiological signals; software for the analysis, storage and monitoring of physiological data, including diagnostic, surveillance and warning tools; devices for capturing and transmitting physiological signals; devices, such as electroconductive clothing, incorporating electro-textile sensors for capturing physiological signals; personal digital assistant; transmitters of electronic signals.

10 – Surgical, medical, dental and veterinary apparatus and instruments; orthopedic articles; apparatus and instruments for checking, diagnosis, monitoring and alerts relating to heart, respiratory, neurological and physiological disorders; medical devices and instruments; diagnostic devices for medical use.

44 – Medical services; medical diagnostic services by electronic and telematic means.

(260) AM 2018 93642 A
 (800) 182276
 (151) 1995 01 27
 (891) 2017 07 18
 (731) STAHL INTERNATIONAL B.V.
 Sluisweg 10, NL-5145 PE WAALWIJK,
 Netherlands
 (540)

CAMOTEX

(591) Black, white
 (511)
 2 – Colorants for the leather and footwear industries.

(260) AM 2018 93643 A
 (800) 926191
 (151) 2007 04 25
 (891) 2017 05 26
 (731) "RN-Lubricants" LLC
 8, District Yuzhniy Promuzel, RU-390011
 Ryazan, Russian Federation
 (540)

REVOLUX

(591) Black, white
 (511)
 4 – Industrial oils and greases; lubricants; dust absorbing, wetting and binding compositions; fuels.

(260) AM 2018 93644 A
 (800) 1065669
 (151) 2011 01 12
 (891) 2017 06 09
 (731) YARA NEDERLAND B.V.
 Industrieweg 10, NL-4541 HJ Sluiskil,
 Netherlands
 (540)

SUPER FK

(591) Black, white
 (511)
 1 – Chemicals used in agriculture, horticulture and forestry; chemical agents for propagation by cuttings; growth promotants, flower preservatives and other chemical agents for treating flowers except fungicides and herbicides; fertilizers.

(260) AM 2018 93647 A
 (800) 1261518
 (151) 2015 06 08
 (891) 2017 05 12
 (731) CORTEFIEL, S.A.
 Avda del Llano Castellano, 51 E-28034
 MADRID, Spain

(540)

my essentials

by women'secret

(591) Black, white

(531) 27.05.15

(511)

25 – Ready-made clothing for women, men and children, footwear (except orthopedic footwear) and headgear.

(260) AM 2018 93648 A

(800) 1294614

(151) 2016 03 02

(891) 2017 07 06

(731) PENTHOUSE GLOBAL MEDIA, INC.

8944 Mason Ave. Chatsworth CA 91311,

USA

(540)

OMNI

(591) Black, white

(511)

16 – Magazines in the field of science, fiction and fantasy.

(260) AM 2018 93655 A

(800) 1358006

(151) 2016 11 18

(891) 2016 11 18

(731) Obschestvo s ogranichennoi otvetstvennostyu

"NAUCHNO-PROIZVODSTVENNAYA

FIRMA "MATERIA MEDICA HOLDING"

Trety Samotekny pereulok, 9 RU-127473

Moscow, Russian Federation

(540)

RENGALIN

(591) Black and white

(531) 27.05.01

(511)

5 – Pharmaceuticals, medical and veterinary preparations; sanitary preparations for medical purposes; dietetic food and substances adapted for medical or veterinary use, food for babies; dietary supplements for humans and animals; plasters, materials for dressings; aconitine; air purifying preparations; albuminous foodstuffs for medical purposes; albuminous preparations for medical purposes; aldehydes for pharmaceutical purposes; starch for dietetic or pharmaceutical purposes; anti-rheumatism bracelets; anti-rheumatism rings; anaesthetics; dill oil for medical purposes; adhesive plasters; angostura bark for medical purposes; asthmatic tea; frostbite salve for pharmaceutical purposes; hemorrhoid preparations;

antiseptic cotton; anti-uric preparations; aseptic cotton; bacteriological preparations for medical and veterinary use; bacterial preparations for medical and veterinary use; corn rings for the feet; bath preparations for medical purposes; salts for mineral water baths; oxygen baths; sea water for medicinal bathing; therapeutic preparations for the bath; balsamic preparations for medical purposes; bandages for dressings; balms for medical purposes; bismuth preparations for pharmaceutical purposes; lead water; charcoal for pharmaceutical purposes; candy, medicated; medicinal mud; mud for baths; bracelets for medical purposes; preparations for the treatment of burns; cachou for pharmaceutical purposes; preparations for callouses; calomel; syrups for pharmaceutical purposes; capsules for medicines; pharmaceutical preparations; poultices; wadding for medical purposes; lint for medical purposes; lime-based pharmaceutical preparations; chemico-pharmaceutical preparations; hydrated chloral for pharmaceutical purposes; collyrium; compresses; vitamin preparations; chemical conductors for electrocardiograph electrodes; condurango bark for medical purposes; medicines for alleviating constipation; radiological contrast substances for medical purposes; cotton for medical purposes; pharmaceutical preparations for treating sunburn; headache pencils; chilblain preparations; hemostatic pencils; croton bark; vaccines; detergents for medical purposes; decoctions for pharmaceutical purposes; dressings, medical; deparatives; disinfectants for hygiene purposes; deodorants, other than for human beings or for animals; diabetic bread adapted for medical use; digestives for pharmaceutical purposes; analgesics; drugs for medical purposes; magnesia for pharmaceutical purposes; melissa water for pharmaceutical purposes; mineral waters for medical purposes; mineral water salts; thermal water; barks for pharmaceutical purposes; elixirs [pharmaceutical preparations]; anticryptogamic preparations; vulnerary sponges; salts for medical purposes; ethers for pharmaceutical purposes; esters for pharmaceutical purposes; surgical dressings; eucalyptol for pharmaceutical purposes; eucalyptus for pharmaceutical purposes; purgatives; flour for pharmaceutical purposes; febrifuges; fennel for medical purposes; medicinal infusions; medicinal tea; cod liver oil; nervines; guaiacol for pharmaceutical purposes; vermifuges; gauze for dressings; laxatives; gelatine for medical purposes; gentian for pharmaceutical purposes; glycerophosphates; gum for medical purposes; linseed for pharmaceutical purposes; greases for medical purposes; greases for veterinary purposes; medicinal oils; hematogen; hemoglobin; medicinal herbs; hormones for medical purposes; mustard oil for medical purposes; hydrastine; hydrastinine; absorbent cotton; tincture of iodine; peptones for pharmaceutical purposes; iodoform; Irish moss for medical purposes; jalap; jujube, medicated; liquorice for pharmaceutical purposes;

milk ferments for pharmaceutical purposes; malted milk beverages for medical purposes; linseed meal for pharmaceutical purposes; lotions for pharmaceutical purposes; lactose for pharmaceutical purposes; yeast for pharmaceutical purposes; liniments; lupulin for pharmaceutical purposes; chewing gum for medical purposes; mangrove bark for pharmaceutical purposes; mint for pharmaceutical purposes; malt for pharmaceutical purposes; sulfur sticks [disinfectants]; pomades for medical purposes; tinctures for medical purposes; serums; mercurial ointments; nutritive substances for microorganisms; cultures of microorganisms for medical or veterinary use; pastilles for pharmaceutical purposes; mustard for pharmaceutical purposes; myrobalan bark for pharmaceutical purposes; smelling salts; ointments for pharmaceutical purposes; opodeldoc; ophotherapy preparations; pectin for pharmaceutical purposes; phenol for pharmaceutical purposes; paper for mustard plasters; pharmaceutical preparations for skin care; herbal teas for medicinal purposes; pepsins for pharmaceutical purposes; cachets for pharmaceutical purposes; phosphates for pharmaceutical purposes; blood plasma; potassium salts for medical purposes; quebracho for medical purposes; quassia for medical purposes; quinquina for medical purposes; quinine for medical purposes; chinoline for medical purposes; radioactive substances for medical purposes; radium for medical purposes; medicinal roots; rhubarb roots for pharmaceutical purposes; tonics [medicines]; bismuth subnitrate for pharmaceutical purposes; sarsaparilla for medical purposes; blood for medical purposes; leeches for medical purposes; scapulars for surgical purposes; sedatives; ergot for pharmaceutical purposes; serotherapeutic medicines; mustard plasters; soporifics; sodium salts for medical purposes; styptic preparations; sugar for medical purposes; sulfonamides [medicines]; suppositories; tartar for pharmaceutical purposes; turpentine for pharmaceutical purposes; oil of turpentine for pharmaceutical purposes; thymol for pharmaceutical purposes; veterinary preparations; vesicants; acetates for pharmaceutical purposes; acids for pharmaceutical purposes; adhesive tapes for medical purposes; alkaloids for medical purposes; dietetic foods adapted for medical purposes; food for babies; aluminium acetate for pharmaceutical purposes; milk of almonds for pharmaceutical purposes; bath salts for medical purposes; stick liquorice for pharmaceutical purposes; bicarbonate of soda for pharmaceutical purposes; biological preparations for medical purposes; bromine for pharmaceutical purposes; dietetic beverages adapted for medical purposes; camphor oil for medical purposes; camphor for medical purposes; candy for medical purposes; lecithin for medical purposes; gases for medical purposes; royal jelly for pharmaceutical purposes; medical preparations for slimming purposes; cellulose esters for pharmaceutical purposes;

caustics for pharmaceutical purposes; by-products of the processing of cereals for dietetic or medical purposes; chemical preparations for pharmaceutical purposes; collodion for pharmaceutical purposes; cream of tartar for pharmaceutical purposes; creosote for pharmaceutical purposes; medicines for human purposes; medicines for veterinary purposes; diagnostic preparations for medical purposes; glycerine for medical purposes; medicinal drinks; ferments for pharmaceutical purposes; flowers of sulfur for pharmaceutical purposes; smoking herbs for medical purposes; fumigation preparations for medical purposes; gallic acid for pharmaceutical purposes; petroleum jelly for medical purposes; glucose for medical purposes; gamboge for medical purposes; gurjun [gurjon, gurjan] balsam for medical purposes; extracts of hops for pharmaceutical purposes; castor oil for medical purposes; hydrogen peroxide for medical purposes; iodine for pharmaceutical purposes; iodides for pharmaceutical purposes; alkaline iodides for pharmaceutical purposes; isotopes for medical purposes; dietetic substances adapted for medical use; biological preparations for veterinary purposes; chemical preparations for medical purposes; chemical preparations for veterinary purposes; chemical reagents for medical or veterinary purposes; diastase for medical purposes; enzymes for medical purposes; enzymes for veterinary purposes; enzyme preparations for medical purposes; enzyme preparations for veterinary purposes; siccatives [drying agents] for medical purposes; tissues impregnated with pharmaceutical lotions; preparations of trace elements for human and animal use; amino acids for medical purposes; amino acids for veterinary purposes; cedar wood for use as an insect repellent; fish meal for pharmaceutical purposes; mineral food supplements; nutritional supplements; antibiotics; bronchodilating preparations; moleskin for medical purposes; adjuvants for medical purposes; oxygen for medical purposes; stem cells for medical purposes; biological tissue cultures for medical purposes; biological tissue cultures for veterinary purposes; cooling sprays for medical purposes; aloe vera preparations for pharmaceutical purposes; pearl powder for medical purposes; antioxidant pills; albumin dietary supplements; wheat germ dietary supplements; medicated animal feed; pharmaceutical cough preparations; cough syrups and cough medicine drinks.

(260) AM 2018 93657 A

(800) 1358021

(151) 2017 04 10

(891) 2017 04 10

(731) DAIICHI SANKYO COMPANY,
LIMITED

3-5-1, Nihonbashi Honcho, Chuo-ku Tokyo
103-8426, Japan

(540)

Duefcomb

(591) Black and white

(531) 27.05.01

(511)

5 – Pharmaceutical preparations and substances.

(260) AM 2018 93658 A

(800) 1358022

(151) 2017 04 10

(891) 2017 04 10

(731) DAIICHI SANKYO COMPANY, LIMITED
3-5-1, Nihonbashi Honcho, Chuo-ku Tokyo
103-8426, Japan

(540)

Asceprev

(591) Black and white

(531) 27.05.01

(511)

5 – Pharmaceutical preparations and substances.

(260) AM 2018 93667 A

(800) 1358063

(151) 2017 05 17

(891) 2017 05 17

(731) ROLEX SA
Rue François-Dussaud 3-5-7 CH-1211
Genève 26, Switzerland

(540)

OYSTERSTEEL

(591) Black and white

(511)

6 – Common metals and their alloys; unwrought or semi-wrought steel; common metals and their alloys for use in clock and watch-making; stainless steels and steel alloys for use in clock and watch-making.

14 – Timepieces, namely watches, wristwatches, component parts of timepieces and accessories for timepieces not included in other classes, clocks and other chronometric instruments, chronometers, chronographs (timepieces); watch bands, dials (for timepieces), cases and presentation cases for timepieces and jewelry, watch movements and their parts; jewelry; precious stones and semi-precious stones; precious metals and their alloys.

(260) AM 2018 93668 A

(800) 1358071

(151) 2017 08 19

(891) 2017 08 19

(731) rommelag – Kunststoff – Maschinen
Vertriebsgesellschaft mbH
Mayennerstraße 18-20 71332 Waiblingen,
Germany

(540)

ROMMELAG

(591) Black and white

(511)

7 – Container filling systems (machines); feeding machines for containers; aseptic feeding machines for containers; filling machines for containers; aseptic filling machines; moulding and blow moulding machines for producing plastic containers from injection-moulded, thermoplastic blanks; machines for producing ampoules, pouches, cans, boxes and containers; injection moulding, injection blow moulding, extrusion blow moulding, stretch blow moulding and blow moulding machines for producing hollow bodies of plastic, in particular containers; machines for processing thermoplastic plastics and for making plastic articles, in particular for producing, filling and closing containers of plastic and for producing films of plastic; blow-moulding, filling and sealing machines; machines for preparing plastics and machines for processing plastics; container rinsing machines; aligners (machine parts); conveyors (machine parts) for container filling systems; positioning machines and orientation machines for containers; locking machines and sealing machines for containers; automatic accumulation tables (parts of machines) for containers, and other buffering devices (parts of machines); packaging machines and wrapping machines; erectors (machine parts) for plastic bottles and plastic containers; pallet unloaders (conveyor machines); palletisers and depalletisers (conveying machines); industrial robots; labellers (machines); installations (machines) for treating fluids; mixing machines; homogenising machines; agitators; stirring machines for liquids and gases, in particular saturators.

21 – Plastic ampoules, plastic containers and band-like products consisting of the aforesaid ampoules and containers, in particular all of the aforesaid goods being produced using a blow moulding, filling and sealing process.

35 – Retailing and wholesaling in relation to container filling installations, including blow moulding, filling and sealing machines, charging machines for containers, aseptic charging machines for containers, filling machines for containers, aseptic filling machines, moulding and blow moulding machines for producing plastic containers made of injection-moulded thermoplastic blanks, machines for producing ampoules, bags, cases, boxes and containers, injection moulding, injection blow moulding, extrusion blow moulding, stretch blow moulding and blow moulding machines for producing hollow bodies of plastic, in particular containers, machines for processing thermoplastics and for producing plastic products, in particular for producing plastic films and for producing, filling and sealing plastic containers, blow moulding, filling and sealing machines, coo-

ling devices and devices for controlled heat dissipation of extruded and filled container products for the purposes of protecting heat-sensitive fillings, sterilising installations and machines, and the aforesaid devices and parts therefor, machines for preparing and processing plastics, container rinsing machines, aligners, conveying devices for container filling systems, machines for positioning and orienting containers, machines for locking and sealing containers, automatic accumulation tables for containers, and other buffering devices, packaging and wrapping machines, erectors for plastic bottles and plastic containers, pallet unloaders, palletisers and depalletisers, industrial robots, labellers, installations for treating fluids, mixers, homogenising machines, agitators, stirring machines for liquids and gas, in particular saturators.

37 – Installation, maintenance and repair of container filling systems, including blow moulding, filling and sealing machines, machines for processing thermoplastics and for producing plastic products, in particular for producing plastic films and for producing, filling and sealing plastic containers; installation, maintenance and repair of blow moulding, filling and sealing machines; installation, maintenance and repair of cooling devices and devices for controlled heat dissipation of extruded and filled container products for the purposes of protecting heat-sensitive charges; installation, maintenance and repair, and leasing and rental of sterilising systems and machines, and devices and parts therefor; installation, maintenance and repair of machines for preparing and processing plastics, palletising machines, depalletising machines, packaging machines, unpacking machines, sorting machines, cleaning machines, inspection machines, filling machines, sealing machines, labellers and packing machines; leasing and rental of machines for filling and sealing containers, rinsing machines; leasing and rental of aligners and conveying devices for container filling installations.

42 – Technical consultancy and development, engineering, and research in the fields of container filling installations, including blow moulding, filling and sealing machines, charging machines for containers, aseptic charging machines for containers, filling machines for containers, aseptic filling machines, moulding and blow moulding machines for producing plastic containers from injection-moulded, thermoplastic blanks, machines for producing ampoules, pouches, cases, boxes and containers, injection moulding, injection blow moulding, extrusion blow moulding, stretch blow moulding and blow moulding machines for producing hollow bodies of plastic, in particular containers, machines for processing thermoplastics and for producing plastic products, in particular for producing plastic films and for producing, filling and sealing plastic containers, blow moulding, filling and sealing machines, cooling de-

vices and devices for controlled heat dissipation of extruded and filled container products for the purposes of protecting heat-sensitive fillings, sterilising systems and machines, and devices and parts therefor, machines for preparing and processing plastics, container rinsing machines, aligners, conveying devices for container filling systems, machines for positioning and aligning containers, machines for locking and sealing containers, automatic accumulation tables for containers, and other buffering devices, packaging and wrapping machines, erectors for plastic bottles and plastic containers, pallet unloaders, palletisers and depalletisers, industrial robots, labellers, systems for handling liquids, mixers, homogenising machines, agitators, agitators for liquids and gas, in particular saturators.

(260) AM 2018 93669 A
(800) 1358074
(151) 2016 11 03
(891) 2016 11 03
(731) EURO GAMES TECHNOLOGY LTD.
"Maritsa" Str. 4, "Vranya-Lozen-Triugulnika"
BG-1151 Sofia, Bulgaria
(540)



(591) Yellow, dark brown and red
(531) 27.05.02; 27.05.19; 29.01.13
(511)
9 – Apparatus for recording, transmission or reproduction of sound or images, computer software, recorded, monitors [computer hardware].
28 – Games that are not included in other classes; gaming machines operating with coins, banknotes and cards; gaming machines for gambling, adapted for use with external screen or monitor.

(260) AM 2018 93670 A
(800) 1358144
(151) 2017 04 27
(891) 2017 04 27
(731) ASTELLAS PHARMA INC.
5-1, Nihonbashi-Honcho 2-chome, Chuo-ku
Tokyo 103-8411, Japan
(540)



(591) Black and white
(531) 27.05.01
(511)
5 – Vaccines for human use.

(260) AM 2018 93671 A

(800) 1358172

(151) 2017 01 09

(891) 2017 01 09

(731) BEIERSDORF AG

Unnastrasse 48 20253 Hamburg, Germany

(540)

NIVEA URBAN SKIN

(591) Black and white

(511)

3 – Cosmetic skin care preparations.

(260) AM 2018 93686 A

(800) 1358332

(151) 2017 03 09

(891) 2017 03 09

(731) NEILOS S.R.L.

Via Bagnulo, 95, I-80063 PIANO DI
SORRENTO (NA), Italy

(540)

REFLUWARD

(591) Black, white

(531) 27.05.17

(511)

5 – Dental abrasives; aconitine; adhesives for dentures; air purifying preparations; albuminous food-stuffs for medical purposes; albuminous preparations for medical purposes; medicinal alcohol; aldehydes for pharmaceutical purposes; alloys of precious metals for dental purposes; dental amalgams; starch for dietetic or pharmaceutical purposes; anaesthetics; dill oil for medical purposes; adhesive plasters; sticking plasters; angostura bark for medical purposes; preparations for destroying noxious animals; asthma tea; frostbite salve for pharmaceutical purposes; hemorrhoid preparations; haemorrhoid preparations; preparations for destroying dry rot fungus; mothproofing preparations; antiparasitic preparations; antiseptics; antiseptic cotton; anti-uric preparations; wart pencils; aseptic cotton; fly catching paper; media for bacteriological cultures; bouillons for bacteriological cultures; bacteriological culture mediums; bacteriological preparations for medical and veterinary use; bacterial poisons; bacterial preparations for medical and veterinary use; corn rings for the feet; bath preparations for medical purposes; salts for mineral water baths; oxygen baths; sea water for medicinal bathing; therapeutic preparations for the bath; balsamic preparations for medical purposes; bandages for dressings; balms for medical purposes; cattle washes [insecticides]; biocides; bismuth preparations for pharmaceutical purposes; lead water; Goulard water; insecticides; charcoal for pharmaceutical purposes; candy medicated; medicinal mud; medicinal sediment [mud]; mud for baths; preparations for the treatment of burns; cachou for

pharmaceutical purposes; preparations for callouses; calomel [fungicide]; powder of cantharides; rubber for dental purposes; syrups for pharmaceutical purposes; capsules for medicines; pharmaceutical preparations; poultices; belts for sanitary napkins [towels]; wadding for medical purposes; lint for medical purposes; lime-based pharmaceutical preparations; dog washes [insecticides]; repellents for dogs; chemico-pharmaceutical preparations; hydrated chloral for pharmaceutical purposes; chloroform; tobacco-free cigarettes for medical purposes; dental cements; cement for animal hooves; molding wax for dentists; moulding wax for dentists; fumigating sticks; fumigating pastilles; cocaine; antiparasitic collars for animals; collyrium; compresses; vitamin preparations; chemical conductors for electrocardiograph electrodes; condurango bark for medical purposes; medicines for alleviating constipation; solutions for contact lenses; solutions for use with contact lenses; chemical contraceptives; radiological contrast substances for medical purposes; corn remedies; cotton for medical purposes; pharmaceutical preparations for treating sunburn; caustic pencils; chilblain preparations; hemostatic pencils; haemostatic pencils; croton bark; curare; vaccines; detergents for medical purposes; decoctions for pharmaceutical purposes; teeth filling material; dental impression materials; dental lacquer; dental mastics; dressings, medical; porcelain for dental prostheses; preparations to facilitate teething; depuratives; disinfectants for hygiene purposes; deodorants, other than for human beings or for animals; preparations for destroying mice; diabetic bread adapted for medical use; digestives for pharmaceutical purposes; digitalin; analgesics; drugs for medical purposes; medicine cases, portable, filled; magnesia for pharmaceutical purposes; melissa water for pharmaceutical purposes; mineral waters for medical purposes; mineral water salts; thermal water; barks for pharmaceutical purposes; elixirs [pharmaceutical preparations]; solvents for removing adhesive plasters; anticryptogamic preparations; vulnerary sponges; salts for medical purposes; esters for pharmaceutical purposes; ethers for pharmaceutical purposes; surgical dressings; eucalyptol for pharmaceutical purposes; eucalyptus for pharmaceutical purposes; purgatives; evacants; flour for pharmaceutical purposes; meal for pharmaceutical purposes; lacteal flour for babies; febrifuges; fennel for medical purposes; medicinal infusions; medicinal tea; cod liver oil; fungicides; nervines; guaiacol for pharmaceutical purposes; vermifuges; anthelmintics; gauze for dressings; laxatives; gelatine for medical purposes; gentian for pharmaceutical purposes; germicides; glycerophosphates; gum for medical purposes; linseed for pharmaceutical purposes; flaxseed for pharmaceutical purposes; greases for medical purposes; greases for veterinary purposes; milking grease; chemical preparations for the diagnosis of pregnancy; medicinal oils;

hematogen; haematogen; hemoglobin; haemoglobin; medicinal herbs; hormones for medical purposes; mustard oil for medical purposes; hydrastine; hydrastinine; absorbent cotton; absorbent wadding; semen for artificial insemination; insect repellents; tincture of iodine; peptones for pharmaceutical purposes; iodoform; Irish moss for medical purposes; jalap; jujube medicated; liquorice for pharmaceutical purposes; tobacco extracts [insecticides]; milk ferments for pharmaceutical purposes; malted milk beverages for medical purposes; animal washes [insecticides]; linseed meal for pharmaceutical purposes; flaxseed meal for pharmaceutical purposes; lotions for pharmaceutical purposes; lactose for pharmaceutical purposes; milk sugar for pharmaceutical purposes; larvae exterminating preparations; yeast for pharmaceutical purposes; slug exterminating preparations; liniments; lupulin for pharmaceutical purposes; chewing gum for medical purposes; mangrove bark for pharmaceutical purposes; sanitary panties; menstruation knickers; sanitary knickers; sanitary pants; mint for pharmaceutical purposes; chemical preparations to treat mildew; malt for pharmaceutical purposes; herbicides; preparations for destroying noxious plants; weedkillers; sulfur sticks [disinfectants]; pomades for medical purposes; tinctures for medical purposes; serums; menthol; mercurial ointments; nutritive substances for microorganisms; cultures of microorganisms for medical or veterinary use; pastilles for pharmaceutical purposes; lozenges for pharmaceutical purposes; rat poison; fly glue; fly catching adhesives; fly destroying preparations; mustard for pharmaceutical purposes; lotions for veterinary purposes; myrobalan bark for pharmaceutical purposes; chemical preparations to treat wheat blight [smut]; chemical preparations to treat wheat smut; narcotics; smelling salts; ointments for pharmaceutical purposes; opiates; opium; opodeldoc; opotherapy preparations; organotherapy preparations; dental amalgams of gold; pectin for pharmaceutical purposes; sanitary tampons; menstruation tampons; sanitary pads; menstruation bandages; sanitary towels; sanitary napkins; phenol for pharmaceutical purposes; paper for mustard plasters; paper for mustard poultices; parasiticides; pharmaceutical preparations for skin care; herbal teas for medicinal purposes; pharmaceutical preparations for treating dandruff; pepsins for pharmaceutical purposes; cachets for pharmaceutical purposes; first-aid boxes, filled; phosphates for pharmaceutical purposes; chemical preparations for treating phyloxera; remedies for foot perspiration; blood plasma; poisons; potassium salts for medical purposes; pyrethrum powder; quebracho for medical purposes; quassia for medical purposes; quinquina for medical purposes; cinchona for medical purposes; quinine for medical purposes; chinoline for medical purposes; radioactive substances for medical purposes; radium for medical purposes; medicinal roots; rhubarb roots for pharmaceu-

tical purposes; tonics [medicines]; bismuth subnitrate for pharmaceutical purposes; sarsaparilla for medical purposes; blood for medical purposes; leeches for medical purposes; scapulars for surgical purposes; sedatives; tranquilizers; ergot for pharmaceutical purposes; serotherapeutic medicines; mustard plasters; mustard poultices; soil-sterilising preparations; soporifics; sodium salts for medical purposes; sterilising preparations; strychnine; styptic preparations; sugar for medical purposes; sulfonamides [medicines]; suppositories; tartar for pharmaceutical purposes; turpentine for pharmaceutical purposes; oil of turpentine for pharmaceutical purposes; thymol for pharmaceutical purposes; remedies for perspiration; mothproofing paper; mothproof paper; veterinary preparations; vine disease treating chemicals; vermin destroying preparations; vesicants; acetates for pharmaceutical purposes; acids for pharmaceutical purposes; adhesive tapes for medical purposes; adhesive bands for medical purposes; alkaloids for medical purposes; dietetic foods adapted for medical purposes; food for babies; aluminium acetate for pharmaceutical purposes; almond milk for pharmaceutical purposes; sunburn ointments; bath salts for medical purposes; stick liquorice for pharmaceutical purposes; bicarbonate of soda for pharmaceutical purposes; biological preparations for medical purposes; bromine for pharmaceutical purposes; dietetic beverages adapted for medical purposes; camphor oil for medical purposes; camphor for medical purposes; candy for medical purposes; carbolineum [parasiticide]; algicides; lecithin for medical purposes; gases for medical purposes; panty liners [sanitary]; royal jelly for pharmaceutical purposes; medical preparations for slimming purposes; cellulose esters for pharmaceutical purposes; caustics for pharmaceutical purposes; cellulose ethers for pharmaceutical purposes; by-products of the processing of cereals for dietetic or medical purposes; chemical preparations for pharmaceutical purposes; collodion for pharmaceutical purposes; cream of tartar for pharmaceutical purposes; creosote for pharmaceutical purposes; medicines for dental purposes; medicines for human purposes; medicines for veterinary purposes; diagnostic preparations for medical purposes; glycerine for medical purposes; medicinal drinks; ferments for pharmaceutical purposes; flowers of sulfur for pharmaceutical purposes; formic aldehyde for pharmaceutical purposes; smoking herbs for medical purposes; fumigation preparations for medical purposes; gallic acid for pharmaceutical purposes; petroleum jelly for medical purposes; glucose for medical purposes; gamboge for medical purposes; gurjun [gurjon, gurjan] balsam for medical purposes; extracts of hops for pharmaceutical purposes; castor oil for medical purposes; hydrogen peroxide for medical purposes; iodine for pharmaceutical purposes; iodides for pharmaceutical purposes; alkaline iodides for pharmaceutical purposes; isotopes for

medical purposes; dietetic substances adapted for medical use; diapers for incontinents; napkins for incontinents; biological preparations for veterinary purposes; chemical preparations for medical purposes; chemical preparations for veterinary purposes; chemical reagents for medical or veterinary purposes; contact lens cleaning preparations; diastase for medical purposes; dietary fiber; dietary fibre; enzymes for medical purposes; enzymes for veterinary purposes; enzyme preparations for medical purposes; enzyme preparations for veterinary purposes; pants, absorbent, for incontinents; siccatives [drying agents] for medical purposes; tissues impregnated with pharmaceutical lotions; preparations of trace elements for human and animal use; amino acids for medical purposes; amino acids for veterinary purposes; breast-nursing pads; cedar wood for use as an insect repellent; disinfectants for chemical toilets; fish meal for pharmaceutical purposes; mineral food supplements; mouthwashes for medical purposes; nutritional supplements; bone cement for surgical and orthopaedic purposes; bone cement for surgical and orthopedic purposes; insect repellent incense; acaricides; antibiotics; appetite suppressants for medical purposes; bronchodilating preparations; bunion pads; moleskin for medical purposes; vaginal washes for medical purposes; medicinal hair growth preparations; steroids; adjuvants for medical purposes; surgical implants comprised of living tissues; eyepatches for medical purposes; oxygen for medical purposes; deodorants for clothing and textiles; air deodorising preparations; douching preparations for medical purposes; stem cells for medical purposes; stem cells for veterinary purposes; biological tissue cultures for medical purposes; biological tissue cultures for veterinary purposes; cooling sprays for medical purposes; personal sexual lubricants; aloe vera preparations for pharmaceutical purposes; pearl powder for medical purposes; preparations for reducing sexual activity; babies' diapers [napkins]; babies' napkins [diapers]; babies' napkin-pants [diaper-pants]; babies' diaper-pants; babies' napkin-pants; medicated eye-washes; appetite suppressant pills; slimming pills; tanning pills; antioxidant pills; dietary supplements for animals; albumin dietary supplements; linseed dietary supplements; flaxseed dietary supplements; linseed oil dietary supplements; flaxseed oil dietary supplements; wheat germ dietary supplements; yeast dietary supplements; royal jelly dietary supplements; propolis for pharmaceutical purposes; propolis dietary supplements; pollen dietary supplements; enzyme dietary supplements; glucose dietary supplements; lecithin dietary supplements; alginate dietary supplements; alginates for pharmaceutical purposes; casein dietary supplements; protein dietary supplements; protein supplements for animals; reagent paper for medical purposes; alcohol for pharmaceutical purposes; pesticides; diapers for pets; disinfectants; surgical glues;

diagnostic biomarker reagents for medical purposes; acne treatment preparations; medicated animal feed; diagnostic preparations for veterinary purposes; cotton sticks for medical purposes; cotton swabs for medical purposes; infant formula; powdered milk for babies; transplants [living tissues]; collagen for medical purposes; plant extracts for pharmaceutical purposes; pharmaceuticals; preparations of microorganisms for medical or veterinary use; phytotherapy preparations for medical purposes; herbal extracts for medical purposes; sexual stimulant gels; immunostimulants; nutraceutical preparations for therapeutic or medical purposes; freeze-dried food adapted for medical purposes; lyophilized food adapted for medical purposes; lyophilised food adapted for medical purposes; homogenized food adapted for medical purposes; pre-filled syringes for medical purposes; freeze-dried meat adapted for medical purposes; lyophilized meat adapted for medical purposes; lyophilised meat adapted for medical purposes; reagent paper for veterinary purposes; astringents for medical purposes; medicated dentifrices; lice treatment preparations [pediculicides]; pediculicidal shampoos; insecticidal animal shampoo; insecticidal veterinary washes; antibacterial soap; antibacterial handwashes; medicated after-shave lotions; medicated shampoos; medicated toiletry preparations; medicated hair lotions; medicated dry shampoos; medicated shampoos for pets; disinfectant soap; medicated soap.

(260) AM 2018 93687 A

(800) 1358405

(151) 2017 01 12

(891) 2017 01 12

(731) GENERAL CONFERENCE CORPORATION
OF SEVENTH-DAY ADVENTISTS
12501 OLD COLUMBIA PIKE, SILVER
SPRING MD 209046600, USA

(540)

**SEVENTH-DAY
ADVENTIST**

(591) Black, white

(531) 27.05.15

(511)

16 – Religious books, magazines, pamphlets, newsletters, brochures, encyclopedias, dictionaries, commentaries, fliers, bulletins, yearbooks, booklets and bibles.

45 – Conducting religious ceremonies; missionary services, namely, the provision of clothing and shoes to needy people [charitable services].

(260) AM 2018 93698 A
 (800) 1358627
 (151) 2017 03 30
 (891) 2017 03 30
 (731) "KONTI-RUS" JOINT STOCK COMPANY
 ul. Zolotaia, 13, RU-305000 Kursk, Russian
 Federation
 (540)



(591) Blue, red, light brown, dark brown,
 white and black
 (531) 03.01.14; 03.01.24; 29.01.14
 (511)
 30 – Pastries and confectionery.

(260) AM 2018 93699 A
 (800) 1358647
 (151) 2017 05 23
 (891) 2017 05 23
 (731) JUKI Central Europe Sp. z o.o.
 ul. Poleczki 21 C, PL-02-822 Warszawa,
 Poland
 (540)

JEUX

(591) Black, white
 (511)
 7 – Sewing machines, including industrial sewing
 and sealing machines; motors and engines (except
 motors for land vehicles).
 9 – Computers and computer software for apparatus
 for the control of sewing machines, in particular in-
 dustrial sewing and sealing machines; electrical in-
 stallations and electrical systems and circuits and
 parts therefor for sewing machines, in particular in-
 dustrial sewing and sealing machines.
 37 – Building construction; repair of agricultural and
 sewing machines; installation of assembly machines
 and production lines.

(260) AM 2018 93700 A
 (800) 1358669
 (151) 2016 10 19
 (891) 2016 10 19
 (731) EURO GAMES TECHNOLOGY LTD.
 "Maritsa" Str. 4, "Vranya-Lozen-Triugulnika",
 BG-1151 Sofia, Bulgaria

(540)



(591) Red and white
 (531) 26.01.24; 26.11.12; 27.05.23
 (511)
 9 – Software; games software; computer software
 packages; computer operating system software; ap-
 plication software; computer software; interfaces for
 computers; software drivers; interactive computer
 software; computer application software; virtual
 reality software; computer software for encryption;
 software programs for video games; software for
 electronic games; computer game software; compu-
 ter software for games; software programs for video
 games; software programmable microprocessors;
 data communications software; software for card
 readers; programmed video games contained on car-
 tridges [software]; entertainment software for com-
 puter games; computer games programmes (soft-
 ware); computer programs for network management;
 computer software that permits games to be played;
 operating computer software for main frame com-
 puters; video games on disc [computer software];
 interactive entertainment software for use with per-
 sonal computers; computer games programs recor-
 ded on disc (software); computer software to en-
 hance the audio-visual capabilities of multimedia ap-
 plications; monitors (computer hardware); computer
 hardware; computer networking hardware; commu-
 nications servers (computer hardware); apparatus for
 recording images; distance recording apparatus; ap-
 paratus for the transmission of images; power-line
 transmission apparatus; apparatus for the transmis-
 sion of sound; portable electronic communication
 and computer equipment for data reception, control,
 storage, handling, display and transmission for ope-
 rating electronic locking devices; replicating appa-
 ratus; monitors (computer programs); computer pro-
 grams for games; recorded computer game programs;
 computer joysticks; interactive multimedia computer
 game programs; computer programs for playing ga-
 mes; video games [computer games] in die form of
 computer programs recorded on data carriers; com-
 puter programmes for interactive television and for
 interactive games and/or quizzes; computer chips;
 chips (integrated circuits); chips (integrated circuits);
 chips for multiprocessors; integrated circuit chips
 with electronic memory.
 28 – Gaming machines for gambling; gambling
 chips; Mah-jong; arcade games; amusement machi-
 nes, operated by inserting coins, notes and cards;
 coin-operated amusement gaming machines; games;
 scratch cards for playing lottery games; electronic

games; parlour games; gaming chips; board games; slot machines [gaming machines]; LCD game machines; slot machines [gaming machines]; coin-operated amusement machines; roulette chips; poker chips; chips and dice (gaming equipment).

41 – Gambling; services related to gambling; gaming services for entertainment purposes; casino, gaming and gambling services; training in the development of software systems; providing gaming house facilities; casino facilities (gambling); gaming machine entertainment services; providing casino facilities [gambling]; amusement arcades; amusement arcade services; games equipment rental; gaming machines rental; providing amusement arcade services; rental of gaming machines with images of fruits; editing or recording of sounds and images; sound recording and video entertainment services; hire of sound reproducing apparatus; providing of casino and gaming facilities.

(260) AM 2018 93701 A
 (800) 1358695
 (151) 2016 12 14
 (891) 2016 12 14
 (731) FULYA KOZMETIK ISLAK MENDIL
 IMALAT VE PAZARLAMA LIMITED
 SIRKETI
 Osman Gazi Mah. Kucuk, Ayazma Cad.
 No:17, Esenyurt, Istanbul, Turkey
 (540)



(591) Black, white
 (531) 27.05.01; 27.05.02
 (511)
 3 – Detergents other than for use in manufacturing operations and for medical purposes, laundry starches, laundry bleaches, soaps, fabric softeners, colour-brightening chemicals for household purposes, perfumes, eau de cologne, lotions for cosmetic purposes, essential oils, deodorants for personal use, rose oils, antiperspirants, after-shave lotions, nail polishes, lipstick, creams, hair dyes, shampoos, hair lotions, hair sprays, hair colorants, hair waving preparations, eyebrow pencils, eyebrow cosmetics, body powder, make-up powder, varnish-removing preparations, mascaras, petroleum jelly for cosmetic purposes, gels for cosmetic purposes, cosmetic preparations for slimming purposes, cosmetic preparations for eyelashes, cosmetic kits, shaving preparations, shaving soaps, cotton wool for cosmetic purposes, tissues impregnated with cosmetic lotions, ear cleaning swabs; wet wipes, disinfectant soap, anti-perspirant soap, toothpastes, mouth washes (not for

medical purposes), emery cloths, emery paper, polish for furniture and flooring.

(260) AM 2018 93702 A
 (800) 1358714
 (151) 2017 02 02
 (891) 2017 02 02
 (731) MULTISOL LIMITED
 Albion House, Rawdon Park, Green Lane,
 Yeadon, Leeds LS19 7XX, United Kingdom
 (540)

NOVAD

(591) Black, white
 (511)
 4 – Industrial oils and greases; mineral lubricating oils; base oils; additives (non-chemical -) for fuels; additives (non-chemical -) for oils; additives (non-chemical -) for lubricants; lubricants; fuels.

(260) AM 2018 93703 A
 (800) 1358716
 (151) 2017 01 25
 (891) 2017 01 25
 (731) Albrecht Jung GmbH & Co. KG
 Volmestraße 1, 58579 Schalksmühle,
 Germany
 (540)

LS 990

(591) Black, white
 (511)
 9 – Electric connectors, in particular electric connection devices, couplings, adapters, electric sockets, plugs, terminals for electric cables; branch boxes (electricity); junction boxes (electricity); antennas; switchboards; alarms and alarm systems; indicators (electric/electronic); covering plates for covering of electro-technical and electronic apparatus for home and building technology; limiters (electricity); computer programs, recorded; computer software (recorded); inductor coils; anti-interference devices (electricity); remote control devices; fire alarms; electric/electronic equipment/apparatus, for house and building technology, connected using wireless and/or cable technology, in particular via an installation bus system, and for transmitting commands to modulate regulating, controlling, checking (supervision), measuring, transmission and recording apparatus and instruments; interfaces, in particular for home automation and building technology; couplers (data processing equipment); optical lamps; light emitting diodes (LEDs); light signalling apparatus, light regulators, in particular dimmers; photometers; regulating, controlling, checking (supervision), measuring, monitoring, switching and recording apparatus and instruments, in particular for home automation and building technology; electric/electronic

switches, in particular installation switches, built-in switches for equipment, toggle switches, rocker switches, rotary switches, press-button switches, touch contacts, pull switches, slide switches and multiple circuit breakers; control consoles and panels (electricity); transmitters of electric and electronic signals; smart cards [integrated circuit cards]; battery chargers; coils (electric and electromagnetic); electronic controls; rectifiers; converters, electric; current relays, in particular for lighting devices; sensors for detecting movements (movement indicators), sounds, brightness, gases, smoke, temperature and other physical variables for home automation and building technology, in particular for the control of lighting, room and building surveillance; electric/electronic transformers; distribution boxes and boards (electricity); time switch apparatus, in particular for controlling electric equipment, lighting devices, blinds, roller blinds.

11 – Lighting apparatus and installations; lighting apparatus utilising light emitting diodes (LEDs); lamps (electric and electronic); light diffusers; protective casings for lighting.

37 – Installation, maintenance and repair of electric apparatus (servicing).

(260) AM 2018 93723 A
(800) 1358973
(151) 2017 07 06
(891) 2017 07 06
(731) BEATS ELECTRONICS, LLC
8600 Hayden Place Culver City CA 90232,
USA

(540)

POWERBEATS

(591) Black and white
(511)
9 – Earphones, audio cables.

(260) AM 2018 93724 A
(800) 1359002
(151) 2016 10 09
(891) 2016 10 09
(731) SANLIUYIDU (FUJIAN) SPORTS GOODS
CO., LTD.
Jiangtou Industrial Zone, Chendai Town,
Jinjiang City 362211 Fujian, China

(540)



(591) Black and white
(531) 26.11.11; 26.13.25; 27.07.01
(511)

18 – Leather, unworked or semi-worked; backpacks; bags for sports; handbags; leather laces; pocket wallets; furniture coverings of leather; umbrellas; canes; harness fittings.

25 – Waterproof clothing; clothing; footwear; shoes; sports shoes; hats; hosiery; gloves [clothing]; scarfs; girdles; wristbands for use in playing sports.

28 – Games; toys; chess games; playing balls; body-building apparatus; machines for physical exercises; swimming pools [play articles]; shin guards [sports articles]; snowshoes; grip tape for rackets.

(260) AM 2018 93725 A
(800) 1359040
(151) 2017 06 15
(891) 2017 06 15
(731) PREVAR LIMITED
507 Eastbourne Street West Hastings
4122, New Zealand

(540)

PIQA

(591) Black and white
(511)
31 – Fresh fruits and vegetables, including apples and pears.

(260) AM 2018 93726 A
(800) 1359059
(151) 2017 06 21
(891) 2017 06 21
(731) AVON PRODUCTS, INC.
601 Midland Avenue Rye NY 10580,
USA

(540)

AVON LUCK LIMITLESS

(591) Black and white
(511)
3 – Non-medicated soaps; perfumery; essential oils; non-medicated cosmetics; non-medicated hair lotions; non-medicated dentifrices.

(260) AM 2018 93727 A
(800) 1359081
(151) 2017 06 07
(891) 2017 06 07
(731) NOVARTIS AG
CH-4002 Basel, Switzerland

(540)

UNIPEXY

(511)

10 – Surgical apparatus and instruments for ophthalmic surgery.

(260) AM 2018 93728 A

(800) 1359121

(151) 2017 03 30

(891) 2017 03 30

(731) "KONTI-RUS" JOINT STOCK COMPANY
ul. Zolotaia, 13 RU-305000 Kursk, Russian
Federation

(540)

(591) Blue, red, light brown, dark brown,
white and black(531) 03.01.14; 03.01.17; 03.01.20; 03.01.24;
29.01.15

(511)

30 – Pastries and confectionery.

(260) AM 2018 93731 A

(800) 1359158

(151) 2017 03 15

(891) 2017 03 15

(731) Jean CASSEGRAIN, Société par actions
Simplifiée
12 rue Saint-Florentin F-75001 PARIS, France

(540)



(591) Black and white

(531) 02.01.20; 02.01.21

(511)

3 – Air fresheners; cosmetics; toiletries; perfumes,
eau-de-toilette; creams for leather, leather bleaching
preparations, shoe polish, shoe cream.4 – Candles, perfumed candles; oils and greases for
shoes and leather.9 – USB flash drives; covers for mobile phones, sle-
eves for laptops; spectacles [optics], sunglasses;
spectacle cases, containers for contact lenses; spec-
tacle frames; carrying cases for computers.14 – Precious metals and their alloys; jewelry, rings
(jewelry); jewelry cases, boxes of precious metal,
watch cases, earrings, cuff links, bracelets, watch
bands; charms, amulets, brooches, chains, key rings
(trinkets or fobs), necklaces, cases for watches, pins
(jewelry), tie pins, tie clips, precious stones; timepi-
eces and chronometric instruments, watches; cases
for timepieces.16 – Printed materials, brochures, posters; desk ac-
cessories, desk pads, letter holders, letter trays; writ-
ing cases (stationery), writing paper, photograph
stands, pencils, pens, pen cases, indexes, note books,
diaries, covers and sleeves for notepads and diaries,
passport and document pouches; holders for check-
books, pencil holders, pen holders; calendars, perio-
dicals, printed publications, books, booklets; packa-
ging, wrapping and storage bags and articles of pa-
per, cardboard and plastic; small bags [envelopes,
pouches] of paper or plastics for packaging; bags
[envelopes, pouches] of paper or plastics, for packa-
ging.18 – Leather and imitations of leather, leather, un-
worked or semi-worked, animal skins, trunks, suit-
cases, walking sticks, leather shoulder straps, leather
goods such as pocket wallets, identity card cases,
purses, billfolds, document cases, key cases, travel-
ing bags, handbags, traveling trunks, boxes intended
for toiletry articles known as "vanity cases", umbre-
llas, briefcases of leather or imitation leather, attaché
cases, sports bags, backpacks, shoulder bags, beach
bags, garment bags for travel; leather pouches; tra-
veling sets; shopping bags, wheeled bags; trinket
baskets of leather.22 – Protective fabric covers for storing handbags
when not in use.25 – Clothing for women, men and children, coats,
gloves (clothing), neckties, scarves, sashes for wear,
stoles, shirts, short-sleeve shirts, overalls, boots,
half-boots, slippers, shoes, hats, caps, belts (clot-
hing), bathing suits (swimsuits).

34 – Smokers' articles.

35 – Advertising; commercial business management;
commercial administration; office functions; retail
sale services, also on the Internet, for articles of
leather or imitation leather, key cases (leatherware),
business card cases (leatherware), credit card cases
and holders (leatherware), handbags, shopping bags,
school bags, bags for climbers, backpacks, shoulder
bags, bags for campers, beach bags, garment bags,
boxes of leather or leather board, evening handbags,
sports bags (other than those designed to contain

products for which they are intended), traveling bags, traveling sets (leatherware), briefcases, pouches of leather for packaging, pocket wallets, purses not of precious metal, purses, school satchels, luggage, trunks and suitcases, umbrellas, walking sticks, clothing for women, men and children, belts (clothing), neckties, gloves (clothing), stoles, scarves, sashes for wear, footwear (other than orthopedic), headgear, jewelry, timepieces and chronometric instruments, watches, stationery, office requisites, printed materials; shop window dressing; organization of fashion shows for promotional purposes; demonstration of goods; distribution of advertising material [leaflets, prospectuses, printed matter, samples]; dissemination of advertising material [leaflets, prospectuses, printed matter, samples]; market study; production of advertising films; computerized file management; commercial information via websites; publication of advertising texts.

(260) AM 2018 93733 A
 (800) 1359167
 (151) 2017 04 07
 (891) 2017 04 07
 (731) Eagle Investment SICAV plc, acting on behalf of ITT FUND
 Alpine House, Naxxar Road SGN 9032
 San Gwann, Malta
 (540)

Slot Ghosts

(591) Black and white
 (511)
 9 – Games software; software programs for video games; interactive video game programs; cartridges for computer games [software]; cartridges for video games [software]; electronic components for gambling machines; games cartridges for use with electronic games apparatus; coin-operated musical automata [juke boxes]; automated teller machines [ATM].

28 – Games; sports games; manipulative games; mechanical games; musical games; electronic games; parlor games; board games; quiz games; apparatus for games; arcade games; skill and action games; electronic hand-held game units; handheld computer games; lottery wheels; lottery tickets; slot machines [gaming machines]; automatic gaming machines; coin-operated amusement machines; bill-operated gaming equipment; LCD game machines; counters for games; amusement apparatus for use in arcades; arcade game machines.

41 – Gambling; operating lotteries; prize draws [lotteries]; organising and conducting lotteries; games equipment rental; casino services; providing casino facilities; leasing of casino games; providing casino facilities [gambling]; providing of casino and gaming facilities; casino, gaming and gambling ser-

vices; providing amusement arcade services; video arcade services.

(260) AM 2018 93734 A
 (800) 1359168
 (151) 2017 04 07
 (891) 2017 04 07
 (731) Eagle Investment SICAV plc, acting on behalf of ITT FUND
 Alpine House, Naxxar Road SGN 9032
 San Gwann, Malta
 (540)

Rich Fish

(591) Black and white
 (511)
 9 – Games software; software programs for video games; interactive video game programs; cartridges for computer games [software]; cartridges for video games [software]; software; educational software; application software; community software; computer telephony software; interactive computer software; communication software; programs for computers; electronic components for gambling machines; games cartridges for use with electronic games apparatus; coin-operated musical automata [juke boxes]; automated teller machines [ATM].

(260) AM 2018 93735 A
 (800) 1359169
 (151) 2017 04 21
 (891) 2017 04 21
 (731) Eagle Investment SICAV plc, acting on behalf of ITT FUND
 Alpine House, Naxxar Road SGN 9032 San Gwann, Malta
 (540)

THUNDER

(591) Black and white
 (511)
 28 – Apparatus for games; lottery wheels; slot machines; automatic gaming machines; coin-operated amusement machines; bill-operated gaming equipment; LCD game machines; counters for games; board games; amusement apparatus for use in arcades.

41 – Gambling; operating lotteries; prize draws; organizing and conducting lotteries; games equipment rental; leasing of casino games; providing of casino and gaming facilities; casino, gaming and gambling services; providing amusement arcade services; video arcade services; gaming machine entertainment services.

(260) AM 2018 93736 A
 (800) 1359170
 (151) 2017 04 21
 (891) 2017 04 21
 (731) Eagle Investment SICAV plc, acting on behalf of ITT FUND
 Alpine House, Naxxar Road SGN 9032
 San Gwann, Malta

(540)

ORCANE

(591) Black and white
 (511)
 28 – Apparatus for games; lottery wheels; slot machines; automatic gaming machines; coin-operated amusement machines; bill-operated gaming equipment; LCD game machines; counters for games; board games; amusement apparatus for use in arcades.
 41 – Gambling; operating lotteries; prize draws; organising and conducting lotteries; games equipment rental; leasing of casino games; providing of casino and gaming facilities; casino, gaming and gambling services; providing amusement arcade services; video arcade services; gaming machine entertainment services.

(260) AM 2018 93737 A
 (800) 1359193
 (151) 2017 02 22
 (891) 2017 02 22
 (731) AMAXA PHARMA LTD
 72 Hammersmith Road London W14 8TH,
 United Kingdom

(540)

NASCAR

(591) Black and white
 (531) 27.05.17
 (511)
 5 – Adjuvants for medical purposes; acaricides; acetonitrile; alkaloids for medical purposes; alginates for pharmaceutical purposes; alginate dietary supplements; algicides; aldehydes for pharmaceutical purposes; amino acids for veterinary purposes; amino acids for medical purposes; analgesics; anaesthetics; antibiotics; appetite suppressants for medical purposes; first-aid boxes, filled; aluminium acetate for pharmaceutical purposes; acetates for pharmaceutical purposes; cotton for medical purposes; tonics [medicines]; germicides; bacterial poisons; bacterial preparations for medical and veterinary use; bacteriological preparations for medical and veterinary use; balms for medical purposes; balsamic preparations for medical purposes; aseptic cotton; tobacco-free cigarettes for medical purposes; bandages for dressings; albumin dietary supplements; albuminous

preparations for medical purposes; albuminous food-stuffs for medical purposes; biological tissue cultures for veterinary purposes; biological tissue cultures for medical purposes; biological preparations for veterinary purposes; biological preparations for medical purposes; biocides; bismuth subnitrate for pharmaceutical purposes; flaxseed meal for pharmaceutical purposes; flour for pharmaceutical purposes; bromine for pharmaceutical purposes; bronchodilating preparations; vaginal washes for medical purposes; petroleum jelly for medical purposes; vaccines; wadding for medical purposes; cotton sticks for medical purposes; absorbent cotton; veterinary preparations; decoctions for pharmaceutical purposes; tartar for pharmaceutical purposes; vitamin preparations; mineral waters for medical purposes; hydrated chloral for pharmaceutical purposes; dietary fiber; charcoal for pharmaceutical purposes; gases for medical purposes; gallic acid for pharmaceutical purposes; guaiacol for pharmaceutical purposes; haematogen; haemoglobin; herbicides, panty liners [sanitary]; menstruation knickers; menstruation bandages; sanitary napkins; menstruation tampons; hydrastine; hydrastinine; mustard for pharmaceutical purposes; mustard oil for medical purposes; mustard plasters; anthelmintics; glycerine for medical purposes; glycerophosphates; glucose for medical purposes; hormones for medical purposes; mud for baths; medicinal mud; rubber for dental purposes; gum for medical purposes; gamboge for medical purposes; gurjun [gurjon, gurjan] balsam for medical purposes; disinfectants; disinfectants for hygiene purposes; disinfectants for chemical toilets; deodorants for clothing and textiles; deodorants, other than for human beings or for animals; detergents for medical purposes; digitalin; infant formula; diagnostic preparations for veterinary purposes; diagnostic preparations for medical purposes, diastase for medical purposes; dietary supplements for animals; glucose dietary supplements; flaxseed dietary supplements; flaxseed oil dietary supplements; royal jelly dietary supplements; pollen dietary supplements; propolis dietary supplements; wheat germ dietary supplements; dietetic beverages adapted for medical purposes; dietetic substances adapted for medical use; dietetic foods adapted for medical purposes; yeast for pharmaceutical purposes; yeast dietary supplements; eucalyptus for pharmaceutical purposes; eucalyptol for pharmaceutical purposes; plant extracts for pharmaceutical purposes; extracts of hops for pharmaceutical purposes; elixirs [pharmaceutical preparations]; esters for pharmaceutical purposes; cellulose esters for pharmaceutical purposes; ethers for pharmaceutical purposes; cellulose ethers for pharmaceutical purposes; gelatine for medical purposes; milking grease; greases for veterinary purposes; greases for medical purposes; jujube, medicated; chewing gum for medical purposes; nervines; sedatives; personal sexual lubricants; dental amalgams; dental

amalgams of gold; dental mastics; dental cements; isotopes for medical purposes; reagent paper for medical or veterinary purposes; insecticides; Irish moss for medical purposes; caustic pencils; caustics for pharmaceutical purposes; iodine for pharmaceutical purposes; alkaline iodides for pharmaceutical purposes; iodides for pharmaceutical purposes; iodoform; casein dietary supplements; calomel; camphor for medical purposes; camphor oil for medical purposes; capsules for medicines; carbolineum [parasiticide]; castor oil for medical purposes; cachou for pharmaceutical purposes; quassia for medical purposes; quebracho for medical purposes; oxygen for medical purposes; acids for pharmaceutical purposes; oxygen baths; bone cement for surgical and orthopaedic purposes; adhesives for dentures; fly catching adhesives; cocaine; collagen for medical purposes; colloidion for pharmaceutical purposes; compresses; condurango bark for medical purposes; angostura bark for medical purposes; cedar wood for use as an insect repellent; mangrove bark for pharmaceutical purposes; barks for pharmaceutical purposes; cinchona for medical purposes; rhubarb roots for pharmaceutical purposes; lint for medical purposes; collyrium; cream of tartar for pharmaceutical purposes; creosote for pharmaceutical purposes; blood for medical purposes; depuratives; haemostatic pencils; styptic preparations; dill oil for medical purposes; croton bark; starch for dietetic or pharmaceutical purposes; cultures of microorganisms for medical or veterinary use; curare; dental lacquer; lactose for pharmaceutical purposes; lecithin for medical purposes; lecithin dietary supplements; fly catching paper; adhesive bands for medical purposes; medicine cases, portable, filled; medicines for alleviating constipation; eyepatches for medical purposes; medical preparations for slimming purposes; drugs for medical purposes; medicines for veterinary purposes; remedies for perspiration; medicines for human purposes; medicines for dental purposes; medicinal roots; medicated animal feed; medicinal tea; medicinal herbs; remedies for foot perspiration; medicinal drinks; medicinal infusions; medicinal oils; medicinal hair growth preparations; liniments; liquorice for pharmaceutical purposes; dog lotions for veterinary purposes; lotions for veterinary purposes; lotions for pharmaceutical purposes; lupulin for pharmaceutical purposes; candy for medical purposes; flaxseed for pharmaceutical purposes; magnesia for pharmaceutical purposes; sunburn ointments; ointments for pharmaceutical purposes; frostbite salve for pharmaceutical purposes; gauze for dressings; teeth filling material; dental impression materials; royal jelly for pharmaceutical purposes; melissa water for pharmaceutical purposes; menthol; almond milk for pharmaceutical purposes; dog washes [insecticides]; animal washes [insecticides]; cattle washes [insecticides]; myrobalan bark for pharmaceutical purposes; mineral food supplements; bunion pads; moleskin

for medical purposes; powdered milk for babies; lacteal flour for babies; milk ferments for pharmaceutical purposes; sea water for medicinal bathing; mint for pharmaceutical purposes; scapulars for surgical purposes; vesicants; narcotics; tincture of iodine; tinctures for medical purposes; fumigation preparations for medical purposes; fumigating pastilles; cachets for pharmaceutical purposes; wart pencils; oil of turpentine for pharmaceutical purposes; opium; opodeldoc; mouthwashes for medical purposes; rat poison; poisons; cooling sprays for medical purposes; air purifying preparations; stick liquorice for pharmaceutical purposes; pants, absorbent, for incontinents; paper for mustard plasters; mothproof paper; parasiticides; lozenges for pharmaceutical purposes; insect repellent incense; pectin for pharmaceutical purposes; babies' diapers [napkins]; diapers for incontinents; pepsins for pharmaceutical purposes; peptones for pharmaceutical purposes; dressings, medical; pearl powder for medical purposes; hydrogen peroxide for medical purposes; pesticides; tanning pills; appetite suppressant pills; slimming pills; antioxidant pills; diapers for pets; babies' diaper-pants; pyrethrum powder; blood plasma; adhesive plasters; breast-nursing pads; nutritional supplements; nutritive substances for microorganisms; bacteriological culture mediums; pomades for medical purposes; powder of cantharides; porcelain for dental prostheses; laxatives; belts for sanitary napkins [towels]; haemorrhoid preparations; preparations for callouses; chilblain preparations; corn remedies; preparations for reducing sexual activity; air deodorising preparations; mothproofing preparations; acne treatment preparations; preparations for destroying dry rot fungus; larvae exterminating preparations; preparations for destroying mice; fly destroying preparations; vermin destroying preparations; slug exterminating preparations; preparations for destroying noxious animals; preparations for the treatment of burns; opotherapy preparations; soil-sterilising preparations; bath preparations for medical purposes; aloe vera preparations for pharmaceutical purposes; preparations of trace elements for human and animal use; preparations of microorganisms for medical or veterinary use; bismuth preparations for pharmaceutical purposes; opiates; preparations to facilitate teething; medicated eye-washes; poultices; chemical conductors for electrocardiograph electrodes; food for babies; by-products of the processing of cereals for dietetic or medical purposes; evacuants; propolis for pharmaceutical purposes; protein dietary supplements; protein supplements for animals; asthmatic tea; febrifuges; chemical contraceptives; antiseptic cotton; antiseptics; corn rings for the feet; antiparasitic collars for animals; antiparasitic preparations; anti-uric preparations; anticryptogamic preparations; leeches for medical purposes; radium for medical purposes; radioactive substances for medical purposes; diagnostic biomarker reagents for medical purposes;

poses; radiological contrast substances for medical purposes; insect repellents; repellents for dogs; digestives for pharmaceutical purposes; fish meal for pharmaceutical purposes; cod liver oil; ergot for pharmaceutical purposes; solutions for contact lenses; solvents for removing adhesive plasters; mercurial ointments; sarsaparilla for medical purposes; Goulard water; suppositories; tissues impregnated with pharmaceutical lotions; serotherapeutic medicines; siccatives [drying agents] for medical purposes; serums; syrups for pharmaceutical purposes; sulfur sticks [disinfectants]; soporifics; bicarbonate of soda for pharmaceutical purposes; bath salts for medical purposes; smelling salts; salts for mineral water baths; potassium salts for medical purposes; mineral water salts; salts for medical purposes; sodium salts for medical purposes; malt for pharmaceutical purposes; malted milk beverages for medical purposes; semen for artificial insemination; medicinal alcohol; alcohol for pharmaceutical purposes; alloys of precious metals for dental purposes; douching preparations for medical purposes; sterilising preparations; steroids; stem cells for veterinary purposes; stem cells for medical purposes; dental abrasives; strychnine; sulfonamides [medicines]; vulnerary sponges; therapeutic preparations for the bath; thermal water; turpentine for pharmaceutical purposes; thymol for pharmaceutical purposes; gentian for pharmaceutical purposes; smoking herbs for medical purposes; herbal teas for medicinal purposes; transplants [living tissues]; tobacco extracts [insecticides]; pharmaceutical preparations; pharmaceutical preparations for treating dandruff; pharmaceutical preparations for skin care; pharmaceutical preparations for treating sunburn; lime-based pharmaceutical preparations; pharmaceuticals; phenol for pharmaceutical purposes; fennel for medical purposes; enzymes for veterinary purposes; enzymes for medical purposes; ferments for pharmaceutical purposes; enzyme dietary supplements; enzyme preparations for veterinary purposes; enzyme preparations for medical purposes; formic aldehyde for pharmaceutical purposes; molding wax for dentists; phosphates for pharmaceutical purposes; fungicides; chemical preparations to treat wheat blight [smut]; chemical preparations for treating phylloxera; chemico-pharmaceutical preparations; chemical preparations for the diagnosis of pregnancy; vine disease treating chemicals; chemical preparations for veterinary purposes; chemical preparations for medical purposes; chemical preparations for pharmaceutical purposes; chemical preparations to treat mildew; chemical reagents for medical or veterinary purposes; quinine for medical purposes; chinoline for medical purposes; surgical implants comprised of living tissues; surgical glues; surgical dressings; diabetic bread adapted for medical use; chloroform; flowers of sulfur for pharmaceutical purposes; cement for animal hooves; candy, me-

dicated; sugar for medical purposes; contact lens cleaning preparations; jalap.

(260) AM 2018 93738 A
 (800) 1359196
 (151) 2017 02 22
 (891) 2017 02 22
 (731) ABSTRAGAN HOLDING LIMITED
 Astra House, Arklow Road London
 SE14 6EB, United Kingdom
 (540)

MEXAJ

(591) Black and white
 (531) 27.05.17
 (511)
 5 – Pharmaceutical and veterinary preparations; sanitary preparations for medical purposes; dietetic food and substances adapted for medical or veterinary use, food for babies; dietary supplements for humans and animals; plasters, materials for dressings; material for stopping teeth, dental wax; disinfectants; preparations for destroying vermin; fungicides, herbicides.

(260) AM 2018 93740 A
 (800) 1359201
 (151) 2017 04 07
 (891) 2017 04 07
 (731) Eagle Investment SICAV plc, acting on behalf of ITT FUND
 Alpine House, Naxxar Road SGN 9032
 San Gwann, Malta
 (540)

PANDORA

(591) Black and white
 (511)
 9 – Games software; software programs for video games; interactive video game programs; cartridges for computer games; cartridges for video games; educational software; community software; computer telephony software; electronic components for gambling machines; games cartridges for use with electronic games apparatus; coin-operated musical automata; automated teller machines.

28 – Games; sports games; manipulative games; mechanical games; musical games; electronic games; board games; quiz games; apparatus for games; arcade games; skill and action games; electronic handheld game units; handheld computer games; lottery wheels; lottery tickets; slot machines; automatic gaming machines; coin-operated amusement machines; bill-operated gaming equipment; LCD game machines; counters for games; amusement apparatus for use in arcades; arcade game machines.

41 – Gambling; operating lotteries; organizing and conducting lotteries; games equipment rental; casino services; providing casino facilities; leasing of casino games; providing of casino and gaming facilities; gaming services; providing amusement arcade services; video arcade services.

(260) AM 2018 93744 A

(800) 1359233

(151) 2017 04 07

(891) 2017 04 07

(731) Eagle Investment SICAV plc, acting on behalf of ITT FUND

Alpine House, Naxxar Road SGN 9032

San Gwann, Malta

(540)

BONUS JOKER

(591) Black and white

(511)

9 – Games software; software programs for video games; interactive video game programs; software cartridges for computer games; software cartridges for video games; software; educational software; application software; community software; computer telephony software; interactive computer software; communication software; programs for computers; electronic components for gambling machines; games cartridges for use with electronic games apparatus; juke boxes; automated teller machines.

28 – Games; sports games; manipulative games; mechanical games; musical games; electronic games; parlor games; board games; quiz games; apparatus for games; arcade games; skill and action games; electronic hand-held game units; handheld computer games; lottery wheels; lottery tickets; slot machines; automatic gaming machines; coin-operated amusement machines; bill-operated gaming equipment; LCD game machines; counters for games; amusement apparatus for use in arcades.

41 – Gambling; operating lotteries; prize draws; organizing and conducting lotteries; games equipment rental; casino services; leasing of casino games; providing of casino and gaming facilities; casino, gaming and gambling services; providing amusement arcade services; video arcade services.

(260) AM 2018 93748 A

(800) 1359290

(151) 2017 04 10

(891) 2017 04 10

(731) Limited Liability Company "Meat processing plant REMIT"

Khudozhestvenny pr-d, 2D, Podolsk

RU-142111 Moscow region, Russian

Federation

(540)



(591) Red, white

(531) 26.04.01; 26.04.05; 26.04.24; 27.05.24; 29.01.12

(511)

29 – Seaweed extracts for food; gelatine; edible fats; anchovy, not live; peanut butter; butter; cocoa butter for food; coconut butter; buttercream; bouillon; preparations for making bouillon; caviar; fruit, preserved; charcuterie; potato chips; sauerkraut; rape oil for food; bouillon concentrates; jams; frozen fruits; soups; raisins; gherkins; vegetables, preserved; vegetables, cooked; vegetables, dried; oils for food; cream [dairy products]; cheese; frosted fruits; croquettes; crustaceans, not live; dates; milk; crayfish, not live; fish fillets; fruit, stewed; fruit jellies; fruit pulp; meat; fish, not live; jellies for food; meat jellies; game, not live; soya beans, preserved, for food; fat-containing mixtures for bread slices; herrings, not live; lobsters, not live; corn oil for food; sesame oil for food; oysters, not live; ham; yogurt; vegetable juices for cooking; meat extracts; kefir [milk beverage]; kumys [kumyss] [milk beverage]; milk beverages, milk predominating; whey; milk products; spiny lobsters, not live; bacon; lentils, preserved; margarine; marmalade; mussels, not live; palm oil for food; nuts, prepared; eggs; liver pâté; onions, preserved; olives, preserved; olive oil for food; pickles; peas, preserved; sausages; salted meats; preparations for making soup; vegetable salads; fruit salads; sardines, not live; salmon, not live; suet for food; tuna, not live; sunflower oil for food; tripe; truffles, preserved; poultry, not live; fruit peel; mushrooms, preserved; coconut oil for food; beans, preserved; liver; fish-based foodstuffs; fruit chips; fruit preserved in alcohol; prawns, not live; fish, preserved; meat, preserved; shrimps, not live; tofu; whipped cream; pork; fish, tinned; fish meal for human consumption; fruits, tinned; meat, tinned; potato fritters; salted fish; vegetables, tinned; potato flakes; fruit purées; berry purées; vegetable purée; toasted laver; fruit-based snack food; soya milk; milk shakes; sunflower seeds, prepared; fish mousses; vegetable mousses; fish roe, prepared; seeds, prepared; preserved garlic; protein milk; linseed oil for culinary purposes; low-fat potato chips; compotes; condensed milk; smetana [sour cream]; ryazhenka [fermented baked milk]; prostokvasha [soured milk]; tomato paste; sea-cucumbers, not live; curd.

(260) AM 2018 93750 A
 (800) 1359920
 (151) 2017 05 19
 (891) 2017 05 19
 (731) MERCK KGAA
 Frankfurter Str. 250, 64293 Darmstadt,
 Germany
 (540)



(591) Black, white
 (531) 26.01.05; 26.11.03; 26.11.12; 27.05.01
 (511)
 5 – Pharmaceutical products; medical and veterinary preparations; hygiene preparations and articles for medical purposes; dietetic preparations and dietetic food supplements.

(260) AM 2018 93751 A
 (800) 1359929
 (151) 2017 05 24
 (891) 2017 05 24
 (731) SHENZHEN DEZHI TRADING CO., LTD.
 Room B605 Building 6, Minle First Area,
 Minzhi Street Office, Longhua New District,
 Shenzhen 518000 Guangdong (CN),
 Switzerland



(591) Black, white
 (531) 26.11.08; 27.05.01
 (511)
 14 – Wristwatches; watch chains; chronographs [watches]; chronometers; watches; alarm clocks; cases for watches [presentation]; clocks; clocks and watches, electri.
 25 – Underwear; clothing; skirts; outerclothing; clothing of leather; footwear; caps [headwear]; socks; scarves.

(260) AM 2018 93752 A
 (800) 1359947
 (151) 2017 05 26
 (891) 2017 05 26
 (731) MITSUI CHEMICALS AGRO, INC.
 1-19-1, Nihonbashi, Chuo-ku, Tokyo
 103-0027, Japan



(531) 27.05.01
 (511)
 5 – Pharmaceutical, veterinary and sanitary preparations; reagent paper for medical purposes; preparations for killing weeds and destroying vermin; insecticides; pesticides; fungicides; germicides; herbicides; fly catching paper; mothproofing paper.

(260) AM 2018 93754 A
 (800) 1359957
 (151) 2017 05 17
 (891) 2017 05 17
 (731) Tovarichtchestvo s ogranitchennoi
 otvetstvennost'iou "GT"
 office 1503, korpus 4"B", BC "Nurly Tau",
 Prospect Al-Farabi, 17 050059 Almaty,
 Kazakhstan



(591) Black, white
 (531) 27.05.17
 (511)
 35 – Advertising; commercial business management; commercial administration; office functions.

41 – Education; training; entertainment; open/covered recreational parks for children, amusement gardens, amusement parks; organization of sporting and cultural activities.

43 – Services for providing food and drink; temporary accommodation.

(260) AM 2018 93758 A
 (800) 1359982
 (151) 2017 03 08
 (891) 2017 03 08
 (731) Dimitar Hristov BALEV
 Blvd. Vitosha No. 137, apt.17, BG-1408
 SOFIA, Bulgaria

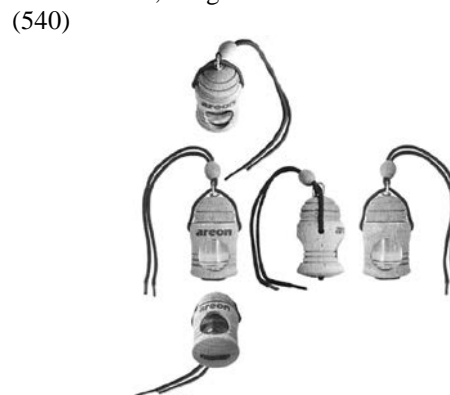

(591) Black, white
 (531) 19.03.01
 (554) Three-dimensional

(511)
3 – Soaps; perfumery; essential oils; aromatics [essential oils]; essential oils for use in air fresheners; ionone [perfumery]; extracts of flowers [perfumes]; potpourris [fragrances]; fragrances for personal use; aromatics for fragrances; air fragrancing preparations; fragrances for household purposes; fragrances for automobiles; automobile cleaners; sachets for perfuming linen; scented wood; scented water; tissues impregnated with cosmetic lotions; cloths impregnated with a detergent for cleaning; bath salts, not for medical purposes.

5 – Salts for mineral water baths; air purifying preparations; car deodorants; deodorants for clothing and textiles; air deodorising preparations; preparations for the neutralising of odours; disposable sanitizing wipes; disposable babies' napkins of cellulose; cleaning cloths impregnated with disinfectant for hygiene purposes; tissues impregnated with antibacterial preparations.

(260) AM 2018 93759 A

(800) 1359992

(151) 2017 04 12

(891) 2017 04 12

(731) COASTROCK HOLDINGS LIMITED

Thasou 3, Dadlaw House, CY-1520 Nicosia, Cyprus

(540)

COOLEMOTION

(591) Black, white

(531) 26.11.08; 27.05.01

(511)

11 – Apparatus for refrigerating; ice boxes; ice machines and apparatus; freezers; coolers for furnaces; refrigerators; fridge; commercial refrigeration equipment; commercial cooling installations for beverages; warehouse cooling installations for beverages; air cooling apparatus; cooling installations for water; cooling installations for liquids; cooling installations for tobacco; cooling installations and machines; milk cooling installations; beverage cooling apparatus; refrigerating apparatus and machines; refrigerating containers; refrigerating chambers, walk-in refrigerators; refrigerating display cabinets; open refrigerating display cabinets; closed refrigerating display cabinets; cooling appliances and installations; refrigerating appliances and installations; refrigerating cabinets; refrigerating cabinets with a glass door; refrigerators with a glass door.

(260) AM 2018 93761 A

(800) 1360010

(151) 2017 03 10

(891) 2017 03 10

(731) ADP GAUSELMANN GMBH

Merkur-Allee 1-15, 32339 Espelkamp, Germany

(540)

Elements of Crime

(591) Black, white

(511)

9 – Scientific, nautical, surveying, photographic, cinematographic, optical, weighing, measuring, signalling, checking (supervision), life-saving and teaching apparatus and instruments; apparatus and instruments for conducting, switching, transforming, accumulating, regulating or controlling electricity; apparatus for recording, transmission or reproduction of sound or images; magnetic data carriers, recording discs; compact discs, DVDs and other digital recording media; cash registers, calculating machines, data processing equipment, computers; computer software; fire-extinguishing apparatus; musical jukeboxes and parts for the aforesaid automatic machines; automatic cash dispensers, automatic money counting and money changing machines; coin-operated mechanisms; computer and video games software; games software for use on any computer platform, including electronic entertainment and games consoles; computer game programs; computer games programs; video games (software); computer games provided through a global computer network or supplied by means of multi-media electronic broadcast or through telecommunications or electronic transmission or via the internet; computer games, leisure and recreational software, video games and computer software, all being provided in the form of storage media; programs for operating electric and electronic apparatus for games, amusement and/or entertainment purposes; automatic lottery machines: computer software for computer games on the internet; online games (software), in particular for online betting games, online prize games, online gambling games, online games of skill and online casino games; computer software in the form of an app for mobile devices and computers; calculating apparatus in coin-operated machines and parts for the aforesaid goods; apparatus for recording, transmission, processing or reproduction of data, including sound or images, including parts for all the aforesaid goods, except radio sets, television receivers, hi-fi systems, video recorders, telephone apparatus, fax machines and telephone answering machines; computer hardware and software for casino and amusement arcade games, for gaming machines, slot machines or video lottery gaming machines or games of chance via the internet; electric, electronic, optical or automatic apparatus, for identifying data carriers, identity cards and credit cards, bank notes and coins; electric, electronic or optical alarm and monitoring installations, including video cameras and apparatus for image transmission and image processing; data processing apparatus and computers, including data processing apparatus and computers

being components for data networks and parts facilitating data network communications; electric wiring harnesses; circuit boards, printed circuit boards (electronic components) and combinations thereof, being assemblies and parts for apparatus, included in this class.

28 – Games; toys; gymnastic and sporting articles not included in other classes; decorations for Christmas trees; gaming apparatus (including coin-operated apparatus); coin-operated arcade games (machines); games for amusement arcades (included in this class); coin-operated video gaming apparatus; video games apparatus adapted for use with external screens or monitors only; casino fittings, namely roulette tables, roulette wheels; coin-operated automatic gaming machines and gaming machines, in particular for gaming arcades, with or without a prize payout; electronic or electrotechnical gaming apparatus, automatic gaming machines, gaming machines, slot machines operated by coins, tokens, banknotes, tickets or by means of electronic, magnetic or biometric storage media, in particular for commercial use in casinos and amusement arcades, with or without a prize payout; automatic gaming machines and gaming machines, in particular for commercial use in casinos and gaming arcades, with or without a prize payout; coin-operated gaming machines and/or electronic money-based gaming apparatus (machines), with or without prizes; housings adapted for gaming machines, gaming apparatus and automatic gaming machines, operated by means of coins, tokens, tickets or by means of electronic, magnetic or biometric storage media, in particular for commercial use in casinos and gaming arcades, with or without a prize payout; electronic games; electronic game entertainment apparatus and parts thereof; video output game machines; drawing apparatus for prize games and lotteries, draws or raffles; housings of metal, plastic and/or wood for coin-operated automatic machines; apparatus for games (including video games), other than adapted for use with external screens or monitors only; electropneumatic and electric slot machines with pulling handles (gaming machines); gaming tables, in particular for table football, billiards, sliding games; flying discs (toys) and darts; gaming machines, namely electric, electronic or electromechanical apparatus for bingo games, lotteries or video lottery games and for betting offices, connected or unconnected to a computer network; LCD games consoles; automatic gaming machines; all the aforesaid automatic gaming machines and apparatus operating in networks; apparatus and devices for accepting and storing money, being fittings for the aforesaid automatic machines, included in this class.

(260) AM 2018 93762 A
(800) 1360024
(151) 2017 05 04

(891) 2017 05 04
(731) IWI AG
Industriestrasse 13-C, CH-6304 Zug,
Switzerland
(540)

Magnolia

(591) Black, white
(511)
3 – Dentifrices.

(260) AM 2018 93764 A
(800) 325516
(151) 1996 11 08
(891) 2017 07 20
(731) KONINKLIJKE GROLSCH N.V.
Brouwerslaan 1, NL-7548 XA ENSCHEDE,
Netherlands
(540)

GROLSCH

(591) Black, white
(511)
32 – Beer.

(260) AM 2018 93765 A
(800) 524247
(151) 1988 05 04
(891) 2017 05 17
(731) HELMUT LANG NEW YORK LLC
615 South Dupont Highway, Dover
Delaware, 19901, USA
(540)

HELMUT LANG

(591) Black, white
(511)
14 – Leather and imitation leather, articles made of these materials not included in other classes; skins, trunks and suitcases; umbrellas, parasols and walking sticks, whips, harness and saddlery.

(260) AM 2018 93773 A
(800) 1096535
(151) 2011 10 03
(891) 2017 06 08
(731) KIRILL VLADIMIROVICH MRACHKO
k. 1, d. 39, ul. Dneprovskaya 220102
Minsk, Belarus

(540)

ONZOIL

(591) Black, white
(511)
1 – Chemicals used in science, photography, agriculture, horticulture and forestry; unprocessed artificial

resins, unprocessed plastics; fertilizing preparations; fire extinguishing compositions; tempering and soldering preparations; chemical substances for preserving foodstuffs; tanning substances; adhesives used in industry; antifreeze; fluids for hydraulic circuits; brake fluid; transmission fluid.

4 – Industrial oils and greases; lubricants; dust absorbing, wetting and binding compositions; fuels (including motor spirit) and illuminants; candles and wicks for lighting; cutting fluids; lubricating oil; industrial oil; moistening oil; motor oil; lubricants.

35 – Advertising; business management; business administration; office functions; marketing studies.

(260) AM 2018 93774 A

(800) 1106615

(151) 2011 08 01

(891) 2017 05 31

(731) PASSO INTERNATIONAL, SIA
Republikas laukums 3-24, LV-1010
Riga, Latvia

(540)



(591) White and violet

(531) 25.03.07; 26.04.04; 26.04.22; 26.04.24;
27.05.24; 29.01.12

(511)

3 – Perfumery, essential oils, cosmetics including hair lotions, hair dyes, creams, tonics, cosmetic oils and waxing wax; massage oils and creams; nail care preparations, nail polish, false nails; sun tanning preparations, namely, suntan accelerating preparations and sun protection preparations.

8 – Manicure and pedicure instruments and their sets; electric manicure and pedicure apparatus and equipment.

10 – Orthopedic articles; pedicure apparatus for medical purposes; vibromassage apparatus; lamps for medical purposes; apparatus for cosmetic massage; physiotherapy apparatus.

20 – Furniture for beauty and hairdressing salons; mirrors.

35 – Retail and whole sale services, including via Internet or via other communications in respect of beauty products including cosmetic preparations, apparatus and instruments, equipment for beauty and hairdressing salons; sales promotion for others; selection and display of goods (except their transportation) for others to enable consumers to view and purchase these goods; procurement services for others.

(260) AM 2018 93776 A

(800) 1292193

(151) 2016 01 13

(891) 2017 07 26

(731) SOPRO

Zone d'Activité Commerciale Athélia IV,
Avenue des Genévriers, F-13705 LA
CIOTAT CEDEX, France

(540)



(591) Black, turquoise

(531) 20.05.07; 26.04.02; 26.04.09; 27.01.01;
27.01.02; 27.03.15; 29.01.13

(511)

9 – Software for merging, processing and back-up of medical images.

(260) AM 2018 93777 A

(800) 1322290

(151) 2016 09 12

(891) 2017 05 22

(731) GIOCHI PREZIOSI S.p.A.

Via Vincenzo Gioberti, 1 I-20123 Milano
(MI), Italy

(540)

GLIMMIES

(591) Black, white

(511)

28 – Toys with light; dolls with light; play sets for minidolls and dolls with light; accessories for dolls and minidolls with lights; none of the aforesaid goods in connection with fashion and fashion accessories for toys and dolls.

(260) AM 2018 93778 A

(800) 1331133

(151) 2016 11 24

(891) 2017 06 12

(731) RIGO TRADING S.A.

Route de Trèves 6 EBBC, Building E,
L-2633 Senningerberg, Luxembourg

(540)

CRASHER

(591) Black, white

(511)

30 – Soft chew candy, fruit bubble gum.

(260) AM 2018 93779 A

(800) 1337910

(151) 2017 01 17

(891) 2017 07 11
 (731) ADP GAUSELMANN GMBH
 Merkur-Allee 1-15, 32339 Espelkamp,
 Germany
 (540)

Odyssee

(591) Black, white
 (511)
 9 – Scientific, nautical, surveying, photographic, cinematographic, optical, weighing, measuring, signalling, checking (supervision), life-saving and teaching apparatus and instruments; apparatus and instruments for conducting, switching, transforming, accumulating, regulating or controlling electricity; apparatus for recording, transmission or reproduction of sound or images; magnetic data carriers, recording discs; compact discs, DVDs and other digital recording media; cash registers, calculating machines, data processing equipment, computers; computer software; fire-extinguishing apparatus; musical jukeboxes and parts for the aforesaid automatic machines; automatic cash dispensers, automatic money counting and money changing machines; coin-operated mechanisms; computer and video games software; games software for use on any computer platform, including electronic entertainment and games consoles; computer game programs; computer games programs; video games (software); computer games provided through a global computer network or supplied by means of multimedia electronic broadcast or through telecommunications or electronic transmission or via the internet; computer games, leisure and recreational software, video games and computer software, all being provided in the form of storage media; programs for operating electric and electronic apparatus for games, amusement and/or entertainment purposes; automatic lottery machines; computer software for computer games on the internet; online games (software), in particular for online betting games, online prize games, online gambling games, online games of skill and online casino games; computer software in the form of an app for mobile devices and computers; calculating apparatus in coin-operated machines and parts for the aforesaid goods; apparatus for recording, transmission, processing or reproduction of data, including sound or images, including parts for all the aforesaid goods, except radio sets, television receivers, hi-fi systems, video recorders, telephone apparatus, fax machines and telephone answering machines; computer hardware and software for casino and amusement arcade games, for gaming machines, slot machines or video lottery gaming machines or games of chance via the internet; electric, electronic, optical or automatic apparatus, for identifying data carriers, identity cards and credit cards, bank notes and coins; electric, electronic or optical alarm and monitoring installations, including video cameras and apparatus for image transmission and image processing; data processing

apparatus and computers, including data processing apparatus and computers being components for data networks and parts facilitating data network communications; electric wiring harnesses; circuit boards, printed board assemblies (electronic components) and combinations thereof being assemblies and equipment parts, included in this class.

(260) AM 2018 93780 A
 (800) 1341962
 (151) 2016 12 19
 (891) 2017 06 06
 (731) GILIO S.R.L.
 Via Privata Cesare Battisti, 2 I-20122
 MILANO, Italy
 (540)

FURRISSIMA

(591) Black, white
 (511)
 18 – Animal skins; curried skins; travelling sets [leatherware]; briefcases; moleskin [imitation of leather]; leather leashes; fur; butts [parts of hides]; furniture coverings of leather; chamois leather, other than for cleaning purposes; clothing for pets; saddlery; key cases; walking sticks; vanity cases, not fitted; trunks [luggage]; bags; bags for sports; purses; handbags; game bags [hunting accessories]; collars for animals; horseshoes; whips; slings for carrying infants; umbrellas; business card cases; credit card cases; pocket wallets; haversacks; bags for campers; riding saddles, luggage tags; valises; suitcases; attaché cases; garment bags for travel; rucksacks.
 25 – Waterproof clothing; clothing of leather; cyclists' clothing; clothing for gymnastics; dresses; bath robes; clothing; bandanas [neckerchiefs]; berets; underwear; boas [necklets]; teddies [undergarments]; braces for clothing [suspenders]; galoshes; footwear; stockings; socks; breeches for wear; albs; shirts; hats; coats; belts [clothing]; money belts [clothing]; collars [clothing]; headgear for wear; layettes [clothing]; bathing suits; masquerade costumes; neckties; panties; headbands [clothing]; pocket squares; ready-made linings [parts of clothing]; scarfs; jackets [clothing]; skirts; aprons [clothing]; gloves [clothing]; mittens; ready-made clothing; leggings [leg warmers]; hosiery; sweaters; muffs [clothing]; pelearines; boxer shorts; underpants; vests; trousers; slippers; ear muffs [clothing]; parkas; furs [clothing]; brassieres; stocking suspenders; sandals; shoes; bath slippers; gymnastic shoes; beach shoes; sports shoes; shawls; sashes for wear; overcoats; slips [undergarments]; boots; fur stoles; soles for footwear; heels; pockets for clothing; tee-shirts; combinations [clothing]; veils [clothing]; dressing gowns; visors [headwear]; wooden shoes.
 35 – Shop window dressing; business management consultancy; demonstration of goods; compilation of

statistics; provision of an on-line marketplace for buyers and sellers of goods and services; business management of hotels; commercial information and advice for consumers [consumer advice shop]; marketing; organization of exhibitions and trade fairs for commercial or advertising purposes; organization of fashion shows for promotional purposes; presentation of goods on communication media, for retail purposes; advertising; public relations; market studies; modelling for advertising or sales promotion; retail or wholesale services for the following goods: animal skins, curried skins, travelling sets [leatherware], briefcases, moleskin [imitation of leather], leather leashes, fur, furniture coverings of leather, chamois leather, other than for cleaning purposes, clothing for pets, saddlery, key cases, walking sticks, vanity cases, not fitted trunks [luggage], bags, bags for sports, purses, handbags, horseshoes, whips, slings for carrying infants, umbrellas, business card cases, credit card cases, pocket wallets, haversacks, bags for campers, riding saddles, luggage tags, valises, suitcases, attaché cases, garment bags for travel, rucksacks, clothing of leather, bath robes, clothing, berets, underwear, boas [necklets], braces for clothing [suspenders], footwear, stockings, socks, breeches for wear, shirts, hats, coats, waistbands [parts of clothing], collars [clothing], headgear for wear, layettes [clothing], bathing suits, masquerade costumes, neckties, headbands [clothing], pocket squares, scarfs, jackets [clothing], skirts, gloves [clothing], ready-made clothing, hosiery, muffs [clothing], vests, trousers, slippers, ear muffs [clothing], parkas, furs [clothing], shoes, bath slippers, gymnastic shoes, sports shoes, shawls, sashes for wear, overcoats, boots, fur stoles, tee-shirts, combinations [clothing], dressing gowns, wooden shoes.

(260) AM 2018 93781 A
 (800) 1342716
 (151) 2016 11 09
 (891) 2017 07 26
 (731) SOPRO Zone d'Activité Commerciale Athélia
 IV, Avenue des Génévriers
 F-13705 LA CIOTAT CEDEX, France

(540)
ISYMORE

(591) Black, white
 (531) 27.05.05
 (511)
 9 – Software (recorded programs) for diagnostic assistance, for medical, dental or veterinary use; software (recorded programs) for merging, processing and storing medical images.

(260) AM 2018 93789 A
 (800) 1359453
 (151) 2017 01 17

(891) 2017 01 17
 (731) GENERAL CONFERENCE CORPORATION
 OF SEVENTH-DAY ADVENTISTS, THE
 12501 Old Columbia Pike, Silver Spring
 MD 20904-6600, USA

(540)



(591) Black, white
 (531) 01.15.05; 20.07.01; 20.07.02; 24.13.01
 (511)

16 – Religious books, magazines, pamphlets, newsletters, brochures, encyclopedias; dictionaries, fliers, bulletins, yearbooks, booklets, all in the field of religion; bibles; and bulletins, books, booklets, magazines, newsletters and pamphlets in the field of health and medical care.

45 – Ministerial services; missionary services, namely, the provision of clothing and shoes to needy people [charitable services].

(260) AM 2018 93793 A
 (800) 1359493
 (151) 2017 05 01
 (891) 2017 05 01
 (731) PARS BEH SHARGH
 Home Appliances Company Unit 5, No.2,
 186 Western St, Between The Second and
 Third Square, of Tehranpars Tehran, Iran
 (Islamic Republic of)

(540)



(591) Blue and black
 (531) 27.05.01; 29.01.12
 (511)
 27 – Wallpaper.

(260) AM 2018 93794 A
 (800) 1359587
 (151) 2017 05 03
 (891) 2017 05 03
 (731) Shanghai Hugong Electric (Group) Co., Ltd
 7177 WaiQingSong Hwy, Qingpu District
 201700 Shanghai, China

(540)



(531) 26.04.12; 26.04.18; 26.04.24; 26.11.12;
27.05.24

(511)

7 – Handling machines, automatic [manipulators]; robots [machines]; cutting machines.

(260) AM 2018 93795 A

(800) 1359635

(151) 2017 01 26

(891) 2017 01 26

(731) EURO GAMES TECHNOLOGY LTD.

Maritsa" Str. 4, "Vranya-Lozen-Triugulnika"
BG-1151 Sofia, Bulgaria

(540)



(591) Brown, yellow, gray, green and black

(531) 24.17.09; 27.05.02; 27.05.03; 29.01.15

(511)

9 – Apparatus for recording, transmission or reproduction of sound or image; computer software, recorded; monitors; computer hardware; computer games.

28 – Games that are not included in other classes; gaming machines operating with coins, banknotes and cards; gaming machines for gambling, adapted for use with external screen or monitor; slot machines, gaming machines.

(260) AM 2018 93796 A

(800) 1359639

(151) 2017 02 10

(891) 2017 02 10

(731) SCA Hygiene Products AB

SE-405 03 Göteborg, Sweden

(540)

SANCELLA

(591) Black, white

(511)

3 – Bleaching preparations; substances for laundry use; detergents; cleaning polishing, scouring and abrasive preparations; skin care products, namely washing creams, cleansing creams, moisturizers, skin lotions, barrier creams, zinc creams, hand-washing substances, soaps, cakes of soap; perfumery,

essential oils; bath oils; shampoos and conditioners; hair gels; after-shave lotions; toothpaste; deodorants; disposable impregnated paper and cotton articles (toiletries) for cleaning, personal sanitary and cosmetic purposes; cotton wool; cotton sticks.

5 – Disposable paper and cotton articles impregnated with pharmaceutical lotions for cleaning and sanitary purposes; breast nursing pads; disposable diapers; diaper pants; disposable diapers, diaper pants and other absorbent articles; nappy liners; sanitary panty liners; tampons; sanitary napkins (towels) and other absorbent articles for sanitary purposes; ointments; diagnostic agents for pharmaceutical use; wound cleansing set composed of medical cleansers for wounds and wound dressings; plasters, dressings, wound dressings, medical strips, bandages for sanitary purposes (and/or medical purposes).

9 – Computer software in digital forms containing information relating to all aspects of health care, personal care, incontinence care and geriatric care; computer software related to the measurement of patterns of urination; apparatus for the transmission of data; data storage devices; data processing equipment and accessories, communication equipment; sensors and detectors; software for analyzing business management and customer services for analyzing traffic and visitor data, consumption and stock levels; software for steering and optimizing operations, software for improvement of quality; software for providing information to customers and staff relating to traffic and visitor data, consumption and stock levels; software in form of apps; computer systems for automatic control of ventilating, air-purifying and air-freshening apparatus and installations, sanitary apparatus and installations, in particular toilets, urinals (sanitary fixtures), wash bowls, hand drying apparatus, towel dispensers, soap dispensers, toilet paper dispensers, aerosol containers.

10 – Orthopedic support dressings and orthopedic bandages and hosiery; medical compression stockings, tights and socks, medical support stockings; casting tapes and bandages for orthopedic purposes; splints for surgical purposes; orthopedic articles; padding material for orthopedic purposes (included in this class).

16 – Paper; paper wipes containing cellulose or not, for wiping, drying, cleaning and polishing; paper products for household, hygienic, sanitary and cosmetic purposes, namely, tissue paper, kitchen rolls, toilet paper, paper handkerchiefs, cellulose wipes, paper handtowels, paper napkins, paper serviettes, paper washcloth, paper towels, paper tissues, babies bibs of paper, face towels of paper, facial tissues of paper; protective covers made of paper, namely, bibs of paper, paper pads for changing nappies; paper table cloths; printing products, namely, colour prints, printed emblems, printed patterns, printed paper

labels, graphic prints; printing paper, fine paper; writing paper, newsprint, paper for books, newspapers, catalogues, magazines and other printed matters; packagings made of paper or plastic; plastic material for packaging of soaps, degreasing agents, detergents; table linen of paper; absorbent paper.

20 – Non-metallic fixed stands and dispensers for products made of paper, such as towels, serviettes, kitchen rolls and toilet rolls; bins, bins for sanitary products.

21 – Household stands (holders), holders, containers and dispensers for paper, paper towels, liquid soap, air fresheners and other household, kitchen and toilet products; cleaning cloths; household and kitchen utensils and containers (not of precious metal or coated therewith).

24 – Woven fabrics and textile goods not included in other classes; bed and table linen, woven and non-woven; bed and table covers, under sheets.

35 – Business information services provided on-line from a computer database or the internet; distribution of samples; systematization of data in databases.

38 – Providing access to a compilation of information from computer databases matter in relation to health care, hygienic care and geriatric care; providing access to a global computer network for the transfer and dissemination of information.

41 – Education; education services relating to personal care, health care and geriatric care; arranging and conducting of educational seminars in relation to personal care, health care and geriatric care.

42 – Industrial analysis and research services in the field of the paper industry including area of paper and cotton products for household, hygienic, sanitary and cosmetic purposes; quality assurance consultancy; advice and analysis relating to improvement of quality in relation to analysis of traffic and visitor data, product consumption and stock levels.

44 – Healthcare; consultancy services relating to health; individualised and group healthcare services provided through planning, organizing and monitoring, the aforementioned services also provided on-line or via the internet; hygienic and beauty care for human beings.

(260) AM 2018 93797 A

(800) 1359644

(151) 2017 02 17

(891) 2017 02 17

(731) GfK SE

Nordwestring 101, 90419 NÜRNBERG,
Germany

(540)

Supercrunch

(591) Black, white

(511)

9 – Electronic databases [software] in the fields of market research, media research, advertising research, business research, retail marketing and sales information, consumer purchase and behaviour research, media audience measurement, media ratings and business and brand consulting, all in downloadable form or recorded on computer media; computer programs used to manage and analyze and prepare reports containing the aforesaid information, all in downloadable form or recorded on computer media for computer as well as computer software programs, database management programs and the respective user's manuals to create, access, view, review, manipulate, categorize, analyze, format, and prepare and print reports from data and information in all the aforesaid databases, all in downloadable form or recorded on computer media.

16 – Printed publications; printed publications in the form of reports and presentations as well as in form of publications in the fields of market research, media research, advertising research, business research, retail marketing and sales information, consumer purchase and behaviour research, media audience measurement, media ratings as well as business and brand consulting.

35 – Market research services; media research services; advertising research services; business research services, namely survey of market research data as well as statistical analysis of data files for market research and advertising [data-mining purposes]; providing marketing information services for retailers; consumer purchase and behaviour research services in the context of market and sales research; media audience measurement [market research]; market analysis for media rating services; business consulting services; brand consultancy in the context of image consultancy for companies; analysis and evaluation of data obtained by conducting business research surveys, polling, opinion studies, studies, analysis and evaluations, and on line survey panels for market and opinion research; conducting market studies on population and product trends and preparing and providing reports based thereon; arranging of commercial and business contacts by planning and conducting business meetings; organization and conducting business meetings for business and advertising purposes on the topics market research, media research, advertising research, business research, retail marketing and sales information, consumer purchase and behaviour research, media audience measurement, media ratings and business and brand consulting.

42 – Application service provider [ASP], namely providing software for use on public or private networks with regard to the areas of market research, media research, advertising research, business re-

search, retail marketing and sales information, consumer purchase and behaviour research, media audience measurement, media ratings and business and brand consulting; rental of database software for creating, accessing, updating, downloading, viewing and processing.

(260) AM 2018 93798 A

(800) 1359665

(151) 2017 03 09

(891) 2017 03 09

(731) ADP GAUSELMANN GMBH

Merkur-Allee 1-15, 32339 Espelkamp,

Germany

(540)

CASH EXPERIENCE

(591) Black, white

(511)

9 – Scientific, nautical, surveying, photographic, cinematographic, optical, weighing, measuring, signalling, checking (supervision), life-saving and teaching apparatus and instruments; apparatus and instruments for conducting, switching, transforming, accumulating, regulating or controlling electricity; apparatus for recording, transmission or reproduction of sound or images; magnetic data carriers, recording discs; compact discs, DVDs and other digital recording media; cash registers, calculating machines, data processing equipment, computers; computer software; fire-extinguishing apparatus; musical jukeboxes and parts for the aforesaid automatic machines; automatic cash dispensers, automatic money counting and money changing machines; coin-operated mechanisms; computer and video games software; games software for use on any computer platform, including electronic entertainment and games consoles; computer game programs; computer games programs; video games (software); computer games provided through a global computer network or supplied by means of multi-media electronic broadcast or through telecommunications or electronic transmission or via the internet; computer games, leisure and recreational software, video games and computer software, all being provided in the form of storage media; programs for operating electric and electronic apparatus for games, amusement and/or entertainment purposes; automatic lottery machines; computer software for computer games on the internet; online games (software), in particular for online betting games, online prize games, online gambling games, online games of skill and online casino games; computer software in the form of an app for mobile devices and computers; calculating apparatus in coin-operated machines and parts for the aforesaid goods; apparatus for recording, transmission, processing or reproduction of data, including sound or images, including parts for all the aforesaid goods, except radio sets, television receivers, hi-fi systems,

video recorders, telephone apparatus, fax machines and telephone answering machines; computer hardware and software for casino and amusement arcade games, for gaming machines, slot machines or video lottery gaming machines or games of chance via the internet; electric, electronic, optical or automatic apparatus, for identifying data carriers, identity cards and credit cards, bank notes and coins; electric, electronic or optical alarm and monitoring installations, including video cameras and apparatus for image transmission and image processing; data processing apparatus and computers, including data processing apparatus and computers being components for data networks and parts facilitating data network communications; electric wiring harnesses; circuit boards, printed circuit boards (electronic components) and combinations thereof, being assemblies and parts for apparatus, included in this class.

28 – Games; toys; gymnastic and sporting articles not included in other classes; decorations for christmas trees; gaming apparatus (including coin-operated apparatus); coin-operated arcade games (machines); games for amusement arcades (included in this class); coin-operated video gaming apparatus; video games apparatus adapted for use with external screens or monitors only; casino fittings, namely roulette tables, roulette wheels; coin-operated automatic gaming machines and gaming machines, in particular for gaming arcades, with or without a prize payout; electronic or electrotechnical gaming apparatus, automatic gaming machines, gaming machines, slot machines operated by coins, tokens, banknotes, tickets or by means of electronic, magnetic or biometric storage media, in particular for commercial use in casinos and amusement arcades, with or without a prize payout; automatic gaming machines and gaming machines, in particular for commercial use in casinos and gaming arcades, with or without a prize payout; coin-operated gaming machines and/or electronic money-based gaming apparatus (machines), with or without prizes; housings adapted for gaming machines, gaming apparatus and automatic gaming machines, operated by means of coins, tokens, tickets or by means of electronic, magnetic or biometric storage media, in particular for commercial use in casinos and gaming arcades, with or without a prize payout; electronic games; electronic game entertainment apparatus and parts thereof; video output game machines; drawing apparatus for prize games and lotteries, draws or raffles; housings of metal, plastic and/or wood for coin-operated automatic machines; apparatus for games (including video games), other than adapted for use with external screens or monitors only; electropneumatic and electric slot machines with pulling handles (gaming machines); gaming tables, in particular for table football, billiards, sliding games; flying discs (toys) and darts; gaming machines, namely electric, electronic or electromechanical apparatus for bingo ga-

mes, lotteries or video lottery games and for betting offices, connected or unconnected to a computer network; LCD games consoles; automatic gaming machines; all the aforesaid automatic gaming machines and apparatus operating in networks; apparatus and devices for accepting and storing money, being fittings for the aforesaid automatic machines, included in this class.

(260) AM 2018 93799 A

(800) 1359667

(151) 2017 03 16

(891) 2017 03 16

(731) HEILAN HOME CLOTHING CO., LTD.
NO.8, HUAXING ROAD), HUASHI TOWN
INDUSTRIAL ZONE, JIANGYIN CITY,
JIANGSU PROVINCE, China

(540)

HLA

(591) Black, white

(531) 27.05.17; 27.05.23

(511)

24 – Textile material; non-woven textile fabrics; wall hangings of textile; tapestry [wall hangings], of textile; printers' blankets of textile; towels of textile; bed covers; diaper changing cloths for babies; sheets [textile]; table linen, not of paper; door curtains; fitted toilet lid covers of fabric; marabouts [cloth]; hada (a long piece of silk used as a greeting gift among the Tibetan and Mongol nationalities); banners; shrouds.

35 – Advertising; publicity; presentation of goods on communication media, for retail purposes; business management of hotels; commercial administration of the licensing of the goods and services of others; organization of exhibitions for commercial or advertising purposes; providing business information via a web site; business management assistance; commercial information agencies; marketing; sales promotion for others; employment agencies; relocation services for businesses; photocopying services; business auditing; rental of vending machines; sponsorship search; rental of sales stands; retail or wholesale services for pharmaceutical, veterinary and sanitary preparations and medical supplies.

37 – Building construction supervision; construction; residential and commercial building construction; mining extraction; upholstering; burner maintenance and repair; kitchen equipment installation; repair of sanitary installations; vehicle service stations [refuelling and maintenance]; shipbuilding; photographic apparatus repair; clock and watch repair; safe maintenance and repair; paint spraying; retreading of tires; dry cleaning; disinfecting; lift

installation and repair; repair of sports equipment; restoration of works of art; jewelry repair; shoe repair; furniture restoration; window cleaning.

45 – Security consultancy; clothing rental; embalming services; dating services; rental of fire extinguishers; adoption agency services; opening of security locks; lost property return; planning and arranging of wedding ceremonies; rental of safes; releasing doves for special occasions; intellectual property consultancy.

(260) AM 2018 93800 A

(800) 1359710

(151) 2017 05 04

(891) 2017 05 04

(731) CCC S.A.

ul. Strefowa 6, PL-59-101 Polkowice, Poland

(540)

Sprandi



(591) Black, white

(531) 26.03.23

(511)

18 – Leather and imitations of leather, and goods made of these materials and not included in other classes; animal skins, hides; trunks and travelling bags; hand bags; umbrellas, parasols and walking sticks; whips, harness and saddlery.

25 – Clothing, footwear, headgear.

(260) AM 2018 93801 A

(800) 1359717

(151) 2017 05 09

(891) 2017 05 09

(731) BEIERSDORF AG

Unnastrasse 48, 20253 Hamburg, Germany

(540)

MicellAIR
SKIN BREATHE

(591) Blue

(531) 27.05.10; 29.01.04

(511)

3 – Cosmetic skin care and skin cleansing preparations.

(260) AM 2018 93803 A

(800) 1359743

(151) 2017 05 04

(891) 2017 05 04

(731) Obshchestvo s ogranichennoy
otvetstvennostyu "ZEKKERT"
7-ya liniya V. O., d. 76, lit. A, RU-199178
Saint Petersburg, Russian Federation

(540)



(591) White, blue.

(531) 26.04.18; 26.13.25; 27.05.09; 27.05.10;
27.05.17; 27.05.22; 29.01.04

(511)

7 – Machines and machine tools; motors and engines (except for land vehicles); machine coupling and transmission components (except for land vehicles); agricultural implements other than hand-operated; incubators for eggs; automatic vending machines.
9 – Accumulators, electric, for vehicles; coils, electric; wires, electric; thermostats for vehicles.

11 – Lamps for directional signals of automobiles; light bulbs for directional signals for vehicles; headlights for automobiles; vehicle headlights; lights for automobiles; lights for vehicles.

12 – Vehicles; apparatus for locomotion by land, water and air.

35 – Advertising; business management; business administration; office functions.

(260) AM 2018 93805 A

(800) 1359777

(151) 2017 05 26

(891) 2017 05 26

(731) Zakrytoe aktsionerное obshchestvo
"PENZASPETSAVTOMASH"
ul. Minskaya, 13-74, RU-440047 Penza,
Russian Federation

(540)

Benza

(591) Black, white

(531) 27.05.17

(511)

6 – Tanks of metal; containers of metal for liquid fuel; containers of metal [storage, transport].

7 – Mufflers for motors and engines; brake pads, other than for vehicles; compressors [machines]; machine wheelwork; exhaust manifold for engines; reduction gears, other than for land vehicles; propulsion mechanisms, other than for land vehicles; pumps [machines]; pumps [parts of machines, engines or motors]; vacuum pumps [machines]; compressed air pumps; pumps for heating installations; lubricating pumps; centrifugal pumps.

11 – Oil-scrubbing apparatus; air filters for household purposes; air filters for industrial installations.

(260) AM 2018 93807 A

(800) 1359859

(151) 2017 02 13

(891) 2017 02 13

(731) ULF

Zone d'Activités "Les Doucettes", 1 Avenue
des Morillons F-95140 GARGES LES
GONESSE, France

(540)

ARTLOVE

(591) Black, white

(531) 27.05.05

(511)

14 – Jewelry; jewelry products, precious stones; timepieces and chronometric instruments; precious metals and their alloys; works of art of precious metal; jewelry cases [caskets]; boxes of precious metal; watch cases, straps, chains, springs or glasses; key rings [trinkets or fobs]; statues or figurines (statuettes) of precious metals; cases or presentation cases for timepieces; medals.

18 – Leather and imitations of leather; animal skins; trunks and suitcases; umbrellas, parasols and walking sticks; whips, harness and saddlery; wallets; purses (coin purses); credit card cases (wallets); bags; vanity cases (empty); collars or clothing for animals; net bags for shopping.

25 – Clothing, footwear, headgear; shirts; clothing of leather or imitation of leather; belts (clothing); furs (clothing); gloves (clothing); scarves; neckties; hosiery; socks; bedroom slippers; beach, ski or sports footwear; underwear.

(260) AM 2018 93808 A

(800) 1359870

(151) 2017 05 26

(891) 2017 05 26

(731) Compagnie des Montres Longines, Francillon
S.A. (Longines Watch Co., Francillon Ltd)
CH-2610 Saint-Imier, Switzerland

(540)

ELEGANCE IS AN ATTITUDE

(591) Black, white

(511)

14 – Precious metals and their alloys; jewelry, precious and semi-precious stones; timepieces and chronometric instruments.

35 – Advertising; commercial business management; commercial administration; office functions.

(260) AM 2018 93812 A

(800) 1360823

(151) 2017 05 29

(891) 2017 05 29
 (731) MERİDYEN GIDA SANAYİ VE TİCARET
 LİMİTED ŞİRKETİ
 Maltepe Mah. Ali Rıza Gürcan Cad. No:1,
 Meridyen İş Merkezi, Kat:4 No:427
 Zeytinburnu, stanbul (TR), Turkey

(540)



(591) White, light brown, dark brown
 (531) 01.15.19; 05.07.01; 26.13.01; 27.05.24;
 29.01.13

(511)
 30 – Coffee, cocoa; coffee or cocoa based beverages,
 chocolate based beverages.

(260) AM 2018 93813 A
 (800) 1360846
 (151) 2017 04 14
 (891) 2017 04 14
 (731) Zakrytoe aktsionernoie obshchestvo
 "PharmFirma "SOTEX"
 d. 11, pos. Belikovo, selskoe, poselenie
 Bereznyakovskoe, Sergievo-Posadsky,
 municipalny rayon, RU-141345 Moscovskaya
 obl., Russian Federation

(540)

HEМУЛЕК
NEMULEX

(591) Black, white
 (531) 27.05.17; 28.05
 (511)
 5 – Pharmaceutical and veterinary preparations; sa-
 nitary preparations for medical purposes; dietetic
 substances adapted for medical use, food for babies;
 plasters, materials for dressings; material for stop-
 ping teeth, dental wax; disinfectants; preparations
 for destroying vermin; fungicides, herbicides.

(260) AM 2018 93816 A
 (800) 1360866
 (151) 2017 06 28
 (891) 2017 06 28

(731) JANSSEN PHARMACEUTICA NV
 Turnhoutseweg 30, B-2340 BEERSE,
 Belgium

(540)

IMTILSTA

(511)
 5 – Human pharmaceutical preparations.

(260) AM 2018 93821 A
 (800) 1360068
 (151) 2017 01 11
 (891) 2017 01 11
 (731) ZENITH GLOBAL MANAGEMENT
 LLC.
 P.O.Box 590, Horsfords Business Centre,
 Long Point Road, Charlestown Nevis, West
 Indies, Saint Kitts and Nevis

(540)



(591) Black, white and green.
 (531) 27.05.17; 27.05.21; 29.01.13
 (511)

41 – Teaching; providing of training; entertainment
 services; sporting and cultural activities; modelling
 for artists; academies [education]; rental of sports
 grounds; rental of tennis courts; lending library ser-
 vices; booking of seats for shows; videotaping; phy-
 sical education; production of music; discotheque
 services; animal training; dubbing; gambling servi-
 ces; publication of books; education information;
 recreation information; entertainment information;
 movie studio services; health club services [health
 and fitness training]; nightclub services [entertain-
 ment]; layout services, other than for advertising
 purposes; microfilming; videotape editing; produc-
 tion of radio and television programmes; screenplay
 writing; game services provided on-line from a com-
 puter network; providing on-line electronic publica-
 tions, not downloadable; religious education; gym-
 nastic instruction; correspondence courses; practical
 training [demonstration]; organization of balls; orga-
 nization of exhibitions for cultural or educational
 purposes; providing recreation facilities; arranging
 and conducting of colloquiums; arranging and con-
 ducting of congresses; arranging and conducting of
 conferences; arranging and conducting of concerts;
 arranging and conducting of workshops [training];
 arranging and conducting of in-person educational
 forums; arranging and conducting of seminars; ar-
 ranging and conducting of symposiums; arranging of
 beauty contests; organization of competitions [edu-
 cation or entertainment]; organization of lotteries;

organization of fashion shows for entertainment purposes; organization of shows [impresario services]; organization of sports competitions; vocational guidance [education or training advice]; amusement park services; sign language interpretation; television entertainment; mobile library services; vocational retraining; providing on-line videos, not downloadable; providing on-line music, not downloadable; providing golf facilities; providing sports facilities; providing amusement arcade services; cinema presentations; presentation of circus performances; presentation of variety shows; presentation of live performances; theatre productions; conducting fitness classes; educational examination; timing of sports events; film production, other than advertising films; rental of audio equipment; rental of video cameras; rental of video cassette recorders; rental of videotapes; rental of show scenery; rental of sound recordings; toy rental; rental of cinematographic apparatus; rental of motion pictures; games equipment rental; rental of stadium facilities; rental of lighting apparatus for theatrical sets or television studios; rental of radio and television sets; rental of skin diving equipment; rental of sports equipment, except vehicles; rental of stage scenery; electronic desktop publishing; on-line publication of electronic books and journals; publication of texts, other than publicity texts; radio entertainment; entertainer services; writing of texts; zoological garden services; news reporters services; party planning [entertainment]; music composition services; subtitling; tutoring; holiday camp services [entertainment]; conducting guided tours; disc jockey services; personal trainer services [fitness training]; providing casino facilities [gambling]; calligraphy services; karaoke services; club services [entertainment or education]; songwriting; providing museum facilities [presentation, exhibitions]; orchestra services; translation; scriptwriting, other than for advertising purposes; ticket agency services [entertainment]; coaching [training]; sport camp services; recording studio services; language interpreter services; services of schools [education]; nursery schools; photography; photographic reporting; boarding school education; production of shows.

(260) AM 2018 93823 A

(800) 1360101

(151) 2017 03 24

(891) 2017 03 24

(731) ONOFF TELECOM

26 BOULEVARD DE BONNE-NOUVELLE,
F-75010 PARIS, France

(540)



(591) Blue

(531) 14.05.19; 26.01.05; 27.05.17; 29.01.12

(511)

9 – Downloadable software for communications via voice over Internet protocol (VOIP) and for telecommunications via voice over mobile telephony networks and private branch exchange (PBX); Internet messaging and instant messaging software for use in short messaging services (SMS) and multimedia messaging services (MMS); computer software, namely, software for the transmission, recording, reproducing, displaying, organizing, managing, manipulating and reviewing of messages, texts, images, files, contacts, audio, video and audio-visual content and other data for the facilitation of communications between two or more users via computer networks, mobile telecommunications networks and the global computer network; software for use as application programming interfaces (APIs); wireless devices for communications, namely, telephones, handsets, headsets, loudspeakers, microphones, earphones, Webcams and video cameras; application software for mobile phones, portable computers, namely, for sending digital photographs, video, images and texts to others via the global computer network; programs for personal information management and data synchronization for establishing telephone communication integrated with electric, mobile and computer communications global information networks; database management software, character recognition, management of telephony, electronic messaging and mail, mobile radio paging, mobile telephony; software for the redirection of messages, voice calls, e-mail over the Internet, and/or other data to one or several portable electronic devices from a database stored on or associated with a personal computer or a server; software for the synchronization of data between a mobile telephone and a remote land-line or mobile handset of the gateway type; telephones; mobile, portable and digital electronic devices for the sending and receiving of telephone calls, faxes, electronic mail, and other digital data; cordless telephones; facsimile machines, answering machines, photographic apparatus, videophones, telephone-based information retrieval software and hardware; portable electronic units for receiving, storing and/or wirelessly transmitting data and messages, and electronic devices that enable the user to keep track of or manage personal information from their mobile telephone; loudspeakers, multiple speaker systems, microphones; digital audio and video devices; digital audio tape recorders and players.

(260) AM 2018 93824 A

(800) 1360110

(151) 2017 06 02

(891) 2017 06 02

(731) AOT HOLDING LTD

Grafenauweg 4, CH-6300 Zug, Switzerland

(540)

AOT ENERGY

(591) Black, white

(511)

4 – Industrial oils and greases; lubricants; dust absorbing, wetting and binding compositions; fuels (including motor spirit) and illuminants; candles and wicks for lighting.

39 – Transport; packaging and storage of merchandise; travel organization.

(260) AM 2018 93825 A

(800) 1360867

(151) 2017 06 28

(891) 2017 06 28

(731) JANSSEN PHARMACEUTICA NV
Turnhoutseweg 30, B-2340 BEERSE (BE),
Belgium

(540)

TELPREXI

(591) Black, white

(511)

5 – Human pharmaceutical preparations.

(260) AM 2018 93849 A

(800) 1360996

(151) 2017 04 07

(891) 2017 04 07

(731) Eagle Investment SICAV plc, acting on behalf
of ITT FUND
Alpine House, Naxxar Road San Gwann SGN
9032, Malta

(540)

Slot Birds

(591) Black, white

(511)

9 – Games software; software programs for video games; interactive video game programs; software cartridges for software; application telephony software; communication software; components for gambling with electronic games cartridges for computer games; video games software; educational software; groupware; computer Interactive computer software; programs for computers; electronic machines; games cartridges for use apparatus; coin-operated musical automata; automated teller machines.

28 – Games; sports games; manipulative games; mechanical games; musical games; electronic games; parlor games; board games; quiz games; apparatus for games; arcade games; skill and action games; electronic hand-held game units; handheld computer games; lottery wheels; lottery tickets; slot machines; automatic gaming machines; coin-operated amusement machines; bill-operated gaming equipment;

LCD game machines; counters for games; amusement apparatus for use in arcades; arcade game machines.

41 – Gambling; operating lotteries; organizing and conducting lotteries; games equipment rental; casino services; providing casino facilities; leasing of casino games; providing of casino and gaming facilities; gaming services; providing amusement arcade services; video arcade services.

(260) AM 2018 93850 A

(800) 1361051

(151) 2017 06 15

(891) 2017 06 15

(731) ALKERMES PHARMA IRELAND
LIMITED
Connaught House, 1 Burlington Road,
Dublin 4, Ireland

(540)

ELUMIDOR

(591) Black, white

(511)

5 – Pharmaceutical preparations for the treatment of diseases mediated by an opioid receptor, namely, major depressive disorder, chronic depression, severe unipolar recurrent major depressive episodes, dysthymic disorder, depressive neurosis and neurotic depression, melancholic depression, atypical depression, reactive depression, treatment resistant depression, seasonal affective disorder and pediatric depression, premenstrual syndrome, premenstrual dysphoric disorder, hot flashes, bipolar disorders or manic depression, bipolar I disorder, bipolar II disorder and cyclothymic disorder, anxiety, post-traumatic stress disorder, obsessive compulsive disorder and borderline personality disorder.

(260) AM 2018 93851 A

(800) 1361074

(151) 2017 05 26

(891) 2017 05 26

(731) EGIS Gyógyszergyár Zrt.
Keresztúri út 30-38, H-1106 Budapest,
Hungary

(540)

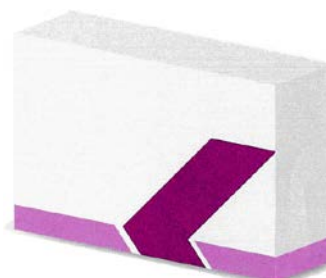

(591) Dark fuchsia purple Pantone 2405 and white

(531) 26.03.23; 26.15.11; 29.01.12

(554) Three-dimensional
(511)
5 – Pharmaceutical preparations for human use.

(260) AM 2018 93853 A
(800) 1361106
(151) 2017 05 06
(891) 2017 05 06
(731) CELGENE CORPORATION
86 Morris Avenue, Summit NJ 07901, USA
(540)

HUMAGINE

(591) Black, white
(511)
5 – Pharmaceutical preparations for the treatment of cancer and associated dermatological and immune disorders.

35 – Business administration of patient reimbursement programs; business administration of pharmacy reimbursement programs and services.

41 – Providing educational and training services, namely, conducting classes, seminars and workshops in the field of cancer and associated dermatological and immune related disorders; educational services, namely, conducting live and online training in the field of treatment of cancer and associated dermatological and immune related disorders; education services, namely, providing on-line classes, seminars and workshops in the field of cancer and associated dermatological and immune related disorders; arranging and conducting of lectures in the field of cancer and associated dermatological and immune related disorders; organizing events for educational purposes in the field of pharmaceutical and medical products; providing on-line non-downloadable electronic publications, namely, books, booklets, brochures, papers, periodical publications, magazines, newspapers and newsletters, leaflets, and instructional and teaching materials in the field of cancer and associated dermatological and immune related disorders; publication of electronic books, booklets, brochures, papers, periodical publications, magazines, newspapers and newsletters, leaflets, and instructional and teaching materials online in the field of cancer and associated dermatological, and immune related disorders; providing online educational games in the field of cancer and associated dermatological and immune related disorders and the treatment thereof.

42 – Development of pharmaceutical preparations and medicines; pharmaceutical research services; medical research services in the field of cancer and associated dermatological and immune related disorders; conducting clinical trials for pharmaceutical products in the field of cancer and associated dermatological and immune related disorders; providing information about the results of clinical trials for

pharmaceutical products; providing temporary use of online non-downloadable software applications containing information on the use of pharmaceutical products and for calculating use of medicine.

44 – Providing medical information, consultancy and advisory services in the field of health; medical and pharmaceutical consultation; pharmaceutical advice; providing information relating to diagnostic, prophylactic and therapeutic properties of pharmaceuticals; medical counseling; medical services, namely, medical care in the field of cancer and associated dermatological and immune related disorders; planning of medical treatment programs for the treatment of cancer and associated dermatological and immune related disorders; providing information and advice in the fields of cancer and associated dermatological and immune related disorders; providing medical information via a website.

45 – Personal and social services rendered by others to meet the needs of individuals, namely, providing non-therapeutic emotional counseling and emotional support to patients and families of patients, and providing information to relatives on how to provide emotional support to patients and families of patients.

(260) AM 2018 93854 A
(800) 430881
(151) 1977 03 25
(891) 2017 07 21
(731) CARLOS FUSTE SENALLE
Calle Principe de Asturias, 5, 5o, 1a, E-08012
BARCELONA, Spain
(540)

SADIRA

(591) Black, white
(511)
1 – Chemical products for use in industry, science, photography, agriculture, horticulture and forestry; artificial and synthetic resins, unprocessed plastics (in powder, liquid or paste form); soil fertilizers (natural and artificial); fire extinguishing compositions; chemical preparations for tempering and soldering; chemical substances for preserving foodstuffs; tanning materials; adhesive substances for industrial use; particularly products for waterproofing and preserving ammunition from moisture, as well as preparations for softening metals.

2 – Paints, varnishes, lacquers; anti-oxidant preservatives and preservatives against the deterioration of wood; coloring materials; mordants; natural varnishes, metals in foil and powder form for painters and decorators; anti-corrosive products, preservatives against rust and protective products for metals.

3 – Products for shining, for softening, polishing, degreasing, cleaning and for deoxidation.

(260) AM 2018 93855 A
(800) 817443
(151) 2003 12 17
(891) 2017 08 01
(731) VIEGA HOLDING GMBH & CO. KG
Viega Platz 1, 57439 Attendorn, Germany
(540)

Viega

(591) Black, white
(511)
7 – Powered handtools.
8 – Handtools, all goods for installation activities.

(260) AM 2018 93856 A
(800) 905107
(151) 2006 11 08
(891) 2017 06 01
(731) AZAD Pharmaceutical Ingredients AG
Durachweg 15, CH-8200 Schaffhausen,
Switzerland
(540)

AZAD

(591) Black, white
(511)
5 – Pharmaceutical and veterinary products; sanitary preparations for medical purposes; dietetic substances adapted for medical use; adjuvants for medical purposes; amino acids for medical purposes; anaesthetics; analgesics; vermifuges; antibiotics; barks for pharmaceutical purposes; biological preparations for medical purposes; chemical preparations for pharmaceutical purposes; chemical reagents for medical or veterinary purposes; chemical-pharmaceutical preparations; ferments for pharmaceutical purposes; hormones for medical purposes; medicinal infusions; medicines for dental purposes; medicines for human purposes; pharmaceutical preparations; pills for pharmaceutical purposes; radiological contrast substances for medical purposes; steroids.

39 – Transport; packaging and storage of goods.

40 – Treatment of materials.

42 – Scientific and technological services and related research and design services; industrial analysis and research services; design and development of computers and software; legal services; biological research; chemical analysis; chemical research; chemistry services; intellectual property consultancy; granting of intellectual property licenses; quality control; research and development of new products for third parties.

44 – Medical services; veterinary services; hygienic and beauty care for human beings or animals; pharmacy advice.

(260) AM 2018 93860 A
(800) 1048219
(151) 2010 07 08
(891) 2017 06 14
(731) SEED CO., LTD.
40-2, Hongo 2-chome, Bunkyo-ku, Tokyo
113-0033, Japan
(540)

SEED

(591) Black, white
(531) 27.05.17
(511)
9 – Contact lenses, cases and containers for contact lenses.

(260) AM 2018 93861 A
(800) 1159901
(151) 2013 04 22
(891) 2017 07 28
(731) TEELING WHISKEY COMPANY LIMITED
13-17 Newmarket, Dublin 8, Ireland
(540)

TEELING

(591) Black, white
(511)
33 – Alcoholic beverages; whiskey.

(260) AM 2018 93862 A
(800) 1198689
(151) 2013 12 09
(891) 2017 05 05
(731) APPLE INC.
1 Infinite Loop, Cupertino CA 95014, USA
(540)

ICLOUD KEYCHAIN

(591) Black, white
(511)
42 – Electronic data storage services; cloud computing services; computer software services, namely creating, storing, and encrypting data and text; computer software services, namely storing and transmitting data and text.

(260) AM 2018 93863 A
(800) 1212690
(151) 2014 03 10
(891) 2017 05 09
(731) MARLÙ S.P.A.
Via M. Bucci, 55, 47895 Domagnano, San Marino

(540)

MARLÛ

(591) Black, white

(511)

14 – Precious metals and their alloys and products in these materials or coated not included in other classes; trinket; jewellery; precious stones; horological instruments; key rings.

(260) AM 2018 93864 A

(800) 1234548

(151) 2014 05 14

(891) 2017 04 20

(731) POLEN UN VE GIDA KATKI MADDELERİ SANAYİ VE TİCARET ANONİM ŞİRKETİ
Osmangazi Mahallesi 3142, Sokak No:15,
Esenyurt İstanbul , Turkey

(540)

VIZYON

(591) Black, white

(531) 27.05.17

(511)

29 – Preserved, frozen, dried and cooked fruits and vegetables; dried legumes; soup mixes; prepared nuts, processed nuts; jellies.

30 – Coffee, cocoa and artificial coffee; rice; tapioca and sago; flour and preparations made from cereals; sugar, honey; yeast, baking powder; salt; mustard; vinegar, sauces (condiments); spices; ice; pudding.

(260) AM 2018 93865 A

(800) 1299446

(151) 2016 04 15

(891) 2017 06 29

(731) CASEN RECORDATI, S.L.
Autovía Logroño, Km. 13,30,0 E-50180
UTEBO (Zaragoza), Spain

(540)

CITRAFLEET

(591) Black, white

(511)

5 – Pharmaceutical and veterinary preparations; sanitary preparations for medical purposes; dietetic substances adapted for medical use, food for babies; plasters, materials for dressings; material for stopping teeth, dental wax; disinfectants; preparations for destroying vermin; fungicides, herbicides laxatives, enemas, bowel cleansing preparations, and solutions for treatment of constipation and gastrointestinal disturbances.

(260) AM 2018 93866 A

(800) 1300278

(151) 2016 02 25

(891) 2017 08 01

(731) DAIICHI SANKYO COMPANY, LIMITED
3-5-1, Nihonbashi Honcho, Chuo-ku, Tokyo
103-8426, Japan

(540)

Vanflyta

(591) Black, white

(531) 27.05.17

(511)

5 – Pharmaceutical preparations and substances; medicines for human purposes.

(260) AM 2018 93867 A

(800) 1305848

(151) 2015 12 28

(891) 2017 05 19

(731) SHISEIDO AMERICAS CORPORATION
301 Route 17 North, 10th Floor, Rutherford
NJ 07070, USA

(540)

NARS

(591) Black, white

(511)

3 – Cosmetics, namely, nail polish, nail enamels, lipstick, lip liner, lip gloss, lip cream, non-medicated lip balm, makeup, skin concealers, rouge, blush, eye liner, eye shadow, mascara, eyebrow pencil, face powder, and sun block preparations, perfume.

21 – Cosmetic brushes.

(260) AM 2018 93868 A

(800) 1309867

(151) 2015 11 30

(891) 2017 04 10

(731) ZHU HAICHAO XIA QI
Lane 31, Dongtou Road, Puzhou Street,
Longwan, Wenzhou, 325011 ZheJiang,
China

(540)

LIVOLO

(591) Black, white

(531) 27.05.17

(511)

9 – Electronic tags for goods; television apparatus; logs [measuring instruments]; cables, electric; circuit breakers; protection devices for personal use against accidents; electric door bells; spectacles [optics]; computer peripheral devices.

(260) AM 2018 93871 A
 (800) 1312857
 (151) 2016 06 02
 (891) 2017 05 30
 (731) VEDA CAPITAL Ltd.
 Okulovoy str., 68 B, RU-153020 Ivanovo,
 Aruba
 (540)

ORMATEK VERDA/OPMATEK ВЕРДА

(591) Black, white
 (511)
 10 – Orthopedic articles; furniture especially made for medical purposes; cushions for medical purposes; pads [pouches] for preventing pressure sores on patient bodies; soporific pillows for insomnia.

20 – Sideboards; coat hangers; coatstands; display stands; showcases [furniture]; signboards of wood or plastics; covers for clothing [wardrobe]; doors for furniture; pegs [pins], not of metal; divans; flowerstands [furniture]; mirrors [looking glasses]; handheld mirrors [toilet mirrors]; bamboo; rattan; plaited straw, except matting; wickerwork; works of art of wood, wax, plaster or plastic; cabinet work; index cabinets [furniture]; cradles; chests of drawers; lecterns; armchairs; hospital beds; bedsteads of wood; beds; air mattresses, not for medical purposes; mattresses; furniture of metal; office furniture; school furniture; curtain rails; furniture; furniture partitions of wood; mirror tiles; head-rests [furniture]; trestles [furniture]; book rests [furniture]; pillows; cushions; racks [furniture]; library shelves; furniture shelves; shelves for storage; wood ribbon; hat stands; inflatable publicity objects; counters [tables]; bedding, except linen; door handles, not of metal; writing desks; seats of metal; benches [furniture]; sofas; silvered glass [mirrors]; gun racks; carts for computers [furniture]; dressing tables; washstands [furniture]; typing desks; drafting tables; massage tables; tables of metal; wall-mounted baby changing platforms; desks; tea carts; dinner wagons [furniture]; tables; steps [ladders], not of metal; chairs [seats]; high chairs for babies; chests, not of metal; placards of wood or plastics; stools; crates; trolleys [furniture]; straw plaits; straw mattresses; door fittings, not of metal; bed fittings, not of metal; furniture fittings, not of metal; window fittings, not of metal; infant walkers; easy chairs; poles, not of metal; screens [furniture]; cupboards; filing cabinets; medicine cabinets; meat chests, not of metal; plate racks; bamboo curtains; paper blinds; slatted indoor blinds; woven timber blinds [furniture]; indoor window blinds [shades] [furniture]; interior textile window blinds; screens for fireplaces [furniture]; lockers; boxes of wood or plastic; chests for toys; letter boxes, not of metal or masonry.

22 – Bags [envelopes, pouches] of textile, for packaging; straw for stuffing upholstery; grasses for

upholstering; carded wool; camel hair; flock [stuffing]; upholstery wool [stuffing]; wood wool; combed wool; raw or treated wool; shorn wool; padding and stuffing materials [except of paper, cardboard, rubber or plastics]; packing [cushioning, stuffing] materials, not of rubber, plastics, paper or cardboard.

24 – Household linen; diapered linen; bath linen, except clothing; bed linen; table linen, not of paper; table runners; drugget; shower curtains of textile or plastic; curtains of textile or plastic; net curtains; furniture coverings of textile; fabrics for textile use; wall hangings of textile; pillowcases; mattress covers; bed blankets; eiderdowns [down coverlets]; handkerchiefs of textile; travelling rugs [lap robes]; curtain holders of textile material; bed covers; furniture coverings of plastic; towels of textile; ticks [mattress covers]; gummed cloth, other than for stationery; printers' blankets of textile; door curtains; place mats, not of paper; table covers; oilcloth for use as tablecloths; lingerie fabric; upholstery fabrics; tulle; fitted toilet lid covers of fabric; covers [loose] for furniture; pillow shams; labels of cloth.

(260) AM 2018 93872 A
 (800) 1313823
 (151) 2016 05 20
 (891) 2017 07 27
 (731) PHOENIX S.R.L.
 Via 2 Giugno, 60/A1, I-20068 PESCHIERA
 BORROMEO (MI), Italy
 (540)



(591) Red, blue, white and light blue
 (531) 26.01.01; 26.01.03; 26.01.12; 26.01.24;
 26.11.12; 27.05.02; 27.05.13
 (511)
 5 – Pharmaceutical preparations; vitamins and vitamin preparations; dietary supplements; nutritional supplements; homeopathic supplements; herbal supplements.

(260) AM 2018 93873 A
 (800) 1352839
 (151) 2017 02 15
 (891) 2017 08 01
 (731) DAIICHI SANKYO COMPANY
 LIMITED
 3-5-1, Nihonbashi Honcho, Chuo-ku, Tokyo
 103-8426, Japan
 (540)



(591) Blue, light blue
 (531) 07.01.24; 26.03.23; 26.11.07; 29.01.12
 (511)
 5 – Pharmaceutical preparations and substances; medicines for human purposes.

(260) AM 2018 93874 A
 (800) 1325117
 (151) 2016 07 07
 (891) 2017 05 30
 (731) VEDA CAPITAL Ltd.
 Okulovoy str., 68, B RU-153020 Ivanovo,
 Russian Federation

(540)
РАЙТОН/RAITON

(591) Black, white
 (511)
 10 – Orthopedic articles; furniture especially made for medical purposes; cushions for medical purposes; pads [pouches] for preventing pressure sores on patient bodies; soporific pillows for insomnia.

20 – Sideboards; coat hangers; coatstands; display stands; showcases [furniture]; signboards of wood or plastics; covers for clothing [wardrobe]; doors for furniture; pegs [pins], not of metal; divans; flowerstands [furniture]; mirrors [looking glasses]; handheld mirrors [toilet mirrors]; bamboo; rattan; plaited straw, except matting; wickerwork; works of art of wood, wax, plaster or plastic; cabinet work; index cabinets [furniture]; cradles; chests of drawers; lecterns; armchairs; hospital beds; bedsteads of wood; beds; air mattresses, not for medical purposes; mattresses; furniture of metal; office furniture; school furniture; curtain rails; furniture; furniture partitions of wood; mirror tiles; head-rests [furniture]; trestles [furniture]; book rests [furniture]; pillows; cushions; racks [furniture]; library shelves; furniture shelves; shelves for storage; wood ribbon; hat stands; inflatable publicity objects; counters [tables]; bedding, except linen; door handles, not of metal; writing desks; seats of metal; benches [furniture]; sofas; silvered glass [mirrors]; gun racks; carts for computers [furniture]; dressing tables; washstands [furniture]; typing desks; drafting tables; massage tables; tables of metal; wall-mounted baby changing platforms; desks; tea carts; dinner wagons [furniture]; tables; steps [ladders], not of metal; chairs [seats]; high chairs for babies; chests, not of metal; placards of wood or plastics; stools; crates; trolleys [furniture]; straw plait; straw mattresses; door fittings, not of metal; bed fittings, not of metal; furniture fittings, not of metal; window fittings, not of metal; infant walkers; easy chairs; poles, not of metal; screens [furniture]; cupboards; filing cabinets; medicine cabinets; meat chests, not of metal; plate racks; bamboo curtains; paper blinds; slatted indoor blinds; woven timber blinds [furniture]; indoor window blinds [shades]

[furniture]; interior textile window blinds; screens for fireplaces [furniture]; lockers; boxes of wood or plastic; chests for toys; letter boxes, not of metal or masonry.

24 – Household linen; diapered linen; bath linen, except clothing; bed linen; table linen, not of paper; table runners; drugget; shower curtains of textile or plastic; curtains of textile or plastic; net curtains; furniture coverings of textile; fabrics for textile use; wall hangings of textile; pillowcases; mattress covers; bed blankets; eiderdowns [down coverlets]; handkerchiefs of textile; travelling rugs [lap robes]; curtain holders of textile material; bed covers; furniture coverings of plastic; towels of textile; ticks [mattress covers]; gummed cloth, other than for stationery; printers' blankets of textile; door curtains; place mats, not of paper; tablecloths, not of paper; oilcloth for use as tablecloths; lingerie fabric; upholstery fabrics; tulle; fitted toilet lid covers of fabric; covers [loose] for furniture; pillow shams; labels of cloth.

(260) AM 2018 93878 A
 (800) 1360287
 (151) 2017 04 20
 (891) 2017 04 20
 (731) OPUS GROUP AB
 Bäckstersgatan 11, SE-431 49 Mölndal,
 Sweden
 (540)

OPUS INSPECTION

(591) Black, white
 (511)
 9 – Measuring instruments; gasometers [measuring instruments]; mathematical instruments; measuring instruments; measuring apparatus and instruments; weight measuring instruments; physics (apparatus and instruments for -); wheel alignment measuring apparatus; tyre monitoring apparatus; measuring, counting, alignment and calibrating instruments; pressure measuring apparatus; instruments for measuring levels of fluids; instruments for surveying physical data; programs for computers; computer programmes for data processing; programs for computers; databases (electronic); computer databases; databases (electronic); computer software for database management; computer operating system software; software; data communications software; computer software programs for database management; diagnostic apparatus, not for medical purposes; diagnostic apparatus, not for medical purposes; computer systems; computer servers; computers; computers and computer hardware; engine diagnostic apparatus; electrical test apparatus; hydraulic system tes-

ting units; engine analyzers; flue gas analyzers; computerized vehicle engine analyzers.

35 – Computerised file management; systemization of information into computer databases.

37 – Installation of hardware for computer systems; inspection of vehicles prior to maintenance; inspection of vehicles prior to repair; advisory services relating to vehicle repair; advisory services relating to vehicle maintenance.

41 – Consultancy services relating to engineering education; training (practical -) [demonstration]; education services relating to computers; education services relating to computer systems; provision of instruction relating to computer programming; training services relating to computer systems; training in the operation of computer programs; education in the field of data processing; training in the development of software systems; training in the design of software systems; vehicle maintenance instruction; instructional services relating to the repair of vehicles; instructional services relating to the maintenance of vehicles; training services relating to the repair of vehicles.

42 – Computer programming; computer programming for others; computer programming and maintenance of computer programs; computer programming services for commercial analysis and reporting; computer programming; design of software; design and writing of computer software; design services for computer programs; creation, updating and adapting of computer programs; preparation of computer programs for data processing; installation of computer software; installation and customisation of computer applications software; installation and maintenance of computer programs; installation and maintenance of computer programs; installation, maintenance, repair and servicing of computer software; installation, repair and maintenance of computer software; computer software consultancy; configuration of computer software; configuration of computer software; advisory services relating to computer programming; computer software consultancy; modifying of computer programs; creating of computer programs; creation of computer programmes for data processing; creation of computer programmes for data processing; writing of computer programs; maintenance of software; maintenance of and updating of computer software; maintenance of and updating of computer software; design of software; design of software; software design and development; design, maintenance and up-dating of computer software; developing computer software; development of computer programs for combustion process analysis inside an engine; development of data bases; design of computer databases; database design and development; certification [quality con-

trol]; developing computer software; conducting sampling to assess pollution levels.

(260) AM 2018 93879 A

(800) 1360294

(151) 2017 04 04

(891) 2017 04 04

(731) PIAGGIO & C. S.P.A.

Viale Rinaldo Piaggio, 25, I-56025

PONTEDERA, PISA, Italy

(540)



(591) Black, white

(531) 27.05.01; 27.05.11; 27.05.19

(511)

12 – Two, three, four wheeled vehicles; bodies for vehicles; brakes for vehicles; caps for land vehicle gas tanks; luggage nets for vehicles; seat covers for vehicles; shock absorbing springs for vehicles; suspension shock absorbers for vehicles; vehicle chassis; vehicle seats; pneumatic tires; casings for pneumatic tires; non-skid devices for vehicle tires; adhesive rubber patches for repairing inner tubes; tire pumps for bicycles and motorcycles; repair outfits for inner tubes, namely, tire repair patches; rims for vehicle wheels; valves for vehicle tires; airbags in the nature of safety devices for automobiles; electric cigarette lighters for land vehicles; anti-theft devices for vehicles; antitheft alarms for vehicles; horns for vehicles; safety seats for children for vehicles; bells for cycles; stands for bicycles and motorcycles as parts of bicycles and motorcycles; mudguards; direction signals for vehicles; frames for bicycles and motorcycles; luggage carriers for vehicles; pedals for bicycles and motorcycles; rearview mirrors; saddle covers for bicycles and motorcycles; saddlebags adapted for bicycles and motorcycles; saddles for bicycles and motorcycles; engines for land vehicles; electric motors for land vehicles; motorcycle bags namely tank bags, sissy bar bags, tail bags, side hardbags, topcases.

(260) AM 2018 93880 A

(800) 1360296

(151) 2017 03 31

(891) 2017 03 31

(731) FERRERO S.P.A.

Piazzale Pietro Ferrero,1,I-12051 ALBA,

CUNEO, Italy

(540)



(591) Black, red-orange, light blue and white.

(531) 01.15.15; 11.03.02; 27.05.01; 27.05.17;
27.05.19; 29.01.13

(511)

30 – Pastries; confectionery; chocolate; chocolate based products; chocolate snacks; cream filled sponge cakes; biscuits; cakes; sweet baked products.

(260) AM 2018 93881 A

(800) 1360313

(151) 2016 12 28

(891) 2016 12 28

(731) LENZING AKTIENGESELLSCHAFT

Werkstr.2, A-4860 Lenzing, Austria

(540)

REFIBRA

(591) Black, white

(511)

10 – Breast shields; incontinence bed pads; medical drapes of non-woven textile materials; haemostats; surgical mesh; medical furniture and bedding, equipment for moving patients; blankets for medical purposes; incontinence sheets for use with babies; incontinence sheets for use with infants; cushions for medical purposes; pillows for orthopedic use; pillows for therapeutic use; pillows (soporific -) filled with down; sheets [drapes] for medical use; incontinence mattress protectors; incontinence sheets; medical clothing; disposable protective gloves for medical purposes; gloves for medical purposes; gloves for use in hospitals; medical compression stockings; surgical mesh comprised primarily of artificial materials; knee supports for medical use.

20 – Beds, bedding, mattresses, pillows and cushions; bedding for cots [other than bed linen]; bedding for cots [other than bed linen]; replacement seat covers [fitted] for furniture; textile covers [shaped] for furniture; inflatable pillows; bath pillows; bedding, except linen; children's beds made of cloth in the form of a bag; futon mattresses [other than childbirth mattresses]; head supporting pillows; maternity pillows; mattress toppers; mattresses; mattresses; mattresses [other than child birth mattresses]; nap mats [cushions or mattresses]; neck-supporting pillows; nursing pillows; pet cushions; pillows; scented pillows; sleeping mats for camping [mattresses]; soft furnishings [cushions]; stuffed pillows; support pillows for use in baby car safety seats; support

pillows for use in baby seating; animal housing and beds; beds for pets; pet cushions; pet houses; advertising display boards; advertisement display boards of plastic [non-luminous].

21 – Anti-static cloths for household use; dusters; eyeglass cleaning cloths; towel rings; chopstick cases; applicators for applying eye make-up; cases adapted for cosmetic utensils; toilet cases; applicators for cosmetics; oven mitts; cleaning rags; cleaning rags; cleaning rags.

22 – Raw textile fibers and substitutes; liber; raw cotton; treated wool; chemical fibers for textile use; fibres being partly prepared synthetic materials for textile use; fibres being raw synthetic materials for textile use; silk flock; yarn fibers; twisted cords [sash]; raw fibrous textile; scoured wool; semi-synthetic fibers [for textile use]; true hemp fiber [raw]; rabbit hair; jute; jute fiber [raw]; combed wool; kashmir hair; linters; raw fibrous textile materials treated with flame retardants; mohair; natural fibers; polyester stuffing fibers; polyester filaments for use in the manufacture of fabrics, textiles, yarns; polyester plastic netting for packaging goods; vitreous silica fibers for textile use; raffia fibers; ramie fibre; raw textile fibers; raw fibres of plastics for textile use; linen (raw -) [flax]; raw silk; raw wool; silk waste; shorn wool; silk fibers; silk polyester monofilaments for use in the manufacture of fabrics, textiles, yarns; carded wool; synthetic fibers for textile use; synthetic fibers for textile use; synthetic textile filaments; textile filaments; textile fibers; non-woven textile fibres; fibres for making up into carpets; fibres for making up into carpet tiles; viscose silica fibres; raw or treated wool; wool flock; bags and sacks for packaging, storage and transport; liners for use in bulk containers; bags and sacks for packaging, storage and transport; nets; plant hangers of rope; slings and bands, not of metal, for loading; strips for tying-up vines; wrapping or binding bands, not of metal; hammocks; storage bags for holding a body prior to cremation; mesh bags for washing lingerie; mesh bags for storage; packaging bags [sacks] of textile for bulk transportation; packaging bags [sacks] of textile for bulk storage; sacks; sacks made of textile materials; sacks for transporting waste; sacks for the transport of materials; sacks for the storage of materials in bulk; sacks and bags (not included in other classes); sacks for the storage of materials; bags [sacks] for the transport and storage of materials in bulk; non-textile bags for the transportation of materials in bulk; non-textile bags for the bulk storage of animal foodstuffs; non-textile bags for the bulk storage of materials; shoe bags for storage; sail bags; textile wine gift bags; protection pouches made of fabric for storing purses when not in use; bags [envelopes, pouches] of textile, for packaging; bags [envelopes, pouches] of textile, for packaging; bags [envelopes, pouches] of textile, for

packaging; packaging nets for transporting fruits and vegetables; bags [envelopes, pouches] of textile, for packaging; textile bags for merchandise packaging [envelopes, pouches]; tarpaulins, awnings, tents, and unfitted coverings; tents for use in angling; tents for camping; vehicle covers, not fitted; unfitted covers for boats and marine vehicles; tarpaulins; tents; tents [awnings] for vehicles; tents [awnings] for caravans; tents made of textile materials; tents for mountaineering or camping; sails; material for making sails; ropes and strings; binding thread, not of metal, for agricultural purposes; thread, not of metal, for wrapping or binding; strings; twine made of polypropylene; twine made of sisal; non-metallic twines; strings for tying purposes; packaging string; macrame rope; yarns for use in tyre cord construction; cordage; ropes and synthetic ropes; rope for use in toys for pets; synthetic ropes; cordage; ropes, not of metal; baling twine; packing rope; nets; elastic netting for meat products; hemp nettings; netting [not of metal or asbestos]; nets for windbreak purposes; chemical fiber nettings; rockfall prevention nets of textile; commercial fishing nets; commercial nets; nets for use with floating structures; twine for nets; net pens for fish farming; nets for shading; silk netting; fitted nets; padding and stuffing materials; down feathers; feathers for stuffing upholstery; wadding for filtering; fillings of synthetic fibres; fillings for upholstered pillows; fillings of synthetic foam; fillings for duvets; fillings for pillows; fillings for quilts; wood shavings; kapok; loose feathers; materials for padding; padding materials, other than of rubber or plastic for pillows; padding materials, other than of rubber or plastic for sleeping bags; padding materials made of fibrous material; padding materials made of fibrous material; padding made of non woven fabrics; padding materials, other than of rubber or plastic for beds; polyester batting; sawdust; sisal; sisal fibers; industrial packaging containers of textile; fleece for the upholstery industry; wadding for padding and stuffing upholstery; wadding fibres; wool (upholstery -) [stuffing]; padding and stuffing materials (except of paper, cardboard, rubber or plastics); fillings for upholstered pillows; spun polyester fibre for textile use.

23 – Yarns and threads; angora yarn; spools of thread; spools of yarn; spun cotton; cotton yarn; chenille yarn; chenille yarn; douppioni silk yarn; elastic thread; elastic thread and yarn for textile use; elastic strips of synthetic fibres for textile use; threads made of spun cotton; thread for textile use; textile filaments [threads]; flocked fibers; yarn; yarns made of angora for textile use; waste cotton yarn; polyester pre-oriented yarns; yarns made of carbon fibres for textile use; yarn of synthetic or mixed fibres for use in textiles; wild silk yarn; knitting yarns; yarns for domestic use; yarns for textile applications; inorganic fiber base mixed thread and yarn; cotton base mixed thread and yarn; chemical fiber base mixed

thread and yarn; chemical-fiber threads and yarns for textile use; degreased waste threads and yarns; hemp base mixed thread and yarn; regenerated fiber thread and yarn [for textile use]; silk base mixed thread and yarn; synthetic fiber thread and yarn; wool base mixed thread and yarn; yarns and threads for textile use; yarns for sale in kit form; twisted cotton thread and yarn; twisted threads and yarns; twisted hemp thread and yarn; twisted silk thread and yarn; twisted wool thread and yarn; yarns (combed -) made of natural fibres; twisted mixed thread and yarn; worsted yarn; spun silk yarn; spun silk yarn; semi-synthetic fiber thread and yarn [chemically treated natural fiber yarn]; hand knitting wools; true hemp thread and yarn; true hemp thread and yarn; heat-stable yarns and threads; jute thread and yarn; camel hair yarn; carded threads in flax for textile use; carded yarns of hemp for textile use; carded threads in natural fibres for textile use; carded threads in natural fibres for textile use; yarns (carded -) made of wool; carded threads in wool for textile use; cashmere yarns; ceramic fibre yarns for textile use; coir thread and yarn; rayon thread and yarn; linen thread and yarn; linen thread and yarn; metal fiber thread for textile use; sewing thread for textile use; sewing thread and yarn; natural yarns; non-metallic yarns for textile use; silica threads; ramie thread and yarn; raw silk yarn; spun silk; silk yarn; embroidery thread and yarn; knitting yarns; knitting yarns made of acrylic materials; knitting yarns made of nylon; knitting yarns made of wool; polyester textured yarns; yarns made of synthetic material for textile use; synthetic threads; carpet yarns; textile yarns; textile yarns made of man-made fibres; textile yarns made of natural fibres; covered rubber thread and yarn [for textile use]; mixed spun threads and yarns; waxed thread; waxed yarn; weaving fibres for industrial use; spun thread and yarn; worsted; wool yarn; wool yarn.³

24 – Flocked fabrics; fabrics being textile piece goods for use in tapestry; tick [linen]; knitted elastic fabrics for ladies underwear; knitted elastic fabrics for bodices; knitted elastic fabrics for sportswear; knitted elastic fabrics for gymnastic dresses; fibre fabrics for use in the manufacture of articles of clothing; fibre fabrics for the manufacture of the exterior coverings of furniture; fibre fabrics for use in the manufacture of linings of shoes; fibre fabrics for use in the manufacture of linings of bags; felt; felt for use by papermakers; felt cloth; flame retardant fabrics [other than asbestos]; flannel [fabric]; towelling [textile]; linings [textile]; inlay materials of non-woven fabrics; chemical fiber fabrics; fabrics for textile use; knit lace fabrics; knitted fabric; gummed waterproof cloth; towelling [textile]; linens; jersey [fabric]; jersey [fabric]; fabrics of carbon fibre, other than for insulation; fabrics [textile piece goods] made of carbon fibre; fabrics made from artificial fibres [other than for insulation]; upholstery fabrics; fur-

nishing fabrics; upholstery fabrics; furnishing fabrics in the piece; furnishing fabrics in the piece; woven furnishing fabrics; non-woven felts; silk fabrics for furniture; semi-synthetic fiber fabrics; fabrics of chemically produced fibres, other than for insulation; fabrics of organic fibres, other than for insulation; regenerated fiber yarn fabrics; fabrics made from artificial fibres [other than for insulation]; fabrics for use in making jerseys; knitted fabric; knitted fabrics of cotton yarn; knitted fabrics of chemical-fiber yarn; knitted fabrics of wool yarn; fabrics made of mixed synthetic and natural fibres, other than for insulation; textile fabrics for use in the manufacture of beds; textile fabrics for making into linens; textile fabrics for use in the manufacture of bedding; textile fabrics for making into blankets; textile fabrics for use in the manufacture of furniture; textile fabrics for use in the manufacture of sheets; textile fabrics for use in the manufacture of towels; textile fabrics for use in the manufacture of pillowcases; textile piece goods for making bedding covers; textile piece goods for making-up into towels; cloth; tissues being textile piece goods; velours for furniture; non-woven fabrics; non-woven textile fabrics; non-woven textile fabrics; non-woven textile fabrics for use as interlinings; non-woven fabrics of natural fibres; non-woven fabrics of synthetic fibres; non-woven fabrics in the form of sheeting for use in manufacture; woven fabrics for furniture; textile goods, and substitutes for textile goods; nightdress cases of textile; printers' blankets of textile; disposable cloths; linings [textile]; linen lining fabric for shoes; wall fabrics; fabrics for textile use; household textile articles made from non-woven materials; linens; nightdress cases of textile; ticks [mattress covers]; coverings for furniture; mosquito nets; non-woven textile articles; dust sheets; textile tissues; textiles made of flannel; non-woven textile articles; interlinings made of non-woven fabrics; coverings for furniture; furniture coverings (unfitted); loose covers made of textile materials for furniture; furniture coverings of textile; dust sheets; loose covers made of textile materials for furniture; draperies [thick drop curtains]; curtains; markers [labels] of cloth for textile fabrics; wall fabrics; wall hangings of textile; bed linen; bed linen; towelling [textile]; towels of textile; kitchen and table linens; towels of textile; hand towels of textile; bed linen and table linen; tea cloths; dish towels for drying; towelling [textile]; hand towels of textile; place mats, not of paper; textile smallwares [table linen]; table covers; table cloths (not of paper); tablemats, not of paper; table covers of non-woven textile fabrics; textile napkins; table linen, not of paper; napery of textile; table linen; washing gloves; bed linen; receiving blankets; bed linen and table linen; bed coverings; duvet covers; comforters; bed blankets made of cotton; bed blankets made of man-made fibres; bed covers of paper; silk bed blankets; woolen blankets; duvet covers; bed sheets; bed skirts; bed

throws; fabric bed valances; bed linen made of non-woven textile material; infants' bed linen; covers for eiderdown and duvets; comforters; blankets for household pets; quilts; blankets for outdoor use; disposable bedding of textile; eiderdowns [down coverlets]; terry towels; futon quilts; sleeping bags [sheeting]; waterproof bed clothes; cot blankets; cot sheets; children's blankets; shams; lap rugs; contoured mattress covers; pillowcases; ticks (mattress and pillow coverings); mattress covers; mattress covers; quilts filled with down; duvets; travelling rugs [lap robes]; sleeping bag liners; silk blankets; contour sheets; quilted mattress protectors [bedding]; quilts of textile; quilts of textile; quilts filled with feathers; quilts filled with half down; quilts filled with stuffing materials; quilts filled with synthetic stuffing materials; quilts; quilt covers; textile covers for duvets; textile goods for use as bedding; bed sheets; bed throws; valanced bed sheets; bed skirts; woolen blankets; bath linen; hand towels of textile; bath sheets; bath towels; bath linen, except clothing; disposable wash cloths; towelling coverlets; face cloths of towelling; turkish towel; turkish towel; bath sheets; bath sheets; towelling [textile] adapted for use in dispensers; hand towels; towelling [textile]; hand towels of textile; children's towels; towelling [textile]; household linen, including face towels; make-up removal cloths [textile], other than impregnated with cosmetics; make-up removal cloths [textile], other than impregnated with toilet preparations; cloths of woven textile material for washing the body (other than for medical use); cloths of non-woven textile material for washing the body [other than for medical use]; bath mitts; mitts made of non-woven fabric for washing the body; wash cloths; cloths for washing the body [other than for medical use]; filtering materials of textile; flame resistant fabrics.

25 – Headgear; swimming caps; bandanas [neckerchiefs]; baseball caps; berets; bobble hats; millinery; shower caps; fascinator hats; fedoras; fezzes; bucket caps; golf caps; yashmaks; bonnets [headwear]; tams; hats; frames (hat -) [skeletons]; skull caps; waterpolo caps; hoods [clothing]; small hats; knot caps; chefs' hats; sports headgear [other than helmets]; children's headwear; head scarves; head scarves; head scarves; yashmaghs; miters [hats]; fashion hats; caps [headwear]; cap peaks; sun visors [headwear]; nightcaps; hats (paper -) [clothing]; paper hats for wear by chefs; paper hats for wear by nurses; party hats [clothing]; fur muffs; fur hats; head scarves; rain hats; knitted caps; flat caps; garrison caps; sedge hats (suge-gasa); sleep masks; veils [clothing]; wimples; tam-o'-shanters; tennis sweatbands; ski hats; sun hats; sports caps and hats; sports caps; headbands [clothing]; head sweatbands; beach hats; knitted caps; balaclavas; thermal headgear; toques [hats]; head scarves; woolly hats; top hats; clothing; evening wear; evening coats; detachable neckpieces

for kimonos (haneri); detachable collars; underarm gussets [parts of clothing]; aikido suits; albs; american football bibs; parkas; suits; evening suits; women's suits; bowties; dress pants; jumper suits; blouses; work clothes; coveralls; blouses; sleeveless jerseys; mantles; arm warmers [clothing]; gowns for doctors [uniforms]; warm-up pants; clothing made of fur; driving gloves; layettes [clothing]; layettes [clothing]; baby bodysuits; baby doll pyjamas; babies' pants [clothing]; plastic baby bibs; baby tops; baby bunting [clothing]; babies' pants [clothing]; baby bottoms; layettes [clothing]; pram suits; swimming costumes; bathing costumes for women; bathing suits for men; fitted swimming costumes with bra cups; swim wear for gentlemen and ladies; bathing drawers; swimming costumes; swimming costumes; bathrobes; bathing drawers; swimming trunks; bathwraps; robes; ballet suits; ball gowns; bandanas [neckerchiefs]; bandeaux [clothing]; baseball uniforms; baselayer bottoms; baselayer tops; crop tops; printed t-shirts; leg warmers; cashmere clothing; clothing of imitations of leather; woolen clothing; motorists' clothing; baby clothes; bridesmaids wear; figure skating clothing; christening robes; clothing for wear in judo practices; children's wear; infant wear; girls' clothing; motorcyclists' clothing of leather; leather clothing; linen clothing; paper clothing; plush clothing; silk clothing; clothing for martial arts; clothing for horse-riding [other than riding hats]; articles of clothing for theatrical use; clothing for fishermen; boys' clothing; clothing for wear in wrestling games; maternity clothing; lounge pants; bermuda shorts; bed jackets; bed socks; maillots; blazers; blousons; boas [necklets]; leotards; body stockings; teddies [undergarments]; boleros; bolo ties; bomber jackets; boxer shorts; wedding dresses; burnouses; brassieres; bustiers; pea coats; capes; pedal pushers; car coats; cargo pants; chaps (clothing); chasubles; chemisettes; cheongsams (chinese gowns); albs; choir robes; evening wear; corduroy trousers; covers; ladies' clothing; lingerie; gowns; women's outer-clothing; knickers; ladies' underwear; ladies' underwear; down jackets; down vests; denim jeans; topcoats; donkey jackets; three piece suits [clothing]; duffel coats; pocket squares; one-piece suits; jumper suits; one-piece playsuits; disposable underwear; skating outfits; athletic tights; woollen tights; pleated skirts for formal kimonos (hakama); masquerade costumes; women's ceremonial dresses; moisture-wicking sports bras; moisture-wicking sports shirts; moisture-wicking sports pants; fishing shirts; fishing vests; fleeces; fleece vests; bowties; flying suits; formal evening wear; formalwear; foulards [clothing articles]; morning coats; leisure suits; casual shirts; slacks; casualwear; tap pants; barber smocks; robes; replica football kits; football jerseys; soccer bibs; footmuffs, not electrically heated; gabardines [clothing]; goloshes; gaiters; morning coats; padded pants for athletic use; padded shirts for athletic use;

padded shorts for athletic use; knitwear [clothing]; knitted gloves; knit jackets; knitted underwear; guernseys; woven clothing; woven shirts; gilets; polo shirts; golf trousers; golf pants, shirts and skirts; golf skirts; unitards; clothing for gymnastics; ankle socks; halloween costumes; neckbands; neckwear; scarves; neck tubes; wrist warmers; gloves [clothing]; gloves for cyclists; gloves with conductive fingertips that may be worn while using handheld electronic touch screen devices; gloves including those made of skin, hide or fur; handwarmers [clothing]; loungewear; aloha shirts; button-front aloha shirts; shirt yokes; shirts; shirts for suits; collared shirts; open-necked shirts; button down shirts; nighties; slips [undergarments]; shirt-jacs; shirt fronts; men's suits; menswear; outer-clothing for men; men's socks; men's underwear; waistcoats; wedding dresses; lumber jackets; hooded pullovers; knickers; trousers; trousers of leather; trousers for children; trousers for children; nurse pants; sweatpants; snowboard trousers; pantsuits; culotte skirts; knee-high stockings; braces for clothing [suspenders]; suspender belts for men; girdles; girdles; jackets [clothing]; jackets being sports clothing; polar fleece jackets; fishermen's jackets; sleeved jackets; sleeveless jackets; snowboard jackets; rainproof jackets; men's and women's jackets, coats, trousers, vests; jacket liners; hunting pants; hunting jackets; hunting vests; hunting shirts; kimonos; denims [clothing]; denim jeans; denim jackets; jumpers; jodhpurs; shell suits; jogging sets [clothing]; sweatpants; jogging tops; sweatpants; heavy jackets; stuff jackets [clothing]; judo suits; caftans; bodices [lingerie]; martial arts uniforms; combative sports uniforms; hooded sweat-shirts; karate suits; cashmere scarves; kendo outfits; khakis; kilts; kilts; kimonos; gowns; pinafores; gowns; nurse dresses; linings (ready-made -) [parts of clothing]; pockets for clothing; leisurewear; bloomers; walking breeches; trouser socks; knee warmers [clothing]; short sets [clothing]; ready-to-wear clothing; basic upper garment of Korean traditional clothes [jeogori]; korean traditional women's waistcoats [baeja]; korean topcoats [durumagi]; body warmers; corselets; camisoles; corsets; corsets; corsets; costumes; skirt suits; costumes for use in children's dress up play; costumes for use in role-playing games; shoulder wraps; detachable collars; collars for dresses; neckties; ascots; crinolines; cummerbunds; short-sleeved or long-sleeved t-shirts; short-sleeve shirts; short-sleeve shirts; short trousers; sweatpants; short petticoats; short overcoat for kimono (haori); cowls [clothing]; laboratory coats; long sleeve pullovers; long sleeved vests; long jackets; japanese sleeping robes (nemaki); full-length kimonos (nagagi); long johns; bibs, not of paper; bib overalls for hunting; running suits; running vests; leather suits; leather clothing; leather jackets; leather jackets; casual trousers; leggings [trousers]; underwear; sweat-absorbent underwear; light-reflecting

jackets; lingerie; liveries; bathing suit cover-ups; outerclothing for girls; maniples; athletic uniforms; cuffs; coats; pelisses; cotton coats; coats of denim; coats for women; coats for men; mantillas; sleep masks; eye masks; sailor suits; corselets; foundation garments; miniskirts; monokinis; robes; lounging robes; motorcycle riding suits; motorcycle gloves; motorcycle jackets; muffs [clothing]; muumuus; nighties; nighties; nighties; nightwear; wet suits; negligees; pop socks; women's outerclothing; outerclothing; dress shirts; uppers of woven rattan for japanese style sandals; chemise tops; cycling tops; hooded tops; halter tops; earbands; ear muffs [clothing]; combinations [clothing]; coveralls; coveralls; nurse overalls; overshirts; beach wraps; parkas; pelerines; furs [clothing]; pelisses; fur coats and jackets; fur muffs; fur cloaks; petticoats; petti-pants; polo shirts; pirate pants; plastic aprons; pantaloons; polo shirts; polo knit tops; turtleneck sweaters; polo sweaters; ponchos; sweaters; crew neck sweaters; mock turtleneck sweaters; v-neck sweaters; slipovers [clothing]; bloomers; pyjamas; pajama bottoms; cyclists' clothing; cycling shorts; ramie shirts; rash guards; head scarves; rainproof clothing; rainwear; waterproof trousers; mackintoshes; rain ponchos; riding gloves; jodhpurs; riding jackets; skirts; turtlenecks; roll necks [clothing]; turtleneck shirts; turtleneck sweaters; rugby tops; rugby shorts; rugby tops; bush jackets; saris; sarongs; sheepskin jackets; sheepskin coats; neck scarfs [mufflers]; mufflers [clothing]; shawls [from tricot only]; shawls and headscarves; shawls and stoles; sashes for wear; sash bands for kimono (obi); referees uniforms; nightwear; sleep masks; nighties; tube tops; veils [clothing]; cravats; knickers; snow suits; snow suits; snow pants; shoulder scarves; shoulder wraps [clothing]; school uniforms; aprons [clothing]; paper aprons; maternity bands; maternity smocks; sweat-absorbent socks; sweat-absorbent stockings; sweatbands; sweat bands for the wrist; headbands [clothing]; dress shields; anti-perspirant socks; head sweatbands; uniforms for nurses; swimming trunks; silk ties; silk scarves; adhesive bras; shampoo capes; shell jackets; shift dresses; mock turtleneck shirts; shirts and slips; shortalls; shorts; fleece shorts; boy shorts [underwear]; snow suits; ski suits for competition; ski gloves; ski trousers; ski jackets; clothing for skiing; ski balaclavas; sliding shorts; briefs; cummerbunds; dinner jackets; dinner suits; snow boarding suits; snowboard gloves; japanese style socks (tabi); socks and stockings; sock suspenders; bralettes; sundresses; sunsuits; playsuits [clothing]; camiknickers; gym suits; sports clothing [other than golf gloves]; sportswear; sports bras; casual shirts; sports shirts with short sleeves; sports pants; sports jackets; sports socks; singlets; sports jerseys and breeches for sports; gym suits; athletics vests; dust coats; quilted jackets [clothing]; quilted vests; cloth bibs; cloth bibs for adult diners; tightening-up strings for kimo-

nos (datejime); rompers; snap crotch shirts for infants and toddlers; beachwear; beach robes; stretch pants; knitwear [clothing]; knit shirts; cardigans; thongs; garters; stockings; sweat-absorbent stockings; heelpieces for stockings; pantie-girdles; tights; maillots [hosiery]; footless tights; hosiery; footless socks; surfwear; jockstraps [underwear]; sweaters; tracksuit bottoms; sweat jackets; sweat shirts; sweat shorts; taekwondo suits; waist cinchers; tank tops; dance clothing; dance costumes; tabards; camouflage gloves; camouflage shirts; camouflage pants; camouflage jackets; camouflage vests; trews; tennis wear; tennis shirts; tennis dresses; tennis pullovers; tennis skirts; tennis shorts; tennis socks; fabric belts [clothing]; thobes; theatrical costumes; thermal socks; thermal underwear; togas; tops [clothing]; folk costumes; japanese traditional clothing; bra straps; bib tights; pinafore dresses; strapless bras; tank tops; clothing for gymnastics; sweatpants; sweat shorts; tracksuit tops; trench coats; bib shorts; triathlon clothing; knitwear [clothing]; singlets; dry suits; tee-shirts; kerchiefs [clothing]; neckerchiefs; head scarves; tunics; turbans; clothing for gymnastics; gym shorts; tutus; twin sets; korean outer jackets worn over basic garment [magoja]; nappy pants [clothing]; topcoats; over-trousers; neck scarves; cloaks; shawls; maternity clothing; maternity sleepwear; maternity lingerie; uniforms; uniforms for commercial use; uniforms for nurses; referees uniforms; union suits; underwear; babies' undergarments; sweat-absorbent underwear; vest tops; undershirts for kimonos (juban); undershirts for kimonos (koshimaki); bottoms [clothing]; pants; chemises; petticoats; bustles for obi-knots (obiage-shin); tracksuit bottoms; underwear; garments for protecting clothing; suit coats; volleyball jerseys; thermally insulated clothing; warm-up jackets; warm-up tops; weatherproof clothing; waterproof suits for motorcyclists; waterproof capes; waterproof outerclothing; water socks; waterproof trousers; rainproof jackets; oilskins [clothing]; wetsuits for water-skiing; chefs' whites; white coats for hospital use; caftans; sweat shirts; reversible jackets; waistcoats; leather waistcoats; cagoules; weatherproof clothing; sailing wet weather clothing; puttees and gaiters; wrap belts for kimonos (datemaki); beach wraps; beach wraps; swaddling clothes; salopettes; windproof clothing; wind suits; wind pants; windshirts; wind vests; winter gloves; winter coats; hosiery; weather resistant outer clothing; woollen socks; yoga pants; yoga shirts; zoot suits; gussets [parts of clothing]; gussets for bathing suits [parts of clothing]; gussets for footlets [parts of clothing]; gussets for leotards [parts of clothing]; gussets for stockings [parts of clothing]; gussets for tights [parts of clothing]; gussets for underwear [parts of clothing]; footwear; heels; heelpieces for footwear; bootees (woollen baby shoes); bath slippers; footwear for women; insoles for footwear; espadrilles; heel inserts;

flat shoes; embossed heels of rubber or of plastic materials; embossed soles of rubber or of plastic materials; non-slipping devices for footwear; slippers; slipper socks; stiffeners for shoes; inner socks for footwear; running shoes; infants' footwear; leather slippers; leather shoes; canvas shoes; deck shoes; uppers for japanese style sandals; slippers; pumps [footwear]; welts for footwear; rain boots; riding shoes; riding shoes; shoe straps; rugby boots; mules; slip-on shoes; shoes; athletic shoes; leisure shoes; shoes for foot volleyball; shoes with hook and pile fastening tapes; high-heeled shoes; mountaineering shoes; shoe inserts for non-orthopedic purposes; shoe uppers; footwear soles; shoe covers, other than for medical purposes; footwear uppers; snowboard shoes; shoe soles; slipper soles; soles for japanese style sandals; espadrilles; dance shoes; ballroom dancing shoes; tennis shoes; training shoes; tips for footwear; waterproof boots for fishing; aqua shoes; winter boots; yoga shoes; zori; tongues for shoes and boots; ladies' underwear; wetsuit gloves; pyjamas [from tricot only]; intermediate soles.

27 – Carpets, rugs and mats; bath mats; textile bath mats; bath mats; bath mats; vehicles mats and carpets; rugs (floor -); door mats; runners [mats]; oriental non-woven rugs (mosen); carpet tile backing; carpet backing; carpeting; carpet tiles; primary carpet backing; textile bath mats; carpets [textile]; wall-paper; wall paper of vinyl; wall coverings of paper; carpets.

35 – Advertising, marketing and promotional services; bill-posting; banner advertising; merchandising; public relations services; online advertising; telemarketing services; sales promotion for others; advertising; display services for merchandise; preparation and presentation of audio visual displays for advertising purposes; organisation and conducting of product presentations; presentation of goods and services; sales demonstration [for others]; demonstration of goods and services by electronic means, also for the benefit of the so-called teleshopping and home shopping services; demonstration of goods for promotional purposes; arranging of demonstrations for advertising purposes; demonstration of goods; arranging and conducting of trade show exhibitions; arranging of exhibitions for business purposes; arranging of exhibitions for advertising purposes; exhibitions (conducting -) for business purposes; exhibitions (conducting -) for business purposes; exhibitions (conducting -) for advertising purposes; organisation of exhibitions and trade fairs for business and promotional purposes; shows (conducting business -); fashion show exhibitions for commercial purposes; arranging of displays for commercial purposes; organisation of events for commercial and advertising purposes; organization of events, exhibitions, fairs and shows for commercial, promotional and advertising purposes; arranging of demonstra-

tions for advertising purposes; planning and conducting of trade fairs, exhibitions and presentations for economic or advertising purposes; arranging of exhibitions for advertising purposes; rental of advertising space on-line; rental of advertising space; distribution of advertising, marketing and promotional material; distribution of promotional matter; distribution of advertisements and commercial announcements; dissemination of advertising matter; distribution of advertising material; dissemination of advertising and promotional materials; dissemination of advertising, marketing and publicity materials; dissemination of advertisements; dissemination of advertising for others; dissemination of advertising for others via the internet; distribution and dissemination of advertising materials [leaflets, prospectuses, printed material, samples]; handbill distribution; handbill distribution; handbill distribution; distribution of samples for publicity purposes; distribution of prospectuses and samples; handbill distribution; distribution of products for advertising purposes; sample distribution; distribution of advertising announcements; distribution and dissemination of advertising materials [leaflets, prospectuses, printed material, samples]; handbill distribution; handbill distribution; distribution of promotional matter; arranging the distribution of advertising literature in response to telephone enquiries; arranging of presentations for business purposes; office functions; business management; supply chain management services; arranging of presentations for business purposes; arranging of presentations for business purposes; business administration; marketing studies; compilation of scientific information; collection of information relating to hydrology.

42 – Scientific and technological services; advisory services relating to scientific research; computer aided scientific analysis services; computer aided scientific research services; scientific testing services; preparation of scientific reports; provision of information relating to scientific research; provision of scientific information; advisory services relating to science; scientific services and design relating thereto; scientific services and research relating thereto; scientific research relating to cosmetics; scientific research for medical purposes; scientific research and analysis; laboratory (scientific -) services; scientific and industrial research; scientific investigations for medical purposes; consultancy services relating to product engineering; engineering services for others; engineering consultancy services; engineering testing; preparation of engineering reports; engineering consultancy services; engineering research; engineering consultancy relating to testing; technical engineering; conducting of scientific studies; scientific analysis; information services relating to the safety testing of chemicals used in horticulture; information services relating to the safety testing of chemicals used in agriculture; scientific

research relating to chemistry; scientific research relating to ecology; engineering testing; scientific testing services; textile testing; quality testing of products for certification purposes; certification [quality control]; providing information in the field of product development; product research and development; design of carpets; designing of packaging and wrapping materials; design of curtains.

(260) AM 2018 93883 A

(800) 1360419

(151) 2017 04 12

(891) 2017 04 12

(731) OLGARLAR SPOR MALZEMELERİ
TURİZM İLAN REKLAM AJANSLIĞI
YAYINCILIK VE TİCARET ANONİM
ŞİRKETİ
Ulus mahallesi Öztöpus Cad. No:30 Ulus
Beşiktaş İSTANBUL, Turkey

(540)



(591) Black, white

(531) 05.01.05; 27.05.01

(511)

18 – Leather and imitations of leather; animal skins and hides; luggage and carrying bags; umbrellas and parasols; walking sticks; whips, harness and saddlery; collars, leashes and clothing for animals.

25 – Clothing, footwear, headgear.

35 – Advertising; business management; business administration; office functions.

(260) AM 2018 93884 A

(800) 1360454

(151) 2017 05 02

(891) 2017 05 02

(731) RAUCH Fruchtsäfte GmbH
Langgasse 1, A-6830 Rankweil, Austria

(540)



(591) Black, white

(531) 05.07.11; 05.07.13; 26.01.02; 26.01.03;
26.01.15; 26.01.20; 27.05.17

(511)

30 – Tea; iced tea; tea-based beverages; tea-based drinks.

32 – Non-alcoholic beverages; non-alcoholic beverages containing tea or tea extracts or with a tea flavour.

(260) AM 2018 93885 A

(800) 1360461

(151) 2017 05 22

(891) 2017 05 22

(731) SAAT VE SAAT SANAYI VE TICARET A.S.
Maslak Mah. Büyükdere Cad. No:237/D,
Noramin İp, Merkezi Sariyer İstanbul,
Turkey

(540)

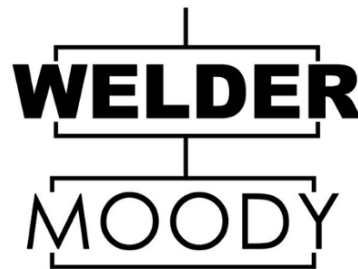

(591) Black, white

(531) 26.04.09; 26.04.19; 27.05.10; 27.05.17

(511)

14 – Watches.

(260) AM 2018 93893 A

(800) 1360616

(151) 2017 05 23

(891) 2017 05 23

(731) NUFARM

28 boulevard Camélinat, F-92230
GENNEVILLIERS, France

(540)



(591) Black, white

(531) 27.05.17

(511)

5 – Insecticides.

(260) AM 2018 93895 A

(800) 1360639

(151) 2016 11 10

(891) 2016 11 10

(731) TASLY PHARMACEUTICAL GROUP CO.,
LTD

Tasly Modern TCM Garden, No.2 Pujithe
East Road, Beichen District 300410 Tianjin,
China

(540)



(591) Black, white

(531) 26.03.01; 26.03.23; 26.03.24; 26.11.08;
27.05.17

(511)

5 – Medicines for human purposes; chemico-pharmaceutical preparations; raw material medicine; biomedicine; pharmaceutical herbs for medical purposes; prepared Chinese medicine; capsules for medicines; pharmaceutical preparations; dietetic substances adapted for medical use; bath preparations, medicated; balsamic preparations for medical purposes; preparations for the treatment of burns; syrups for pharmaceutical purposes; vitamin preparations; sunburn preparations for pharmaceutical purposes; vaccines; detergents for medical purposes; disinfectants for hygiene purposes; digestives for pharmaceutical purposes; drugs for medical purposes; medicine cases, portable, filled; mineral water for medical purposes; salts for medical purposes; purgatives; meal for pharmaceutical purposes; flour for pharmaceutical purposes; febrifuges; medicinal tea; nervines; anthelmintics; gelatine for medical purposes; germicides; greases for medical purposes; chemical preparations for the diagnosis of pregnancy; medicinal oils; medicinal herbs; lotions for pharmaceutical purposes; ointments for pharmaceutical purposes; pectin for pharmaceutical purposes; herbs teas for medicinal purposes; pharmaceutical preparations for skin care; pharmaceutical preparations for treating dandruff; first-aid boxes, filled; medicinal roots; tonics [medicine]; sedatives; soporifics; sugar for medical purposes; biological preparations for medical purposes; medical preparations for slimming purposes; by-products of the processing of cereals for dietetic or medical purposes; chemical preparations for pharmaceutical purposes; medicines for dental purposes; diagnose preparations for medical purposes; medicinal drinks; ferments for pharmaceutical purposes; chemical preparations for medical purposes; chemical reagents for medical or veterinary purposes; dietary fiber; enzyme preparations for medical purposes; amino acids for pharmaceutical purposes; mouthwashes for medical purposes; appetite suppressants for medical purposes; adjuvants for medical purposes; weight-reducing aid; medicine for the treatment of tanning skin; antioxidant medicine; acne treatment preparation; lysine electuary; oral rehydration salts; medicinal liquor; ginseng electuary; ginseng (term considered too vague by the International Bureau – Rule 13.2.b of the Common Regulations); medlar (term considered too vague by the International Bureau – Rule 13.2.b of the Common Regulations); weight-reducing tea; dietetic foods adapted for medical purposes; dietetic beverages

adapted for medical purposes; nutritional additives for medical purposes; food for babies; milk powder for infants; air purifying preparations; animal washes; veterinary preparations; feed, containing drugs (term considered too vague by the International Bureau – Rule 13.2.b of the Common Regulations); biocides; vermin destroying preparations; sanitary towels; wadding for medical purposes; medical dressings; rubber for dental purposes; teeth filling material; diaper for pets.

(260) AM 2018 93898 A

(800) 1360739

(151) 2017 06 23

(891) 2017 06 23

(731) BEIERSDORF AG

Unnastr. 48, 20253 Hamburg, Germany

(540)

NIVEA ROCK SALTS

(591) Black, white

(511)

3 – Non-medicated soaps, cosmetics, cosmetic bath and shower preparations.

(260) AM 2018 93899 A

(800) 1361036

(151) 2017 04 14

(891) 2017 04 14

(731) BOTTO GIUSEPPE & FIGLI S.P.A. Via B.

Sella, 166, I-13825 VALLE MOSSO,
BIELLA, Italy

(540)



Botto Giuseppe

(591) Black, white

(531) 05.01.01; 23.01.01; 23.01.05; 24.01.10;
24.01.13

(511)

23 – Spun thread and yarn; spun cotton; thread; chenille yarn; woollen thread and yarn; linen thread and yarn; silk thread and yarn; mixed spun thread and yarn; elastic thread and yarn for textile use; sewing thread and yarn; embroidery thread and yarn; yarn and thread for textile purposes; waste cotton thread and yarn; spun wool; spun silk; cashmere thread and yarn.

(260) AM 2018 93903 A

(800) 1362448

(151) 2017 04 01

(891) 2017 04 01

(731) CHINA CENTRAL TELEVISION

No.11, Fuxing Road Beijing, China

(540)

cgtn

(591) Black, white

(531) 27.05.17

(511)

9 – Electronic publications, downloadable; downloadable image files; downloadable music files; computer software applications, downloadable; computer programs for editing images, sound and video; computer software for processing image, graphics and word; computer software for organizing and viewing digital images and photos; computer software for music composition; compact disc; animated cartoons.

16 – Printed matter; printed publications; posters; books; periodicals; magazines [periodicals]; newsletters; newspapers; picture poster; photographs [printed].

35 – Advertising; television advertising; production of advertising films; publication of publicity texts; advertising design; promotion movie series for others; market investigations based on computer database; consultancy and advisory services for business strategy; business management planning; business management of performing artists; word processing.

36 – Capital investment; lease-purchase financing; investment of funds; rental of real estate; real estate agency services; real estate management; rental of offices [real estate]; apartment house management; rental of apartments; commercial housing sales.

38 – Pay-per-view television programmes broadcasting; television broadcasting; cable television broadcasting; news agency services; internet broadcasting services; message sending; providing online forums; providing access to databases; providing telecommunications connections to a global computer network; providing user access to global computer networks; transmission of digital files.

41 – Production of radio and television programmes; television entertainment; production of shows; news reporters services; writing of texts; photographic reporting; production of music; entertainer services; performance for live comedy programmes; entertainment information; publication of texts, other than publicity texts; publication of books; providing online electronic publications, not downloadable; publish video tape; organization of competitions [education or entertainment]; organization of shows [impresario services]; instruction services.

42 – Conversion of data or documents from physical to electronic media; computer software design; maintenance of computer software; installation of computer software; providing search engines for the internet; information technology [IT] consultancy;

design and development of multimedia products; research and development of new products for others; telecommunications technology consultancy; dress designing; construction planning and design for entertainment venue.

(260) AM 2018 93904 A

(800) 1362449

(151) 2017 04 01

(891) 2017 04 01

(731) CHINA CENTRAL TELEVISION

No.11, Fuxing Road Beijing, China

(540)

CGTN+

(591) Black, white

(531) 24.13.01; 27.05.17

(511)

9 – Electronic publications, downloadable; downloadable image files; downloadable music files; computer software applications, downloadable; computer programs for editing images, sound and video; computer software for processing image, graphics and word; computer software for organizing and viewing digital images and photos; computer software for music composition; compact disc; animated cartoons.

16 – Printed matter; printed publications; posters; books; periodicals; magazines [periodicals]; newsletters; newspapers; picture poster; photographs [printed].

35 – Advertising; television advertising; production of advertising films; publication of publicity texts; advertising design; promotion movie series for others; market investigations based on computer database; consultancy and advisory services for business strategy; business management planning; business management of performing artists; word processing.

36 – Capital investment; lease-purchase financing; investment of funds; rental of real estate; real estate agency services; real estate management; rental of offices [real estate]; apartment house management; rental of apartments; commercial housing sales.

38 – Pay-per-view television programmes broadcasting; television broadcasting; cable television broadcasting; news agency services; internet broadcasting services; message sending; providing online forums; providing access to databases; providing telecommunications connections to a global computer network; providing user access to global computer networks; transmission of digital files.

41 – Production of radio and television programmes; television entertainment; production of shows; news

reporters services; writing of texts; photographic reporting; production of music; entertainer services; performance for live comedy programmes; entertainment information; publication of texts, other than publicity texts; publication of books; providing on-line electronic publications, not downloadable; publish video tape; organization of competitions [education or entertainment]; organization of shows [impresario services]; instruction services.

42 – Conversion of data or documents from physical to electronic media; computer software design; maintenance of computer software; installation of computer software; providing search engines for the internet; information technology [IT] consultancy; design and development of multimedia products; research and development of new products for others; telecommunications technology consultancy; dress designing; construction planning and design for entertainment venue.

(260) AM 2018 93905 A

(800) 1362450

(151) 2017 04 01

(891) 2017 04 01

(731) CHINA CENTRAL TELEVISION

No.11, Fuxing Road Beijing, Switzerland

(540)

CGTN

(591) Black, white

(531) 27.05.17

(511)

9 – Electronic publications, downloadable; downloadable image files; downloadable music files; computer software applications, downloadable; computer programs for editing images, sound and video; computer software for processing image, graphics and word; computer software for organizing and viewing digital images and photos; computer software for music composition; compact disc; animated cartoons.

16 – Printed matter; printed publications; posters; books; periodicals; magazines [periodicals]; newsletters; newspapers; picture poster; photographs [printed].

35 – Advertising; television advertising; production of advertising films; publication of publicity texts; advertising design; promotion movie series for others; market investigations based on computer database; consultancy and advisory services for business strategy; business management planning; business management of performing artists; word processing.

36 – Capital investment; lease-purchase financing; investment of funds; rental of real estate; real estate agency services; real estate management; rental of

offices [real estate]; apartment house management; rental of apartments; commercial housing sales.

38 – Pay-per-view television programmes broadcasting; television broadcasting; cable television broadcasting; news agency services; internet broadcasting services; message sending; providing online forums; providing access to databases; providing telecommunications connections to a global computer network; providing user access to global computer networks; transmission of digital files.

41 – Production of radio and television programmes; television entertainment; production of shows; news reporters services; writing of texts; photographic reporting; production of music; entertainer services; performance for live comedy programmes; entertainment information; publication of texts, other than publicity texts; publication of books; providing on-line electronic publications, not downloadable; publish video tape; organization of competitions [education or entertainment]; organization of shows [impresario services]; instruction services.

42 – Conversion of data or documents from physical to electronic media; computer software design; maintenance of computer software; installation of computer software; providing search engines for the internet; information technology [IT] consultancy; design and development of multimedia products; research and development of new products for others; telecommunications technology consultancy; dress designing; construction planning and design for entertainment venue.

(260) AM 2018 93907 A

(800) 517432

(151) 1987 10 14

(891) 2017 05 17

(731) HELMUT LANG NEW YORK LLC

615 South Dupont Highway, Dover
Delaware, 19901, USA

(540)

HELMUT LANG

(591) Black, white

(511)

25 – Clothing, including boots, shoes and slippers.

(260) AM 2018 93908 A

(800) 819872

(151) 2004 01 28

(891) 2017 06 28

(731) C. BECHSTEIN PIANOFORTEFABRIK AG

Kantstrasse 17, 10623 Berlin, Germany

(540)

Zimmermann

(591) Black, white
 (531) 27.05.17
 (511)
 15 – Pianos and grand pianos.

(260) AM 2018 93909 A
 (800) 920157
 (151) 2007 02 16
 (891) 2017 06 28
 (731) HENKEL AG & CO. KGAA
 Henkelstrasse 67, 40589 Düsseldorf, Germany
 (540)

BLONDME

(591) Black, white
 (511)
 3 – Soaps, perfumery, essential oils, cosmetics, hair preparations for caring, cleaning, tinting, dyeing, bleaching, fixing and perming.

(260) AM 2018 93911 A
 (800) 950947
 (151) 2007 05 03
 (891) 2017 08 09
 (731) AXEL SPRINGER SE
 Axel-Springer-Straße 65, 10969 Berlin,
 Germany;
 AXEL SPRINGER AUTO-VERLAG GMBH
 Axel-Springer-Platz 1 20350 Hamburg,
 Germany

(540)



(591) Black, yellow, white. Yellow and white, black-shaded letters on white and yellow background
 (531) 24.17.07; 26.04.22; 26.04.24; 27.05.17; 27.05.24; 29.01.12
 (511)
 9 – Sound, image and data carriers of all kinds (except unexposed films), in particular sound tapes, cassettes, CDs, recording discs, DAT tapes, video tapes, floppy discs, CD-ROMs, CD-Is, recording media (except films), DVDs, magnetic data carriers, all the aforesaid goods recorded or unrecorded; computer programs and software, in particular for telecommunications, network and voice data applications, and for electronic commerce via the global communications network; apparatus for recording, transmission and reproduction of sound, images and data of all types; calculating machines; data-processing equipment and computers; electronic 3-D spectacles;

multimedia apparatus, included in this class; apparatus for interactive television, decoders, smartcards, included in this class; computer games recorded on data carriers; computer programs, in particular for gaming; electronic games adapted for use exclusively with a television receiver; image files; downloadable music; exposed films.

16 – Paper, cardboard and goods made from these materials (included in this class); printed matter, in particular prospectuses, catalogues, books, newspapers and periodicals; bookbinding material; photographs; stationery; instructional and teaching material (except apparatus); voucher books; tokens and pre-paid cards, not encoded, of cardboard and paper, including those coated with plastic; office requisites (other than furniture).

28 – Games and playthings, in particular cuddly toys or other playthings, such as nodding dogs, used as decorations in vehicles; gymnastic and sporting articles (included in this class); game cards; apparatus for electronic games other than those adapted for use with television receivers only; scooters (toys), in particular scooters for children and adults with adjustable steering handles (kickboards); home training equipment, in particular stationary exercise bicycles, treadmills, steppers, rowing machines, fitness benches, dumb-bells; skis, snowboards, sledges; Christmas trees of synthetic material; decorations for Christmas trees; Christmas tree stands; children's pedal cars (toys); rocking horses; in-line roller skates; games other than those adapted for use with an external display screen or monitor; toys, namely battery-powered computer games with LCD screen featuring animation and sound effect.

35 – Business management services; business administration; office functions; marketing, in particular on digital networks in the form of web advertising, including dialogue marketing and direct marketing; market research; market analysis; opinion polling; advertising, in particular Internet, radio, television, cinema, print, videotext and teletext advertising, including in the form of sponsorship and catalogue advertising; advertising marketing, in particular in the aforesaid media and via the aforesaid media; merchandising; advertising; sales research; rental of advertising space on the Internet (banner exchange); advertising for sales activities, for others; conducting online campaigns on the Internet, namely in the form of sales events for goods, including the procurement of contracts for others regarding the sale of goods against the highest offer; conducting online campaigns on the Internet, namely in the form of competitions and prize games for advertising purposes; online services, namely the electronic, telephone and/or computerised receipt of orders for goods; arranging contracts, for others, for the buying and selling of goods and the billing therefor, included in this class (online-shopping); arranging commercial transac-

tions, for others, in particular within the framework of an electronic department store (supermarket); e-commerce provider services, namely order placement and invoice management for electronic ordering systems, and presentation of goods and services; business and organization consultancy; arranging contracts for the buying and selling of goods for others; compilation, maintenance and systemization of data in computer databases, in particular by means of interactive computer systems; arranging advertising contracts, for others, in particular for facilitators; telephone and/or computerised order placement for teleshopping; personnel placement; development of advertising concepts for use on various communication media, in particular television, teletext and telephone and computers associated with telephones; advertising research; advertising management; distribution of goods for advertising purposes; economic information; online auctioneering on the Internet; sales promotion (for others); dissemination of advertisements; arranging contracts for others regarding the provision of services, namely provision of contracts regarding procurement of access to computer programs in data networks; arranging of commercial and business contacts; price calculation for goods and services; conducting online promotional campaigns on the Internet, namely in the form of competitions for sales promotion and prize games; public relations; providing consumer information; arranging of contracts, for others, for the providing of services; computerized file management; publication of publicity texts; searches in computer data files (for others); presentation of companies on the Internet and other media; sponsoring in the form of advertising; arranging newspaper subscriptions (for others); arranging of subscription agreements for the broadcasting and dissemination of television programs, in particular in the form of pay-TV and video-on-demand; publication of advertising texts; publication of published matter in the form of text, graphics, image and sound data, as well as voice data, which can be transmitted electronically and is accessible via data networks, for advertising purposes; production of television advertising, radio advertising and Internet advertising broadcasts, including respective competition and prize game broadcasts; negotiation of contracts concerning access rights for users to different communication networks; rental of advertising films; business management of performing artists.

38 – Telecommunications, in particular data-processing supported electronic information services in the field of telecommunication and communication services by telephone and computer terminals for general and closed groups of users; transmission of information and communication services of all kinds by telephone and computer terminals, including with the aid of integrated voice recognition technologies; provision of access to a digital media platform on

the Internet for the exchange of news and information of all kinds, also by converting of formats into speech or other output media; video streaming (continuous real-time transmission of video streams on computer networks); mobile telephone value-added services, included in this class, namely voice services, SMS, WAP, GPRS and UMTS services; sound, image and data transmission by cable, satellite, computers and computer networks, in particular by email, telephone and ISDN lines and any other transmission media; broadcasting of film, television, radio, VTX, videotext, teletext and Internet programmes or transmissions; transmission and forwarding of radio and television programmes, including by wire, cable, satellite communications, videotext, Internet and similar technical installations; press agency services; hotline telephone services; providing access to information, news and entertainment programmes on the Internet and by other transmission media; operating chat rooms, chatlines and forums; provision of access to a platform, in particular of an e-commerce platform; web messaging, namely the relaying of messages of all kinds to Internet addresses; collection and supply of news (press agencies); transmission of internally and externally procured data content and formats, for and by means of voice service sales channels, SMS and WAP (content brokerage); providing access to internally and externally procured content and formats on computer networks by means of voice service sales channels, SMS and WAP; collection and supply of press news; providing automated telephone services (active/passive) using computers, in particular voice response, ordering and information services, voice mail, interactive computer games, accessed by telephone; telephone services, namely voice-controlled telephone retrieval of information and services from computers; providing a telephone number as a mailbox for advertisers, on which a personal message can be recorded; providing access to, and operating of, value-added voice and fax services, namely voicemail services, virtual call numbers, telephone conversations via the Internet, call forwarding, conferencing, fax retrieval, bulk fax mailing, fax receiving, sending of fax messages; operating a subscriber hotline for accepting responses on interactive television, radio and Internet programmes; providing access to a directory on the world wide web, websites, news groups and other sources organised and indexed into easily accessible specialist fields; providing access to a worldwide computer network; providing access to portals on the Internet; telecommunication routing and junction services; electronic mail services; computer-aided transmission of messages and images; rental of access time to global computer networks, in particular to internally and externally procured content and formats for voice service sales channels, SMS and WAP; providing and rental of access time to databases, in particular to internally and externally

procured content and formats for voice service sales channels, SMS and WAP; providing of access to computer programmes in data networks; allocation of access rights for users to different communication networks; rental of telecommunications hardware for voice-controlled telephone inquiry applications; technical consultancy in the field of telecommunication.

39 – Order delivery services.

41 – Education; providing of training; entertainment; sporting and cultural activities; development and production of film, television, radio, VTX, videotext, teletext and Internet programmes or broadcasts, in particular interactive programmes or broadcasts (for cultural, educational and entertainment purposes, and of news broadcasts); radio, television and Internet entertainment; publishing printed matter (excluding publicity texts) and corresponding electronic media, in particular prospectuses, voucher books and inserts (printed matter), catalogues, books, newspapers and periodicals; publication of published matter in the form of text, graphics, image and sound data, as well as voice data, which can be transmitted electronically and is accessible via data networks; production and presentation of shows, quizzes, interviews, theatrical, sporting and musical events, and organisation of competitions (education and entertainment), in particular on the Internet, including the aforesaid services for recorded programmes or live broadcasts on television, radio or the Internet; producing films and sound and image recordings; development and production of television formats, television content, television programmes, television series, television shows and television game shows, as well as pre-production thereof, including scriptwriting and script development and show concepts and ideas for games, show episodes, interview techniques; services of a publishing house (excluding printing services); operating of games on the Internet; rental of films; conducting prize games on interactive television, radio and Internet programmes; editor services; conducting online campaigns on the Internet, namely in the form of competitions and prize games for entertainment purposes; news reporters services; online publishing of electronic books and periodicals; providing electronic publications (non-downloadable); photographic reporting; publication of texts (except publicity texts); entertainment information; organization of exhibitions for cultural or educational purposes; composition of television programmes and broadcast programmes; seat reservation for entertainment events; organization and operation of cultural and/or sport events; gaming services; editing of websites; awarding of prizes; providing information on the Internet in the field of education, providing of training, entertainment, sporting and cultural activities; digital image processing.

42 – Creation of data processing programmes; development of electronic television programme guides; computer programming; scientific research using databases and the Internet; services of a designer, namely development of company logos; services of a graphic designer, namely updating and design of advertising space on the Internet; electronic data security; electronic data storage services; care, rental, maintenance and installation of software; technical consultancy in the fields of computer hardware and software; server administration; providing web space (web-hosting); providing of memory space on the Internet; design services, especially design of titles for games and show episodes; services of a designer, namely development of stage scenery; design services for film, television, radio, VTX, videotext, teletext and Internet programmes or broadcasts, in particular interactive programmes or broadcasts (for cultural, educational and entertainment purposes, and of news broadcasts).

45 – Management and exploitation of copyright and industrial property rights for others; negotiation, exploitation and management of television broadcasting rights, in particular rights to the broadcasting of events on television; negotiation, exploitation and management of rights to press articles and radio, television and film items to be used in sound and image carriers; negotiation, exploitation and management of rights to articles in newspapers and periodicals; managing, negotiating and exploitation of broadcasting, further broadcasting, audiovisual, mechanical and other user rights for radio and television broadcasts and other sound and image productions; negotiation, management and awarding of rights to television formats, television content, television broadcasts, television series, television shows and television game shows and the showing thereof, in particular screenplays and the basic design elements thereof, including titles, logos, show concepts, ideas for games, stage scenery, show episodes, interview techniques (except publicity texts); legal intermediary services for the management and exploitation of copyright and industrial property rights for others.

(260) AM 2018 93912 A

(800) 983697

(151) 2008 07 07

(891) 2017 06 15

(731) DEUTSCHE BAHN AG

Potsdamer Platz 2, 10785 Berlin, Germany

(540)

The logo consists of the letters 'DB' in a bold, black, sans-serif font, enclosed within a black square border. To the right of this square, the word 'SCHENKER' is written in a larger, bold, black, sans-serif font.

(591) Black, white

(531) 26.04.18; 27.05.17

(511)

39 – Transport, namely transport of persons and goods by motor vehicles, trains, ships and aircrafts; loading and unloading of ships, motor vehicles, railway carriages and airplanes; guarded transport of valuables; services of an agency in the field of transport, namely, arranging transport services by third parties as an agency; packaging of goods, especially repackaging and processing of goods for sale forwarding; storage of goods.

(260) AM 2018 93915 A

(800) 985227

(151) 2008 10 14

(891) 2017 06 28

(731) HENKEL AG & CO. KGAA

Henkelstraße 67, 40589 Düsseldorf, Germany

(540)

ESSENSITY

(591) Black, white

(511)

3 – Soaps, perfumery, essential oils, cosmetics, hair preparations for caring, cleaning, dyeing, tinting, bleaching, styling, fixing and perming; hair lotions and hair shampoos for cosmetical purposes.

(260) AM 2018 93917 A

(800) 1069606

(151) 2010 12 09

(891) 2017 05 22

(731) FIDIA FARMACEUTICI S.p.A.

Via Ponte della Fabbrica, 3/A, I-35031

ABANO TERME (PD), Italy

(540)

HyalOne

(591) Black, white

(531) 01.15.15; 26.01.13; 27.01.06; 27.05.05;
27.05.17

(511)

5 – Pharmaceutical, veterinary preparations; hygienic preparations for medical purposes; food and dietetic substances adapted for medical use, food for babies; plasters; materials for dressings; material for stopping teeth and dental wax; disinfectants; preparations for destroying vermin, fungicides, herbicides; none of the aforementioned being for use in ophthalmic surgery, or other treatments of the eye.

(260) AM 2018 93918 A

(800) 1083339

(151) 2011 05 12

(891) 2017 05 11

(731) CALEND A SPA

Via E. Fermi, 52, I-35030 VEGGIANO (PD), Italy

(540)

PALCO

(591) Black, white

(531) 27.05.01; 27.05.17

(511)

3 – Cosmetics, hair creams, hair oils, essential oils, toilet soaps, perfumes, hair lotions, hair dyes, hair gel, hair spray, hair shampoo.

(260) AM 2018 93920 A

(800) 1146796

(151) 2012 10 19

(891) 2017 03 13

(731) XTI FOOTWEAR, S.L.

Polígono Industrial Las Teresas, c/ Miguel

Servet, s/n, E-30510 Yecla (Murcia), Spain

(540)

REFRESH

(591) Black, white

(511)

25 – Clothing, footwear (except orthopedic), headgear.

(260) AM 2018 93922 A

(800) 1194991

(151) 2013 12 16

(891) 2017 06 28

(731) HENKEL AG & CO. KGAA

Henkelstr. 67, 40589 Düsseldorf, Germany

(540)



(591) Grey, red and black

(531) 27.05.10; 27.05.17; 29.01.13

(511)

3 – Soaps; perfumery goods, essential oils, cosmetics; hair lotions; dentifrices.

(260) AM 2018 93924 A

(800) 1235376

(151) 2014 12 24

(891) 2017 08 07

(731) FRIESLANDCAMPINA NEDERLAND B.V.

Stationsplein 4, NL-3818 LE Amersfoort,

Netherlands

(540)



- (591) Several shades of green, gold and white
 (531) 24.01.13; 24.01.15; 26.01.06; 26.02.05;
 26.15.25; 29.01.13
 (511)
 5 – Food for babies, infants and toddlers; dietetic food.
 20 – Milk and milk products including milk powder.

- (260) AM 2018 93925 A
 (800) 1235377
 (151) 2014 12 24
 (891) 2017 08 07
 (731) FRIESLANDCAMPINA NEDERLAND B.V.
 Stationsplein 4, NL-3818 LE Amersfoort,
 Netherlands
 (540)



- (591) Several shades of blue, gold and white
 (531) 24.01.03; 24.01.13; 24.01.15; 25.07.06;
 25.07.07; 26.01.06; 26.02.05; 26.02.07;
 26.15.01; 26.15.25; 29.01.13
 (511)
 5 – Food for babies, infants and toddlers; dietetic food.
 29 – Milk and milk products including milk powder.

- (260) AM 2018 93926 A
 (800) 1283901
 (151) 2015 12 01
 (891) 2017 08 09
 (731) LAFARGEHOLCIM LTD
 Zürcherstrasse 156, CH-8645 Jona,
 Switzerland
 (540)



LafargeHolcim

- (591) Black, white
 (531) 27.05.10; 27.05.17; 27.05.22
 (511)
 1 – Chemical products for use in industry and science, including chemical products for use in the concrete and cement industry; unprocessed artificial re-

sins, unprocessed plastics; adhesives for use in industry.

19 – Non-metallic building materials including concrete, cement and clinker; components and additives (included in this class) for the above-mentioned goods, particularly additives for concrete; non-metallic rigid pipes for building; asphalt, pitch and bitumen; transportable buildings not of metal; monuments not of metal.

42 – Development, project planning and consultancy services as well as services provided by architects, engineers or chemists in the field of manufacture and treatment of construction materials such as concrete, as well as in the field of building and civil engineering; expert chemical appraisals.

- (260) AM 2018 93927 A
 (800) 1289185
 (151) 2015 12 18
 (891) 2017 07 04
 (731) Obshchestvo s ogranichennoy
 otvetstvennostyu "WALL-STREET"
 pom. 7N, d. 20, ul. Shornaya 220004 Minsk,
 Belarus
 (540)

GREENFIELD

- (591) Black, white
 (531) 27.05.17
 (511)
 33 – Alcoholic beverages (except beers).

- (260) AM 2018 93928 A
 (800) 1294552
 (151) 2016 02 05
 (891) 2017 05 03
 (731) NINGBO KEYROAD STATIONERY &
 GIFT CO., LTD.
 No.111 Dingxiang Road, Hi-Tech District,
 Ningbo City, 315040 Zhejiang Province,
 China

(540)
KEYROAD

- (591) Black, white
 (531) 27.05.01; 27.05.17
 (511)
 16 – Stationery; writing instruments; drawing instruments; adhesives [glues] for stationery or household purposes; stapling presses [office requisites]; paper; pictures; hygienic paper; note books; packing paper; files [office requisites]; ink; fountain pens; gummed tape [stationery]; square rulers; drawing sets; drawing materials; stamp pads.

- (260) AM 2018 93929 A
 (800) 1301224
 (151) 2016 02 11
 (891) 2017 05 26
 (731) OLBO Limited
 d. 10A, str. 1, pr. 1-y Irtyshtsky, RU-107143
 Moscow, Russian Federation
 (540)



- (591) Black and bronze
 (531) 02.01.08; 02.01.23; 02.03.08; 02.03.23;
 26.01.01; 26.01.14; 27.05.01; 27.05.09;
 27.05.19; 29.01.12
 (511)
 3 – Nail polish, lipsticks; cosmetic hair lotions.

- (260) AM 2018 93930 A
 (800) 1311286
 (151) 2016 03 25
 (891) 2017 06 09
 (731) JINJIANG JIUFULONG SHOES CO., LTD
 No.113 South District, Yangmao Village,
 Chidian Town, Jinjiang City, Quanzhou,
 Fujian, China
 (540)

Adadila

- (591) Black, white
 (531) 27.05.17
 (511)
 25 – Clothing; football shoes; shoes; sports shoes;
 soles for footwear; insoles; mountaineering boots;
 spiked shoes; sandals; slippers.

- (260) AM 2018 93932 A
 (800) 1313223
 (151) 2016 05 11
 (891) 2017 06 27
 (731) SCHÄRF COFFEESHOP GMBH
 Dr. Alexander Schärf Platz 1, A-7100
 Neusiedl am See, Austria
 (540)



- (591) Black, white
 (531) 01.15.05; 05.07.01; 26.04.15; 26.04.24
 (511)
 30 – Coffee; coffee-based beverages; tea; ice tea;
 non-medicated herbal teas; coffee substitutes; herbal
 coffee substitutes; cocoa; cocoa-based beverages;
 cocoa preparations; chocolate; chocolate-based be-
 verages; coffee beverages with milk; cocoa bever-
 ages with milk; chocolate beverages with milk; coffee
 flavours; herbal flavours for beverages, except es-
 sential oils; essences for nutritional purposes, except
 essential essences and oils; syrups for flavouring
 coffee beverages.
 43 – Services for providing food and drink; tempo-
 rary accommodation; café, cafeteria and restaurant
 services.

- (260) AM 2018 93935 A
 (800) 1361120
 (151) 2017 05 24
 (891) 2017 05 24
 (731) DOUBLESTAR GROUP CO., LTD
 No.5 of Guizhou Road, Shinan District,
 Qingdao City Shandong Province, China
 (540)

DOUBLESTAR

- (591) Black, white
 (531) 01.01.03; 01.01.10; 27.05.08; 27.05.24
 (511)
 12 – Vehicles for locomotion by land, air, water or
 rail; automobile tires [tyres]; treads for retreading
 tires [tyres]; pneumatic tires [tyres]; inner tubes for
 bicycles, cycles; repair outfits for inner tubes; pat-
 ches (adhesive rubber -) for repairing inner tubes; ti-
 res for vehicle wheels; airplane tyre; non-skid devi-
 ces for vehicle tires [tyres].

- (260) AM 2018 93936 A
 (800) 1361130
 (151) 2017 05 25
 (891) 2017 05 25
 (731) SHISEIDO COMPANY, LIMITED
 7-5-5 Ginza, Chuo-ku, Tokyo 104-0061, Japan
 (540)

SHISEIDO
ESSENTIAL ENERGY

- (591) Black, white
 (531) 27.05.01; 27.05.10
 (511)
 3 – Soaps; cosmetics; perfumery; incenses and frag-
 rances; dentifrices; false nails; false eyelashes.

(260) AM 2018 93937 A
 (800) 1361143
 (151) 2017 04 07
 (891) 2017 04 07
 (731) MIRAGE GRANITO CERAMICO S.P.A.
 Via Giardini Nord, 225, I-41026 Pavullo
 nel Frignano (MO), Italy

(540)

MIRAGE

(591) Black, white
 (531) 27.05.17
 (511)
 20 – Work surfaces; table tops; counter tops for kitchens; counter tops for use with sinks; wall shelves; furniture shelves.

(260) AM 2018 93939 A
 (800) 1361159
 (151) 2017 03 29
 (891) 2017 03 29
 (731) HEKTAS TICARET TURK ANONIM
 SIRKETI
 Organize Sanayi Bolgesi 700, Sokak,
 TR-41480 Gebze Kocaeli, Turkey

(540)



(591) white, green
 (531) 05.07.02; 26.04.15; 26.04.24; 27.05.24;
 29.01.12

(511)
 5 – Pharmaceutical and veterinary preparations for medical purposes; chemical preparations for medical and veterinary purposes, chemical reagents for pharmaceutical and veterinary purposes; dietary supplements for pharmaceutical and veterinary purposes; dietary supplements; nutritional supplements; medical preparations for slimming purposes; food for babies; herbs and herbal beverages adapted for medicinal purposes; dental preparations and articles; teeth filling material, dental impression material, dental adhesives and material for repairing teeth; sanitary preparations for medical use; feminine hygiene pads; menstruation tampons; tampons for medical purposes; plasters; materials for dressings; diapers, including those made of paper and textiles; preparations for destroying vermin; fungicides, herbicides; deodorants, other than for human beings or for animals; air deodorizing preparations; disinfectants; antiseptics; detergents for medical purposes.

(260) AM 2018 93940 A
 (800) 1361219
 (151) 2017 06 06
 (891) 2017 06 06
 (731) ASLAN KHABLIEV
 Avenue Général Guisan 60, CH-1009 Pully,
 Switzerland

(540)

equos

(591) Black, white
 (511)
 36 – Financial affairs; monetary affairs; banking services; investment banking services; Internet banking; financial services; consultancy services relating to personal finances; financing of securities; brokerage services in relation to capital investments; fund investment; capital management; services provided by consultants relating to capital investment; venture capital financing services for commercial companies, research institutions, universities and inventors; equity investment in commercial companies, research institutions, universities and inventors; capital investment; capital investment in real estate; venture capital brokerage services; provision of loan and credit facilities; providing credit and loans; financial services relating to the provision and structuring of capital; private banking services; fund management for private clients; financial trust management.

(260) AM 2018 93941 A
 (800) 1314310
 (151) 2016 05 11
 (891) 2017 06 27
 (731) SCHÄRF COFFEESHOP GMBH
 Dr. Alexander Schärf Platz, 1 A-7100
 Neusiedl am See, Austria

(540)



(591) Black, white
 (531) 01.15.05; 05.07.01
 (511)
 30 – Coffee; coffee-based beverages; tea; ice tea; non-medicated herbal teas; coffee substitutes; herbal coffee substitutes; cocoa; cocoa-based beverages; cocoa preparations; chocolate; chocolate-based beverages; coffee beverages with milk; cocoa beverages with milk; chocolate beverages with milk; coffee flavours; herbal flavours for beverages, except essential oils; essences for nutritional purposes, except

essential essences and oils; syrups for flavouring coffee beverages.

43 – Services for providing food and drink; temporary accommodation; café, cafeteria and restaurant services.

(260) AM 2018 93942 A

(800) 1331489

(151) 2016 09 16

(891) 2017 06 16

(731) JCB CO., LTD.

5-1-22 Minami Aoyama, Minato-ku, Tokyo
107-8686, Japan

(540)

J/Speedy

(591) Black, white

(531) 26.11.09; 27.05.01; 27.05.08; 27.05.17

(511)

36 – Credit card services including electronic payment processing via computer networks or electronic media; providing information of credit card statements; issue of prepaid cards; debit card services including electronic payment processing via computer networks or electronic media; electronic funds transfer for electronic payments; financing services, namely, cash advances and loan services in credit card services; rental of card-readers, card-writers and payment processing machines and equipment used for credit cards or debit cards; agencies for recruitment and management of credit card members and merchants (member stores) on behalf of credit card issuers.

(260) AM 2018 93943 A

(800) 1341710

(151) 2017 01 17

(891) 2017 05 09

(731) ADP GAUSELMANN GMBH

Merkur-Allee 1-15, 32339 Espelkamp,
Germany

(540)

221b Baker Street

(591) Black, white

(511)

9 – Scientific, nautical, surveying, photographic, cinematographic, optical, weighing, measuring, signalling, checking (supervision), life-saving and teaching apparatus and instruments; apparatus and instruments for conducting, switching, transforming, accumulating, regulating or controlling electricity; apparatus for recording, transmission or reproduction of sound or images; magnetic data carriers, recording discs; compact discs, DVDs and other digital recording media; cash registers, calculating ma-

chines, data processing equipment, computers; computer software; fire-extinguishing apparatus; musical jukeboxes and parts for the aforesaid automatic machines; automatic cash dispensers, automatic money counting and money changing machines; coin-operated mechanisms; computer and video games software; games software for use on any computer platform, including electronic entertainment and games consoles; computer game programs; computer games programs; video games (software); computer games provided through a global computer network or supplied by means of multi-media electronic broadcast or through telecommunications or electronic transmission or via the internet; computer games, leisure and recreational software, video games and computer software, all being provided in the form of storage media; programs for operating electric and electronic apparatus for games, amusement and/or entertainment purposes; automatic lottery machines; computer software for computer games on the internet; online games (software), in particular for online betting games, online prize games, online gambling games, online games of skill and online casino games; computer software in the form of an app for mobile devices and computers; calculating apparatus in coin-operated machines and parts for the aforesaid goods; apparatus for recording, transmission, processing or reproduction of data, including sound or images, including parts for all the aforesaid goods, except radio sets, television receivers, hi-fi systems, video recorders, telephone apparatus, fax machines and telephone answering machines; computer hardware and software for casino and amusement arcade games, for gaming machines, slot machines or video lottery gaming machines or games of chance via the internet; electric, electronic, optical or automatic apparatus, for identifying data carriers, identity cards and credit cards, bank notes and coins; electric, electronic or optical alarm and monitoring installations, including video cameras and apparatus for image transmission and image processing; data processing apparatus and computers, including data processing apparatus and computers being components for data networks and parts facilitating data network communications; electric wiring harnesses; circuit boards, printed circuit boards (electronic components) and combinations thereof being assemblies and equipment parts for apparatus, included in this class.

(260) AM 2018 93944 A

(800) 1361236

(151) 2017 01 23

(891) 2017 01 23

(731) LENZING AKTIENGESELLSCHAFT

Werkstr. 2, A-4860 Lenzing , Austria

(540)

TENCEL

(591) Black, white

(511)

22 – Raw textile fibers and substitutes; liber; raw cotton; treated wool; chemical fibers for textile use; fibres being partly prepared synthetic materials for textile use; fibres being raw synthetic materials for textile use; silk flock; yarn fibers; twisted cords [sash]; raw fibrous textile; scoured wool; semi-synthetic fibers [for textile use]; true hemp fiber [raw]; rabbit hair; jute; jute fiber [raw]; combed wool; kasimir hair; linters; raw fibrous textile materials treated with flame retardants; mohair; natural fibers; polyester stuffing fibers; polyester filament; polyester plastic netting for packaging goods; vitreous silica fibers for textile use; raffia fibers; ramie fibre; raw textile fibers; raw fibres of plastics for textile use; linen (raw -) [flax]; raw silk; raw wool; silk waste; shorn wool; silk fibers; silk polyester monofilaments for textile use; carded wool; synthetic fibers for textile use; synthetic fibers for textile use; synthetic textile filaments; textile filaments; textile fibers; non-woven textile fibres; fibres for making up into carpets; fibres for making up into carpet tiles; viscose silica fibres; raw or treated wool; wool flock; bags and sacks for packaging, storage and transport; liners for use in bulk containers; bags and sacks for packaging, storage and transport; nets; plant hangers of rope; slings and bands; strips for tying-up vines; wrapping or binding bands, not of metal; hammocks; storage bags for holding a body prior to cremation; mesh bags for washing lingerie; mesh bags for storage; packaging bags [sacks] of textile for bulk transportation; packaging bags [sacks] of textile for bulk storage; sacks; sacks made of textile materials; sacks for transporting waste; sacks for the transport of materials; sacks for the storage of materials in bulk; sacks and bags (not included in other classes); sacks for the storage of materials; bags [sacks] for the transport and storage of materials in bulk; non-textile bags for the transportation of materials in bulk; non-textile bags for the bulk storage of animal foodstuffs; non-textile bags for the bulk storage of materials; shoe bags for storage; sail cloth; textile wine gift bags; protection pouches made of fabric for storing purses when not in use; bags [envelopes, pouches] of textile, for packaging; bags [envelopes, pouches] of textile, for packaging; bags [envelopes, pouches] of textile, for packaging; packaging nets for transporting fruits and vegetables; bags [envelopes, pouches] of textile, for packaging; textile bags for merchandise packaging [envelopes, pouches]; tarpaulins, awnings, tents, and unfitted coverings; tents for use in angling; tents for camping; vehicle covers, not fitted; unfitted covers for boats and marine vehicles; tarpaulins; tents; tents [awnings] for vehicles; tents [awnings] for caravans; tents made of textile materials; tents for mountaineering or camping; sails; material for making sails; ropes and strings; binding thread, not of metal, for

agricultural purposes; thread, not of metal, for wrapping or binding; strings; twine made of polypropylene; twine made of sisal; non-metallic twines; strings for tying purposes; packaging string; macrame rope; yarns for use in tyre cord construction; cordage; ropes and synthetic ropes; rope for use in toys for pets; synthetic ropes; cordage; ropes, not of metal; baling twine; packing rope; nets; elastic netting for meat products; hemp nettings; netting [not of metal or asbestos]; nets for windbreak purposes; chemical fiber nettings; rockfall prevention nets of textile; commercial fishing nets; commercial nets; nets for use with floating structures; twine for nets; net pens for fish farming; nets for shading; silk netting; fitted nets; padding and stuffing materials; down feathers; feathers for stuffing upholstery; wadding for filtering; fillings of synthetic fibres; fillings for upholstered pillows; fillings of synthetic foam; fillings for duvets; fillings for pillows; fillings for quilts; wood shavings; kapok; loose feathers; padding and stuffing materials (except of paper, cardboard, rubber or plastics); materials for padding; padding materials, other than of rubber or plastic for pillows; padding materials, other than of rubber or plastic for sleeping bags; padding materials made of fibrous material; padding materials made of fibrous material; padding made of non woven fabrics; padding materials, other than of rubber or plastic for beds; polyester batting; sawdust; sisal; sisal fibers; industrial packaging containers of textile; fleece for the upholstery industry; wadding for padding and stuffing upholstery; wadding fibres; wool (upholstery -) [stuffing]; stuffing, not of rubber, plastics, paper or cardboard; spun polyester fibre for textile use.

23 – Yarns and threads; angora yarn; spools of thread; spools of yarn; spun cotton; cotton yarn; cotton yarn; chenille yarn; chenille yarn; douppioni silk yarn; elastic thread; elastic thread and yarn for textile use; elastic strips of synthetic fibres for textile use; threads made of spun cotton; thread for textile use; textile filaments [threads]; flocked fibers; yarn; yarns made of angora for textile use; waste cotton yarn; polyester pre-oriented yarns; yarns made of carbon fibres for textile use; yarn of synthetic or mixed fibres for use in textiles; wild silk yarn; knitting yarns; yarns for domestic use; yarns for textile applications; inorganic fiber base mixed thread and yarn; cotton base mixed thread and yarn; chemical fiber base mixed thread and yarn; chemical-fiber threads and yarns for textile use; degreased waste threads and yarns; hemp base mixed thread and yarn; regenerated fiber thread and yarn [for textile use]; silk base mixed thread and yarn; synthetic fiber thread and yarn; wool base mixed thread and yarn; yarns and threads for textile use; yarns for sale in kit form; twisted cotton thread and yarn; twisted threads and yarns; twisted hemp thread and yarn; twisted silk thread and yarn; twisted wool thread and yarn; yarns

(combed -) made of natural fibres; twisted mixed thread and yarn; worsted yarn; spun silk yarn; semi-synthetic fiber thread and yarn [chemically treated natural fiber yarn]; hand knitting wools; true hemp thread and yarn; heat-stable yarns and threads; jute thread and yarn; camel hair yarn; carded threads in flax for textile use; carded yarns of hemp for textile use; carded threads in natural fibres for textile use; yarns (carded -) made of wool; carded threads in wool for textile use; carded threads in wool for textile use; cashmere yarns; ceramic fibre yarns for textile use; coir thread and yarn; rayon thread and yarn; linen thread and yarn; linen thread and yarn; metal fiber thread for textile use; sewing thread for textile use; sewing thread and yarn; natural yarns; non-metallic yarns for textile use; silica threads; ramie thread and yarn; raw silk yarn; spun silk; silk yarn; embroidery thread and yarn; knitting yarns; knitting yarns made of acrylic materials; knitting yarns made of nylon; knitting yarns made of wool; polyester textured yarns; yarns made of synthetic material for textile use; synthetic threads; carpet yarns; textile yarns; textile yarns made of man-made fibres; textile yarns made of natural fibres; covered rubber thread and yarn [for textile use]; mixed spun threads and yarns; waxed thread; waxed yarn; weaving fibres for industrial use; spun thread and yarn; worsted; wool yarn; wool yarn.

24 – Flocked fabrics; fabrics being textile piece goods for use in tapestry; tick [linen]; knitted elastic fabrics for ladies underwear; knitted elastic fabrics for bodices; knitted elastic fabrics for sportswear; knitted elastic fabrics for gymnastic dresses; fibre fabrics for use in the manufacture of articles of clothing; fibre fabrics for the manufacture of the exterior coverings of furniture; fibre fabrics for use in the manufacture of linings of shoes; fibre fabrics for use in the manufacture of linings of bags; felt; felt for use by papermakers; felt cloth; flame retardant fabrics [other than asbestos]; flannel [fabric]; towelling [textile]; linings [textile]; inlay materials of non-woven fabrics; chemical fiber fabrics; fabrics for textile use; knit lace fabrics; knitted fabric; gummed waterproof cloth; towelling [textile]; linens; jersey [fabric]; jersey [fabric]; fabrics of carbon fibre, other than for insulation; fabrics [textile piece goods] made of carbon fibre; fabrics made from artificial fibres [other than for insulation]; upholstery fabrics; furnishing fabrics in the piece; furnishing fabrics in the piece; woven furnishing fabrics; non-woven felts; silk fabrics for furniture; semi-synthetic fiber fabrics; fabrics of chemically produced fibres, other than for insulation; fabrics of organic fibres, other than for insulation; regenerated fiber yarn fabrics; fabrics made from artificial fibres [other than for insulation]; fabrics for use in making jerseys; knitted fabric; knitted fabrics of cotton yarn; knitted fabrics of chemical-fiber yarn; knitted fabrics of wool yarn; fabrics made of mixed synthetic and natural fibres,

other than for insulation; textile fabrics for use in the manufacture of beds; textile fabrics for making into linens; textile fabrics for use in the manufacture of bedding; textile fabrics for making into blankets; textile fabrics for use in the manufacture of furniture; textile fabrics for use in the manufacture of sheets; textile fabrics for use in the manufacture of towels; textile fabrics for use in the manufacture of pillowcases; textile piece goods for making bedding covers; textile piece goods for making-up into towels; cloth; tissues being textile piece goods; velours for furniture; non-woven fabrics; non-woven textile fabrics; non-woven textile fabrics; non-woven textile fabrics for use as interlinings; non-woven fabrics of natural fibres; non-woven fabrics of synthetic fibres; non-woven fabrics in the form of sheeting for use in manufacture; woven fabrics for furniture; textile goods, and substitutes for textile goods; nightdress cases of textile; printers' blankets of textile; disposable cloths; linings [textile]; linen lining fabric for shoes; wall fabrics; fabrics for textile use; household textile articles made from non-woven materials; linens; nightdress cases of textile; ticks [mattress covers]; coverings for furniture; mosquito nets; non-woven textile articles; dust sheets; textile tissues; textiles made of flannel; non-woven textile articles; interlinings made of non-woven fabrics; coverings for furniture; furniture coverings (unfitted); loose covers made of textile materials for furniture; furniture coverings of textile; dust sheets; loose covers made of textile materials for furniture; draperies [thick drop curtains]; curtains; markers [labels] of cloth for textile fabrics; wall fabrics; wall hangings of textile; bed linen; bed linen; towelling [textile]; towels of textile; kitchen and table linens; towels of textile; hand towels of textile; bed linen and table linen; tea cloths; dish towels for drying; towelling [textile]; hand towels of textile; place mats, not of paper; textile smallwares [table linen]; table covers; table cloths (not of paper); tablemats, not of paper; table covers of non-woven textile fabrics; textile napkins; table linen, not of paper; napery of textile; table linen; washing gloves; bed linen; receiving blankets; bed linen and table linen; bed covers; duvet covers; comforters; bed blankets made of cotton; bed blankets made of man-made fibres; bed covers of paper; silk bed blankets; woolen blankets; duvet covers; bed sheets; bed skirts; bed throws; fabric bed valances; bed linen made of non-woven textile material; infants' bed linen; covers for eiderdown and duvets; comforters; blankets for household pets; quilts; blankets for outdoor use; disposable bedding of textile; eiderdowns [down coverlets]; terry linen; sleeping bags [sheeting]; waterproof bed clothes; cot blankets; cot sheets; children's blankets; shams; lap rugs; contoured mattress covers; pillowcases; ticks (mattress and pillow coverings); mattress covers; mattress covers; quilts filled with down; duvets; travelling rugs [lap robes]; sleeping bag liners; silk

blankets; contour sheets; quilt bedding mats; textile quilts; quilts of textile; quilts filled with feathers; quilts filled with half down; quilts filled with stuffing materials; quilts filled with synthetic stuffing materials; quilt covers; textile covers for duvets; textile goods for use as bedding; bed sheets; bed throws; valanced bed sheets; bed skirts; woolen blankets; bath linen; hand towels of textile; bath towels; bath linen, except clothing; disposable wash cloths; towelling coverlets; face cloths of towelling; turkish towel; turkish towel; bath sheets; bath sheets; towelling [textile] adapted for use in dispensers; hand towels; towelling [textile]; hand towels of textile; children's towels; towelling [textile]; household linen, including face towels; make-up removal cloths [textile], other than impregnated with cosmetics; make-up removal cloths [textile], other than impregnated with toilet preparations; cloths of non-woven textile material for washing the body [other than for medical use]; bath mitts; mitts made of non-woven fabric for washing the body; wash cloths; cloths for washing the body [other than for medical use]; filtering materials of textile; bath sheets; cloths of woven textile material for washing the body (other than for medical use); flame resistant fabrics; furnishing fabrics; quilts.

25 – Headgear; swimming caps; bandanas [neckerchiefs]; baseball caps; berets; bobble hats; millinery; shower caps; fascinator hats; fedoras; fezzes; bucket caps; golf caps; yashmaks; bonnets [headwear]; tams; hats; frames (hat -) [skeletons]; skull caps; waterpolo caps; hoods [clothing]; small hats; knot caps; chefs' hats; sports headgear [other than helmets]; children's headwear; head scarves; head scarves; head scarves; yashmaghs; miters [hats]; fashion hats; caps [headwear]; cap peaks; sun visors [headwear]; nightcaps; hats (paper -) [clothing]; paper hats for wear by chefs; paper hats for wear by nurses; party hats [clothing]; fur muffs; fur hats; head scarves; rain hats; knitted caps; flat caps; garrison caps; sedge hats (suge-gasa); sleep masks; veils [clothing]; wimples; tam o'shanters; tennis sweatbands; ski hats; sun hats; sports caps and hats; sports caps; headbands [clothing]; head sweatbands; beach hats; knitted caps; balaclavas; thermal headgear; toques [hats]; head scarves; woolly hats; top hats; clothing; evening wear; evening coats; detachable neckpieces for kimonos (haneri); detachable collars; underarm gussets [parts of clothing]; aikido suits; albs; american football bibs; parkas; suits; evening suits; women's suits; bowties; dress pants; jumper suits; blouses; work clothes; coveralls; blouses; sleeveless jerseys; mantles; arm warmers [clothing]; gowns for doctors; warm-up pants; clothing made of fur; driving gloves; layettes [clothing]; layettes [clothing]; baby bodysuits; baby doll pyjamas; babies' pants [clothing]; plastic baby bibs; baby tops; baby bunting [clothing]; babies' pants [clothing]; baby bottoms; layettes [clothing]; pram suits; swimming cos-

tumes; bathing costumes for women; bathing suits for men; fitted swimming costumes with bra cups; swim wear for gentlemen and ladies; bathing drawers; swimming costumes; swimming costumes; bathrobes; bathing drawers; swimming trunks; wraps [clothing]; robes; ballet suits; ball gowns; bandanas [neckerchiefs]; bandeaux [clothing]; baseball uniforms; baselayer bottoms; baselayer tops; crop tops; printed t-shirts; leg warmers; cashmere clothing; clothing of imitations of leather; woolen clothing; motorists' clothing; baby clothes; bridesmaids wear; figure skating clothing; christening robes; clothing for wear in judo practices; children's wear; infant wear; girls' clothing; motorcyclists' clothing of leather; leather clothing; linen clothing; paper clothing; plush clothing; silk clothing; clothing for martial arts; clothing for horse-riding [other than riding hats]; articles of clothing for theatrical use; clothing for fishermen; boys' clothing; clothing for wear in wrestling games; maternity clothing; lounge pants; bermuda shorts; bed jackets; bed socks; maillots; maillots; blazers; blouses; boas [necklets]; leotards; body stockings; teddies [undergarments]; boleros; bolo ties; bomber jackets; boxer shorts; wedding dresses; burnouses; brassieres; bustiers; pea coats; capes; pedal pushers; car coats; cargo pants; chaps (clothing); chasubles; chemisettes; cheongsams (chinese gowns); albs; choir robes; evening wear; corduroy trousers; coverups; ladies' clothing; lingerie; gowns; womens' outerclothing; knickers; ladies' underwear; ladies' underwear; down jackets; down vests; denim jeans; topcoats; donkey jackets; three piece suits [clothing]; duffel coats; pocket squares; one-piece suits; jumper suits; one-piece playsuits; disposable underwear; skating outfits; athletic tights; woollen tights; pleated skirts for formal kimonos (hakama); masquerade costumes; women's ceremonial dresses; moisture-wicking sports bras; moisture-wicking sports shirts; moisture-wicking sports pants; fishing shirts; fishing vests; fleeces; fleece vests; bowties; flying suits; formal evening wear; formalwear; foulards [clothing articles]; morning coats; leisure suits; casual shirts; slacks; casualwear; tap pants; barber smocks; robes; replica football kits; football jerseys; soccer bibs; footmuffs, not electrically heated; gabardines [clothing]; goloshes; gaiters; morning coats; padded pants for athletic use; padded shirts for athletic use; padded shorts for athletic use; knitwear [clothing]; knitted gloves; knit jackets; knitted underwear; guernseys; woven clothing; woven shirts; gilets; polo shirts; golf trousers; golf pants, shirts and skirts; golf skirts; unitards; clothing for gymnastics; ankle socks; halloween costumes; neckbands; neckwear; scarves; neck tubes; wrist warmers; gloves [clothing]; gloves for cyclists; gloves with conductive fingertips that may be worn while using handheld electronic touch screen devices; gloves including those made of skin, hide or fur; handwarmers [clothing]; loungewear;

aloha shirts; button-front aloha shirts; shirt yokes; shirts; shirts for suits; collared shirts; open-necked shirts; button down shirts; nighties; slips [undergarments]; shirt-jacs; shirt fronts; men's suits; menswear; outerclothing for men; men's socks; men's underwear; waistcoats; wedding dresses; lumberjackets; hooded pullovers; knickers; trousers; trousers of leather; trousers for children; trousers for children; nurse pants; sweatpants; snowboard trousers; pantsuits; culotte skirts; knee-high stockings; braces for clothing [suspenders]; suspender belts for men; girdles; girdles; jackets [clothing]; jackets being sports clothing; polar fleece jackets; fishermen's jackets; sleeved jackets; sleeveless jackets; snowboard jackets; rainproof jackets; men's and women's jackets, coats, trousers, vests; jacket liners; hunting pants; hunting jackets; hunting vests; hunting shirts; kimonos; denims [clothing]; denim jeans; denim jackets; jumpers; jodhpurs; shell suits; jogging sets [clothing]; sweatpants; jogging tops; sweatpants; heavy jackets; stuff jackets [clothing]; judo suits; caftans; bodices [lingerie]; martial arts uniforms; combative sports uniforms; hooded sweatshirts; karate suits; cashmere scarves; kendo outfits; khakis; kilts; kilts; kimonos; gowns; pinafores; gowns; nurse dresses; linings (ready-made -) [parts of clothing]; pockets for clothing; leisurewear; bloomers; walking breeches; trouser socks; knee warmers [clothing]; short sets [clothing]; ready-to-wear clothing; basic upper garment of korean traditional clothes [jeogori]; korean traditional women's waistcoats [baeja]; korean topcoats [durumagi]; body warmers; corselets; camisoles; corsets; corsets; costumes; skirt suits; costumes for use in children's dress up play; costumes for use in role-playing games; shoulder wraps; detachable collars; collars for dresses; neckties; ascots; crinolines; cummerbunds; short-sleeved or long-sleeved t-shirts; short-sleeve shirts; short-sleeve shirts; short trousers; sweatpants; short petticoats; short overcoat for kimono (haori); cowls [clothing]; laboratory coats; long sleeve pullovers; long sleeved vests; long jackets; japanese sleeping robes (nemaki); full-length kimonos (nagagi); long johns; bibs, not of paper; bib overalls for hunting; running suits; running vests; leather suits; leather clothing; leather jackets; leather jackets; casual trousers; leggings [trousers]; sweat-absorbent underwear; light-reflecting jackets; lingerie; liveries; bathing suit cover-ups; outerclothing for girls; maniples; athletic uniforms; cuffs; coats; pelisses; cotton coats; coats of denim; coats for women; coats for men; mantillas; sleep masks; eye masks; sailor suits; corselets; foundation garments; miniskirts; monokinis; robes; lounging robes; motorcycle riding suits; motorcycle gloves; motorcycle jackets; muffs [clothing]; muumuus; nighties; nighties; nighties; nightwear; wet suits; negligees; pop socks; womens' outerclothing; outerclothing; dress shirts; uppers of woven rattan for japanese style sandals; chemise

tops; cycling tops; hooded tops; halter tops; earbands; ear muffs [clothing]; combinations [clothing]; coveralls; coveralls; nurse overalls; overshirts; beach wraps; parkas; pelerines; furs [clothing]; pelisses; fur coats and jackets; fur muffs; fur cloaks; petticoats; petti-pants; polo shirts; pirate pants; plastic aprons; pantaloons; polo shirts; polo knit tops; turtleneck sweaters; polo sweaters; ponchos; sweaters; crew neck sweaters; mock turtleneck sweaters; v-neck sweaters; slipovers [clothing]; bloomers; pyjamas; pajama bottoms; cyclists' clothing; cycling shorts; ramie shirts; rash guards; head scarves; rainproof clothing; rainwear; waterproof trousers; mackintoshes; rain ponchos; riding gloves; jodhpurs; riding jackets; skirts; turtlenecks; roll necks [clothing]; turtleneck shirts; turtleneck sweaters; rugby tops; rugby shorts; rugby tops; bushjackets; saris; sarongs; sheepskin jackets; sheepskin coats; neck scarfs [mufflers]; mufflers [clothing]; shawls [from tricot only]; shawls and headscarves; shawls and stoles; sashes for wear; sash bands for kimono (obi); referees uniforms; nightwear; sleep masks; nighties; tube tops; veils [clothing]; cravats; knickers; snow suits; snow suits; snow pants; shoulder scarves; shoulder wraps [clothing]; school uniforms; aprons [clothing]; paper aprons; maternity bands; maternity smocks; sweat-absorbent socks; sweat-absorbent stockings; sweatbands; sweat bands for the wrist; headbands [clothing]; dress shields; anti-perspirant socks; head sweatbands; uniforms for nurses; swimming trunks; silk ties; silk scarves; adhesive bras; shampoo capes; shell jackets; shift dresses; mock turtleneck shirts; shirts and slips; shortalls; shorts; fleece shorts; boy shorts [underwear]; snow suits; ski suits for competition; ski gloves; ski trousers; ski jackets; clothing for skiing; ski balaclavas; sliding shorts; briefs; cummerbunds; dinner jackets; dinner suits; snow boarding suits; snowboard gloves; japanese style socks (tabi); socks and stockings; sock suspenders; bralettes; sundresses; sunsuits; playsuits [clothing]; camiknickers; gym suits; sports clothing [other than golf gloves]; sportswear; sports bras; casual shirts; sports shirts with short sleeves; sports pants; sports jackets; sports socks; singlets; sports jerseys and breeches for sports; gym suits; athletics vests; dust coats; quilted jackets [clothing]; quilted vests; cloth bibs; cloth bibs for adult diners; tightening-up strings for kimonos (datejime); rompers; snap crotch shirts for infants and toddlers; beachwear; beach robes; stretch pants; knitwear [clothing]; knit shirts; cardigans; thongs; garters; stockings; sweat-absorbent stockings; heelpieces for stockings; pantie-girdles; tights; maillots [hosiery]; footless tights; hosiery; footless socks; surfwear; jockstraps [underwear]; sweaters; tracksuit bottoms; sweat jackets; sweat shirts; sweat shorts; taekwondo suits; waist cinchers; tank tops; dance clothing; dance costumes; tabards; camouflage gloves; camouflage shirts; camouflage pants; camouflage jackets; camouflage

vests; trews; tennis wear; tennis shirts; tennis dresses; tennis pullovers; tennis skirts; tennis shorts; tennis socks; fabric belts [clothing]; thobes; theatrical costumes; thermal socks; thermal underwear; togas; tops [clothing]; folk costumes; japanese traditional clothing; bra straps; bib tights; pinafore dresses; strapless bras; tank tops; clothing for gymnastics; sweatpants; sweat shorts; tracksuit tops; trench coats; bib shorts; triathlon clothing; knitwear [clothing]; singlets; dry suits; tee-shirts; kerchiefs [clothing]; neckerchiefs; head scarves; tunics; turbans; clothing for gymnastics; gym shorts; tutus; twin sets; korean outer jackets worn over basic garment [magoja]; nappy pants [clothing]; topcoats; over-trousers; neck scarves; cloaks; shawls; maternity clothing; maternity sleepwear; maternity lingerie; uniforms; uniforms for commercial use; uniforms for nurses; referees uniforms; union suits; underwear; babies' undergarments; sweat-absorbent underwear; vest tops; undershirts for kimonos (juban); undershirts for kimonos (koshimaki); bottoms [clothing]; pants; chemises; petticoats; bustles for obi-knots (obiage-shin); tracksuit bottoms; underwear; garments for protecting clothing; suit coats; volleyball jerseys; thermally insulated clothing; warm-up jackets; warm-up tops; weatherproof clothing; waterproof suits for motorcyclists; waterproof capes; waterproof outerclothing; water socks; waterproof trousers; rainproof jackets; oilskins [clothing]; wetsuits for water-skiing; chefs' whites; white coats for hospital use; caftans; sweat shirts; reversible jackets; waistcoats; leather waistcoats; cagoules; weatherproof clothing; sailing wet weather clothing; puttees and gaiters; wrap belts for kimonos (datemaki); beach wraps; beach wraps; swaddling clothes; saloppes; windproof clothing; wind suits; wind pants; windshirts; wind vests; winter gloves; winter coats; hosiery; weather resistant outer clothing; woollen socks; yoga pants; yoga shirts; zoot suits; gussets [parts of clothing]; gussets for bathing suits [parts of clothing]; gussets for footlets [parts of clothing]; gussets for leotards [parts of clothing]; gussets for stockings [parts of clothing]; gussets for tights [parts of clothing]; gussets for underwear [parts of clothing]; footwear; heels; heelpieces for footwear; bootees (woollen baby shoes); bath slippers; footwear for women; insoles for footwear; espadrilles; heel inserts; flat shoes; embossed heels of rubber or of plastic materials; embossed soles of rubber or of plastic materials; non-slipping devices for footwear; slippers; slipper socks; stiffeners for shoes; inner socks for footwear; running shoes; infants' footwear; leather slippers; leather shoes; canvas shoes; deck shoes; uppers for japanese style sandals; slippers; pumps [footwear]; welts for footwear; rain boots; riding shoes; riding shoes; shoe straps; rugby boots; mules; slip-on shoes; shoes; athletic shoes; leisure shoes; shoes for foot volleyball; shoes with hook and pile fastening tapes; high-heeled shoes; mountai-

neering shoes; shoe inserts for non-orthopedic purposes; shoe uppers; footwear soles; shoe covers, other than for medical purposes; footwear uppers; snowboard shoes; shoe soles; slipper soles; soles for japanese style sandals; espadrilles; dance shoes; ballroom dancing shoes; tennis shoes; training shoes; tips for footwear; waterproof boots for fishing; aqua shoes; winter boots; yoga shoes; zori; tongues for shoes and boots; intermediate soles; pyjamas [from tricot only]; ladies' underwear; braces for clothing [suspenders]; underwear; wetsuit gloves.

(260) AM 2018 93948 A

(800) 1361331

(151) 2017 04 12

(891) 2017 04 12

(731) WIKOLIA INVESTMENTS LIMITED

Arch.Makariou III & Vyronos, P.Lordos
Center, Block B, 1st floor Flat/Office 103,
Neapoli CY-3105 Limassol, Cyprus

(540)



(591) Dark blue, bright green, white.

(531) 26.01.01; 26.01.04; 26.01.18; 27.05.21;
29.01.13

(511)

35 – Sales promotion for others; wholesale and retail store services.

(260) AM 2018 93950 A

(800) 1361361

(151) 2017 07 17

(891) 2017 07 17

(731) APPLE INC.

1 Infinite Loop, Cupertino CA 95014, USA

(540)

MACBOOK AIR

(591) Black, white

(511)

9 – Computers, notebook computers, computer hardware, computer operating system software, computer peripherals.

(260) AM 2018 93951 A

(800) 1361371

(151) 2017 04 09

(891) 2017 04 09

- (731) AIGO Sàrl
c/o PETROSCA Sàrl, Route de Chancy 28,
CH-1213 Petit Lancy, Switzerland
(540)

HELVEK

- (591) Black, white
(511)
7 – Filters (parts of machines, motors or engines), air purifiers (parts of motors or engines), air filters for automobile engines, fuel filters, oil filters for motors or engines, filters for cleaning cooling air for motors or engines, hydraulic filters for automobile engines; air compressors; compressed air pumps and their accessories (garage installations).
12 – Vehicles, including parts and accessories, included in this class, apparatus for locomotion by land, air or water, tires for motorcycles, repair kits, rims, wheels, wheel holders, non-skid devices for tires, not included in other classes; air pumps; deflation warning bells.
37 – Maintenance, overhaul, tuning and repair of motors and engines; automobile customization services.

- (260) AM 2018 93952 A
(800) 1361419
(151) 2017 04 17
(891) 2017 04 17
(731) HUGEL INC.
61-20, SINBUK-RO, SINBUK-EUP,
CHUNCHEON-SI, GANGWON-DO,
REPUBLIC OF KOREA, Republic of Korea
(540)

DERMALAX

- (591) Black, white
(511)
5 – Prefilled injectors with artificial materials for subcutaneous infusion; injectors, including, but not limited to, pre-filled syringes, in the form of a gel, sold alone or in a kit, for use in treating wrinkles, folds, scars and lips, for face and body contouring and for rejuvenating the skin; hypodermic syringes containing pharmaceuticals for the treatment and improvement of skin defect; skin fillers; filler for plastic surgery; filler for urology; filler for dermatology; body filler for plastic surgery; filler for enlarging penis; biomaterials for tissue restoration; pre-filled syringes for use in treating wrinkles, folds, scars and lips, for face and body contouring and for rejuvenating the skin; pre-filled syringes in the form of a gel sold alone or in a kit, for use in treating wrinkles, folds, scars and lips, for face and body contouring and for rejuvenating the skin; pre-filled syringe comprised of hyaluronic acid; filler for dermatology comprised of a pre-filled syringe containing a hyaluronic acid; pre-filled syringes containing

pharmaceutical preparations for the treatment and management of skin and soft tissue and prostheses, namely, hyaluronic acid or modified hyaluronic acid or one of its derivatives or salts or other skin or tissue filling materials; pre-filled syringes for medical purposes.

10 – Medical injection syringe; medical apparatus for introducing pharmaceutical preparations into the human body; injection device for pharmaceuticals; injectors for medical purposes; syringes for medical purposes; surgical apparatus and instruments; automatic injectors for medical purposes; skin infusion apparatus including surgical implants; surgical prostheses; medical apparatus for facilitating the inhalation of pharmaceutical preparations; dermatoplastic instruments; syringes for injections for the skin; medical apparatus used for treatment with carbon gases for cosmetic surgery; surgical instruments for use in cosmetic surgery, dermatology and treatment of wound; medical apparatus and instruments for the treatment of skin; cases fitted for medical instruments; spittoons for medical purposes; electric esthetic massage apparatus; implants for skin regeneration; urological apparatus and instruments; penis prostheses; medical filling apparatus; injection syringes for fillers; filler injection apparatus for medical purposes; implants consisting of artificial materials; medical filling apparatus for hyaluronate acid or modified hyaluronate acid; endoprotheses; artificial breast implants; supporters for medical purposes; surgical implant comprised of artificial materials; artificial skin for surgical purposes; medical drapes; compression bandages; medical apparatus and instruments; medical apparatus and instruments other than for dental purposes; suture for medical purpose; lifting thread for medical purpose; suture; body insertion thread; surgical thread; dental apparatus and instruments; thread for medical purpose; needle for medical purpose; body rehabilitation apparatus for medical purposes; injection needles for medical use; artificial jaws; disposable syringes; syringes for injections; hypodermic syringes; artificial orthopedic implants; medical, surgical and orthopaedic implants made of artificial materials; orthopaedic articles; medical apparatus; medical apparatus and instruments for plastic surgery; implants for use in treating wrinkles, folds, scars and lips, for face and body contouring and for rejuvenating the skin; medical device for use of filling out skin or tissue of body or face, including, but not limited to, wrinkles, folds, scars and lips.

- (260) AM 2018 93954 A
(800) 1361460
(151) 2017 02 22
(891) 2017 02 22
(731) Obshchestvo s ogranichennoy
otvetstvennostyu "ZASTROYSCHIK"

ul. B. Cheremushkinskaya, d. 20, korp. 4,
pomeschenie II, komnata 2 RU-117218
Moscow, Russian Federation

(540)



(531) 26.04.01; 26.04.24; 27.05.24

(511)

43 – Services for providing food and drink; providing temporary housing accommodation; accommodation bureau services [hotels, boarding houses]; rental of temporary accommodation; rental of meeting rooms; tourist home services; hotel reservations; boarding house bookings; temporary accommodation reservations; hotel services; retirement home services; snack-bar services; café services; cafeteria services; motel services; boarding house services; boarding for animals; rental of cooking apparatus; rental of chairs, tables, table linen, glassware; rental of lighting apparatus; rental of tents; rental of transportable buildings; rental of drinking water dispensers; restaurant services; self-service restaurant services; reception services for temporary accommodation [management of arrivals and departures]; food sculpting; canteen services; holiday camp services [lodging]; bar services; providing campground facilities; food and drink catering; washoku restaurant services; day-nursery [crèche] services.

(260) AM 2018 93959 A

(800) 1361463

(151) 2017 03 03

(891) 2017 03 03

(731) SRS LIFE SCIENCES PTE. LIMITED
140 Paya Lebar Road, #06-04 AZ @ Paya
Lebar, Singapore 409015, Singapore

(540)



(591) Black, white, green, Brown, Light brown, gray

(531) 26.05.03; 26.05.04; 26.05.18; 26.05.22;
26.05.24; 27.05.23; 27.05.24; 29.01.15

(511)

5 – Pharmaceutical, medicinal, herbal, nutraceutical and food supplement preparations for human and veterinary use.

(260) AM 2018 93961 A

(800) 1361464

(151) 2017 02 21

(891) 2017 02 21

(731) KRKA, tovarna zdravil, d.d., Novo mesto
Šmarješka cesta 6, SI-8000 Novo mesto,
Slovenia

(540)

MAGNESOL

(591) Black, white

(511)

5 – Dietetic substances for medical use; dietary supplements for humans; nutrients for special health purposes, dietetic nutrients for medical purposes; dietetic additives for humans; dietary supplements for medical use, in particular consisting of mineral substances, trace elements and/or vitamins, individually or in any combination; vitamin and/or mineral preparations; dietetic substances as food supplements and dietary supplements, in particular consisting of mineral substances, trace elements and/or vitamins, individually or in any combination; mineral waters for medical purposes.

32 – Mineral water, non-alcoholic beverages, fruit drinks, fruit juices, lemonades, syrups for beverages, preparations for making non-alcoholic beverages; pastilles and tablets for effervescing beverages, powders for effervescing beverages.

(260) AM 2018 93964 A

(800) 1361499

(151) 2017 05 24

(891) 2017 05 24

(731) SHANDONG BUNSE ELEVATOR CO.,
LTD.
West of Lae Avenue, North of the Meeting
River Avenue, Lae Industrial Area, Laiwu
City 271100 Shandong Province, China

(540)

BenSu

(591) Black, white

(531) 27.05.01; 28.03

(511)

7 – Elevators [lifts]; winches; hoists; loading ramps; elevator conveyor belt; elevating apparatus; escalators; moving staircases [escalators]; escalators; conveyors [machines].

(260) AM 2018 93965 A

(800) 1361503

(151) 2017 05 03

(891) 2017 05 03

(731) Obschestvo s ogranichennoy otvetstvennostyu "VZV"

Fryanovskoe shosse, d. 1 b, str. 2, etazh 1, pom. 8, ofis 105, g. Shchelkovo RU-141100 Moskovskaya obl., Russian Federation

(540)



(591) Black, white

(531) 27.05.10; 27.05.11; 27.05.17

(511)

25 – Clothing, footwear.

(260) AM 2018 93967 A

(800) 1361505

(151) 2017 05 30

(891) 2017 05 30

(731) DARKOV IVAN VASYLOVYCH

vul. Horovytsya, bud.8, kv.7 m. Kyiv 03110, Ukraine

(540)

BIRKIN

(591) Black, white

(511)

29 – Ajvar [preserved peppers]; albumen for culinary purposes; albumin milk; alginates for culinary purposes; almond milk; almond milk-based beverages; almond milk for culinary purposes; almonds, ground; aloe vera prepared for human consumption; anchovy, not live; animal marrow for food; apple purée; arrangements of processed fruit; artichokes, preserved; bacon; beans, preserved; berries, preserved; black pudding [blood sausage]; bone oil, edible; bouillon; bouillon concentrates; bulgogi [Korean beef dish]; butter; buttercream; candied nuts; caviar; charcuterie; cheese; clams, not live; cocoa butter for food; coconut butter; coconut, desiccated; coconut fat; coconut milk; coconut milk-based beverages; coconut milk for culinary purposes; coconut oil for food; colza oil for food; compotes; condensed milk; corn dogs; corn oil for food; cranberry sauce [compote]; crayfish, not live; cream [dairy products]; croquettes; crustaceans, not live; crystallized fruits; curd; dates; edible birds' nests; edible fats; edible

insects, not live; eggplant paste; eggs; escamoles [edible ant larvae, prepared]; extra virgin olive oil; falafel; fat-containing mixtures for bread slices; fatty substances for the manufacture of edible fats; fish-based foodstuffs; fish fillets; fish meal for human consumption; fish mousses; fish, not live; fish, preserved; fish roe, prepared; fish, tinned [canned (Am.)]; flavored nuts; freeze-dried meat; freeze-dried vegetables; frozen fruits; fruit-based snack food; fruit chips; fruit jellies; fruit peel; fruit, preserved; fruit preserved in alcohol; fruit pulp; fruit salads; fruit, stewed; fruits, tinned [canned (Am.)]; galbi [grilled meat dish]; game, not live; gelatine; gherkins; ginger jam; guacamole [mashed avocado]; ham; hazelnuts, prepared; herrings, not live; hot dog sausages; hummus [chickpea paste]; isinglass for food; jams; jellies for food; kephir [milk beverage]; kimchi [fermented vegetable dish]; kumys [kumyss] [milk beverage]; lard; lecithin for culinary purposes; lemon juice for culinary purposes; lentils, preserved; linseed oil for culinary purposes; liver; liver pâté; lobsters, not live; low-fat potato chips; margarine; marmalade; meat; meat extracts; meat jellies; meat, preserved; meat, tinned [canned (Am.)]; milk; milk beverages, milk predominating; milk ferments for culinary purposes; milk products; milk shakes; milk substitutes; mushrooms, preserved; mussels, not live; non-alcoholic eggnog; nut-based spreads; nuts, prepared; oat milk; oils for food; olive oil for food; olives, preserved; onion rings; onions, preserved; oysters, not live; palm kernel oil for food; palm oil for food; peanut butter; peanut milk; peanut milk-based beverages; peanut milk for culinary purposes; peanuts, prepared; peas, preserved; pectin for culinary purposes; pickles; pollen prepared as foodstuff; pork; potato-based dumplings; potato chips; potato flakes; potato fritters; poultry, not live; powdered eggs; powdered milk; prawns, not live; preparations for making bouillon; preparations for making soup; preserved garlic; prostokvasha [soured milk]; raisins; rennet; rice milk; rice milk for culinary purposes; ryazhenka [fermented baked milk]; salmon, not live; salted fish; salted meats; sardines, not live; sauerkraut; sausage casings, natural or artificial; sausages; sausages in batter; sea-cucumbers, not live; seaweed extracts for food; seeds, prepared; sesame oil for food; shellfish, not live; shrimps, not live; silkworm chrysalis for human consumption; smetana [sour cream]; snail eggs for consumption; soups; soya bean oil for food; soya beans, preserved, for food; soya milk; spiny lobsters, not live; suet for food; sunflower oil for food; sunflower seeds, prepared; sweet corn, processed; tahini [sesame seed paste]; toasted laver; tofu; tomato juice for cooking; tomato paste; tomato purée; tripe; truffles, preserved; tuna, not live; vegetable-based cream; vegetable juices for cooking; vegetable marrow paste; vegetable mousses; vegetable salads; vegetables, cooked; vegetables, dried; vegetable soup preparations; vege-

tables, preserved; vegetables, tinned [canned (Am.)]; whey; whipped cream; white of eggs; yakitori; yogurt; yolk of eggs; coconut chips.

(260) AM 2018 93971 A

(800) 1361560

(151) 2016 12 26

(891) 2016 12 26

(731) NATIXIS

30 avenue Pierre Mendès-France, F-75013

PARIS, France

(540)

NATIXIS

(591) Black, white

(511)

9 – Apparatus for recording, transmission and reproduction of sound or images; magnetic recording media; calculating machines; equipment for data processing and computers; integrated circuit cards [smart cards]; credit cards; debit cards; magnetic cards; cash withdrawal cards; payment cards; magnetic cards used in particular for paying financial, banking, monetary and stock exchange transactions; magnetic identity cards; magnetically encoded cards for storing or collecting data; magnetic cards for physical access control, control of access to computer systems; encoded loyalty cards, magnetic cards for collecting points, magnetic subscription cards; Magnetic, optical, electronic memory or microprocessor, chip, disposable or rechargeable cards, cards for prepaid or postpaid use, contact or contactless cards, cards able to contain one or more electronic cash wallets to purchase products or pay for services; software; downloadable software in the financial, banking, monetary, real estate, stock exchange, saving and insurance field; downloadable software for managing shares, securities and other financial instruments; electronic publications [downloadable]; downloadable computer software applications; application software for mobile telephones; computer applications for computers, mobile telephones, tablet computers, personal digital assistants; downloadable software in the form of applications for computers, mobile telephones, tablet computers, personal digital assistants; interactive computer devices; virtual reality helmets and visors; virtual reality software for monitoring movement, location, position and orientation detection; software for the development and interfacing of virtual reality software; software, namely for mobile applications for installation, configuration, display and operation of virtual reality software; software tools for editing prepaid vouchers for printing (digit codes, barcodes, 2D codes or other graphic signatures that can be optically scanned), the aforesaid products for use on hand-held and mobile digital electronic devices and other consumer electronic devices; downloadable electronic publications in the financial, banking, monetary, real estate, stock

exchange, saving and insurance fields; electronic wallets; mechanisms for coin-operated apparatus; automatic ticket dispensers; counterfeit [false] coin detectors; readers for memory or chip cards, magnetic cards, payment cards, credit cards, debit cards, loyalty cards, discount cards.

16 – Printing products (printed matter); instructional or teaching material (except apparatus); printed matter, newspapers and periodicals, checkbooks, printed forms for use by banks; albums, brochures, notebooks, calendars, information bulletins, publications, magazines, prospectuses, books, manuals, directories; checks, service vouchers and special payment vouchers.

35 – Advertising; online advertising on a computer communication network; commercial business management; commercial administration; business consultancy; business inquiries or information; commercial advertising, commercial canvassing for the dissemination of securities; business account management services for clients; accounting services; invoicing services; administration, billing and reconciliation of accounts on behalf of others; computer file management; data search in computer files; commercial and industrial company operational assistance; market study and research; compilation of information; services provided by consultants relating to company acquisitions and mergers; drawing up of bank statements, preparation of business statistics, auditing of accounts; economic forecasting; consultancy relating to tax declaration preparation; tax preparation; administrative management of financial, banking, monetary, real estate and stock exchange transactions; administrative management of shares, securities and other financial assets; administrative management of investment funds [for others]; arranging subscriptions to telematic services; subscription to a provider center for access to a computer network for telecommunications or data transmission, subscription to electronic newspapers, subscription to a telecommunications service; services to bring together for others of products (excluding the transport thereof) and services, namely financial, banking, monetary, real estate, stock exchange, savings and insurance services to enable customers to view and/or purchase the said products and services; presentation of financial, banking, monetary, real estate, stock exchange, saving and insurance products on any communication medium for the retail sale of such products; promotional and advertising operations with a view to developing customer and staff loyalty; research and prospecting of financial markets.

36 – Banking; financial affairs; monetary affairs; real estate affairs; stock exchange affairs; actuarial services, factoring, credit agencies; debt collection agencies; financial analysis; insurance services; insurance consultancy; insurance in connection with

financial and stock exchange transactions; provident funds; credit card services; debit card services; surety services; raising capital; banking and financial consultancy; real estate appraisal; real estate brokerage, real estate management; wealth management, stock exchange quotations; brokerage; stock exchange brokerage; insurance brokerage; credit; lease-purchase financing; deposits of valuables; management of securities; issuing of bank checks, of travelers' checks; issuing of bank cards, issuing of loyalty cards (financial service); savings bank services; financial evaluation (insurance, banking, real estate); financing services; fiscal assessments, fiduciary services, raising funds; financial information; insurance information; home banking; capital investment; exchange operations; installment loans; payment services and transfer of electronic funds; loans [financing]; collateral loans; financial transactions; electronic funds transfer; electronic transfer of shares, securities and other financial goods and services; check verification; financial and banking management; management of securities; financial sponsorship; banking, financial and monetary operations on-line via telecommunication networks and computer communication networks; quotation services of investment funds, shares, securities and financial goods and services; management of listed securities; registration and admission of stocks, securities and financial goods and services on a stock exchange; services for trading shares, securities and financial instruments; intermediary services relating to shares, securities and financial goods and services; issuing tickets and payment vouchers, pre-paid cards and any other means of payment for purchasing products or paying for services; cloud issuing of payment vouchers; issuing of magnetic, optical, electronic memory or microprocessor, chip, disposable or rechargeable cards, cards for prepaid or postpaid use, contact or contactless cards, cards able to contain one or more electronic cash wallets to purchase products or pay for services; issuing of payment cards, debit and credit cards, loyalty cards, magnetic subscription cards; financing services for the acquisition of goods or services by means of electronic documents, coupons, vouchers or control tickets; consultancy in optimization of company remuneration schemes and employee benefit schemes.

38 – Telecommunications; telecommunication services regarding finance, banking, money, real estate, stock exchange, savings and insurance; electronic bulletin board services [telecommunications services]; communications by computer terminals; computer-aided transmission of messages and images; transmission of computer-aided messages and images relating to finances, banking, monetary services, real estate, stock market, savings and insurance; electronic messaging; communicating information and handling inquiries concerning financial, banking, monetary, real estate, stock exchange, savings and

insurance fields on any means of telecommunication, including by means of computer, and computer or electronic networks; transmission of data by any means of telecommunication, including transmission of financial, banking, monetary, real estate, stock exchange, saving and insurance data; rental of access time to a database server center; communication of information and advertising and commercial information in the financial, banking, monetary, real estate, stock exchange, saving and insurance fields by any means of telecommunication, including by means of computer, tablet, mobile phones, connected virtual reality devices or computer or electronic networks; provision of access to hosted applications to acquire information, to compare and subscribe to offers in the financial, banking, monetary, real estate, stock exchange, saving and insurance fields.

41 – Education; training; arranging and conducting training workshops, colloquiums, conferences, congresses, seminars and/or symposiums in the financial, banking, monetary, real estate, stock exchange, saving and insurance fields; practical training [demonstration] in the financial, banking, monetary, real estate, stock exchange, saving and insurance fields; provision of on-line electronic publications [non-downloadable]; electronic publication of books and journals online; publication of books, booklets and brochures; publication of texts [other than advertising texts]; publication of banking, financial, real estate or stock exchange fields, as well as statistics, business information, studies and market analysis; organization of competitions, games (entertainment), information campaigns and professional and other events in the cultural, sports, research, environmental solidarity and humanitarian fields, and for cultural or educational purposes; production of films and television series, information shows, cinematographic and television entertainment, audiovisual and multimedia programs (computer editing of texts and/or of still or animated images, and/or of musical or non-musical sounds) for interactive or non-interactive use.

42 – Development [design], installation, updating, maintenance and rental of software; creation [design], installation, updating, maintenance and rental of software in the finance, banking, monetary, real estate, stock exchange, saving and insurance fields; providing temporary use of on-line, non-downloadable software for processing electronic payments; providing temporary use of on-line, non-downloadable authentication software to control access and communication with computers and computer networks.

45 – Legal services; all kinds of legal or judicial research; legal analyses; legal assistance services; legal advice and consultancy; litigation services; computer software licensing [legal services].

(260) AM 2018 93972 A

(800) 1361690

(151) 2017 04 21

(891) 2017 04 21

(731) Obschestvo s ogranichennoy

otvetstvennostyu "EVRA"

Solnechnogorskaya ul., 4, str. 6, RU-125413

Moscow, Russian Federation

(540)

Мега Секрет

Mega Secret

(591) Black and white

(531) 27.05.17; 28.05

(511)

28 – Games; toys; gymnastic and sporting articles; decorations for Christmas trees; toy figures; novelties for parties, dances [party favors, favours]; scratch cards for playing lottery games; spinning tops [toys]; jigsaw puzzles; flying discs [toys]; dolls' houses; dominoes; chessboards; checkerboards; darts; Christmas trees of synthetic material; stuffed toys; plush toys; mobiles [toys]; practical jokes [novelties]; parlor games; board games; ring games; building games; kaleidoscopes; bingo cards; playing cards; skittles [games]; bells for Christmas trees; dolls' rooms; confetti; explosive bonbons [Christmas crackers]; dice; dolls' beds; building blocks [toys]; dolls; bows for archery; marionettes; carnival masks; masks [playthings]; theatrical masks; matryoshka dolls [wooden nested Russian dolls]; teddy bears; targets; toy models; scale model kits [toys]; scale model vehicles; balls for games; dolls' clothes; gloves for games; pinatas; toy pistols; air pistols [toys]; percussion caps [toys]; caps for pistols [toys]; rattles [playthings]; candle holders for Christmas trees; portable games with liquid crystal displays; soap bubbles [toys]; rackets; sling shots [sports articles]; scooters [toys]; sleds [sports articles]; butterfly nets; slides [playthings]; radio-controlled toy vehicles; decorations for Christmas trees, except illumination articles and confectionery; conjuring apparatus; apparatus for games; counters [discs] for games; marbles for games; playing balls; play balloons; chess games; checkers [games]; paper party hats.

30 – Coffee, tea, cocoa; artificial coffee, including vegetal preparations for use as coffee substitutes, chicory [coffee substitute]; unroasted coffee; rice; tapioca and sago; flour, including bean meal, tapioca flour, potato flour, corn flour, nut flours, wheat flour, soya flour, barley meal; cereal preparations; pastries; confectionery; chocolate, including chocolate in the form of eggs; ice cream; sugar; honey; treacle; yeast, baking powder; salt; mustard; vinegar, including beer vinegar; condiments; spices; edible ices; aromatic preparations for food, including coffee fla-

vorings [flavourings]; food flavourings, other than essential oils, including for confectionery and for beverages; star aniseed; cereal bars, including high-protein cereal bars; sponge cakes; pancakes; noodle-based prepared meals; buns; bread rolls; vanillin [vanilla substitute]; vanilla [flavoring]; vareniki [stuffed dumplings]; waffles; vermicelli [noodles], spaghetti, macaroni and noodles; natural sweeteners; sausage binding materials, binding agents for ice cream [edible ices]; sea water for cooking; seaweed [condiment]; malt biscuits; cloves [spice]; cake frosting [icing]; glucose for culinary purposes; gluten additives for culinary purposes; thickening agents for cooking foodstuffs; leaven; rice-based snack food, cereal-based snack food; dressings for salad; fruit jellies [confectionery]; pasta; candy decorations for cakes; confectionery for decorating Christmas trees; cakes; pastries; peanut confectionery, almond confectionery; ginger [spice]; frozen yogurt [confectionery ices]; capers; caramels [candy]; curry [spice]; gruel, with a milk base, for food; ketchup [sauce]; quiches; gluten prepared as foodstuff; cinnamon [spice]; sweetmeats [candy], including chocolate candies, liquorice [confectionery], peppermint sweets; starch for food; crackers; custard; groats for human food, including semolina, oatmeal, crushed barley, hominy grits; corn, milled; corn, roasted; meat pies; turmeric for food; couscous [semolina]; farinaceous foods; candy; rice cakes; mayonnaise; maltose; hominy; marinades; marzipan; royal jelly; dessert mousses [confectionery]; chocolate mousses; muesli; mint for confectionery; coffee-based beverages, cocoa beverages with milk, coffee beverages with milk, tea-based beverages, chocolate-based beverages, chocolate beverages with milk, cocoa-based beverages; infusions, not medicinal; nutmegs; chocolate-coated nuts; crushed oats; husked oats; stick liquorice [confectionery]; soya bean paste [condiment]; molasses for food; pepper; pastilles [confectionery]; pesto [sauce]; biscuits, including petit-beurre biscuits, macarons [pastry]; pâtés en croûte; pelmeni [dumplings stuffed with meat]; pies; pizzas; meat gravies; baking powder and powders for ice cream; mustard meal; fondants [confectionery]; popcorn; gingerbread; pralines; meat tenderizers, for household purposes; oat-based food; propolis; petits fours [cakes]; puddings; cake powder; fruit coulis [sauces]; ravioli; chewing gum; relish [condiment]; wheat germ for human consumption; spring rolls; aniseed; linseed for culinary purposes [seasoning]; golden syrup; baking soda [bicarbonate of soda for cooking purposes]; malt for human consumption; salt for preserving foodstuffs; cooking salt, celery salt; sorbets [ices]; ham glaze; sauces [condiments], including soya sauce, tomato sauce; seasonings; preparations for stiffening whipped cream; rusks, including breadcrumbs; sushi; sandwiches; tabbouleh; tacos; cream of tartar for culinary purposes; tarts; dough; pastry dough, including cake dough; almond

paste; tortillas; garden herbs, preserved [seasonings]; ferments for pastes; halvah; bread; chips [cereal products], including corn flakes, oat flakes; chutneys [condiments]; cheeseburgers [sandwiches]; chow-chow [condiment]; saffron [seasoning]; malt extract for food; essences for foodstuffs, except etheric essences and essential oils; husked barley; chocolate decorations for cakes; flowers or leaves for use as tea substitutes; minced garlic [condiment].

(260) AM 2018 93973 A

(800) 1361717

(151) 2017 05 17

(891) 2017 05 17

(731) JSP Limited

Worsham Mill, Minster Lovell Oxford,
Oxfordshire OX29 0TA, United Kingdom

(540)

PRESSCHECK

(591) Black and white

(531) 27.03.15; 27.05.22

(511)

9 – Protective eyewear, protective goggles, protective spectacles, protective faceshields, protective masks; anti-glare and anti-dazzle eyewear; safety helmets; respirators and breathing apparatus and filters therefor, protective powered respirators, other than for artificial respiration; and parts and fittings of all the aforesaid goods.

10 – Hearing protectors; ear defenders, ear plugs; and parts and fittings of all the aforesaid goods.

(260) AM 2018 93974 A

(800) 1361574

(151) 2017 03 07

(891) 2017 03 07

(731) QUIPMENT, Société par actions simplifiée

132 Rue André Bisiaux, F-54320
MAXEVILLE, France

(540)

QuiPMENT

(591) Black, white

(531) 27.05.05

(511)

10 – Surgical, medical, dental and veterinary apparatus and instruments.

35 – Inventory management services; retail and wholesale services in relation to medical and laboratory apparatus and instruments; retail and wholesale services in relation to medical and laboratory accessories and equipment; compilation and systemization of data into computer databases for ot-

hers; processing administrative data on behalf of others.

39 – Transportation and storage of laboratory and medical apparatus, instruments and equipment; logistics services relating to the transportation of medical and laboratory apparatus, instruments, and equipment; information relating to storage of laboratory and medical apparatus, instruments and equipment; location and tracing by means of the electronic tracking of laboratory and medical apparatus, instruments and equipment during the transportation or storage thereof; shipping services [transportation of goods] of laboratory and medical apparatus, instruments and equipment.

41 – Training in the use of medical equipment; training in computer and Internet tools for the management and operation of medical equipment.

44 – Rental of medical machines, apparatus and instruments; provision of information relating to the rental of medical apparatus; rental of medical equipment for clinical trials; remote medical assistance; rental of centrifuges for medical purposes, apparatus for ECG monitoring, infusion apparatus, microscopes, diagnostic ultrasound systems, oximeters, multi-parameter monitors in the field of health, defibrillators, freezers for medical purposes; rental of laboratory equipment for medical use; providing information relating to the rental of equipment for medical laboratory use.

(260) AM 2018 93975 A

(800) 1361752

(151) 2017 06 20

(891) 2017 06 20

(731) APPLE INC.

1 Infinite Loop Cupertino CA 95014, USA

(540)

HOMEPOD

(591) Black and white

(511)

9 – Audio speakers, amplifiers and receivers; digital audio players; sound reproducing apparatus; voice recording and recognition apparatus; microphones; radios, radio transmitters, and radio receivers; wireless communication devices for voice or data transmission; computer hardware for playing, organizing, downloading, transmitting, manipulating and reviewing audio files and media files; electronic devices capable of providing access to the Internet and for the sending, receiving, and storing of digital data; voice-controlled smart audio speakers with virtual personal assistant capabilities; personal digital assistant; electronic voice command and recognition and remote control apparatus and devices for controlling and monitoring consumer electronics devices, lighting, appliances, thermostats, heating and air condi-

tioning systems, alarm and home security and surveillance systems, smoke and carbon monoxide detectors, door and window locks and latches, and home automation systems; remote controls; accessories for smart audio speakers.

(260) AM 2018 93976 A

(800) 1361591

(151) 2017 06 15

(891) 2017 06 15

(731) TISSOT SA

Chemin des Tourelles 17, CH-2400 Le Locle,
Switzerland

(540)



(591) Black, white

(531) 26.04.01; 26.04.18; 26.04.24; 27.05.21;
27.05.24

(511)

14 – Wristwatches.

(260) AM 2018 93977 A

(800) 1361800

(151) 2017 03 07

(891) 2017 03 07

(731) TRADE CORPORATION

INTERNATIONAL, S.A. UNIPERSONAL
Alcalá, 498, planta 2 E-28027 MADRID,
Spain

(540)

tradefos 

(591) Dark green, black, yellow and white

(531) 01.15.15; 05.03.14; 27.05.08; 29.01.13

(511)

1 – Fertilizers; soil fertilizers.

(260) AM 2018 93989 A

(800) 1361953

(151) 2017 03 16

(891) 2017 03 16

(731) HEILAN HOME CLOTHING CO., LTD.

(NO. 8, HUAXIN ROAD), HUASHI TOWN
INDUSTRIAL ZONE, JIANGYIN CITY
JIANGSU PROVINCE, China

(540)

HLA
海澜之家

(591) Black and white

(531) 27.05.17; 27.05.23; 28.03

(511)

24 – Textile material; non-woven textile fabrics; wall hangings of textile; tapestry [wall hangings], of textile; printers' blankets of textile; towels of textile; bed covers; diaper changing cloths for babies; sheets [textile]; table linen, not of paper; door curtains; fitted toilet lid covers of fabric; marabouts [cloth]; silk fabrics, namely, hada (greeting fabric); banners; shrouds.

35 – Advertising; publicity; presentation of goods on communication media, for retail purposes; business management of hotels; commercial administration of the licensing of the goods and services of others; organization of exhibitions for commercial or advertising purposes; providing business information via a web site; business management assistance; commercial information agencies; marketing; sales promotion for others; employment agencies; relocation services for businesses; photocopying services; business auditing; rental of vending machines; sponsorship search; rental of sales stands; retail or wholesale services for pharmaceutical, veterinary and sanitary preparations and medical supplies.

37 – Building construction supervision; construction; residential and commercial building construction; mining extraction; upholstery; burner maintenance and repair; kitchen equipment installation; repair of sanitary installations; vehicle service stations [refuelling and maintenance]; shipbuilding; photographic apparatus repair; clock and watch repair; safe maintenance and repair; painting services; retreading of tires; dry cleaning; disinfecting; lift installation and repair; repair of sports equipment; restoration of works of art; jewelry repair; shoe repair; furniture restoration; housework services.

45 – Security consultancy; clothing rental; embalming services; dating services; rental of fire extinguishers; adoption agency services; opening of security locks; lost property return; planning and arranging of wedding ceremonies; rental of safes; releasing doves for special occasions; intellectual property consultancy.

(260) AM 2018 93990 A

(800) 1361954

(151) 2017 05 22

(891) 2017 05 22
(731) KERTEN UNLIMITED COMPANY
221-223 Lower Rathmines Road Dublin 6,
D06A582, Ireland

(540)

THEHOUSE|RESIDENCE

(591) Black and red
(531) 26.11.07; 27.05.10; 29.01.12
(511)
43 – Providing of food and drink; temporary accommodation.

(260) AM 2018 93991 A
(800) 1362045
(151) 2016 12 28
(891) 2016 12 28
(731) INTERTEK GROUP PLC
33 Cavendish Square LONDON W1G 0PS,
United Kingdom

(540)



(591) Black and white
(531) 26.01.18; 27.05.19
(511)
35 – Business services; commercial management services; business administration; commercial administration; business inquiries; commercial inquiries; business investigations, commercial investigations; business research; commercial research; business information analysis; commercial information analysis; compilation of business information and/or data; compilation of commercial information and/or data; business risk management services; supply chain management services; compilation of information onto computer databases including information relating to product characteristics, safety statistics, injuries, environmental, metocean, geophysical, geotechnical and geohazard data and information; provision of business information, commercial information, advice and/or statistics; compilation and/or analysis of business statistics; compilation and/or analysis of commercial statistics; compilation and/or analysis of product safety statistics; business data analysis services provided by compilation and/or use of statistical models for analyzing business information, commercial information and/or safety information; business data analysis services provided by compilation and/or use of algorithms for analysing business information, commercial information

and/or safety information; compilation of import and/or export shipment information; analysis of import and/or export shipment information; provision of business and/or commercial reports; provision of financial and/or insurance statistics; computerized data verification services; benchmarking services for business management purposes; benchmarking of business practices; evaluation of business organization practices in the nature of provision of benchmarking and reference information relating to performance, environmental, social welfare, ethical or safety standards for business purposes; management of product recalls; business project management services; provision of subscription services to computer servers, databases, websites and software resources; any of the aforesaid services provided online from a computer database, information network and/or the Internet; compilation of financial information; compilation of insurance information; advisory and/or consultancy services relating to the aforesaid services.

36 – Financial services; financial inquiries, financial investigations; insurance services; maritime insurance services in the nature of marine and cargo risk and liability services; insurance inquiries, insurance investigations; analysis of financial information; analysis of insurance information; financial risk management advisory and consultancy services; financial analysis of taxation information; advisory services relating to declaration, calculation and/or collection of revenue; advisory services relating to declaration, calculation and/or collection or import duty and/or customs revenue; analysis of financial and/or insurance information relating to shipment of goods; provision of financial and/or insurance reports; financial analysis services related to analysing financial information and/or insurance information by compilation and/or use of statistical models; financial analysis services related to analysing financial information and/or insurance information by compilation and/or use of algorithms; any of the aforesaid services provided online from a computer database, information network and/or the Internet; advisory and/or consultancy services relating to the aforesaid services.

37 – Maintenance and repair services in respect of oil and gas structures, marine structures, civil structures and buildings; maintenance and repair services in respect of oil and gas structures, marine structures, civil structures and buildings provided via rope access for working at high elevation; cleaning and painting services; advisory and/or consulting services relating to the aforesaid services.

38 – Providing access to computer servers, databases, websites, content, software resources and portals; leasing or renting or providing subscription-based access to content, and portals; advisory and/or consulting services relating to the aforesaid services.

41 – Training services; training advisory and consultancy services relating to obtaining regulatory or governmental qualifications; any of the aforesaid services provided online from a computer database, information network and/or the Internet; advisory and/or consulting services relating to the aforesaid services.

42 – Technical testing services; quality testing services; scientific testing services; environmental testing services; technical inspection services; quality inspection services; environmental inspection services; certification services, namely the testing, analysis and evaluation of goods and services of others for the purposes of certification; technical evaluation services; quality evaluation services; scientific evaluation services; evaluation of product design or development; evaluation services related to application of industrial standards; quantity and quality verification services; verification of technical data; industrial analysis services; technical analysis services; scientific analysis services; engineering analysis services; technical validation services for product development purposes; validation services, namely reviewing and verifying third party quality assertions; non-destructive testing services; technical or scientific testing, inspection, certification, evaluation, verification or analysis of goods including materials, consumer products, building products, building materials, reinforced concrete structures, engineering components, marine structures, marine components, piping, plumbing products, plumbing materials, vehicles, engines, vehicle components, livestock, poultry, foods, beverages, medical equipment, medical products, pharmaceuticals; technological, scientific and industrial analysis and research services, namely testing, inspection, certification, evaluation, verification or analysis services for commodities including natural resources, agricultural products and energy commodities; environmental testing, inspection, certification, evaluation, verification and analysis; electronic, electrical, physical, chemical, metallurgical, mechanical, ultrasonic, radiographic and optical testing, inspection, certification, verification, evaluation and analysis services relating to the application of industrial or commercial standards; testing, inspection, certification, verification, evaluation and analysis services all for compliance with regulatory, quality, quantity, consistency, performance, ethical or safety standards; laser scanning services for mapping and surveying purposes; laser scanning services for the production of 3D models of buildings, facilities, industrial plant and ships; quality and safety control testing and assessment services; auditing of quality control capability; calibration services; scientific and technological services; scientific laboratory services; medical research laboratory services; blood testing services for scientific or industrial research purposes; body fluid testing servi-

ces for scientific or industrial research purposes; forensic science services for investigation purposes; industrial analysis services; industrial and scientific research services; medical and pharmacological research services; corrosion testing services; technical services for corrosion modelling and monitoring; mechanical integrity services; pipeline integrity services; integrity monitoring services; stress testing of materials and products; conducting clinical trials and field trials; development of medical products; process and formulation development of pharmaceutical, microbiological, medical and veterinary preparations; design and development of medical devices; research relating to plant breeding; scientific study protocol development; technological or engineering project management services; environmental monitoring and hazard assessments; design services; safety design services; premises layout design services; surveying services; engineering services; preparing engineering analyses and reports; geological and geotechnical services; testing, inspection, evaluation, verification and analysis of business systems, management systems, quality management systems, environmental management systems, manufacturing systems, methods and processes, including supply chain management all for compliance with regulatory, quality, quantity, consistency, performance, ethical or safety standards; provision of benchmarking and reference information relating to performance, environmental, engineering, social welfare or ethical safety or quality standards; provision of benchmarking and technical reference information relating to metocean, geophysical, geotechnical or geohazard data and information; any of the aforesaid services provided online from a computer database, information network and/or the Internet; computer services in the nature of Software as a Service (SaaS), namely hosting computer software and software-utilising services for access by, or use by, others; computer services in the nature of Software as a Service (SaaS), namely the online (from websites or via the Internet) provision of software resources for use by others; leasing of computer software; computer software consultancy, research, advisory, planning and information services; computer software design, writing, development, customization, installation, testing, updating, repair and maintenance services; information and advisory services relating to computer software and the use and application thereof; product benchmarking; advisory and consultancy services relating to all the aforesaid services.

45 – Litigation support services; expert witness services; document verification services being verification of identification labelling and certificates required for trade; security and safety risk assessment services; process safety and process hazards analysis related to workplace safety or product design and development; provision of safety information and advice; provision of security information and advice;

provision of legal information and legal advice relating to laws and regulations in the field of quality, safety and performance; legal advice and consultancy relating to obtaining regulatory or governmental approvals; auditing of supply chain security practices; inspection of workplaces for occupational health and safety purposes; project management services, namely, consultancy services relating to health and safety; provision of benchmarking and reference information relating to workplace safety standards or supply chain safety standards; container scanning for security purposes; cargo scanning services for security purposes; any of the aforesaid services provided online from a computer database, information network and/or the Internet; advisory and consultancy services relating to all the aforesaid services.

(260) AM 2018 93992 A

(800) 1362040

(151) 2016 10 24

(891) 2016 10 24

(731) STILL ARSER İŞ MAKİNALARI SERVİS
VE TİCARET ANONİM ŞİRKETİ
Osmangazi Mahallesi, Yıldızhan Caddesi,
No:5 Sancaktepe İstanbul, Turkey

(540)



(591) Orange, black and white

(531) 26.04.05; 27.05.01; 27.05.17; 29.01.12

(511)

35 – Advertising, marketing and public relations; organization of exhibitions and trade fairs for commercial or advertising purposes; office functions; secretarial services; arranging newspaper subscriptions for others; compilation of statistics; rental of office machines; systemization of information into computer databases; telephone answering for unavailable subscribers; business management, business administration and business consultancy; accounting; commercial consultancy services; personnel recruitment, personnel placement, employment agencies, import-export agencies; temporary personnel placement services; auctioneering; the bringing together, for the benefit of others, of a variety of goods, namely, machines and machine tools, motors and engines (except for land vehicles), machine coupling and transmission components (except for land vehicles), agricultural implements other than hand-operated, incubators for eggs, automatic vending machines, scientific, nautical, surveying, photographic, cinematographic, optical, weighing, measuring, signalling, checking (supervision), life-sa-

ving and teaching apparatus and instruments, apparatus and instruments for conducting, switching, transforming, accumulating, regulating or controlling electricity, apparatus for recording, transmission or reproduction of sound or images, magnetic data carriers, recording discs, compact discs, DVDs and other digital recording media, mechanisms for coin-operated apparatus, cash registers, calculating machines, data processing equipment, computers, computer software, fire-extinguishing apparatus, batteries, electric accumulators, battery charging devices for motor vehicles, vehicles, apparatus for locomotion by land, air or water, fork lift trucks enabling customers to conveniently view and purchase those goods, such services may be provided by retail stores, wholesale outlets, by means of electronic media or through mail order catalogues.

37 – Construction services, rental of construction machines and equipment; cleaning services for buildings (interior and exterior), public areas, industrial premises; disinfecting, vermin exterminating services, other than for agriculture, rental of cleaning machines and equipment; vehicle service stations for land vehicles, maintenance, repair and refueling of land vehicles; vehicle service stations for marine vehicles, maintenance, repair and refueling of marine vehicles; repair and maintenance of air vehicles; upholstery, repair and restoration of furniture; installation, maintenance and repair of heating, cooling and sanitary installations; cleaning, care and repair of clothing; installation, maintenance and repair of industrial machines and equipment, office machines and equipment, communication apparatus, electric and electronic appliances; repair and maintenance of lifts; clock and watch repair; mining services and mining extraction; repair of shoes, bags and belts.

(260) AM 2018 93993 A

(800) 1362074

(151) 2017 03 23

(891) 2017 03 23

(731) LENZING AKTIENGESELLSCHAFT
Werkstr. 2 A-4860 Lenzing, Austria

(540)

LENZING

(591) Black and white

(511)

1 – Filtering media of chemical and non-chemical substances included in the class; filtering preparations for the beverages industry; chemical preparations and materials for film, photography and printing; security papers [sensitized]; fertilisers, and chemicals for use in agriculture, horticulture and forestry; pyroligneous acid; furfural; sodium sulphate; chemicals used in science; chemical intensifiers for paper; chemical substances, chemical materials and chemical preparations.

3 – Facial washes [cosmetic]; hand masks for skin care; skin conditioners; skin masks [cosmetics]; skin conditioning creams for cosmetic purposes; skin care creams, other than for medical use; wrinkle removing skin care preparations; skin cleansing cream; skin cleansing lotion; skin cleansers [non-medicated]; body masks; facial care preparations; skin cleansers [cosmetic]; wrinkle-minimizing cosmetic preparations for topical facial use; patches containing sun screen and sun block for use on the skin; wipes impregnated with a skin cleanser; exfoliating scrubs for the face; exfoliants for the cleansing of the skin; exfoliating scrubs for cosmetic purposes; pores tightening mask packs used as cosmetics; cleansing masks; cosmetic masks; face packs; shampoo; cleaning and fragrancing preparations; polish for furniture and flooring; grease-removing preparations; wiping cloth impregnated with a cleaning preparation for cleaning eye glasses; cloths impregnated with a detergent for cleaning; cloths impregnated with polishing preparations for cleaning; pre-moistened towelettes impregnated with a detergent for cleaning; cloths impregnated with a detergent for cleaning; wipes incorporating cleaning preparations; polishing preparations; refurbishing preparations; refurbishing preparations; scented sachets; fabric conditioning preparations; fabric softener for laundry; grinding preparations; exfoliants for the care of the skin; toiletries; cotton sticks for cosmetic purposes; cologne impregnated disposable wipes; perfumed tissues; disposable wipes impregnated with cleansing compounds for use on the face; pre-moistened cosmetic wipes; moist wipes for sanitary and cosmetic purposes; cleaning masks for the face; skin care preparations; impregnated tissues for cleaning [non-medicated, for use on the person]; non-medicated body care preparations; beauty care cosmetics; tissues impregnated with essential oils, for cosmetic use; tissues impregnated with make-up removing preparations; tissues impregnated with make-up removing preparations; make-up removing preparations; facial wipes impregnated with cosmetics; nail varnish remover [cosmetics]; nail polish remover; self-tanning preparations [cosmetics]; personal deodorants; baby wipes; skin cleansing cream [non-medicated]; anti-wrinkle cream; non-medicated moisturisers; foot masks for skin care; facial masks; face scrubs (non-medicated -); facial cleansers [cosmetic]; cotton wool for cosmetic purposes; feminine hygiene cleansing towelettes.

5 – Fibre (dietary -); nutritional supplements; dental preparations and articles; dental impression materials; dental materials for stopping the teeth; dental materials for making models of teeth; dental materials for duplicating models of teeth; embedding material for dental use; lining materials for dental purposes; dental resin for temporary bridges, crowns and veneers; material for repairing teeth; material for dental prostheses; materials for artificial teeth; ma-

terial for dental bridges; material for dental crowns; pharmaceutical preparations for dental use; synthetic materials for dental use for fillings; dental composite materials; teeth filling material; dental mastics; absorbent articles for personal hygiene, namely odour-absorbing materials, feminine hygiene articles, disposable incontinence pads, sanitary clothing (sanitary wear), incontinence pads, absorbent hygiene articles, breast-nursing pads, bandages for health purposes, napkins for incontinents, sanitary towels, belts for sanitary napkins (towels), menstruation tampons, sanitary pads, sanitary knickers, panty liners, panty liners (sanitary), sanitary tampons, babies' napkin-pants (diaper-pants), babies' napkins (diapers), babies' napkins (diapers) of cellulose, paper or cellulose, disposable babies' napkins (diapers) of paper and cellulose, triangular babies' napkins (diapers) of paper, napkin pads of paper for incontinents, napkin pads of cellulose for incontinents, disposable pads of cellulose for napkins, disposable napkin pads for incontinents, disposable pants of paper for holding babies' napkins in place, disposable pants of cellulose for holding babies' napkins in place, disposable napkins of paper for incontinents, disposable swimming napkins for babies, disposable swimming napkins for children and small children, disposable training pants (napkins), disposable napkins for incontinents, shaped babies' napkins (diapers) of paper, shaped babies' napkins (diapers) of cellulose, clothing for incontinents, disposable napkins of cellulose for incontinents, absorbent pants for incontinents, napkin-pants for incontinents, napkin pads of paper, napkins of paper, swimming napkins (diapers) for babies, bandages for health purposes, panty liners for incontinents, disposable babies' napkins (diapers) of paper, disposable training napkins of paper or cellulose, disposable training napkins for small children, disposable incontinence napkins for adults, disposable babies' napkin-pants (diaper-pants) of paper, disposable babies' napkin-pants (diaper-pants) of cellulose, disposable napkins, disposable babies' napkin-pants (diaper-pants), napkins of paper for incontinents, adult napkins, napkins for incontinents, napkins of cellulose, babies' napkins (diapers) of cellulose, wadding for medical purposes, absorbent wadding for medical purposes; sanitary preparations for medical purposes, namely scrubs (preparations) for medical purposes, medicinal creams for the protection of the skin, skin care creams for medical use, skin care preparations for medical use, tisanes [medicated beverages], face scrubs (medicated -), skin care lotions [medicated], pharmaceutical preparations for skin care, cotton wool for pharmaceutical purposes, cotton wool in the form of sticks for medical use; hygienic preparations for veterinary use; diapers for pets, namely absorbent diapers of cellulose for pets, absorbent nappies of paper for pets; alcohol swabs for medical purposes, namely disinfectant swabs, medi-

cal swabs; sanitizers for household use; disinfectants for hygiene purposes; disinfectants for medical apparatus and instruments; disinfectants for medical instruments; disinfectants for medical use; disinfectants for dental apparatus and instruments; sanitizing wipes; impregnated medicated wipes, namely wipes with insect repellents; impregnated antiseptic wipes; medicated handwash; wipes for medical purposes, namely wet wipes, impregnated with a pharmaceutical lotion, pads impregnated with medications, wipes, impregnated with pharmaceutical lotions, wet wipes for medical purposes, pads impregnated with medicines, moistened towels of paper impregnated with a pharmaceutical lotion, wipes for medical use, wipes for medical purposes; tissues impregnated with antibacterial preparations; disinfectants impregnated into tissues; deodorants for clothing and textiles, namely odour-neutralising preparations for clothing and textiles; shoe deodorizers; antiseptic preparations for wound care, namely materials for dressings, covering materials and applicators (for medical purposes), first aid kits for domestic use, haemostatic pencils, materials for surgical casts, medical adhesives for binding internal tissue, medical adhesives for binding wounds, oiled paper for medical purposes, first-aid boxes, filled, gels for dermatological use, haemostatics for medical purposes, paper for mustard poultices, pharmaceutical preparations for wounds, antiseptic liquid bandages, dissolvable strips to stop bleeding from minor cuts and grazes, eyepatches for medical purposes, eye pads for medical use, eye bandages for medical use, bandages for use as dressings, cotton for medical use, bandages for making casts, surgical bandages, surgical plasters, medical and surgical dressings, elastic bandages [dressings], first aid dressings, gauze, tissues for surgical use, adhesive bandages, adhesive plasters, adhesive bands for medical purposes, corn rings for the feet, tapes for strapping [medical], adhesive bands for medical purposes, tapes for varicose veins, adhesive dressings, compresses, materials for dressings, materials for dressing wounds, medicated plasters, gauze compresses, ear bandages, plasters, materials for dressings, bunion pads, plasters incorporating a magnet, sponge material for healing wounds, mustard poultices, sterilized dressing, synthetic material for use in setting bones, synthetic material for use in producing casts, tampons for medical purposes, swabs for medical use, bandages for skin wounds, bandages for the prevention of blisters, gauze for dressings, dressings, medical, dressing retention materials, surgical dressings, absorbent cotton, cotton wool for surgical use, vulnerary sponges, wound dressings; cleaning cloths impregnated with disinfectants for hygiene purposes, namely mothproofing paper.

9 – Cases adapted for mobile phones; cases for telephones; cases for PDAs; cases for pocket calculators; cases adapted for CD players; cases adapted

for DVD players; cases for digital media players; lens cases; advertising display signs [mechanical or luminous]; cases adapted for photographic equipment; camcorder cases; camera casings; battery separators; spectacle cases; cases for children's eye glasses; cases for contact lenses; lens cases; fire-resistant flying suits; respirators for filtering air; clothing for protection against fire; fireproof automobile racing suits for safety purposes; fire blankets; clothing for protection against fire; filters for respiratory masks; respiratory mask filters [non-medical]; safety nets; footwear for protection against fire; flame-retardant balaclavas; boots for protection against fire; clothing for protection against accidents, irradiation and fire; helmets for motorcyclists; cases fitted with dissecting instruments for scientific or research purposes; cases fitted with dissecting instruments not for medical use; laboratory filters; fire resistant gloves; protective and safety equipment.

10 – Breast shields; incontinence bed pads; medical drapes of non-woven textile materials; haemostats; surgical mesh; medical furniture and bedding, equipment for moving patients; blankets for medical purposes; incontinence sheets for use with babies; incontinence sheets for use with infants; cushions for medical purposes; pillows for orthopedic use; pillows for therapeutic use; pillows (soporific -) filled with down; sheets [drapes] for medical use; incontinence mattress protectors; incontinence sheets; medical clothing; disposable protective gloves for medical purposes; gloves for medical purposes; gloves for use in hospitals; medical compression stockings; surgical mesh comprised primarily of artificial materials; knee supports for medical use.

12 – Fitted liners for the cargo area of vehicles; linings for vehicles; upholstery for vehicles; protective interiors for vehicles; roof linings for vehicles; interior panels for vehicles; car safety seats for children; car safety seats for children; car safety seats for children; children's seats for use in vehicles; child carrying seats for use in vehicles; safety seats for vehicles; pet safety seats for use in vehicles; safety seats for infants and children for vehicles; safety seats for vehicles; car seat canopies; car tidies; boot tidies; seat covers [shaped] for use in automobiles; coverings for car seats; car seats; children's car seats; seat cushions for the seats of vehicles; children's car seats; sun shields and visors for motor cars.

16 – Crepe paper; filtering materials of paper; filter paper; paper filters for coffee makers; printed packaging materials of paper; containers of paper for packaging purposes; bags made of paper for packaging; decorative paper bows for wrapping; decorative wrapping paper; humidity control sheets of paper or plastic for foodstuff packaging; sheets of reclaimed cellulose for wrapping; gift wrap paper;

cardboard packaging; plastic film for packaging; paper impregnated with oil for wrapping purposes; plastic materials for packaging; paper for wrapping and packaging; paper sacks; bags made of paper for packaging; bows for decorating packaging; bags made of paper for packaging; bags and articles for packaging, wrapping and storage of paper, cardboard or plastics; industrial packaging containers of paper; containers of card for packaging; packaging containers of regenerated cellulose; bags [envelopes, pouches] of paper or plastics, for packaging; films for wrapping foodstuffs; packing cardboard; cartons of cardboard for packaging; fiberboard boxes; plastic materials for packaging (not included in other classes); wrapping materials made of paper; packaging materials made of cardboard; packaging materials made of recycled paper; packaging material made of starches; packaging materials; wrapping paper; cartons of cardboard for packaging; cartons of cardboard for packaging; bags made of paper for packaging; viscose sheets for wrapping; pencil boxes; cases for stationery; adhesive packaging tapes; adhesive wall decorations of paper; promotional publications; book covers; crepe paper for domestic use; paper for use in the manufacture of wallpaper; tissue paper for use as material of stencil paper (ganpishi); paper for use in the manufacture of tea bags; tissues of paper for removing make-up; coarse tissue [for toiletry use]; filters (paper coffee -); paper wipes; facial tissues of paper; absorbent sheets of paper or plastic for foodstuff packaging; paper tissues; tissue paper; hygienic paper; paper tissues for cosmetic use; cellulose wipes.

17 – Fibres for insulating purposes; quilted blankets for insulating; regenerated fiber thread not for textile use; chemical fibres not for textile use; synthetic fibres, other than for textile use; insulation and barrier articles and materials; insulating fabrics; fabrics made from synthetic fibres [for insulation]; fabrics made of mixed synthetic and natural fibres for use as insulation; fabrics of carbon fibre for use as insulation; fabrics of chemically produced fibres for use as insulation; fabrics of organic fibres for use as insulation; fiberglass for insulation; fibres impregnated with synthetic resins for insulation; fleeces of crude fibres of carbon [insulation]; insulating paper; insulation material for use in the aircraft industry; insulating materials produced from plastics; insulation sheets; magnet wire (insulation for -); insulating paper; paper impregnated with oil for insulating; pipe insulation; pre-formed insulation components; treated papers for insulating; thermal insulation articles and materials; fibreboard for high temperature insulation; heat resistant fabrics [insulation]; insulation jackets for industrial pipes; insulations of synthetic material for the thermic protection of pipes; insulations with sealing functions for heat protection; thermal insulation jackets for industrial plant; thermal insulating materials; electrical insulation

articles and materials; electrical insulating tape; insulation for electric conductors; paper for electrical capacitors; substrates for electrical insulation; acoustic insulation articles and materials; acoustical tiles; acoustical insulation barrier panels; acoustical insulation for buildings; structures (non-metallic -) for noise abatement [insulation]; foils of cellulose [other than for wrapping or packaging]; foil of regenerated cellulose, other than for packing; foam rubber; carbon fibre; regenerated cellulose for use in manufacture; viscose sheets, other than for packing; carbon fibres for use in industry; carbon fibers [fibres], other than for textile use; raw fibres of carbon, other than for textile use; resin impregnated carbon fibre fabrics; yarns of carbon fibres [other than for use in textiles]; molded foam for packing; packaging tapes (adhesive -), other than for household or stationery use; plastic fibers for use in the manufacture of tire cord; flame retardant fabrics [asbestos]; fire resistant insulated panels; insulating refractory materials; insulating felt; fabrics of chemically produced fibres for use as insulation; insulations of synthetic material for the thermic protection of pipes; foils of cellulose [other than for wrapping or packaging]; semi-worked plastic substances; filtering materials [semi-processed foams or films of plastic].

20 – Beds, bedding, mattresses, pillows and cushions; bedding for cots [other than bed linen]; bedding for cots [other than bed linen]; replacement seat covers [fitted] for furniture; textile covers [shaped] for furniture; inflatable pillows; bath pillows; bedding, except linen; children's beds made of cloth in the form of a bag; futon mattresses [other than childbirth mattresses]; head supporting pillows; maternity pillows; mattress toppers; mattresses; mattresses; mattresses [other than child birth mattresses]; nap mats [cushions or mattresses]; neck-supporting pillows; nursing pillows; pet cushions; pillows; scented pillows; sleeping mats for camping [mattresses]; soft furnishings [cushions]; stuffed pillows; support pillows for use in baby car safety seats; support pillows for use in baby seating; animal housing and beds; beds for pets; pet cushions; pet houses; advertising display boards; advertisement display boards of plastic [non-luminous].

21 – Anti-static cloths for cleaning; dusters; eyeglass cleaning cloths; towel rings; chopstick cases; applicators for applying eye make-up; cases adapted for cosmetic utensils; toilet cases; applicators for cosmetics; oven mitts; cleaning rags; cleaning rags; cleaning rags.

22 – Raw textile fibers and substitutes; liber; raw cotton; treated wool; chemical fibers for textile use; fibres being partly prepared synthetic materials for textile use; fibres being raw synthetic materials for textile use; silk flock; yarn fibers; twisted cords [sash]; raw fibrous textile; scoured wool; semi-synthetic fibers [for textile use]; true hemp fiber [raw];

rabbit hair; jute; jute fiber [raw]; combed wool; cashmere wool [raw material]; linters; raw fibrous textile materials treated with flame retardants; mohair; natural fibers; polyester stuffing fibers; polyester filament; polyester plastic netting for packaging goods; vitreous silica fibers for textile use; raffia fibers; ramie fibre; raw textile fibers; raw fibres of plastics for textile use; linen (raw -) [flax]; raw silk; raw wool; silk waste; shorn wool; silk fibers; silk polyester monofilaments; carded wool; synthetic fibers for textile use; synthetic fibers for textile use; synthetic textile filaments; textile filaments; textile fibers; non-woven textile fibres; fibres for making up into carpets; fibres for making up into carpet tiles; viscose silica fibres; raw or treated wool; wool flock; bags and sacks of textile for packaging, storage and transport; liners for use in bulk containers; bags and sacks for packaging, storage and transport; nets; plant hangers of rope; non-metal slings and bands for handling loads; strips for tying-up vines; wrapping or binding bands, not of metal; hammocks; storage bags for holding a body prior to cremation; mesh bags for washing lingerie; mesh bags for storage; packaging bags [sacks] of textile for bulk transportation; packaging bags [sacks] of textile for bulk storage; sacks; sacks made of textile materials; sacks for transporting waste; sacks for the transport of materials; sacks for the storage of materials in bulk; sacks and bags (not included in other classes); sacks for the storage of materials; bags [sacks] for the transport and storage of materials in bulk; non-textile bags for the transportation of materials in bulk; non-textile bags for the bulk storage of animal foodstuffs; non-textile bags for the bulk storage of materials; shoe bags for storage; sail bags (terms considered too vague by the International Bureau – rule 13.2.b) of the Common Regulations); textile wine gift bags; protection pouches made of fabric for storing purses when not in use; bags [envelopes, pouches] of textile, for packaging; bags [envelopes, pouches] of textile, for packaging; bags [envelopes, pouches] of textile, for packaging; packaging nets for transporting fruits and vegetables; bags [envelopes, pouches] of textile, for packaging; textile bags for merchandise packaging [envelopes, pouches]; tarpaulins, awnings, tents, and unfitted coverings; tents for use in angling; tents for camping; vehicle covers, not fitted; unfitted covers for boats and marine vehicles; tarpaulins; tents; tents [awnings] for vehicles; tents [awnings] for caravans; tents made of textile materials; tents for mountaineering or camping; sails; canvas for making sails; ropes and strings; binding thread, not of metal, for agricultural purposes; thread, not of metal, for wrapping or binding; strings; twine made of polypropylene; twine made of sisal; non-metallic twines; strings for tying purposes; packaging string; macrame rope; cordage; ropes and synthetic ropes; rope for use in toys for pets; synthetic ropes; cordage; ropes, not of metal;

balancing twine; packing rope; nets; elastic netting for meat products; hemp nettings; netting [not of metal or asbestos]; nets for windbreak purposes; chemical fiber nettings; rockfall prevention nets of textile; commercial fishing nets; commercial nets; nets for use with floating structures; twine for nets; net pens for fish farming; nets for shading; silk netting; fitted nets; padding and stuffing materials; down feathers; feathers for stuffing upholstery; wadding for filtering; fillings of synthetic fibres; fillings for upholstered pillows; fillings of synthetic foam; fillings for duvets; fillings for pillows; fillings for quilts; wood shavings; kapok; loose feathers; materials for padding; padding materials, other than of rubber or plastic for pillows; padding materials, other than of rubber or plastic for sleeping bags; padding materials made of fibrous material; padding materials made of fibrous material; padding made of non woven fabrics; padding materials, other than of rubber or plastic for beds; polyester batting; sawdust; sisal; sisal fibers; industrial packaging containers of textile; fleece for the upholstery industry; wadding for padding and stuffing upholstery; wadding fibres; wool (upholstery -) [stuffing]; padding and stuffing materials (except of paper, cardboard, rubber or plastics); fillings for upholstered pillows; spun polyester fibre for textile use.

23 – Yarns and threads; angora yarn; spools of thread; spools of yarn; spun cotton; cotton yarn; chenille yarn; chenille yarn; douppioni silk yarn; elastic thread; elastic thread and yarn for textile use; elastic thread and yarn of synthetic fibres for textile use; threads made of spun cotton; thread for textile use; textile filaments [threads]; flocked fibers (terms considered too vague by the International Bureau – rule 13.2.b) of the Common Regulations); yarn; yarns made of angora for textile use; waste cotton yarn; polyester pre-oriented yarns; yarns made of carbon fibres for textile use; yarn of synthetic or mixed fibres for use in textiles; wild silk yarn; knitting yarns; yarns for domestic use; yarns for textile applications; inorganic fiber base mixed thread and yarn; cotton base mixed thread and yarn; chemical fiber base mixed thread and yarn; chemical-fiber threads and yarns for textile use; degreased waste threads and yarns; hemp base mixed thread and yarn; regenerated fiber thread and yarn [for textile use]; silk base mixed thread and yarn; synthetic fiber thread and yarn; wool base mixed thread and yarn; yarns and threads for textile use; yarns for sale in kit form; twisted cotton thread and yarn; twisted threads and yarns; twisted hemp thread and yarn; twisted silk thread and yarn; twisted wool thread and yarn; yarns (combed -) made of natural fibres; twisted mixed thread and yarn; worsted yarn; spun silk yarn; spun silk yarn; semi-synthetic fiber thread and yarn [chemically treated natural fiber yarn]; hand knitting wools; true hemp thread and yarn; true hemp thread and yarn; heat-stable yarns and threads; jute thread

and yarn; camel hair yarn; carded threads in flax for textile use; carded yarns of hemp for textile use; carded threads in natural fibres for textile use; carded threads in natural fibres for textile use; yarns (carded -) made of wool; carded threads in wool for textile use; cashmere yarns; ceramic fibre yarns for textile use; coir thread and yarn; rayon thread and yarn; linen thread and yarn; linen thread and yarn; metal fiber thread for textile use; sewing thread for textile use; sewing thread and yarn; natural yarns; non-metallic yarns for textile use; silica threads; ramie thread and yarn; raw silk yarn; spun silk; silk yarn; embroidery thread and yarn; knitting yarns; knitting yarns made of acrylic materials; knitting yarns made of nylon; knitting yarns made of wool; polyester textured yarns; yarns made of synthetic material for textile use; synthetic threads; carpet yarns; textile yarns; textile yarns made of man-made fibres; textile yarns made of natural fibres; covered rubber thread and yarn [for textile use]; mixed spun threads and yarns; waxed thread; waxed yarn; weaving fibre thread and yarn for industrial use; spun thread and yarn; worsted; wool yarn; wool yarn; yarns for use in tyre cord construction.

24 – Flocked fabrics; fabrics being textile piece goods for use in tapestry; tick [linen]; knitted elastic fabrics for ladies underwear; knitted elastic fabrics for bodices; knitted elastic fabrics for sportswear; knitted elastic fabrics for gymnastic dresses; fibre fabrics for use in the manufacture of articles of clothing; fibre fabrics for the manufacture of the exterior coverings of furniture; fibre fabrics for use in the manufacture of linings of shoes; fibre fabrics for use in the manufacture of linings of bags; felt; felt for use by papermakers; felt cloth; flame retardant fabrics [other than asbestos]; flannel [fabric]; towelling [textile]; linings [textile]; inlay materials of non-woven fabrics; chemical fiber fabrics; fabrics for textile use; knit lace fabrics; knitted fabric; gummed waterproof cloth; towelling [textile]; linens; jersey [fabric]; jersey [fabric]; fabrics of carbon fibre, other than for insulation; fabrics [textile piece goods] made of carbon fibre; fabrics made from artificial fibres [other than for insulation]; upholstery fabrics; furnishing fabrics; upholstery fabrics; furnishing fabrics in the piece; furnishing fabrics in the piece; woven furnishing fabrics; non-woven felts; silk fabrics for furniture; semi-synthetic fiber fabrics; fabrics of chemically produced fibres, other than for insulation; fabrics of organic fibres, other than for insulation; regenerated fiber yarn fabrics; fabrics made from artificial fibres [other than for insulation]; fabrics for use in making jerseys; knitted fabric; knitted fabrics of cotton yarn; knitted fabrics of chemical-fiber yarn; knitted fabrics of wool yarn; fabrics made of mixed synthetic and natural fibres, other than for insulation; textile fabrics for use in the manufacture of beds; textile fabrics for making into linens; textile fabrics for use in the manufacture of bedding; textile

fabrics for making into blankets; textile fabrics for use in the manufacture of furniture; textile fabrics for use in the manufacture of sheets; textile fabrics for use in the manufacture of towels; textile fabrics for use in the manufacture of pillowcases; textile piece goods for making bedding covers; textile piece goods for making-up into towels; cloth; tissues being textile piece goods; velours for furniture; non-woven fabrics; non-woven textile fabrics; non-woven textile fabrics; non-woven textile fabrics for use as interlinings; non-woven fabrics of natural fibres; non-woven fabrics of synthetic fibres; non-woven fabrics in the form of sheeting for use in manufacture; woven fabrics for furniture; textile goods, and substitutes for textile goods; nightdress cases of textile; printers' blankets of textile; disposable cloths; linings [textile]; linen lining fabric for shoes; wall fabrics; fabrics for textile use; household textile articles made from non-woven materials; linens; nightdress cases of textile; ticks [mattress covers]; coverings for furniture; mosquito nets; non-woven textile articles; dust sheets; textile tissues; textiles made of flannel; non-woven textile articles; interlinings made of non-woven fabrics; coverings for furniture; furniture coverings (unfitted); loose covers made of textile materials for furniture; furniture coverings of textile; dust sheets; loose covers made of textile materials for furniture; draperies [thick drop curtains]; curtains; markers [labels] of cloth for textile fabrics; wall fabrics; wall hangings of textile; bed linen; bed linen; towelling [textile]; towels of textile; kitchen and table linens; towels of textile; hand towels of textile; bed linen and table linen; tea cloths; dish towels for drying; towelling [textile]; hand towels of textile; place mats, not of paper; textile smallwares [table linen]; table covers; table cloths (not of paper); tablemats, not of paper; table covers of non-woven textile fabrics; textile napkins; table linen, not of paper; napery of textile; table linen; washing gloves; bed linen; receiving blankets; bed linen and table linen; bed sheets; duvet covers; comforters; bed blankets made of cotton; bed blankets made of man-made fibres; bed covers of paper; silk bed blankets; woolen blankets; duvet covers; bed sheets; bed skirts; bed throws; fabric bed valances; bed linen made of non-woven textile material; infants' bed linen; covers for eiderdown and duvets; comforters; blankets for household pets; quilts; blankets for outdoor use; disposable bedding of textile; eiderdowns [down coverlets]; terry linen; futon quilts; sleeping bags [sheeting]; waterproof bed clothes; cot blankets; cot sheets; children's blankets; shams; lap rugs; contoured mattress covers; pillowcases; ticks (mattress and pillow coverings); mattress covers; mattress covers; quilts filled with down; duvets; travelling rugs [lap robes]; sleeping bag liners; silk blankets; contour sheets; quilt bedding mats (terms considered too vague by the International Bureau – rule 13.2.b) of the Common Regulations); quilts of textile; quilts

of textile; quilts filled with feathers; quilts filled with half down; quilts filled with stuffing materials; quilts filled with synthetic stuffing materials; quilts; quilt covers; textile covers for duvets; textile goods for use as bedding; bed sheets; bed throws; valanced bed sheets; bed skirts; woolen blankets; bath linen; hand towels of textile; bath sheets; bath towels; bath linen, except clothing; disposable wash cloths; towelling coverlets; face cloths of towelling; turkish towel; turkish towel; bath sheets; bath sheets; towelling [textile] adapted for use in dispensers; hand towels; towelling [textile]; hand towels of textile; children's towels; towelling [textile]; household linen, including face towels; make-up removal cloths [textile], other than impregnated with cosmetics; make-up removal cloths [textile], other than impregnated with toilet preparations; cloths of woven textile material for washing the body (other than for medical use); cloths of non-woven textile material for washing the body [other than for medical use]; bath mitts; mitts made of non-woven fabric for washing the body; wash cloths; cloths for washing the body [other than for medical use]; filtering materials of textile; flame resistant fabrics; baby bunting.

25 – Headgear; swimming caps; bandanas [neckerchiefs]; baseball caps; berets; bobble hats; millinery; shower caps; fascinator hats; fedoras; fezzes; bucket caps; golf caps; yashmaks; bonnets [headwear]; tams; hats; frames (hat -) [skeletons]; skull caps; waterpolo caps; hoods [clothing]; small hats; knot caps; chefs' hats; sports headgear [other than helmets]; children's headwear; head scarves; head scarves; head scarves; yashmaghs; miters [hats]; fashion hats; caps [headwear]; cap peaks; sun visors [headwear]; nightcaps; hats (paper -) [clothing]; paper hats for wear by chefs; paper hats for wear by nurses; party hats [clothing]; fur muffs; fur hats; head scarves; rain hats; knitted caps; flat caps; garrison caps; sedge hats (suge-gasa); sleep masks; veils [clothing]; wimples; tam o'shanters; tennis sweatbands; ski hats; sun hats; sports caps and hats; sports caps; headbands [clothing]; head sweatbands; beach hats; knitted caps; balaclavas; thermal headgear; toques [hats]; head scarves; woolly hats; top hats; clothing; evening wear; evening coats; detachable neckpieces for kimonos (haneri); detachable collars; underarm gussets [parts of clothing]; aikido suits; albs; american football bibs; parkas; suits; evening suits; women's suits; bowties; dress pants; jumper suits; blouses; work clothes; coveralls; blouses; sleeveless jerseys; mantles; arm warmers [clothing]; gowns for doctors; warm-up pants; clothing made of fur; driving gloves; layettes [clothing]; layettes [clothing]; baby bodysuits; baby doll pyjamas; babies' pants [clothing]; plastic baby bibs; baby tops; babies' pants [clothing]; baby bottoms; layettes [clothing]; pram suits; swimming costumes; bathing costumes for women; bathing suits for men; fitted swimming costumes with bra cups; swim wear for gentlemen and

ladies; bathing drawers; swimming costumes; swimming costumes; bathrobes; bathing drawers; swimming trunks; bathwraps; robes; ballet suits; ball gowns; bandanas [neckerchiefs]; bandeaux [clothing]; baseball uniforms; baselayer bottoms; baselayer tops; crop tops; printed t-shirts; leg warmers; cashmere clothing; clothing of imitations of leather; woolen clothing; motorists' clothing; baby clothes; bridesmaids wear; figure skating clothing; christening robes; clothing for wear in judo practices; children's wear; infant wear; girls' clothing; motorcyclists' clothing of leather; leather clothing; linen clothing; paper clothing; plush clothing; silk clothing; clothing for martial arts; clothing for horse-riding [other than riding hats]; articles of clothing for theatrical use; clothing for fishermen; boys' clothing; clothing for wear in wrestling games; maternity clothing; lounge pants; bermuda shorts; bed jackets; bed socks; maillots; blazers; blouses; boas [necklets]; leotards; body stockings; teddies [undergarments]; boleros; bolo ties; bomber jackets; boxer shorts; wedding dresses; burnouses; brassieres; bustiers; pea coats; capes; pedal pushers; car coats; cargo pants; chaps (clothing); chasubles; chemisettes; cheongsams (chinese gowns); albs; choir robes; evening wear; corduroy trousers; coverups; ladies' clothing; lingerie; gowns; women's outerclothing; knickers; ladies' underwear; ladies' underwear; down jackets; down vests; denim jeans; topcoats; donkey jackets; three piece suits [clothing]; duffel coats; pocket squares; one-piece suits; jumper suits; one-piece playsuits; disposable underwear; skating outfits; athletic tights; woollen tights; pleated skirts for formal kimonos (hakama); masquerade costumes; women's ceremonial dresses; moisture-wicking sports bras; moisture-wicking sports shirts; moisture-wicking sports pants; fishing shirts; fishing vests; fleeces; fleece vests; bowties; flying suits; formal evening wear; formalwear; foulards [clothing articles]; morning coats; leisure suits; casual shirts; slacks; casualwear; tap pants; barber smocks; robes; replica football kits; football jerseys; soccer bibs; footmuffs, not electrically heated; gabardines [clothing]; goloshes; gaiters; morning coats; padded pants for athletic use; padded shirts for athletic use; padded shorts for athletic use; knitwear [clothing]; knitted gloves; knit jackets; knitted underwear; guernseys [clothing]; woven clothing; woven shirts; gilets; polo shirts; golf trousers; golf pants, shirts and skirts; golf skirts; unitards; clothing for gymnastics; ankle socks; halloween costumes; neckbands; neckwear; scarves; neck tubes; wrist warmers; gloves [clothing]; gloves for cyclists; gloves with conductive fingertips that may be worn while using handheld electronic touch screen devices; gloves including those made of skin, hide or fur; handwarmers [clothing]; loungewear; aloha shirts; button-front aloha shirts; shirt yokes; shirts; shirts for suits; collared shirts; open-necked shirts; button down shirts; nighties; slippers [undergar-

ments]; shirt-jacs; shirt fronts; men's suits; menswear; outerclothing for men; men's socks; men's underwear; waistcoats; wedding dresses; lumberjackets; hooded pullovers; knickers; trousers; trousers of leather; trousers for children; trousers for children; nurse pants; sweatpants; snowboard trousers; pantsuits; culotte skirts; knee-high stockings; braces for clothing [suspenders]; suspender belts for men; girdles; girdles; jackets [clothing]; jackets being sports clothing; polar fleece jackets; fishermen's jackets; sleeved jackets; sleeveless jackets; snowboard jackets; rainproof jackets; men's and women's jackets, coats, trousers, vests; jacket liners; hunting pants; hunting jackets; hunting vests; hunting shirts; kimonos; denims [clothing]; denim jeans; denim jackets; jumpers; jodhpurs; shell suits; jogging sets [clothing]; sweatpants; jogging tops; sweatpants; heavy jackets; stuff jackets [clothing]; judo suits; caftans; bodices [lingerie]; martial arts uniforms; combative sports uniforms; hooded sweatshirts; karate suits; cashmere scarves; kendo outfits; khakis; kilts; kilts; kimonos; gowns; pinafores; gowns; nurse dresses; linings (ready-made -) [parts of clothing]; pockets for clothing; leisurewear; bloomers; walking breeches; trouser socks; knee warmers [clothing]; short sets [clothing]; ready-to-wear clothing; basic upper garment of korean traditional clothes [jeogori]; korean traditional women's waistcoats [baeja]; korean topcoats [durumagi]; body warmers; corselets; camisoles; corsets; corsets; corsets; costumes; skirt suits; costumes for use in children's dress up play; costumes for use in role-playing games; shoulder wraps; detachable collars; collars for dresses; neckties; ascots; crinolines; cummerbunds; short-sleeved or long-sleeved t-shirts; short-sleeve shirts; short-sleeve shirts; short trousers; sweatpants; short petticoats; short overcoat for kimono (haori); cowls [clothing]; laboratory coats; long sleeve pullovers; long sleeved vests; long jackets; japanese sleeping robes (nemaki); full-length kimonos (nagagi); long johns; bibs, not of paper; bib overalls for hunting; running suits; running vests; leather suits; leather clothing; leather jackets; leather jackets; casual trousers; leggings [trousers]; underwear; sweat-absorbent underwear; light-reflecting jackets; lingerie; liveries; bathing suit cover-ups; outerclothing for girls; maniples; athletic uniforms; cuffs; coats; pelisses; cotton coats; coats of denim; coats for women; coats for men; mantillas; sleep masks; eye masks; sailor suits; corselets; foundation garments; miniskirts; monokinis; robes; lounging robes; motorcycle riding suits; motorcycle gloves; motorcycle jackets; muffs [clothing]; muumuus; nighties; nighties; nighties; nightwear; wet suits; negligees; pop socks; women's outerclothing; outerclothing; dress shirts; uppers of woven rattan for japanese style sandals; chemise tops; cycling tops; hooded tops; halter tops; earbands; ear muffs [clothing]; combinations [clothing]; coveralls; coveralls; nurse overalls; overshirts;

beach wraps; parkas; pelerines; furs [clothing]; pelisses; fur coats and jackets; fur muffs; fur cloaks; petticoats; petti-pants; polo shirts; pirate pants; plastic aprons; pantaloons; polo shirts; polo knit tops; turtleneck sweaters; polo sweaters; ponchos; sweaters; crew neck sweaters; mock turtleneck sweaters; v-neck sweaters; slipovers [clothing]; bloomers; pyjamas; pajama bottoms; cyclists' clothing; cycling shorts; ramie shirts; rash guards; head scarves; rainproof clothing; rainwear; waterproof trousers; mackintoshes; rain ponchos; riding gloves; jodhpurs; riding jackets; skirts; turtlenecks; roll necks [clothing]; turtleneck shirts; turtleneck sweaters; rugby tops; rugby shorts; rugby tops; bushjackets; saris; sarongs; sheepskin jackets; sheepskin coats; neck scarfs [mufflers]; mufflers [clothing]; shawls [from tricot only]; shawls and headscarves; shawls and stoles; sashes for wear; sash bands for kimono (obi); referees uniforms; nightwear; sleep masks; nighties; tube tops; veils [clothing]; cravats; knickers; snow suits; snow suits; snow pants; shoulder scarves; shoulder wraps [clothing]; school uniforms; aprons [clothing]; paper aprons; maternity bands; maternity smocks; sweat-absorbent socks; sweat-absorbent stockings; sweatbands; sweat bands for the wrist; headbands [clothing]; dress shields; anti-perspirant socks; head sweatbands; uniforms for nurses; swimming trunks; silk ties; silk scarves; adhesive bras; shampoo capes; shell jackets; shift dresses; mock turtleneck shirts; shirts and slips; shortalls; shorts; fleece shorts; boy shorts [underwear]; snow suits; ski suits for competition; ski gloves; ski trousers; ski jackets; clothing for skiing; ski balaclavas; sliding shorts; briefs; cummerbunds; dinner jackets; dinner suits; snow boarding suits; snowboard gloves; japanese style socks (tabi); socks and stockings; sock suspenders; bralettes; sundresses; sunsuits; playsuits [clothing]; camiknickers; gym suits; sports clothing [other than golf gloves]; sportswear; sports bras; casual shirts; sports shirts with short sleeves; sports pants; sports jackets; sports socks; singlets; sports jerseys and breeches for sports; gym suits; athletics vests; dust coats; quilted jackets [clothing]; quilted vests; cloth bibs; cloth bibs for adult diners; tightening-up strings for kimonos (datejime); rompers; snap crotch shirts for infants and toddlers; beachwear; beach robes; stretch pants; knitwear [clothing]; knit shirts; cardigans; thongs; garters; stockings; sweat-absorbent stockings; heelpieces for stockings; pantie-girdles; tights; maillots [hosiery]; footless tights; hosiery; footless socks; surfwear; jockstraps [underwear]; sweaters; tracksuit bottoms; sweatjackets; sweat shirts; sweat shorts; taekwondo suits; waist cinchers; tank tops; dance clothing; dance costumes; tabards; camouflage gloves; camouflage shirts; camouflage pants; camouflage jackets; camouflage vests; trews; tennis wear; tennis shirts; tennis dresses; tennis pullovers; tennis skirts; tennis shorts; tennis socks; fabric belts [clothing]; thobes;

theatrical costumes; thermal socks; thermal underwear; togas; tops [clothing]; folk costumes; japanese traditional clothing; bra straps; bib tights; pinafore dresses; strapless bras; tank tops; clothing for gymnastics; sweatpants; sweat shorts; tracksuit tops; trench coats; bib shorts; triathlon clothing; knitwear [clothing]; singlets; dry suits; tee-shirts; kerchiefs [clothing]; neckerchiefs; head scarves; tunics; turbans; clothing for gymnastics; gym shorts; tutus; twin sets; korean outer jackets worn over basic garment [magoja]; nappy pants [clothing]; topcoats; over-trousers; neck scarves; cloaks; shawls; maternity clothing; maternity sleepwear; maternity lingerie; uniforms; uniforms for commercial use; uniforms for nurses; referees uniforms; union suits; underwear; babies' undergarments; sweat-absorbent underwear; vest tops; undershirts for kimonos (juban); undershirts for kimonos (koshimaki); bottoms [clothing]; pants; chemises; petticoats; bustles for obi-knots (obiage-shin); tracksuit bottoms; underwear; garments for protecting clothing; suit coats; volleyball jerseys; thermally insulated clothing; warm-up jackets; warm-up tops; weatherproof clothing; waterproof suits for motorcyclists; waterproof capes; waterproof outerclothing; water socks; waterproof trousers; rainproof jackets; oilskins [clothing]; wetsuits for water-skiing; chefs' whites; white coats for hospital use; caftans; sweat shirts; reversible jackets; waistcoats; leather waistcoats; cagoules; weatherproof clothing; sailing wet weather clothing; puttees and gaiters; wrap belts for kimonos (datemaki); beach wraps; beach wraps; swaddling clothes; salopettes; windproof clothing; wind suits; wind pants; windshirts; wind vests; winter gloves; winter coats; hosiery; weather resistant outer clothing; woollen socks; yoga pants; yoga shirts; zoot suits; gussets [parts of clothing]; gussets for bathing suits [parts of clothing]; gussets for footlets [parts of clothing]; gussets for leotards [parts of clothing]; gussets for stockings [parts of clothing]; gussets for tights [parts of clothing]; gussets for underwear [parts of clothing]; footwear; heels; heelpieces for footwear; bootees (woollen baby shoes); bath slippers; footwear for women; insoles for footwear; espadrilles; heel inserts; flat shoes; embossed heels of rubber or of plastic materials; embossed soles of rubber or of plastic materials; non-slipping devices for footwear; slippers; slipper socks; stiffeners for shoes; inner socks for footwear; running shoes; infants' footwear; leather slippers; leather shoes; canvas shoes; deck shoes; uppers for japanese style sandals; slippers; pumps [footwear]; welts for footwear; rain boots; riding shoes; riding shoes; shoe straps; rugby boots; mules; slip-on shoes; shoes; athletic shoes; leisure shoes; shoes for foot volleyball; shoes with hook and pile fastening tapes; high-heeled shoes; mountaineering shoes; shoe inserts for non-orthopedic purposes; shoe uppers; footwear soles; shoe covers, other than for medical purposes;

footwear uppers; snowboard shoes; shoe soles; slipper soles; soles for japanese style sandals; espadrilles; dance shoes; ballroom dancing shoes; tennis shoes; training shoes; tips for footwear; waterproof boots for fishing; aqua shoes; winter boots; yoga shoes; zori; tongues for shoes and boots; ladies' underwear; wetsuit gloves; pyjamas [from tricot only]; intermediate soles.

27 – Carpets, rugs and mats; bath mats; textile bath mats; bath mats; bath mats; vehicles mats and carpets; rugs (floor -); door mats; runners [mats]; oriental non-woven rugs (mosen); carpet tile backing; carpet backing; carpeting; carpet tiles; primary carpet backing; textile bath mats; carpets [textile]; wallpaper; wall paper of vinyl; wall coverings of paper; carpets.

35 – Advertising, marketing and promotional services; bill-posting; banner advertising; merchandising; public relations services; advertisement for others on the internet; telemarketing services; sales promotion for others; advertising; display services for merchandise; preparation and presentation of audio visual displays for advertising purposes; organisation and conducting of product presentations; presentation of goods and services; sales demonstration [for others]; demonstration of goods and services by electronic means, also for the benefit of the so-called teleshopping and homeshopping services; demonstration of goods for promotional purposes; arranging of demonstrations for advertising purposes; demonstration of goods; arranging and conducting of trade show exhibitions; arranging of exhibitions for business purposes; arranging of exhibitions for advertising purposes; exhibitions (conducting -) for business purposes; exhibitions (conducting -) for business purposes; exhibitions (conducting -) for advertising purposes; organisation of exhibitions and trade fairs for business and promotional purposes; shows (conducting business -); arranging and conducting of fashion show exhibitions for commercial purposes; arranging of displays for commercial purposes; organisation of events for commercial and advertising purposes; organization of events, exhibitions, fairs and shows for commercial, promotional and advertising purposes; arranging of demonstrations for advertising purposes; planning and conducting of trade fairs, exhibitions and presentations for economic or advertising purposes; arranging of exhibitions for advertising purposes; rental of advertising space online; rental of advertising space; distribution of advertising, marketing and promotional material; distribution of promotional matter; distribution of advertisements and commercial announcements; dissemination of advertising matter; distribution of advertising material; dissemination of advertising and promotional materials; dissemination of advertising, marketing and publicity materials; dissemination of advertisements; dissemination of advertising for ot-

hers; dissemination of advertising for others via the internet; distribution and dissemination of advertising materials [leaflets, prospectuses, printed material, samples]; handbill distribution; handbill distribution; handbill distribution; distribution of samples for publicity purposes; distribution of prospectuses and samples; handbill distribution; distribution of products for advertising purposes; sample distribution; distribution of advertising announcements; distribution and dissemination of advertising materials [leaflets, prospectuses, printed material, samples]; handbill distribution; handbill distribution; distribution of promotional matter; arranging the distribution of advertising literature in response to telephone enquiries; arranging of presentations for business purposes; office functions; business management; supply chain management services; arranging of presentations for business purposes; arranging of presentations for business purposes; business administration; marketing studies; compilation of scientific information; collection of information relating to hydrology.

42 – Services in the field of science and technology and related research and development services; advisory services relating to scientific research; computer aided scientific analysis services; computer aided scientific research services; scientific testing services; preparation of scientific reports; provision of information relating to scientific research; provision of scientific information; advisory services relating to science research; scientific services and design relating thereto; scientific services and research relating thereto; scientific research relating to cosmetics; scientific research for medical purposes; scientific research and analysis; laboratory (scientific -) services; scientific and industrial research; scientific investigations for medical purposes; consultancy services relating to product engineering; engineering services for others; engineering consultancy services; engineering testing; preparation of engineering reports; engineering consultancy services; engineering research; engineering consultancy relating to testing; technical engineering; conducting of scientific studies; scientific analysis; information services relating to testing in the field of the safety of chemicals used in horticulture; information services relating to testing in the field of the safety of chemicals used in agriculture; scientific research relating to chemistry; scientific research relating to ecology; engineering testing; scientific testing services; textile testing; quality testing of products for certification purposes; certification [quality control]; providing information in the field of product development; product research and development; design of carpets; designing of packaging and wrapping materials; design of curtains.

(260) AM 2018 93994 A

(800) 1362107

(151) 2017 04 01

(891) 2017 04 01

(731) CHINA CENTRAL TELEVISION
No.11, Fuxing Road Beijing, China

(540)

CGTNPLUS

(591) Black and white

(531) 27.05.17

(511)

9 – Electronic publications, downloadable; downloadable image files; downloadable music files; computer software applications, downloadable; computer programs for editing images, sound and video; computer software for processing image, graphics and word; computer software for organizing and viewing digital images and photos; computer software for music composition; compact disc; animated cartoons.

16 – Printed matter; printed publications; posters; books; periodicals; magazines [periodicals]; newsletters; newspapers; picture poster; photographs [printed].

35 – Advertising; television advertising; production of advertising films; publication of publicity texts; advertising design; promotion movie series for others; market investigations based on computer database; consultancy and advisory services for business strategy; business management planning; business management of performing artists; word processing.

36 – Capital investment; lease-purchase financing; investment of funds; rental of real estate; real estate agency services; real estate management; rental of offices [real estate]; apartment house management; rental of apartments; commercial housing sales.
38 – Pay-per-view television programmes broadcasting; television broadcasting; cable television broadcasting; news agency services; internet broadcasting services; message sending; providing online forums; providing access to databases; providing telecommunications connections to a global computer network; providing user access to global computer networks; transmission of digital files.

41 – Production of radio and television programmes; television entertainment; production of shows; news reporters services; writing of texts; photographic reporting; production of music; entertainer services; performance for live comedy programmes; entertainment information; publication of texts, other than publicity texts; publication of books; providing online electronic publications, not downloadable; publish video tape; organization of competitions [education or entertainment]; organization of shows [impresario services]; instruction services.

42 – Conversion of data or documents from physical to electronic media; computer software design; maintenance of computer software; installation of computer software; providing search engines for the internet; information technology [IT] consultancy; design and development of multimedia products; research and development of new products for others; telecommunications technology consultancy; dress designing; construction planning and design for entertainment venue.

(260) AM 2018 93995 A

(800) 1362133

(151) 2017 06 23

(891) 2017 06 23

(731) RADIONOMY GROUP B.V.

Strawinskylaan 3127, Atrium 8th floor

NL-1077 ZX Amsterdam, Netherlands

(540)

WINAMP

(591) Black and white

(511)

9 – Computer software for use in organizing, manipulating, creating, playing, and viewing video, audio, graphic, text, multimedia content, and other data files; computer software for use in transmitting, delivering, broadcasting, and receiving video, audio, graphic, text, multimedia content, and other data files via computer and other communications networks; computer software for transmitting streamed and downloadable audio and video files via computer and other communications networks; computer software for use in writing to compact discs; computer software for broadcasting and transmission of radio and television programs via computer and other communications networks; computer software for web casting; computer software for transmitting prerecorded music, music videos, movies, and movie trailers; digital audio software for playing high-fidelity audio via an electronic communications network; downloadable software for playing high-fidelity audio via an electronic communications network.

38 – Telecommunications services, namely, providing multiple-user access to computer networks; electronic transmission on computer networks, providing online chat rooms for transmission of messages among computer users; electronic mail services; providing online electronic bulletin boards for transmission of messages among computer users.

41 – Entertainment services, namely, providing news and information in the field of music via computer networks.

42 – Computerized on-line services in the field of computer software and hardware, namely, the temporary use of non-downloadable computer software

for playing high-fidelity audio via an electronic communications network.

(260) AM 2018 93998 A

(800) 1362252

(151) 2017 03 23

(891) 2017 03 23

(731) BLAUER WORLD FASHION S.r.l.

Corso Stati Uniti, 41 I-10129 TORINO, Italy

(540)

Blauer

(591) Black and white

(531) 24.17.02; 27.05.01; 27.05.17

(511)

25 – Clothing, footwear and headgear directed to the consumer fashion market and excluding uniforms, outdoor, equipment, protective wear and other clothing items for the public safety market such as fire, police, emergency medical, hazardous material service and the like.

(260) AM 2018 94000 A

(800) 1362335

(151) 2017 05 31

(891) 2017 05 31

(731) SQUALIO GROUP, SIA

Krišjāņa Valdemāra iela 21-19 LV-1010

Rīga, Latvia

(540)



(591) Blue, light blue and white

(531) 26.04.22; 26.04.24; 27.05.11; 27.05.24;

29.01.12

(511)

9 – Data processing equipment; computers; computer software; all computer programs and software regardless of recording media or means of dissemination, that is, software recorded on magnetic media or downloaded from remote computer network; scientific, photographic, checking (supervision) apparatus and instruments for conducting, switching, transforming, accumulating, regulating or controlling electricity; apparatus for recording, transmission or reproduction of sound or images; magnetic data carriers, recording discs; compact discs; DVDs and other digital recording media, mechanisms for coinoperated apparatus; data processing equipment; all listed goods, as far as it does not concern vehicles.

35 – Advertising; business management; business administration; office functions; market studies; sales promotion for others; demonstration of goods; negotiation and conclusion of commercial transactions for third parties; retail services for computer software; all listed services, as far as it does not concern vehicles.

37 – Installation and repair of computer hardware and communications equipment; all listed services, as far as it does not concern vehicles.

42 – IT consultancy, advisory and information services; scientific and technological services and research and design relating thereto; design and development of computer hardware and software; professional advice relating to computer software and computer system design; all listed services, as far as it does not concern vehicles.

(260) AM 2018 94003 A

(800) 1362366

(151) 2017 06 20

(891) 2017 06 20

(731) APPLE INC.

1 Infinite Loop Cupertino CA 95014, USA

(540)

HomePod

(591) Black and white

(531) 27.05.05

(511)

9 – Audio speakers, amplifiers and receivers; digital audio players; sound reproducing apparatus; voice recording and recognition apparatus; microphones; radios, radio transmitters, and radio receivers; wireless communication devices for voice or data transmission; computer hardware for playing, organizing, downloading, transmitting, manipulating and reviewing audio files and media files; electronic devices capable of providing access to the internet and for the sending, receiving, and storing of digital data; voice-controlled smart audio speakers with virtual personal assistant capabilities; personal digital assistant; electronic voice command and recognition and remote control apparatus and devices for controlling and monitoring consumer electronics devices, lighting, appliances, thermostats, heating and air conditioning systems, alarm and home security and surveillance systems, smoke and carbon monoxide detectors, door and window locks and latches, and home automation systems; remote controls; accessories for smart audio speakers.

(260) AM 2018 94005 A

(800) 1362388

(151) 2017 06 30

(891) 2017 06 30

(731) LYKOS Pharma Ltd

7, Sir William Reid Street GZR 1039 GZR
1039 Gzira, Malta

(540)

ERMUCIN

(591) Black and white

(511)

5 – Pharmaceutical preparations; veterinary preparations; sanitary preparations for medical purposes; dietetic substances adapted for medical use; food for babies; plasters, materials for dressings; material for stopping teeth; dental wax; disinfectants; preparations for destroying vermin; fungicides; herbicides; anti-cough drops; anti-tussive expectorants; compounds for treating correlated pulmonary syndromes; compounds for treating respiratory diseases; cough mixtures; cough pastilles for medical use; cough syrups; decongestants; elixirs for relieving colds; expectorants; inhaled pharmaceutical preparations for the treatment of respiratory diseases and disorders; pharmaceutical cough preparations; pharmaceutical preparations for the prevention of diseases of the respiratory system; pharmaceutical preparations for the prevention of disorders of the respiratory system; pharmaceutical preparations for treating allergic rhinitis; pharmaceutical preparations for treating respiratory diseases; pharmaceutical products for treating respiratory diseases; preparations for treating colds.

(260) AM 2018 94006 A

(800) 1362430

(151) 2017 06 01

(891) 2017 06 01

(731) DR. THEISS NATURWAREN GMBH

Michelinstr. 10 66406 Homburg, Germany

(540)

Recupar

(591) Black and white

(511)

3 – Bleaching preparations and laundry detergents; cleaning, polishing, scouring and abrasive preparations; soaps; perfumery, essential oils, cosmetics, including non-medical skin cleaning and care preparations, and hair care preparations; eyelashes (false); lotions for hair; dentifrices.

5 – Pharmaceutical and veterinary preparations; medicines for human or veterinary purposes; sanitary preparations for medical purposes; medicated hair care preparations; medicinal hair growth preparations; dietetic foodstuffs and substances adapted for medical use; nutritional supplements; vitamin preparations, including beauty capsules.

(260) AM 2018 94007 A

(800) 1362446

(151) 2017 04 01

(891) 2017 04 01

(731) CHINA CENTRAL TELEVISION
No.11, Fuxing Road Beijing, China
(540)

cgtn+

(591) Black and white
(531) 24.13.01; 27.05.17
(511)

9 – Electronic publications, downloadable; downloadable image files; downloadable music files; computer software applications, downloadable; computer programs for editing images, sound and video; computer software for processing image, graphics and word; computer software for organizing and viewing digital images and photos; computer software for music composition; compact disc; animated cartoons.

16 – Printed matter; printed publications; posters; books; periodicals; magazines [periodicals]; newsletters; newspapers; picture poster; photographs [printed].

35 – Advertising; television advertising; production of advertising films; publication of publicity texts; advertising design; promotion movie series for others; market investigations based on computer database; consultancy and advisory services for business strategy; business management planning; business management of performing artists; word processing.

36 – Capital investment; lease-purchase financing; investment of funds; rental of real estate; real estate agency services; real estate management; rental of offices [real estate]; apartment house management; rental of apartments; commercial housing sales.

38 – Pay-per-view television programmes broadcasting; television broadcasting; cable television broadcasting; news agency services; internet broadcasting services; message sending; providing online forums; providing access to databases; providing telecommunications connections to a global computer network; providing user access to global computer networks; transmission of digital files.

41 – Production of radio and television programmes; television entertainment; production of shows; news reporters services; writing of texts; photographic reporting; production of music; entertainer services; performance for live comedy programmes; entertainment information; publication of texts, other than publicity texts; publication of books; providing online electronic publications, not downloadable; publish video tape; organization of competitions [education or entertainment]; organization of shows [impresario services]; instruction services.

42 – Conversion of data or documents from physical to electronic media; computer software design; ma-

intenance of computer software; installation of computer software; providing search engines for the internet; information technology [IT] consultancy; design and development of multimedia products; research and development of new products for others; telecommunications technology consultancy; dress designing; construction planning and design for entertainment venue.

(260) AM 2018 94008 A
(800) 1362447
(151) 2017 04 01
(891) 2017 04 01
(731) CHINA CENTRAL TELEVISION
No.11, Fuxing Road Beijing, China
(540)

cgtnplus

(591) Black and white
(531) 27.05.17
(511)

9 – Electronic publications, downloadable; downloadable image files; downloadable music files; computer software applications, downloadable; computer programs for editing images, sound and video; computer software for processing image, graphics and word; computer software for organizing and viewing digital images and photos; computer software for music composition; compact disc; animated cartoons.

16 – Printed matter; printed publications; posters; books; periodicals; magazines [periodicals]; newsletters; newspapers; picture poster; photographs [printed].

35 – Advertising; television advertising; production of advertising films; publication of publicity texts; advertising design; promotion movie series for others; market investigations based on computer database; consultancy and advisory services for business strategy; business management planning; business management of performing artists; word processing.

36 – Capital investment; lease-purchase financing; investment of funds; rental of real estate; real estate agency services; real estate management; rental of offices [real estate]; apartment house management; rental of apartments; commercial housing sales.

38 – Pay-per-view television programmes broadcasting; television broadcasting; cable television broadcasting; news agency services; internet broadcasting services; message sending; providing online forums; providing access to databases; providing telecommunications connections to a global computer network; providing user access to global computer networks; transmission of digital files.

41 – Production of radio and television programmes; television entertainment; production of shows; news reporters services; writing of texts; photographic reporting; production of music; entertainer services; performance for live comedy programmes; entertainment information; publication of texts, other than publicity texts; publication of books; providing on-line electronic publications, not downloadable; publish video tape; organization of competitions [education or entertainment]; organization of shows [impresario services]; instruction services.

42 – Conversion of data or documents from physical to electronic media; computer software design; maintenance of computer software; installation of computer software; providing search engines for the internet; information technology [IT] consultancy; design and development of multimedia products; research and development of new products for others; telecommunications technology consultancy; dress designing; construction planning and design for entertainment venue.

(260) AM 2018 94022 A

(800) 641680

(151) 1995 07 27

(891) 2017 06 28

(731) Henkel AG & Co. KGaA

Henkelstrasse 67, 40589 Düsseldorf, Germany

(540)

BONACROM

(591) Black, white

(511)

3 – Perfumery, essential oils, cosmetics, particularly hair cleaning, care and embellishment preparations, as well as various hair and scalp care and treatment preparations.

(260) AM 2018 94024 A

(800) 926166

(151) 2007 05 09

(891) 2017 08 17

(731) ANTROPOLI Carmine

Via IV Novembre, 11, I-81020 S. ANGELO

IN FORMIS-(CE), Italy

(540)

ANTROLIN

(591) Black, white

(511)

5 – Medicines for the treatment of proctological diseases.

(260) AM 2018 94027 A

(800) 1038476

(151) 2010 02 24

(891) 2017 07 14

(731) Obshchestvo s ogranichennoy

otvetstvennostyu "VITEX-S"

Liter A, korp. 1, d.19, ul. Stakhanovskaya,

g. Kolpino, RU-196653 Saint-Petersburg,

Russian Federation

(540)



(591) Black, white

(531) 03.07.17; 27.05.01

(511)

9 – Breathing apparatus for underwater swimming; swimming jackets; life jackets; goggles for sports; gloves for divers; floats for bathing and swimming; swimming belts; ear plugs for divers.

25 – Smocks; half-boots; breeches(for wear); trousers; football boots; gaiters; vests; sports jerseys; hosiery; combinations (clothing); wet suits for water-skiing; suits; bathing suits; beach clothes; jackets (clothing); tee-shirts; socks; bath slippers; beach shoes; sports shoes; footwear; outerclothing; ready-made clothing; gabardines (clothing); jerseys (clothing); clothing of imitations of leather; clothing of leather; knitwear (clothing); clothing; overcoats; gloves (clothing); bathing trunks; frocks; waterproof clothing; pullovers; shirts; wooden shoes; sandals; boots; sweaters; shoes; bathing caps; pelisses; skirts.

28 – Surf boards; sailboards; flippers for swimming; waterskis; surf skis; masts for sailboards; harness for sailboards; harpoon guns(sports articles); machines for physical exercise; bags especially designed for skis and surfboards.

35 – Demonstration of goods; advertising; sales promotion for others; procurement services for others (purchasing goods and services for other businesses).

(260) AM 2018 94028 A

(800) 1051965

(151) 2010 08 26

(891) 2017 06 21

(731) MEDIABOX BROADCASTING

INTERNATIONAL LTD.

Building 3, Chiswick Park, 566 Chiswick

High Road, London W4 5YA, United

Kingdom

(540)

FASHIONBOX

(591) Black, white

(511)

38 – Broadcasting of radio and television programmes.

(260) AM 2018 94029 A
 (800) 1139213
 (151) 2012 07 03
 (891) 2017 06 09
 (731) QINGDAO FULLRUN TYRE CORP. LTD
 Room B303, Yida Developing Affiliated
 Building, No.60, Beijing Road, Free Trade
 Zone, Qingdao City, Shandong Province,
 China
 (540)

AUTOGRIP

(591) Black, white
 (531) 27.05.02
 (511)
 12 – Rolling stock for railways; automobiles; motor-
 cycles; cycles; funiculars; hand cars; omnibuses; ti-
 res for vehicle wheels; air vehicles; boats.

(260) AM 2018 94030 A
 (800) 1273669
 (151) 2015 10 07
 (891) 2017 06 28
 (731) Henkel AG & Co. KGaA
 Henkelstr. 67, 40589 Düsseldorf, Germany
 (540)

FIBREPLEX

(591) Black, white
 (511)
 3 – Preparations for conditioning, cleaning, tinting,
 dyeing, bleaching, fixing, shaping and waving hair.

(260) AM 2018 94032 A
 (800) 1289809
 (151) 2015 10 12
 (891) 2017 08 17
 (731) BONATOUT INVESTMENT GROUP SA
 Boulevard Grande-Duchesse Charlotte 65,
 L-1331 Luxembourg, Luxembourg
 (540)



SNAUWAERT

(591) Black, white
 (531) 24.17.09; 26.03.23; 26.11.06; 26.11.11;
 27.05.01
 (511)
 18 – Leather and imitations of leather; animal skins;
 trunks and traveling bags; umbrellas, parasols and
 walking sticks; whips and saddlery; backpacks, bags,
 shopping bags with wheels, shoulder bags; key
 cases.

25 – Clothing, footwear, headgear; track suits and
 underwear for sports, sports shoes; t-shirts, t-shirts
 without sleeves, sweatshirts, shorts, caps, berets,
 visors, headbands.

28 – Games and playthings; gymnastic and sporting
 articles.

35 – Advertising; business management; business
 administration; administrative work; dissemination
 of advertising; distribution of advertising material;
 rental of advertising space; assistance and advice in
 the management of commercial and industrial com-
 panies; retail and wholesale services in relation to
 sporting goods, clothing, footwear, headgear, jewe-
 lery, jewellery, watches, perfumes, cosmetics, soaps,
 deodorants, spectacles and sunglasses, spectacle
 frames, spectacle cases, luggage, leather goods,
 belts, articles of paper, stationery, printed matter, ga-
 mes, toys, sporting goods, mobile phones and acces-
 sories.

(260) AM 2018 94033 A
 (800) 1300277
 (151) 2016 02 25
 (891) 2017 08 01
 (731) DAIICHI SANKYO COMPANY, LIMITED
 3-5-1, Nihonbashi Honcho, Chuo-ku, Tokyo
 103-8426, Japan
 (540)

Onquelva

(591) Black, white
 (531) 27.05.17
 (511)
 5 – Pharmaceutical preparations and substances;
 medicines for human purposes.

(260) AM 2018 94036 A
 (800) 1302190
 (151) 2016 04 28
 (891) 2017 06 30
 (731) CASEN RECORDATI, S.L.
 Autovía Logroño, Km. 13,300, E-50180
 UTEBO (Zaragoza), Spain
 (540)

CLEENEMA

(591) Black, white
 (511)
 5 – Pharmaceutical and dietetic preparations adapted
 for medical use.

(260) AM 2018 94037 A
 (800) 1316851
 (151) 2016 02 25

(891) 2017 08 01
 (731) DAIICHI SANKYO COMPANY,
 LIMITED
 3-5-1, Nihonbashi Honcho, Chuo-ku, Tokyo
 103-8426, Japan

(540)
Amlyfend

(591) Black, white
 (531) 27.05.17
 (511)
 5 – Pharmaceutical preparations and substances;
 medicines for human purposes.

(260) AM 2018 94040 A
 (800) 1362487
 (151) 2017 06 23
 (891) 2017 06 23
 (731) DR. THEISS NATURWAREN GMBH
 Michelinstr. 10 66424 Homburg, Germany

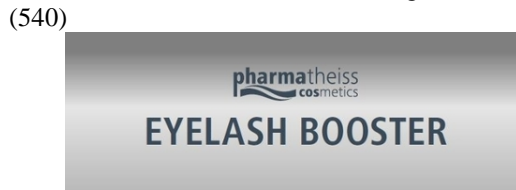

(591) Black and white
 (531) 26.11.13; 27.05.10; 27.05.11; 27.05.17
 (511)
 3 – Bleaching preparations and other substances for
 laundry use; cleaning, polishing, scouring and ab-
 rasive preparations; soaps; perfumery, essential oils,
 cosmetics, including non-medical skin cleaning and
 care preparations, and hair care preparations; eye-
 lashes (false -); hair lotions; dentifrices.

5 – Pharmaceutical and veterinary preparations; me-
 dicines for human or veterinary purposes; sanitary
 preparations for medical purposes; dietetic foods-
 tuffs and substances adapted for medical use; nu-
 tritional supplements; vitamin preparations, inclu-
 ding beauty capsules.

(260) AM 2018 94041 A
 (800) 1362491
 (151) 2017 06 20
 (891) 2017 06 20
 (731) SEAT, S.A.
 Autovia A-2 km.585 E-08760 Martorell
 (Barcelona), Spain

(540)



(591) Black and white
 (531) 07.01.24; 07.05.02; 07.05.08; 07.05.10;
 07.05.25

(511)
 12 – Vehicles; apparatus for locomotion by land;
 cars; vehicle parts and accessories.

(260) AM 2018 94042 A
 (800) 1362520
 (151) 2017 06 13
 (891) 2017 06 13
 (731) YIWU CHAOLAN HARDWARE FIRM
 No. F2-14192 Shop, International Trade
 City, China Commodity City, Yiwu,
 Jinhua Zhejiang, China

(540)



(591) Black and white
 (531) 27.05.11; 27.05.22
 (511)
 9 – Calculating machines; pedometers; facsimile ma-
 chines; scales; measures; measuring instruments;
 protection devices for personal use against accidents.

(260) AM 2018 94043 A
 (800) 1362537
 (151) 2017 06 09
 (891) 2017 06 09
 (731) BEIERSDORF AG
 Unnastrasse 48 20253 Hamburg, Germany

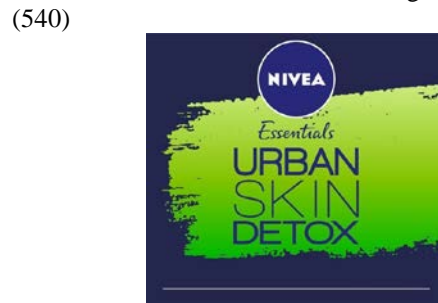

(591) Dark blue, medium blue, various shades of
 green and white
 (531) 26.01.03; 26.01.20; 26.01.24; 26.11.01;
 26.11.05; 26.11.08; 26.13.01; 27.05.01;
 27.05.24; 29.01.13
 (511)
 3 – Cosmetic skin care preparations.

(260) AM 2018 94044 A
 (800) 1362557
 (151) 2017 04 05
 (891) 2017 04 05
 (731) KIKU Srl-GmbH
 Via Lamm, 23/c I-39057 Appiano/Cornaiano
 (BZ), Italy

(540)



(591) Black and white

(531) 24.09.03; 24.09.05; 24.09.07

(511)

31 – Fruit, fresh; apples, fresh; fruit plants; fruit trees; rootstocks for fruit tree grafting; scions for fruit tree grafting.

(260) AM 2018 94045 A

(800) 1362560

(151) 2017 06 09

(891) 2017 06 09

(731) BEIERSDORF AG

Unnastrasse 48 20253 Hamburg, Germany

(540)



(591) White, blue and various shades of green

(531) 26.01.01; 26.01.03; 26.01.20; 26.01.24;
26.13.01; 27.05.10; 27.05.24; 29.01.13

(511)

3 – Cosmetic skin care preparations.

(260) AM 2018 94046 A

(800) 1362600

(151) 2017 06 30

(891) 2017 06 30

(731) RADIONOMY GROUP B.V.

Strawinskylaan 3127, Atrium 8th floor
NL-1077 ZX Amsterdam, Netherlands

(540)

SHOUTCAST

(591) Black and white

(511)

9 – Downloadable computer software for use in transmitting and playing audio streaming transmissions of music via a global computer network.

38 – Audio streaming transmission of music via a global computer network.

(260) AM 2018 94047 A

(800) 1362691

(151) 2016 12 16

(891) 2016 12 16

(731) DIACHUK SERHII IVANOVYCH

vul. Ozerna, 10, s. Ivankovychi, Vasylkivskyi
raion Kyivska obl. 08632, Ukraine

(540)



(591) White, green, light green, grey, light grey,
brown, pink and red

(531) 05.03.16; 05.07.09; 27.05.24; 29.01.15

(511)

3 – Balms other than for medical purposes; plant-based hair tonics; hair balms; hair conditioners; hair cosmetic kits; hair lotions; hair masks; hair tonics; plant-based hair masks; dry shampoos; shampoos; plant-based hair dyes; all above-mentioned goods which are relevant to the term "ecological".

(260) AM 2018 94049 A

(800) 1362702

(151) 2017 04 19

(891) 2017 04 19

(731) ŠKODA AUTO a.s.

tř. Václava Klementa 869 CZ-293 01 Mladá
Boleslav II, Czech Republic

(540)

ANUQ

(591) Black and white

(511)

12 – Automobiles and their parts and accessories, all included in this class.

(260) AM 2018 94050 A

(800) 1362753

(151) 2017 03 10

(891) 2017 03 10

(731) CHINA TOBACCO HUNAN INDUSTRIAL
CO., LTD.

No.188, Section 3, Wanjiali Middle Road,
Changsha Hunan, China

(540)

Marshal

(591) Black and white

(531) 27.05.17

(511)
34 – Tobacco; chewing tobacco; snuff; electronic cigarettes; liquid nicotine solutions for use in electronic cigarettes; humidors; oral vaporizers for smokers; filter tow for cigarettes; flavorings, other than essential oils, for tobacco; flavorings, other than essential oils, for use in electronic cigarettes; cigarettes; cigarette tips; matches; lighters for smokers; butane storage canisters for cigarette lighters; cigarette paper; cigarette filters; shredded tobacco; tobacco pipes; ashtrays for smokers.

(260) AM 2018 94052 A
(800) 1362867
(151) 2017 01 18
(891) 2017 01 18
(731) SOCIETE DES HOTELS
INTERCONTINENTAL FRANCE SAS
5 place de l'Opéra F-75009 Paris, France
(540)



(591) Black and white
(531) 24.09.05; 24.09.24; 25.01.10; 27.05.01
(511)
29 – Meat, fish, poultry and game; meat extracts; preserved, dried and cooked fruits and vegetables; jellies, jams; eggs, milk and milk products; edible oils and fats.

30 – Coffee, tea, cocoa, sugar, rice, tapioca, sago, artificial coffee; flour and preparations made from cereals, bread, pastry, confectionery, ices; honey, treacle; yeast, baking-powder; salt, mustard; vinegar, sauces (condiments); spices; ice; fruit sauces.

31 – Agricultural, horticultural and forestry products and grains; fresh fruits and vegetables.

32 – Beers; mineral water, aerated or still; fruit drinks, fruit juices; syrups and other preparations for making beverages; non-alcoholic beverages.

33 – Alcoholic beverages (except beers).

43 – Providing of food and drink; catering services, hotel services; hotel reservations.

(260) AM 2018 94058 A
(800) 1362887
(151) 2017 06 28
(891) 2017 06 28

(731) OUTRACE Science & Technology PLC.
Industrial Park, Gao'an Jiangxi, China

(540)

OUTRACE

(591) Black, white
(531) 27.05.01; 27.05.17
(511)

11 – Lamps; lamp shades; lampshade holders; electric lamps; street lamps; luminous tubes for lighting; discharge tubes, electric, for lighting; chandeliers.

(260) AM 2018 94060 A
(800) 1362891
(151) 2017 06 14
(891) 2017 06 14
(731) HELL ENERGY Magyarország Kft.
Károlyi krt. 1. 1. em. 2., H-1075 Budapest,
Hungary

(540)

HELL

(591) Black, white
(511)
32 – Energy drinks.

(260) AM 2018 94061 A
(800) 1362901
(151) 2017 07 18
(891) 2017 07 18
(731) Beats Electronics, LLC
8600 Hayden Place, Culver City CA
90232, USA

(540)

URBEATS

(591) Black, white
(531) 27.05.01
(511)
9 – Headphones.

(260) AM 2018 94062 A
(800) 1362960
(151) 2017 06 01
(891) 2017 06 01
(731) AZAD Pharmaceutical Ingredients AG
Durachweg 15, CH-8200 Schaffhausen,
Switzerland

(540)

AZAD

(591) Black, white
(531) 05.03.04; 24.13.13; 27.05.17

(511)
35 – Commercial consultancy and assistance before authorizing authorities.

39 – Transport; packaging and storage of merchandise.

40 – Treatment of materials.

42 – Scientific and technological services as well as research and design services relating thereto; scientific and technological consultancy and assistance before authorizing authorities, industrial analysis and research services; biological research services; chemical analysis; chemical research; chemistry services; quality control; research and development of new products for others.

44 – Medical services; veterinary services; hygienic and beauty care for human beings or animals; pharmacy advice, medical and pharmaceutical consultancy and assistance before authorizing authorities.

45 – Legal services and representation, intellectual property consultancy; intellectual property licensing.

(260) AM 2018 94064 A

(800) 1362964

(151) 2017 06 06

(891) 2017 06 06

(731) Montres Jaquet Droz SA
(Montres Jaquet Droz AG) (Montres Jaquet Droz Ltd)
Allée du Tourbillon 2, CH-2300 La Chaux-de-Fonds, Switzerland

(540)

SOME WATCHES TELL TIME... SOME TELL A STORY

(591) Black, white

(511)

14 – Precious metals and their alloys and goods made of these materials or coated therewith included in this class namely split rings for keys, busts, statues, figurines, trophies, badges, medals, medallions, ornamental pins, hat ornaments, footwear ornaments; jewelry, namely rings, earrings, cuff links, bracelets, charms, brooches, chains, necklaces, tie pins, tie clips, jewelry caskets, jewelry cases; precious stones, semi-precious stones; timepieces and chronometric instruments, namely, chronometers, chronographs, clocks, watches, wristwatches, wall clocks, alarm clocks as well as parts and accessories for the aforesaid products, namely, hands, anchors, pendulums, barrels, watch cases, watch straps, watch dials, clockworks, watch chains, movements for timepieces, rough watch movements, watch springs, watch glasses, presentation cases for timepieces, cases for timepieces.

(260) AM 2018 94065 A

(800) 1363000

(151) 2017 06 16

(891) 2017 06 16

(731) BEIERSDORF AG

Unnastrasse 48, 20253 Hamburg, Germany

(540)



(591) Blue, white and (various shades of) green.

(531) 26.01.03; 26.01.20; 26.01.24; 26.13.01;

27.05.01; 27.05.24; 29.01.13

(511)

3 – Cosmetic preparations for body and beauty care.

(260) AM 2018 94066 A

(800) 1363006

(151) 2017 07 18

(891) 2017 07 18

(731) Janssen Pharmaceutica NV
Turnhoutseweg 30, B-2340 BEERSE,
Belgium

(540)

VALTESKA

(591) Black, white

(511)

5 – Pharmaceutical preparations for human use namely preparations for the central nervous system.

(260) AM 2018 94067 A

(800) 1363049

(151) 2017 04 03

(891) 2017 04 03

(731) "KONTI-RUS" JOINT STOCK COMPANY
ul. Zolotaia, 13, RU-305000 Kursk,
Russian Federation

(540)

Konfirella

(591) Black, white

(531) 27.05.01

(511)

30 – Confectionery.

(260) AM 2018 94069 A
 (800) 1363116
 (151) 2017 07 04
 (891) 2017 07 04
 (731) ZHEJIANG MIAOOU COSMETICS CO.,
 LTD.
 No.48, Donghe North Street, Chengxi
 Industrial Park, Yiwu City, Jinhua City
 Zhejiang Province, China
 (540)



(591) Black, white
 (531) 27.05.11; 27.05.19
 (511)
 3 – Shampoos; perfumery; eyebrow pencils; rouge;
 cosmetic kits; cosmetics; perfumes; toiletries; eye
 shadow; dentifrices.

(260) AM 2018 94070 A
 (800) 1363129
 (151) 2017 04 27
 (891) 2017 04 27
 (731) Schweiz Tourismus
 Tödistrasse 7, CH-8002 Zürich, Switzerland
 (540)



(591) Red (Pantone201C), light red (Pantone 7418C)
 and white
 (531) 01.03.01; 01.03.15; 06.01.04; 24.03.07;
 24.03.11; 24.03.18; 26.01.01; 26.01.04;
 26.01.19; 26.01.21; 28.05; 29.01.13
 (511)
 9 – Image and sound carriers, in particular video
 films; electronic, blank magnetic and optical data
 carriers of all kinds; all the aforesaid goods are of
 Swiss origin; electronic, magnetic and optical data
 carriers of all kinds; downloadable electronic data
 and publications; software; computer games (soft-
 ware); application programs.

16 – Printed matter, in particular instruction manu-
 als, forms, questionnaires, newsletters, books, cata-
 logs, prospectuses, magazines, periodicals, journals
 (publications), loose-leaf pads, paper publications,
 calendars, appointment diaries, adhesive note pads,
 note books, manuals, city maps, lists and pamphlets
 for travelers; printed publications; pencils, ball-point
 pens and other stationery articles; instructional or
 teaching material (except apparatus); all the afore-
 said goods are of Swiss origin.

35 – Tourism advertising; public relations in the
 field of care of the Swiss image abroad; compilation
 and systematization of information into electronic
 databases; advertising, including intermediary servi-
 ces for advertisements, in particular via global/uni-
 versal telecommunication systems; providing adver-
 tising space in printed and online media; publishing
 of advertisements for advertising purposes; e-com-
 merce services, namely negotiation of contracts for
 the acquisition and sale of goods and services; elec-
 tronic commerce services, namely provision of in-
 formation on goods via telecommunication networks
 for advertising or sales purposes; marketing; sales by
 auction, in particular by means of telecommunica-
 tion systems; promotional services, namely organi-
 zation, exploitation and supervision of purchase in-
 centive, loyalty and advertising programs; rental of
 advertising space, also on a website; rental of adver-
 tising time on communication media; collection of
 information in the form of data, images, graphics,
 sound and/or audiovisual material by means of com-
 puters and/or communication networks; all the afo-
 resaid goods of Swiss origin.

39 – Transport; packaging and storage of merchant-
 dise; all the aforesaid services of Swiss origin; pro-
 vision of on-line information in the field of travel;
 provision of cruise ships for travel; provision of
 information for planning and booking airline travel
 via electronic means; provision of information relat-
 ing to travel via a website; provision of travel in-
 formation via the Internet; provision of information
 relating to business travel reservation via the
 Internet; provision of information relating to travel
 and tours by means of online services and call cen-
 ters; provision of information relating to travel and
 transport, via electronic means; provision of infor-
 mation relating to travel and sightseeing tours;
 provision of information relating to the planning and
 booking of travel and transport via electronic means;
 provision of information relating to air travel, via
 electronic means; providing information to travelers
 regarding fares, timetables and public transport; pro-
 vision of automated recordings for air passengers;
 travel arrangements for individuals or groups; travel
 arrangements as part of bonus programs for credit
 card users; arranging of travel by air and sea; orga-
 nization and reservation of travel; booking of seats
 for rail travel; booking of seats for coach travel;

travel reservations; organization of travel for excursions, sightseeing tours, holidays and tours; planning and booking of travel and transport via electronic means; planning and reservation of air travel by electronic means; planning, arranging and booking of travel by electronic means; arranging of holiday travel; transport and travel arrangement; organization of day trips, holidays and sightseeing tours; organization of travel for study, linguistic and training purposes; arranging of travel, excursions and cruises; organization of travel and boat trips; arranging of package holidays; arranging of sightseeing tours as part of package holidays; arranging car hire as part of package holiday; preparing and organizing of visits and sightseeing tours; organization and booking of travel, cruises and sightseeing tours; organization and booking of travel for business or leisure purposes; arranging and booking of travel for package holidays; arranging of air and sea travel for package holidays; online booking of travel and excursions; reservation services and online information in the field of business travel; information services relating to travel and travel services provided online; travel booking services provided by travel agencies; booking of seats for air travel; booking of travel, excursions and cruises; booking of travel through tourist offices; booking of travel through third party agencies; booking of travel through agencies; travel reservation; booking of eco-travel and tours via a website; organization and booking of travel, excursions and cruises; reservation, seat allocation, recording and priority boarding services for frequent fliers; consultancy in the field of travel and sightseeing provided by telephone call centers and an online service; consultancy and booking in the field of travel; consultancy in the field of business travel provided by telephone call centers and an online service; air transport of passengers and goods; transport of travelers.

(260) AM 2018 94073 A

(800) 545778

(151) 1989 10 31

(891) 2017 06 29

(731) PURATOS

Industrialaan 25, B-1702 Groot-Bijgaarden,
Groot-Bijgaarden, B-1702, Belgium

(540)

BELCOLADE

(591) Black, white

(511)

30 – Cocoa and chocolate products, coffee, artificial coffee; cereal and flour preparations, bread, pastry and confectionery, edible ices; powders, mixtures and binding agents for edible ices, honey, treacle; yeast, baking-powder; sauces (except salad dressings); aromatic preparations for food, products for

improving the quality of bakery products for household use.

(260) AM 2018 94074 A

(800) 629493

(151) 1994 11 25

(891) 2017 06 28

(731) Henkel AG & Co. KGaA

Henkelstrasse 67, 40589 Düsseldorf, Guernsey

(540)

IGORA

(591) Black, white

(511)

3 – Cosmetics, particularly preparations for cleaning, treating and improving the appearance of hair as well as various hair and scalp care and treatment preparations.

(260) AM 2018 94081 A

(800) 1364294

(151) 2017 06 14

(891) 2017 06 14

(731) BSH Hausgeräte GmbH

Carl-Wery-Str. 34, 81739 München, Germany

(540)



(591) Black, white

(531) 11.03.18; 26.03.23; 27.05.10

(511)

7 – Electric household and kitchen machines and apparatus, included in this class, in particular electric kitchen machines and apparatus, including grinders, beaters and kneading apparatus, fruit presses, juice extractors, juice centrifuges, mincing machines, cutting apparatus, electrically powered tools, tin openers, knife sharpening apparatus, and machines and apparatus for making beverages and/or preparing food, beverage pumps for dispensing chilled beverages; electric vending machines for beverages or foods, automatic vending machines; electrical apparatus for sealing plastics (packaging); electric waste disposal devices, including waste disposers and waste presses; dishwashers; electric machines and apparatus for treating laundry and clothing (included in this class), including washing machines, spin dryers; ironing presses, ironing machines, included in this class; electric household cleaning equipment, including electric window cleaning equipment, electric shoe polishers and vacuum cleaners, wet and dry vacuuming apparatus; robotic vacuum cleaners, robots for household chores; parts for all the aforesaid goods, included in this class; hoses, tubes, dust filters and dust filter bags, all for vacuum cleaners.

11 – Apparatus for heating, steam generating and cooking, in particular ovens, baking, roasting, gri-

ling, toasting, defrosting and heating devices, water heaters, immersion heaters, slow-cookers, microwave ovens, waffle irons (electric), egg cookers, deep-fat fryers (electric); electric tea and coffee machines, espresso coffee machines, automatic coffee machines (included in this class); refrigerating apparatus, in particular refrigerators, chest freezers, refrigerated cabinets, beverage-cooling apparatus, fridge-freezers, freezers, ice machines and apparatus; drying apparatus, in particular including tumble dryers, laundry drying machines, hand dryers, hair dryers; infrared lamps (other than for medical use); heated cushions, not for medical purposes; blankets, electric, not for medical purposes; apparatus for ventilating, in particular fans; extractor hood filters, extractor hood equipment and extractor hoods, air conditioning apparatus and devices for improving air quality, air humidifiers, air deodorisers, fragrance dispensing apparatus (not for personal use); air purifying apparatus, apparatus for water supply and sanitary purposes, in particular including fittings for steam generating, ventilating and water supply installations; water heaters, storage water heaters and instantaneous water heaters; kitchen sinks; heat pumps; parts for all the aforesaid goods, included in this class; mechanical taps (dispensers) for dispensing chilled beverages for use in combination with apparatus for chilling beverages (other than vending machines).

(260) AM 2018 94083 A
 (800) 1364342
 (151) 2017 07 18
 (891) 2017 07 18
 (731) JANSSEN PHARMACEUTICA NV
 Turnhoutseweg 30, B-2340 BEERSE,
 Belgium
 (540)

RETRESKA

(591) Black, white
 (511)
 5 – Pharmaceutical preparations for human use namely preparations for the central nervous system.

(260) AM 2018 94084 A
 (800) 1364348
 (151) 2016 03 11
 (891) 2016 03 11
 (731) CIMTAS CELIK IMALAT MONTAJ VE
 TESISAT ANONIM SIRKETI
 Balmumcu Mah. Enka Binası 2, Kat: 111
 Beşiktaş, Istanbul, Turkey
 (540)

cimtas

(591) Blue
 (531) 27.05.17; 29.01.04
 (511)
 6 – Common metals and their alloys; metal building materials; transportable buildings of metal; materials of metal for railway tracks; non-electric cables and wires of common metal; ironmongery, small items of metal hardware; pipes and tubes of metal; safes; ores; unwrought and semi-wrought common metals; goods of common metal included in this class.

37 – Building construction; repair; installation services; services relating to the construction of buildings, roads, bridges, dams or transmission lines and services of undertakings specializing in the field of construction such as those of painters, plumbers, heating installers or roofers; construction services, including consultancy and information services relating to construction; shipbuilding; rental of tools for use in building construction; services consisting of hiring of tools or building materials; repair services, i.e., services which undertake to put any object into good condition after wear, damage, deterioration or partial destruction (restoration of an existing building or another object that has become imperfect and is to be restored to its original condition); repair services; services of maintenance for preserving an object in its original condition without changing any of its properties.

42 – Scientific and technological services and research and design relating thereto; industrial analysis and research services; design and development of computer hardware and software; the services of engineers and scientists who undertake evaluations, estimates, research and reports in the scientific and technological fields (including technological consultancy) (terms considered too vague by International Bureau – rule 13(2)(b) of the Common Regulations).

(260) AM 2018 94085 A
 (800) 1364385
 (151) 2016 09 28
 (891) 2016 09 28
 (731) Limited Liability Company "MISTRAL
 TRADING"
 str. Pudovkina, 4, RU-119285 Moscow,
 Russian Federation
 (540)

Мистраль

(591) Blue, white
 (531) 26.11.02; 26.11.06; 26.11.12; 27.05.11;
 29.01.04

(511)

29 – Butter cream; white of eggs; isinglass for food; pectin for culinary purposes; whipped cream; milk products; edible birds' nests; gelatin; milk; almonds, ground; fish meal for human consumption; nuts, prepared; tofu; rennet; soya milk [milk substitute]; peanuts, prepared; coconut, desiccated; eggs; powdered eggs; seaweed extracts for food; pollen prepared as foodstuff; yolk of eggs; albumen for culinary purposes; silkworm chrysalis, for human consumption; alginates for culinary purposes.

30 – Malt for human consumption; oat flakes; chicory [coffee substitute]; frozen yoghurt [confectionery ices]; starch for food; cereal preparations; capers; ice for refreshment; cereal-based snack food; corn flour; oatmeal; oat-based food; sugar; malt extract for food; powders for making ice cream; groats for human food; coffee; vanilla flavourings for culinary purposes; infusions, not medicinal; husked oats; iced tea; flour; corn flakes; potato flour; cocoa; couscous [semolina]; maltose; mustard; propolis; tapioca flour; coffee flavourings; pasta; spaghetti; chips [cereal products]; glucose for culinary purposes; aromatic preparations for food; tea; crushed oats; molasses for food; ice, natural or artificial; barley meal; star aniseed; ice cream; rice; baking soda [bicarbonate of soda for cooking purposes]; condiments; hominy grits; vegetal preparations for use as coffee substitutes; vanillin [vanilla substitute]; coffee-based beverages; salt for preserving foodstuffs; turmeric; essences for foodstuffs, except etheric essences and essential oils; noodles; royal jelly; binding agents for ice cream [edible ices]; natural sweeteners; hominy; vermicelli [noodles]; wheat flour; pepper; cocoa beverages with milk; sea water for cooking; noodle-based prepared meals; thickening agents for cooking foodstuffs; unroasted coffee; garden herbs, preserved [seasonings]; quiches; yeast; rice-based snack food; seasonings; soya flour; aniseed; corn, milled; macaroni; meat tenderizers, for household purposes; honey; preparations for stiffening whipped cream; spices; gluten prepared as foodstuff; coffee beverages with milk; celery salt; crushed barley; edible ices; bean meal; vinegar; sausage binding materials; nutmegs; cooking salt; cocoa-based beverages; semolina; husked barley; muesli; artificial coffee; food flavorings, other than essential oils; gruel, with a milk base, for food.

31 – Sanded paper for pets [litter]; beverages for pets; aloe vera plants; roots for food; litter peat; groats for poultry; rice, unprocessed; linseed meal for animal consumption; maize; flower bulbs; mushrooms, fresh; hay; cereal seeds, unprocessed; fish, live; fruit, fresh; malt for brewing and distilling; bred stock; coconut shell; dog biscuits; mash for fattening livestock; grains [cereals]; salt for cattle; Christmas trees; bran mash for animal consumption; barley; animal foodstuffs; plants, dried, for decoration; flo-

wers, dried, for decoration; trees; hop cones; olives, fresh; garden herbs, fresh; mushroom spawn for propagation; rye; grains for animal consumption; nuts [fruits]; edible chews for animals; eggs for hatching, fertilised; meal for animals; oil cake; silkworms; fruit residue [marc]; residual products of cereals for animal consumption; residue in a still after distillation; grains [seeds]; spinach, fresh; poultry, live; flax meal [fodder]; linseed for animal consumption; almonds [fruits]; crayfish, live; algarovilla for animal consumption; hazelnuts, fresh; fish meal for animal consumption; rose bushes; bagasses of cane [raw material]; wood chips for the manufacture of wood pulp; bushes; forage; stall food for animals; truffles, fresh; seedlings; straw [forage]; hops; aromatic sand for pets [litter]; bird food; chicory roots; peanut meal for animals; wheat; wreaths of natural flowers; spiny lobsters, live; bran; silkworm eggs; plants; yeast for animal consumption; citrus fruit, fresh; edible sesame, unprocessed; pine cones; straw litter; peas, fresh; kola nuts; cucumbers, fresh; straw mulch; draff; pollen [raw material]; wheat germ for animal consumption; mussels, live; pet food; sugarcane; undressed timber; squashes, fresh; copra; chicory, fresh; lemons, fresh; chestnuts, fresh; lentils, fresh; vegetables, fresh; peanuts, fresh; beet, fresh; rough cork; turf, natural; fishing bait, live; cocoa beans, raw; live animals; oats; coconuts; beans, fresh; leeks, fresh; lettuce, fresh; litter for animals; juniper berries; seed germ for botanical purposes; fish spawn; peppers [plants]; crustaceans, live; seaweed for human or animal consumption; rhubarb, fresh; flowers, natural; peanut cake for animals; oranges, fresh; raw barks; sea-cucumbers, live; shellfish, live; grapes, fresh; oysters, live; palm trees; distillery waste for animal consumption; berries, fresh.

32 – Peanut milk [non-alcoholic beverage]; aloe vera drinks, non-alcoholic; syrups for lemonade; preparations for making liqueurs; seltzer water; non-alcoholic beverages; tomato juice [beverage]; non-alcoholic fruit extracts; extracts of hops for making beer; milk of almonds [beverage]; malt beer; beer; cocktails, non-alcoholic; aerated water; ginger ale; malt wort; sarsaparilla [non-alcoholic beverage]; smoothies; syrups for beverages; vegetable juices [beverages]; must; isotonic beverages; preparations for making beverages; grape must, unfermented; non-alcoholic fruit juice beverages; table waters; aperitifs, non-alcoholic; cider, non-alcoholic; fruit nectars, non-alcoholic; lithia water; kvass [non-alcoholic beverage]; beer wort; whey beverages; essences for making beverages; soda water; preparations for making mineral water; mineral water [beverages]; fruit juice; sorbets [beverages]; waters [beverages]; lemonades; non-alcoholic honey-based beverages.

- (260) AM 2018 94086 A
 (800) 1364467
 (151) 2017 02 14
 (891) 2017 02 14
 (731) Interchemie Werken "DE ADELAAR" B.V.
 Metaalweg 8, NL-5804 CG Venray,
 Netherlands
 (540)



- (591) Purple (Pantone Violet C), green
 (Pantone 376 C) and white
 (531) 03.07.01; 03.07.16; 25.05.03; 26.04.01;
 26.04.05; 26.04.12; 26.04.22; 29.01.13
 (511)
 5 – Veterinary medicines; medicated additives for
 animal feed; supplements for animals, amongst
 which mineral food supplements; vitamins and vita-
 min preparations for animals; proteins supplements
 for animals; amino acid, amino acid preparations,
 acids and/or acidifiers for veterinary purposes; en-
 zymes and enzyme preparations for veterinary pur-
 poses; disinfectants; herbal additives for animal fo-
 odstuffs.

- (260) AM 2018 94089 A
 (800) 1364566
 (151) 2017 06 19
 (891) 2017 06 19
 (731) BGLab s.r.o.
 Kaprova 42/14, CZ-11000 Praha 1,
 Czech Republic

(540)
gammon : space

- (591) Black, red
 (531) 26.01.06; 29.01.12
 (511)
 9 – Games software; software programs for video
 games; games software; downloadable software;
 application software for mobile phones; computer
 software for mobile phones; computer software
 downloadable from the internet; computer game
 software downloadable from a global computer
 network.
 41 – Entertainment; arranging, organising and provi-
 sion of gaming, amusement and entertainment ser-
 vices; arranging, organising and conducting of en-
 tertainment in the form of online competitions; or-
 ganization of competitions; provision of interactive
 games, interactive entertainment and/or interactive

competitions; providing online computer games via
 global communications networks; provision of the
 aforesaid services in electronic or computerised
 form; provision of the aforesaid services on-line
 from a computer database or the internet; provision
 of information relating to gaming services accessible
 via a global computer network; providing informa-
 tion online from a computer database or from the
 internet relating to entertainment; providing elec-
 tronic games online via a computer database or the
 internet; providing interactive computer games for
 multiple players via the internet and electronic
 communications networks.

42 – Creating and maintaining websites; hosting web
 sites for others; updating and maintenance of com-
 puter software and programs; design and develop-
 ment of computer game software; computer prog-
 ramming of video and computer games; application
 service provider [ASP], namely, hosting computer
 software applications of others; rental of software;
 hosting services and software as a service and rental
 of software.

- (260) AM 2018 94091 A
 (800) 1364567
 (151) 2017 04 26
 (891) 2017 04 26
 (731) Zakrytoe aktsionernoe obschestvo
 "ALEXANDRA PLUS"
 Verejskaya street, 29, stroenie 154, pomes-
 henie 45, RU-121351 Moscow, Russian
 Federation
 (540)



- (591) dark-brown. White for background, white for
 the word, orange, red, dark red, black, white
 for word, yellow and light yellow for the ear
 of grain and background, brown, dark-brown,
 red, dark-red, green, dark-green, black, grey,
 dark-grey for graphics
 (531) 03.05.05; 03.05.25; 05.07.02; 08.03.01;
 08.03.25; 11.03.07; 28.05; 29.01.15
 (511)
 29 – Alginates for culinary purposes; anchovy;
 broth; jams; fatty substances for the manufacture of

edible fats; mushrooms, preserved; game, not live; gelatin; meat jellies; fruit jellies; edible fats; fruit-based snack food; sausages; raisins; caviar; sauerkraut; vegetables, tinned [canned (Am.)]; fruits, tinned [canned (Am.)]; broth concentrates; gherkins; shrimps, not live; butter cream; croquettes; margarine; marmalade; vegetable oils for food; butter; cocoa butter for food; animal marrow for food; mussels, not live; milk; soya milk [milk substitute]; seafood, not live; fruit pulp; meat; meat, tinned [canned (Am.)]; potato fritters; olives, preserved; nuts, prepared; tomato paste; liver pate; liver; pickles; powdered eggs; milk products; fish-based foodstuffs; prostokvasha [soured milk]; poultry, not live; mashed potatoes; fruit puree; berry puree; crustaceans, not live; fish, not live; fish, tinned [canned (Am.)]; fruit salads; suet for food; whipped cream; fat-containing mixtures for bread slices; corned beef; sausages in batter; preparations for making broths; preparations for making soup; tripe; soups; cheese; tahini [sesame seed paste]; tofu; truffles, preserved; oysters, not live; fish fillets; dates; crystallized fruits; frozen fruits; fruit, stewed; potato flakes; fruit peel; potato chips; fruit chips; seaweed extracts for food; meat extracts; eggs.

30 – Food flavorings, other than essential oils; sponge cakes; pancakes; vanillin [vanilla substitute]; vanilla flavoring for culinary purposes; waffles; vermicelli [noodles]; coffee flavorings; natural sweeteners; sea water for cooking; glucose for culinary purposes; mustard; yeast; thickening agents for cooking foodstuffs; rice-based snack food; coffee substitutes; confectionery; cookies; pasta; small pies; frozen yogurt [confectionery ices]; cocoa; cocoa products; caramels [candy]; gruel, with a milk base, for food; liquorice [confectionery]; coffee; starch for food; crackers; cereal-based snack food; corn, milled; corn, roasted; meat pies; noodles; edible ices; marzipan; custard; honey; ice cream; flour; muesli; cocoa beverages with milk; coffee beverages with milk; coffee-based beverages; tea-based beverages; chocolate beverages with milk; chocolate-based beverages; infusions, not medicinal; nutmeg; pepper; biscuits; cakes; pizzas; popcorn; powders for making ice cream; pralines; cereal preparations; propolis; gingerbread; spices; puddings; sugar confectionery; ravioli; chewing gum; rice; sugar; pastries; sweetmeats [candy]; baking soda [bicarbonate of soda for cooking purposes]; malt for human consumption; salt for preserving foodstuffs; cooking salt; celery salt; spaghetti; seasonings; breadcrumbs; sushi; sandwiches; tapioca; dough; tortillas; fruit and berry cakes; garden herbs, preserved [seasonings]; vinegar; ferments for pastes; halvah; bread; chips [cereal products]; chicory [coffee substitute]; tea; chocolate; malt extract for food; essences for foodstuffs, except etheric essences and essential oils.

(260) AM 2018 94094 A

(800) 1364272

(151) 2017 02 17

(891) 2017 02 17

(731) ORIFLAME COSMETICS AG

c/o Oriflame Global Management AG,
Bleicheplatz 3, CH-8200 Schaffhausen,
Switzerland

(540)

ORIFLAME ECLAT

(591) Black, white

(511)

3 – Non-medicated preparations for the application to, conditioning and care of hair, scalp, skin and nails; soaps; perfumes; perfumery; eau de cologne; toilet waters; essential and herbal oils; cosmetics; make-up preparations; lipsticks; nail varnishes; nail varnish removers; non-medicated toilet preparations; hair lotions; hair sprays and hair gels; preparations for use in the bath or shower; bath and shower oils, gels, creams and foams; face and body masks; face and body scrubs; facial washes; skin cleansers and hydrators; skin toners; skin moisturizers; blemish creams and blemish gels; deodorants; antiperspirants; preparations for use before shaving and after shaving; shaving soaps; shaving creams; shaving gels; after-shave preparations; pre-shave preparations; talcum powders; toiletries; dentifrices; toothpastes.

(260) AM 2018 94095 A

(800) 1364647

(151) 2017 07 03

(891) 2017 07 03

(731) SHENZHEN WINNER BROS IMPORT & EXPORT CO., LTD

Rm 813A, #8 Floor, Moi Commercial
Building, Busha Rd, Buji Longgang District,
Shenzhen city, 518000 Guangdong, China

(540)

(591) Black, white

(531) 27.05.17

(511)

9 – Smart cards [integrated circuit cards]; cables, electric; lasers, not for medical purposes; lightning conductors; connections for electric lines; couplings, electric; telescopes; sunglasses; battery chargers; batteries, electric.

11 – Searchlights; lights for vehicles; lighting apparatus and installations; lighting apparatus for vehicles; pocket searchlights; light-emitting diodes [LED] lighting apparatus; light bulbs; lava rocks for use in barbecue grills; heating apparatus, electric; lighters.

(260) AM 2018 94117 A
 (800) 1363794
 (151) 2017 06 19
 (891) 2017 06 19
 (731) ADAM OPEL GMBH
 Bahnhofplatz, 65423 Rüsselsheim, Germany
 (540)

CAYU

(591) Black, white
 (511)
 35 – Retail services relating to the sale of motor vehicles, parts and spare parts therefore, that are provided online and via retail stores and other premises; information and advisory services relating to the purchase and quality of motor vehicles that are provided online as well as in retail stores and at other premises; advertising and sales promotion relating to the sale, rental and leasing of motor vehicles; online services, namely providing online consulting for the purchase and sale of motor vehicles; provision of information online from a computer database or from the Internet relating to the purchase of motor vehicles.

38 – Providing access to platforms and portals on the Internet, telecommunication services provided via Internet platforms and portals; services for transferring data and information to computers (including portable notebooks) and mobile devices (including telephones and tablets); electronic transmission of data via a global communication network; providing access to Interactive databases; providing access to customer login portals (in particular for retrieving tracking information on the progress of the purchase of automobiles as well as information on scheduled after-sales services according to maintenance plan); communications by computer terminals; transmission of electronic mail to computers (including portable notebooks) and mobile devices (including telephones and tablets).

39 – Car rental; consultancy and information services relating to car rental; transport and transportation of motor vehicles.

(260) AM 2018 94118 A
 (800) 1326638
 (151) 2016 04 18
 (891) 2017 06 29
 (731) FRITZ EGGER GMBH & CO. OG
 Weiberndorf 20, A-6380 St. Johann in Tirol,
 Austria
 (540)

FEELWOOD

(591) Black, white
 (511)
 17 – Laminates for the decorative coating of wooden composite boards for use in furniture making and interior work; compact laminates.

19 – Chipboard and fibreboard as well as goods made thereof, not included in other classes; floor boards and panels (laminated and unlaminated) made of condensed chipboards and fibreboards.

20 – Furniture and furniture parts, in particular work tops, furniture facing elements, edge elements, of fibreboard or chipboard; laminated boards and plastic laminates as furniture parts for furniture construction.

(260) AM 2018 94119 A
 (800) 1331815
 (151) 2016 11 01
 (891) 2017 07 20
 (731) PARNASSIA GROEP B.V.
 Monsterseweg 93, NL-2553 RJ 's-Gravenhage,
 Netherlands
 (540)



(591) Blue (RGB 92-120-148), white
 (531) 26.04.03; 26.04.04; 26.04.24; 27.05.24;
 29.01.12

(511)
 41 – Upbringing, education, training and courses, including in the field of healthcare; schooling and retraining in the field of healthcare, as well as in the medical and psychological field; training and courses in the medical and psychological field and concerning healthcare, including regarding addictions and treatment options; issuing publications, in printed or electronic form; information, advice and consultancy in the aforementioned fields, whether or not by electronic and telecommunications channels, including the internet.

42 – Scientific and technological services and research relating thereto; services of scientific laboratories.

44 – Medical services; services in the field of mental health care, also regarding social issues; services rendered by psychiatrists, psychologists, therapists, medical practitioners, paramedics and nurses; services in the field of healthcare; services of general hospitals, psychiatric hospitals, nursing homes, medical homes for the elderly, sanatoriums, rest homes, convalescent homes and medical and psychiatric shelters; psychological and medical treatment, care and counseling; medical services to prevent addic-

tion; treatments in the field of healthcare, including nursing, therapy, care and counseling for addicts, patients with behavioral disorders and psychiatric patients; forensic psychiatric care and forensic medical care for the benefit of persons in custody under a hospital order; services rendered by medical specialists, including psychologists and psychiatrists to treat, care and counsel addicts, patients with behavioral disorders and psychiatric patients; information, advice and consultancy with regard to aforesaid services, whether or not by electronic and telecommunication channels, including internet.

45 – Legal services; legal advice, including legal advice in the medical and psychological field, as well as on legislation in the field of healthcare and treatment methods; information, advice and consultancy with regard to aforesaid services, whether or not by electronic and telecommunication means, including internet.

(260) AM 2018 94120 A
 (800) 1362946
 (151) 2017 05 15
 (891) 2017 08 24
 (731) Société des Produits Nestlé S.A.
 CH-1800 Vevey, Switzerland
 (540)



(591) Black, white
 (531) 02.05.01; 02.05.02; 02.05.03; 02.05.06;
 26.01.14

(511)
 5 – Dietetic foodstuffs, beverages and substances for medical and clinical use; food and food substances for babies; food preparations for infants; lacteal flour for babies; powdered milk for babies; foodstuffs and food substances for medical use for children and patients; foodstuffs and food substances for medical use for nursing mothers; nutritional supplements for medical use for pregnant women and breastfeeding mothers; nutritional supplements; dietetic supplements for medical use; nutritional and dietetic supplements for medical use; vitamin preparations, mineral-based preparations; dietary fibers; vitamins; vitamin preparations and substances; nutritional and food supplements.

29 – Cooked dishes based on vegetables, potatoes, fruits, meat, poultry, fish and seafood products; preserved, frozen, dried and cooked fruits and vegetables; milk and dairy products; powdered milk; milk-based beverages and preparations; milk substitutes; milk beverages, milk predominating; milk-based beverages containing cereals and/or chocolate; yogurts; soy milk.

30 – Malt-based preparations for human consumption; cocoa and cocoa-based beverages and preparations; chocolate, chocolate products, chocolate-based beverages and preparations; cereal-based beverages and preparations included in this class; cereals, breakfast cereals; cereal bars; ready-to-eat cereals; cereal preparations; cereal-based snacks; food products based on rice, flour, oat meal or cereals, also in the form of cooked dishes.

32 – Still waters, sparkling or aerated waters, treated waters, spring waters, mineral and table waters, flavored waters; fruit-flavored beverages and beverages based on fruit, fruit juices, fruit concentrates and vegetable juices; nectars, fruit nectars (beverages), lemonades, soda water and other non-alcoholic beverages; syrups, extracts and essences and other preparations for making non-alcoholic beverages (excluding essential oils); water-based beverages with tea extracts; beverages based on milk ferments; soy-based beverages; malt-based beverages; isotonic beverages.

(260) AM 2018 94122 A
 (800) 1363840
 (151) 2017 04 07
 (891) 2017 04 07
 (731) PAPA JOHN'S INTERNATIONAL, INC.
 2002 Papa John's Boulevard, Louisville KY
 40299, USA

(540)

**PIZZA PAPA JOHN'S BETTER
 INGREDIENTS. BETTER PIZZA.**

(591) Black, white
 (531) 27.05.01; 27.05.15

(511)
 30 – Pizza; pizza cheese sticks; bread rolls, pizza rolls; pepperoni rolls; breadsticks; cookies; brownies; baked desserts; sauces; spicy sauces; seasonings.

39 – Pizza delivery services; delivery of food and drinks by restaurants.

43 – Restaurant services; restaurant services featuring in-restaurant dining and carryout and delivery services; take-out restaurant services.

(260) AM 2018 94123 A
 (800) 1363860
 (151) 2017 06 14

(891) 2017 06 14
 (731) Turner Broadcasting System, Inc.
 One CNN Center, Atlanta GA 30303, USA
 (540)

THE DRESS UP GANG

(591) Black, white
 (511)
 9 – Audio visual recordings featuring entertainment in the nature of an on-going television series in the field of comedy, action, drama, reality and adventure; downloadable video files, namely television programming featuring comedy, action, drama, reality and adventure distributed via the internet and wireless communications.
 41 – Entertainment services, namely, a multimedia program series featuring comedy, action, drama, reality and adventure distributed via various platforms across multiple forms of transmission media.

(260) AM 2018 94126 A
 (800) 1364052
 (151) 2016 12 27
 (891) 2016 12 27
 (731) BURLAKA SERHII
 vul. Yurkivska, 34A, of. 2, Kyiv 04080,
 Ukraine
 (540)

eurabota

(591) Black, white
 (531) 27.05.17
 (511)
 35 – Advertising; business management; business administration; office functions.

(260) AM 2018 94128 A
 (800) 1364072
 (151) 2017 03 17
 (891) 2017 03 17
 (731) WORLD MEDICINE İLAÇ SANAYİ VE
 TİCARET ANONİM ŞİRKETİ
 Evren Mah. Camiyolu Cad. No.50 Kat 1 B,
 Zemin 4-5-6 Güneşli/Bağcılar İstanbul,
 Turkey
 (540)

RUPADA РУПАДА

(591) Black, white
 (531) 27.05.05; 28.05

(511)
 5 – Medicines for human purposes, medicines for veterinary purposes, vitamin preparations, chemical preparations for medical purposes, dietetic substances adapted for medical use, dietetic foods adapted for medical purposes, baby foods, medicinal herbs, herbal beverages adapted for medical purposes, nutritional supplements, pollen dietary supplements, mineral food supplements, protein dietary supplements, dietary supplements for animals, fodder supplements for veterinary purposes, medicines for dental purposes, hygienic products for medical purposes including sanitary pads, breast-nursing pads and bunion pads, wadding for medical purposes, plasters for medical purposes, dressings for medical purposes, babies' napkins, preparations for destroying noxious plants, preparations for destroying noxious animals, fungicides, deodorants other than for human beings or for animals, air deodorising preparations, disinfectants for hygiene purposes, antiseptics, detergents for medical purposes.

(260) AM 2018 94220 A
 (800) 1365138
 (151) 2017 06 30
 (891) 2017 06 30
 (731) CELGENE CORPORATION
 86 Morris Avenue, Summit NJ 07901,
 USA
 (540)

PANTRITIONKITCHEN

(591) Black, white
 (511)
 43 – Providing information to patients about recipes, ingredients and cooking information for pancreatic cancer patients via an online computer database.
 44 – Providing online medical information in the field of pancreatic cancer; providing medical information, consultancy and advisory services; medical screening information services in the field of pancreatic cancer; providing medical information on tips for managing nutrition with pancreatic cancer; health counseling, namely providing information on tips for managing nutrition with pancreatic cancer.

(260) AM 2018 94221 A
 (800) 1365140
 (151) 2017 05 24
 (891) 2017 05 24
 (731) ORGANİKA KİMYA KOZMETİK VE
 AMBALAJ SANAYİ TİCARET LİMİTE
 D ŞİRKETİ
 Ortaköy Mah. Tibet Sokak, No:6/A Selimpaşa
 Silivri İstanbul, Turkey

(540)



(591) Black, white

(531) 26.04.01; 26.04.05; 26.04.22; 27.05.01;
27.05.19

(511)

3 – Perfumes; eau de cologne, colognes, lotions for cosmetic purposes, essential oils, deodorants for personal use, rose water, after-shave lotions, antiperspirant deodorants and lotions, cosmetics namely, nail polishes, lipsticks, mascaras, creams for cosmetic, hair care cream, hair dyes, hair gel, body gel, hair spray, petroleum jelly for cosmetic purposes, hair wax, shampoos, hair waving preparations; eyebrow pencils (eyeliner), lip-liners, eye shadows, rouges, skin care creams, moisturizing cream and lotions liquid make-up, powder for make-up; nail varnish remover; nail care products, nail hardening and nourishing preparations, shaving preparations, shaving soaps, after-shave soaps, after-shave creams, shower gel, depilatory' preparations for cosmetic purposes, hennas; cosmetic preparations for slimming purposes; auto bronzers, cosmetic and disinfectant soaps, soaps namely, soaps for personal use, tooth care preparations namely toothpastes, dentifrices; mouth-washes, not for medical purposes.

(260) AM 2018 94223 A

(800) 1365174

(151) 2017 07 21

(891) 2017 07 21

(731) APPLE INC.

1 Infinite Loop, Cupertino CA 95014,
USA

(540)



(591) white, blue, purple, and pink

(531) 24.17.12; 26.15.11; 29.01.14

(511)

9 – Computer software used in developing other software applications; application development software.

(260) AM 2018 94225 A

(800) 1365181

(151) 2017 05 24

(891) 2017 05 24

(731) COTECNICA, S.C.C.L.

Ctra. Nacional II, Km. 494,50, E-25250
Bellpuig (Lleida), Spain

(540)

COTECNICA

(591) Black, white

(511)

31 – Foodstuffs and fodder for animals.

(260) AM 2018 94227 A

(800) 1365182

(151) 2017 05 22

(891) 2017 05 22

(731) COTECNICA, S.C.C.L.

Ctra. Nacional II, Km. 494,50 E-25250
Bellpuig (Lleida), Spain

(540)

COTAGRO

(591) Black, white

(511)

31 – Foodstuffs and fodder for animals.

(260) AM 2018 94229 A

(800) 1365223

(151) 2016 12 16

(891) 2016 12 16

(731) PRIVA HOLDING B.V.

Zijlweg 3, NL-2678 LC De Lier, Netherlands

(540)



(591) Black, white

(531) 26.04.02; 26.04.07; 27.05.17; 27.05.24;
29.01.12

(511)

7 – Machines not included in other classes and machine tools; agricultural instruments, other than hand-operated; mixers (machines), including fertilizer mixing and dosing installations; production machines; robots [machines] for the treatment and processing of crops in agriculture and horticulture; robotized agricultural and horticultural machines, leaf cutting machines, machines for clipping and trelli-

sing crops, cultivating machines, harvesters and fruit picking machines for use in agriculture and horticulture; parts of the machines and machine tools listed in this class.

9 – Scientific and electric apparatus and instruments (not included in other classes); optical and electronic detectors; measuring, regulating, monitoring (supervision) apparatus and instruments; computers and computer peripherals; recorded computer programs, more specifically for technical, administrative and management applications; measuring, dosing, signaling, monitoring (supervision), emergency (life-saving) and teaching instruments, apparatus and systems; data recording and storage devices; downloadable and online publications; calculating machines and data processing equipment; software; data processing systems; parts of the apparatus and instruments listed in this class.

11 – Lighting, heating, steam-generating, cooking, refrigerating, drying, ventilating and water distribution apparatus; apparatus and installations for disinfecting water, including irrigation, drainage and pond water; humidification, dehumidification and air-conditioning apparatus and installations; parts of the apparatus and installations listed in this class.

(260) AM 2018 94230 A

(800) 1364672

(151) 2017 04 02

(891) 2017 04 02

(731) NILIT LTD.

Maurizio Levy Road Migdal Ha'emek,
Israel

(540)

SENSIL

(591) Black and white

(511)

22 – Ropes, string; fabric, polyamide and polyester mesh net used for storing toys and other household items, fishing nets; tents; awnings; tarpaulins, sails, sacks and bags for the transportation or storage of materials in bulk; padding and stuffing materials not of rubber, paper or plastic, raw fibrous textile materials.

23 – Yarns and threads for textile use.

24 – Textiles and textile goods, namely, fabrics for textile use; fiberglass fabric for textile use; textile fabrics for use in the manufacture of garments, bags, jackets, gloves, and apparel; textile used as lining for clothing.

25 – Wearable garments and clothing, namely, shirts, pants, skirts, dresses; ladies' underwear; bras; men's underwear; children's underwear, and hosiery.

(260) AM 2018 94232 A

(800) 1365227

(151) 2016 12 14

(891) 2016 12 14

(731) SWAGELOK COMPANY

29500 Solon Road, Solon OH 44139, USA

(540)



(591) Black, white

(531) 27.05.01

(511)

1 – Chemical compound for detecting leaks in gas and fluid lines; chemical compound which will not freeze at low temperatures for detecting leaks in gas and fluid lines.

4 – Lubricant oil for glass seals and for titanium, stainless steel, steel, and alloy fitting threads, o-rings and gaskets.

6 – Manually operated metal valves for tubes, pipes and hoses; metal valves not being parts of machines; metal glands, ferrules and nuts for tubes, pipes and hoses; metal straight, elbow, tee and cross fittings for tubes, pipes and hoses; metal vacuum fittings for tubes, pipes and hoses; metal couplings for tubes, pipes and hoses; metal reducer fittings for tubes, pipes and hoses; metal adapter fittings for tubes, pipes and hoses; metal port connector fittings for tubes, pipes and hoses; metal quick disconnect fittings for tube, pipe and hose end connections; metal tubing; flexible metal tubing and hose; metal convoluted tubing; metal pipes used for gas distribution; metal seals for tubes, pipes and hoses; metal clamps for tubes, pipes and hoses; metal caps for tubes, pipes and hoses; metal plugs for tubes, pipes and hoses; metal compressed gas cylinders sold empty for use with hydraulic and pneumatic systems; metal cylinders for fluids sold empty; metal thermowells; metal manifolds for use with hydraulic and pneumatic systems.

7 – Electrically-powered machines and electrically-powered tools for cutting, bending, deburring, and swaging tube and hose; electric tube bender machine; electric arc welding machines for use with welding cooling plates, tube and hose; electric tube bender machine; electric arc welding machines for use with welding cooling plates, weld head bench mounting brackets attached to work benches, weld held fixture tool, welding collets for tubes, pipes and fittings; valves as machine components; pressure transducers as parts of machines; pneumatic valve actuators; regulators being parts of machines; gas and liquid filters being parts of machines; welding electrodes; control valves for regulating the flow of gases and liquids.

8 – Hand-operated tools for cutting, sawing, bending, deburring and swaging tube and hose; wrenches.

9 – Welding apparatus, namely, remote pendant controls, weld head centering gauges, weld arc gap gauges; pressure gauges for gas and fluid; fittings gap inspection apparatus; electrical transducer; electric or electronic sensors for sensing flow of fluid; pressure transducers and transmitters that convert hydraulic or pneumatic pressure into analog electrical signals for monitoring and controlling hydraulic or pneumatic systems; electric valve actuators; pressure relief valves for fluid systems; thermometers; flowmeters; calibration devices for calibrating fluid systems.

11 – Pressure regulators for gas installations.

17 – Pipe joint sealant; sealant compounds for joints; non-metal gaskets for fluid systems; non-metal, plastic and rubber hoses for industrial applications; plastic pipe and flexible pipe not of metal; plastic glands and ferrules for plastic tubes, flexible pipes and non-metal hoses; all the aforesaid goods for research, instrumentation, pharmaceutical, oil and gas, power generation, chemical, petrochemical, sanitary and semiconductor industry purposes; non-metallic flexible pipes and hose fittings; flexible tubes of plastic and plugs therefor; metal gaskets for tubes, pipes and hoses; non-metal pipe couplings and joints; non-metal tubing and tubing couplings for joining and terminating pipes.

20 – Plastic valves being other than machine parts; plastic nuts.

35 – Business consulting services relating to logistics management, marketing, inventory control, and customer services management for others in the fields of biopharmaceutical, food, beverage, dairy, oil and gas, power generation, chemical, petrochemical, shipbuilding, pulp and paper, and semiconductor technologies; business management consultancy; business organization consultancy; business management assistance; business information; procurement, namely, purchasing of fluid systems equipment for others used in the process of analytical instrumentation, biopharmaceutical, food, beverage, dairy, oil and gas, power generation, chemical, petrochemical, shipbuilding, pulp and paper, and semiconductor industries.

37 – Rental of equipment, namely, weld systems, tube benders, and other equipment, namely, tube flaring tools, gap inspection gauges, depth marking tools and tube cutters for the support of fluid systems technologies used in the process and analytical instrumentation, biopharmaceutical, food, beverage, dairy, oil and gas, power generation, chemical, petrochemical, shipbuilding, pulp and paper, and semiconductor industries.

39 – Shipping and delivery services, namely, pickup and transportation, and delivery of goods used in the process and analytical instrumentation, biopharmaceutical, food, beverage, dairy, oil and gas, power generation, chemical, petrochemical, shipbuilding, pulp and paper, and semi-conductor industries by various modes of transportation.

41 – Educational training services, namely, conducting classes and providing electronic and on-site training in the field of fluid system technologies equipment for goods used in the process and analytical instrumentation, biopharmaceutical, food, beverage, dairy, oil and gas, power generation, chemical, petrochemical, shipbuilding, pulp and paper, and semi-conductor industries, and distributing course materials in connection therewith.

42 – Testing, analysis and evaluation of the goods of others for the purpose of certification, engineering consultancy and chemistry consultancy, in the fields of process and analytical instrumentation, biopharmaceutical, food, beverage, dairy, oil and gas, power generation, chemical, petrochemical, shipbuilding, pulp and paper, and semi-conductor technologies; quality control; technical support services, namely, troubleshooting of computer software problems.

(260) AM 2018 94297 A

(800) 1365764

(151) 2017 05 19

(891) 2017 05 19

(731) GERE P Maschinenbau GmbH

Alter Postweg 10 29556 Suderburg, Germany

(540)



(591) Blue

(531) 24.13.05; 24.13.23; 26.04.03; 29.01.04

(511)

7 – Shock absorbing cylinders [parts of machines]; industrial shock absorber plungers [parts of machines].

12 – Shock absorbers being parts of vehicle suspension and shock absorbers for railway vehicles, trucks and busses.

(260) AM 2018 94298 A

(800) 1365775

(151) 2017 06 19

(891) 2017 06 19

(731) DEFACTO PERAKENDE TİCARET

ANONİM ŞİRKETİ

Defacto Plaza Basın Ekspres Yolu Atatürk
Mah. Bahariye Cad. No. 31 Küçükçekmece,
Turkey



(591) Black and white

(531) 21.01.14; 24.17.25; 27.05.02

(511)

25 – Clothing, including underwear and outerclot-
hing, other than special purpose protective clothing;
socks, mufflers [clothing], shawls, bandanas, scar-
ves, belts [clothing], footwear, shoes, slippers, san-
dals, headgear, hats, caps with visors, berets, caps
[headwear], skull caps.

(260) AM 2018 94299 A

(800) 1365778

(151) 2017 07 05

(891) 2017 07 05

(731) DOĞAL KİMYEVİ MADDELER VE

ZİRAİİLAÇLAR SANAYİ VE TİCARET

ANONİM ŞİRKETİ

Toplarönü Sk. No:16, Anadoluhisari Beykoz
TR-34810 İstanbul, Turkey

(540)



(591) Green, yellow, and brown

(531) 01.03.01; 07.03.11; 27.05.17; 29.01.13

(511)

44 – Agriculture, horticulture and forestry services.

(260) AM 2018 94300 A

(800) 1282805

(151) 2015 09 07

(891) 2017 07 19

(731) NOVOSOLOV IURII OLEKSANDROVYCH

Zaporiz'Ke Shose, 62, KV. 142 M,
DNIPROPETROVSK 49041, Ukraine

(540)

Соробан

(591) Black, white

(531) 28.05

(511)

41 – Academies (education), consultancy services
relating to education; education and training servi-
ces, rental of audio equipment, lending libraries, bo-
okmobile services/mobile library services, educatio-
nal services, presentation of live performances,
education information, nursery schools, organization
of competitions [education or entertainment], arrang-
ing and conducting of colloquiums, arranging and
conducting of conferences, arranging and conducting
of seminars, arranging and conducting of workshops
[training], arranging and conducting of symposiums,
correspondence courses, arranging and conducting
of congresses, coaching [training], club services [en-
tertainment or education], practical training [demon-
stration], religious education, tutoring, vocational
guidance [education or training advice], boarding
schools, vocational retraining.

(260) AM 2018 94301 A

(800) 1338099

(151) 2016 11 22

(891) 2017 05 31

(731) PHILIP MORRIS PRODUCTS S.A.

Quai Jeanrenaud 3, CH-2000 Neuchâtel,
Switzerland

(540)

IQOS

(591) Black, white

(531) 05.03.14; 27.03.11; 27.05.17

(511)

35 – Advertising, marketing, commercialization,
promotion and retail services (including online retail
services) of heated tobacco products, electronic ciga-
rettes, electronic smoking devices, electronic devices
and their parts for the purpose of heating cigarettes
or tobacco in order to release nicotine-containing ae-
rosol for inhalation, oral vaporizing devices, vaporiz-
ers for electronic cigarettes and smoking devices,
electronic rechargeable cigarette cases, extinguishers
for heated cigarettes and cigars as well as heated to-
bacco sticks, liquid nicotine solutions for use in
electronic cigarettes, tobacco substitutes (not for me-
dical purposes), smokers' articles, batteries for el-
ectronic cigarettes and for heating portable electro-
nic smoking devices, battery chargers, chargers for
electronic devices, parts and fittings for the afore-
mentioned goods.

(260) AM 2018 94302 A

(800) 1365794

(151) 2017 07 04

(891) 2017 07 04

(731) Obshchestvo s ogranichennoy
otvetstvennostyu "KROKMART"
ul. Koroleva, d. 40 RU-630015
g. Novosibirsk, Russian Federation

(540)

**В хозяйстве хороша
ХОЗЯЮШКА
Мила**

(591) Black and white

(531) 28.05

(511)

6 – Ironmongery; hooks of metal for clothes rails; clothes hooks of metal; bands of metal for tying-up purposes; staircases of metal; traps for wild animals; building materials of metal; binding thread of metal for agricultural purposes; door handles of metal; towel dispensers, fixed, of metal; hinges of metal; insect screens of metal.

8 – Garden tools, hand-operated; abrading instruments [hand instruments]; annular screw plates; depilation appliances, electric and non-electric; sharpening instruments; nail clippers, electric or non-electric; cutting tools [hand tools]; hand tools, hand-operated; daggers; razor blades; beard clippers; hair clippers for personal use, electric and non-electric; hammers [hand tools]; manicure sets; knives; scissors; agricultural implements, hand-operated; saws [hand tools]; tweezers; cutters; tongs; tool handles of metal.

21 – Hair for brushes; birdcages; funnels; carpet beaters [hand instruments]; abrasive sponges for scrubbing the skin; sponges for household purposes; toilet sponges; deodorising apparatus for personal use; sponge holders; soap holders; holders for flowers and plants [flower arranging]; stands for shaving brushes; ironing boards; cutting boards for the kitchen; chamois leather for cleaning; toothpicks; ceramics for household purposes; brush goods; cleaning instruments, hand-operated; stew-pans; covers, not of paper, for flower pots; shaving brushes; cages for household pets; polishing leather; shoe trees [stretchers]; napkin rings; beer mugs; tankards; rat traps; pot lids; butter-dish covers; covers for dishes; cheese-dish covers; buttonhooks; jugs; perfume burners; coldboxes (non-electric portable -); insect traps; mixing spoons [kitchen utensils]; basting spoons, for kitchen use; tart scoops; spatulas [kitchen utensils]; litter boxes [trays] for pets; butter dishes; brush-making (material for -); polishing materials for making shiny, except preparations, paper and stone; feather-dusters; brooms; isothermic bags; confectioners' decorating bags [pastry bags]; basins [bowls]; mosaics of glass, not for building; saucepan scourers of metal; soap boxes; mouse traps; cooking pot sets; nozzles for watering cans; spouts; nozzles for sprinkler hose; picnic baskets (fitted -), including dishes; toilet

cases; floss for dental purposes; fiberglass thread, not for textile use; cookie [biscuit] cutters; pastry cutters; sprinklers; sprinklers for watering flowers and plants; cotton waste for cleaning; wool waste for cleaning; cleaning tow; chopsticks; cocktail stirrers; pepper pots; gloves for household purposes; polishing gloves; gardening gloves; lazy susans; heaters for feeding bottles, non-electric; candlesticks; trivets [table utensils]; coasters, not of paper and other than table linen; menu card holders; knife rests for the table; flat-iron stands; egg cups; grill supports; scouring pads; drinking troughs; powdered glass for decoration; pottery; pots; cooking pots; glassware (painted -); tableware, other than knives, forks and spoons; porcelain ware; earthenware; crystal [glassware]; cosmetic utensils; trouser presses; cruet stands for oil and vinegar; spice sets; food cooling devices, containing heat exchange fluids, for household purposes; toilet paper dispensers; apparatus for wax-polishing, non-electric; bottle openers; glove stretchers; boot jacks; crumb trays; tie presses; clothes-pegs; glass caps; powder compacts; perfume sprayers; powder puffs; dusting apparatus, non-electric; soap dispensers; combs; shoe horns; candle rings; tea strainers; siphons for carbonated water; rolling pins, domestic; pressure cookers [autoclaves], non-electric; steel wool for cleaning; curry-combs; blenders, non-electric, for household purposes; vessels of metal for making ices and iced drinks; refrigerating bottles; cups of paper or plastic; glass [receptacles]; drinking glasses; drying racks for washing; basins [receptacles]; table plates; graters [household utensils]; vacuum bottles; indoor terrariums [plant cultivation]; cloth for washing floors; cloths for cleaning; dusting cloths [rags]; furniture dusters; urns; aerosol dispensers, not for medical purposes; water apparatus for cleaning teeth and gums; wax-polishing appliances, non-electric, for shoes; sprinkling devices; utensils for household purposes; kitchen utensils; cooking utensils, non-electric; fly swatters; teapots; kettles, non-electric; cups; garlic presses [kitchen utensils]; ironing board covers, shaped; mops; cocktail shakers; pig bristles; dishwashing brushes; brushes for cleaning tanks and containers; lamp-glass brushes; horse brushes; scrubbing brushes; toothbrushes; toothbrushes, electric; bristles (animal -) [brushware]; carpet sweepers; brushes for footwear; toilet brushes; boxes of metal, for dispensing paper towels; dustbins.

22 – String; tarpaulins; wadding for padding and stuffing upholstery; wadding for filtering; ropes; fibers (textile -); horsehair; hammocks; jute; wax ends; ropes, not of metal; kapok; cocoons; raw linen [flax]; strips for tying-up vines; ladder tapes for venetian blinds; rope ladders; linters; liber; padding materials, not of rubber, plastics, paper or cardboard; packing [cushioning, stuffing] materials, not of rubber, plastics, paper or cardboard; bags [sacks] for the transport and storage of materials in bulk; mail bags;

twine for nets; thread, not of metal, for wrapping or binding; wrapping or binding bands, not of metal; sawdust; bottle envelopes of straw; tow; cotton tow; silk flock; tents; sails; sails for ski sailing; hemp; tarred brattice cloth; feathers for bedding; sacks [bags] of textile, for packaging; gaskets (fibrous -) for ships; down [feathers]; belts, not of metal, for handling loads; hemp bands; fleece wool; camouflage (nets for -); fishing nets; nets; sisal; glass fibers [fibres] for textile use; slings, not of metal, for handling loads; bags for washing hosiery; raw fibrous textile; awnings of synthetic materials; awnings of textile; network; cables, not of metal; car towing ropes; vehicle covers, not fitted; camouflage (covers for -); raw or treated wool; cords for hanging pictures; sash cords.

24 – Frieze [cloth]; velvet; household linen; diapered linen; bath linen, except clothing; bed linen; table linen, not of paper; buckram; dimity; felt; jersey [fabric]; table runners; drugget; shower curtains of textile or plastic; curtains of textile or plastic; net curtains; zephyr [cloth]; banners; canvas for tapestry or embroidery; bolting cloth; crepe [fabric]; crepon; furniture coverings of textile; fabrics for textile use; filtering materials of textile; wall hangings of textile; non-woven textile fabrics; plastic material [substitute for fabrics]; material (textile -); sleeping bag liners; haircloth [sackcloth]; moleskin [fabric]; pillowcases; mattress covers; bed blankets; eiderdowns [down coverlets]; brocades; handkerchiefs of textile; travelling rugs [lap robes]; hat linings, of textile, in the piece; coasters [table linen]; curtain holders of textile material; bed covers; bed covers of paper; coverings of plastic for furniture; towels of textile; hemp cloth; ticks [mattress covers]; gummed cloth, other than for stationery; printers' blankets of textile; cloth; door curtains; shrouds; tissues of textile for removing make-up; face towels of textile; place mats, not of paper; tablecloths, not of paper; oilcloth for use as tablecloths; billiard cloth; taffeta [cloth]; tick [linen]; lingerie fabric; fabric, impervious to gases, for aeronautical balloons; jute fabric; fabric for footwear; ramie fabric; esparto fabric; damask; adhesive fabric for application by heat; linen cloth; hemp fabric; lining fabric for shoes; traced cloths for embroidery; chenille fabric; printed calico cloth; bunting; knitted fabric; cotton fabrics; silk fabrics for printing patterns; woollen cloth; elastic woven material; fabric; fabric of imitation animal skins; cheese cloth; marabouts [cloth]; tulle; flags, not of paper; flannel [fabric]; sanitary flannel; trellis [cloth]; fitted toilet lid covers of fabric; covers [loose] for furniture; pillow shams; cheviots [cloth]; labels of cloth.

(260) AM 2018 94303 A
(800) 1365825
(151) 2017 06 28

(891) 2017 06 28

(731) Merial

29 avenue Tony Garnier F-69007 LYON,
France

(540)

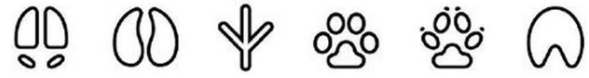

(591) Black and white

(531) 03.06.03

(511)

3 – Soaps, shampoos, lotions, dentifrices, toiletries and cosmetic care products for animals; skin care preparations for animals.

5 – Preparations for veterinary use; preparations for destroying vermin; parasiticides, fungicides; pharmaceutical products, medicines and vaccines for veterinary use; medicinal nutritional supplements for animals.

10 – Surgical, medical, dental and veterinary apparatus and instruments; orthopedic articles; suture material.

31 – Foodstuffs for animals, pet food; dry foodstuffs for animals; dog biscuits; edible chewing bones and sticks for animals; edible treats for animals.

(260) AM 2018 94304 A

(800) 1352411

(151) 2017 03 27

(891) 2017 07 21

(731) GILEAD SCIENCES IRELAND UC

IDA Business and Technology Park,
Carrigtohill, Co. Cork, Ireland

(540)

BIKTARVY

(591) Black and white

(511)

5 – Pharmaceutical preparations.

(260) AM 2018 94305 A

(800) 1365888

(151) 2017 05 29

(891) 2017 05 29

(731) SUNTORY HOLDINGS LIMITED

1-40, Dojimahama 2-chome, Kita-ku, Osaka-shi
Osaka 530-8203, Japan

(540)

ROKU

(591) Black and white

(531) 27.05.17

(511)

33 – Gin; awamori [distilled rice spirits]; sake substitute; Japanese white liquor (Shochu); Japanese

sweet rice-based mixed liquor (Shiro-zake); sake; Naoshi [Japanese liquor]; Japanese shochu-based mixed liquor (Mirin); western liquors (in general); alcoholic fruit beverages; Japanese shochu-based beverages (Chuhai); beer-flavored alcoholic beverages containing neither malt nor oats; beer-flavored alcoholic beverages containing malt or oats (except beers and low malt beers); Chinese liquors (in general); flavored liquors.

(260) AM 2018 94425 A

(800) 1367425

(151) 2017 07 26

(891) 2017 07 26

(731) Obshchestvo s ogranichennoy
otvetstvennostyu "DYURAN MEDIA"
Vakhitova Street, 4B, RU-603001 Nizhny
Novgorod, Russian Federation

(540)

TAUBERG

(591) Black, white

(531) 27.05.02

(511)

1 – Anti-boil preparations for engine coolants; anti-freeze; auxiliary fluids for use with abrasives; brake fluid; catalysts; chemical additives to motor fuel; combusting preparations [chemical additives to motor fuel]; descaling preparations, other than for household purposes; detergent additives to petrol [gasoline]; disinfectants; engine-decarbonising chemicals; fluids for hydraulic circuits; fuel-saving preparations; glue for industrial purposes; oil dispersants; plasticizers; silicones; transmission fluid.

4 – Additives, non-chemical, to motor fuel; cutting fluids; dust laying compositions; industrial oil; lubricants; lubricating grease; lubricating oil; motor oil; vaporized fuel mixtures.

(260) AM 2018 94437 A

(800) 1110445

(151) 2012 02 28

(891) 2017 09 14

(731) ESAVE AG

Kupfergasse 15, CH-7002 Chur, Switzerland

(540)

ESAVE

(591) Black, white

(531) 05.03.14; 27.05.01

(511)

9 – Electric apparatus and instruments for conducting, switching, transforming, storing, regulating and/or controlling electricity; apparatus for remote

control, signaling, monitoring and regulating; switching devices and monitoring devices for lighting systems; apparatus and instruments for recording, transmission or reproduction of sound, images or data; communication apparatus, electric, magnetic and optical data carriers; data processing equipment and computers; monitoring software and programs; parts of all the above goods included in this class.

11 – Lighting fixtures, lamps; street lamps, floor lamps; lamp chimneys; electric lamps; lamp reflectors; light-emitting diodes, LED; lamp chimneys, lamp cylinders; projector lamps; pocket torches; parts of all the above goods included in this class.

16 – Paper, cardboard and goods made from these materials, not included in other classes; printed matter; bookbinding material; photographs; stationery; adhesives [glues] for stationery or household purposes; artists' materials; paintbrushes; typewriters and office requisites (except furniture); instructional and teaching material (except apparatus); plastic materials for packaging (not included in other classes); printing type, printing blocks.

42 – Scientific and technological services and research and design services related thereto; industrial analysis and research services, design and development of computer hardware and software; consultancy services in connection with developing lighting systems; computer services for restoration and maintenance of networks (computer software).

(260) AM 2018 94438 A

(800) 1351999

(151) 2016 07 15

(891) 2017 08 02

(731) Otkrytoie aktsionernoie obshchestvo
"PUSHKINSKII ZAVOD"

Yaroslavskoie shossie, 1, lit.A., h.Pushkino,
RU-141200 Moskovskaia obl., Russian
Federation

(540)



(591) White, blue and red.

(531) 26.01.11; 26.04.10; 26.04.22; 27.05.01;
29.01.13

(511)

1 – Anti-knock substances for internal combustion engines; antistatic preparations, other than for hou-

sehold purposes; antifreeze; acetone; distilled water; acidulated water for recharging accumulators; brake fluid; glycol; glycerine for industrial purposes; detergents for use in manufacturing processes; petroleum dispersants; detergent additives to gasoline; chemical additives to motor fuel; glycol ether; opacifiers for glass; dehydrating preparations for industrial purposes; degreasing preparations for use in manufacturing processes; scale removing preparations, other than for household purposes; cement for pneumatic tires (tyres); adhesives for industrial purposes; corrosive preparations; methyl alcohol; combusting preparations (chemical additives to motor fuel); coolants for vehicle engines; purification preparations; fuel-saving preparations; anti-incrustants; anti-frothing solutions for batteries; anti-boil preparations for engine coolants; liquids for removing sulfates from accumulators; power steering fluid; fluids for hydraulic circuits; transmission fluid; solvents for adhesives; solvents for varnishes; tire repairing compositions; ethyl alcohol; synthetic materials for absorbing oil; filtering materials (unprocessed plastics); oil-purifying chemicals; engine-decarbonising chemicals; chemical additives for oils; fillers for automobile bodies; oil cement (putty).

3 – Abrasives; ammonia [volatile alkali] [detergent]; shining preparations (polish); cloths impregnated with a detergent for cleaning; disinfectant soap; laundry soaking preparations, preparations for soaking laundry; color-removing preparations; degreasers other than for use in manufacturing processes; scale removing preparations for household purposes; polishing wax; polishing creams; polishing preparations; polish for furniture and flooring; detergents other than for use in manufacturing operations and for medical purposes; washing preparations; soap; oils for cleaning purposes; oil of turpentine for degreasing; laundry paste; canned pressurized air for cleaning and dusting purposes; laundry glaze; laundry bleaching preparations; laundry preparations; dry-cleaning preparations; stain removers; paint stripping preparations; floor wax removers (scouring preparations); windscreen cleaning liquids; tissues impregnated with cosmetic lotions; turpentine, for degreasing; cleaning (polishing) preparations; cleaning preparations; scouring solutions; shampoos.

4 – Benzine; benzol; gasoline; kerosene; lubricating graphite; methylated spirit; charcoal (fuel); diesel oil; additives, non-chemical, to motor fuel; tallow; moistening oil; carnauba wax; xylol; mazut; firelighters; grease for arms (weapons); grease for belts; lubricating grease; lubricants; lubricating oil; cutting fluids; mineral fuel; motor fuel; motor oil; naphtha; petroleum, raw or refined; petroleum ether; oil-gas; fuel gas; vaporized fuel mixtures; fuel; fuel with an alcoholic base; alcohol (fuel); industrial oil.

35 – Cost price analysis; commercial information agencies; auctioneering; market studies; opinion

polling; organization of exhibitions for commercial or advertising purpose; organization of trade fairs for commercial or advertising purpose; demonstration of goods; business research; business information; business appraisals; business investigations; business inquiries; business management assistance; marketing research; commercial or industrial management assistance; advisory services for business management; economic forecasting; business efficiency expert services; compilation of statistics; invoicing; business management consultancy; business organization consultancy; commercial information and advice for consumers (consumer advice shop); writing of publicity texts; rental of advertising space; rental of advertising time on communication media; publicity material rental; updating of advertising material; shop window dressing; price comparison services; layout services for advertising purposes; outsourcing services (business assistance); procurement services for others (purchasing goods and services for other business); sponsorship search; presentation of goods on communication media, for retail purposes; publication of publicity texts; radio advertising; advertising by mail order; advertising agencies; advertising; on-line advertising on a computer network; outdoor advertising; distribution of samples; dissemination of advertising matter; direct mail advertising; sales promotion for others; television advertising; professional business consultancy.

42 – Technical project studies; material testing; recovery of computer data; research in the field of environmental protection; chemical research; surveying; computer programming; consultancy in the field of energy-saving; consultancy in the design and development of computer hardware; computer software consultancy; rental of web servers; rental of computer software; computer rental; creating and maintaining web sites for others; maintenance of computer software; chemistry services; quality control; vehicle roadworthiness testing; research and development of new products for others; computer system design; industrial design; hosting computer sites (web sites); styling (industrial design); chemical analysis.

(260) AM 2018 94443 A

(800) 1366858

(151) 2017 05 19

(891) 2017 05 19

(731) HORS LIMITED

26, Nikou Pattichi Str. CY-3071 Limassol, Cyprus

(540)

SELVAGGIO

(591) Black, white

(531) 27.05.01

(511)
29 – Meat, fish, poultry and game; meat extracts; preserved, dried and cooked fruits and vegetables; jellies; jams; compotes; eggs; milk and milk products; edible oils and fats; peanut butter; cocoa butter for food; coconut oil for food; coconut butter; corn oil for food; sesame oil for food; linseed oil for culinary purposes; olive oil for food; palm oil for food; palm kernel oil for food; sunflower oil for food; rape oil for food; butter; soya bean oil for food.

30 – Vegetal preparations for use as coffee substitutes; cocoa; coffee; cocoa beverages with milk; coffee beverages with milk; coffee-based beverages; cocoa-based beverages; tea-based beverages; chocolate beverages with milk; chocolate-based beverages; miso [condiment]; muesli; soya bean paste [condiment]; soya sauce; sauces [condiments]; seasonings; vinegar; tea; chicory [coffee substitute]; chocolate; essences for foodstuffs, except etheric essences and essential oils.

(260) AM 2018 94480 A
(800) 1367985
(151) 2017 07 12
(891) 2017 07 12
(731) INNER MONGOLIA BAOTOU STEEL UNION CO., LTD.
Hexi Industrial Park, Kun District, Baotou City Inner Mongolia, China

(540)

BISG

(591) Black, white
(531) 27.05.01; 27.05.17
(511)
6 – Iron, unwrought or semi-wrought; steel sheets; blooms [metallurgy]; ingots of common metal; rails of metal; steel pipes; steel wire; hoop steel; iron wire; railroad ties of metal.

(260) AM 2018 94482 A
(800) 1367986
(151) 2017 07 12
(891) 2017 07 12
(731) INNER MONGOLIA BAOTOU STEEL UNION CO., LTD.
Hexi Industrial Park, Kun District, Baotou City Inner Mongolia, China

(540)



(591) Black, white
(531) 26.01.02; 26.01.18; 26.13.25
(511)
6 – Hoop steel; steel sheets; ingots of common metal; blooms [metallurgy]; steel pipes; rails of metal; steel wire; iron wire; pig iron; railroad ties of metal.

(260) AM 2018 94484 A
(800) 1367505
(151) 2017 08 17
(891) 2017 08 17
(731) JANSSEN PHARMACEUTICA NV
Turnhoutseweg 30 B-2340 BEERSE, Belgium
(540)

TEMPOZA

(591) Black and white
(511)
5 – Pharmaceutical preparations for human use excluding pharmaceutical preparations for dental care.

(260) AM 2018 94527 A
(800) 1368534
(151) 2017 08 10
(891) 2017 08 10
(731) APPLE INC.
1 Infinite Loop, Cupertino CA 95014, USA
(540)

EXPOSÉ

(591) Black, white
(511)
9 – Feature of computer software for the collection, organizing and storage of data and information; feature of graphical user interface software.

(260) AM 2018 94528 A
(800) 1368211
(151) 2017 06 28
(891) 2017 06 28
(731) HUAWEI TECHNOLOGIES CO., LTD.
Administration Building Huawei Technologies Co., Ltd., Bantian, Longgang District Shenzhen, China

(540)

HUAWEI P10

(591) Black, white
(531) 27.05.01
(511)
9 – Smartphones; protective covers for mobile phones; protective cases for mobile phones; batteries for mobile phones; tablet computers; protective covers for tablet computers; supports for tablet computers; protective cases for tablet computers; headphones; earphones; television apparatus; set-top boxes; portable cabinets for loudspeakers; sound transmitting

apparatus; camcorders; digital photo frames; routers; network communication equipment; cell phone straps; wearable computers having the functions of making phone calls, sleep monitoring, activity recording and managing; screens for mobile phones; computer keyboards; mouse (computer peripheral); wearable network communication equipment having the functions of making phone calls, sleep monitoring, activity recording and managing; modems; telephone sheath; portable media players; encoded identification bracelets, magnetic; pedometers; electric monitoring apparatus; smartglasses; smartwatches; wearable activity trackers; selfie sticks (hand-held monopods); holograms; connected bracelets (measuring instruments); protective films adapted for computer screens; protective films adapted for cell phones; covers for smartphones; cases for smartphones; chargers for electronic cigarettes.

(260) AM 2018 94529 A
(800) 1368620
(151) 2017 04 07
(891) 2017 04 07
(731) STEPHAN WILSON
Sanddornweg 1, 49377 Vechta, Germany
(540)



LINE ONE

(591) Black, white
(531) 26.01.18; 27.05.17
(511)

18 – Work bags; clothing for pets; dog clothing; overnight cases; travel cases; attaché cases; cosmetic purses; vanity cases, not fitted; leather bags and wallets; umbrellas; traveling trunks; trunks [luggage]; travelling sets [leatherware]; wheeled bags; roller suitcases; saddlery of leather; key cases; key cases made of leather; key cases of imitation leather; school book bags; school knapsacks; satchels; sports packs; bags for sports; bags; gentlemen's handbags; garment carriers; collars for animals.

24 – Bath towels; bath linen; coated fabrics; duvet covers; comforters; jersey [fabric]; jersey [fabric]; mixed fiber fabrics; cloth with a raised nap; textile material; suiting materials [textile]; fabrics for shirts; materials for use in making clothes; fabrics for use in making jerseys; woven fabrics; towels of textile; fabrics; apparel fabrics; textile fabric piece goods for the manufacture of upholstered furniture; textile piece goods for furnishing purposes; textile goods, and substitutes for textile goods.

25 – Layette [clothing]; motorists' clothing; baby clothes; children's wear; infant wear; clothing; clot-

hing of leather; linen clothing; paper clothing; blazers; bobble hats; boxer shorts; capes; ladies' clothing; pocket squares; waist belts; gloves [clothing]; shirts; trousers; hats; jackets [clothing]; dresses; dresses made from skins; headgear; nighties; nightwear; outer clothing; dress shirts; polo shirts; sweaters; sandals; footwear; shorts; gym suits; sports jerseys; boots; sports jerseys; tee-shirts; kerchiefs [clothing]; neckerchiefs; underwear; thermally insulated clothing; weatherproof clothing.

(260) AM 2018 94531 A
(800) 1368643
(151) 2017 07 21
(891) 2017 07 21
(731) Limited Liability Company "VARNITSA"
ul. Lenina, 55-a, pos. Kardymovo,
Kardymovskiy r-on, RU-215850 Smolenskaya
oblast, Russian Federation

(540)

DE BROGELONNE

(591) Black, white
(511)

32 – Beer-based cocktails; beer; ginger beer; malt beer; beer wort; malt wort; extracts of hops for making beer.

35 – Demonstration of goods; commercial information and advice for consumers [consumer advice shop]; providing business information via a web site; presentation of goods on communication media, for retail purposes; sales promotion for others; administrative processing of purchase orders; procurement services for others [purchasing goods and services for other businesses].

43 – Snack-bar services; café services; cafeteria services; restaurant services; self-service restaurant services; canteen services; bar services; food and drink catering.

(260) AM 2018 94532 A
(800) 1368645
(151) 2017 06 27
(891) 2017 06 27
(731) Zakrytoe Aktsionernoe Obshchestvo "MARKON"
ul. Zelentsovskaya, d. 17, RU-150002 Yaroslavl,
Russian Federation

(540)



(591) Black, white
(531) 26.04.02; 26.04.04; 26.04.18; 27.05.02;
27.05.10

(511)
12 – Shock absorbers for automobiles; bumpers for automobiles; vehicle bumpers; transmission shafts for land vehicles; valves for vehicle tires [tyres]; horns for vehicles; doors for vehicles; engines for land vehicles; brake discs for vehicles; rearview mirrors; side view mirrors for vehicles; inner tubes for pneumatic tires [tyres]; hoods for vehicle engines; crankcases for land vehicle components, other than for engines; vehicle wheels; brake pads for automobiles; brake linings for vehicles; gear boxes for land vehicles; bands for wheel hubs; caps for vehicle petrol [gas] tanks; automobile bodies; propulsion mechanisms for land vehicles; freewheels for land vehicles; clutches for land vehicles; upholstery for vehicles; rims for vehicle wheels; windows for vehicles; engine mounts for land vehicles; axles for vehicles; headlight wipers; gearing for land vehicles; head-rests for vehicle seats; vehicle running boards; air bags [safety devices for automobiles]; cigar lighters for automobiles; shock absorbing springs for vehicles; reduction gears for land vehicles; safety belts for vehicle seats; vehicle suspension springs; rudders; brake segments for vehicles; anti-theft alarms for vehicles; reversing alarms for vehicles; vehicle seats; hydraulic circuits for vehicles; vehicle wheel spokes; spoilers for vehicles; windscreens; windshield wipers; hubs for vehicle wheels; couplings for land vehicles; bicycle brakes; brakes for vehicles; transmission chains for land vehicles; spare wheel covers; covers for vehicle steering wheels; seat covers for vehicles; automobile chassis; automobile tires [tyres]; motors, electric, for land vehicles.

(260) AM 2018 94538 A
(800) 430882
(151) 1977 03 25
(891) 2017 07 21
(731) CARLOS FUSTE SENALLE
Calle Principe de Asturias, 5, 5o, 1a. E-08012
BARCELONA, Spain

(540)

SADIRA

(591) Black, white
(511)
3 – Preparations for cleaning, maintaining and protecting firearms.

4 – Products for maintaining and protecting firearms; industrial oils and greases (other than edible oils and fats and essential oils); lubricants; dust-binding compositions; fuels and lighting fuel; candles, nightlights and wicks; oils and greases for protecting arms and belts, oils for machines, penetrating oils; non-slipping products.

13 – Firearms, products for the cleaning and maintenance thereof; ammunition and projectiles, explosive substances; fireworks and other accessories relating to the aforementioned products.

(260) AM 2018 94539 A
(800) 955877
(151) 2008 02 01
(891) 2017 08 25
(731) Otkrytoe aktsionernoe obshchestvo
"NIZHEGORODSKY MASLO-ZHIROVOY
KOMBINAT"
11, sh. Zhirkombinata, RU-603950
g. Nizhny Novgorod, Russian Federation

(540)



(591) red, white
(531) 26.11.12; 28.05; 29.01.01; 29.01.12
(511)

3 – Soaps; perfumery, essential oils, cosmetics, hair lotions; dentifrices.

(260) AM 2018 94540 A
(800) 1114729
(151) 2012 04 02
(891) 2017 08 28
(731) NIZHEGORODSKY MASLO-ZHIROVOY
KOMBINAT
11, sh. Zhirkombinata, RU-603950 g. Nizhny
Novgorod, Russian Federation

(540)

Морской ветер

(591) Black, white
(511)

3 – Bleaching preparations and other substances for laundry use; cleaning preparations; soaps; perfume-ry, essential oils, cosmetics, hair lotions; petroleum jelly for cosmetic purposes; cotton wool for cosmetic purposes; sachets for perfuming linen; greases for cosmetic purposes; quillaia bark for washing; cosmetic creams; skin whitening creams; lotions for cosmetic purposes; beauty masks; oils for cosmetic purposes; oils for toilet purposes; oils for cleaning purposes; disinfectant soap; deodorant soap; shaving soap; soap for brightening textile; cakes of toilet soap; medicated soap; antiperspirant soap; soap for foot perspiration; almond soap; cosmetic kits; cosmetic preparations for baths; toiletries; laundry soaking preparations; polishing preparations; starch

glaze for laundry purposes; fabric softeners for laundry use; laundry bleach; make-up removing preparations; paint stripping preparations; color-brightening chemicals for household purposes [laundry]; scouring solutions; tissues impregnated with cosmetic lotions; bath salts, not for medical purposes; sun-tanning preparations [cosmetics]; cosmetic preparations for skin care; cosmetics; cosmetics for animals; detergents other than for use in manufacturing operations and for medical purposes; antiperspirants [toiletries]; cloths impregnated with a detergent for cleaning; shampoos; shampoos for pets; cotton sticks for cosmetic purposes; swabs [toiletries]; deodorants for personal use; creams for leather; waxes for leather; after-shave lotions; oils for perfumes and scents; adhesives for cosmetic purposes; stain removers; liquid soap; cream soap; shower gel; bath foam.

(260) AM 2018 94541 A
 (800) 1288056
 (151) 2015 11 27
 (891) 2017 09 20
 (731) TURNER NETWORK TELEVISION, INC.
 1050 Techwood Drive, NW, Atlanta GA
 30318, USA
 (540)



(591) Black, white
 (531) 26.01.03; 26.01.18; 26.01.24; 27.05.17;
 27.05.19; 27.05.24

(511)
 41 – Entertainment services, namely, production of motion picture films, on-going television programs featuring dramas, comedies, romances, documentaries, news, comedy performances and talk shows; motion picture film distribution services rendered through the medium of cable television, satellite television, broadcast television and the Internet; entertainment services, namely, providing multimedia program series via various platforms across multiple forms of transmission media.

(260) AM 2018 94647 A
 (800) 1369466
 (151) 2017 07 25
 (891) 2017 07 25
 (731) SHABSHAI YEFYM MYKHAILOVYCH
 br-Shkilnyi, bud. 12, kv. 66 m. Donetsk
 83015, Ukraine

(540)

Amograce

(591) Black and white

(531) 27.05.17

(511)

41 – Academies [education]; aikido instruction; amusement park services; providing amusement arcade services; animal training; rental of artwork; rental of audio equipment; arranging of beauty contests; boarding school education; booking of seats for shows; calligraphy services; providing casino facilities [gambling]; cinema presentations; rental of cinematographic apparatus; club services [entertainment or education]; coaching [training]; arranging and conducting of colloquiums; arranging and conducting of concerts; arranging and conducting of conferences; arranging and conducting of congresses; correspondence courses; disc jockey services; discotheque services; dubbing; education information; educational examination; educational services provided by schools; electronic desktop publishing; entertainer services; entertainment services; entertainment information; film production, other than advertising films; providing films, not downloadable, via video-on-demand transmission services; conducting fitness classes; gambling services; game services provided on-line from a computer network; games equipment rental; providing golf facilities; conducting guided tours; gymnastic instruction; health club services [health and fitness training]; holiday camp services [entertainment]; arranging and conducting of in-person educational forums; rental of indoor aquaria; karaoke services; language interpreter services; layout services, other than for advertising purposes; lending library services; rental of lighting apparatus for theatrical sets or television studios; microfilming; mobile library services; modelling for artists; rental of motion pictures; movie studio services; providing museum facilities [presentation, exhibitions]; music composition services; production of music; news reporters services; nightclub services [entertainment]; nursery schools; on-line publication of electronic books and journals; providing on-line electronic publications, not downloadable; providing on-line music, not downloadable; providing on-line videos, not downloadable; orchestra services; organization of competitions [education or entertainment]; organization of exhibitions for cultural or educational purposes; organization of sports competitions; organization of lotteries; organization of balls; organization of shows [impresario services]; organization of fashion shows for entertainment purposes; party planning [entertainment]; personal trainer services [fitness training]; photographic reporting; photography; physical education; practical training [demonstration]; presentation of circus performances; presentation of variety

shows; presentation of live performances; publication of texts, other than publicity texts; publication of books; radio entertainment; rental of radio and television sets; production of radio and television programmes; recording studio services; providing recreation facilities; recreation information; religious education; sado instruction [tea ceremony instruction]; screenplay writing; scriptwriting, other than for advertising purposes; arranging and conducting of seminars; rental of show scenery; production of shows; sign language interpretation; rental of skin diving equipment; songwriting; rental of sound recordings; sport camp services; providing sports facilities; rental of sports equipment, except vehicles; rental of sports grounds; rental of stadium facilities; rental of stage scenery; subtitling; arranging and conducting of symposiums; teaching; television entertainment; providing television programmes, not downloadable, via video-on-demand transmission services; rental of tennis courts; theatre productions; ticket agency services [entertainment]; timing of sports events; toy rental; training services provided via simulators; translation; tutoring; rental of video cassette recorders; rental of video cameras; videotape editing; rental of videotapes; videotaping; vocational guidance [education or training advice]; vocational retraining; arranging and conducting of workshops [training]; writing of texts; zoological garden services.

44 – Aerial and surface spreading of fertilizers and other agricultural chemicals; alternative medicine services; animal breeding; animal grooming; aquaculture services; aromatherapy services; artificial insemination services; beauty salon services; blood bank services; body piercing; chiropractic; convalescent home services; dentistry services; depilatory waxing; farming equipment rental; in vitro fertilization services; flower arranging; gardening; hair implantation; hairdressing; health care; health spa services; health centre services; health counselling; hospice services; hospital services; human tissue bank services; landscape gardening; landscape design; lawn care; manicuring; massage; medical clinic services; medical assistance; medical equipment rental; medical advice for individuals with disabilities; midwife services; nursing home services; nursing, medical; opticians' services; orthodontic services; palliative care; pest control services for agriculture, aquaculture, horticulture and forestry; pet grooming; pharmacy advice; physiotherapy; plant nursery services; plastic surgery; preparation of prescriptions by pharmacists; services of a psychologist; public bath services for hygiene purposes; reforestation services; rehabilitation for substance abuse patients; rest home services; sanatorium services; rental of sanitation facilities; sauna services; solarium services; speech therapy; tattooing; telemedicine services; therapy services; tree surgery; tree planting for carbon offsetting purposes; Turkish bath services; vermin ex-

terminating for agriculture, aquaculture, horticulture and forestry; veterinary assistance; visagists' services; weed killing; wreath making.

(260) AM 2018 94648 A
(800) 1369581
(151) 2017 05 18
(891) 2017 05 18
(731) MONDELEZ EUROPE GMBH
Lindbergh-Allee 1 CH-8152 Glattpark,
Switzerland
(540)



(591) Black and white
(531) 26.13.25
(511)
29 – Preserved, dried and cooked fruit and vegetables; jellies, jams, compotes; eggs, milk and dairy products; prepared meals consisting primarily of meat, fish, poultry or vegetables; soups and potato crisps; snacks and preparations for making snacks containing dried fruits and pulses.

30 – Rice, pasta; flour, cereals, cereal preparations, preparations made from wheat, cereal breakfast foods, confectionery, frozen confectionery, non-medicated confectionery having breath freshening properties; candy, chewing gum and bubble gum (confectionery); syrups with chocolate, chocolate syrups, syrups for toppings, honey, sauces (condiments), chocolate, cakes, sponge cakes, pastries, biscuits, cookies, crackers, pancakes (food) and waffles, scones, pastry and puddings, flans; bread; sugar and natural sweeteners; foodstuffs prepared in the form of snack foods made from rice, cereals, wheat; chocolate-based fillings for cakes and tarts, custard-based fillings for cakes and tarts; sandwiches, ready meals containing noodles, rice, pasta; preparations for making bakery products included in this class; snacks and preparations for making snacks containing nuts or confectionery, all included in this class.

(260) AM 2018 94769 A
(800) 1370923
(151) 2017 04 19
(891) 2017 04 19
(731) HUGEL INC.
61-20, Sinbuk-Ro Sinbuk-Eup, Chuncheon-Si
GANGWON-DO, Republic of Korea

(540)

HUGEL

(591) Black and white

(511)

5 – Pharmaceutical and veterinary preparations; drugs for medical purposes; adjuvants for medical purposes, biological preparations for medical purposes; pharmaceutical preparations for treating neurological diseases and disorders; pharmaceutical preparations for treating dystonia; pharmaceutical preparations for the treatment of wrinkles; pharmaceutical preparations for the treatment of spasm; pharmaceutical preparations for the treatment of pain; pharmaceutical agents for treating physically caused lesions; pharmaceutical preparations for use in treating urogenital system diseases and conditions; ophthalmic preparations; pharmaceutical preparations for ocular or intraocular surgery; pharmaceutical preparations for dental purposes; pharmaceutical preparations for use in dermatology; pharmaceutical preparations for treating skin disorders; microorganisms for medical purposes; cultures of microorganisms for medical or veterinary use; bacteriological preparations for medical and veterinary use; chemical preparations for pharmaceutical purposes; bacterial toxins, namely botulinum toxin; appetite suppressants for medical purposes, medicated lotions; ointments for pharmaceutical purposes; analgesics; pharmaceutical agents affecting peripheral nervous system; poisons; vaccines; hyaluronic acid mixed with its derivatives and other polysaccharides, including or not including lidocaine, in ampoule form for medical purposes; pharmaceutical preparations mainly based on hyaluronic acid; medical gels for activation of tissues (gels for hypodermic syringes for improving wrinkles); hyaluronic acid preparations for medical purposes (fillers for skin and soft tissue used for skin moisturizing and improving wrinkles); modified hyaluronic acid preparations for medical purposes (fillers for skin and soft tissue used for skin moisturizing and improving wrinkles); filler for dermatology; skin fillers; syringes for medical purposes (prefilled with pharmaceutical preparations in the nature of hyaluronic acid, modified hyaluronic acid, its derivatives or substances that have a similar effect to hyaluronic acid, for the treatment and management of skin and soft tissue or artificial prostheses).

(260) AM 2018 94770 A

(800) 1370930

(151) 2017 06 14

(891) 2017 06 14

(731) BSH Hausgeräte GmbH

Carl-Wery-Str. 34 81739 München,
Germany

(540)



(591) Black and white

(531) 26.01.12; 26.11.03; 26.11.05; 26.11.13;
27.05.10

(511)

7 – Electric household and kitchen machines and apparatus, included in class 7, in particular electric kitchen machines and apparatus, including grinders, beaters and kneading apparatus, fruit presses, juice extractors, juice centrifuges, mincing machines, electrically powered tools, tin openers, knife sharpening apparatus, and machines and apparatus for making beverages and/or preparing food, beverage pumps for dispensing chilled beverages; electric vending machines for beverages or foods, automatic vending machines; electrical apparatus for sealing plastics (packaging); electric waste disposal devices, including waste disposers and waste presses; dishwashers; electric machines and apparatus for treating laundry and clothing (included in this class), including washing machines, spin dryers; ironing presses, ironing machines, included in this class; electric household cleaning equipment, including electric window cleaning equipment, electric shoe polishers and vacuum cleaners, wet and dry vacuuming apparatus; robotic vacuum cleaners, robots for household chores; parts for all the aforesaid goods, included in this class; hoses, tubes, dust filters and dust filter bags, all for vacuum cleaners.

11 – Apparatus for heating, steam generating and cooking, in particular ovens, baking, roasting, grilling, toasting, defrosting and heating devices, water heaters, immersion heaters, slow-cookers, microwave ovens, waffle irons (electric), egg cookers, deep-fat fryers (electric); electric tea and coffee machines, espresso coffee machines, automatic coffee machines (included in this class); refrigerating apparatus, in particular refrigerators, chest freezers, refrigerated cabinets, beverage-cooling apparatus, fridge-freezers, freezers, ice machines and apparatus; drying apparatus, in particular including tumble dryers, laundry drying machines, hand dryers, hair dryers; infrared lamps (other than for medical use); heated cushions, not for medical purposes; blankets, electric, not for medical purposes; apparatus for ventilating, in particular fans; extractor hood filters, extractor hood equipment and extractor hoods, air conditioning apparatus and devices for improving air quality, air humidifiers, air deodorisers, fragrance dispensing apparatus (not for personal use); air purifying apparatus, apparatus for water supply and sanitary purposes, in particular including fittings for steam generating, ventilating and water supply installations; water heaters, storage water heaters and instantaneous water heaters; kitchen sinks; heat pumps; parts for all the aforesaid goods, included in

this class; mechanical taps (dispensers) for dispensing chilled beverages for use in combination with apparatus for chilling beverages (other than vending machines).

- (260) AM 2018 94771 A
 (800) 1370945
 (151) 2017 08 01
 (891) 2017 08 01
 (731) GÖKHAN BOYA SANAYI VE TICARET LIMITED SIRKETI
 Kazimpasa Mahallesi, Çanakkale Asfaltı
 No:20 Menemen – İzmir, Turkey
 (540)



- (591) Red, white, orange and black
 (531) 04.05.02; 04.05.03; 04.05.21; 26.01.22;
 26.01.24; 27.05.10; 27.05.24; 29.01.14
 (511)
 2 – Paints; varnishes; lacquers; preservatives against rust; preservatives against deterioration of wood; thinners and binders for paints; pigments; preservatives for metals; shoe dyes; printing dyes and ink; toners (including filled toner cartridges); colorants for food, pharmaceuticals and beverages, raw natural resins, metals in foil and powder form for painters, decorators, printers and artists.

- (260) AM 2018 94772 A
 (800) 1370966
 (151) 2017 09 01
 (891) 2017 09 01
 (731) MUZO INTERNATIONAL LTD.
 2nd Fl. Windward III, Regatta Office
 Park, 85 Peninsula Ave., P.O. Box 31661
 Grand Cayman KY1-1207, Cayman Islands
 (540)

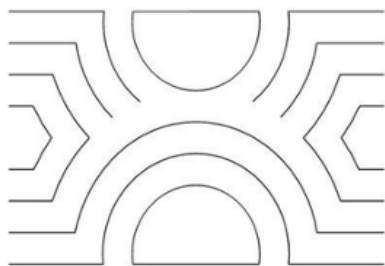

- (591) Black and white
 (531) 26.02.01; 26.07.25; 26.11.05; 26.11.11;
 26.11.25

- (511)
 14 – Emeralds; gemstones; precious stones.

- (260) AM 2018 94773 A
 (800) 1371002
 (151) 2016 06 05
 (891) 2017 06 05
 (731) PREMIER BEVERAGES P.B. LIMITED
 Amathountos, 50E PEARL BUILDING,
 3 rd floor, Flat/Office 1 Agios Tychonas,
 CY-4532 Limassol, Cyprus

(540)
БОБР/BOBR

- (591) Black and white
 (531) 27.05.17; 28.05
 (511)
 32 – Beers; mineral and aerated waters and other non-alcoholic beverages; fruit drinks and fruit juices; syrups and other preparations for making beverages; isotonic beverages; kvass [non-alcoholic beverage]; Smoothies; products for making mineral water; beer wort; extracts of hops for making beer; malt wort; non-alcoholic honey-based beverages; soy-based beverages, other than milk substitutes; beer-based cocktails.

33 – Alcoholic beverages except beers; ciders.

- (260) AM 2018 94775 A
 (800) 1371043
 (151) 2017 08 25
 (891) 2017 08 25
 (731) BIOFARMA
 50 rue Carnot F-92284 SURESNES Cedex,
 France

(540)
ИНКСИТУ

- (591) Black and white
 (531) 28.05
 (511)
 5 – Pharmaceutical products; veterinary preparations; sanitary products for medical purposes; implants for pharmaceutical use, namely implants (living tissues), biological implants or medical implants; implantable medicines; dietetic substances for medical use; dietetic substances for veterinary use; food for babies; dietetic preparations and food supplements; food supplements for animals; plasters, materials for dressings; compresses; teeth filling materials; dental impression materials; disinfectants; products for destroying vermin; fungicides; herbicides.

10 – Medical apparatus and instruments; applicators for medicines; medical implants; artificial surgical implants; holders for medical use; applicators for

pharmaceutical preparations; pumps for medical use for administering pharmaceutical products contained in receptacles; infusion pumps for administering medicines; injection devices for pharmaceutical products; surgical apparatus and instruments; cases fitted for medical instruments; suture materials; scalpels; knives for surgical purposes; surgical knives; scissors for surgery; knives for surgical use; cases fitted for use by doctors; containers especially made for medical waste; receptacles for applying medicines.

(260) AM 2018 94780 A

(800) 1371084

(151) 2017 05 22

(891) 2017 05 22

(731) Otkrytoe aktsionernoe obchtchestvo

"Borisovsky zavod meditsinskikh preparatov"

64 ul. Chapaeva 222518 Borisov, Minskaya

obl., Belarus

(54)



(591) Black and white

(531) 26.13.25; 27.05.01; 27.05.17

(511)

5 – Pharmaceutical and veterinary preparations; sanitary preparations for medical purposes; dietetic food and substances adapted for medical or veterinary use, food for babies; dietary supplements for humans and animals; plasters, materials for dressings; material for stopping teeth, dental wax; disinfectants; preparations for destroying vermin; fungicides, herbicides.

**საერთაშორისო სასაქონლო ნიშნები,
რომლებსაც მიენიჭათ დასვა საქართველოში**

(260) AM 2018 88867 A
(800) 1311245
(151) 2016 06 02
(181) 2026 06 02
(891) 2016 06 02
(511) 05

(891) 2016 10 24
(511) 09, 28

(260) AM 2018 90397 A
(800) 1135742
(151) 2012 07 03
(181) 2022 07 03
(891) 2016 12 16
(511) 09, 14

(260) AM 2018 91653 A
(800) 1337484
(151) 2016 11 30
(181) 2026 11 30
(891) 2016 11 30
(511) 05, 30, 35

(260) AM 2018 90704 A
(800) 1329277
(151) 2016 04 25
(181) 2026 04 25
(891) 2016 04 25
(511) 05, 10

(260) AM 2018 91654 A
(800) 1337503
(151) 2016 12 22
(181) 2026 12 22
(891) 2016 12 22
(511) 09, 10

(260) AM 2018 90707 A
(800) 1329398
(151) 2016 11 16
(181) 2026 11 16
(891) 2016 11 16
(511) 14

(260) AM 2018 91664 A
(800) 1337523
(151) 2016 12 19
(181) 2026 12 19
(891) 2016 12 19
(511) 18

(260) AM 2018 91122 A
(800) 1333019
(151) 2016 11 30
(181) 2026 11 30
(891) 2016 11 30
(511) 09, 14, 25

(260) AM 2018 91666 A
(800) 1337538
(151) 2016 08 29
(181) 2026 08 29
(891) 2016 08 29
(511) 05

(260) AM 2018 91313 A
(800) 1334981
(151) 2016 11 28
(181) 2026 11 28
(891) 2016 11 28
(511) 05, 10

(260) AM 2018 91669 A
(800) 1337547
(151) 2016 11 18
(181) 2026 11 18
(891) 2016 11 18
(511) 01

(260) AM 2018 91639 A
(800) 1337269
(151) 2016 10 24
(181) 2026 10 24

(260) AM 2018 91709 A
(800) 1337843
(151) 2017 01 17
(181) 2027 01 17
(891) 2017 01 17
(511) 05

(260) AM 2018 91712 A
 (800) 1337912
 (151) 2016 12 15
 (181) 2026 12 15
 (891) 2016 12 15
 (511) 03

(891) 2016 10 28
 (511) 03, 05

(260) AM 2018 91727 A
 (800) 1338046
 (151) 2016 12 19
 (181) 2026 12 19
 (891) 2016 12 19
 (511) 18, 25

(260) AM 2018 91784 A
 (800) 1339045
 (151) 2016 08 30
 (181) 2026 08 30
 (891) 2016 08 30
 (511) 29

(260) AM 2018 91765 A
 (800) 1339329
 (151) 2017 01 11
 (181) 2027 01 11
 (891) 2017 01 11
 (511) 31, 35, 44

(260) AM 2018 91785 A
 (800) 1339064
 (151) 2016 09 22
 (181) 2026 09 22
 (891) 2016 09 22
 (511) 03

(260) AM 2018 91766 A
 (800) 1339343
 (151) 2016 05 13
 (181) 2026 05 13
 (891) 2016 05 13
 (511) 07, 08, 12, 35, 37, 41

(260) AM 2018 91789 A
 (800) 1339180
 (151) 2017 01 24
 (181) 2027 01 24
 (891) 2017 01 24
 (511) 39

(260) AM 2018 91770 A
 (800) 1339015
 (151) 2016 12 30
 (181) 2026 12 30
 (891) 2016 12 30
 (511) 03

(260) AM 2018 91881 A
 (800) 1340729
 (151) 2016 09 29
 (181) 2026 09 29
 (891) 2016 09 29
 (511) 33

(260) AM 2018 91778 A
 (800) 1339393
 (151) 2016 11 14
 (181) 2026 11 14
 (891) 2016 11 14
 (511) 05

(260) AM 2018 91896 A
 (800) 1339907
 (151) 2017 01 09
 (181) 2027 01 09
 (891) 2017 01 09
 (511) 03, 05

(260) AM 2018 91779 A
 (800) 1339401
 (151) 2016 12 14
 (181) 2026 12 14
 (891) 2016 12 14
 (511) 09, 18, 25, 28

(260) AM 2018 91904 A
 (800) 1340939
 (151) 2016 05 25
 (181) 2026 05 25
 (891) 2016 05 25
 (511) 05, 10, 35, 36, 37, 42, 43, 44, 45

(260) AM 2018 91780 A
 (800) 1339404
 (151) 2016 10 28
 (181) 2026 10 28

(260) AM 2018 91905 A
 (800) 1340983
 (151) 2017 02 01
 (181) 2027 02 01
 (891) 2017 02 01
 (511) 12

(260) AM 2018 91907 A
 (800) 1339981
 (151) 2017 01 11
 (181) 2027 01 11
 (891) 2017 01 11
 (511) 09

(891) 2016 12 20
 (511) 09, 28

(260) AM 2018 91930 A
 (800) 1340137
 (151) 2016 12 21
 (181) 2026 12 21
 (891) 2016 12 21
 (511) 04, 37

(260) AM 2018 92003 A
 (800) 1341475
 (151) 2016 12 23
 (181) 2026 12 23
 (891) 2016 12 23
 (511) 09, 38, 41, 45

(260) AM 2018 91936 A
 (800) 1333211
 (151) 2016 07 15
 (181) 2026 07 15
 (891) 2017 04 03
 (511) 21, 33

(260) AM 2018 92034 A
 (800) 1341820
 (151) 2017 01 03
 (181) 2027 01 03
 (891) 2017 01 03
 (511) 04, 09, 39, 40

(260) AM 2018 91966 A
 (800) 1340487
 (151) 2015 12 21
 (181) 2025 12 21
 (891) 2015 12 21
 (511) 09

(260) AM 2018 92051 A
 (800) 1341330
 (151) 2016 11 08
 (181) 2026 11 08
 (891) 2016 11 08
 (511) 09, 38, 41

(260) AM 2018 91968 A
 (800) 1340505
 (151) 2016 10 24
 (181) 2026 10 24
 (891) 2016 10 24
 (511) 07

(260) AM 2018 92053 A
 (800) 1341337
 (151) 2016 12 27
 (181) 2026 12 27
 (891) 2016 12 27
 (511) 12

(260) AM 2018 91979 A
 (800) 1341893
 (151) 2016 09 15
 (181) 2026 09 15
 (891) 2016 09 15
 (511) 03, 05, 29, 35

(260) AM 2018 92054 A
 (800) 1341393
 (151) 2015 12 11
 (181) 2025 12 11
 (891) 2015 12 11
 (511) 18, 35

(260) AM 2018 91992 A
 (800) 1341074
 (151) 2016 03 16
 (181) 2026 03 16
 (891) 2016 03 16
 (511) 01

(260) AM 2018 92056 A
 (800) 1341921
 (151) 2017 01 04
 (181) 2027 01 04
 (891) 2017 01 04
 (511) 01, 02, 03

(260) AM 2018 91995 A
 (800) 1341099
 (151) 2016 12 20
 (181) 2026 12 20

(260) AM 2018 92060 A
 (800) 1341452
 (151) 2016 11 12
 (181) 2026 11 12
 (891) 2016 11 12
 (511) 01, 02, 19

(260) AM 2018 92061 A
 (800) 1341970
 (151) 2016 10 27
 (181) 2026 10 27
 (891) 2016 10 27
 (511) 25

(891) 2017 01 11
 (511) 01, 09

(260) AM 2018 92062 A
 (800) 1341462
 (151) 2016 08 08
 (181) 2026 08 08
 (891) 2016 08 08
 (511) 01, 02, 19

(260) AM 2018 92147 A
 (800) 1342293
 (151) 2016 11 23
 (181) 2026 11 23
 (891) 2016 11 23
 (511) 09

(260) AM 2018 92082 A
 (800) 1342159
 (151) 2017 01 23
 (181) 2027 01 23
 (891) 2017 01 23
 (511) 05

(260) AM 2018 92148 A
 (800) 1342312
 (151) 2017 02 20
 (181) 2027 02 20
 (891) 2017 02 20
 (511) 05

(260) AM 2018 92107 A
 (800) 1343124
 (151) 2016 06 17
 (181) 2026 06 17
 (891) 2016 06 17
 (511) 03, 09, 14, 18, 24, 25, 26, 35, 41, 45

(260) AM 2018 92150 A
 (800) 1342336
 (151) 2016 11 23
 (181) 2026 11 23
 (891) 2016 11 23
 (511) 09

(260) AM 2018 92131 A
 (800) 1342609
 (151) 2016 12 21
 (181) 2026 12 21
 (891) 2016 12 21
 (511) 04, 37

(260) AM 2018 92152 A
 (800) 1342363
 (151) 2017 01 23
 (181) 2027 01 23
 (891) 2017 01 23
 (511) 35, 36

(260) AM 2018 92133 A
 (800) 1342641
 (151) 2016 05 10
 (181) 2026 05 10
 (891) 2016 05 10
 (511) 06, 07, 11, 12, 14, 17, 19, 26, 40

(260) AM 2018 92153 A
 (800) 1342441
 (151) 2017 01 25
 (181) 2027 01 25
 (891) 2017 01 25
 (511) 09, 11, 37

(260) AM 2018 92134 A
 (800) 1342649
 (151) 2016 12 19
 (181) 2026 12 19
 (891) 2016 12 19
 (511) 18, 25

(260) AM 2018 92154 A
 (800) 1342454
 (151) 2016 12 22
 (181) 2026 12 22
 (891) 2016 12 22
 (511) 33

(260) AM 2018 92136 A
 (800) 1342669
 (151) 2017 01 11
 (181) 2027 01 11

(260) AM 2018 92162 A
 (800) 142345
 (151) 1949 07 07
 (181) 2019 07 07
 (891) 2017 04 18
 (511) 14

(260) AM 2018 92168 A
 (800) 607752
 (151) 1993 10 21
 (181) 2023 10 21
 (891) 2017 04 19
 (511) 05

(260) AM 2018 92170 A
 (800) 974513
 (151) 2008 07 10
 (181) 2018 07 10
 (891) 2017 04 07
 (511) 09

(260) AM 2018 92197 A
 (800) 1342796
 (151) 2016 09 23
 (181) 2026 09 23
 (891) 2016 09 23
 (511) 25, 28, 35, 41

(260) AM 2018 92278 A
 (800) 1344017
 (151) 2016 11 09
 (181) 2026 11 09
 (891) 2016 11 09
 (511) 12, 37

(260) AM 2018 92286 A
 (800) 1112929
 (151) 2012 02 20
 (181) 2022 02 20
 (891) 2017 03 07
 (511) 05

(260) AM 2018 92287 A
 (800) 1121414
 (151) 2012 03 25
 (181) 2022 03 25
 (891) 2017 04 23
 (511) 35

(260) AM 2018 92289 A
 (800) 1191718
 (151) 2014 01 09
 (181) 2024 01 09
 (891) 2017 04 24
 (511) 01, 05, 44

(260) AM 2018 92290 A
 (800) 1344056
 (151) 2017 02 14
 (181) 2027 02 14

(891) 2017 02 14
 (511) 05

(260) AM 2018 92291 A
 (800) 1242113
 (151) 2014 11 13
 (181) 2024 11 13
 (891) 2017 04 20
 (511) 11, 21

(260) AM 2018 92292 A
 (800) 1243780
 (151) 2014 12 22
 (181) 2024 12 22
 (891) 2017 01 30
 (511) 11, 30

(260) AM 2018 92293 A
 (800) 1344072
 (151) 2017 02 21
 (181) 2027 02 21
 (891) 2017 02 21
 (511) 12, 35, 39

(260) AM 2018 92294 A
 (800) 1248845
 (151) 2014 07 18
 (181) 2024 07 25
 (891) 2017 01 18
 (511) 18

(260) AM 2018 92295 A
 (800) 1262478
 (151) 2015 04 07
 (181) 2025 04 07
 (891) 2016 09 29
 (511) 09, 35, 39, 42

(260) AM 2018 92296 A
 (800) 1344080
 (151) 2017 01 25
 (181) 2027 01 25
 (891) 2017 01 25
 (511) 09, 11, 37

(260) AM 2018 92297 A
 (800) 1304467
 (151) 2016 04 08
 (181) 2026 04 08
 (891) 2017 01 13
 (511) 30

(260) AM 2018 92299 A
 (800) 1327865
 (151) 2015 10 15
 (181) 2026 10 15
 (891) 2017 01 17
 (511) 01, 02, 03, 06, 09, 11, 12

(891) 2016 12 13
 (511) 29

(260) AM 2018 92300 A
 (800) 1331134
 (151) 2017 11 24
 (181) 2026 11 24
 (891) 2016 03 16
 (511) 30

(260) AM 2018 92323 A
 (800) 1344308
 (151) 2017 03 08
 (181) 2027 03 08
 (891) 2017 03 08
 (511) 17

(260) AM 2018 92301 A
 (800) 1344105
 (151) 2017 03 06
 (181) 2027 03 06
 (891) 2017 03 06
 (511) 30

(260) AM 2018 92324 A
 (800) 1344314
 (151) 2017 03 10
 (181) 2027 03 10
 (891) 2017 03 10
 (511) 34

(260) AM 2018 92302 A
 (800) 1344108
 (151) 2017 03 21
 (181) 2027 03 21
 (891) 2017 03 21
 (511) 42

(260) AM 2018 92325 A
 (800) 1344333
 (151) 2016 12 05
 (181) 2026 12 05
 (891) 2016 12 05
 (511) 43

(260) AM 2018 92305 A
 (800) 1344128
 (151) 2016 09 29
 (181) 2026 09 29
 (891) 2016 09 29
 (511) 29, 30, 32

(260) AM 2018 92327 A
 (800) 1344416
 (151) 2016 12 20
 (181) 2026 12 20
 (891) 2016 12 20
 (511) 05

(260) AM 2018 92307 A
 (800) 1344135
 (151) 2016 12 20
 (181) 2026 12 20
 (891) 2016 12 20
 (511) 35, 42, 45

(260) AM 2018 92401 A
 (800) 1344717
 (151) 2017 02 14
 (181) 2027 02 14
 (891) 2017 02 14
 (511) 31

(260) AM 2018 92318 A
 (800) 1344195
 (151) 2016 10 25
 (181) 2026 10 25
 (891) 2016 10 25
 (511) 03

(260) AM 2018 92402 A
 (800) 1344870
 (151) 2017 01 27
 (181) 2027 01 27
 (891) 2017 01 27
 (511) 25

(260) AM 2018 92321 A
 (800) 1344209
 (151) 2016 12 13
 (181) 2026 12 13

(260) AM 2018 92405 A
 (800) 1344980
 (151) 2017 02 27
 (181) 2027 02 27
 (891) 2017 02 27
 (511) 14

(260) AM 2018 92409 A
(800) 1344749
(151) 2017 01 18
(181) 2027 01 18
(891) 2017 01 18
(511) 09

(260) AM 2018 92416 A
(800) 1345020
(151) 2017 01 20
(181) 2027 01 20
(891) 2017 01 20
(511) 30

(260) AM 2018 92417 A
(800) 1344840
(151) 2017 01 23
(181) 2027 01 23
(891) 2017 01 23
(511) 32

(260) AM 2018 92426 A
(800) 1345192
(151) 2017 02 24
(181) 2027 02 24
(891) 2017 02 24
(511) 03, 05

(260) AM 2018 92427 A
(800) 1345422
(151) 2016 04 20
(181) 2026 04 20
(891) 2016 04 20
(511) 07

(260) AM 2018 92428 A
(800) 1345437
(151) 2016 06 22
(181) 2026 05 18
(891) 2016 06 22
(511) 24, 35

(260) AM 2018 92429 A
(800) 1345195
(151) 2017 02 17
(181) 2026 02 17
(891) 2016 02 17
(511) 03

(260) AM 2018 92431 A
(800) 1345324
(151) 2016 07 29
(181) 2026 07 29

(891) 2016 07 29
(511) 10, 20

(260) AM 2018 92432 A
(800) 1345359
(151) 2017 01 18
(181) 2027 01 18
(891) 2017 01 18
(511) 05

(260) AM 2018 92433 A
(800) 1345521
(151) 2016 06 14
(181) 2026 06 14
(891) 2016 06 14
(511) 05

(260) AM 2018 92434 A
(800) 1345398
(151) 2017 02 23
(181) 2027 02 23
(891) 2017 02 23
(511) 10

(260) AM 2018 92443 A
(800) 882879
(151) 2006 02 28
(181) 2026 02 28
(891) 2017 03 02
(511) 09

(260) AM 2018 92448 A
(800) 1169975
(151) 2013 05 22
(181) 2023 05 22
(891) 2017 02 09
(511) 33

(260) AM 2018 92449 A
(800) 1220559
(151) 2014 05 13
(181) 2024 05 13
(891) 2017 05 04
(511) 09, 11, 37

(260) AM 2018 92451 A
(800) 1204756
(151) 2014 01 17
(181) 2024 01 17
(891) 2016 12 14
(511) 09, 16, 35, 39

(260) AM 2018 92454 A
 (800) 1232759
 (151) 2014 09 30
 (181) 2024 09 30
 (891) 2017 02 09
 (511) 09

(891) 2017 02 21
 (511) 09, 16, 41

(260) AM 2018 92512 A
 (800) 1346568
 (151) 2016 12 22
 (181) 2026 12 22
 (891) 2016 12 22
 (511) 05

(260) AM 2018 92532 A
 (800) 1345803
 (151) 2016 09 20
 (181) 2027 09 20
 (891) 2016 09 20
 (511) 33

(260) AM 2018 92513 A
 (800) 1346588
 (151) 2016 12 22
 (181) 2026 12 22
 (891) 2016 12 22
 (511) 42

(260) AM 2018 92533 A
 (800) 1345810
 (151) 2017 02 02
 (181) 2027 02 02
 (891) 2017 02 02
 (511) 09

(260) AM 2018 92524 A
 (800) 1345666
 (151) 2016 04 14
 (181) 2026 04 14
 (891) 2016 04 14
 (511) 18, 25, 35

(260) AM 2018 92546 A
 (800) 1346104
 (151) 2017 01 26
 (181) 2027 01 26
 (891) 2017 01 26
 (511) 03, 29, 30, 32, 33

(260) AM 2018 92526 A
 (800) 1345705
 (151) 2017 03 22
 (181) 2027 03 22
 (891) 2017 03 22
 (511) 30

(260) AM 2018 92547 A
 (800) 1346116
 (151) 2017 01 24
 (181) 2027 01 24
 (891) 2017 01 24
 (511) 03, 05, 10, 16, 24, 25

(260) AM 2018 92527 A
 (800) 1345709
 (151) 2017 03 20
 (181) 2027 03 20
 (891) 2017 03 20
 (511) 05

(260) AM 2018 92548 A
 (800) 1346122
 (151) 2017 02 07
 (181) 2027 02 07
 (891) 2017 02 07
 (511) 09

(260) AM 2018 92528 A
 (800) 1345710
 (151) 2017 03 20
 (181) 2027 03 20
 (891) 2017 03 20
 (511) 05

(260) AM 2018 92549 A
 (800) 1346123
 (151) 2017 02 07
 (181) 2027 02 07
 (891) 2017 02 07
 (511) 09

(260) AM 2018 92529 A
 (800) 1345728
 (151) 2017 02 21
 (181) 2027 02 21

(260) AM 2018 92551 A
 (800) 1346124
 (151) 2017 02 07
 (181) 2027 02 07
 (891) 2017 02 07
 (511) 09

(260) AM 2018 92555 A
 (800) 1345915
 (151) 2016 05 04
 (181) 2026 05 04
 (891) 2016 05 04
 (511) 03, 04, 06, 07, 09, 11, 12, 17, 20, 21, 22, 24,
 25, 28, 35

(260) AM 2018 92558 A
 (800) 1345937
 (151) 2017 02 09
 (181) 2027 02 09
 (891) 2017 02 09
 (511) 05

(260) AM 2018 92560 A
 (800) 1345952
 (151) 2016 11 07
 (181) 2026 11 07
 (891) 2016 11 07
 (511) 09, 12, 14, 16, 18, 20, 21, 24, 25, 28, 34

(260) AM 2018 92562 A
 (800) 1345973
 (151) 2017 02 07
 (181) 2027 02 07
 (891) 2017 02 07
 (511) 43

(260) AM 2018 92582 A
 (800) 1346227
 (151) 2017 02 24
 (181) 2027 02 24
 (891) 2017 02 24
 (511) 11

(260) AM 2018 92593 A
 (800) 1346310
 (151) 2017 01 12
 (181) 2027 01 12
 (891) 2017 01 12
 (511) 14

(260) AM 2018 92594 A
 (800) 1346345
 (151) 2017 03 16
 (181) 2027 03 16
 (891) 2017 03 16
 (511) 05

(260) AM 2018 92596 A
 (800) 1346347
 (151) 2017 03 29

(181) 2027 03 29
 (891) 2017 03 29
 (511) 03

(260) AM 2018 92597 A
 (800) 1346359
 (151) 2017 01 26
 (181) 2027 01 26
 (891) 2017 01 26
 (511) 05

(260) AM 2018 92598 A
 (800) 1346361
 (151) 2017 03 10
 (181) 2027 03 10
 (891) 2017 03 10
 (511) 03

(260) AM 2018 92609 A
 (800) 1346676
 (151) 2016 08 25
 (181) 2026 08 25
 (891) 2016 08 25
 (511) 03, 05, 16

(260) AM 2018 92614 A
 (800) 1346751
 (151) 2016 11 07
 (181) 2026 11 07
 (891) 2016 11 07
 (511) 01, 16, 17

(260) AM 2018 92630 A
 (800) 1347552
 (151) 2016 10 19
 (181) 2026 11 19
 (891) 2016 10 19
 (511) 09, 28

(260) AM 2018 92631 A
 (800) 1347582
 (151) 2017 02 23
 (181) 2027 02 23
 (891) 2017 02 23
 (511) 09

(260) AM 2018 92632 A
 (800) 1347609
 (151) 2017 03 21
 (181) 2027 03 21
 (891) 2017 03 21
 (511) 42

(260) AM 2018 92634 A
 (800) 1347615
 (151) 2017 04 04
 (181) 2027 04 04
 (891) 2017 04 04
 (511) 30

(891) 2016 12 21
 (511) 05, 10

(260) AM 2018 92636 A
 (800) 1347635
 (151) 2017 01 09
 (181) 2027 01 09
 (891) 2017 01 09
 (511) 03, 21

(260) AM 2018 92719 A
 (800) 1347306
 (151) 2017 01 23
 (181) 2027 01 23
 (891) 2017 01 23
 (511) 37

(260) AM 2018 92699 A
 (800) 1347235
 (151) 2017 01 24
 (181) 2027 01 24
 (891) 2017 01 24
 (511) 09, 11, 34, 35, 42

(260) AM 2018 92722 A
 (800) 1347320
 (151) 2017 01 18
 (181) 2027 01 18
 (891) 2017 01 18
 (511) 30

(260) AM 2018 92701 A
 (800) 1347250
 (151) 2017 03 17
 (181) 2027 03 17
 (891) 2017 03 17
 (511) 03, 09, 10, 16, 18, 25, 28, 35, 40, 42

(260) AM 2018 92832 A
 (800) 1348769
 (151) 2016 08 24
 (181) 2026 08 24
 (891) 2016 08 24
 (511) 05

(260) AM 2018 92702 A
 (800) 1347254
 (151) 2017 02 24
 (181) 2027 02 24
 (891) 2017 02 24
 (511) 11

(260) AM 2018 92833 A
 (800) 1348782
 (151) 2017 03 02
 (181) 2027 03 02
 (891) 2017 03 02
 (511) 05

(260) AM 2018 92703 A
 (800) 1347275
 (151) 2013 10 10
 (181) 2023 10 02
 (891) 2013 10 10
 (511) 01, 03, 05

(260) AM 2018 92841 A
 (800) 1349207
 (151) 2016 08 01
 (181) 2026 08 01
 (891) 2016 08 01
 (511) 09

(260) AM 2018 92714 A
 (800) 1347292
 (151) 2016 08 16
 (181) 2026 08 16
 (891) 2016 08 16
 (511) 07, 09, 11, 35

(260) AM 2018 92843 A
 (800) 1349217
 (151) 2016 10 11
 (181) 2026 10 11
 (891) 2016 10 11
 (511) 20, 28

(260) AM 2018 92718 A
 (800) 1347303
 (151) 2017 12 21
 (181) 2026 12 21

(260) AM 2018 92846 A
 (800) 1349237
 (151) 2016 11 03
 (181) 2026 11 03
 (891) 2016 11 03
 (511) 09, 28, 41

(260) AM 2018 92890 A
(800) 1348994
(151) 2017 03 16
(181) 2027 03 16
(891) 2017 03 16
(511) 06, 12, 36, 37, 39

(260) AM 2018 93051 A
(800) 1047863
(151) 2010 07 15
(181) 2020 07 15
(891) 2017 05 09
(511) 01, 02, 17, 19

(260) AM 2018 93052 A
(800) 1292204
(151) 2015 12 29
(181) 2025 12 29
(891) 2017 06 07
(511) 02, 16

(260) AM 2018 93184 A
(800) 1352637
(151) 2017 03 16
(181) 2027 03 16
(891) 2017 03 16
(511) 35, 43

(260) AM 2018 93186 A
(800) 1352656
(151) 2017 05 05
(181) 2027 05 05
(891) 2017 05 05
(511) 03

(260) AM 2018 93187 A
(800) 1352685
(151) 2016 06 16
(181) 2026 06 16
(891) 2016 06 16
(511) 12, 14, 16, 20, 21, 25, 28, 36, 37

(260) AM 2018 93188 A
(800) 1352698
(151) 2017 02 08
(181) 2027 02 08
(891) 2017 02 08
(511) 30

(260) AM 2018 93193 A
(800) 1352788
(151) 2016 11 03

(181) 2026 11 03
(891) 2016 11 03
(511) 25

(260) AM 2018 93194 A
(800) 1352796
(151) 2016 12 19
(181) 2026 12 19
(891) 2016 12 19
(511) 05

(260) AM 2018 93199 A
(800) 1352833
(151) 2017 03 29
(181) 2027 03 29
(891) 2017 03 29
(511) 09, 10

(260) AM 2018 93213 A
(800) 1212925
(151) 2014 07 02
(181) 2024 07 02
(891) 2017 03 16
(511) 33

(260) AM 2018 93215 A
(800) 1276693
(151) 2015 05 25
(181) 2025 05 25
(891) 2017 03 27
(511) 20

(260) AM 2018 93218 A
(800) 1339713
(151) 2017 01 17
(181) 2027 01 17
(891) 2017 05 03
(511) 09

საქონლის ადგილწარმოშობის დასახელება
რეგისტრირებული ადგილწარმოშობის დასახელება

(111) 975
(151) 2018 06 04
(540)

ხაშმის საშერაზი

(732) სსიპ „ღვინის ეროვნული სააგენტო“
მარშალ გელოვანის გამზ. 6, 0159,
თბილისი, საქართველო
(511) 33

ოფიციალური შეტყობინებები

გამოგონებები

პატენტების მოქმედების აღდგენა

(21) AP 2007 10444

(11) P 2010 5072 B

(73) შპს „კოორდინირებული რასპრედელიტელნი ცენტრ „ეფკო-კასკად“

(54) ოლეინის მჟავას მაღალი შემცველობის მქონე მზესუმზირის ზეთი და მისი მიღების ხერხი

პატენტი გაუქმებული იყო: 2017 12 19

პატენტის მოქმედების აღდგენის თარიღი: 2018 06 25

(21) AP 2008 11006

(11) P 2010 5094 B

(73) ვლადიმერ ტარასაშვილი

(54) ოპტიკური სიბნელის ბაპლიმერებისა და კორექციის კოლარიზაციულ კოლობრაფიული ხერხი

პატენტი გაუქმებული იყო: 2017 12 10

პატენტის მოქმედების აღდგენის თარიღი: 2018 06 25

(21) AP 2009 11600

(11) P 2011 5273 B

(73) თენგიზ გელაშვილი

(54) უკლინკერო ცემენტი

პატენტი გაუქმებული იყო: 2017 12 14

პატენტის მოქმედების აღდგენის თარიღი: 2018 06 25

(21) AP 2009 11601

(11) P 2011 5274 B

(73) თენგიზ გელაშვილი

(54) მცირეკლინკერიანი ცემენტი

პატენტი გაუქმებული იყო: 2017 12 14

პატენტის მოქმედების აღდგენის თარიღი: 2018 06 25

(21) AP 2012 12581

(11) P 2013 5895 B

(73) ცისანა სულაქველიძე;

ალექსანდრე სხირტლაძე;

ეთერ ქემერტელიძე

(54) ღიბიტონინის მიღების ხერხი

პატენტი გაუქმებული იყო: 2018 02 20

პატენტის მოქმედების აღდგენის თარიღი: 2018 06 25

(21) AP 2012 12911

(11) P 2014 6118 B

(73) თამთა კიკვაძე;

ლია ჟღენტი

(54) ნიადაგის ზედაპირიდან თხილის ამკრები მოწყობილობა
პატენტი გაუქმებული იყო: 2017 12 06
პატენტის მოქმედების აღდგენის თარიღი: 2018 06 25

(21) AP 2013 13081
(11) P 2014 6110 B
(73) ვახტანგ ასლანიკაშვილი
(54) მიწისქვეშა სარწყავი კვანძი
პატენტი გაუქმებული იყო: 2018 05 07
პატენტის მოქმედების აღდგენის თარიღი: 2018 06 25

(21) AP 2012 13272
(11) P 2016 6568 B
(73) პალუბა მედიკალ ლტდ
(54) ნევროლოგიური დარღვევების სამკურნალო კომპოზიციები
პატენტი გაუქმებული იყო: 2018 03 28
პატენტის მოქმედების აღდგენის თარიღი: 2018 06 25

(21) AP 2013 13578
(11) P 2018 6824 B
(73) სანტენ სას
(54) ზეთის ღისპერსია, მისი მიღების ხერხი, შეფუთვა და გორმშავას გამოყენება ზეთის
ღისპერსიის კონსერვაციის სტიმულატორის სახით
პატენტი გაუქმებული იყო: 2018 02 22
პატენტის მოქმედების აღდგენის თარიღი: 2018 06 25

(21) AP 2015 13750
(11) P 2016 6541 B
(73) სსიპ ფერდინანდ თავაძის მეტალურგიის და მასალათმცოდნეობის ინსტიტუტი
(54) ფხვნილოვანი ებზოთემრემული კაჟმებიდან არარობანული მასალების ნაკეთობების
მიღების ხერხი
პატენტი გაუქმებული იყო: 2018 03 04
პატენტის მოქმედების აღდგენის თარიღი: 2018 06 25

(21) AP 2015 13827
(11) P 2016 6565 B
(73) რუსუდან მაისურაძე;
გიორგი ნოზაძე;
ალექსანდრე ქართველიშვილი;
დავით პატარაია;
სსიპ გრიგოლ წულუკიძის სამთო ინსტიტუტი
(54) დახრილი საყრდენის საპირკველი
პატენტი გაუქმებული იყო: 2018 05 15
პატენტის მოქმედების აღდგენის თარიღი: 2018 06 25

(21) AP 2016 14105
(11) P 2017 6713 B
(73) გიორგი დოლაძე;
ირმა დარიბაშვილი;
შალვა დოლაძე;

ვახტანგ ლოლაძე;
ვლადიმერ ლოლაძე
(54) ლამიან, მცურავ და წყალნაჯერ ქვიშოვან ბრუნტაში მონოლითური კედლის
დაბეტონების ხერხი მეთოდით „კედელი ბრუნტში“
პატენტი გაუქმებული იყო: 2018 03 30
პატენტის მოქმედების აღდგენის თარიღი: 2018 06 25

(21) AP 2003 6780
(11) P 2005 3533 B
(73) რევაზ თოროზაშვილი;
ლამარა აივაზოვი;
ვაჟა კვალიაშვილი
(54) ვაშლის ალკოჰოლიანი სასმელის მასალისა და ვაშლის შემავსებელი ალკოჰოლიანი
სასმელის მასალის წარმოების ხერხი
პატენტი გაუქმებული იყო: 2018 01 21
პატენტის მოქმედების აღდგენის თარიღი: 2018 06 25

პატენტების გაუქმება

(21) AP 2007 10111
(11) P 2009 4643 B
(73) დევი ვასაძე
(54) საკაბელო კავშირბაგმულობის დისტანციურად მართვადი კომპლექსური სისტემა
პატენტის გაუქმების თარიღი: 2018 06 05
პატენტის მოქმედების აღდგენა შესაძლებელია: 2019 06 05-მდე

(21) AP 2006 10483
(11) P 2009 4787 B
(73) აზიენდე ქიმიჩე რიუნიტე ანჯელინი ფრანჩესკო ა.ც.რ.ა.ფ. ს.პ.ა.
(54) მადის დარღვევის სამკურნალო, 1 (3 ქლორფენილ) 3 ალკილპიპერაზინის შემცველი
წარმაცემი კომპოზიცია
პატენტის გაუქმების თარიღი: 2018 06 02
პატენტის მოქმედების აღდგენა შესაძლებელია: 2019 06 02-მდე

(21) AP 2007 11112
(11) P 2011 5166 B
(73) აზიენდე ქიმიჩე რიუნიტე ანჯელინი ფრანჩესკო ა.ც.რ.ა.ფ. ს.პ.ა.
(54) 2 არილინდოლის წარმოებულები, როგორც mPGES 1 ინჰიბიტორები
პატენტის გაუქმების თარიღი: 2018 06 14
პატენტის მოქმედების აღდგენა შესაძლებელია: 2019 06 14-მდე

(21) AP 2010 12512
(11) P 2015 6223 B
(73) ინტერმუნ ინკ.
(54) პირფენიდონის სინთეზის გაუმჯობესებული ხერხი
პატენტის გაუქმების თარიღი: 2018 06 02
პატენტის მოქმედების აღდგენა შესაძლებელია: 2019 06 02-მდე

(21) AP 2011 12941
(11) P 2015 6234 B
(73) ლე ლაბორატუარ სერვიე
(54) აბოიმელატინის უსაღელური ნაერთები და მათი მიღების ხერხი
პატენტის გაუქმების თარიღი: 2018 06 08
პატენტის მოქმედების აღღებნა შესაძლებელია: 2019 06 08-მდე

(21) AP 2014 13487
(11) P 2016 6427 B
(73) დალი ძანაშვილი;
ნათელა პაპუნაშვილი;
გიორგი მუძლაძე;
რევაზ კოსრეიძე;
ზურაბ ადამია;
ნიკოლოზ მარგიანი
(54) მაღალტემპერატურული ზეზამტარი კერამიკა
პატენტის გაუქმების თარიღი: 2018 06 05
პატენტის მოქმედების აღღებნა შესაძლებელია: 2019 06 05-მდე

(21) AP 2014 13488
(11) P 2016 6428 B
(73) დალი ძანაშვილი;
ნათელა პაპუნაშვილი;
გიორგი მუძლაძე;
რევაზ კოსრეიძე;
ზურაბ ადამია;
ნიკოლოზ მარგიანი
(54) მაღალტემპერატურული ზეზამტარი კერამიკა
პატენტის გაუქმების თარიღი: 2018 06 05
პატენტის მოქმედების აღღებნა შესაძლებელია: 2019 06 05-მდე

(21) AP 2015 13827
(11) P 2016 6565 B
(73) რუსუდან მაისურაძე;
გიორგი ნოზაძე;
ალექსანდრე ქართველიშვილი;
დავით პატარაია;
სსიპ გრიგოლ წულუკიძის სამთო ინსტიტუტი
(54) ღახრილი საჭრდენის საპირკველი
პატენტის გაუქმების თარიღი: 2018 05 15
პატენტის მოქმედების აღღებნა შესაძლებელია: 2019 05 15-მდე

(21) AP 2015 13835
(11) P 2016 6512 B
(73) ზაურ ბერიშვილი
(54) პლანარული მახინტრონული გაფრქვევის მოწყობილობა
პატენტის გაუქმების თარიღი: 2018 05 28
პატენტის მოქმედების აღღებნა შესაძლებელია: 2019 05 28-მდე

(21) AP 2000 5632
(11) P 2002 2750 B
(73) ესიფარმს

(54) სფეროიდების სახის მქონე მრავალკომპონენტიანი წარმაცვებზე პრეპარატი
და მისი მიღების ხერხი
პატენტის გაუქმების თარიღი: 2018 05 20
პატენტის მოქმედების აღღებნა შესაძლებელია: 2019 05 20-მდე

(21) AP 2000 5634
(11) P 2003 3119 B
(73) აგენტის ფარმა ს.ა
(54) ახალი ოქტაჰიდრო 6,10 დიოქსო 6H პირიდინო[1,2-a][1,2] დიაზეპინ 1 კარბონმჟავას
წარმოვებელი, მათი მიღების ხერხი და გამოყენება
პატენტის გაუქმების თარიღი: 2018 04 26
პატენტის მოქმედების აღღებნა შესაძლებელია: 2019 04 26-მდე

(21) AP 2000 5678
(11) P 2003 2987 B
(73) უორნერ ლამბერტ კომპანი
(54) ბამა ამინოვარდობის წარმოვებების შემცველი სტაბილიზებული მჟავა
წარმაცვებზე კომპოზიცია ნეიტროპათოლოგიური დაავადებების სამკურნალოდ
და მისი მიღების ხერხი
პატენტის გაუქმების თარიღი: 2018 05 10
პატენტის მოქმედების აღღებნა შესაძლებელია: 2019 05 10-მდე

(21) AP 2002 6674
(11) P 2006 3796 B
(73) ლე ლაბორატუარ სერვიერ
(54) N [(S) 1 კარბოქსიზუთილ] (S) ალანინის ეთერების სინთეზის ხერხი და მათი გამოყენება
პერინდოპრილის სინთეზში
პატენტის გაუქმების თარიღი: 2018 03 30
პატენტის მოქმედების აღღებნა შესაძლებელია: 2019 03 30-მდე

(21) AP 2003 7204
(11) P 2006 3810 B
(73) ბრფ ს.ა.
(54) დიეტური ბოჭკოების შემცველი საკვები კომპოზიცია და მისი გამოყენება საკვებო
პროდუქტების დასამზადებლად
პატენტის გაუქმების თარიღი: 2018 05 29
პატენტის მოქმედების აღღებნა შესაძლებელია: 2019 05 29-მდე

(21) AP 2003 8531
(11) P 2007 4046 B
(73) ინტერდიჯიტალ ტექნოლოჯი კორპორეიშენ
(54) მომხმარებლის მოწყობილობის საიდენტიფიკაციო სპეციფიკური სპრემბლირების
კოდის ბენეფიციარია მალაუნის მარტივი საერთო გამოყენების მართვის არხებისათვის
პატენტის გაუქმების თარიღი: 2018 05 05
პატენტის მოქმედების აღღებნა შესაძლებელია: 2019 05 05-მდე

სასარგებლო მოდელები

პატენტების მოქმედების აღდგენა

(21) AU 2011 12225
(11) U 2012 1714 Y
(73) გურამ ბერაია
(54) აკუმულატორის ავტონომიური სამუშაოში მოწყობილობა
პატენტი გაუქმებული იყო: 2018 05 17
პატენტის მოქმედების აღდგენის თარიღი: 2018 06 25

(21) AU 2012 12702
(11) U 2013 1759 Y
(73) ნუგზარ მელაძე
(54) ჰელიოლანდობარი ცხელი წყლით მომარაგებისთვის
პატენტი გაუქმებული იყო: 2018 05 07
პატენტის მოქმედების აღდგენის თარიღი: 2018 06 25

(21) AU 2013 12969
(11) U 2014 1812 Y
(73) ეთერ ქემერტელიძე;
მერი ალანია
(54) რობინინის მიღების ხერხი
პატენტი გაუქმებული იყო: 2018 01 17
პატენტის მოქმედების აღდგენის თარიღი: 2018 06 25

პატენტების გაუქმება

(21) AU 2011 12260
(11) U 2013 1764 Y
(73) კარინა გვერდწითელი;
თენგიზ სანაძე;
გიორგი გურგენიძე;
მიხეილ გვერდწითელი
(54) სატრანსპორტო საშუალების მომსახურების საფასურის გადახდის მოწყობილობა
პატენტის გაუქმების თარიღი: 2018 06 10
მოქმედების აღდგენის შესაძლებლობა: 2019 06 10-მდე

(21) AU 2013 13116
(11) U 2014 1805 Y
(73) ზურაბ მურღული
(54) სისტემა აუსკულტაციისათვის
პატენტის გაუქმების თარიღი: 2018 06 11
მოქმედების აღდგენის შესაძლებლობა: 2019 06 11-მდე

(21) AU 2015 13830

(11) U 2017 1922 Y

(73) რივა ლიპარტელიანი;
ნანული ხოტენაშვილი;
შალვა პაპავა;
ეთერ გავაშელიძე;
ვიტალი შეროზია;
ნუნუ მაისურაძე;
ნორა დოხტურიშვილი;
ნაზი გელაშვილი;
ია ჩიტრეკაშვილი;
ელდარ გუგავა;
მარინე გურგენიშვილი;
გივი პაპავა

(54) პროლონგირებული მოქმედების პოლიმერული ანოტოვანი სასუქის მიღების ხერხი
პატენტის გაუქმების თარიღი: 2018 05 20
მოქმედების მოქმედების აღდგენა შესაძლებელია: 2019 05 20-მდე

(21) AU 2015 13851

(11) U 2017 1933 Y

(73) თამაზ კუჭავა

(54) თმის საკრეპი ინსტრუმენტი

პატენტის გაუქმების თარიღი: 2018 06 09

მოქმედების მოქმედების აღდგენა შესაძლებელია: 2019 06 09-მდე

(21) AU 2016 14121

(11) U 2017 1937 Y

(73) შალვა ბიჭიაშვილი

(54) მცენარეთა ფიზიოლოგიური მდგომარეობის განსაზღვრის ხერხი

პატენტის გაუქმების თარიღი: 2018 04 19

მოქმედების მოქმედების აღდგენა შესაძლებელია: 2019 04 19-მდე

(21) AU 2016 14127

(11) U 2017 1930 Y

(73) ზინაიდა ვაწაძე;

ჟიული ქებაძე;

თეიმურაზ როყვა;

თემურ ჩახუნაშვილი

(54) სარეაქციო აპარატი მაღალი აბრეშქვების მქონე ხსნარებში ძირითადი პროცესების
ჩასატარებლად

პატენტის გაუქმების თარიღი: 2018 04 27

მოქმედების მოქმედების აღდგენა შესაძლებელია: 2019 04 27-მდე

(21) AU 2016 14128

(11) U 2017 1957 Y

(73) თამარ კვერნაძე;

ნანა ოსიპოვა;

გივი ჩიმაკაძე;

ეთერ ხალუქვაძე;

ლეილა ჯაფარიძე;

სპარტაკ უროტაძე;

ციალა გაბელია

(54) ცხოველთა ლითონდუფიციტური ანემიის კომპოზიციური პროფილაქტიკურ სამკურნალო საშუალება
პატენტის გაუქმების თარიღი: 2018 04 27
მოქმედის მოქმედების აღდგენა შესაძლებელია: 2019 04 27-მდე

დიზაინები

რეგისტრაციის მოქმედების გაბრძნობა

(11) D 2013 558 S
(73) შპს „აისი“ (GE)
ი. ევლოშვილის ქ. 37, გურჯაანი, 1500, საქართველო (GE)
(54) ბრავიკოპული კომპონანცია, ბრავიკოპული სიმბოლო
(28) 2
(24) 2013 04 05
(18) 2023 04 05
(58) 2018 06 07

(11) D 2014 568 S
(73) დიმიტრი ლომინაძე (GE)
მ. კოსტავას I შეს. 21, 0179, თბილისი, საქართველო (GE)
შალვა კანდელაკი (GE)
განათლების ქ. 1ა, 4600, ქუთაისი, საქართველო (GE)
არჩილ ღალანიაძე (GE)
ნუცუბიძის IV მკრ., კორპ. 14, ბ. 42, 0183, თბილისი, საქართველო (GE)
(54) სწრაფააღებადი ნახშირი
(28) 2
(24) 2013 08 05
(18) 2023 08 05
(58) 2018 06 11

(11) D 2013 563 S
(73) ნიკოლოზ ბახია (GE)
დიმიტრი ბაქრაძის ქ. 16, 0119, თბილისი, საქართველო (GE)
(54) ლობო
(28) 1
(24) 2013 08 26
(18) 2023 08 26
(58) 2018 06 15

რეგისტრაციის განხილვა

(რეგისტრაციის მოქმედების აღდგენა შესაძლებელია მოქმედების ვადის ამოწურვიდან 6 თვის ვადაში)

(11) P 2008 367 B

(73) სს „წყალი მარგებელი“ (GE)

სოფ. ნაბეღლაგი, 4900, ჩოხატაურის რ-ნი, საქართველო (GE)

(54) **ბოთლი**

(18) 2018 04 18

(58) 2018 06 07

(11) P 2013 565 B

(73) მამუკა მაჭარაშვილი (GE)

ლ. ლაგურაშვილის ქ. 5/13, 0179, თბილისი, საქართველო (GE)

(54) **პარტოზილის ხრაშუნა ხვეულა**

(18) 2018 04 01

(58) 2018 06 07

(11) P 2013 557 B

(73) ლევან ბერიშვილი (GE)

გლდანის მას., IIIა მკრ., კორპ. 15, ბ. 25, 0167, თბილისი, საქართველო (GE)

(54) **ნიჟარა**

(18) 2018 04 03

(58) 2018 06 11

(11) P 2013 559 B

(73) დავით შამირიძე (GE)

მარტყოფის შეს. 12, 0103, თბილისი, საქართველო (GE)

(54) **საფუთავი**

(18) 2018 04 18

(58) 2018 06 07

(11) P 2013 562 B

(73) დავით დონაძე (GE)

პეკინის ქ. 9, ბ. 34, 0160, თბილისი, საქართველო (GE)

(54) **სასმისი**

(18) 2018 05 29

(58) 2018 06 11

მოქონალური შეტყობინებები

სასაქონლო ნიშნები

რეგისტრაციის მოქმედების ვადის გაგრძელება

(111) M 1997 7652 R2

(156) 1997 11 21

(186) 2027 11 21

(732) კანსონი

67 რიუ ლუი ე ლორენ სეგუენი, 07100
ანონაი, საფრანგეთი

(111) M 1998 10495 R2

(156) 1998 08 26

(186) 2028 08 26

(732) ემი (იპ) ლიმიტიდ

364-366 კენსინგტონ ჰაი სტრიტი, ლონ-
დონი W14 8NS, გაერთიანებული სამეფო

(111) M 1997 7694 R2

(156) 1997 11 24

(186) 2027 11 24

(732) კანსონი

67 რიუ ლუი ე ლორენ სეგუენი, 07100
ანონაი, საფრანგეთი

(111) M 1998 8339 R2

(156) 1998 02 16

(186) 2028 02 16

(732) ფუჯიციუ ჯენერალ ლიმიტიდ

3-3-17, სუენაგა ტაკაცუ-კუ, კავასაკი
213-8502, იაპონია

(111) M 1997 7695 R2

(156) 1997 11 24

(186) 2027 11 24

(732) კანსონი

67 რიუ ლუი ე ლორენ სეგუენი, 07100
ანონაი, საფრანგეთი

(111) M 1998 9177 R2

(156) 1998 05 04

(186) 2028 05 04

(732) პპ ინდასტრიზ ოპაიო, ინკ.

3800 უესტ 143-ე სტრიტი, კლიფლენდი,
ოჰაიო 44111, აშშ

(111) M 1997 7696 R2

(156) 1997 11 24

(186) 2027 11 24

(732) კანსონი

67 რიუ ლუი ე ლორენ სეგუენი, 07100
ანონაი, საფრანგეთი

(111) M 1998 9213 R2

(156) 1998 05 05

(186) 2028 05 05

(732) ბრიტიშ ამერიკენ ტობაკო ვესტერნ

იუროპ კომერშელ ტრეიდინგ ლიმიტიდ
გლობ ჰაუსი, 1 უოტერ სტრიტი, ლონდონ-
ნი, WC2R 3LA, გაერთიანებული სამეფო

(111) M 1997 7699 R2

(156) 1997 11 24

(186) 2027 11 24

(732) ემი (იპ) ლიმიტიდ

364-366 კენსინგტონ ჰაი სტრიტი, ლონ-
დონი W14 8NS, გაერთიანებული სამეფო

(111) M 1998 9044 R2

(156) 1998 04 29

(186) 2028 04 29

(732) დოიჩე ტელეკომ აგ

ფრიდრიხ-ებერტ-ალეე 140, 53113 ბონი,
გერმანია

(111) M 1998 10494 R2

(156) 1998 08 26

(186) 2028 08 26

(732) ემი (იპ) ლიმიტიდ

364-366 კენსინგტონ ჰაი სტრიტი,
ლონდონი W14 8NS, გაერთიანებული
სამეფო

(111) M 1997 6580 R2

(156) 1997 09 01

(186) 2027 09 01

(732) პონგტა ტობაკო (გრუპ) კო., ლტდ

პონგტაშანი, იუქსი, იუნანის პროვინცია,
ჩინეთი

(111) M 1997 6708 R2
 (156) 1997 09 08
 (186) 2027 09 08
 (732) ჰონგტა ტობაკო (გრუპ) კო., ლტდ
 ჰონგტაშანი, იუქსი, იუნანის პროვინცია,
 ჩინეთი

(111) M 1998 9076 R2
 (156) 1998 04 29
 (186) 2028 04 29
 (732) ორიონ კორპორეიშენ
 13, ბეკობო-რო 90და-გილ, იონგსან-გუ,
 სეული, კორეის რესპუბლიკა

(111) M 1997 6709 R2
 (156) 1997 09 08
 (186) 2027 09 08
 (732) ჰონგტა ტობაკო (გრუპ) კო., ლტდ
 ჰონგტაშანი, იუქსი, იუნანის პროვინცია,
 ჩინეთი

(111) M 1998 9077 R2
 (156) 1998 04 29
 (186) 2028 04 29
 (732) ორიონ კორპორეიშენ
 13, ბეკობო-რო 90და-გილ, იონგსან-გუ,
 სეული, კორეის რესპუბლიკა

(111) M 1997 6710 R2
 (156) 1997 09 08
 (186) 2027 09 08
 (732) ჰონგტა ტობაკო (გრუპ) კო., ლტდ
 ჰონგტაშანი, იუქსი, იუნანის პროვინცია,
 ჩინეთი

(111) M 1998 9087 R2
 (156) 1998 04 30
 (186) 2028 04 30
 (732) ოლინგესტ (ნიდერლანდზ) ბ.გ.
 WTS ბილდინგ, პრინსიზ
 მარგრიტპლანტსუნ 92, 2595 BR ჰააგა,
 ნიდერლანდები

(111) M 1997 6811 R2
 (156) 1997 09 17
 (186) 2027 09 17
 (732) კალიუმეტ ბრენდიდ პროდაქტს,
 ელ.ელ.სი., დელავერის შეზღუდული
 პასუხისმგებლობის კომპანია
 2780 უოტერფრანტ პარკევი ისტ დრაივი,
 სუიტ 200, ინდიანაპოლისი, ინდიანა
 46214, აშშ

(111) M 1998 9946 R2
 (156) 1998 07 07
 (186) 2028 07 07
 (732) ალტეკო ქემიკალ პტი ლტდ
 19, ტუას ავენიუ 11, სინგაპური 639084,
 სინგაპური

(111) M 1998 9054 R2
 (156) 1998 04 29
 (186) 2028 04 29
 (732) ფეროსან ა/ს
 ლოტრუპენგ 8, DK-2750 ბალერუპი,
 დანია

(111) M 1998 9947 R2
 (156) 1998 07 07
 (186) 2028 07 07
 (732) ალტეკო ქემიკალ პტი ლტდ
 19, ტუას ავენიუ 11, სინგაპური 639084,
 სინგაპური

(111) M 1998 9071 R2
 (156) 1998 04 29
 (186) 2028 04 29
 (732) ფეროსან ა/ს
 ლოტრუპენგ 8, DK-2750 ბალერუპი,
 დანია

(111) M 1998 9948 R2
 (156) 1998 07 07
 (186) 2028 07 07
 (732) ალტეკო ქემიკალ პტი ლტდ
 19, ტუას ავენიუ 11, სინგაპური 639084,
 სინგაპური

(111) M 1998 9075 R2
 (156) 1998 04 29
 (186) 2028 04 29
 (732) ორიონ კორპორეიშენ
 13, ბეკობო-რო 90და-გილ, იონგსან-გუ,
 სეული, კორეის რესპუბლიკა

(111) M 1998 10914 R2
 (156) 1998 09 23
 (186) 2028 09 23
 (732) ემი (იპ) ლიმიტიდ
 364-366 კენსინგტონ ჰაი სტრიტი,
 ლონდონი W14 8NS, გაერთიანებული
 სამეფო

(111) M 1998 10915 R2

(156) 1998 09 23

(186) 2028 09 23

(732) ემი (იპ) ლიმიტიდ
364-366 კენსინგტონ ჰაი სტრიტი,
ლონდონი W14 8NS, გაერთიანებული
სამეფო

(111) M 1998 10916 R2

(156) 1998 09 23

(186) 2028 09 23

(732) ემი (იპ) ლიმიტიდ
364-366 კენსინგტონ ჰაი სტრიტი,
ლონდონი W14 8NS, გაერთიანებული
სამეფო

(111) M 1997 7511 R2

(156) 1997 11 14

(186) 2027 11 14

(732) ვენგარდ ტრეიდმარკ ჰოლდინგზ უსა
ლლკ
600 კორპორეიტ პარკ დრაივი, სტ.
ლუისი, მისური 63105, აშშ

(111) M 1998 8303 R2

(156) 1998 02 10

(186) 2028 02 10

(732) ლორენც სნეკ-უორლდ ჰოლდინგ გმბჰ
ადელჰაიდშტრასე 4/5, 30171 ჰანოვერი,
გერმანია

(111) M 2008 18409 R1

(156) 2008 05 01

(186) 2028 05 01

(732) სან ლაბორატორის ფზე
საიფ პლუს R5-30/B საფოსტო ყუთი:
7818 შარჯა, არაბთა გაერთიანებული
სამხრეთი

(111) M 2008 18437 R1

(156) 2008 05 16

(186) 2028 05 16

(732) ბრიტიშ ამერიკენ ტობაკო ვესტერნ
იუროპ კომერშელ ტრეიდინგ ლიმიტიდ
გლობ ჰაუზი, 1 უოტერ სტრიტი,
ლონდონი, WC2R 3LA, გაერთიანებული
სამეფო

(111) M 2008 18364 R1

(156) 2008 04 14

(186) 2028 04 14

(732) ონი ბაიოტეკ ინკ.

ბეირდ რისერჩ პარკი, 1576 სვიტჰოუმ
როუდი, ამჰერსტი, ნიუ-იორკი 14228, აშშ

(111) M 2008 18341 R1

(156) 2008 03 27

(186) 2028 03 27

(732) ასტექს ფარმასეუტიკალს, ინკ.
4420 როუზვედ დრაივი, სუიტ 200
პლიზენტონი, კალიფორნია 94588, აშშ

(111) M 2008 18389 R1

(156) 2008 04 29

(186) 2028 04 29

(732) შპს „შაბო-ჯორჯია“
ილ. ჭავჭავაძის გამზ. 2913, 0179,
თბილისი, საქართველო;
ელდარ იუკურიძე
ქუკოვსკის ქ.19, ბ. 9, ოდესა, უკრაინა

(111) M 2008 18490 R1

(156) 2008 05 27

(186) 2028 05 27

(732) რომა სისტემზ, ინკ., დელავერის
კორპორაცია
11315 კორპორეიტ ბულვარ სუიტ 100,
ორლანდო, ფლორიდა 32817, აშშ

(111) M 2008 18599 R1

(156) 2008 07 11

(186) 2028 07 11

(732) მეიჯი სეიკა ფარმა კო., ლტდ.
4-16, კიობაში 2-ჩომე, ჩუო-კუ, ტოკიო,
იაპონია

(111) M 1998 10179 R2

(156) 1998 08 05

(186) 2028 08 05

(732) სალომონ ს.ა.ს.
დე კრუასდე, 74370 მეს-ტესი,
საფრანგეთი

(111) M 1997 7853 R2

(156) 1997 12 15

(186) 2027 12 15

(732) ფრატელი ბრანკა დისტრიბუტორი
ს.რ.დ.
ვია ბროლეტო 35, I-20121 მილანი,
იტალია

(111) M 1998 9313 R2
(156) 1998 05 13
(186) 2028 05 13
(732) როიალ კანინ სას
650 ავენიუ დე ლა პეტიტ კამარგი,
F-30470 ემარგი, საფრანგეთი

(111) M 1998 8547 R2
(156) 1998 03 05
(186) 2028 03 05
(732) ორიონ პიკერზ კორპორეიშენ
245 ნორთ ბევერლი დრაივი, ბევერლი
ჰილზი, CA 90210, აშშ

(111) M 1998 8468 R2
(156) 1998 02 27
(186) 2028 02 27
(732) ფიშერვერკე გმპ & კო. კგ
კლაუს-ფიშერ-სტრ. 1, 72178
ვალდასტელი, გერმანია

(111) M 1998 9328 R2
(156) 1998 05 14
(186) 2028 05 14
(732) პომერი
5, პლას დიუ ქენერალ გურო, 51100
რეიმსი, საფრანგეთი

(111) M 1998 9329 R2
(156) 1998 05 14
(186) 2028 05 14
(732) პომერი
5, პლას დიუ ქენერალ გურო, 51100
რეიმსი, საფრანგეთი

(111) M 1998 8058 R2
(156) 1998 01 15
(186) 2028 01 15
(732) ზე პოლო/ლორენ კომპანი, ლ.პ.
650 მედისონ ავენიუ, ნიუ-იორკი,
ნიუ-იორკი 10022, აშშ

(111) M 1998 8059 R2
(156) 1998 01 15
(186) 2028 01 15
(732) ზე პოლო/ლორენ კომპანი, ლ.პ.
650 მედისონ ავენიუ, ნიუ-იორკი,
ნიუ-იორკი 10022, აშშ

(111) M 1998 8060 R2
(156) 1998 01 15
(186) 2028 01 15
(732) ზე პოლო/ლორენ კომპანი, ლ.პ.
650 მედისონ ავენიუ, ნიუ-იორკი,
ნიუ-იორკი 10022, აშშ

უფლებების სრული ბაღასემა

(111) M 1998 8875 R
(732) ბელ-რეი კომპანი
ელ.ელ.სი. ნიუ-ჯერსის შეზღუდული
პასუხისმგებლობის კომპანია
პ.ო. ბოქს 526 ფარმინგდეილი,
ნიუ-ჯერსი 07727, აშშ
(770) ბელ-რეი კომპანი ინკ.
1201 ბოუმენ ავენიუ უოლი, ნიუ-ჯერსი
07719, აშშ
(580) 2018 04 16

(111) M 1998 8875 R
(732) ბელ-რეი კომპანი
ელ.ელ.სი., დელავერის შეზღუდული
პასუხისმგებლობის კომპანია
პ.ო. ბოქს 526 ფარმინგდეილი,
ნიუ-ჯერსი 07727, აშშ
(770) ბელ-რეი კომპანი ელ.ელ.სი.
ნიუ-ჯერსის შეზღუდული პასუხისმგებ-
ლობის კომპანია
პ.ო. ბოქს 526 ფარმინგდეილი,
ნიუ-ჯერსი 07727, აშშ
(580) 2018 04 16

(111) M 1998 8875 R
(732) კალიუმეტ ბრენდიდ პროდაქტს,
ელ.ელ.სი., დელავერის შეზღუდული
პასუხისმგებლობის კომპანია
2780 უოტერფრანტ პარკევი ისტ დრაივი,
სუიტ 200, ინდიანაპოლისი, ინდიანა
46214, აშშ
(770) ბელ-რეი კომპანი, ელ.ელ.სი.
დელავერის შეზღუდული
პასუხისმგებლობის კომპანია
პ.ო. ბოქს 526 ფარმინგდეილი, ნიუ-ჯერსი
07727, აშშ
(580) 2018 04 16

(111) M 1997 6811 R
(732) ბელ-რეი კომპანი
ელ.ელ.სი. ნიუ-ჯერსის შეზღუდული
პასუხისმგებლობის კომპანია
პ.ო. ბოქს 526 ფარმინგდეილი,
ნიუ-ჯერსი 07727, აშშ
(770) ბელ-რეი კომპანი, ინკ.
1201 ბოუმენ ავენიუ უოლი, ნიუ-ჯერსი
07719, აშშ
(580) 2018 04 16

(111) M 1997 6811 R
(732) ბელ-რეი კომპანი
ელ.ელ.სი. დელავერის შეზღუდული
პასუხისმგებლობის კომპანია
პ.ო. ბოქს 526 ფარმინგდეილი,
ნიუ-ჯერსი 07727, აშშ
(770) ბელ-რეი კომპანი ელ.ელ.სი.
ნიუ-ჯერსის შეზღუდული პასუხისმგებ-
ლობის კომპანია
პ.ო. ბოქს 526 ფარმინგდეილი,
ნიუ-ჯერსი 07727, აშშ
(580) 2018 03 12

(111) M 1997 6811 R
(732) კალიუმეტ ბრენდიდ პროდაქტს,
ელ.ელ.სი., დელავერის შეზღუდული
პასუხისმგებლობის კომპანია
2780 უოტერფრანტ პარკევი ისტ დრაივი,
სუიტ 200, ინდიანაპოლისი, ინდიანა
46214, აშშ
(770) ბელ-რეი კომპანი ელ.ელ.სი.
დელავერის შეზღუდული პასუხისმგებ-
ლობის კომპანია
პ.ო. ბოქს 526 ფარმინგდეილი, ნიუ-ჯერსი
07727, აშშ
(580) 2018 03 12

(111) M 1998 9597 R
(732) გლაქსო გრუპ ლიმიტიდ
980 გრიტ უესტ როუდი, ბრენტფორდი,
მიდლსექსი TW8 9GS, გაერთიანებული
სამეფო;
ასპენ გლობალ ინკორპორეტიდ
ჯბს პლაზა, კორნერ ლა სალენტი &
როიად როუდსი, გრენდ ბეი, მავრიკი
(770) გლაქსო გრუპ ლიმიტიდ
980 გრიტ უესტ როუდი, ბრენტფორდი,
მიდლსექსი TW8 9GS, გაერთიანებული
სამეფო
(580) 2018 05 23

(111) M 2007 17818 R
(732) უნილვეერ ნ.ვ.
ვეენა 455, 3013 AL როტერდამი,
ნიდერლანდები
(770) სტარბაკს კორპორეი შენ მოლვაწე
როგორც სტარბაკს კოფი კომპანი
(ვაშინგტონის შტატის კორპორაცია)
2401 იუტა ავენიუ საუთი, სიეტლი,

ვაშინგტონი 98134, აშშ
(580) 2018 04 20

გიორგი ჭანტურიას ქ. 6, 1400, გორი,
საქართველო
(580) 2018 04 05

(111) M 2008 18827 R
(732) შპს „პრესტიჟი“
პეტრე სარაჯიშვილის ქ. 17ა, თბილისი,
საქართველო
(770) პაატა გიგაური
ლარსის ქ. 1, 0179, თბილისი, საქართველო;
გიორგი მედულაშვილი
კეკელიძის ქ. 8, ბ. 9, 0179, თბილისი,
საქართველო;
ნინო შისაშვილი
კეკელიძის ქ. 8, ბ. 9, 0179, თბილისი,
საქართველო;
ლევან მარგველაშვილი
ფალიაშვილის ქ. 72, ბ. 31, 0179,
თბილისი, საქართველო
(580) 2018 05 02

(111) M 2009 19037 R
(732) შპს „გორელი“
შინდისის გზატ. მე-2 კმ., 1400, გორი,
საქართველო
(770) გიორგი გოგიჩაიშვილი
გიორგი ჭანტურიას ქ. 6, 1400, გორი,
საქართველო
(580) 2018 03 23

(111) M 2009 19032 R
(732) შპს „გორელი“
შინდისის გზატ. მე-2 კმ., 1400, გორი,
საქართველო
(770) გიორგი გოგიჩაიშვილი
გიორგი ჭანტურიას ქ. 6, 1400, გორი,
საქართველო
(580) 2018 03 23

(111) M 2009 19533 R
(732) შპს „პრესტიჟი“
პეტრე სარაჯიშვილის ქ. 17ა, თბილისი,
საქართველო
(770) პაატა გიგაური
ლარსის ქ. 1, 0179, თბილისი, საქართველო;
გიორგი მედულაშვილი
კეკელიძის ქ. 8, ბ. 9, 0179, თბილისი,
საქართველო;
ნინო შისაშვილი
კეკელიძის ქ. 8, ბ. 9, 0179, თბილისი,
საქართველო
(580) 2018 05 25

(111) M 2009 19033 R
(732) შპს „გორელი“
შინდისის გზატ. მე-2 კმ., 1400, გორი,
საქართველო
(770) გიორგი გოგიჩაიშვილი
გიორგი ჭანტურიას ქ. 6, 1400, გორი,
საქართველო
(580) 2018 03 23

(111) M 2013 23868 R
(732) ბადრი ბაგათელია
ირ. აბაშიძის ქ. 70, ბ. 73, 0162, თბილისი,
საქართველო;
რამაზ ხარებავა
სენაკი, საქართველო
(770) ბადრი ბაგათელია
ირ. აბაშიძის ქ. 24, ბ. 26, 0179, თბილისი,
საქართველო
(580) 2018 02 01

(111) M 2009 19035 R
(732) შპს „გორელი“
შინდისის გზატ. მე-2 კმ., 1400, გორი,
საქართველო
(770) გიორგი გოგიჩაიშვილი
გიორგი ჭანტურიას ქ. 6, 1400, გორი,
საქართველო
(580) 2018 03 23

(111) M 1999 12077 R
(732) ასპენ გლობალ ინკორპორეტიდ
ჯბს პლაზა, კორნერ ლა სალეტი &
როილ როუდსი, გრენდ ბეი, მავრიკი
(770) გლაქსო გრუპ ლიმიტიდ
980 გრიტ უესტ როუდი, ბრენტფორდი,
მიდლსექსი TW8 9GS, გაერთიანებული
სამეფო
(580) 2018 05 23

(111) M 2009 19036 R
(732) შპს „გორელი“
შინდისის გზატ. მე-2 კმ., 1400, გორი,
საქართველო
(770) გიორგი გოგიჩაიშვილი

(111) M 1999 12085 R
(732) ასპენ გლობალ ინკორპორეტიდ
ჯბს პლაზა, კორნერ ლა სალეტი &
როილ როუდსი, გრენდ ბეი, მავრიკი
(770) გლაქსო გრუპ ლიმიტიდ
980 გრიტ უესტ როუდი, ბრენტფორდი,

მიდლსექსი TW8 9GS, გაერთიანებული
სამეფო
(580) 2018 05 23

(111) M 1999 12086 R
(732) ასპენ გლობალ ინკორპორეტიდ
ჯბს პლაზა, კორნერ ლა სალექტი &
როიალ როუდსი, გრენდ ბეი, მავრიკი
(770) გლაქსო გრუპ ლიმიტიდ
980 გრიტ უესტ როუდი, ბრენტფორდი,
მიდლსექსი TW8 9GS, გაერთიანებული
სამეფო
(580) 2018 05 23

(111) M 2016 27128 R
(732) კოტ ბევერიჯის ლლკ
1001 10თ ავენიუ, კოლუმბუსი, ჯორჯია
31901, აშშ
(770) კოტ ბევერიჯის ინკ.
5519 ვესტ აიდლუაილდ ავენიუ, ტამპა,
ფლორიდა 33634-8016, აშშ
(580) 2018 04 13

(111) M 2016 27316 R
(732) კოტ ბევერიჯის ლლკ
1001 10თ ავენიუ, კოლუმბუსი, ჯორჯია
31901, აშშ
(770) კოტ ბევერიჯის ინკ.
5519 ვესტ აიდლუაილდ ავენიუ, ტამპა,
ფლორიდა 33634-8016, აშშ
(580) 2018 04 13

(111) M 2017 28922 R
(732) კოტ ბევერიჯის ლლკ
1001 10თ ავენიუ, კოლუმბუსი, ჯორჯია
31901, აშშ
(770) კოტ ბევერიჯის ინკ.
5519 ვესტ აიდლუაილდ ავენიუ, ტამპა,
ფლორიდა 33634-8016, აშშ
(580) 2018 04 13

(111) M 1997 4429 R
(732) პრისმიან ს.პ.ა.
ვია კიეზე 6, 20126 მილანი, იტალია
(770) დრაკა კაბელ ბ.კ.
შივეგ 9, 2627 AN დელფი, ნიდერლანდები
(580) 2018 05 01

(111) M 1997 4361 R
(732) კოტ ბევერიჯის ლლკ
1001 10თ ავენიუ, კოლუმბუსი, ჯორჯია
31901, აშშ

(770) კოტ ბევერიჯიზ ინკ.
ჯორჯიას კორპორაცია
5405 საიპრეს სენტერ დრაივი, სუიტი 100,
ტამპა, ფლორიდა, აშშ 33069, აშშ;
კოტ ბევერიჯიზ ინკ.
ჯორჯიას კორპორაცია
4211 ვ. ბოი სკაუტ ბლვდ., კორპორეტი
სენტერ II, ტამპა, ფლორიდა 33607, აშშ;
კოტ ბევერიჯიზ ინკ.
ჯორჯიას კორპორაცია
5519 ვესტ აიდლუაილდ ავენიუ, ტამპა,
ფლორიდა 33634-8016, აშშ
(580) 2018 04 13

(111) M 1997 4362 R
(732) კოტ ბევერიჯის ლლკ
1001 10თ ავენიუ, კოლუმბუსი, ჯორჯია
31901, აშშ
(770) კოტ ბევერიჯიზ ინკ.
ჯორჯიას კორპორაცია
5405 საიპრეს სენტერ დრაივი, სუიტი 100,
ტამპა, ფლორიდა, აშშ 33069, აშშ;
კოტ ბევერიჯიზ ინკ.
ჯორჯიას კორპორაცია
4211 ვ. ბოი სკაუტ ბლვდ.
კორპორეტი სენტერ II, ტამპა, ფლორიდა
33607, აშშ;
კოტ ბევერიჯიზ ინკ.
ჯორჯიას კორპორაცია
5519 ვესტ აიდლუაილდ ავენიუ, ტამპა,
ფლორიდა 33634-8016, აშშ
(580) 2018 04 13

(111) M 1996 4279 R
(732) ასპენ გლობალ ინკორპორეტიდ
ჯბს პლაზა, კორნერ ლა სალექტი &
როიალ როუდსი, გრენდ ბეი, მავრიკი
(770) გლაქსო გრუპ ლიმიტიდ; 980 გრიტ
უესტ როუდი, ბრენტფორდი, მიდლსექსი
TW8 9GS, გაერთიანებული სამეფო
(580) 2018 05 23

ფლობელის სახელის და/ან მისამართის სვლილება

(111) M 1997 7699 R
(732) ემი (იპ) ლიმიტიდ
364-366 კენსინგტონ ჰაი სტრიტი, ლონ-
დონი W14 8NS, გაერთიანებული სამეფო
(770) ემი (იპ) ლიმიტიდ
27 რაიტს ლეინი, ლონდონი W8 5SW,
გაერთიანებული სამეფო
(580) 2018 01 24

(111) M 1998 10494 R
(732) ემი (იპ) ლიმიტიდ
364-366 კენსინგტონ ჰაი სტრიტი, ლონ-
დონი W14 8NS, გაერთიანებული სამეფო
(770) ემი (იპ) ლიმიტიდ
27 რაიტს ლეინი, ლონდონი W8 5SW,
გაერთიანებული სამეფო
(580) 2018 01 26

(111) M 1998 10495 R
(732) ემი (იპ) ლიმიტიდ
364-366 კენსინგტონ ჰაი სტრიტი,
ლონდონი W14 8NS, გაერთიანებული
სამეფო
(770) ემი (იპ) ლიმიტიდ
27 რაიტს ლეინი, ლონდონი W8 5SW,
გაერთიანებული სამეფო
(580) 2018 01 24

(111) M 1998 9054 R
(732) ფეროსან ა/ს
ლოტრუპენგ 8, DK-2750 ბალერუპი,
დანია
(770) ფეროსან ა/ს
საიდმარკენ 5, DK-2860 სოებორგი, დანია
(580) 2018 05 02

(111) M 1998 9071 R
(732) ფეროსან ა/ს
ლოტრუპენგ 8, DK-2750 ბალერუპი,
დანია
(770) ფეროსან ა/ს
საიდმარკენ 5, DK-2860 სოებორგი, დანია
(580) 2018 05 02

(111) M 1998 9075 R
(732) ორიონ კორპორეიშენ
13, ბეკომ-რო 90და-გილ, იონგსან-გუ,
სეული, კორეის რესპუბლიკა

(770) ორიონ კორპორეიშენ
30-10, მუნბაე-დონგი, იონგსან-კუი,
სეული, კორეის რესპუბლიკა
(580) 2018 05 02

(111) M 1998 9076 R
(732) ორიონ კორპორეიშენ
13, ბეკომ-რო 90და-გილ, იონგსან-გუ,
სეული, კორეის რესპუბლიკა
(770) ორიონ კორპორეიშენ
30-10, მუნბაე-დონგი, იონგსან-კუი,
სეული, კორეის რესპუბლიკა;
ტონგ იანგ კონფეკშენერი კორპორეიშენ
30-10, მუნბაე-დონგი, იონგსან-კუ,
სეული, კორეის რესპუბლიკა
(580) 2018 05 02

(111) M 1998 9077 R
(732) ორიონ კორპორეიშენ
13, ბეკომ-რო 90და-გილ, იონგსან-გუ,
სეული, კორეის რესპუბლიკა
(770) ორიონ კორპორეიშენ
30-10, მუნბაე-დონგი, იონგსან-კუი,
სეული, კორეის რესპუბლიკა
(580) 2018 05 02

(111) M 1998 10914 R
(732) ემი (იპ) ლიმიტიდ
364-366 კენსინგტონ ჰაი სტრიტი,
ლონდონი
W14 8NS, გაერთიანებული სამეფო
(770) ემი (იპ) ლიმიტიდ
27 რაიტს ლეინი, ლონდონი W8 5SW,
გაერთიანებული სამეფო
(580) 2018 01 24

(111) M 1998 10915 R
(732) ემი (იპ) ლიმიტიდ
364-366 კენსინგტონ ჰაი სტრიტი,
ლონდონი W14 8NS, გაერთიანებული
სამეფო
(770) ემი (იპ) ლიმიტიდ
27 რაიტს ლეინი, ლონდონი W8 5SW,
გაერთიანებული სამეფო
(580) 2018 01 24

(111) M 1998 10916 R
 (732) ემი (იპ) ლიმიტიდ
 364-366 კენსინგტონ ჰაი სტრიტი,
 ლონდონი W14 8NS, გაერთიანებული
 სამეფო
 (770) ემი (იპ) ლიმიტიდ
 27 რაიტს ლეინი, ლონდონი W8 5SW,
 გაერთიანებული სამეფო
 (580) 2018 01 24

(111) M 1998 8303 R
 (732) ლორენც სნეკ-უორლდ ჰოლდინგ გმბჰ
 ადელჰაიდშტრასე 4/5, 30171 ჰანოვერი,
 გერმანია
 (770) ლორენც სნეკ-უორლდ ჰოლდინგ გმბჰ
 ბემეროდერ შტრასე 71, 30559 ჰანოვერი,
 გერმანია
 (580) 2018 02 14

(111) M 2007 17811 R
 (732) ბრიჯსტოუნ ლაისენსინგ სერვისიზ, ინკ.
 (დელავერის შტატის კორპორაცია)
 200 4თ ავენიუ საუთი, სუიტ 100,
 ნეშვილი, ტენესი 37201, აშშ
 (770) ბრიჯსტოუნ ლაისენსინგ სერვისიზ, ინკ.
 535 მარიოტ დრაივი, ნეშვილი, ტენესი
 37214, აშშ
 (580) 2018 04 04

(111) M 2008 18364 R
 (732) ონი ბაიოტეკ ინკ.
 ბეირდ რისერჩ პარკი, 1576 სვიტჰოუმ
 როუდი, ამჰერსტი, ნიუ-იორკი 14228, აშშ
 (770) ონი ინკ.
 ბეირდ რისერჩ პარკი, 1576 სვიტჰოუმ
 როუდი, ამჰერსტი, ნიუ-იორკი 14228, აშშ
 (580) 2018 04 11

(111) M 2008 18341 R
 (732) ასტექს ფარმასეუტიკალს, ინკ.
 4420 როუზვუდ დრაივი, სუიტ 200
 პლიზენტონი, კალიფორნია 94588, აშშ
 (770) ასტექს ფარმასეუტიკალს, ინკ.
 4140 დუბლინ ბულვარი, სუიტ 200,
 დუბლინი, კალიფორნია 94568, აშშ
 (580) 2018 04 03

(111) M 2008 18341 R
 (732) ასტექს ფარმასეუტიკალს, ინკ.
 4420 როუზვუდ დრაივი, სუიტ 200
 პლიზენტონი, კალიფორნია 94588, აშშ
 (770) ასტექს ფარმასეუტიკალს, ინკ.

4140 დუბლინ ბულვარი, სუიტ 200,
 დუბლინი, კალიფორნია 94568, აშშ
 (580) 2018 04 03

(111) M 1996 2842 R
 (732) ბრიჯსტოუნ ლაისენსინგ სერვისიზ, ინკ.
 (დელავერის შტატის კორპორაცია)
 200 4თ ავენიუ საუთი, სუიტ 100,
 ნეშვილი, ტენესი 37201, აშშ
 (770) ბრიჯსტოუნ ლაისენსინგ სერვისიზ, ინკ.
 (დელავერის შტატის კორპორაცია)
 50 სენჩერი ბულვარი, ნეშვილი, ტენესი
 37214, აშშ;
 ბრიჯსტოუნ ლაისენსინგ სერვისიზ, ინკ.
 (დელავერის შტატის კორპორაცია)
 535 მარიოტ დრაივი, ნეშვილი, ტენესი
 37214, აშშ
 (580) 2018 04 04

(111) M 2008 18490 R
 (732) რომა სისტემზ, ინკ., დელავერის
 კორპორაცია
 11315 კორპორეიტ ბულვარ სვიტ 100,
 ორლანდო, ფლორიდა 32817, აშშ
 (770) რომა სისტემზ, ინკ.
 დელავერის კორპორაცია
 სვიტი 200, 9304 ფორესტ ლეინი,
 დალასი, ტეხასი 75243, აშშ
 (580) 2018 05 21

(111) M 1998 10179 R
 (732) სალომონ ს.ა.ს.
 ლე კრუასლე, 74370 მეს-ტესი,
 საფრანგეთი
 (770) სალომონ ს.ა.
 ლე კრუასლე, 74370 მეს-ტესი, საფრანგეთი;
 სალომონ ს.ა.
 ლა რაგუარი, მეს-ტესი, F-74370 პრენვი,
 საფრანგეთი
 (580) 2018 01 23

(111) M 2009 20096 R
 (732) ლალი რუბინი
 კეკელიძის ქ. 6, ბ.9, თბილისი, საქართველო
 (770) ლალი მანჯგალაძე
 დიღმის მას.მე-5 კვარ., კორპ.11, ბ.10,
 0159, თბილისი, საქართველო
 (580) 2018 02 07

(111) M 2013 23489 R
 (732) ჰაივინ ტექნოლოჯის კორპ.
 7, ჯინგკე როუდი, ნანტუნ დისტრიქტი,

ტაიხუნგ სიტი 40852, ტაივანი, ჩინეთის
პროვინცია
(770) ჰაივინ ტექნოლოჯის კორპ.
N46, 37 რდ., ტაიხუნგ ინდუსტრიულ
პარკი, ტაიხუნგ 40707, ტაივანი, ჩინეთი
(580) 2018 05 14

(111) M 2015 26118 R
(732) ეჯზაჯიბაში თიუქეთიმ ურუნღერი
სანაი ვე თიჯარეთ ანონიმ შირქეთი
ქავაჯიქ ოფის რიუზგარლი ბაჰჩე მაჰ.
ქავაქ სქ. No.20 ბეიქოზ სტამბოლი,
თურქეთი
(770) იფექ ქავით სანაი ვე თიჯარეთ ანონიმ
შირქეთი
კანიონ ოფისი ბიუიუკდერე ჯად., № 185
ლევენთ სტამბული, თურქეთი
(580) 2018 04 17

(111) M 1998 9313 R
(732) როიალ კანინ სას
650 ავენიუ დე ლა პეტიტ კამარგი,
F-30470
ემარგი, საფრანგეთი
(770) როიალ კანინ ს.ა.; F-30470 ემარგი,
საფრანგეთი
(580) 2018 05 10

(111) M 1998 9328 R
(732) პომერი
5, პლას დიუ ჟენერალ გურო, 51100
რეიმსი, საფრანგეთი
(770) პომერი ს.ა.
5, პლას დიუ ჟენერალ გურო, 51100
რეიმსი, საფრანგეთი
(580) 2018 05 15

(111) M 1998 9329 R
(732) პომერი
5, პლას დიუ ჟენერალ გურო, 51100
რეიმსი, საფრანგეთი
(770) პომერი ს.ა.
5, პლას დიუ ჟენერალ გურო, 51100
რეიმსი, საფრანგეთი
(580) 2018 05 15

(111) M 2017 28505 R
(732) ბრიჯსტოუნ ლაისენსინგ სერვისიზ, ინკ.
(დელავერის შტატის კორპორაცია)
200 4თ ავენიუ საუთი, სუიტ 100,
ნეშვილი, ტენესი 37201, აშშ

(770) ბრიჯსტოუნ ლაისენსინგ სერვისიზ, ინკ.
(დელავერის კორპორაცია)
535 მერიოტ დრაივ, ნეშვილი, ტენესი
37214, აშშ
(580) 2018 04 04

(111) M 1998 9618 R
(732) სანდენ ჰოლდინგს კორპორეიშენ
20, კოტობუკი-ჩო, ისესაკი-ში, 372-8502
გუნმა, იაპონია
(770) სანდენ ჰოლდინგს კორპორეიშენ
20, კოტობუკი-ჩო, ისესაკი-ში, გუნმა,
372, იაპონია
(580) 2018 05 23

(111) M 1998 9619 R
(732) სანდენ ჰოლდინგს კორპორეიშენ
20, კოტობუკი-ჩო, ისესაკი-ში, 372-8502
გუნმა, იაპონია
(770) სანდენ ჰოლდინგს კორპორეიშენ
20, კოტობუკი-ჩო, ისესაკი-ში, გუნმა,
372, იაპონია
(580) 2018 05 23

(111) M 1997 4429 R
(732) პრისმიან ს.პ.ა.
ვია კიეზე 6, 20126 მილანი, იტალია
(770) დრაკა კაბელ ბ.ვ.
შივევ 9, 2627 AN დელფი,
ნიდერლანდები
(580) 2018 05 01

(111) M 1998 8547 R
(732) ორიონ პიკერზ კორპორეიშენ
245 ნორთ ბევერლი დრაივი, ბევერლი
ჰილზი, CA 90210, აშშ
(770) ორიონ პიკერზ კორპორეიშენ
10250 კონსტელეიშენ ბლვდ., ლოს-ანჯე-
ლესი, კალიფორნია 90067-6241, აშშ;
ორიონ პიკერზ კორპორეიშენ
2500 ბროდვეი სტრიტი, სანტა-მონიკა,
კალიფორნია 90404-3061, აშშ;
ორიონ პიკერზ კორპორეიშენ
1888 სენჩერი პარკ ისტი, ლოს-ანჯელე-
სი, კალიფორნია 90067, აშშ
(580) 2018 02 28

(111) M 1998 9620 R
(732) სალამანდერ გმზ
ცურ შდენკჰეკე 4, 40764 ლანგენფელდი,
გერმანია

(770) სალამანდერ გმბჰ
კაიზერშტრასე 39-49,
D-63065 ოფენბახი, გერმანია
(580) 2018 05 01

(111) M 2017 29124 R
(732) შპს „სოფტ დრინკს ჯორჯია“
ი. პეტრიწის ქ.16, სართ. 8, ბ. 27,
თბილისი, საქართველო
(770) შპს „სოფტ დრინკს ჯორჯია“
ლ. მესხიშვილის 12, ავლაბრის შესახ.5,
ბ.16, საქართველო
(580) 2018 04 30

რეგისტრაციის ბათილად ცნობა

(111) M 1998 10611 R
(151) 1998 08 27
(181) 2019 02 27
(732) ჯენერალ მოტორს ლდკ
300 რენესანს სენტერი, სიტი-ოფ-დეტრო-
იტი, მიჩიგანის შტატი 48265-3000, აშშ

სასაქონლო ნიშნის საქონლისა და/ან მომსახურების
ჩამონათვალის სვლილება

(111) M 1998 8339 R

(732) ფუჯიცუ ჯენერალ ლიმიტიდ
3-3-17, სუენაგა ტაკაცუ-კუ, კავასაკი
213-8502, იაპონია

(511)

11 – საკონდიციონერო აპარატურა და დანადგარები; გამთბობი აპარატები; სამაცივრო აპარატურა და მანქანები; საშრობი აპარატები ტანსაცმლის საშრობების ჩათვლით; ჰაერის გამაგრილებელი აპარატურა; გამნათებელი, გასათბობი, ორთქლგენერატორული, კვების პროდუქტების სითბური დამუშავების, სამაცივრო, სავენტილაციო, საშრობი, წყლის გამწვანებელი და სანიტარულ-ტექნიკური დანიშნულების მოწყობილობები; ნაწილები და ფიტინგები ზემოთ ნახსენები პროდუქციისათვის (რომლებიც სხვა კლასებში არ არის გათვალისწინებული).

(111) M 1998 10791 R

(732) რიზო კაგაკუ კორპორეიშენ
5-34-7 შიბა, მინატო-კუ, ტოკიო 108-8385,
იაპონია

(511)

2 – სასტამბო საღებავი.

9 – ელექტრული ასლგადამღები მოწყობილობები და აპარატები, ფოტოგრაფიული, ელექტროსტატიკური და თერმული ასლგადამღები მოწყობილობებისა და აპარატების ჩათვლით; პორტატიული ტრაფარეტული საბეჭდი მოწყობილობა ელვა-ნათურით და ინტერფეისები.

16 – ბეჭდვისათვის განკუთვნილი ნაკრები; საბეჭდი მანქანები, ასლების გამრავლებისათვის განკუთვნილი მოწყობილობები და მანქანები, ტრაფარეტები, ტრაფარეტული ქაღალდი, ქაღალდი, ქაღალდის ყუთები, მელანი, საწერი ქაღალდი.

სისტემური საძიებლები გამოგონებები

**საერთაშორისო კლასიფიკაციის ინდექსის და განაცხადის
გამოქვეყნების ნომრის შესაბამისობის ცხრილი**

საერთაშორისო კლასიფიკაციის ინდექსი (51)	განაცხადის გამოქვეყნების ნომერი (10)
A 61 K 9/20; A 61 K 9/48; A 61 K 9/48; A 61 K 36/537; A 61 P 9/10; A 61 P 9/00; A 61 P 7/02	AP 2018 14056 A
A 61 K 31/337; A 61 K 31/551; A 61 K 35/00	AP 2018 13599 A
C 02 F 9/00; C 02 F 103/42; C 02 F 103/00; C 02 F 1/00; C 02 F 1/52; C 02 F 1/40; C 02 F 1/76	AP 2018 14150 A
C 07 D 213/75; C 07 D 217/22; C 07 D 401/04; C 07 D 401/06; C 07 D 401/14; C 07 D 405/14; C 07 D 407/06; C 07 D 407/12; C 07 D 409/04; C 07 D 409/06; C 07 D 409/14; C 07 D 413/04; C 07 D 413/14; C 07 D 417/04; C 07 D 417/06	AP 2018 13584 A
C 07 D 241/26; A 61 K 31/4965; A 61 P 11/12	AP 2018 13881 A
C 07 D 311/58; A 61 K 31/353; A 61 K 31/40025; A 61 P 5/00; A 61 P 19/00	AP 2018 13579 A
C 07 D 401/06; A 61 K 31/454; A 61 P 3/04	AP 2018 13634 A
E 04 C 2/296	AP 2018 14227 A

**განაცხადის გამოქვეყნების ნომრის და საერთაშორისო
კლასიფიკაციის ინდექსის შესაბამისობის ცხრილი**

განაცხადის გამოქვეყნების ნომერი (10)	საერთაშორისო კლასიფიკაციის ინდექსი (51)
AP 2018 13579 A	C 07 D 311/58; A 61 K 31/353; A 61 K 31/40025; A 61 P 5/00; A 61 P 19/00
AP 2018 13584 A	C 07 D 213/75; C 07 D 217/22; C 07 D 401/04; C 07 D 401/06; C 07 D 401/14; C 07 D 405/14; C 07 D 407/06; C 07 D 407/12; C 07 D 409/04; C 07 D 409/06; C 07 D 409/14; C 07 D 413/04; C 07 D 413/14; C 07 D 417/04; C 07 D 417/06
AP 2018 13599 A	A 61 K 31/337; A 61 K 31/551; A 61 K 35/00
AP 2018 13634 A	C 07 D 401/06; A 61 K 31/454; A 61 P 3/04
AP 2018 13881 A	C 07 D 241/26; A 61 K 31/4965; A 61 P 11/12
AP 2018 14056 A	A 61 K 9/20; A 61 K 9/48; A 61 K 9/48; A 61 K 36/537; A 61 P 9/10; A 61 P 9/00; A 61 P 7/02
AP 2018 14150 A	C 02 F 9/00; C 02 F 103/42; C 02 F 103/00; C 02 F 1/00; C 02 F 1/52; C 02 F 1/40; C 02 F 1/76
AP 2018 14227 A	E 04 C 2/296

საერთაშორისო კლასიფიკაციის ინდექსის, პატენტის ნომრისა და გამოქვეყნების ნომრის შესაბამისობის ცხრილი

საერთაშორისო კლასიფიკაციის ინდექსი (51)	პატენტის ნომერი (11)	ბანაცხადის გამოქვეყნების ნომერი (10)
A 61 K 8/362; A 61 K 8/41; A 61 Q 5/00; A 61 Q 5/04; A 61 Q 5/08; A 61 Q 5/10	P 2018 6869 B	AP 2018 14045 A
A 61 K 9/00; A 61 M 15/00; A 61 K 31/167; A 61 K 31/40; B 65 D 83/54; A 61 K 31/573	P 2018 6870 B	AP 2018 14192 A
A 61 K 31/7048; A 61 P 31/04	P 2018 6872 B	AP 2018 14327 A
A 61 K 38/14; A 61 K 31/545; C 07 D 501/00; C 07 K 9/00	P 2018 6874 B	AP 2018 13957 A
A 61 K 39/395	P 2018 6866 B	AP 2018 13302 A
A 61 M 15/00	P 2018 6865 B	AP 2018 14377 A
B 28 B 19/00	P 2018 6867 B	AP 2018 13882 A
C 07 C 237/22	P 2018 6871 B	AP 2018 14220 A
C 07 D 401/14; C 07 D 413/14; C 07 D 401/04; A 61 K 31/506; A 61 K 31/4545; A 61 K 31/5377; A 61 P 3/00; C 07 D 491/08; C 07 D 487/04	P 2018 6864 B	AP 2018 14268 A
C 07 F 9/45; A 61 P 35/04; A 61 K 31/662	P 2018 6868 B	AP 2018 13996 A
G 06 T 15/00; A 63 F 13/00; G 06 T 17/00; G 06 T 19/00; H 04 N 5/272	P 2018 6873 B	AP 2018 14351 A

პატენტის ნომრის, ბანაცხადის გამოქვეყნების ნომრისა და საერთაშორისო კლასიფიკაციის ინდექსის შესაბამისობის ცხრილი

პატენტის ნომერი (11)	ბანაცხადის გამოქვეყნების ნომერი (10)	საერთაშორისო კლასიფიკაციის ინდექსი (51)
P 2018 6864 B	AP 2018 14268 A	C 07 D 401/14; C 07 D 413/14; C 07 D 401/04; A 61 K 31/506; A 61 K 31/4545; A 61 K 31/5377; A 61 P 3/00; C 07 D 491/08; C 07 D 487/04
P 2018 6865 B	AP 2018 14377 A	A 61 M 15/00
P 2018 6866 B	AP 2018 13302 A	A 61 K 39/395
P 2018 6867 B	AP 2018 13882 A	B 28 B 19/00
P 2018 6868 B	AP 2018 13996 A	C 07 F 9/45; A 61 P 35/04; A 61 K 31/662
P 2018 6869 B	AP 2018 14045 A	A 61 K 8/362; A 61 K 8/41; A 61 Q 5/00; A 61 Q 5/04; A 61 Q 5/08; A 61 Q 5/10
P 2018 6870 B	AP 2018 14192 A	A 61 K 9/00; A 61 M 15/00; A 61 K 31/167; A 61 K 31/40; B 65 D 83/54; A 61 K 31/573
P 2018 6871 B	AP 2018 14220 A	C 07 C 237/22
P 2018 6872 B	AP 2018 14327 A	A 61 K 31/7048; A 61 P 31/04
P 2018 6873 B	AP 2018 14351 A	G 06 T 15/00; A 63 F 13/00; G 06 T 17/00; G 06 T 19/00; H 04 N 5/272
P 2018 6874 B	AP 2018 13957 A	A 61 K 38/14; A 61 K 31/545; C 07 D 501/00; C 07 K 9/00

ბანაცხადის ნომრის, ბანაცხადის გამოქვეყნების ნომრისა და პატენტის ნომრის შესაბამისობის ცხრილი

ბანაცხადის ნომერი (21)	ბანაცხადის გამოქვეყნების ნომერი (10)	პატენტის ნომერი (11)
AP 2012 013302	AP 2018 13302 A	P 2018 6866 B
AP 2012 013882	AP 2018 13882 A	P 2018 6867 B
AP 2014 013957	AP 2018 13957 A	P 2018 6874 B
AP 2015 013996	AP 2018 13996 A	P 2018 6868 B
AP 2014 014045	AP 2018 14045 A	P 2018 6869 B
AP 2014 014192	AP 2018 14192 A	P 2018 6870 B
AP 2014 014220	AP 2018 14220 A	P 2018 6871 B
AP 2015 014268	AP 2018 14268 A	P 2018 6864 B
AP 2015 014327	AP 2018 14327 A	P 2018 6872 B
AP 2015 014351	AP 2018 14351 A	P 2018 6873 B
AP 2015 014377	AP 2018 14377 A	P 2018 6865 B

სასარგებლო მოდელები

საერთაშორისო კლასიფიკაციის ინდექსის და ბანაცხადის გამოქვეყნების ნომრის შესაბამისობის ცხრილი

საერთაშორისო კლასიფიკაციის ინდექსი (51)	ბანაცხადის გამოქვეყნების ნომერი (10)
A 23 L 1/06	AU 2018 14589 U
A 43 B 17/00	AU 2018 14429 U
A 47 G 21/00	AU 2018 14654 U
B 44 C 5/00	AU 2018 14575 U

ბანაცხადის გამოქვეყნების ნომრის და საერთაშორისო კლასიფიკაციის ინდექსის შესაბამისობის ცხრილი

ბანაცხადის გამოქვეყნების ნომერი (10)	საერთაშორისო კლასიფიკაციის ინდექსი (51)
AU 2018 14429 U	A 43 B 17/00
AU 2018 14575 U	B 44 C 5/00
AU 2018 14589 U	A 23 L 1/06
AU 2018 14654 U	A 47 G 21/00

საერთაშორისო კლასიფიკაციის ინდექსის, პატენტის ნომრისა და გამოქვეყნების ნომრის შესაბამისობის ცხრილი

საერთაშორისო კლასიფიკაციის ინდექსი (51)	პატენტის ნომერი (11)	ბანაცხადის გამოქვეყნების ნომერი (10)
A 01 B 51/00; B 62 D 21/00	U 2018 1970 Y	AU 2018 14476 U

პატენტის ნომრის, განაცხადის გამოქვეყნების ნომრისა და საერთაშორისო კლასიფიკაციის ინდექსის შესაბამისობის ცხრილი

პატენტის ნომერი (11)	განაცხადის გამოქვეყნების ნომერი (10)	საერთაშორისო კლასიფიკაციის ინდექსი (51)
U 2018 1970 Y	AU 2018 14476 U	A 01 B 51/00; B 62 D 21/00

განაცხადის ნომრის, განაცხადის გამოქვეყნების ნომრისა და პატენტის ნომრის შესაბამისობის ცხრილი

განაცხადის ნომერი (21)	განაცხადის გამოქვეყნების ნომერი (10)	პატენტის ნომერი (11)
AU 2017 014476	AU 2018 14476 U	U 2018 1970 Y

ღიზინები

საერთაშორისო კლასიფიკაციის ინდექსის, პატენტის ნომრისა და გამოქვეყნების ნომრის შესაბამისობის ცხრილი

საერთაშორისო კლასიფიკაციის ინდექსი (51)	პატენტის ნომერი (11)	განაცხადის გამოქვეყნების ნომერი (10)
19-04	D 2018 765 S	AD 2018 985 S
32-00	D 2018 766 S	AD 2018 995 S

პატენტის ნომრის, განაცხადის გამოქვეყნების ნომრისა და საერთაშორისო კლასიფიკაციის ინდექსის შესაბამისობის ცხრილი

პატენტის ნომერი (11)	განაცხადის გამოქვეყნების ნომერი (10)	საერთაშორისო კლასიფიკაციის ინდექსი (51)
D 2018 765 S	AD 2018 985 S	19-04
D 2018 766 S	AD 2018 995 S	32-00

განაცხადის ნომრის, განაცხადის გამოქვეყნების ნომრისა და პატენტის ნომრის შესაბამისობის ცხრილი

განაცხადის ნომერი (21)	განაცხადის გამოქვეყნების ნომერი (10)	პატენტის ნომერი (11)
AD 2017 985	AD 2018 985 S	D 2018 765 S
AD 2017 995	AD 2018 995 S	D 2018 766 S

სასაქონლო ნიშნები

რეგისტრაციის ნომრის, განაცხადის ნომრის,
განაცხადის გამოქვეყნების ნომრისა და ბიულეტენის ნომრის
შესაბამისობის ცხრილი

რეგისტრაციის ნომერი (11)	განაცხადის ნომერი (210)	განაცხადის გამოქვეყნების ნომერი (260)	ბიულეტენის ნომერი
1	2	3	4
M 2018 29758 R	AM 97786	-	12(496)2018
M 2018 29759 R	AM 97417	-	12(496)2018
M 2018 29760 R	AM 97784	-	12(496)2018
M 2018 29761 R	AM 79963	-	12(496)2018
M 2018 29762 R	AM 97452	-	12(496)2018
M 2018 29763 R	AM 97769	-	12(496)2018
M 2018 29764 R	AM 97978	-	12(496)2018
M 2018 29765 R	AM 97890	-	12(496)2018
M 2018 29766 R	AM 97891	-	12(496)2018
M 2018 29767 R	AM 97399	-	12(496)2018
M 2018 29768 R	AM 97881	-	12(496)2018
M 2018 29769 R	AM 97961	-	12(496)2018
M 2018 29770 R	AM 97962	-	12(496)2018
M 2018 29771 R	AM 89279	AM 2017 89279 A	23(483)2017
M 2018 29772 R	AM 89285	AM 2017 89285 A	23(483)2017
M 2018 29773 R	AM 89288	AM 2017 89288 A	23(483)2017
M 2018 29774 R	AM 90306	AM 2018 90306 A	5(489)2018
M 2018 29775 R	AM 90391	AM 2017 90391 A	18(478)2017
M 2018 29776 R	AM 91531	AM 2017 91531 A	21(481)2017
M 2018 29777 R	AM 91737	AM 2018 91737 A	4(488)2018
M 2018 29778 R	AM 91783	AM 2017 91783 A	24(484)2017
M 2018 29779 R	AM 91857	AM 2017 91857 A	24(484)2017
M 2018 29780 R	AM 91858	AM 2017 91858 A	24(484)2017
M 2018 29781 R	AM 91860	AM 2017 91860 A	24(484)2017
M 2018 29782 R	AM 91861	AM 2017 91861 A	24(484)2017
M 2018 29783 R	AM 91889	AM 2017 91889 A	24(484)2017
M 2018 29784 R	AM 92103	AM 2017 92103 A	24(484)2017
M 2018 29785 R	AM 92112	AM 2018 92112 A	5(489)2018
M 2018 29786 R	AM 92126	AM 2018 92126 A	2(486)2018
M 2018 29787 R	AM 92141	AM 2017 92141 A	24(484)2017
M 2018 29788 R	AM 92143	AM 2017 92143 A	24(484)2017
M 2018 29789 R	AM 92182	AM 2018 92182 A	2(486)2018
M 2018 29790 R	AM 92193	AM 2018 92193 A	5(489)2018
M 2018 29791 R	AM 92194	AM 2018 92194 A	5(489)2018
M 2018 29792 R	AM 92202	AM 2018 92202 A	4(488)2018
M 2018 29793 R	AM 92226	AM 2017 92226 A	23(483)2017
M 2018 29794 R	AM 92340	AM 2018 92340 A	1(485)2018
M 2018 29795 R	AM 92341	AM 2018 92341 A	1(485)2018
M 2018 29796 R	AM 92365	AM 2018 92365 A	1(485)2018
M 2018 29797 R	AM 92367	AM 2018 92367 A	1(485)2018
M 2018 29798 R	AM 92368	AM 2018 92368 A	1(485)2018
M 2018 29799 R	AM 92376	AM 2018 92376 A	1(485)2018
M 2018 29800 R	AM 92377	AM 2018 92377 A	1(485)2018
M 2018 29801 R	AM 92378	AM 2018 92378 A	1(485)2018
M 2018 29802 R	AM 92385	AM 2018 92385 A	1(485)2018
M 2018 29803 R	AM 92536	AM 2018 92536 A	3(487)2018

1	2	3	4
M 2018 29804 R	AM 92541	AM 2017 92541 A	23(483)2017
M 2018 29805 R	AM 92653	AM 2018 92653 A	4(488)2018
M 2018 29806 R	AM 92654	AM 2018 92654 A	4(488)2018
M 2018 29807 R	AM 92655	AM 2018 92655 A	4(488)2018
M 2018 29808 R	AM 92708	AM 2018 92708 A	1(485)2018
M 2018 29809 R	AM 92711	AM 2018 92711 A	1(485)2018
M 2018 29810 R	AM 92713	AM 2018 92713 A	1(485)2018
M 2018 29811 R	AM 92715	AM 2018 92715 A	1(485)2018
M 2018 29812 R	AM 92716	AM 2018 92716 A	1(485)2018
M 2018 29813 R	AM 92720	AM 2018 92720 A	1(485)2018
M 2018 29814 R	AM 92721	AM 2018 92721 A	1(485)2018
M 2018 29815 R	AM 92725	AM 2018 92725 A	1(485)2018
M 2018 29816 R	AM 92726	AM 2018 92726 A	1(485)2018
M 2018 29817 R	AM 92731	AM 2018 92731 A	1(485)2018
M 2018 29818 R	AM 92884	AM 2018 92884 A	4(488)2018
M 2018 29819 R	AM 92921	AM 2018 92921 A	3(487)2018
M 2018 29820 R	AM 92923	AM 2018 92923 A	3(487)2018
M 2018 29821 R	AM 92924	AM 2018 92924 A	3(487)2018
M 2018 29822 R	AM 92925	AM 2018 92925 A	3(487)2018
M 2018 29823 R	AM 92926	AM 2018 92926 A	3(487)2018
M 2018 29824 R	AM 92986	AM 2018 92986 A	2(486)2018
M 2018 29825 R	AM 92992	AM 2018 92992 A	4(488)2018
M 2018 29826 R	AM 93139	AM 2018 93139 A	5(489)2018
M 2018 29827 R	AM 93143	AM 2018 93143 A	5(489)2018
M 2018 29828 R	AM 93146	AM 2018 93146 A	5(489)2018
M 2018 29829 R	AM 93149	AM 2018 93149 A	5(489)2018
M 2018 29830 R	AM 93485	AM 2018 93485 A	4(488)2018
M 2018 29831 R	AM 93492	AM 2018 93492 A	4(488)2018
M 2018 29832 R	AM 93530	AM 2018 93530 A	5(489)2018
M 2018 29833 R	AM 88769	AM 2018 88769 A	3(487)2018
M 2018 29834 R	AM 97967	-	12(496)2018

ბანაცხადის გამოქვეყნების ნომრის და ბანაცხადის ნომრის შესაბამისობის ცხრილი

ბანაცხადის გამოქვეყნების ნომერი (260)	ბანაცხადის ნომერი (210)	1	2
1	2	AM 2018 94490 A	AM 94490 A
AM 2018 91940 A*	AM 91940 A	AM 2018 94534 A	AM 94534 A
AM 2018 92481 A	AM 92481 A	AM 2018 94544 A	AM 94544 A
AM 2018 92586 A	AM 92586 A	AM 2018 94547 A	AM 94547 A
AM 2018 93782 A	AM 93782 A	AM 2018 94563 A	AM 94563 A
AM 2018 93834 A	AM 93834 A	AM 2018 94564 A	AM 94564 A
AM 2018 93835 A	AM 93835 A	AM 2018 94565 A	AM 94565 A
AM 2018 93836 A	AM 93836 A	AM 2018 94566 A	AM 94566 A
AM 2018 94378 A	AM 94378 A	AM 2018 94568 A	AM 94568 A
AM 2018 94398 A	AM 94398 A	AM 2018 94571 A	AM 94571 A
AM 2018 94441 A	AM 94441 A	AM 2018 94575 A	AM 94575 A
AM 2018 94454 A	AM 94454 A	AM 2018 94577 A	AM 94577 A
AM 2018 94471 A	AM 94471 A	AM 2018 94597 A	AM 94597 A
		AM 2018 94601 A	AM 94601 A
		AM 2018 94604 A	AM 94604 A
		AM 2018 94608 A	AM 94608 A
		AM 2018 94609 A	AM 94609 A

1	2
AM 2018 94610 A	AM 94610 A
AM 2018 94615 A	AM 94615 A
AM 2018 94674 A	AM 94674 A
AM 2018 94677 A	AM 94677 A
AM 2018 94679 A	AM 94679 A
AM 2018 94680 A	AM 94680 A
AM 2018 94690 A	AM 94690 A
AM 2018 94710 A	AM 94710 A
AM 2018 94711 A	AM 94711 A
AM 2018 94712 A	AM 94712 A
AM 2018 94721 A	AM 94721 A
AM 2018 94776 A	AM 94776 A
AM 2018 94777 A	AM 94777 A
AM 2018 94792 A	AM 94792 A
AM 2018 94821 A	AM 94821 A
AM 2018 94829 A	AM 94829 A
AM 2018 94830 A	AM 94830 A

1	2
AM 2018 94976 A	AM 94976 A
AM 2018 95069 A	AM 95069 A
AM 2018 95070 A	AM 95070 A
AM 2018 95071 A	AM 95071 A
AM 2018 95120 A	AM 95120 A
AM 2018 95121 A	AM 95121 A
AM 2018 95122 A	AM 95122 A
AM 2018 95123 A	AM 95123 A
AM 2018 95124 A	AM 95124 A
AM 2018 95125 A	AM 95125 A
AM 2018 95126 A	AM 95126 A
AM 2018 95127 A	AM 95127 A
AM 2018 95128 A	AM 95128 A
AM 2018 95129 A	AM 95129 A
AM 2018 95182 A	AM 95182 A
AM 2018 95224 A	AM 95224 A
AM 2018 95306 A	AM 95306 A

ბანაცხადის გამოქვეყნების ნომრის საძიებელი საქონლისა და/ან მომსახურების კლასის მიხედვით

საქონლისა და/ან მომსახურების კლასი (511)	ბანაცხადის გამოქვეყნების ნომერი (260)
1	2
2	AM 2018 94454 A
3	AM 2018 92481 A
5	AM 2018 91940 A*
5	AM 2018 94441 A
5	AM 2018 94534 A
5	AM 2018 94566 A
5	AM 2018 94568 A
5	AM 2018 94674 A
5	AM 2018 94677 A
5	AM 2018 94679 A
5	AM 2018 94680 A
5	AM 2018 94690 A
5	AM 2018 94710 A
5	AM 2018 94711 A
5	AM 2018 94829 A
5	AM 2018 94830 A
5	AM 2018 95069 A
5	AM 2018 95070 A
5	AM 2018 95071 A
9	AM 2018 94544 A
9	AM 2018 94821 A
14	AM 2018 94821 A
16	AM 2018 94471 A
16	AM 2018 94721 A
16	AM 2018 95182 A
19	AM 2018 94792 A
21	AM 2018 92481 A

1	2
25	AM 2018 94821 A
28	AM 2018 94821 A
29	AM 2018 94547 A
29	AM 2018 94563 A
29	AM 2018 94712 A
29	AM 2018 94829 A
29	AM 2018 94830 A
29	AM 2018 95306 A
30	AM 2018 94378 A
30	AM 2018 94547 A
30	AM 2018 94563 A
30	AM 2018 95306 A
31	AM 2018 94563 A
32	AM 2018 94608 A
32	AM 2018 94609 A
32	AM 2018 94610 A
33	AM 2018 93782 A
33	AM 2018 94577 A
33	AM 2018 94601 A
33	AM 2018 94604 A
33	AM 2018 94776 A
33	AM 2018 94777 A
34	AM 2018 94575 A
34	AM 2018 95224 A
35	AM 2018 92481 A
35	AM 2018 94490 A
35	AM 2018 94544 A
35	AM 2018 94976 A
35	AM 2018 95120 A
35	AM 2018 95121 A
35	AM 2018 95122 A
35	AM 2018 95123 A

1	2
35	AM 2018 95124 A
35	AM 2018 95125 A
35	AM 2018 95126 A
35	AM 2018 95127 A
35	AM 2018 95128 A
35	AM 2018 95129 A
36	AM 2018 94398 A
36	AM 2018 94597 A
36	AM 2018 94615 A
36	AM 2018 95120 A
36	AM 2018 95121 A
36	AM 2018 95122 A
36	AM 2018 95123 A
36	AM 2018 95124 A
36	AM 2018 95125 A
36	AM 2018 95126 A
36	AM 2018 95127 A
36	AM 2018 95128 A
36	AM 2018 95129 A
36	AM 2018 95182 A
37	AM 2018 93834 A
37	AM 2018 93835 A
37	AM 2018 93836 A
37	AM 2018 94976 A
37	AM 2018 95120 A
37	AM 2018 95121 A
37	AM 2018 95122 A
37	AM 2018 95123 A
37	AM 2018 95124 A
37	AM 2018 95125 A
37	AM 2018 95126 A
37	AM 2018 95127 A
37	AM 2018 95128 A
37	AM 2018 95129 A
38	AM 2018 94544 A
38	AM 2018 95182 A
39	AM 2018 93834 A
39	AM 2018 93835 A
39	AM 2018 93836 A
39	AM 2018 95120 A
39	AM 2018 95121 A
39	AM 2018 95122 A
39	AM 2018 95123 A
39	AM 2018 95124 A
39	AM 2018 95125 A
39	AM 2018 95126 A
39	AM 2018 95127 A
39	AM 2018 95128 A
39	AM 2018 95129 A
41	AM 2018 93834 A
41	AM 2018 93835 A

1	2
41	AM 2018 93836 A
41	AM 2018 94490 A
41	AM 2018 94544 A
41	AM 2018 95120 A
41	AM 2018 95121 A
41	AM 2018 95122 A
41	AM 2018 95123 A
41	AM 2018 95124 A
41	AM 2018 95125 A
41	AM 2018 95126 A
41	AM 2018 95127 A
41	AM 2018 95128 A
41	AM 2018 95129 A
42	AM 2018 93834 A
42	AM 2018 93835 A
42	AM 2018 93836 A
42	AM 2018 94544 A
43	AM 2018 93834 A
43	AM 2018 93835 A
43	AM 2018 93836 A
43	AM 2018 94490 A
43	AM 2018 94564 A
43	AM 2018 94565 A
43	AM 2018 94571 A
43	AM 2018 95120 A
43	AM 2018 95121 A
43	AM 2018 95122 A
43	AM 2018 95123 A
43	AM 2018 95124 A
43	AM 2018 95125 A
43	AM 2018 95126 A
43	AM 2018 95127 A
43	AM 2018 95128 A
43	AM 2018 95129 A
43	AM 2018 95306 A
44	AM 2018 92586 A
44	AM 2018 93834 A
44	AM 2018 93835 A
44	AM 2018 93836 A
44	AM 2018 94471 A
44	AM 2018 94721 A
44	AM 2018 95120 A
44	AM 2018 95121 A
44	AM 2018 95122 A
44	AM 2018 95123 A
44	AM 2018 95124 A
44	AM 2018 95125 A
44	AM 2018 95126 A
44	AM 2018 95127 A
44	AM 2018 95128 A
44	AM 2018 95129 A

დაჩქარებული პროცედურით რეგისტრირებული სასაქონლო ნიშნის
ნომრის სამიჯნაბლი საქონლისა და/ან მომსახურების
კლასის მიხედვით

საქონლისა და/ან მომსახურების კლასი (51)	დაჩქარებული პროცედურით რეგისტრირებული სასაქონლო ნიშნის ნომერი (11)
5	M 2018 29758 R
5	M 2018 29760 R
5	M 2018 29769 R
5	M 2018 29770 R
5	M 2018 29764 R
9	M 2018 29766 R
9	M 2018 29765 R
11	M 2018 29763 R
18	M 2018 29834 R
25	M 2018 29762 R
33	M 2018 29768 R
35	M 2018 29834 R
35	M 2018 29761 R
39	M 2018 29761 R
43	M 2018 29759 R
43	M 2018 29767 R

სამრეწველო საკუთრების
ოფიციალური ბიულეტენი

12(496)

გამოგონებები
სასარგებლო მოდელები
დიზაინები
სასაქონლო ნიშნები

მთავარი რედაქტორი:	ნ. ბებრიშვილი
კორექტორი:	ლ. ჭანტურია
დამაკაბადონებელი:	მ. ორდენიძე
	ქ. სვანიძე
პოლიგრაფიული ჯგუფი:	მ. მეჩიტაშვილი
	ი. გოგოლაშვილი
	ლ. დოლიძე

ხელმოწერილია გამოსაცემად: 2018 06 25

ტირაჟი: 25
შეკვეთა №12

ბიულეტენის ელექტრონული ვერსიის გაცნობა შესაძლებელია საქპატენტის ვებგვერდზე.