



**NATIONAL INTELLECTUAL PROPERTY CENTER OF GEORGIA
SAKPATENTI**

**OFFICIAL BULLETIN
OF THE INDUSTRIAL PROPERTY**

13(449)

**2016
TBILISI**

INID CODES FOR IDENTIFICATION OF BIBLIOGRAPHIC DATA

INVENTIONS, UTILITY MODELS

- (10) Number of publication for application, which has been examined
- (11) Number of patent and kind of document
- (21) Serial number of application
- (22) Date of filing of the application
- (23) Date of exhibition or the date of the earlier filing and the number of application, if any
- (24) Date from which patent may have effect
- (31) Number of priority application
- (32) Date of filing of priority application
- (33) Code of the country or regional organization allotting priority application number
- (44) Date of publication of application not granted, but examined and number of bulletin
- (45) Date of publication of registered document
- (51) International Patent Classification Index
- (54) Title of the invention
- (57) Abstract
- (60) Number of examined patent document granted by foreign patent office, date from which patent has effect and country code
- (62) Number of the earlier application and in case of divided application, date of filing an application
- (71) Name, surname and address of applicant (country code)
- (72) Name, surname of inventor (country code)
- (73) Name, surname and address of patent owner (country code)
- (74) Name, surname of representative or patent attorney
- (85) Date of commencement of the national phase of International Application
- (86) Number and date of filing of international application
- (87) Number and date of publication of international application

DESIGNS

- (10) Number of publication for application
- (11) Number of patent and kind of document or number of registration
- (15) Date of registration/Date of patent renewal
- (18) Expected expiration date of patent or registration
- (21) Serial number of application
- (22) Date of filing of the application
- (23) Date of exhibition or the date of the earlier filing and the number of application, if any
- (24) Date from which patent may have effect
- (28) Number of designs included in the application
- (30) Data relating to priority (number of application, date of filing of application, two-letter code identifying the authority with whom the priority application was made)
- (31) Number of priority application
- (32) Date of filing of priority application
- (33) Code of the country or regional organization allotting priority application number
- (34) Two-letter code according to WIPO St.3 identifying the authority with which the priority application was made
- (44) Date of publication of design and number of bulletin (the first publication)
- (45) Date of publication of design registered by WIPO and number of bulletin
- (51) International Classification for designs (class and subclass of the Locarno Classification)
- (54) Title of the invention
- (55) Reproduction of the design
- (57) Description of characteristic features of the design including indication of colors
- (58) Date of recording of any kind of amendment in the Register
- (62) Number of the earlier application, registration and document number and if available the date of filing an application in case of divided application
- (71) Name, surname and address of applicant (country code)
- (72) Name, surname of creator (country code)
- (73) Name, surname and address of patent owner (country code)
- (74) Name, surname of representative or patent attorney
- (81) Contracting states concerned
 - II designated contracting states according to the 1960 Act
 - III designated contracting states according to the 1999 Act
- (85) Owner's permanent address
- (86) Owner's nationality
- (87) Owner's residence
- (88) State in which the owner has a real and effective industrial or commercial establishment

TRADEMARKS

- (111) - Number of registration
- (151) - Date of registration
- (156) - Date of the renewal
- (181) - Expected expiration date of registration
- (186) - Renewal expiration date of registration
- (141) - Date of cancel of duration of the mark
- (210) - Serial number of application
- (220) - Date of filing of the application
- (230) - Date concerning exhibition
- (260) - Number of application, for which favorable decision of examination about registration has been taken (publication number)
- (310) - Number of the first application
- (320) - Date of filing of the first application
- (330) - Code, identifying national or regional Office where the first application was made
- (511) - International Classification of Goods and Services for the purposes of registration of trade marks and/or list of goods and/or services classified according thereto
- (531) - Description of figurative elements of Trade Marks according to the International Classification of the Figurative Elements of Marks
- (540) - Reproduction of Trade Mark
- (550) - Nature and kind of Trade Mark
- (580) - Date of recording of any kind changes in respect of applications or registrations
- (591) - Information concerning colors claimed
- (731) - Name and address of the applicant
- (732) - Name and address of the holder of the registration
- (740) - Name and address of the representative
- (750) - Address for correspondence
- (770) - Name and address of the previous applicant or holder in case of change in ownership
- (771) - Previous name and address of the applicant or holder in case of change in ownership
- (791) - Name and address of the licensee
- (793) - Indication of conditions and/or restrictions under the license (Type of license, number of license agreement, data of license, data of validity of license)
- (800) - Certain data relating to the international registration of Trade Marks under the Protocol Relating to Madrid Agreement (International registration number)

CODES FOR PUBLICATION IN BULLETIN

- (21) AP 0000 000000 - serial number of application for invention
- (10) AP 0000 0000 A - number of published application for invention (first publication)
- (11) P 0000 0000 B - number of patent for invention (second publication)
- (21) API 0000 000000 - number of application for imported patent
- (11) PI 0000 0000 A - number of imported patent (first publication)
- (21) AU 0000 000000 - serial number of application for utility model
- (10) AU 0000 000 U - number of published application for utility model (first publication)
- (11) U 0000 000 Y - number of patent for utility model (second publication)
- (21) AD 0000 000000 - serial number of application for design
- (10) AD 0000 000 S - number of published application for design (first publication)
- (11) D 0000 000 S - number of patent for design (second publication)

INTERNATIONAL PATENT CLASSIFICATION FOR INVENTIONS AND UTILITY MODELS

- SECTION A - HUMAN NECESSITIES
- SECTION B - PERFORMING OPERATIONS; TRANSPORTING
- SECTION C - CHEMISTRY; METALLURGY
- SECTION D - TEXTILES; PAPER
- SECTION E - FIXED CONSTRUCTIONS
- SECTION F - MECHANICAL ENGINEERING; LIGHTING; HEATING; WEAPONS; BLASTING
- SECTION G - PHYSICS
- SECTION H - ELECTRICITY

-
- M - Trade Mark
 - (210) AM 0000 000000 - Serial number of application;
 - (260) AAM 0000 00000 A - Publication number of application;
 - (111) M 0000 00000 R - Number of registration;
 - (111) MMM0000 00000 Rn - Number of renewals, in which n=1,2,3;
 - (111) M 0000 00000 R(P) - Number of registration under partial assignment of rights
-

LIST OF CODES, IN ALPHABETIC SEQUENCE, AND THE CORRESPONDING (SHORT) NAMES OF STATES, OTHER ENTITIES AND INTERGOVERNMENTAL ORGANIZATIONS
(WIPO STANDARD ST.3)

AD	Andorra				
AE	United Arab Emirates				
AF	Afghanistan				
AG	Antigua and Barbuda				
AI	Anguilla				
AL	Albania				
AM	Armenia				
AN	Netherlands Antilles				
AO	Angola				
AP	African Regional Intellectual Property Organization (ARIPO)				
AR	Argentina				
AT	Austria				
AU	Australia				
AW	Aruba				
AZ	Azerbaijan				
BA	Bosnia and Herzegovina				
BB	Barbados				
BD	Bangladesh				
BE	Belgium				
BF	Burkina Faso				
BG	Bulgaria				
BH	Bahrain				
BI	Burundi				
BJ	Benin				
BM	Bermuda				
BN	Brunei Darussalam				
BO	Bolivia				
BR	Brazil				
BS	Bahamas				
BT	Bhutan				
BV	Bouvet Island				
BW	Botswana				
BX	Benelux Office for Intellectual Property (BOIP)				
BY	Belarus				
BZ	Belize				
CA	Canada				
CD	Democratic Republic of the Congo				
CF	Central African Republic				
CG	Congo				
CH	Switzerland				
CI	Cote d'Ivoire				
CK	Cook Islands				
CL	Chile				
CM	Cameroon				
CN	China				
CO	Colombia				
CR	Costa Rica				
CU	Cuba				
CV	Cape Verde				
CY	Cyprus				
CZ	Czech Republic				
DE	Germany				
DJ	Djibouti				
DM	Dominica				
DO	Dominican Republic				
DZ	Algeria				
EA	Eurasian Patent Organization (EAPO)				
EC	Ecuador				
EE	Estonia				
EG	Egypt				
EH	Western Sahara				
EM	Office for Harmonization in the Internal Market (Trademarks and Designs)(OHIM)				
EP	European Patent Office (EPO)				
ER	Eritrea				
ES	Spain				
ET	Ethiopia				
FI	Finland				
FJ	Fiji				
FK	Falkland Islands (Malvinas)				
FO	Faroe Islands				
FR	France				
GA	Gabon				
GB	United Kingdom				
GC	Patent Office of the Cooperation Council for the Arab States of the Gulf (GCC)				
GD	Grenada				
GG	Guernsey				
GH	Ghana				
GI	Gibraltar				
GT	Guatemala				
GW	Guinea- Bissau				
GY	Guyana				
HK	The Hong Kong Special Administrative Region of the People's Republic of China				
HN	Honduras				
HR	Croatia				
HT	Haiti				
HU	Hungary				
IB	International Bureau of the World Intellectual Property Organization (WIPO)				
ID	Indonesia				
IE	Ireland				
IL	Israel				
IM	Isle of Man				
IN	India				
IQ	Iraq				
ID	Indonesia				
IE	Ireland				
IL	Israel				
IM	Isle of Man				
IN	India				
IQ	Iraq				
IR	Iran (Islamic Republic of)				
IS	Iceland				
IT	Italy				
JE	Jersey				
JM	Jamaica				
JO	Jordan				
JP	Japan				
KE	Kenya				
KG	Kyrgyzstan				
KH	Cambodia				
KI	Kiribati				
KM	Saint Kitts and Nevis				
KP	Democratic People's Republic of Korea				
KR	Republic of Korea				
KW	Kuwait				
KY	Cayman Islands				
KZ	Kazakhstan				
LA	Lao People's Democratic Republic				
LB	Lebanon				
LC	Saint Lucia				
LI	Liechtenstein				
LK	Sri Lanka				
LR	Liberia				
LS	Lesotho				
LT	Lithuania				
LU	Luxembourg				
LV	Latvia				
LY	Libyan Arab Jamahiriya				
MA	Morocco				
MC	Monaco				
MD	Republic of Moldova				
ME	Montenegro				
MG	Madagascar				
MK	The former Yugoslav Republic of Macedonia				
ML	Mali				
MM	Myanmar				
MN	Mongolia				
MO	Macao				
MP	Northern Mariana Islands				
MR	Mauritania				
MS	Montserrat				
MT	Malta				
MU	Mauritius				
MV	Maldives				
MW	Malawi				
MX	Mexico				
MY	Malaysia				
MZ	Mozambique				
NA	Namibia				
NE	Niger				
NG	Nigeria				
NI	Nicaragua				
NL	Netherlands				
NO	Norway				
NP	Nepal				
NR	Nauru				
NZ	New Zealand				
OA	African Intellectual Property Organization (OAPI)				
OM	Oman				
PA	Panama				
PE	Peru				
PG	Papua New Guinea				
PH	Philippines				
PK	Pakistan				
PL	Poland				
PT	Portugal				
PW	Palau				
PY	Paraguay				
QA	Qatar				
QZ	Community Plant Variety Office (European Community) (CPVO)				
RO	Romania				
RS	Serbia				
RU	Russian Federation				
RW	Rwanda				
SA	Saudi Arabia				
SB	Solomon Islands				
SC	Seychelles				
SD	Sudan				
SG	Singapore				
SH	Saint Helena				
SI	Slovenia				
SK	Slovakia				
SL	Sierra Leone				
SM	San Marino				
SN	Senegal				
SO	Somalia				
SR	Suriname				
ST	Sao Tome and Principe				
SV	El Salvador				
SY	Syrian Arab Republic				
SZ	Swaziland				
TC	Turks and Caicos Islands				
TD	Chad				
TG	Togo				
TH	Thailand				
TJ	Tajikistan				
TL	Timor-Leste				
TM	Turkmenistan				
TN	Tunisia				
TO	Tonga				
TR	Turkey				
SE	Sweden				
TT	Trinidad and Tobago				
TV	Tuvalu				
TW	Taiwan, Province of China				
TZ	United Republic of Tanzania				
UA	Ukraine				
UG	Uganda				
US	United States of America				
UY	Uruguay				
UZ	Uzbekistan				
VA	Holy See				
VC	Saint Vincent and the Grenadines				
VE	Venezuela				
VG	Virgin Islands (British)				
VN	Viet Nam				
VU	Vanuatu				
WO	World Intellectual Property Organization (WIPO)				
WS	Samoa				
XN	Nordic Patent Institute (NPI)				
YE	Yemen				
ZA	South Africa				
ZM	Zambia				
ZW	Zimbabwe				

**NATIONAL INTELLECTUAL PROPERTY CENTER OF GEORGIA
SAKPATENTI**

**OFFICIAL BULLETIN
OF THE INDUSTRIAL PROPERTY**

13(449)

**INVENTIONS
UTILITY MODELS
DESIGNS
TRADEMARKS
APPELLATIONS OF ORIGIN**

**DATE OF PUBLICATION
2016 07 11**

CONTENTS

PUBLISHED TITLES OF PROTECTION	3
INVENTIONS	
▪ APPLICATIONS APPROVED FOR GRANTING PATENTS	4
▪ PATENTED INVENTIONS	9
UTILITY MODELS	
▪ PATENTED UTILITY MODELS	11
DESIGNS	
▪ DESIGNS REGISTERED ACCORDING TO THE ACCELERATED PROCEDURE	12
▪ DESIGNS REGISTERED WITH THE INTERNATIONAL BUREAU CLAIMING PRIORITY ON THE TERRITORY OF GEORGIA	14
TRADEMARKS	
▪ APPLICATIONS FILED UNDER THE NATIONAL PROCEDURE APPROVED FOR REGISTRATION	79
▪ REGISTERED TRADEMARKS	86
▪ TRADEMARKS REGISTERED ACCORDING TO THE ACCELERATED PROCEDURE	94
▪ INTERNATIONAL TRADEMARKS FOR WHICH A DECISION ON GRANTING PROTECTION IS TAKEN	97
▪ INTERNATIONAL TRADEMARKS PROTECTED IN GEORGIA	129
APPELLATIONS OF ORIGIN OF GOODS	
▪ THE RIGHT TO USE OF REGISTERED APPLICATION OF ORIGIN	146
OFFICIAL NOTIFICATIONS	
INVENTIONS	
▪ RENEWAL OF A PATENT	147
UTILITY MODELS	
▪ RENEWAL OF A PATENTS	147
TRADEMARKS	
▪ RENEWAL OF REGISTRATIONS	148
▪ COMPLETE TRANSFER OF RIGHTS	165
▪ CHANGES IN NAMES AND/OR ADDRESSES OF OWNERS	166
CLASSIFICATION INDEXES	
INVENTIONS	167
UTILITY MODELS	169
DESIGNS	170
TRADEMARKS	171

PUBLISHED TITLES OF PROTECTION

INVENTIONS

- **APPLICATIONS APPROVED FOR GRANTING PATENTS:**
13719; 13553; 13778; 13405; 13724; 13827; 13564; 13658
- **PATENTED INVENTIONS:**
6506-6512

UTILITY MODELS

- **PATENTED UTILITY MODELS:**
1900-1902

DESIGNS

- **DESIGN REGISTERED ACCORDING TO THE ACCELERATED PROCEDURE:**
683
- **DESIGNS REGISTERED WITH THE INTERNATIONAL BUREAU CLAIMING PRIORITY ON THE TERRITORY OF GEORGIA:**
87942; 88092; 90227; 88089- 88091; 88093; 88101; 88419; 89691; 88150; 87551; 87558; 87584; 87589; 87592, 87593; 87597; 88236; 88280; 88464; 90456; 90494; 90545; 87222, 87223; 87646; 88369, 88370; 88442; 90601

TRADEMARKS

- **APPLICATIONS FILED UNDER THE NATIONAL PROCEDURE APPROVED FOR REGISTRATION:**
71960*; 79686*; 81347*; 81987*; 80913; 82659; 83543; 83859; 84090; 84152; 84161; 84169; 84176; 84207, 84208; 84258; 84390; 84427; 84429; 84574; 84613; 84624; 84626; 84672; 84680; 84700-84702; 84793; 84800; 84802; 84930; 84986; 84989, 84990; 85113, 85114; 85229, 85230
- **REGISTERED TRADEMARKS:**
27211-27240; 27244-27264; 27268-27310
- **TRADEMARKS REGISTERED ACCORDING TO THE ACCELERATED PROCEDURE:**
27210; 27241-27243; 27265-27267; 27311-27314
- **INTERNATIONAL TRADEMARKS FOR WHICH A DECISION ON GRANTING PROTECTIONS IS TAKEN:**
80629*; 81020*; 83221; 83384; 83538; 83599; 83603; 83611, 83612; 83614; 83623; 83625; 83675, 83676; 83680; 83685-83687; 83690; 83693, 83694; 83696; 83745; 83747; 83774-83776; 83847, 83848; 83860, 83861; 83866-83868; 83871, 83872; 83876; 83954-83958; 83968-83972; 83977, 83978; 83980-83983; 83986; 83988; 84102; 84105, 84106; 84123; 84127; 84131, 84132; 84134; 84141; 84144; 84181; 84186, 84187; 84351; 84356; 84365; 84368; 84376; 84382, 84383; 84386; 84514
- **INTERNATIONAL TRADEMARKS PROTECTED IN GEORGIA:**
78886; 78932; 78940; 79102; 79377; 79799; 81062; 81146; 81174; 81634; 81658; 81812; 81842; 81850; 81852; 81962; 82035-82041; 82043-82046; 82048; 82050, 82051; 82053-82055; 82058, 82059; 82065- -82078; 82080; 82082-82084; 82086; 82089; 82091, 82092; 82094-82108; 82114; 82117; 82119; 82130; 82139; 82152; 82154; 82176; 82178; 82180; 82182-82196; 82198-82200; 82206; 82267, 82268; 82273; 82275; 82284-82286; 82291-82299; 82303; 82306-82308; 82310, 82311; 82317-82321; 82325-82335; 82337, 82338; 82340; 82368; 82372-82376; 82378; 82380, 82381; 82383-82386; 82389; 82395-82397; 82399-82403; 82406, 82407; 82410-82412; 82414; 82418; 82420-82429; 82431; 82478, 82479; 82482; 82485, 82486; 82500; 82502; 82504; 82506, 82507; 82550, 82551; 82553, 82554; 82556-82561; 82564; 82574; 82625-82627; 82635; 82638, 82639; 82642-82645; 82647; 82650-82656; 82658; 82662; 82664; 82666-82671; 82752; 82763; 82766, 82767; 82769; 82773; 82792; 82805; 82807; 82810, 82811; 82857, 82858; 82861; 82863

APPELLATIONS OF ORIGIN OF GOODS

- **THE RIGHT TU USE OF REGISTERED APPELLATION OF ORIGIN:**
823

INVENTIONS

APPLICATIONS APPROVED FOR GRANTING PATENTS

The decision can be appealed at the Chamber of Appeal of Sakpatenti within 3 months from the publication or at the Mtskheta District Court Administrative Cases Board (Address: №17, Samkhedro str., Mtskheta), within 1 month following the publication.

PART A

A 21

(10) AP 2016 13719 A (51) Int. Cl. (2006)

A 21 D 8/02

A 21 D 13/04

(21) AP 2015 013719 (22) 2015 02 05

(71) Maria Silagadze (GE)

26 Maisis q. 45, 4600, Kutaisi (GE);

Eliza Pruidze (GE)

Rustavelis q. 137/36, 4600, Kutaisi (GE);

Giorgi Pkhakadze (GE)

26 Maisis q. 45, 4600, Kutaisi (GE);

Nikoloz Pkhakadze (GE)

26 Maisis q. 45, 4600, Kutaisi (GE);

Sopio Gachechiladze (GE)

Titsian Tabidzis q. 28/9, 4600, Kutaisi (GE);

Khatia Khvadagiani (GE)

Tabukashvilis q. 183/76, 4600, Kutaisi (GE)

(72) Maria Silagadze (GE);

Eliza Pruidze (GE);

Giorgi Pkhakadze (GE);

Nikoloz Pkhakadze (GE);

Sopio Gachechiladze (GE);

Khatia Khvadagiani (GE)

(54) METHOD FOR BIOLOGICAL APPRECIATED VALUE GLUTEN-FREE BREAD PREPARATION FOR SICK PEOPLE WITH CELIAC DISEASE

(57) A method provides rice and buckwheat flour, corn starch, amaranth or pea flour, apple or orange marc powder, germinated soya flour, carbonated mineral water – Borjomi or Sairme of medium mineralization 5-10 g/dm³, salt, vegetable oil and yeast usage, fermentation, to form, proof and bake thereof.

Claims: 1 independent

A 23

(10) AP 2016 13553 A (51) Int. Cl. (2006)

A 23 L 1/28

(21) AP 2014 013553 (22) 2014 08 18

(71) Zurab Dzneladze (GE)

Metsnierebis q. 9, b. 5, 3500, Ozurgeti (GE)

(72) Zurab Dzneladze (GE)

(54) METHOD FOR IODIZED

CONCENTRATE PRODUCTION

(57) A method provides actinidia foliage and fruits first and second washout water extracts preparation, potassium iodide introduction into 15 mg first washout water extract, syrop preparation from second washout water extract, and mixing therein correlation 1:4.

Claims: 1 independent

Tables: 2

A 61

(10) AP 2016 13778 A (51) Int. Cl. (2006)

A 61 B 17/32

A 61 B 17/34

A 61 F 2/10

(21) AP 2015 013778 (22) 2015 03 31

(71) Tamaz Shioshvili (GE)

Ir. Abashidzis q. 46, b. 17, 0179, Tbilisi (GE);

Petre Badalov (GE)

Vazha-Pshavelas gamz., kvart. IV., korp. 11, b. 28, 0186, Tbilisi (GE)

(72) Tamaz Shioshvili (GE);

Petre Badalov (GE)

(54) DEVICE FOR MAKING RECESS IN SKIN FOR FREE HAIR ROOTS TRANSPLANTATION

(57) A device includes group of needles 1 rigidly disposed into a fastener 2 having one by one channel 3 and cut 4 in opposite sides, and one general handle 5. The device includes a frame 6 having a window 7 in the middle, as well; and guide bars 8 are disposed on frame opposite sides. At that, the fastener with needles is executed capable to instal and remove frame; and channels and cuts disposition and inclination angle on the fastener correspond guide bars disposition on the frame.

Claims: 1 independent
5 dependent
Fig.: 6

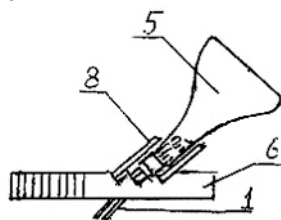
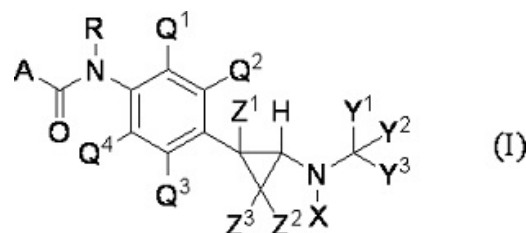

Fig. 6

(10) AP 2016 13405 A (51) Int. Cl. (2006)
A 61 K 31/167
A 61 K 31/36
A 61 K 31/366
A 61 K 31/381
A 61 K 31/40
A 61 K 31/402
A 61 K 31/4035
A 61 K 31/404
A 61 K 31/4184
A 61 K 31/42
A 61 K 31/421
A 61 K 31/426
A 61 K 31/428
A 61 K 31/429
A 61 K 31/433
A 61 K 31/4406
A 61 K 31/4409
A 61 K 31/4453
A 61 K 31/4468
A 61 K 31/495
A 61 K 31/55
A 61 P 35/00
A 61 P 35/02
C 07 C 233/80
C 07 C 235/56
C 07 C 237/40
C 07 C 271/22
C 07 D 207/06
C 07 D 207/337
C 07 D 209/08
C 07 D 209/42
C 07 D 209/46
C 07 D 211/76
C 07 D 213/04
C 07 D 213/38
C 07 D 213/56
C 07 D 223/16
C 07 D 231/14
C 07 D 231/20
C 07 D 231/22
C 07 D 231/56
C 07 D 233/61
C 07 D 233/64

C 07 D 239/36
C 07 D 261/08
C 07 D 263/32
C 07 D 263/34
C 07 D 277/62
C 07 D 277/20
C 07 D 277/28
C 07 D 277/30
C 07 D 285/06
C 07 D 295/14
C 07 D 309/14
C 07 D 317/58
C 07 D 333/20
C 07 D 405/04
C 07 D 409/04
C 07 D 471/04
C 07 D 495/04
C 07 D 513/04

(21) AP 2012 013405 (22) 2012 08 08
(31) 2011-174305
(32) 2011 08 09
(33) JP
(71) TAKEDA PHARMACEUTICAL
COMPANY LIMITED (JP)
1-1, Doshomachi 4-chome, Chuo-ku,
Osaka-shi, Osaka 5410045 (JP)
(72) TOMITA, Naoki (JP);
KAJII, Shigeo (JP);
CARY, Douglas Robert (JP);
TOMITA, Daisuke (JP);
IMAMURA, Shinichi (JP);
TSUCHIDA, Ken (JP);
MATSUDA, Satoru (JP);
HARA, Ryujiro (JP)
(74) Shalva Gvaramadze
(85) 2014 03 04
(86) PCT/JP2012/070267, 2012 08 08
(54) CYCLOPROPANEAMINE COMPOUND
(57) Compound of formula (I),



wherein values of substituents A, Z¹, Z², Z³, Q¹, Q², Q³, Q⁴, X, R, Y¹, Y² and Y³ or their salt, and medicine on basis thereof are provided in the claims; said compound and salt application for schizophrenia, Alzheimer's and Parkinson's diseases or Huntington's chorea prevention and treatment.

Claims: 10 independent
9 dependent
Tables: 17

A 62**(10) AP 2016 13724 A (51) Int. Cl. (2006)****A 62 C 2/06****E 21 F 43/12**

(21) AP 2015 013724 (22) 2015 02 05

(71) Vladimer Loladze (GE)

Bakhtrionis q., korp. I, b. 13, 0194,
Tbilisi (GE);

Vakhtang Loladze (GE)

Bakhtrionis q., korp. I, b. 13, 0194,
Tbilisi (GE);

Giorgi Loladze (GE)

Paliashvilis q. 37/2, 0179, Tbilisi (GE);

Nino Loladze (GE)

Paliashvilis q. 37/2, 0179, Tbilisi (GE)

(72) Vladimer Loladze (GE);

Vakhtang Loladze (GE);

Giorgi Loladze (GE);

Nino Loladze (GE)

(54) DEVICE FOR FIRE**EXTINGUISHING AND ENERGY
CARRIER REJECTED FROM
DAMAGED HEEL OR PIPE DUCT
WITHDRAWAL**

(57) A device is appropriated for fire extinguishing and energy carrier rejected from existed on water surface or water area bottom damaged heel or pipe duct withdrawal; and includes multilayer, assembled crown 1 made of flexible, fire-resistant material perforated 6 with valves on side surface for fire extinguishing material supplement; at least one toolholder equipped with connected thereto at least one branch is connected to crown top. Each toolholder and branch are equipped with arrangement having individual power control and connected together capable of automatic toggle, valves and/or chokes 21 and means 13 for changing direction and detecting place of their disposition. The pumps are placed into the toolholders, and combined with disposed in alignment therewith the emulsifiers and crushing and grinding or crystalline hydrate transforming into water or gas arrangements. A hole 22 is cut at least in one component consisting crown; and sealing collar 23 is placed thereto cover damaged pipe duct with the crown.

Claims: 1 independent
2 dependent

Fig.: 15

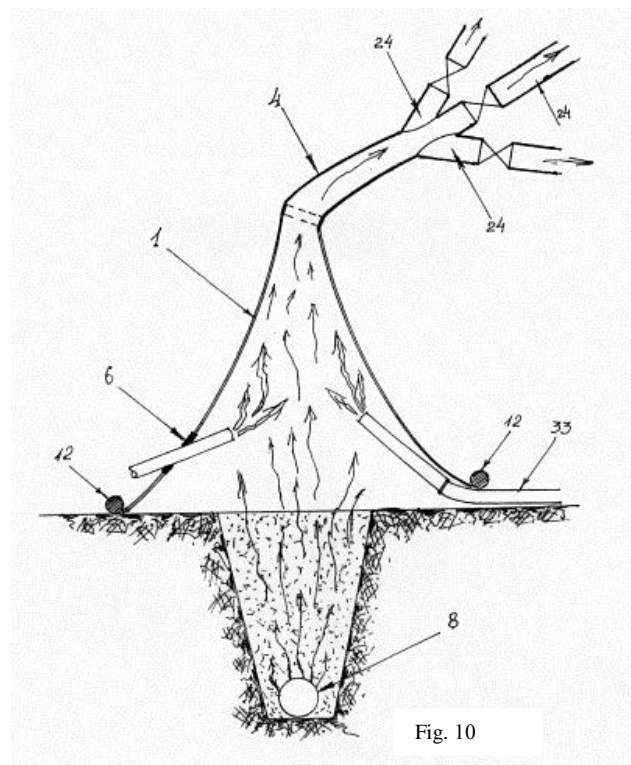
**PART B****B 61****(10) AP 2016 13827 A (51) Int. Cl. (2006)****B 61 B 12/00****E 01 D 19/04**

(21) AP 2015 013827 (22) 2015 05 15

(71) LEPL GRIGOL TSULUKIDZE MINING
INSTITUTE (GE)

Mindelis q. 7, 0186, Tbilisi (GE);

Davit Pataraiia (GE)

Shartavas q. 18, b. 16, 0160, Tbilisi (GE);

Aleksandre Kartvelishvili (GE)

Vazha-Pshavelas gamz. 59, b. 15, 0186,
Tbilisi (GE);

Giorgi Nozadze (GE)

Temkis das., IV mkr., korp. 6, b. 37, 0178,
Tbilisi (GE);

Rusudan Maisuradze (GE)

Nutsunidzis plato IV mkr., korp. 23, b. 1,
0183, Tbilisi (GE)

(72) Davit Pataraiia (GE);

Aleksandre Kartvelishvili (GE);

Giorgi Nozadze (GE);

Rusudan Maisuradze (GE)

(54) INCLINED ABUTMENT BASE

(57) A base includes bearing socket B having hemicylindrical case and inner socket A placed therein. Bearing socket has the blades 7 wherein the

openings 8 are executed. A lattice consisted of radially disposed assembly openings 3, to connect sockets to each other, is placed on case bases. Metallic webbing of rigidity 4 is fastened inside of socket. Bearing socket openings are disposed straight on the blades; and assembly openings executed on the base are oval-shaped.

Claims: 1 independent
1 dependent

Fig.: 3

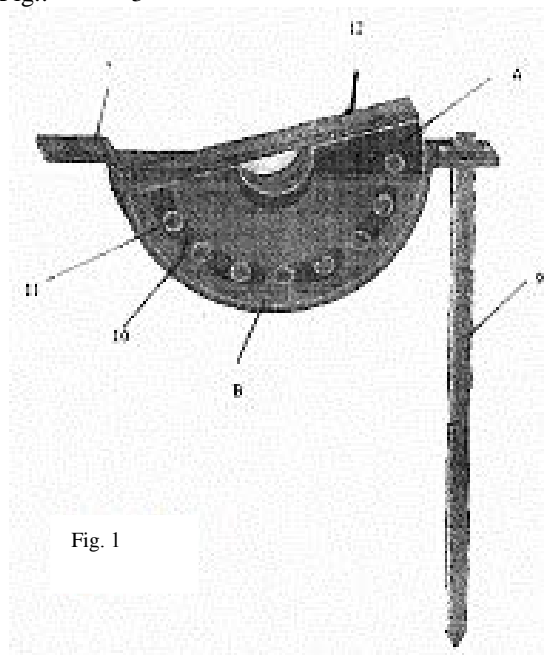

DEAL, Judith, Gail (US);
HOFFMAN, Robert, Louis (US);
HUANG, Qinhuo (CN);
JOHNSON, Ted, William (US);
KANIA, Robert, Steven (US);
KATH, John, Charles (US);
LE, Phuong, Thi, Quy (US);
MCTIGUE, Michele, Ann (US);
PALMER, Cynthia, Louise (US);
RICHARDSON, Paul, Francis (GB);
SACH, Neal, William (GB)

(74) Shalva Gvaramadze

(85) 2014 09 01

(86) PCT/IB2013/051391, 2013 02 20

(54) **MACROCYCLIC DERIVATIVES
FOR THE TREATMENT OF
PROLIFERATIVE DISEASES**

(57) Compound of formula (I),

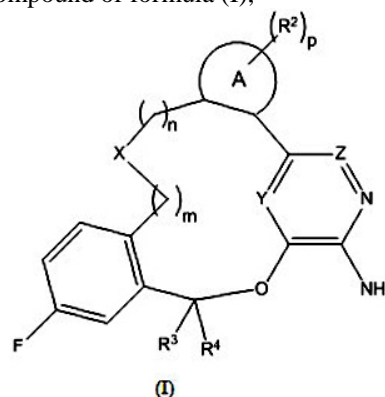

which substitute A is selected from C6-C12 aryl and 5-6 member heteroaryl, and values of R², R³, R⁴, X, Y, Z and n, m, p substitutes are provided in the claims or their pharmaceutically acceptable salt, and composition on basis thereof; application of said compound or salt therefor cancer treating medicine preparation.

Claims: 5 independent
11 dependent

Tables: 1

Fig.: 1

PART C

C 07

(10) AP 2016 13564 A (51) Int. Cl. (2006)
C 07 D 491/08
C 07 D 491/18
C 07 D 498/08
C 07 D 498/18
C 07 D 498/22
C 07 D 513/18
A 61 K 31/4353
A 61 P 35/00

(21) AP 2013 013564 (22) 2013 02 20

(31) 61/607,485; 61/759,307

(32) 2012 03 06; 2013 01 31

(33) US; US

(71) PFIZER INC. (US)

235 East 42nd Street New York,
NY 10017 (US)

(72) BAILEY, Simon (GB);

BURKE, Benjamin, Joseph (US);

COLLINS, Michael, Raymond (US);

CUI, Jingrong, Jean (US);

PART H

H 02

(10) AP 2016 13658 A (51) Int. Cl. (2006)
H 02 P 9/00

(21) AP 2014 013658 (22) 2014 12 09

(71) Leri Giorgadze (GE)
Zh. Shartavas gamz. 11, b. 6, 3700,
Rustavi (GE)

(72) Leri Giorgadze (GE);
Lia Giorgadze (GE)

(54) **METHOD FOR GENERATOR
ACTUATION AND DEVICE FOR
REALIZATION THEREOF**

(57) A method for generator actuation with actuate generator application provides: two-phase voltage application for actuation of actuate generator, wherein sinusoidal voltages are shifted relative to each other on 90 electrical degrees; two-phase voltage generation, wherein nonsinusoidal voltages are shifted relative to each other on 90 electrical degrees; summation of said voltages and supplement on power generator actuate coil.

Claims: 2 independent

Fig.: 1

PATENTED INVENTIONS

PART A

A 01

- (11) **P 2016 6506 B** (51) **Int. Cl. (2006)**
A 01 N 43/42
A 61 K 31/47
- (10) AP 2016 12786 A (44) 6(442)/2016
 (21) AP 2010 012786
 (22) 2010 12 13
 (24) 2010 12 13
 (31) 61/287,535
 (32) 2009 12 17
 (33) US
 (86) PCT/US2010/060007, 2010 12 13
 (73) MERCK SHARP & DOHME CORP. (US)
 126 East Lincoln Avenue Rahway,
 New Jersey 07065-0907 (US)
 (72) KUDUK, Scott, D. (US);
 SCHLEGEL, Kelly-Ann (US);
 YANG, Zhi-Qiang (US)
 (74) Shalva Gvaramadze
 (54) **QUINOLINE AMIDE M1 RECEPTOR**
POSITIVE ALLOSTERIC
MODULATORS

PART B

B 01

- (11) **P 2016 6511 B** (51) **Int. Cl. (2006)**
B 01 D 3/02
C 12 G 3/12
- (10) AP 2016 13559 A (44) 6(442)/2016
 (21) AP 2014 013559
 (22) 2014 08 25
 (24) 2014 08 25
 (73) Aleksandre Kvernadze (GE)
 Dighmis mas., V kvart., korp. 25a, b. 48,
 0159, Tbilisi (GE)
 (72) Aleksandre Kvernadze (GE)
 (54) **DEVICE FOR DISTILLING VODKA**

B 29

- (11) **P 2016 6509 B** (51) **Int. Cl. (2006)**
B 29 D 7/24
B 29 C 55/10
- (10) AP 2016 13456 A (44) 6(442)/2016
 (21) AP 2014 013456
 (22) 2014 05 01
 (24) 2014 05 01
 (73) Levan Nadareishvili (GE)
 Antonovskaias q. 9, b. 57, 0187, Tbilisi (GE)
 (72) Levan Nadareishvili (GE)
 (54) **NADAREISHVILI DEVICE FOR**
STRETCHING POLYMERIC SAMPLES

PART C

C 03

- (11) **P 2016 6508 B** (51) **Int. Cl. (2006)**
C 03 C 1/00
C 03 C 1/02
C 03 C 13/06
- (10) AP 2016 13169 A (44) 6(442)/2016
 (21) AP 2011 013169
 (22) 2011 12 21
 (24) 2011 12 21
 (31) A2117/2010
 (32) 2010 12 22
 (33) AT
 (86) PCT/AT2011/050051, 2011 12 21
 (73) AZA. TEK GMBH (AT)
 Seestraße 59, 3550, Langenlois (AT)
 (72) SCHINKINGER, Thomas (AT);
 MAYER, Anton (AT)
 (74) Tamaz Shilakadze
 (54) **RAW MATERIAL FOR PRODUCING**
BASALT FIBERS

C 07

- (11) **P 2016 6507 B** (51) **Int. Cl. (2006)**
C 07 D 471/04
C 07 D 473/28
C 07 D 487/04
C 07 D 498/04
A 61 K 31/4355
A 61 K 31/437
A 61 K 31/4427
A 61 K 31/4985

A 61 K 31/5025
A 61 K 31/519
A 61 K 31/52
A 61 P 25/18

- (10) AP 2016 12970 A (44) 6(442)/2016
 (21) AP 2011 012970
 (22) 2011 06 22
 (24) 2011 06 22
 (31) 61/358,121; 61/422,845
 (32) 2010 06 24; 2010 12 14
 (33) US; US
 (86) PCT/US2011/041443, 2011 06 22
 (73) TAKEDA PHARMACEUTICAL
 COMPANY LIMITED (JP)
 1-1, Doshomachi 4-chome, Chuo-ku
 Osaka-shi, Osaka, 541-0045 (JP)
 (72) TANIGUCHI, Takahiko (JP);
 YOSHIKAWA, Masato (JP);
 MIURA, Kasei (JP);
 HASUI, Tomoaki (JP);
 HONDA, Eiji (JP);
 IMAMURA, Keisuke (JP);
 KAMATA, Makoto (JP);
 KAMISAKI, Haruhi (JP);
 QUINN, John, F. (US);
 RAKER, Joseph (US);
 CAMARA, Fatoumata (FR);
 WANG, Yi (CH)
 (74) Shalva Gvaramadze
 (54) **FUSED HETEROCYCLIC COMPOUNDS
 AS PHOSPHODIESTERASES (PDES)
 INHIBITORS**

**THERMOPLASTIC IN COMPOSITE
 MATERIAL PRODUCTION**

C 23

- (11) P 2016 6512 B** (51) **Int. Cl. (2006)
 C 23 C 14/35**
 (10) AP 2016 13835 A (44) 6(442)/2016
 (21) AP 2015 013835
 (22) 2015 05 28
 (24) 2015 05 28
 (73) Zaur Berishvili (GE)
 Dighmis masivi III kvart., korp. 36, b. 87,
 0159, Tbilisi (GE)
 (72) Zaur Berishvili (GE)
 (54) **PLANAR MAGNETRON SPUTTER**

C 08

- (11) P 2016 6510 B** (51) **Int. Cl. (2006)
 C 08 J 11/04
 C 08 J 11/06
 B 29 B 17/00
 B 29 B 17/02
 B 29 B 17/04
 B 29 B 7/88
 B 29 B 7/90
 B 29 C 47/10**
 (10) AP 2016 13484 A (44) 6(442)/2016
 (21) AP 2011 013484
 (22) 2011 11 10
 (24) 2011 11 10
 (31) PCT/TR2011/000265
 (32) 2011 11 10
 (33) TR
 (86) PCT/TR2011/000265, 2011 11 10
 (73) GUVEN, Ali Hakan (TR)
 Paris Caddesi, 16/7, 06540 Ankara (TR)
 (72) GUVEN, Ali Hakan (TR)
 (74) Vakhtang Torotadze
 (54) **METHOD FOR RECYCLING WASTE
 THERMOPLASTIC MATERIALS AND
 USING THIS RECYCLED**

UTILITY MODELS

PATENTED UTILITY MODELS

PART A

A 47

- (11) U 2016 1902 Y (51) Int. Cl. (2006)
A 47 G 21/00
(10) AU 2016 13897 U (44) 6(442)/2016
(21) AU 2015 013897
(22) 2015 07 29
(24) 2015 07 29
(73) Giorgi Gvinchidze (GE)
Rustavelis q., me-3 shesakh. 10, Tskneti, 0162,
Tbilisi (GE)
(72) Giorgi Gvinchidze (GE)
(54) **EQUIPMENT FOR HOLDING
"KHINKALI"**
-

PART E

E 04

- (11) U 2016 1901 Y (51) Int. Cl. (2006)
E 04 B 2/42
(10) AU 2016 13834 U (44) 6(442)/2016
(21) AU 2015 013834
(22) 2015 05 22
(24) 2015 05 22
(73) Aleksandre Moseshvili (GE)
Kavtaradzis q. 28, b. 1, 0186, Tbilisi (GE)
(72) Aleksandre Moseshvili (GE)
(54) **HOLLOW CONSTRUCTION BLOCK**
-

PART C

C 25

- (11) U 2016 1900 Y (51) Int. Cl. (2006)
C 25 B 11/02
(10) AU 2016 13773 U (44) 6(442)/2016
(21) AU 2015 013773
(22) 2015 03 27
(24) 2015 03 27
(73) Teimuraz Rokva (GE)
Vazha-Pshavelas V kvart., korp. 1, b. 32,
0186, Tbilisi (GE);
Temur Chakhunashvili (GE)
Panaskertelis q., korp. 17, b. 15, 0194,
Tbilisi (GE);
Dali Dzanashvili (GE)
Nutsbidzis perd., III mkr., II kvart.,
korp. 5, b. 7, 0183, Tbilisi (GE)
(72) Teimuraz Rokva (GE);
Temur Chakhunashvili (GE);
Dali Dzanashvili (GE)
(54) **ANOD COOLED WITH WATER
FOR PRODUCING HIGHLY
DISPERSED ELECTRICAL
MANGANESE DIOXIDE**
-

DESIGNS

DESIGN REGISTERED ACCORDING TO THE ACCELERATED PROCEDURE

The decision can be appealed at the Chamber of Appeal of Sakpatenti within 3 months from the publication.

- (11) D 2016 683 S (51) 32-00
(21) AD 2016 000912 (22) 2016 06 06
(24) 2016 06 06
(28) 15
(18) 2021 06 06
(73) Levan Beriashvili (GE)
Nutsbidzis perd., II kvart., korp. 7, b. 16, 0183, Tbilisi (GE)
(72) Levan Beriashvili (GE)
(74) Vakhtang Torotadze
(54) 1.-15. SURFACE DESIGN
(55)





DESIGNS, WHICH HAVE BEEN REGISTERED WITH THE INTERNATIONAL BUREAU CLAIMING PRIORITY ON THE TERRITORY OF GEORGIA

The decision can be appealed at the Chamber of Appeal of Sakpatenti within 3 months from the publication or at the Mtskheta District Court Administrative Cases Board (Address: №17, Samkhedro Str., Mtskheta), within 1 month following the publication.

(11) DM/087942**(51) 10-07**

(15) 2015 10 23

(45) 2016/17 (2016 04 29)

(22) 2015 10 23

(28) 1

(73) MONTRES JAQUET DROZ SA (MONTRES JAQUET DROZ AG) (MONTRES JAQUET DROZ LTD
Allée du Tourbillon 2, CH-2300 La Chaux-de-Fonds (CH)

(85) CH

(86) CH

(87) CH

(88) CH

(89) CH

(81) II. BZ, MA III. AL, AM, AZ, BA, CH, EM, GE, KG, KR, LI, MC, MD, ME, MK, MN, NO, OM, SG, TN,
TR, UA

(72) Yann Leiggener

Rue du Soleil 16, 2300 La Chaux-de-Fonds, Suisse;

Christian Lattmann

Chemin de Château-Neuf 17, 1125 Monnaz, Suisse

(54) 1. Dial

(55)

1.1



1.2

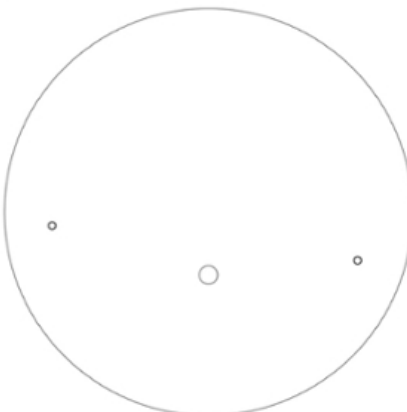

1.3 1.4



1.5

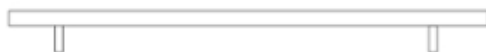

1.6



1.7



(11) DM/088092

(51) 10-02

(15) 2015 10 27

(45) 2016/17 (2016 04 29)

(22) 2015 10 27

(28) 2

(73) SWATCH AG (SWATCH SA) (SWATCH LTD.)

Jakob-Stämpfli-Strasse 94, CH-2502 Biel/Bienne (CH)

(85) CH

(86) CH

(87) CH

(88) CH

(89) CH

(81) II. BZ, MA III. AL, AM, AZ, BA, CH, EM, GE, KG, KR, LI, MC, MD, ME, MK, MN, NO, OM, SG, TN, TR, UA

(72) 1 : Milko BOYAROV

Birmensdorferstrasse 197,8003 Zürich, Suisse;

2 : Anaïs KREBS

Rue de la Côte 21,2000 Neuchâtel, Suisse

(54) 1.-2. Wristwatches

(55)

1

2



(11) DM/090227

(51) 02-04

(15) 2016 04 05

(45) 2016/17 (2016 04 29)

(22) 2016 04 05

(28) 7

(73) VALENTINO S.P.A.

Via Turati, 16/18, I-20121 Milano (IT)

(85) --

(86) EM, IT

(87) EM, IT

(88) EM, IT

(89) EM

(81) III. AZ, EM, GE, JP, KG, KR, TJ, TR, UA

(72) SASSI Stefano

c/o VALENTINO S.p.A., Via Turati, 16/18, I-20121 Milano, Italy

(54) 1.-7. Shoes

(55)

1.1



1.2

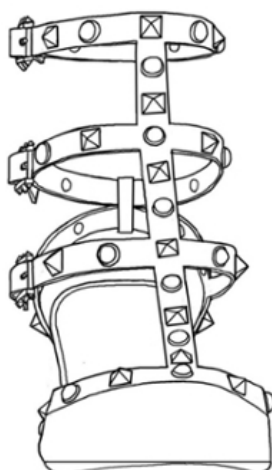

1.3

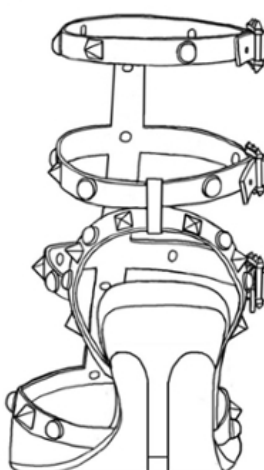

1.4

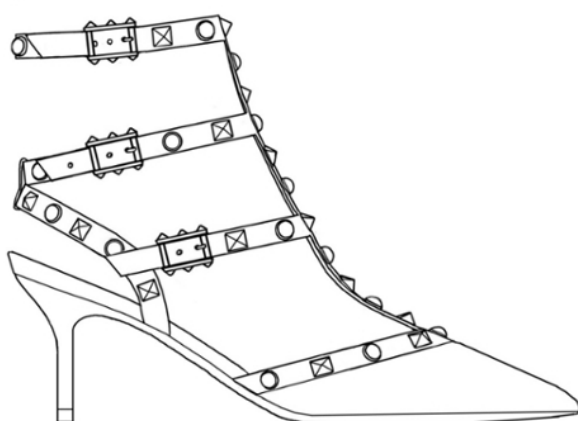

1.5

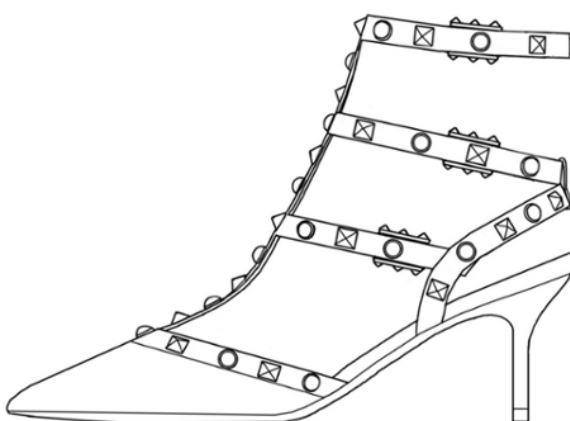

1.6

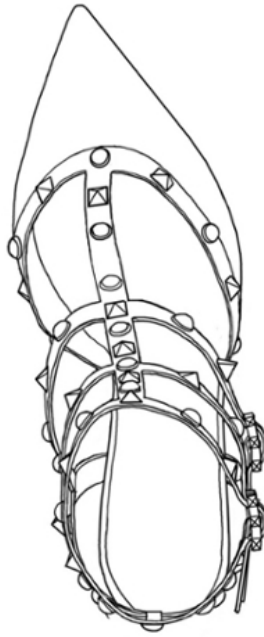

1.7



2.1

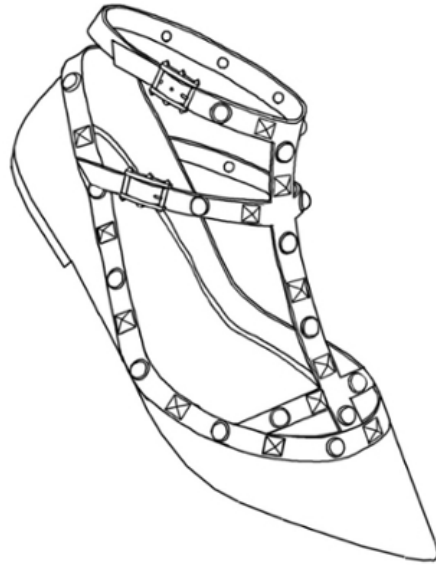

2.2

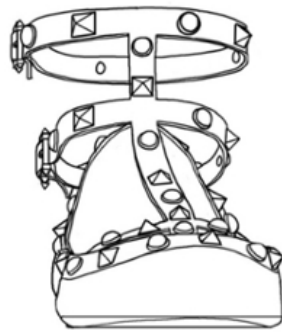

2.3

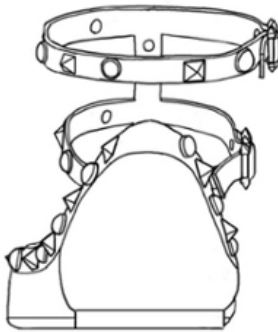

2.4

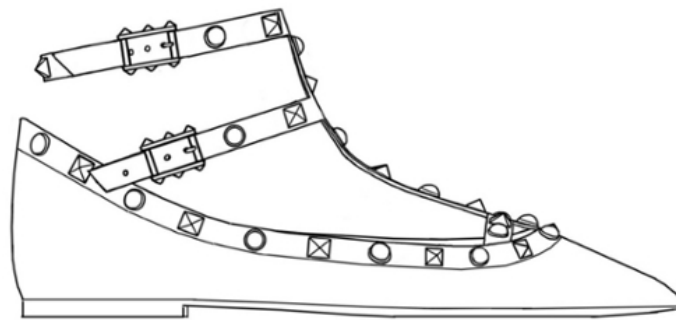

2.5



2.6

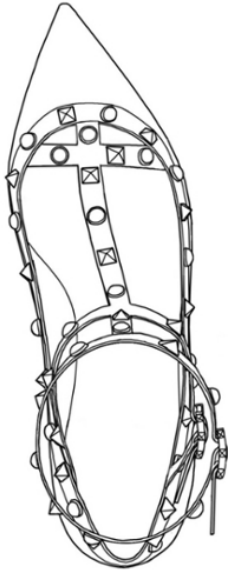

2.7



3.1



3.2

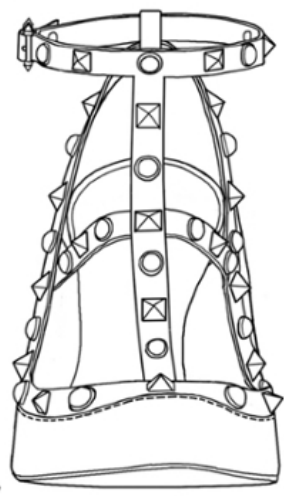

3.3

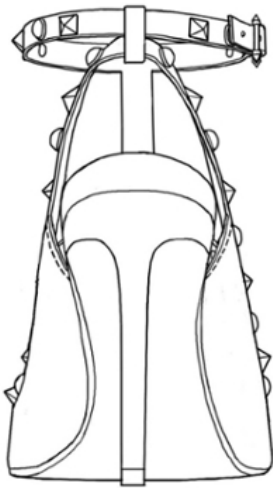

3.4



3.6

3.7

3.5

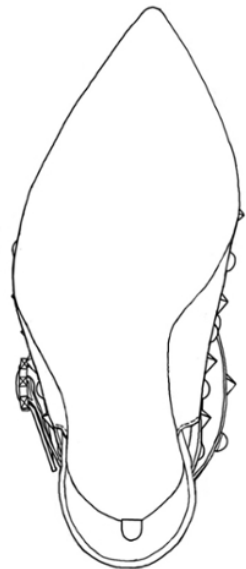
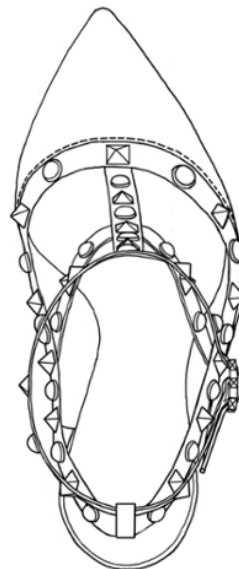

4.1

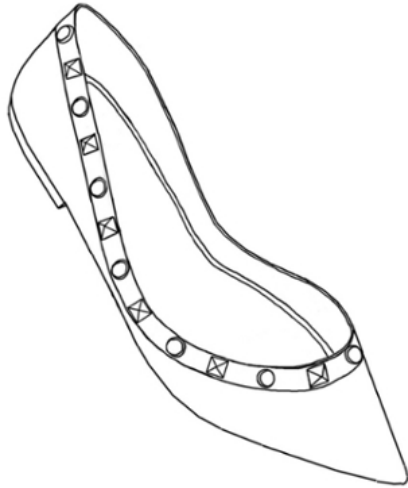

4.2

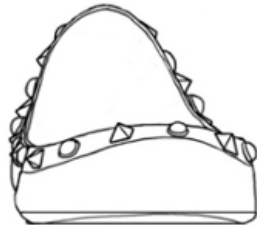

4.3

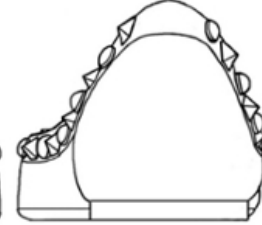

4.4

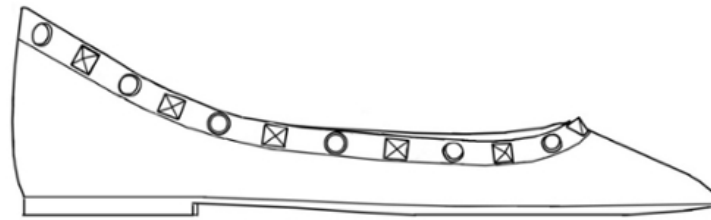

4.6

4.7

4.5

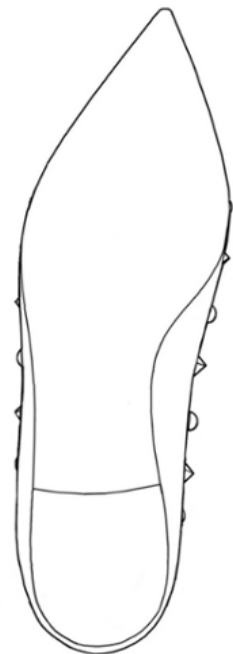
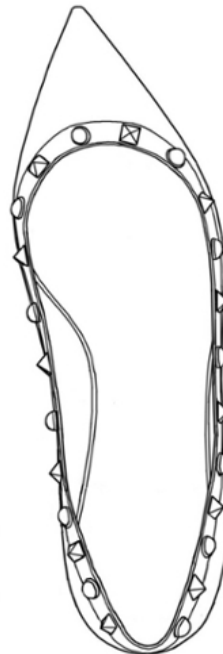
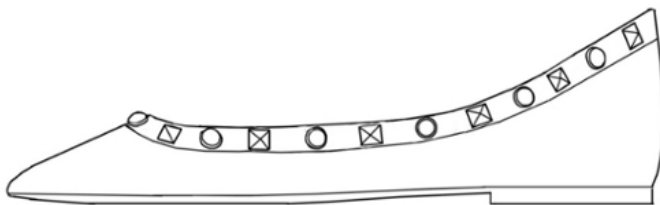

5.1

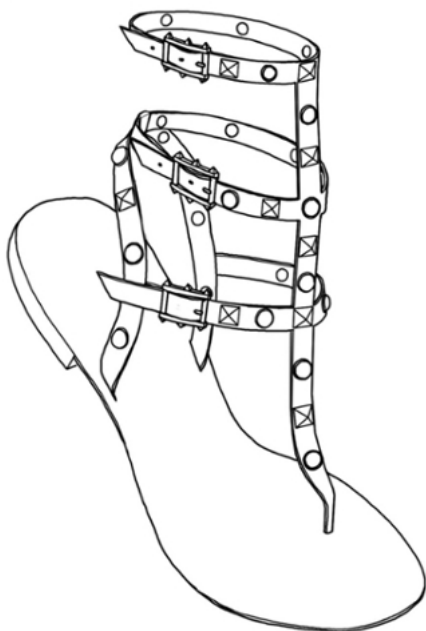

5.2

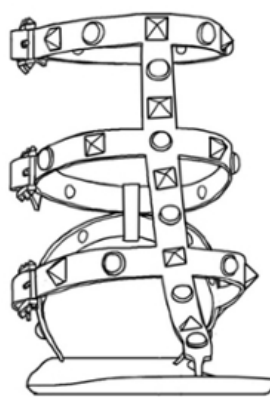

5.3

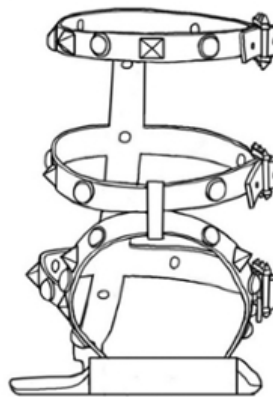

5.4

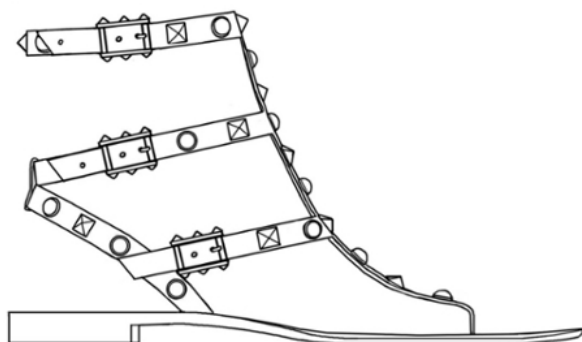

5.5



5.6

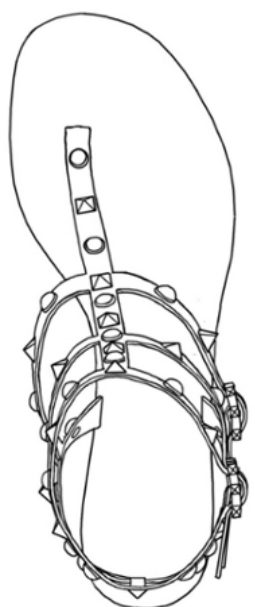

5.7



6.1

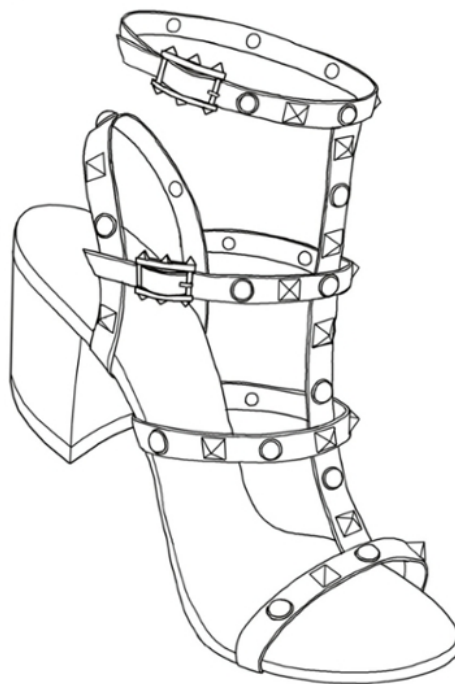

6.2

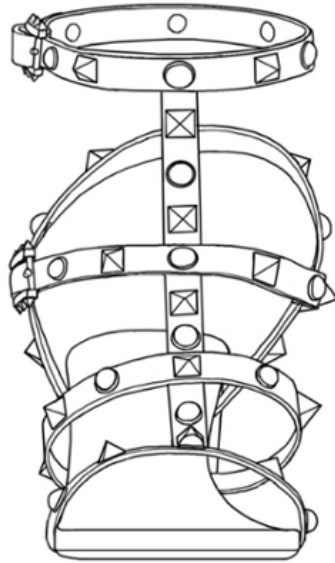

6.3

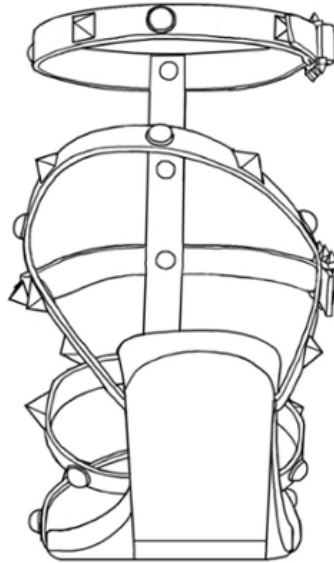

6.4

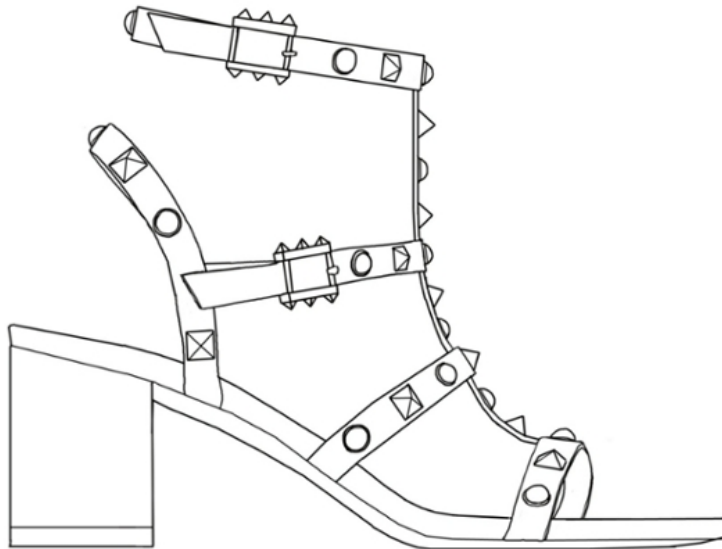

6.5

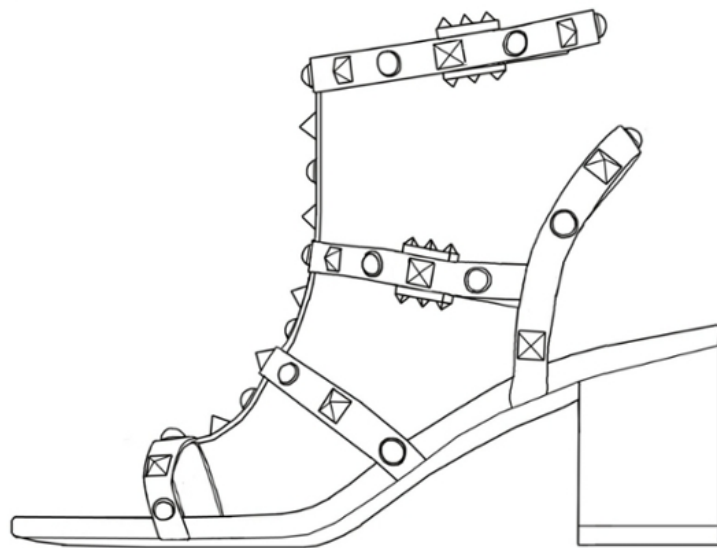

6.6

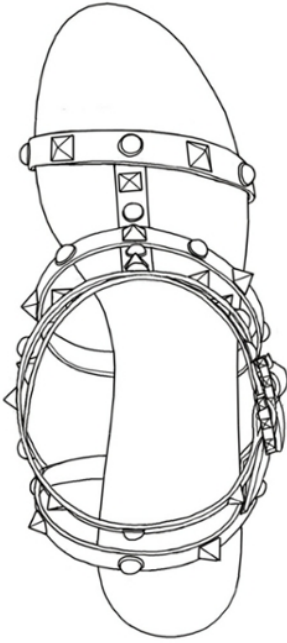

6.7

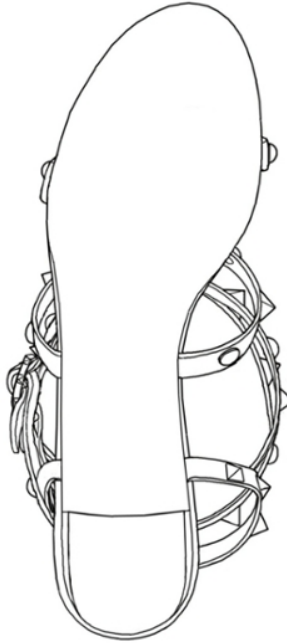

7.1

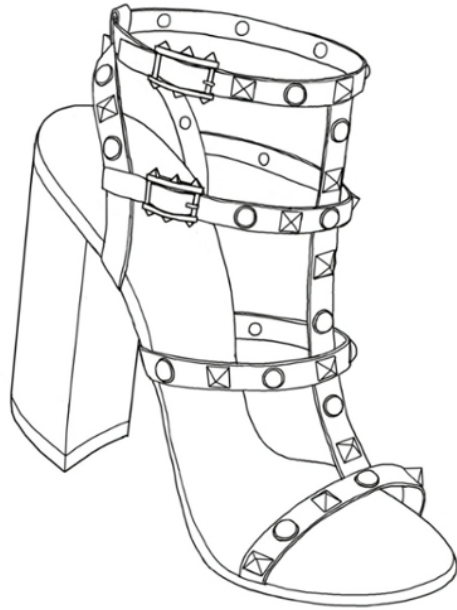

7.2

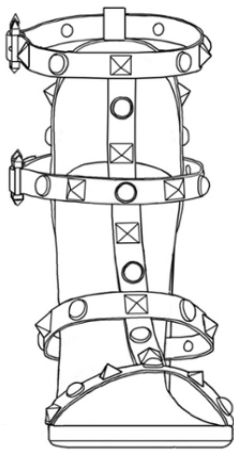

7.3

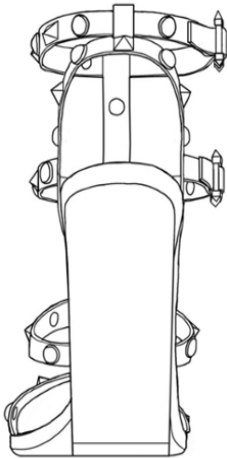

7.4

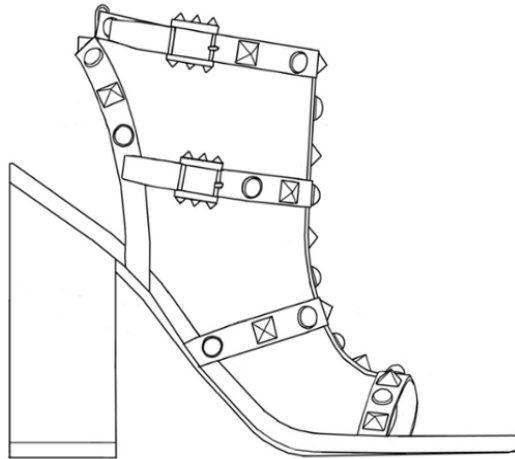

7.6

7.7

7.5

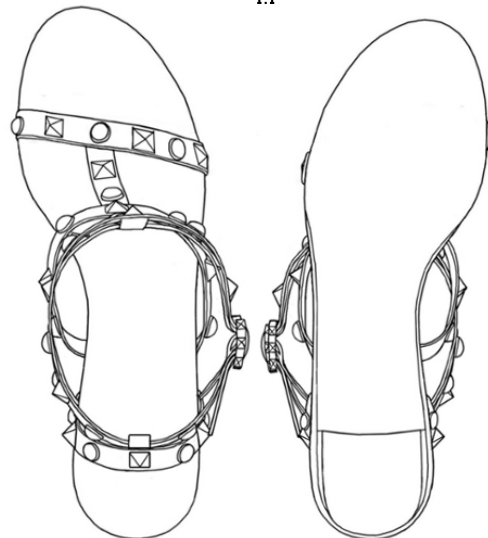
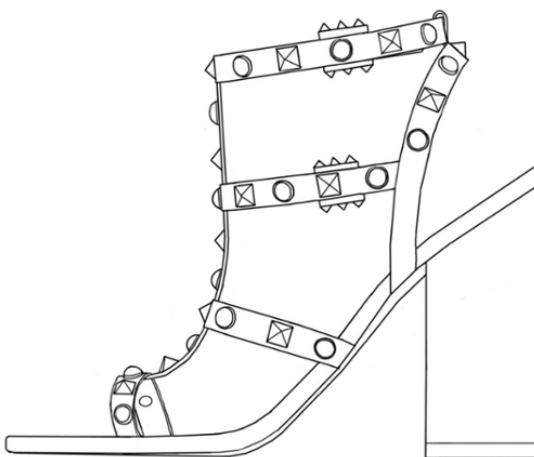

(11) DM/088089

(15) 2015 11 02

(22) 2015 11 02

(28) 1

(73) SWATCH AG (SWATCH SA) (SWATCH LTD.)

Jakob-Stämpfli-Strasse 94, CH-2502 Biel/Bienne (CH)

(85) CH

(86) CH

(87) CH

(88) CH

(89) CH

(81) II. BZ, MA III. AL, AM, AZ, BA, CH, EM, GE, KG, KR, LI, MC, MD, ME, MK, MN, NO, OM, SG, TN, TR, UA

(72) Andrea ARRIGONI

Via Ponte Seveso 39, 20125 Milano, Italie

(54) 1. Wristwatch

(55)

(51) 10-02

(45) 2016/18 (2016 05 06)

1.1



1.2



(11) DM/088090

(51) 11-01

(15) 2015 11 02

(45) 2016/18 (2016 05 06)

(22) 2015 11 02

(28) 2

(73) HARRY WINSTON SA

Chemin du Tourbillon 8, CH-1228 Plan-les-Ouates (CH)

(85) CH

(86) CH

(87) CH

(88) CH

(89) CH

(81) II. BZ, MA III. AL, AM, AZ, BA, CH, EM, GE, KG, KR, LI, MC, MD, ME, MK, MN, NO, OM, SG, TN, TR, UA

(72) 1: Rie YATSUGI-KANG

272 Highland St., 07626 Cresskill, États-Unis d'Amérique;

2: Dominique RIVIERE

360 E. 72nd Street Apt.#b 1003, 10021 New York N.Y., États-Unis d'Amérique

(54) 1. Pendant; 2. Finger ring

(55)

1.1

1.2



1.3



1.7

1.8



1.6



1.4



1.5



2.1



2.2



2.3



2.4



2.5



2.6



2.7



2.8



(11) DM/088091

(15) 2015 11 02

(22) 2015 11 02

(28) 2

(73) SWATCH AG (SWATCH SA) (SWATCH LTD.)

Jakob-Stämpfli-Strasse 94, CH-2502 Biel/Bienne (CH)

(85) CH

(86) CH

(87) CH

(88) CH

(89) CH

(81) II. BZ, MA III. AL, AM, AZ, BA, CH, EM, GE, KG, KR, LI, MC, MD, ME, MK, MN, NO, OM, SG, TN, TR, UA

(72) 1: Martin NORRLIND

Ackersteinstrasse 167, 8049 Zürich, Suisse;

2: Milko BOYAROV

Birmensdorferstrasse 197, 8003 Zürich, Suisse

(54) 1.-2. Wristwatches

(55)

(51) 10-02

(45) 2016/18 (2016 05 06)

1.1



1.2



2



- (11) DM/088093** **(51) 10-02, 07**
 (15) 2015 10 30 (45) 2016/18 (2016 05 06)
 (22) 2015 10 30
 (28) 17
 (73) THE SWATCH GROUP MANAGEMENT SERVICES AG (THE SWATCH GROUP MANAGEMENT SERVICES SA) (THE SWATCH GROUP MANAGEMENT SERVICES LTD.)
 Seevorstadt 6, CH-2502 BIENNE (CH)
 (85) CH
 (86) CH
 (87) CH
 (88) CH
 (89) CH
 (81) II. BZ, MA III. AL, AM, AZ, BA, CH, EM, GE, KG, KR, LI, MC, MD, ME, MK, MN, NO, OM, SG, TN, TR, UA
 (72) 2,5-7,16: Fernando SOARES
 5, rue Fleury, 2000 Neuchâtel, Suisse;
 1,3-4,13: Fabrice DUPORT
 4, Avenue de la Gare, 2000 Neuchâtel, Suisse;
 11-12,15,17: Emmanuel DIETRICH
 Aegeristrasse 66, 6300 Zug, Suisse;
 8-10: Mauro STEFANIZZI
 6, Rue Centrale, 2502 Biel/Bienne, Suisse;
 14: Stefano Russo
 Via Benaco 26, 20139 Milano, Italie
 (54) 1.-3. Watch cases with strap; 4. Wristwatch; 5. Watch case with strap; 6.-7. Wristwatches; 8. Watch case; 9. Watch case with strap; 10. Wristwatch; 11.-12. Watches; 13. Watch case with strap; 14. Swiveling watch case with strap; 15.-17. Watch cases
 (55)

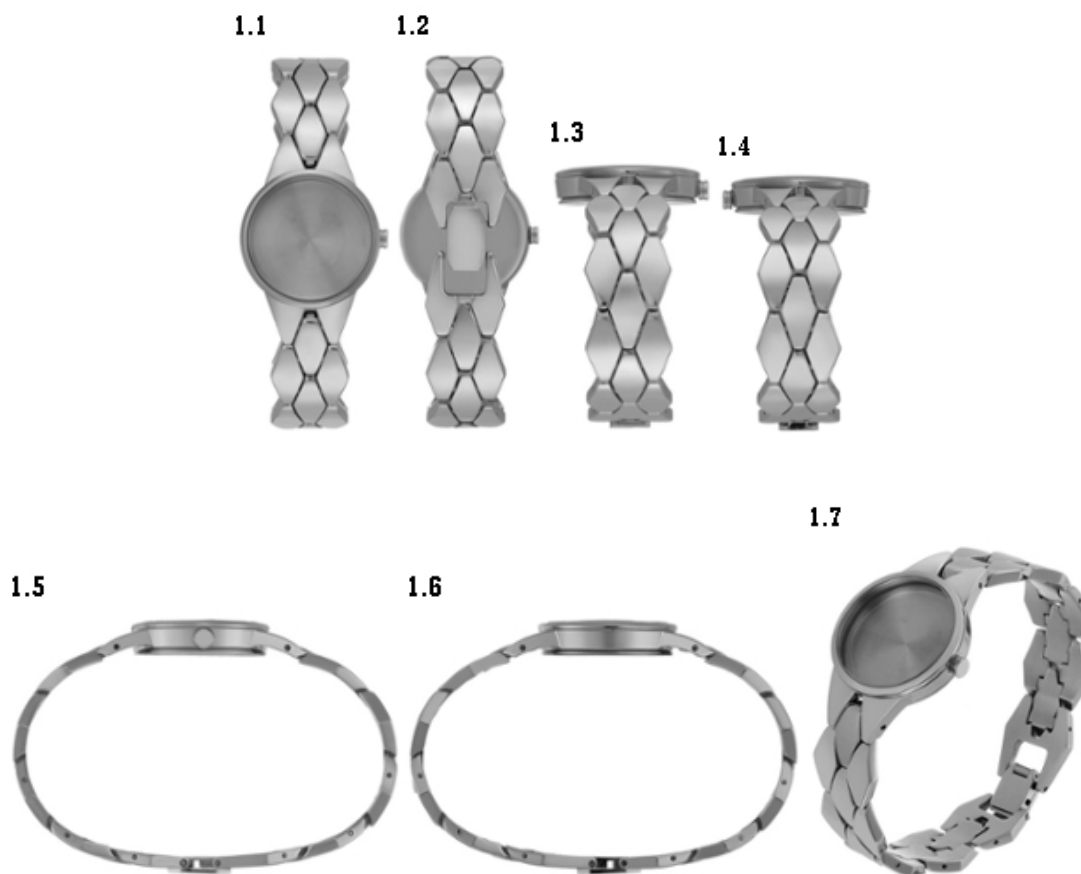

2.2



2.3



2.4



2.5



2.6



2.7



3.1



3.2



3.3



3.4



3.5



3.6



3.7



4.1



4.2



4.3



4.4



4.5







11.1



11.2



11.3



11.4



11.5



11.6



12.1



12.2



12.3



12.4



12.5



12.6



13.1



13.2



13.3



13.4



13.5



13.6



13.7



14.1



14.2



14.3



14.4



14.5



14.6



14.7



14.8



14.9



15.1



15.2



15.6



15.3



15.4



15.5



16.1



16.2



16.3



16.4



17.1



17.2



16.6



16.5



17.6



17.3



17.4



17.5



(11) DM/088101

(15) 2015 11 04

(22) 2015 11 04

(28) 2

(73) HARRY WINSTON SA

Chemin du Tourbillon 8, CH-1228 Plan-les-Ouates (CH)

(85) CH

(86) CH

(87) CH

(88) CH

(89) CH

(81) II. BZ, MA III. AL, AM, AZ, BA, CH, EM, GE, KG, KR, LI, MC, MD, ME, MK, MN, NO, OM, SG, TN, TR, UA

(72) Dominique RIVIERE

360 E. 72nd Street Apt.Nb 1003, 10021 New York N.Y., États-Unis d'Amérique

(54) 1. Earring; 2. Necklace

(55)

(51) 11-01

(45) 2016/18 (2016 05 06)

1.1**1.2****1.3****1.4****1.5****1.6**

1.7



1.8



2.1



2.2



2.3



2.4



2.5



2.6



2.7



2.8

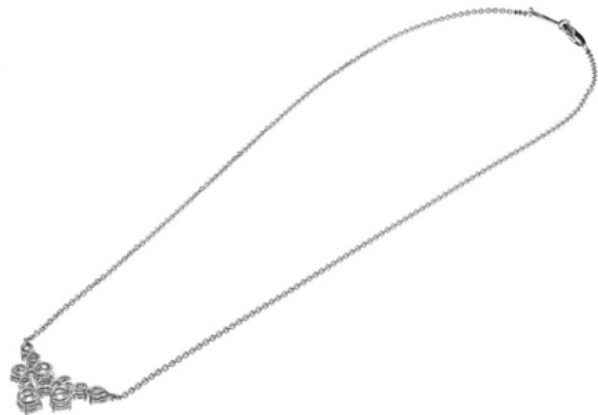

(11) DM/088419**(51) 13-03**

(15) 2015 11 04

(45) 2016/18 (2016 05 06)

(22) 2015 11 04

(28) 2

(30) Nos. 1, 2: 22.10.2015; 2015/07084; TR

(73) VİKO ELEKTRİK VE ELEKTRONİK ENDÜSTRİSİ SANAYİ VE TİCARET ANONİM ŞİRKETİ

Abdurrahmangazi Mah. Ebubekir Cd. No:44, TR-34887 Sancaktepe - İstanbul (TR)

(85) TR

(86) TR

(87) TR

(88) TR

(89) TR

(81) III. AM, AZ, EG, EM, GE, KG, MD, MK, TJ, UA

(72) MIRZAT KOÇ

Abdurrahmangazi Mah. Ebubekir Cad. No:44, 34887 Sancaktepe, Istanbul, Turkey

(54) 1. Electrical socket; 2. Electrical switch

(55)

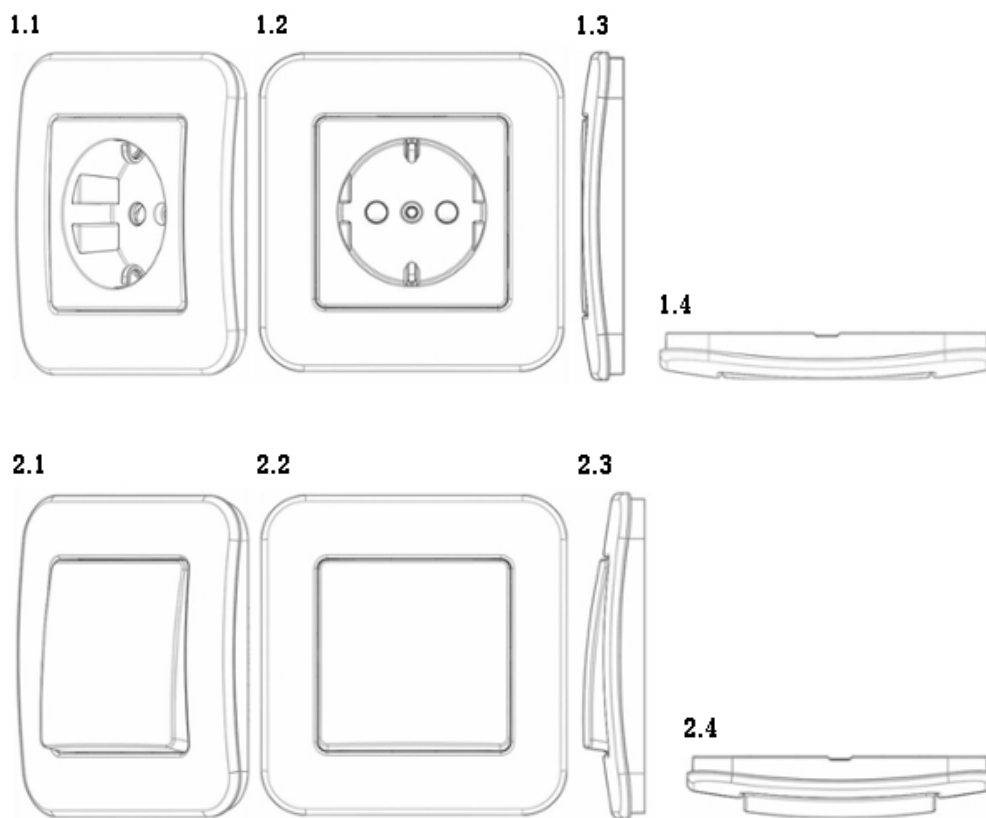

(11) DM/089691**(51) 11-01**

(15) 2015 10 30

(45) 2016/18 (2016 05 06)

(22) 2015 10 30

(28) 22

(73) THE SWATCH GROUP MANAGEMENT SERVICES AG (THE SWATCH GROUP MANAGEMENT SERVICES SA) (THE SWATCH GROUP MANAGEMENT SERVICES LTD.)
Seevorstadt 6, CH-2502 BIENNE (CH)

(85) CH

(86) CH

(87) CH

(88) CH

(89) CH

(81) II. BZ, MA III. AL, AM, AZ, BA, CH, EM, GE, KG, KR, LI, MC, MD, ME, MK, MN, NO, OM, SG, TN, TR, UA

(72) 1-4: Michelle CAMPBELL MASON

1 N. Moore St. N1, NY 10013 New York, États-Unis d'Amérique;

5-9, 12-13: Ilaria TARTARELLI

Corso San Gottardo 20, 20136 Milano, Italie;

6-7: Claire McGILL

49, rue des Parcs, 2000 Neuchâtel, Suisse;

10-11: Mirca MAFFI

Grüngasse 6, 8004 Zürich, Suisse;

14: Selin KENT

211 E 13th Street, NY 11222 New York, États-Unis d'Amérique;

15-20: Stefano RUSSO

Strada della Carità 10, 20135 Milano, Italie

(54) 1. Mini ring pendant; 2. Bracelet; 3. Earrings; 4. Necklace; 5. Bracelet; 6. Finger ring; 7. Bracelet;

8.-9. Pendants; 10.-11. Bracelets; 12. Finger ring; 13.-14. Bracelets; 15. Mini ring pendant; 16. Pendant;

17.-18. Elements for jewellery; 19. Mini ring pendant; 20. Bracelet; 21. Finger ring; 22. Bracelet

(55)

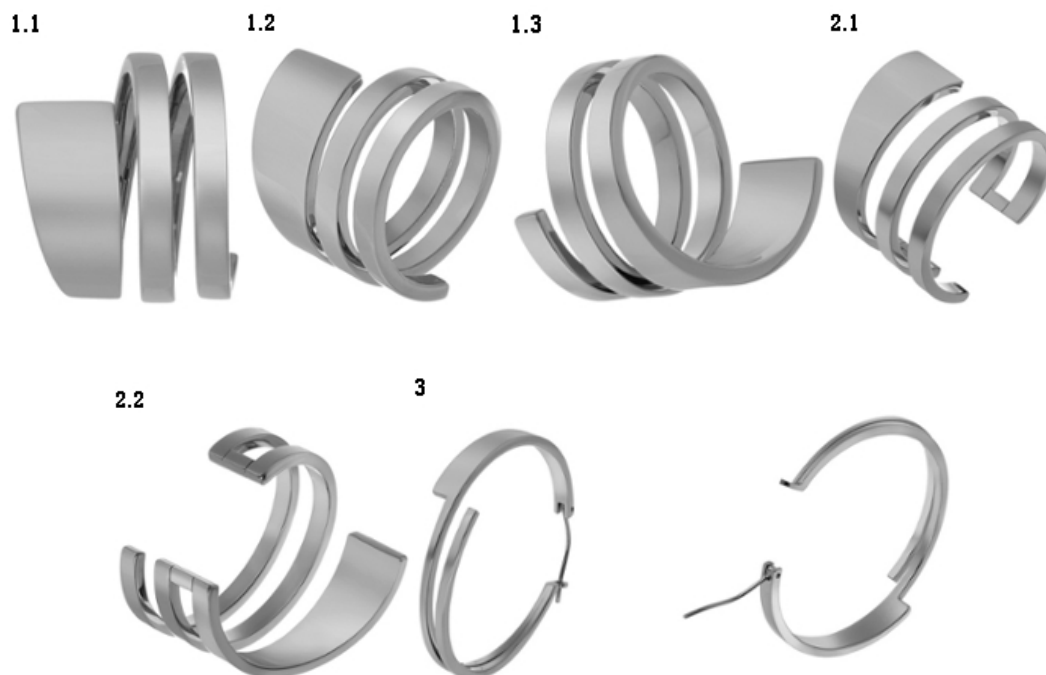

4

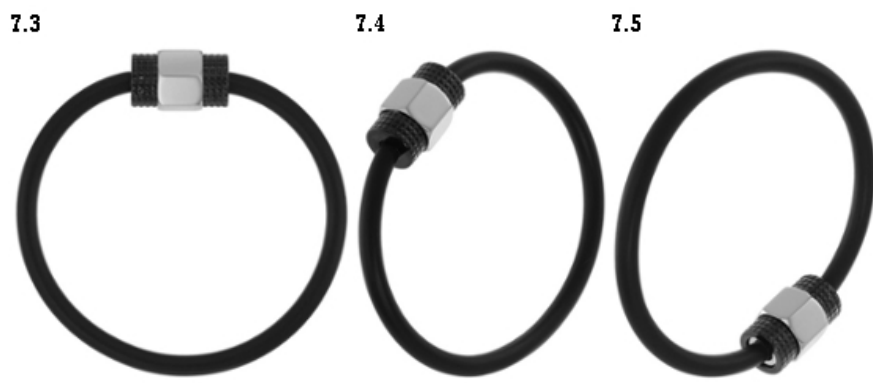
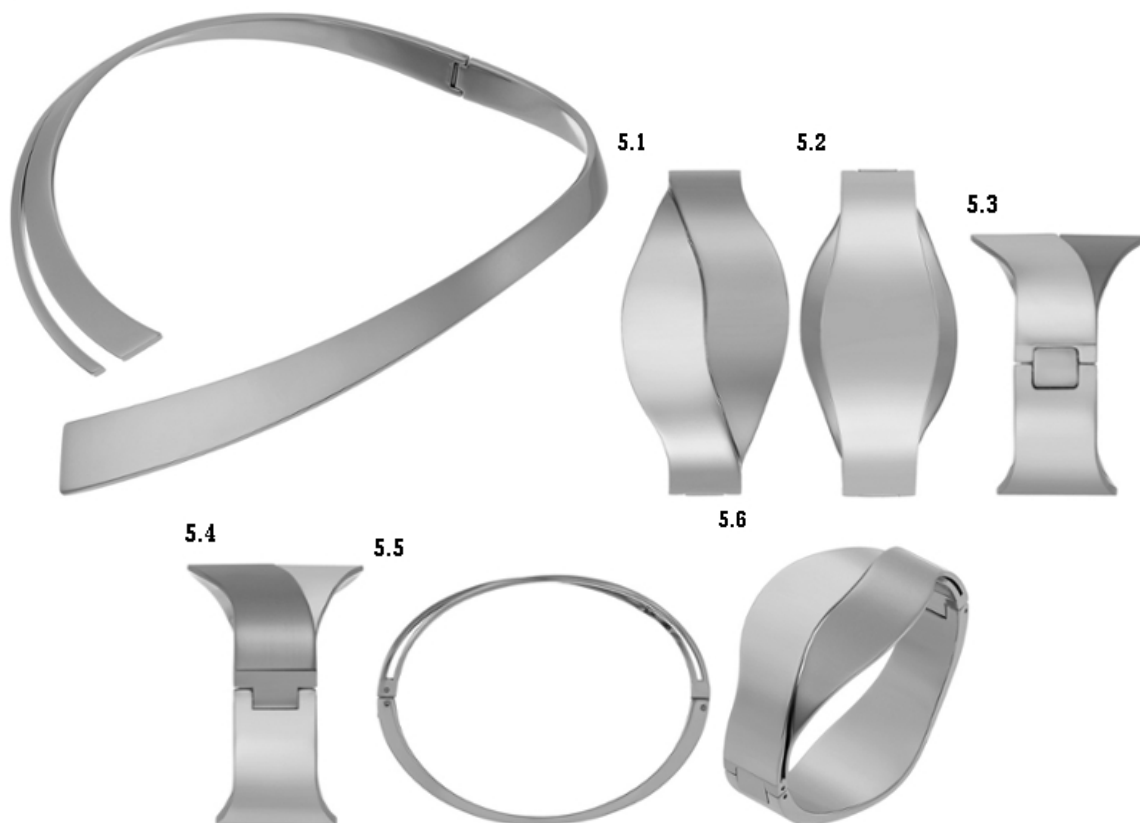

8.1



8.2



8.3



8.4



8.5



8.6



8.7



9.1



9.2



9.3



9.4



10.1



10.2



10.3



10.4



11.1



11.2



11.3



11.6

11.4



11.5



11.7



12.1



12.2



12.3



13.1



13.2



13.3

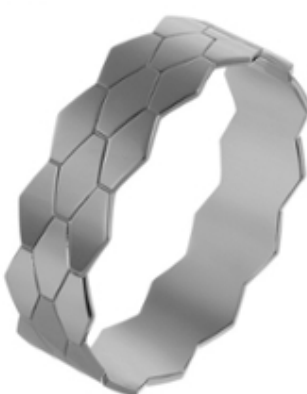

14.1



14.2



14.3



14.4



14.5



15.1



15.2



15.3

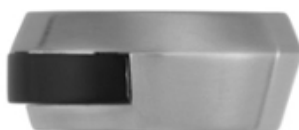

15.4

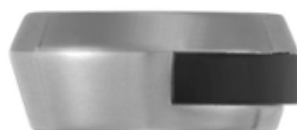

15.5



15.6



15.7



16.1



16.2



16.3



16.4



16.5 16.6



16.7



17.1



17.2



17.5 17.6



17.3



17.4



17.7



17.8



18.1



18.2



18.3



18.4



18.5



18.6



18.7



18.8



19.1



19.2

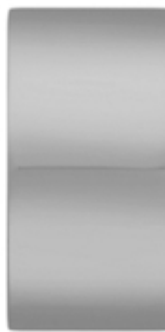

19.3



19.4



19.5



19.6



20.1



20.2



19.7



20.3



20.4



21.1



21.2



21.3



21.4



21.5



22.1



22.2



22.3



22.4



22.5



22.6



(11) DM/088150

(15) 2015 11 10

(22) 2015 11 10

(28) 1

(73) SWATCH AG (SWATCH SA) (SWATCH LTD.)

Jakob-Stämpfli-Strasse 94, CH-2502 Biel/Bienne (CH)

(85) CH

(86) CH

(87) CH

(88) CH

(89) CH

(81) II. BZ, MA III. AL, AM, AZ, BA, CH, EM, GE, KG, KR, LI, MC, MD, ME, MK, MN, NO, OM, SG, TN, TR, UA

(72) Lorenzo CHERUBINI "Jovanotti"

Corso Europa 13 (3rd fl.), 20122 Milano, Italie

(54) 1. Wristwatch

(55)

1.1

1.2



1.3



(11) DM/087551**(51) 10-02**

(15) 2015 09 14

(45) 2016/20 (2016 05 20)

(22) 2015 09 14

(28) 7

(73) SWATCH AG (SWATCH SA) (SWATCH LTD.)

Jakob-Stämpfli-Strasse 94, CH-2502 Biel/Bienne (CH)

(85) CH

(86) CH

(87) CH

(88) CH

(89) CH

(81) II. BZ, MA III. AL, AM, AZ, BA, CH, EM, GE, KG, KR, LI, MD, ME, MK, MN, OM, TN, TR

(72) 1, 5: Patrizio VITA

Via Congiunte Dx 30, 04010 Latina, Italie;

1: Martin NORRLIND

Ackersteinstrasse 167, 8049 Zürich, Suisse;

2, 6: Andrea ARRIGONI

Via Ponte Seveso 39, 20125 Milano, Italie;

3: Danilo SALA

Via L. Muratori 9, 20050 Sovico, Italie;

4: Anaïs KREBS

Rue de la Côte 21, 2000 Neuchâtel, Suisse;

7: Margherita TAGLIA

Graue Gasse 12, 8001 Zürich, Suisse

(54) 1-7. Wristwatches

(55)



4.2



5.1



6.1



6.2



7



5.2



(11) DM/087558

(51) 10-07

(15) 2015 09 17

(45) 2016/20 (2016 05 20)

(22) 2015 09 17

(28) 1

(73) SWATCH AG (SWATCH SA) (SWATCH LTD.)

Jakob-Stämpfli-Strasse 94, CH-2502 Biel/Bienne (CH)

(85) CH

(86) CH

(87) CH

(88) CH

(89) CH

(81) II. BZ, MA III. AL, AM, AZ, BA, CH, EM, GE, KG, KR, LI, MD, ME, MK, MN, OM, TN, TR

(72) Andrea ARRIGONI

Via Ponte Seveso 39, 20125 Milano, Italie

(54) 1. Watch strap

(55)

1.1

1.2

1.3



1.4



(11) DM/087584

(15) 2015 09 17

(22) 2015 09 17

(28) 1

(73) SWATCH AG (SWATCH SA) (SWATCH LTD.)

Jakob-Stämpfli-Strasse 94, CH-2502 Biel/Bienne (CH)

(85) CH

(86) CH

(87) CH

(88) CH

(89) CH

(81) II. BZ, MA III. AL, AM, AZ, BA, CH, EM, GE, KG, KR, LI, MD, ME, MK, MN, OM, TN, TR

(54) 1. Wristwatch

(55)

(51) 10-02

(45) 2016/20 (2016 05 20)

1



(11) DM/087589

(51) 10-02

(15) 2015 09 18

(45) 2016/20 (2016 05 20)

(22) 2015 09 18

(28) 1

(73) SWATCH AG (SWATCH SA) (SWATCH LTD.)

Jakob-Stämpfli-Strasse 94, CH-2502 Biel/Bienne (CH)

(85) CH

(86) CH

(87) CH

(88) CH

(89) CH

(81) II. BZ, MA III. AL, AM, AZ, BA, CH, EM, GE, KG, KR, LI, MD, ME, MK, MN, OM, TN, TR

(72) Pedro Ramos Brinca

Rue Edmond-de-Reynier 2, 2000 Neuchâtel, Suisse

(54) 1. Wristwatch

(55)

1.1



1.2



(11) DM/087592

(15) 2015 09 18

(22) 2015 09 18

(28) 1

(73) SWATCH AG (SWATCH SA) (SWATCH LTD.)

Jakob-Stämpfli-Strasse 94, CH-2502 Biel/Bienne (CH)

(85) CH

(86) CH

(87) CH

(88) CH

(89) CH

(81) II. BZ, MA III. AL, AM, AZ, BA, CH, EM, GE, KG, KR, LI, MD, ME, MK, MN, OM, TN, TR

(72) Margherita TAGLIA

12, Graue Gasse, 8001 Zurich, Suisse

(54) 1. Wristwatch

(55)

(51) 10-02

(45) 2016/20 (2016 05 20)

1.1



1.2



(11) DM/087593 (51) 10-02

(15) 2015 09 18 (45) 2016/20 (2016 05 20)

(22) 2015 09 18 (28) 2

(73) SWATCH AG (SWATCH SA) (SWATCH LTD.)

Jakob-Stämpfli-Strasse 94, CH-2502 Biel/Bienne (CH)

(85) CH

(86) CH

(87) CH

(88) CH

(89) CH

(81) II. BZ, MA III. AL, AM, AZ, BA, CH, EM, GE, KG, KR, LI, MD, ME, MK, MN, OM, TN, TR

(72) Milko BOYAROV

Birmensdorferstrasse 197, 8003 Zurich, Suisse

(54) 1.-2. Wristwatches

(55)



(11) DM/087597 (51) 10-02

(15) 2015 09 18 (45) 2016/20 (2016 05 20)

(22) 2015 09 18 (28) 2

(73) SWATCH AG (SWATCH SA) (SWATCH LTD.)

Jakob-Stämpfli-Strasse 94, CH-2502 Biel/Bienne (CH)

(85) CH

(86) CH

(87) CH

(88) CH

(89) CH

(81) II. BZ, MA III. AL, AM, AZ, BA, CH, EM, GE, KG, KR, LI, MD, ME, MK, MN, OM, TN, TR

(72) 1: Antonio FAZIO

ATO Avenue de Cour 40, 1007 Lausanne, Suisse;

2: Stefano NOVAJRA

Via Unione 30, 22072 Cermenate (CO), Italie

(54) 1.-2. Wristwatches

(55)



(11) DM/088236

(51) 10-07

(15) 2015 11 17

(45) 2016/20 (2016 05 20)

(22) 2015 11 17

(28) 1

(73) TISSOT SA (TISSOT AG) (TISSOT LTD)

Chemin des Tourelles 17, CH-2400 Le Locle (CH)

(85) CH

(86) CH

(87) CH

(88) CH

(89) CH

(81) II. BZ, MA III. AL, AM, AZ, BA, CH, EM, GE, KG, KR, LI, MC, MD, ME, MK, MN, NO, OM, SG, TN, TR, UA

(72) Véronique STOLL

Rue de la Marnière 14a, 2504 Biel/Bienne, Suisse

(54) 1. Dial

(55)

1.1



1.2



1.3



1.4

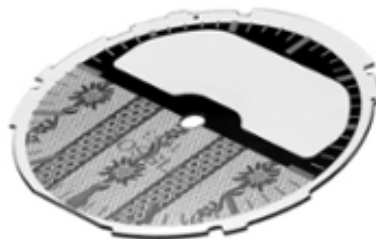

(11) DM/088280

(15) 2015 11 20

(22) 2015 11 20

(28) 1

(73) HARRY WINSTON SA

Chemin du Tourbillon 8, CH-1228 Plan-les-Ouates (CH)

(85) CH

(86) CH

(87) CH

(88) CH

(89) CH

(81) II. BZ, MA III. AL, AM, AZ, BA, CH, EM, GE, KG, KR, LI, MC, MD, ME, MK, MN, NO, OM, SG, TN, TR, UA

(72) Rie YATSUGI-KANG

272 Highland St., NJ 07626 Cresskill, États-Unis d'Amérique

(54) 1. Necklace

(55)

(51) 11-01

(45) 2016/20 (2016 05 20)

1.1



1.2



1.3



1.4



1.5



1.6



1.7



1.8



(11) DM/088464

(15) 2015 11 18

(22) 2015 11 18

(28) 2

(73) SWATCH AG (SWATCH SA) (SWATCH LTD.)

Jakob-Stämpfli-Strasse 94, CH-2502 Biel/Bienne (CH)

(85) CH

(86) CH

(87) CH

(88) CH

(89) CH

(81) IL, BZ, MA III, AL, AM, AZ, BA, CH, EM, GE, KG, KR, LI, MC, MD, ME, MK, MN, NO, OM, SG, TN, TR, UA

(72) 1: Margherita TAGLIA

Wettingerwies 7, 8001 Zürich, Suisse;

2: Anais KREBS

Rue de la Côte 21, 2000 Neuchâtel, Suisse

(54) 1.-2. Wristwatches

(55)

(51) 10-02

(45) 2016/20 (2016 05 20)

1.1



1.2



2.2



2.3



2.1



(11) DM/090456**(51) 21-01**

(15) 2016 03 16

(45) 2016/20 (2016 05 20)

(22) 2016 03 16

(28) 4

(73) YILDIZ HOLDİNG ANONİM ŞİRKETİ

Kısıklı Mahallesi Çeşme Çıkması Sokak No:6/1, Üsküdar İstanbul (TR)

(85) TR

(86) TR

(87) TR

(88) TR

(89) TR

(81) III. AL, AZ, BA, BG, CH, EG, EM, GE, MK, RO, TN, TR

(72) Ali Ülker, Kısıklı Mahallesi, Çeşme Çıkması Sokak, No: 6/1, Üsküdar İstanbul, TURKEY

(54) 1.-4. Toys

(55)

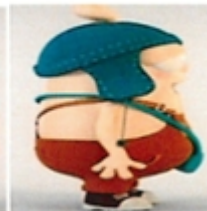
1.1**1.2****1.3****1.4****2.1****2.2****2.3****2.4****3.1****3.2****3.3****3.4****4.1****4.2****4.3****4.4**

(11) DM/090494

(51) 08-08

(15) 2016 03 23

(45) 2016/20 (2016 05 20)

(22) 2016 03 23

(28) 1

(73) UAB "VILTECHMEDA"

Mokslininkų g. 6, LT-08412 Vilnius (LT)

(85) –

(86) –

(87) LT, EM

(88) LT, EM

(89) LT

(81) III. AL, AM, AZ, BA, CH, EG, EM, GE, KG, MD, ME, MK, NO, OA, RS, SY, TJ, TR, UA, US

(72) Boguslav Vinco

Maumedziu g. 13-22, 08307 Vilnius, Lithuania;

Valerij Lipskij

Kazliskiu 13-17, 09204 Vilnius, Lithuania

(54) 1. Clamp for hoses and pipes

(55)

1.1

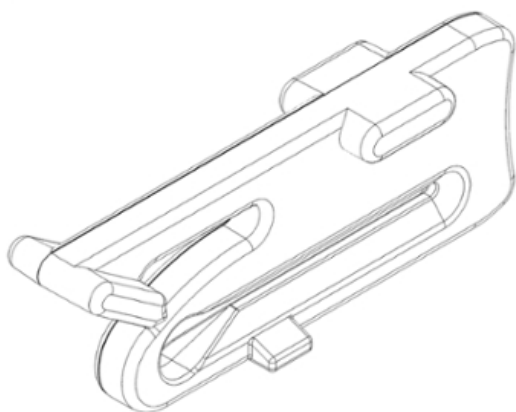

1.2

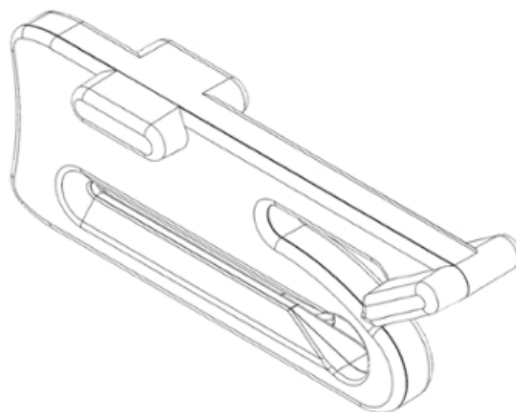

1.3

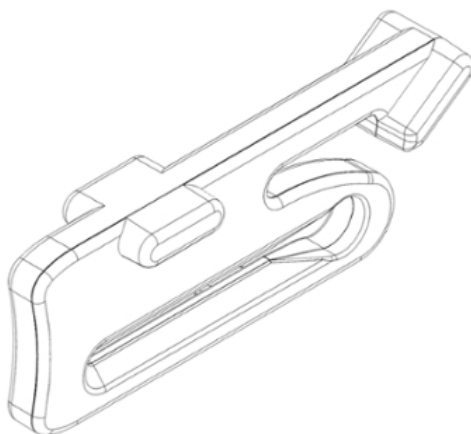

1.4

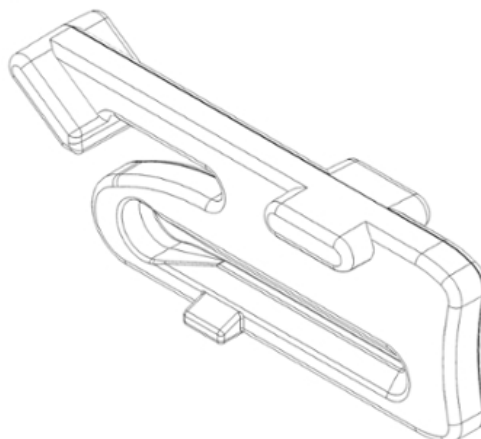

1.5

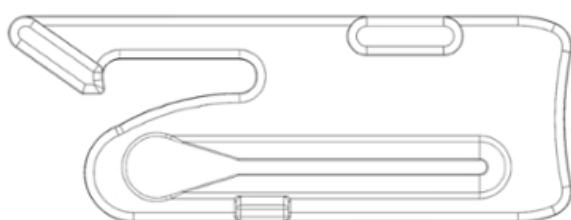

1.6

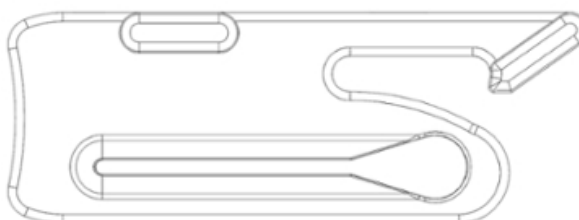

1.7

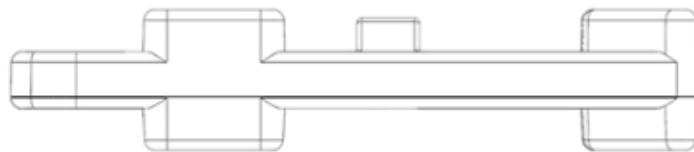

1.8

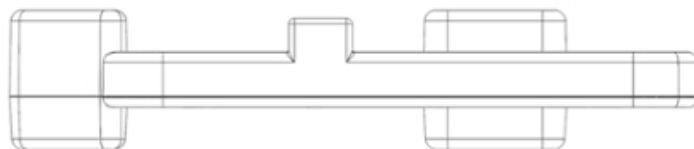

1.9

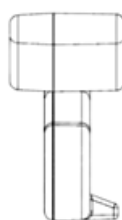

1.10

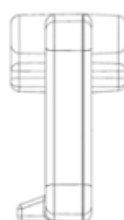

(11) DM/090545

(51) 09-05

(15) 2016 03 21

(45) 2016/20 (2016 05 20)

(22) 2016 03 21

(28) 4

(73) FICOSOTA OOD

Madara Blvd. 48, BG-9700 Shumen (BG)

(85) BG, EM

(86) BG, EM

(87) BG, EM

(88) BG, EM

(89) BG

(81) III. AM, EM, GE, MD, MK, RS, TR, UA

(72) Krasen Kyurkchiev

Madara Blvd. 48, 9700 Shumen, Bulgaria

(54) 1.-4. Packages for toilet paper and paper rolls

(55)

1.1



1.2



1.3



2.1



2.2



2.3



3.1



3.2



3.3



4.1



4.2



4.3



(11) DM/087222

(15) 2015 05 21

(22) 2015 05 21

(28) 2

(73) FCA ITALY S.P.A.

Corso Giovanni Agnelli, 200, I-10135 TORINO (IT)

(85) EM

(86) EM, IT

(87) EM, IT

(88) EM, IT

(89) EM

(81) II. MA III. AL, BA, BN, CH, EG, EM, GE, KR, LI, ME, OM, RS, TN, TR

(72) 1, 2: Roberto GIOLITO

Corso Giovanni Agnelli 200, IT-10135 Torino, Italy

(54) 1.-2. Scale model cars

(55)

(51) 21-01

(45) 2016/21 (2016 05 27)

1.1



1.2



1.3



1.4



1.5



1.6



1.7

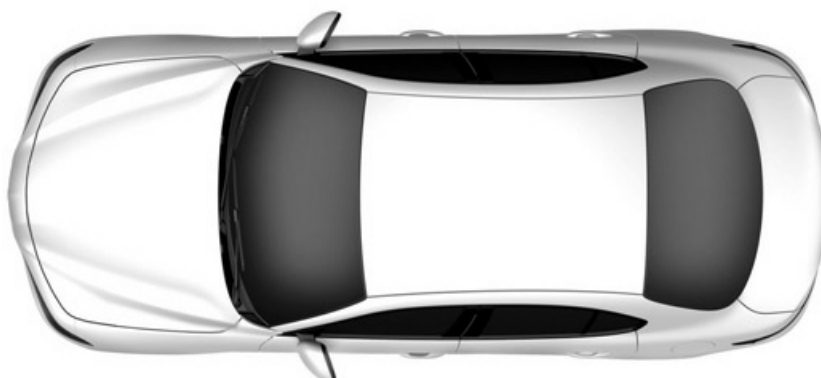

1.8



2.1



2.2



2.3



2.4



2.5



2.6



2.7

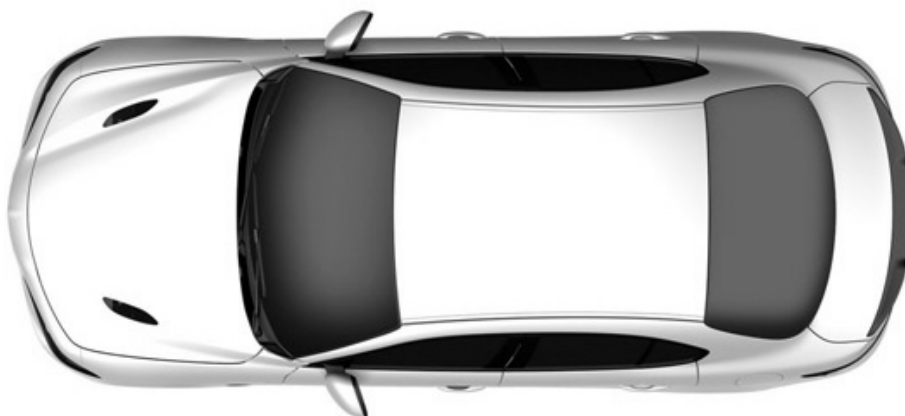

2.8

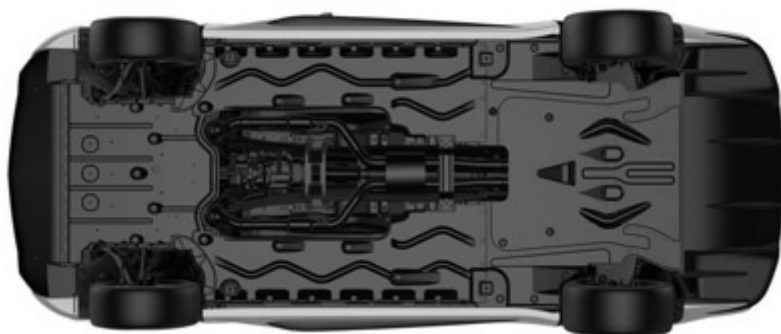

(11) DM/087223

(15) 2015 05 21

(22) 2015 05 21

(28) 2

(73) FCA ITALY S.P.A.

Corso Giovanni Agnelli, 200, I-10135 TORINO (IT)

(85) EM

(86) EM, IT

(87) EM, IT

(88) EM, IT

(89) EM

(81) II. MA III. AL, BA, BN, CH, EG, EM, GE, KR, LI, ME, OM, RS, TN, TR

(72) 1, 2: Roberto GIOLITO

Corso Giovanni Agnelli 200, IT-10135 Torino, Italy

(54) 1.-2. Motor cars

(55)

(51) 12-08

(45) 2016/21 (2016 05 27)

1.1



1.2



1.3



1.4



1.5



1.6



1.7

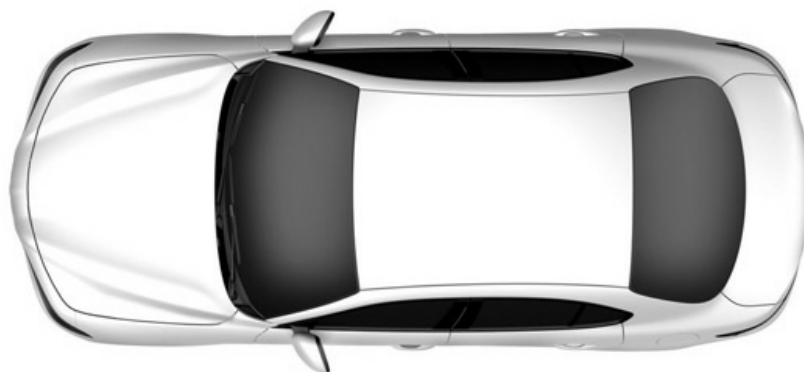

1.8

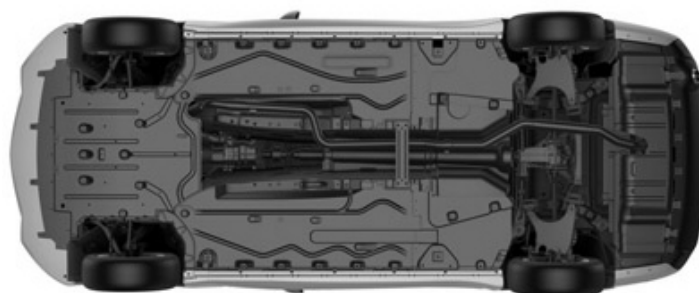

2.1



2.2



2.3



2.4



2.5



2.6



2.7

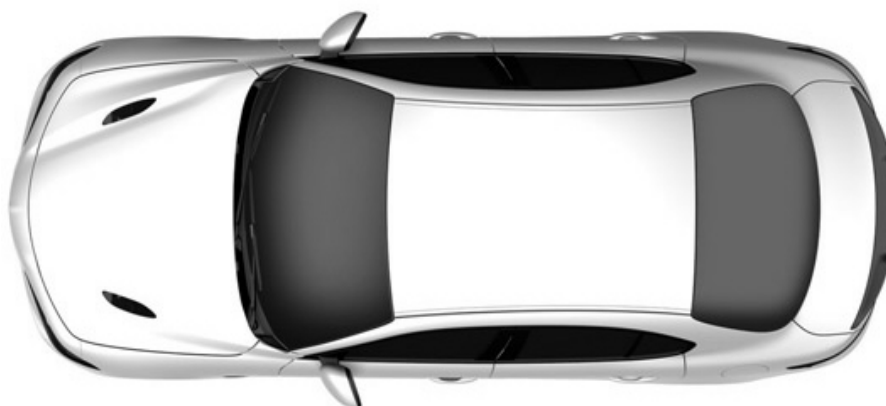

2.8



(11) DM/087646

(15) 2015 09 25

(22) 2015 09 25

(28) 2

(73) SWATCH AG (SWATCH SA) (SWATCH LTD.)

Jakob-Stämpfli-Strasse 94, CH-2502 Biel/Bienne (CH)

(85) CH

(86) CH

(87) CH

(88) CH

(89) CH

(81) II. BZ, MA III. AL, AM, AZ, BA, CH, EM, GE, KG, KR, LI, MD, ME, MK, MN, OM, TN, TR

(72) Pedro Ramos Brinca

Rue Edmond-de-Reynier 2, 2000 Neuchâtel, Suisse

(54) 1.-2. Wristwatches

(55)

(51) 10-02

(45) 2016/21 (2016 05 27)

1.1



1.2



2.2



2.1



(11) DM/088369

(15) 2015 11 25

(22) 2015 11 25

(28) 2

(73) SWATCH AG (SWATCH SA) (SWATCH LTD.)

Jakob-Stämpfli-Strasse 94, CH-2502 Biel/Bienne (CH)

(85) CH

(86) CH

(87) CH

(88) CH

(89) CH

(81) II. BZ, MA III. AL, AM, AZ, BA, CH, EM, GE, KG, KR, LI, MC, MD, ME, MK, MN, NO, OM, SG, TN, TR, UA

(72) 1: Margherita TAGLIA

Graue Gasse 12, 8001 Zürich, Suisse;

2: Min KIM

St. Alban-Ring 238, 4052 Basel, Suisse

(54) 1.-2. Wristwatches

(55)

(51) 10-02

(45) 2016/21 (2016 05 27)

1.1



1.2



2.3



2.1

2.2



(11) DM/088370 (51) 10-02

(15) 2015 11 25 (45) 2016/21 (2016 05 27)

(22) 2015 11 25 (28) 1

(73) SWATCH AG (SWATCH SA) (SWATCH LTD.)

Jakob-Stämpfli-Strasse 94, CH-2502 Biel/Bienne (CH)

(85) CH

(86) CH

(87) CH

(88) CH

(89) CH

(81) IL, BZ, MA III, AL, AM, AZ, BA, CH, EM, GE, KG, KR, LI, MC, MD, ME, MK, MN, NO, OM, SG, TN, TR, UA

(72) Margherita TAGLIA

Graue Gasse 12, 8001 Zürich, Suisse

(54) 1. Wristwatch

(55)

1



(11) DM/088442

(15) 2015 11 27

(22) 2015 11 27

(28) 2

(73) KATUSHA IP AG

c/o MOORE STEPHENS ZUG AG Alpenstrasse 15, CH-6300 Zug (CH)

(85) –

(86) CH

(87) –

(88) –

(89) CH

(81) II. MA III. AZ, CH, EM, GE, KG, MC, OM, SG, TJ, TR, UA

(54) 1. Jersey; 2. Shorts

(55)

(51) 02-02

(45) 2016/21 (2016 05 27)

1.1



1.2



2.1



2.2



(11) DM/090601

(15) 2016 05 11

(22) 2016 05 11

(28) 1

(73) BIOFARMA

50 rue Carnot, F-92284 SURESNES CEDEX (FR)

(85) –

(86) FR, EM

(87) –

(88) –

(89) FR

(81) II. MA III. AM, AZ, BA, CH, EG, EM, GE, MC, MD, ME, MK, NO, OA, RS, SG, TR, UA

(72) SERVIER INTERNATIONAL

50, rue Carnot, 92284 SURESNES CEDEX, France

(54) 1. Packaging for products

(55)

(51) 09-05

(45) 2016/21 (2016 05 27)

1



TRADEMARKS

APPLICATIONS FILED UNDER THE NATIONAL PROCEDURE APPROVED FOR REGISTRATION

The decision can be appealed at the Chamber of Appeal of Sakpatenti within 3 months from the publication or at the Mtskheta District Court Administrative Cases Board (Address: №17, Samkhedro St., Mtskheta), within 1 month following the publication.

(260) AM 2016 71960 A**

(210) AM 71960

(220) 2013 04 19

(731) LTD "GEOCELL"

Gotuas q. 3, Mtkvris marjvena sanapiro,
0160, Tbilisi, Georgia

(540)

GEOCREDIT
ჯეოკრედიტი

(591) Black, white

(511) 16, 36, 38

(260) AM 2016 79686 A*

(210) AM 79686

(220) 2014 11 28

(310) UK00003062302

(320) 2014 07 01

(330) GB

(731) BRITISH AMERICAN TOBACCO

(BRANDS) INC. (a Delaware corporation)
2711 Centerville Road, Suite 300,
Wilmington, Delaware 19808, USA

(740) Tamar Kochlamazashvili

(540)



(591) Black, white

(531) 26.04.24, 24.17.05, 24.13.01, 27.05.24

(511) 34

(260) AM 2016 81347 A*

(210) AM 81347

(220) 2015 03 20

(310) 2014734553

(320) 2014 10 13

(330) RU

(731) SAVENCIA SA.

42 Rue Rieussec, 78220 Viroflay, France

(740) Pavle Meipariani

(540)

GRANDBLU

(511) 29

(260) AM 2016 81987 A*

(210) AM 81987

(220) 2015 05 07

(731) LTD "KAKHETIAN TRADITIONAL
WINEMAKING"

S.Tsintsadzis q. 12, 0160, Tbilisi, Georgia

(740) Ekaterine Gogoladze

(540)

Limonello
ლიმონელო

(511) 33

(260) AM 2016 80913 A

(210) AM 80913

(220) 2015 02 19

(731) ZURAB KAKABADZE

Al. Kazbegis gamz. 6, b. 36, 0166, Tbilisi,
Georgia

(740) ZURAB KAKABADZE

(540)

ჯეო-ოსს
Geo-Oss

(511) 10

(260) AM 2016 82659 A

(210) AM 82659

(220) 2015 06 24

(731) LTD "MEDO"

Sanapiros q. 44, Samtredia, Georgia

(740) Irma Grigolia

(540)



(591) Blue, sky-blue, light green, green, orange, golden and red
 (531) 26.01.02, 26.01.20, 27.05.04, 29.01.15, 05.05.20
 (511) 3, 35

(260) AM 2016 83543 A
 (210) AM 83543
 (220) 2015 08 25
 (731) LTD "SIMON KHECHINASHVILI UNIVERSITY HOSPITAL"
 Iliа Chavchavadzis gamz. 29-31-33, 0179, Tbilisi, Georgia
 (740) Tamar Barnovi
 (540)



(591) Blue, sky-blue, white
 (531) 24.13.01, 26.04.03, 26.04.08, 26.05.11, 27.05.05, 29.01.13
 (511) 35, 44

(260) AM 2016 83859 A
 (210) AM 83859
 (220) 2015 09 19
 (310) 29636
 (320) 2015 04 09
 (330) AD
 (731) BRITISH AMERICAN TOBACCO (BRANDS) Inc. (a Delaware corporation)
 2711 Centerville Road, Suite 300, Wilmington, Delaware 19808, USA
 (740) Tamar Kochlamazashvili
 (540)

CHOOSE

(511) 34

(260) AM 2016 84090 A
 (210) AM 84090
 (220) 2015 10 07
 (731) LTD "BERIKA"
 I. Chavchavadzis gamz. 1 shes.6, b. 80, 0179, Tbilisi, Georgia
 (740) Irakli Mishveladze
 (540)

ტაბლა
TABLA
ТАБЛА

(511) 33

(260) AM 2016 84152 A
 (210) AM 84152
 (220) 2015 10 09
 (731) LTD "INTERNATIONAL CORPORATION ICR"
 D. Aghmasheneblis gamz. 173, 0112, Tbilisi, Georgia
 (740) Tinatin Narimanidze
 (540)



(591) Bordeaux
 (531) 03.07.03, 27.05.01, 29.01.01
 (526) "Café", "La", "France"
 (511) 43

(260) AM 2016 84161 A
 (210) AM 84161
 (220) 2015 10 09
 (731) LTD "INTERNATIONAL CORPORATION ICR"
 D. Aghmasheneblis gamz. 173, 0112, Tbilisi, Georgia
 (740) Tinatin Narimanidze
 (540)



(591) bordeaux
 (531) 03.07.03, 28.19, 29.01.01
 (526) "კაფე", "ლა", "ფრანსი"
 (511) 43

(260) AM 2016 84169 A
 (210) AM 84169
 (220) 2015 10 09
 (731) REVAZ REVAZISHVILI
 Gamsakhurdias gamz. 11, b. 3, 0143,
 Tbilisi, Georgia
 (740) Nugzar Ksovreli
 (540)

СМАЧНА КРАПЛЯ

(511) 29

(260) AM 2016 84176 A
 (210) AM 84176
 (220) 2015 10 12
 (310) 585982015
 (320) 2015 07 17
 (330) CH
 (731) THE PROCTER & GAMBLE COMPANY
 One Procter & Gamble Plaza, Cincinnati,
 Ohio 45202, USA
 (740) Merab Kvimsadze
 (540)

**HEAD & SHOULDERS
 CLINICALLY PROVEN
 SOLUTIONS**

(591) Black, white
 (531) 27.05.05
 (511) 3

(260) AM 2016 84207 A
 (210) AM 84207
 (220) 2015 10 15
 (731) LTD "INTERNATIONAL CORPORATION
 ICR"
 D. Aghmasheneblis gamz. 173, 0112,
 Tbilisi, Georgia
 (740) Tinatin Narimanidze
 (540)

Bambino

(591) Blue, red, yellow, green
 (531) 27.05.01, 29.01.14
 (511) 25, 35

(260) AM 2016 84208 A
 (210) AM 84208
 (220) 2015 10 15
 (731) LTD "INTERNATIONAL CORPORATION
 ICR"
 D. Aghmasheneblis gamz. 173, 0112,
 Tbilisi, Georgia
 (740) Tinatin Narimanidze
 (540)

მამინო

(591) Blue, red, yellow, green
 (531) 28.19, 29.01.14
 (511) 25, 35

(260) AM 2016 84258 A
 (210) AM 84258
 (220) 2015 10 20
 (310) 2015-038850
 (320) 2015 04 21
 (330) JP
 (731) MITSUBISHI JIDOSHA KOGYO
 KABUSHIKI KAISHA
 33-8, Shiba 5-chome, Minato-ku, Tokyo,
 Japan
 (740) Pavle Meipariani
 (540)

XPANDER

(511) 12

(260) AM 2016 84390 A
 (210) AM 84390
 (220) 2015 10 29
 (731) INTERVET INTERNATIONAL B.V.
 Wim de Körverstraat 35, NL-5831 AN
 Boxmeer, Netherlands
 (740) Tamaz Shilakadze
 (540)

NOBILIS

(511) 10

(260) AM 2016 84427 A
 (210) AM 84427
 (220) 2015 11 02
 (731) LTD "EKOMAKS KVISA DA KHIS
 KOMPANIA KUTAISI TIZ"
 Avtomsheneblis 88, 4600, Kutaisi, Georgia
 (740) Mariam Gugunava
 (540)

MACHT

(511) 19, 35

(260) AM 2016 84429 A
 (210) AM 84429
 (220) 2015 11 02
 (310) 2015718098
 (320) 2015 06 16
 (330) RU
 (731) ABBOTT PRODUCTS OPERATIONS AG
 Hegenheimerweg 127, 4123 Allschwil,
 Switzerland
 (740) Merab Kvimsadze
 (540)

ДюфаМишки

(591) Black,white
 (531) 28.05
 (511) 5, 29, 30

(260) AM 2016 84574 A
 (210) AM 84574
 (220) 2015 11 09
 (731) NIKOLOZ PAIASHVILI
 Varketili 3, me-3a m/r, korp. 338, b. 173,
 0163, Tbilisi, Georgia
 (740) NIKOLOZ PAIASHVILI
 (540)

MAGNITI
მაგნიტი

(511) 35

(260) AM 2016 84613 A
 (210) AM 84613
 (220) 2015 11 10
 (731) LTD "SELAZIR"
 Angisi II chikhi 12, 6000, Batumi, Georgia
 (740) Gia Shanidze
 (540)



(591) Red, blue, white and black
 (531) 26.01.02, 27.05.02, 28.19, 29.01.14
 (511) 37, 38

(260) AM 2016 84624 A
 (210) AM 84624
 (220) 2015 11 11
 (731) JSC "TELAVI WINE CELLAR"
 Sop. Kurdghelauri, 2200, Telavis raioni,
 Georgia

(740) Aleksandre Kvernadze
 (540)

GUMURA

(511) 33

(260) AM 2016 84626 A
 (210) AM 84626
 (220) 2015 11 11
 (731) JSC "TELAVI WINE CELLAR"
 Sop. Kurdghelauri, 2200, Telavis raioni,
 Georgia
 (740) Aleksandre Kvernadze
 (540)

MAEMANI

(511) 3

(260) AM 2016 84672 A
 (210) AM 84672
 (220) 2015 11 13
 (731) ID SOFTWARE LLC
 1500 North Greenville Avenue, Floor 7,
 Richardson, Texas 75081, USA
 (740) Tamaz Shilakadze
 (540)

QUAKE

(591) Black,white
 (531) 27.05.17
 (511) 9, 41

(260) AM 2016 84680 A
 (210) AM 84680
 (220) 2015 11 13
 (731) IRAKLI KIRIA
 G. Dzotsenidzis k. 5, b.29, Tbilisi,
 Georgia
 (740) Giorgi Taktakishvili
 (540)

BAKHTANGURI
VAKHTANGURI
ვახტანგური

(511) 33

(260) AM 2016 84700 A
 (210) AM 84700
 (220) 2015 11 17
 (731) INTERCEPT PHARMACEUTICALS
 INC.
 450 W. 15th Street, Suite 505, New York,
 New York 10011, USA
 (740) Tamaz Shilakadze

(540)

Intercept 

(591) Black,white
(531) 26.04.09, 27.05.17
(511) 5

(260) AM 2016 84701 A
(210) AM 84701
(220) 2015 11 17
(731) INTERCEPT PHARMACEUTICALS, INC.
450 W. 15th Street, Suite 505, New York,
New York 10011, USA
(740) Tamaz Shilakadze
(540)

**INTERCEPT
PHARMACEUTICALS**

(511) 5

(260) AM 2016 84702 A
(210) AM 84702
(220) 2015 11 17
(731) INTERCEPT PHARMACEUTICALS, INC.
450 W. 15th Street, Suite 505, New York,
New York 10011, USA
(740) Tamaz Shilakadze
(540)

Intercept  **pharmaceuticals**

(591) Black,white
(531) 26.04.09, 27.05.17
(511) 5

(260) AM 2016 84793 A
(210) AM 84793
(220) 2015 11 24
(731) GENERAL MOTORS LLC
300 Renaissance Center, City of Detroit,
State of Michigan 48265-3000, USA
(740) Giorgi Taktakishvili
(540)

CHEVROLET CODE

(511) 12

(260) AM 2016 84800 A
(210) AM 84800
(220) 2015 11 24
(731) LTD "NATURA SIBERIKA"
Ul. Iuzhnobutovskaya, dom 101, komnata
18a, Moskow, Russian Federation

(740) Tamaz Shilakadze
(540)



(591) Black,white
(531) 25.01.10, 26.04.22, 26.04.24, 27.05.24
(511) 3

(260) AM 2016 84802 A
(210) AM 84802
(220) 2015 11 24
(731) GEORGI LOGUA
Galaktionis q. 3/5, 0105, Tbilisi, Georgia
(740) Giorgi Logua
(540)



(591) White, black, red
(531) 11.01.05, 27.05.01, 29.01.12, 11.01.01
(511) 30

(260) AM 2016 84930 A
(210) AM 84930
(220) 2015 11 30
(731) HUAWEI TECHNOLOGIES CO., LTD.
Administration Building Huawei
Technologies Co., Ltd., Bantian, Longgang
District,
Shenzhen, China
(740) Konstantine Meipariani
(540)



(591) Green, sky-blue, yellow, lilac, white, black
 (531) 01.15.21, 21.03.01, 26.01.06, 27.05.01,
 29.01.15
 (511) 9, 35, 38, 42

(260) AM 2016 84986 A
 (210) AM 84986
 (220) 2015 12 02
 (731) PHILIP MORRIS BRANDS SÀRL
 Quai Jeanrenaud 3, 2000 Neuchâtel,
 Switzerland
 (740) Shalva Gvaramadze
 (540)



(591) Different tone red, white, grey
 (531) 24.07.01, 25.01.01, 26.11.07, 27.05.02,
 29.01.13, 19.03.03
 (511) 34

(260) AM 2016 84989 A
 (210) AM 84989
 (220) 2015 12 02
 (731) PHILIP MORRIS BRANDS SÀRL
 Quai Jeanrenaud 3, 2000 Neuchâtel,
 Switzerland
 (740) Shalva Gvaramadze
 (540)



(591) White, different tone red, blue, silver, black
 (531) 24.01.15, 25.01.01, 25.05.02, 27.05.24,
 29.01.15
 (511) 34

(260) AM 2016 84990 A
 (210) AM 84990
 (220) 2015 12 02
 (731) MORRISON BOWMORE DISTILLERS
 LIMITED
 Springburn Bond, Carlisle Street,
 Springburn, Glasgow G21 1EQ, United
 Kingdom
 (740) Shalva Gvaramadze
 (540)

MCCLELLAND'S

(511) 33

(260) AM 2016 85113 A
 (210) AM 85113
 (220) 2015 12 10
 (731) PHILIP MORRIS BRANDS SÀRL
 Quai Jeanrenaud 3, 2000 Neuchâtel,
 Switzerland
 (740) Shalva Gvaramadze
 (540)



(591) Red, white, grey
 (531) 03.01.22, 24.01.15, 24.09.01, 29.01.13
 (511) 34

(260) AM 2016 85114 A
 (210) AM 85114
 (220) 2015 12 10
 (731) PHILIP MORRIS BRANDS SÀRL
 Quai Jeanrenaud 3, 2000 Neuchâtel,
 Switzerland
 (740) Shalva Gvaramadze
 (540)



(591) Black, white
 (531) 03.03.01, 03.03.17, 01.05.01
 (511) 34

(260) AM 2016 85229 A
(210) AM 85229
(220) 2015 12 16
(731) LTD "AVERSI-PHARMA"
David Aghmasheneblis gamz., 148/2, 0112,
Tbilisi, Georgia
(540)

კაფსილენი
Капсилен
Capsilen

(511) 5

(260) AM 2016 85230 A
(210) AM 85230
(220) 2015 12 16
(731) LTD "AVERSI-PHARMA"
David Aghmasheneblis gamz. 148/2, 0112,
Tbilisi, Georgia
(540)

დექსიდინი
Дексидин
Dexidin

(511) 5

REGISTERED TRADEMARKS

(111) M 2016 27211 R
(151) 2016 06 26
(181) 2026 06 26
(260) AM 2015 77482 A
(220) 2014 06 10

(732) LTD "WINE COMPANY OF KVARELI"
Lermontovis q. 3, 4800, Kvareli, Georgia

(111) M 2016 27212 R
(151) 2016 06 26
(181) 2026 06 26
(260) AM 2016 78169 A
(220) 2014 07 31

(732) JUAN DE BAGRATION
Koto La Zagaleta e-1 N12 Benahavisi,
Malaga, Spain

(111) M 2016 27213 R
(151) 2016 06 26
(181) 2026 06 26
(260) AM 2015 78233 A
(220) 2014 08 07

(732) LTD "GEOCELL "
Gotuas q. 3,0163, Tbilisi, Georgia

(111) M 2016 27214 R
(151) 2016 06 26
(181) 2026 06 26
(260) AM 2015 78904 A
(220) 2014 09 30

(732) ELEMENTOS TRADE LIMITED
Avlonos, 1 Maria House 1075, Kyprus

(111) M 2016 27215 R
(151) 2016 06 26
(181) 2026 06 26
(260) AM 2015 79048 A
(220) 2014 10 10

(732) alaverdis ganvitarebis fondi "TALAVARI"
Nutsubidzis q.221, korp.1a,b.21,
Vake-Saburtalos raioni, Tbilisi, Georgia

(111) M 2016 27216 R
(151) 2016 06 26
(181) 2026 06 26
(260) AM 2015 79268 A
(220) 2014 10 30

(732) N(N)LE "OZHIO CELLAR"
Sop. Ozhio, 0906, Akhmeta, Georgia

(111) M 2016 27217 R
(151) 2016 06 26
(181) 2026 06 26
(260) AM 2016 79775 A
(220) 2014 12 04

(732) BRITISH AMERICAN TOBACCO (BRANDS)
INC. (a Delaware corporation)
2711 Centerville Road, Suite 300, Wilmington,
Delaware 19808, USA

(111) M 2016 27218 R
(151) 2016 06 26
(181) 2026 06 26
(260) AM 2016 79777 A
(220) 2014 12 04

(732) CARRERAS LIMITED
Globe House, 4 Temple Place, London
WC2R 2PG, United Kingdom

(111) M 2016 27219 R
(151) 2016 06 26
(181) 2026 06 26
(260) AM 2016 79780 A
(220) 2014 12 04

(732) BRITISH AMERICAN TOBACCO (BRANDS)
LIMITED
Globe House, 4 Temple Place, London
WC2R 2PG, United Kingdom

(111) M 2016 27220 R
(151) 2016 06 26
(181) 2026 06 26
(260) AM 2016 79781 A
(220) 2014 12 04

(732) BRITISH AMERICAN TOBACCO (BRANDS)
LIMITED
Globe House, 4 Temple Place, London
WC2R 2PG, United Kingdom

(111) M 2016 27221 R
(151) 2016 06 26
(181) 2026 06 26
(260) AM 2016 79782 A
(220) 2014 12 04

(732) BRITISH AMERICAN TOBACCO (BRANDS)
LIMITED
Globe House, 4 Temple Place, London
WC2R 2PG, United Kingdom

(111) M 2016 27222 R (151) 2016 06 26 (181) 2026 06 26 (260) AM 2016 79783 A (220) 2014 12 04 (732) BRITISH AMERICAN TOBACCO (BRANDS) LIMITED Globe House, 4 Temple Place, London WC2R 2PG, United Kingdom	(111) M 2016 27228 R (151) 2016 06 26 (181) 2026 06 26 (260) AM 2015 80489 A (220) 2015 01 27 (732) RAMAZ KARABAKI Sop. II Obcha, 1004, Baghdatis raioni, Georgia
(111) M 2016 27223 R (151) 2016 06 26 (181) 2026 06 26 (260) AM 2016 79982 A (220) 2014 12 23 (732) ABBOTT LABORATORIES 100 Abbott Park Road, Abbott Park, Illinois 60064, USA	(111) M 2016 27229 R (151) 2016 06 26 (181) 2026 06 26 (260) AM 2015 80609 A (220) 2015 02 05 (732) BAGRAT MEZURNISHVILI G. Lortkifanidzis q.1, 0105, Tbilisi, Georgia
(111) M 2016 27224 R (151) 2016 06 26 (181) 2026 06 26 (260) AM 2015 79984 A (220) 2014 12 23 (732) QINGDAO NINE-ALLIANCE GROUP CO., LTD. Shanghai Western Road, Laixi City, Qingdao, China	(111) M 2016 27230 R (151) 2016 06 27 (181) 2026 06 27 (260) AM 2015 80621 A (220) 2015 02 05 (732) N(N)LE "TSISKARI – 1852" Khidis k.1/Atonelis 29, 0105 Tbilisi, Georgia
(111) M 2016 27225 R (151) 2016 06 26 (181) 2026 06 26 (260) AM 2016 80020 A (220) 2014 12 30 (732) LTD "G-M-P" Sop. Ponitchala 65, 0165, Tbilisi, Georgia	(111) M 2016 27231 R (151) 2016 06 27 (181) 2026 06 27 (260) AM 2016 80676 A (220) 2015 02 10 (732) LTD "GENERATIONZ" Gamarjvebis q. 3, Telavi, Georgia
(111) M 2016 27226 R (151) 2016 06 26 (181) 2026 06 26 (260) AM 2016 80212 A (220) 2015 01 13 (732) THE PROCTER & GAMBLE COMPANY One Procter & Gamble Plaza, Cincinnati Ohio 45202, USA	(111) M 2016 27232 R (151) 2016 06 27 (181) 2026 06 27 (260) AM 2015 80928 A (220) 2015 02 23 (732) DIANATUS MANAGEMENT LIMITED Arch. Makariou III, 69, Tlais Tower, 3rd floor, office 301, Cyprus
(111) M 2016 27227 R (151) 2016 06 26 (181) 2026 06 26 (260) AM 2015 80380 A (220) 2015 01 21 (732) LTD "LEVORI" David Jabidzis q. 15, 0163, Tbilisi, Georgia	(111) M 2016 27233 R (151) 2016 06 27 (181) 2026 06 27 (260) AM 2015 81026 A (220) 2015 02 26 (732) LTD "PAGA" 26 maisis moedani 1, 0160, Tbilisi, Georgia
	(111) M 2016 27234 R (151) 2016 06 27 (181) 2026 06 27 (260) AM 2016 81035 A (220) 2015 02 27

(732) SHOTA BITADZE Gia Abesadzis q. 17, 0105, Tbilisi, Georgia	One Amgen Center Drive, Thousand Oaks, California 91320-1799, USA
(111) M 2016 27235 R (151) 2016 06 27 (181) 2026 06 27 (260) AM 2015 81043 A (220) 2015 03 02 (732) HUTESA AGROALIMENTARIA, S.A. Ctra. N.334, Km.136, 29520 FUENTE DE PIEDRA (MÁLAGA), Spain	(111) M 2016 27244 R (151) 2016 06 27 (181) 2026 06 27 (260) AM 2016 81419 A (220) 2015 03 26 (732) TOYO TIRE & RUBBER CO., LTD. 17-18, Edobori 1-chome, Nishi-ku, Osaka, Japan
(111) M 2016 27236 R (151) 2016 06 27 (181) 2026 06 27 (260) AM 2015 81061 A (220) 2015 03 04 (732) AMGEN INC. One Amgen Center Drive, Thousand Oaks, California 91320-1799, USA	(111) M 2016 27245 R (151) 2016 06 27 (181) 2026 06 27 (260) AM 2015 81439 A (220) 2015 03 27 (732) SAMVEL ABGARIANI D. Aghmasheneblis q.34, Batumi, Georgia
(111) M 2016 27237 R (151) 2016 06 27 (181) 2026 06 27 (260) AM 2015 81253 A (220) 2015 03 17 (732) JSC "KRASNIY OCTIYABR" ul. Malaya Krasnoselskay, d. 7, str. 24, 107140 Moscow, Russian Federation	(111) M 2016 27246 R (151) 2016 06 27 (181) 2026 06 27 (260) AM 2015 81475 A (220) 2015 03 30 (732) MASTERCARD INTERNATIONAL INCORPORATED A DELAWARE CORPORATION 2000 Purchase Street, Purchase, New York 10577-2509, USA
(111) M 2016 27238 R (151) 2016 06 27 (181) 2026 06 27 (260) AM 2015 81305 A (220) 2015 03 18 (732) NINO CHUBINISHVILI Abakelias q. 3a, Tbilisi, Georgia	(111) M 2016 27247 R (151) 2016 06 27 (181) 2026 06 27 (260) AM 2016 81625 A (220) 2015 04 08 (732) LTD "G-M-P" Sop. Ponitchala 65, 0165, Tbilisi, Georgia
(111) M 2016 27239 R (151) 2016 06 27 (181) 2026 06 27 (260) AM 2015 81313 A (220) 2015 03 18 (732) TREND FOOD INTERNATIONAL GmbH. Neuer Zollhof N3, 40221 Düsseldorf, Germany	(111) M 2016 27248 R (151) 2016 06 27 (181) 2026 06 27 (260) AM 2016 81735 A (220) 2015 04 21 (732) HASBRO, INC. 1027 Newport Avenue, Pawtucket, Rhode Island 02862, USA
(111) M 2016 27240 R (151) 2016 06 27 (181) 2026 06 27 (260) AM 2015 81396 A (220) 2015 03 26 (732) AMGEN INC.	(111) M 2016 27249 R (151) 2016 06 27 (181) 2026 06 27 (260) AM 2015 81930 A (220) 2015 05 04

(732) IVANE GOGLIDZE
Shartavas q. 35, korp. 1, b. 33, 0160, Tbilisi,
Georgia

(111) M 2016 27250 R
(151) 2016 06 27
(181) 2026 06 27
(260) AM 2016 81969 A
(220) 2015 05 06
(732) LTD "DUTY FREE INTERNATIONAL"
Besikis q. 4, Buiznes Center, office 203,
Tbilisi, Georgia

(111) M 2016 27251 R
(151) 2016 06 27
(181) 2026 06 27
(260) AM 2016 81985 A
(220) 2015 05 07
(732) LTD "AVERSI PHARMA"
David Aghmasheneblis gamz. 148/2, 0112,
Tbilisi, Georgia

(111) M 2016 27252 R
(151) 2016 06 27
(181) 2026 06 27
(260) AM 2016 81986 A
(220) 2015 05 07
(732) LTD "AVERSI PHARMA"
David Aghmasheneblis gamz. 148/2, 0112,
Tbilisi, Georgia

(111) M 2016 27253 R
(151) 2016 06 27
(181) 2026 06 27
(260) AM 2016 81993 A
(220) 2015 05 07
(732) WALTON INTERNATIONAL LTD.
P.O. Box 1586, George Town, Grand Cayman,
KY1-1110, Cayman Islands

(111) M 2016 27254 R
(151) 2016 06 27
(181) 2026 06 27
(260) AM 2016 81994 A
(220) 2015 05 07
(732) SHULTON, INC.
One Procter & Gamble Plaza, Cincinnati OH
45202, USA

(111) M 2016 27255 R
(151) 2016 06 27
(181) 2026 06 27
(260) AM 2016 81999 A

(220) 2015 05 08
(732) INTERSUN HOLDING FZCO.
P.O. Box 61051 Jebel Ali Free Zone, Dubai,
United Arab Emirates

(111) M 2016 27256 R
(151) 2016 06 27
(181) 2026 06 27
(260) AM 2016 82030 A
(220) 2015 05 11
(732) GEORGI KVITSINASHVILI
Dighmis mas. VI kvart., korp. I, b. 9, 0159,
Tbilisi, Georgia

(111) M 2016 27257 R
(151) 2016 06 27
(181) 2026 06 27
(260) AM 2016 82034 A
(220) 2015 05 13
(732) LTD "NEW GEORGIAN CAPITAL"
N. Shengelaia q. 23, 0192, Tbilisi, Georgia

(111) M 2016 27258 R
(151) 2016 06 28
(181) 2026 06 28
(260) AM 2016 82061 A
(220) 2015 05 14
(732) FAES FARMA, S.A.
Maximo Aguirre 14, 48940 Leioa (Bizkaia),
Spain

(111) M 2016 27259 R
(151) 2016 06 28
(181) 2026 06 28
(260) AM 2016 82062 A
(220) 2015 05 14
(732) FAES FARMA, S.A.
Maximo Aguirre 14, 48940 Leioa (Bizkaia),
Spain

(111) M 2016 27260 R
(151) 2016 06 28
(181) 2026 06 28
(260) AM 2016 82063 A
(220) 2015 05 14
(732) FAES FARMA, S.A.
Maximo Aguirre 14, 48940 Leioa (Bizkaia),
Spain

(111) M 2016 27261 R
(151) 2016 06 28
(181) 2026 06 28
(260) AM 2016 82064 A

(220) 2015 05 14
(732) FAES FARMA, S.A.
Maximo Aguirre 14, 48940 Leioa (Bizkaia),
Spain

(111) M 2016 27262 R
(151) 2016 06 28
(181) 2026 06 28
(260) AM 2016 82118 A
(220) 2015 05 18
(732) GEORGI SARDANADZE
G. Abesadzis q. 46, 2000, Zestafoni,
Georgia

(111) M 2016 27263 R
(151) 2016 06 28
(181) 2026 06 28
(260) AM 2016 82134 A
(220) 2015 05 18
(732) LTD "G-M-P"
Sop. Ponitchala 65, 0165, Tbilisi, Georgia

(111) M 2016 27264 R
(151) 2016 06 28
(181) 2026 06 28
(260) AM 2016 82218 A
(220) 2015 05 21
(732) NOVARTIS AG
4002 Basel, Switzerland

(111) M 2016 27268 R
(151) 2016 06 28
(181) 2026 06 28
(260) AM 2016 82229 A
(220) 2015 05 22
(732) THE PROCTER & GAMBLE COMPANY
One Procter & Gamble Plaza, Cincinnati Ohio
45202, USA

(111) M 2016 27269 R
(151) 2016 06 28
(181) 2026 06 28
(260) AM 2016 82251 A
(220) 2015 05 27
(732) LTD "LVOVSKAYA TOBACHNAYA
FABRIKA"
Ul. Zelenaya 149, k. 184, Lviv, 79035,
Ukraine

(111) M 2016 27270 R
(151) 2016 06 28
(181) 2026 06 28
(260) AM 2016 82252 A

(220) 2015 05 27
(732) LTD "LVOVSKAYA TOBACHNAYA
FABRIKA"
Ul. Zelenaya 149, k. 184, Lviv, 79035,
Ukraine

(111) M 2016 27271 R
(151) 2016 06 28
(181) 2026 06 28
(260) AM 2016 82254 A
(220) 2015 05 27
(732) LTD "LVOVSKAYA TOBACHNAYA
FABRIKA"
Ul. Zelenaya 149, k. 184, Lviv, 79035,
Ukraine

(111) M 2016 27272 R
(151) 2016 06 28
(181) 2026 06 28
(260) AM 2016 82255 A
(220) 2015 05 27
(732) LTD "LVOVSKAYA TOBACHNAYA
FABRIKA"
Ul. Zelenaya 149, k. 184, Lviv, 79035,
Ukraine

(111) M 2016 27273 R
(151) 2016 06 29
(181) 2026 06 29
(260) AM 2016 82259 A
(220) 2015 05 27
(732) MASTERCARD INTERNATIONAL
INCORPORATED a Delaware corporation
2000 Purchase Street, Purchase, New York
10577, USA

(111) M 2016 27274 R
(151) 2016 06 29
(181) 2026 06 29
(260) AM 2016 82282 A
(220) 2015 05 29
(732) LTD "SUPERBETI 2014"
Oniashvilis q. 1, 0160, Tbilisi, Georgia

(111) M 2016 27275 R
(151) 2016 06 29
(181) 2026 06 29
(260) AM 2016 82345 A
(220) 2015 06 03
(732) LTD "S. Khechinashvili University Hospital"
I. Chavchavadzis gamz. 29-31-33, 0179,
Tbilisi, Georgia

(111) M 2016 27276 R (151) 2016 06 29 (181) 2026 06 29 (260) AM 2016 82357 A (220) 2015 06 03 (732) NOVARTIS AG 4002 Basel, Switzerland	(732) LTD "CHIRINA" Gudiashvilis q. 9, 0105, Tbilisi, Georgia
(111) M 2016 27277 R (151) 2016 06 29 (181) 2026 06 29 (260) AM 2016 82390 A (220) 2015 06 04 (732) LTD "ALEKSANDRE" Ghambashidzis q.8, 0179, Tbilisi, Georgia	(111) M 2016 27283 R (151) 2016 06 29 (181) 2026 06 29 (260) AM 2016 82441 A (220) 2015 06 09 (732) LTD "CHIRINA" Gudiashvilis q. 9, 0105, Tbilisi, Georgia
(111) M 2016 27278 R (151) 2016 06 29 (181) 2026 06 29 (260) AM 2016 82391 A (220) 2015 06 04 (732) LTD "ALEKSANDRE" Ghambashidzis q.8, 0179, Tbilisi, Georgia	(111) M 2016 27284 R (151) 2016 06 29 (181) 2026 06 29 (260) AM 2016 82442 A (220) 2015 06 09 (732) LTD "CHIRINA" Gudiashvilis q. 9, 0105, Tbilisi, Georgia
(111) M 2016 27279 R (151) 2016 06 29 (181) 2026 06 29 (260) AM 2016 82434 A (220) 2015 06 08 (732) BROWN-FORMAN POLSKA, SP.Z.O.O. UL. Postepu 21 D, 02-676 Warszawa, Poland	(111) M 2016 27285 R (151) 2016 06 29 (181) 2026 06 29 (260) AM 2016 82444 A (220) 2015 06 09 (732) ORALECT LICENSING, LTD 2711 North Haskell Avenue, Suite 650, Dallas, Texas 75204, USA
(111) M 2016 27280 R (151) 2016 06 29 (181) 2026 06 29 (260) AM 2016 82435 A (220) 2015 06 08 (732) BROWN-FORMAN POLSKA, SP.Z.O.O. UL. Postepu 21 D, 02-676 Warszawa, Poland	(111) M 2016 27286 R (151) 2016 06 29 (181) 2026 06 29 (260) AM 2016 82445 A (220) 2015 06 09 (732) ORALECT LICENSING, LTD 2711 North Haskell Avenue, Suite 650, Dallas, Texas 75204, USA
(111) M 2016 27281 R (151) 2016 06 29 (181) 2026 06 29 (260) AM 2016 82439 A (220) 2015 06 09 (732) LTD "CHIRINA" Gudiashvilis q.9, 0105, Tbilisi, Georgia	(111) M 2016 27287 R (151) 2016 06 29 (181) 2026 06 29 (260) AM 2016 82493 A (220) 2015 06 11 (732) GILEAD SCIENCES IRELAND UC IDA Business and Technology Park, Carrigtohill, Co. Cork, Ireland
(111) M 2016 27282 R (151) 2016 06 29 (181) 2026 06 29 (260) AM 2016 82440 A (220) 2015 06 09	(111) M 2016 27288 R (151) 2016 06 29 (181) 2026 06 29 (260) AM 2016 82547 A (220) 2015 06 15 (732) WALTON INTERNATIONAL LTD P.O. Box 1586, George Town, Grand Cayman, KY1-1110, Cayman Islands

(111) M 2016 27289 R
(151) 2016 06 29
(181) 2026 06 29
(260) AM 2016 82548 A
(220) 2015 06 15
(732) WALTON INTERNATIONAL LTD
P.O. Box 1586, George Town, Grand Cayman,
KY1-1110, Cayman Islands

(111) M 2016 27295 R
(151) 2016 06 29
(181) 2026 06 29
(260) AM 2016 82633 A
(220) 2015 06 23
(732) LTD "OPTIMAL SERVICE"
Vazha-Pshavelas gamz. 49, korp. 3, b. 3, 0177,
Tbilisi, Georgia

(111) M 2016 27290 R
(151) 2016 06 29
(181) 2026 06 29
(260) AM 2016 82549 A
(220) 2015 06 15
(732) VISA INTERNATIONAL SERVICE
ASSOCIATION
900 Metro Center Boulevard, Foster City,
California 94404, USA

(111) M 2016 27296 R
(151) 2016 06 29
(181) 2026 06 29
(260) AM 2016 82636 A
(220) 2015 06 23
(732) LTD "TETRAPRODUCT"
Varketilis me-3 masivi, me-9 kvar., 3a korp.
b. 96, 0182, Tbilisi, Georgia

(111) M 2016 27291 R
(151) 2016 06 29
(181) 2026 06 29
(260) AM 2016 82566 A
(220) 2015 06 16
(732) THE GILLETTE COMPANY
One Gillette Park, Boston Massachusetts
02127, USA

(111) M 2016 27297 R
(151) 2016 06 29
(181) 2026 06 29
(260) AM 2016 82676 A
(220) 2015 06 25
(732) NOVARTIS AG
4002 Basel, Switzerland

(111) M 2016 27292 R
(151) 2016 06 29
(181) 2026 06 29
(260) AM 2016 82569 A
(220) 2015 06 17
(732) JOHNSON & JOHNSON
a New Jersey corporation
One Johnson & Johnson Plaza, New Brunswick,
New Jersey, 08933-7001, USA

(111) M 2016 27298 R
(151) 2016 06 29
(181) 2026 06 29
(260) AM 2016 82677 A
(220) 2015 06 25
(732) NOVARTIS AG
4002 Basel, Switzerland

(111) M 2016 27293 R
(151) 2016 06 29
(181) 2026 06 29
(260) AM 2016 82614 A
(220) 2015 06 22

(732) LTD "SHOW TECHNICS CENTER"
I. Petritsis q. 16, b.1, 0131, Tbilisi, Georgia

(111) M 2016 27299 R
(151) 2016 06 29
(181) 2026 06 29
(260) AM 2016 82678 A
(220) 2015 06 25
(732) NOVARTIS AG
4002 Basel, Switzerland

(111) M 2016 27294 R
(151) 2016 06 29
(181) 2026 06 29
(260) AM 2016 82615 A
(220) 2015 06 22

(732) LTD " SHOW TECHNICS CENTER"
I. Petritsis q. 16, b.1, 0131, Tbilisi, Georgia

(111) M 2016 27300 R
(151) 2016 06 29
(181) 2026 06 29
(260) AM 2016 82679 A
(220) 2015 06 25
(732) SUCAMPO AG
Baarerstrasse 22, CH-6300, Zug, Switzerland

(111) M 2016 27301 R
(151) 2016 06 29
(181) 2026 06 29

(260) AM 2016 82822 A
(220) 2015 07 03
(732) ACTIVISION PUBLISHING, INC.
100 Ocean Park Boulevard, Santa Monica,
California 90405, USA

(111) M 2016 27302 R
(151) 2016 06 29
(181) 2026 06 29
(260) AM 2016 82823 A
(220) 2015 07 04
(732) LTD "G-M-P"
Sop. Ponitchala 65, 0165, Tbilisi, Georgia

(111) M 2016 27303 R
(151) 2016 06 29
(181) 2026 06 29
(260) AM 2016 82824 A
(220) 2015 07 04
(732) LTD "G-M-P"
Sop. Ponitchala 65, 0165, Tbilisi, Georgia

(111) M 2016 27304 R
(151) 2016 06 29
(181) 2026 06 29
(260) AM 2016 82825 A
(220) 2015 07 04
(732) LTD "G-M-P"
Sop. Ponitchala 65, 0165, Tbilisi, Georgia

(111) M 2016 27305 R
(151) 2016 06 29
(181) 2026 06 29
(260) AM 2016 82965 A
(220) 2015 07 13
(732) LTD "MEDIKOLI"
Kifshidzis q. 9, b. 63, 0162, Tbilisi, Georgia

(111) M 2016 27306 R
(151) 2016 06 29
(181) 2026 06 29
(260) AM 2016 83243 A
(220) 2015 07 31
(732) IVLIANE IOVADZE
I. Gogebashvilis q. 38, Tbilisi, Georgia

(111) M 2016 27307 R
(151) 2016 06 29
(181) 2026 06 29
(260) AM 2016 83383 A
(220) 2015 08 17
(732) BRITISH AMERICAN TOBACCO (BRANDS)
INC. (a Delaware corporation)

2711 Centerville Road, Suite 300, Wilmington,
Delaware 19808, USA

(111) M 2016 27308 R
(151) 2016 06 29
(181) 2026 06 29
(260) AM 2016 83464 A
(220) 2015 08 20
(732) KENTUCKY FRIED CHICKEN
INTERNATIONAL HOLDINGS, INC.
1441 Gardiner Lane, Louisville, Kentucky
40213, USA

(111) M 2016 27309 R
(151) 2016 06 29
(181) 2026 06 29
(260) AM 2016 83485 A
(220) 2015 08 21
(732) BEATS ELECTRONICS, LLC
8600 Hayden Place Culver City, California
90232, USA

(111) M 2016 27310 R
(151) 2016 06 29
(181) 2026 06 29
(260) AM 2016 83512 A
(220) 2015 08 24
(732) APPLE INC.
1, Infinite Loop, Cupertino, California 95014,
USA

TRADEMARKS REGISTERED ACCORDING TO THE ACCELERATED PROCEDURE

The decision can be appealed at the Chamber of Appeal of Sakpatenti within 3 months from the publication.

(111) M 2016 27210 R
 (151) 2016 06 23
 (181) 2026 06 23
 (210) AM 87582
 (220) 2016 06 10
 (732) GALLAHER LIMITED
 Members Hill, Brooklands Road, Weybridge,
 KT13 OQU Surrey, United Kingdom
 (740) Shalva Gvaramadze
 (540)



(591) Black, white
 (531) 27.05.22
 (511) 34

(111) M 2016 27241 R
 (151) 2016 06 27
 (181) 2026 06 27
 (210) AM 87566
 (220) 2016 06 09
 (732) BEKA JIMSHELADZE
 Sop. Kakabeti, 3807, Sagarejos raioni,
 Georgia;
 HOUALI TONG
 Guangzhou, Faghu, Dasjizinsiunwan,
 Building 4, entr. 3, flat 1205, China
 (740) BEKA JIMSHELADZE
 (540)



(591) Golden, black, white
 (531) 03.11.11, 26.01.15, 27.01.12, 27.07.24,
 29.01.13
 (511) 33

(111) M 2016 27242 R
 (151) 2016 06 27
 (181) 2026 06 27
 (210) AM 87570
 (220) 2016 06 10
 (732) LTD "GLOBAL TSBS"
 Stanislavskis q. 5, 0119, Tbilisi, Georgia
 (740) Tea Kobelashvili
 (540)



(591) White, blue, sky-blue, black
 (531) 02.09.01, 19.03.24, 26.11.13, 29.01.13
 (511) 5

(111) M 2016 27243 R
 (151) 2016 06 27
 (181) 2026 06 27
 (210) AM 87573
 (220) 2016 06 10
 (732) LTD "GLOBAL TSBS"
 Stanislavskis q. 5, 0119, Tbilisi, Georgia
 (740) Tea Kobelashvili
 (540)



(591) White, blue, red, grey
 (531) 19.03.24, 26.11.13, 29.01.14
 (511) 5

(111) M 2016 27265 R
 (151) 2016 06 28
 (181) 2026 06 28
 (210) AM 87553
 (220) 2016 06 08
 (732) BETEK BOYA VE KIMYA SANAYI A.Ş.
 Ankara Asfaltı Hüseyin Çelik Sokak No:2
 Kozyatağı Bostancı - İstanbul, Turkey
 (740) Vakhtang Torotadze
 (540)



(554) Three-dimensional
 (591) White, black, red-brown, green,
 Sky-blue, purple, lilac, yellow-green
 (531) 19.01.11, 26.04.09, 27.05.24, 29.01.15
 (511) 16

(111) M 2016 27266 R
 (151) 2016 06 28
 (181) 2026 06 28
 (210) AM 87623
 (220) 2016 06 17
 (732) WILLMANN & PEIN GMBH
 Schusterrung 35, 25355 Barmstadt, Germany
 (740) Shalva Mghebrishvili
 (540)



(591) Green, blue, white
 (531) 26.13.25, 27.05.05, 29.01.13
 (511) 5

(111) M 2016 27267 R
 (151) 2016 06 28
 (181) 2026 06 28
 (210) AM 87639
 (220) 2016 06 20
 (732) NISSAN JIDOSHA KABUSHIKI KAISHA
 (also trading as Nissan Motor Co., Ltd.)
 No.2, Takara-cho, Kanagawa-ku, Yokohama-shi,
 Kanagawa-ken, Japan
 (740) Shalva Gvaramadze
 (540)



(591) Black, white
 (531) 24.11.25, 25.03.03, 27.05.24
 (511) 16, 24

(111) M 2016 27311 R
 (151) 2016 06 30
 (181) 2026 06 30
 (210) AM 86909
 (220) 2016 04 07
 (732) SHALVA KHETSURIANI
 Tamar Mepis gamz., sh. 17, Tbilisi, Georgia
 (740) Shalva Khetsuriani
 (540)

სავე ჯორჯია
AVE GEORGIA
АВЕ ДЖОРДЖИЯ

(526) The trademark is protected as a whole. "ჯორ-ჯორ", "GEORGIA" and "ДЖОРДЖИЯ" shall not be subject to independent legal protection.
 (511) 33

(111) M 2016 27312 R
 (151) 2016 06 30
 (181) 2026 06 30
 (210) AM 87584
 (220) 2016 06 13
 (732) LTD "SOHO GRUP"
 Zakariadzis q. 8, b. 8, 0177, Tbilisi, Georgia
 (540)



(591) White, green, black
(531) 26.04.09, 27.05.10, 29.01.13, 26.03.23
(511) 36

(111) M 2016 27313 R
(151) 2016 07 01
(181) 2026 07 01
(210) AM 87627
(220) 2016 06 17
(732) LTD "I G DEVELOPMENT GEORGIA"
M. Kostavas q. 47/57, 0179, Tbilisi, Georgia
(740) Paata Arjevanidze
(540)

სიტი მოლი
City mall
СИТИ МОЛ

(511) 36

(111) M 2016 27314 R
(151) 2016 07 04
(181) 2026 07 04
(210) AM 87684
(220) 2016 06 22
(732) ALEKSANDRE BAGRATIONI
D. Aghmasheneblis gamz. 117, 0112, Tbilisi,
Georgia
(740) Meri Gomelauri
(540)

ალექსანდრე ბაგრაციონი
ALEXSANDER BAGRATIONI
АЛЕКСАНДР БАГРАЦИОНИ



(591) Black,white
(531) 03.07.05, 05.03.22, 27.05.05, 28.05, 28.19
(511) 33

INTERNATIONAL TRADEMARKS FOR WHICH A DECISION ON GRANTING PROTECTIONS IS TAKEN

The decision can be appealed at the Chamber of Appeal of Sakpatenti within 3 months from the publication or at the Mtskheta District Court Administrative Cases Board (Address: №17, Samkhedro str., Mtskheta), within 1 month following the publication.

(260) AM 2016 80629 A*

(800) 1232515

(891) 2014 10 01

(731) FERRERO S.P.A.

Piazzale Pietro Ferrero, 1, I-12051 Alba,
Cuneo, Italy

(540)



(511)

30 – chocolate bar.

(260) AM 2016 81020 A*

(800) 1206164

(891) 2015 01 07

(731) COLUMBIA SPORTSWEAR COMPANY

14375 NW Science Park Drive Portland,
OR 97229, USA

(540)

BUGABOO

(511)

20 – Sleeping bags for camping.

22 – Tents.

25 – Parkas and parka liners.

(260) AM 2016 83221 A

(800) 1257061

(891) 2015 03 23

(731) Tovarystvo z obmezheniou vidpovidalnistiu
"ISTERN BEVERIDZH TREIDINH"
vul. Kyivska, bud. 6-v, m. Vyshneve, Kyevo-
Sviatoshynskii r-n, Kyivka obl. 08132,
Ukraine

(540)

ЧИСТЫЕ
РОСЫ

(591) Black and white

(511)

33 – Alcoholic beverages, except beers; anise [liqueur]; anisette [liqueur]; aperitifs; arrack [arak]; alcoholic beverages containing fruit; bitters; brandy; cider; cocktails; curacao; digesters [liqueurs and spirits]; distilled beverages; alcoholic essences; alcoholic extracts; fruit extracts, alcoholic; gin; hydromel [mead]; kirsch; liqueurs; peppermint liqueurs; perry; piquette; rice alcohol; rum; sake; spirits [beverages]; vodka; whisky; wine.

(260) AM 2016 83384 A

(800) 1259474

(891) 2015 06 04

(731) RICHTER GEDEON NYRT.

Gyömrői út 19-21, H-1103 Budapest, Hungary

(540)

PAMPAKORAN

(591) Black and white

(511)

5 – Pharmaceutical preparations.

(260) AM 2016 83538 A

(800) 1261064

(891) 2015 03 16

(731) Closed Joint-Stock Company

"PROIZVODSTVENNAYA FARMACEVTICHESKAYA KOMPANIYA
OBNOVLENIE"

ul. Komissara Zyatkova, 18, r.p. Suzun,
RU-633623 Novosibirskaya oblast',
Russian Federation

(540)

РЕНЕВАЛ

(591) Black and white

(511)

3 – Aromatics [essential oils]; flavorings [flavorings] for beverages [essential oils]; scented water; toilet water; deodorants for personal use [perfumery]; perfumery; cosmetic creams; shaving lotions; hair lotions; lotions for cosmetic purposes; beauty masks; oils for perfumes and scents; oils for cosmetic purposes; oils for toilet purposes; essential oils; oils for cleaning purposes; cleansing milk for toilet purposes; musk [perfumery]; soap; disinfectant

soap; deodorant soap; medicated soap; cosmetic kits; eau de Cologne; dentifrice powder; lipsticks; pomades for cosmetic purposes; douching preparations for personal sanitary or deodorant purposes [toilettries]; toilettries; mouthwashes, not for medical purposes; cosmetic preparations for slimming purposes; laundry bleach; dry-cleaning preparations; make-up removing preparations; nail care preparations; cleaning preparations; cosmetic face powder; fumigation preparations [perfumes]; astringents for cosmetic purposes; make-up preparations; sun-tanning preparations [cosmetics]; hair dyes; neutralizers for permanent waving; cosmetic preparations for eyelashes; depilatory preparations; cosmetic preparations for skin care; cosmetics; antiperspirants [toilettries]; shampoos; ethereal essences.

5 – Antibiotics; balms for medical purposes; dietetic substances adapted for medical use; glucose for medical purposes; hormones for medical purposes; iodine for pharmaceutical purposes; capsules for medicines; cachets for pharmaceutical purposes; candy, medicated; magnesia for pharmaceutical purposes; liniments; ointments for pharmaceutical purposes; sunburn ointments; frostbite salve for pharmaceutical purposes; medicinal oils; medicines for human purposes; medicinal drinks; medicinal infusions; tinctures for medical purposes; decoctions for pharmaceutical purposes; pills for pharmaceutical purposes; pomades for medical purposes; vitamin preparations; pharmaceutical preparations for skin care; pharmaceutical preparations; salts for medical purposes; antiseptics; analgesic preparations; adjuvants for medical purposes; febrifuges; depuratives; tonics [medicines]; nervines; digestives for pharmaceutical purposes; enzymes for medical purposes; herbal teas for medicinal purposes; elixirs [pharmaceutical preparations].

16 – Plastic wrap; cardboard packaging.

(260) AM 2016 83599 A
(800) 1261439
(891) 2014 12 19
(731) PHILIP MORRIS PRODUCTS S.A.
Quai Jeanrenaud 3, CH-2000 Neuchâtel,
Switzerland

(540)

HNB

(591) Black and white
(511)

9 – Batteries for electronic cigarettes; batteries for electronic devices that are used for heating tobacco; battery chargers for electronic devices that are used for heating tobacco; USB chargers for electronic devices that are used for heating tobacco; car chargers for electronic cigarettes; car chargers for devices that

are used for heating tobacco; battery chargers for electronic cigarettes.

11 – Electronic vaporizers; apparatus for heating liquids; apparatus for generating vapor, wired vaporizer.

34 – Tobacco, raw or manufactured; tobacco products, including cigars, cigarettes, cigarillos, tobacco for roll-your-own cigarettes, pipe tobacco, chewing tobacco, snuff tobacco, kretek; snus; tobacco substitutes (not for medical purposes); smokers' articles, including cigarette paper and tubes, cigarette filters, tobacco tins, cigarette cases and ashtrays, pipes, pocket apparatus for rolling cigarettes, lighters; matches; tobacco sticks, heated tobacco products, electronic apparatus that heat cigarettes; electronic smoking apparatus; electronic cigarettes; electronic cigarettes for use as an alternative to traditional cigarettes; electronic nicotine inhalation devices; vaporizing apparatus for tobacco, tobacco products and tobacco substitutes; smokers' articles for electronic cigarettes; extinguishers and accessories, parts and fittings for use in connection with electronic cigarettes or apparatus for heating tobacco; electronic rechargeable cigarette cases.

(260) AM 2016 83603 A

(800) 1261554

(891) 2014 10 27

(731) ERDAL ATİK

Saray Mahallesi Alemdağ, Caddesi Siteyolu
Sokak No:20, İstanbul, Turkey

(540)



Manesol
Hotel

(591) dark blue

(511)

43 – Services for providing food and drink; temporary accommodation, food and drink catering services; hotels, hotel reservations; motels, motel reservations; temporary accommodation reservations; day-nurseries; temporary pet boarding services.

(260) AM 2016 83611 A

(800) 1261641

(891) 2015 06 25

(731) PENSAN KALEM VE KAĞIT SANAYİ
TİCARET ANONİM ŞİRKETİ
Tevfikbey Mahallesi, Tahsin Tekoğlu,
Caddesi No: 35 Sefaköy, İSTANBUL;
PENSAN KALEM VE KAĞIT SANAYİ

TİCARET ANONİM ŞİRKETİ
Tevfikbey Mahallesi, Tahsin Tekoğlu
Caddesi No: 25, Sefaköy İstanbul, Turkey

(540)

MY-TECH

(591) Black and white

(511)

16 – Paper, cardboard and goods made from these materials, not included in other classes; printed matter; bookbinding material; photographs; stationery; adhesives for stationery or household purposes; artists' materials; paint brushes; typewriters and office requisites (except furniture); instructional and teaching material (except apparatus); plastic materials for packaging (not included in other classes); printers' type; printing blocks.

(260) AM 2016 83612 A

(800) 1261652

(891) 2015 05 21

(731) JAKOB HATTELAND LOGISTICS AS

Stokkastrandvegen 85, N-5578 Nedre
Vats, Norway

(540)

(591) Black and white

(511)

6 – Grids, frameworks and structures of metal or predominantly made of metal, including rail structures for conveying machines and roller conveyors for conveying goods for storage and retrieval, for use in warehousing; bins, boxes and containers of metal or predominantly made of metal for storage and transportation of goods; parts and fittings for all the aforementioned goods.

7 – Conveying machines, apparatus and installations; conveying machines, apparatus and installations, namely conveyors and roller conveyors for conveying goods for storage and retrieval, for use in warehousing; electronically controlled machines and apparatus for use for storage and retrieval of goods; boxes and containers adapted for use with the aforementioned machines and apparatus; machine coupling and transmission components (except for land vehicles); parts and fittings for all the aforementioned goods.

20 – Bins, boxes and containers made of plastic or predominantly made of plastic; bins, boxes and containers made of plastic or predominantly made of plastic for storage and retrieval by conveying machi-

nes in warehousing; parts and fittings for all the aforementioned goods.

(260) AM 2016 83614 A

(800) 1261716

(891) 2015 03 25

(731) NSK DEUTSCHLAND GMBH

Harkortstraße 15, 40880 Ratingen, Germany

(540)

(591) grey, Black and white

(511)

7 – Bearings and bearing housings (parts for machines); roller bearings for motors and engines and machines and parts therefor, included in this class.

12 – Steering mechanisms and parts therefor (parts for vehicles); Roller bearings (other than for parts for motors and engines) for land vehicles and parts therefor, included in this class; bearings and bearing housings (other than for parts for motors and engines) for land vehicles and parts therefor, included in this class; wheel bearings for land vehicles.

(260) AM 2016 83623 A

(800) 1040225

(891) 2015 07 30

(731) UAB "RUBINETA"

Architektų g. 152, LT-04202 Vilnius,
Lithuania

(540)

RUBINETA

(591) Black and white

(511)

11 – Aquarium filtration apparatus; aquarium lights; aquarium heaters; watering installations, automatic; bidets; boilers, other than parts of machines; expansion tanks for central heating installations; humidifiers for central heating radiators; central heating radiators; ornamental fountains; disinfectant apparatus; disinfectant dispensers for toilets; gas scrubbers (parts of gas installations); chimney flues; showers; shower cubicles; drying apparatus and installations; drying apparatus; electrically heated carpets; heating cushions (pads), electric, not for medical purposes; foot warmers, electric or non-electric; radiators, electric; laundry dryers, electric; heating apparatus, electric; kettles, electric; filters (parts of household or industrial installations); fountains; air valves for steam heating installations; evaporators; steam accumulators; steam facial apparatus (saunas); steam generating installations; steam boilers, other than parts

of machines; spa baths (vessels); coils (parts of distilling, heating installations); hot air apparatus; toilets, portable; Turkish bath cabinets, portable; flushing tanks; toilet seats; cooking apparatus and installations; mixer taps for water pipes; anti-splash tap nozzles; purification installations for sewage; air deodorizing apparatus; air driers (dryers); air filtering installations; ionization apparatus for the treatment of air; air conditioning apparatus; filters for air conditioning; air conditioning installations; air sterilizers; air reheaters; air purifying apparatus and machines; air cooling apparatus; immersion heaters; hot air bath fittings; hot air bath installations; urinals (sanitary fixtures); swimming pools chlorinating units; hair driers (dryers); sinks; water flushing installations; hand drying apparatus for washrooms; radiators (heating); radiator caps; wash-hand basins (parts of sanitary installations); wash-hand stands (parts of sanitary installations); level controlling valves in tanks; sanitary apparatus and installations; water-pipes for sanitary installations; sauna bath installations; bath tubs for sitz baths; laundry room boilers; sterilizers; whirlpool-jet apparatus; refrigerating apparatus and machines; refrigerating containers; refrigerating appliances and installations; heating installations (water); heating apparatus; heating installations; heating boilers; boiler pipes (tubes) and flues for heating boilers; clean chambers (sanitary installations); thermostatic valves (parts of heating installations); extractor hoods for kitchens; toilets (water-closets); toilet bowls; pipes (parts of sanitary installations); taps (cocks, spigots) for pipes; regulating and safety accessories for water apparatus; regulating and protective accessories for water or gas apparatus and pipes; regulating and safety accessories for water or gas apparatus and pipelines; washers for water taps; water intake apparatus; water filtering apparatus; desalination plants; water-closets; water softening apparatus and installations; water flushing installations (toilets); water distribution installations; water sterilizers; hot water bottles; water heaters; water supply installations; water purifying apparatus and machines; water purification installations; cooling installations for water; water conduits installations; ventilation (air-conditioning) installations and apparatus; fans (air-conditioning); fans (parts of air-conditioning installations); cooling appliances and installations; cooking rings; cookers; kitchen ranges (ovens); bath tubs; bath fittings; bath linings; bathroom installations; heaters for baths; bath installations.

(260) AM 2016 83625 A

(800) 1164113

(891) 2015 05 28

(731) Limited Liability Company "PLANETA ORGANICA"

Checherskiy proezd, d. 24, RU-117042
Moscow, Russian Federation

(540)



(591) Black and White

(511)

3 – Amber [perfume]; balms other than for medical purposes; lip glosses; petroleum jelly for cosmetic purposes; adhesives for cosmetic purposes; scented water; toilet water; depilatory wax; moustache wax; massage gels other than for medical purposes; make-up; deodorants for human beings or for animals; perfumes; greases for cosmetic purposes; perfumery; eyebrow pencils; cosmetic pencils; adhesives for affixing false eyelashes; adhesives for affixing false hair; beard dyes; cosmetic dyes; creams for leather; waxes for leather; cosmetic creams; skin whitening creams; hair spray; nail polish; nail varnish; hair lotions; lotions for cosmetic purposes; after-shave lotions; beauty masks; oils for perfumes and scents; oils for cosmetic purposes; oils for toilet purposes; essential oils; essential oils of cedarwood; essential oils of citron; oils for cleaning purposes; bergamot oil; gaultheria oil; jasmine oil; lavender oil; almond oil; rose oil; almond milk for cosmetic purposes; cleansing milk for toilet purposes; musk [perfumery]; soap; disinfectant soap; deodorant soap; shaving soap; cakes of toilet soap; medicated soap; antiperspirant soap; soap for foot perspiration; almond soap; mint for perfumery; cosmetic kits; nail art stickers; false nails; eau de cologne; bases for flower perfumes; cotton sticks for cosmetic purposes; swabs [toiletries]; dentifrices; pumice stone; hydrogen peroxide for cosmetic purposes; lipsticks; pomades for cosmetic purposes; shaving preparations; cosmetic preparations for baths; toiletries; hair waving preparations; douching preparations for personal sanitary or deodorant purposes [toiletries]; leather bleaching preparations; mouth washes, not for medical purposes; cosmetic preparations for slimming purposes; lacquer-removing preparations; make-up removing preparations; nail care preparations; aloe vera preparations for cosmetic purposes; sunscreen preparations; make-up powder; false eyelashes; tissues impregnated with cosmetic lotions; potpourris [fragrances]; bath salts, not for medical purposes; fumigation preparations [perfumes]; leather preservatives [polishes]; astringents for cosmetic purposes; eyebrow cosmetics; make-up preparations; sun-tanning preparations [cosmetics]; hair colorants; hair dyes; neutralizers for permanent waving; cosmetic preparations for eyelashes; depilatories; cosmetic preparations for skin care; cosmetics; cosmetics for animals; mascara; bleaching preparations [decolorants] for cosmetic purposes; antiperspirants [toiletries]; talcum powder, for toilet use; terpenes [essential oils]; shampoos;

shampoos for pets; dry shampoos; extracts of flowers [perfumes]; ethereal essences; badian essence; mint essence [essential oil].

(260) AM 2016 83675 A

(800) 1262520

(891) 2015 04 20

(731) Tovarystvo z obmezhenoiu vidpovidalnistiu "ZOTIK"

Homelske shose, 10,s. Rivnopillia,
Chernihivskiyi raion, Chernihivska oblast
14000, Ukraine

(540)



(591) Black, white, blue and green.

(511)

1 – Anti-knock substances for internal combustion engines; antistatic preparations, other than for household purposes; antifreeze; acetone; distilled water; acidulated water for recharging accumulators; brake fluid; glycol; glycerine for industrial purposes; detergents for use in manufacturing processes; petroleum dispersants; oil dispersants; detergent additives to gasoline; additives, chemical, to motor fuel; ethers; opacifiers for glass; mastic for tires; adhesives for industrial purposes; corrosive preparations; mineral acids; combusting preparations (chemical additives to motor fuel); coolants for vehicle engines; clarification preparations; industrial chemicals; anti-irrustants; anti-frothing solutions for accumulators; anti-boil preparations for engine coolants; liquids for removing sulfates from accumulators; power steering fluid; fluids for hydraulic circuits; transmission fluid; solvents for varnishes; compositions for repairing tires (tyres); ethyl alcohol; synthetic materials for absorbing oil; filtering materials (mineral substances); filtering materials (unprocessed plastics); filtering materials (vegetable substances); filtering materials (chemical preparations); ceramic materials in particulate form, for use as filtering media; oil-purifying chemicals; chemical preparations for decarbonising engines; chemical additives for oils; automobile body fillers; oil cement (putty); bleaching preparations (decolorants) for industrial purposes; dehydrating preparations for industrial purposes; degreasing preparations for use in manufacturing processes; scale removing preparations, other than for household purposes; fuel-saving preparations; wood alcohol.

3 – Abrasives; ammonia (volatile alkali) (detergent); shining preparations (polish); cloths impregnated

with a detergent for cleaning; disinfectant soap; laundry soaking preparations; color-removing preparations; degreasers other than for use in manufacturing processes; scale removing preparations for household purposes; polishing wax; polishing creams; polishing preparations; polish for furniture and flooring; detergents other than for use in manufacturing operations and for medical purposes; soap; oils for cleaning purposes; oil of turpentine for degreasing; canned pressurized air for cleaning and dusting purposes; laundry glaze; laundry bleach; laundry preparations; dry-cleaning preparations; stain removers; cleaning preparations; windscreen cleaning liquids; tissues impregnated with cosmetic lotions; turpentine, for degreasing; cleaning preparations; scouring solutions; shampoos.

4 – Benzine; benzol; petroleum jelly for industrial purposes; wax for industrial purposes; gasoline; kerosene; lubricating graphite; methylated spirit; charcoal (fuel); diesel oil; additives, non-chemical, to motor-fuel; tallow; moistening oil; carnauba wax; castor oil for industrial purposes; xylol; mazut; fire-lighters; grease for arms (weapons); grease for belts; lubricating grease; lubricants; lubricating oil; cutting fluids; mineral fuel; motor fuel; motor oil; naphtha; petroleum, raw or refined; petroleum ether; oil-gas; oils for paints; fuel gas; vaporized fuel mixtures; fuel; fuel with an alcoholic base; rape oil for industrial purposes; sunflower oil for industrial purposes; alcohol (fuel); industrial grease; industrial oil.

(260) AM 2016 83676 A

(800) 1262305

(891) 2014 12 01

(731) PRIVATE JOINT STOCK COMPANY
"INDUSTRIAL ASSOCIATION "KONTI"
Bul. Shevchenko, 6-b, Donetsk 83015,
Ukraine

(540)

CHOCOLATE CALENDAR

(591) Black and white

(511)

30 – Coffee, tea, cocoa and artificial coffee; rice; tapioca and sago; flour and preparations made from cereals; bread, pastry and confectionery; ices; sugar, honey, treacle; yeast, baking-powder; salt; mustard; vinegar, sauces (condiments); spices; ice; aniseed; peanut confectionery; high-protein cereal bars; baking soda (bicarbonate of soda for cooking purposes); soya bean paste (condiment); bean meal; star aniseed; tapioca flour for food; flour; bread rolls; buns; sandwiches; vanillin (vanilla substitute); vanilla (flavoring); waffles; vermicelli (noodles); cream of tartar for culinary purposes; farinaceous foods; oatmeal; oat flakes; oat-based food; sea water for cooking; seaweed (condiment); binding agents for ice cream (edible ices); biscuits; cloves (spice); mustard

meal; cake frosting (icing); glucose for culinary purposes; relish (condiment); gluten additives for culinary purposes; essences for foodstuffs, except etheric essences and essential oils; fruit jellies (confectionery); chewing gum; custard; leaven; rice-based snack food; cereal-based snack food; frozen yogurt (confectionery ices); frozen kefir (confectionery ices); flavorings, other than essential oils, for beverages; flavorings, other than essential oils, for cakes; flavorings, other than essential oils; wheat germ for human consumption; preparations for stiffening whipped cream; thickening agents for cooking foodstuffs; chips (cereal products); ginger (spice); unroasted coffee; coffee flavorings; coffee-based beverages; coffee beverages with milk; vegetal preparations for use as coffee substitutes; cocoa beverages with milk; cocoa-based beverages; cocoa-based ingredients for confectionery products; cocoa; cocoa mixes; cocoa powder; capers; caramels (candy); lozenges (confectionery); curry (spice); potato flour for food; ketchup (sauce); gluten prepared as foodstuff; confectionery with sugar; tortillas; cinnamon (spice); starch for food; hominy grits; groats for human food; corn, milled; corn, roasted; corn flour; pop corn; corn flakes; turmeric for food; couscous (semolina); salt for preserving foodstuffs; confectionery for decorating Christmas trees; edible ices; ice for refreshment; ice, natural or artificial; liquorice (confectionery); noodles; candy; flaxseed for human consumption; mayonnaise; macaroni; maltose; hominy; chow-chow (condiment); marinades; marzipan; royal jelly; honey; molasses for food; macaroons (pastry); almond paste; almond confectionery; pancakes; spring rolls; gruel, with a milk base, for food; ice-cream; dessert mousses (confectionery); chocolate mousses; nutmegs; muesli; meat gravies; meat tenderizers, for household purposes; mint for confectionery; peppermint sweets; infusions, not medicinal; husked oats; ravioli; pepper; pesto (sauce); beer vinegar; quiches; sweetmeats (candy); pizzas; pies; fondants (confectionery); powder for edible ices; pralines; condiments; dressings for salad; seasonings; unleavened bread; bee glue; gingerbread; puddings; cake powder; fruit coulis (sauces); rice cakes; baking powder; ferments for pastes; sago; garden herbs, preserved (seasonings); celery salt; golden syrup; salt for preserving foodstuffs; soya flour; soya sauce; malt for human consumption; malt biscuits; malt extract for food; tomato sauce; spaghetti; noodle-based prepared meals; ham glaze; rusks; breadcrumbs; petit-beurre biscuits; sushi; tabbouleh; tacos; tapioca; petits fours (cakes); crackers; cake dough; tarts; sorbets (ices); halvah; bread; chicory (coffee substitute); iced tea; tea-based beverages; chocolate-based beverages; chocolate beverages with milk; barley meal; crushed barley.

(260) AM 2016 83680 A

(800) 1262547

(891) 2015 06 12

(731) SEAT, S.A.

Autovia A-2 km. 585, E-08760 Martorell
(Barcelona), Spain

(540)

**SEAT**

(591) Black, white

(511)

4 – Oils and greases for industrial use, lubricants, fuels (including motor spirit), lubricating oil for motor vehicle engines, oils for automobiles, oils for automobile engines, consisting of automotive lubricants, lubricants for automobiles, water-resistant preparations in the form of oils for ignition systems for car engines.

(260) AM 2016 83685 A

(800) 1262320

(891) 2015 03 16

(731) EGIS GYÓGYSZERGYÁR ZRT.

Keresztúri út 30-38, H-1106 Budapest,
Hungary

(540)

MYLAMPIN

(511)

5 – Pharmaceutical preparations for human use; sanitary preparations for medical purposes.

(260) AM 2016 83686 A

(800) 1262321

(891) 2015 03 16

(731) EGIS GYÓGYSZERGYÁR ZRT.

Keresztúri út 30-38, H-1106 Budapest,
Hungary

(540)

DARGIDAL

(511)

5 – Pharmaceutical preparations for human use; sanitary preparations for medical purposes.

(260) AM 2016 83687 A
 (800) 1262322
 (891) 2015 03 16
 (731) EGIS GYÓGYSZERGYÁR ZRT.
 Keresztúri út 30-38, H-1106 Budapest,
 Hungary
 (540)

BROTUBIL

(511)
 5 – Pharmaceutical preparations for human use; sanitary preparations for medical purposes.

(260) AM 2016 83690 A
 (800) 1262324
 (891) 2015 03 16
 (731) EGIS GYÓGYSZERGYÁR ZRT.
 Keresztúri út 30-38, H-1106 Budapest,
 Hungary
 (540)

LAYALEN

(511)
 5 – Pharmaceutical preparations for human use; sanitary preparations for medical purposes.

(260) AM 2016 83693 A
 (800) 670314
 (891) 2015 08 06
 (731) FERRING B.V.
 Polarisavenue 144, NL-2132 JX Hoofddorp,
 Netherlands
 (540)

TRACTOCILE

(511)
 5 – Pharmaceutical products and substances.

(260) AM 2016 83694 A
 (800) 673426
 (891) 2015 08 06
 (731) FERRING B.V.
 Polarisavenue 144, NL-2132 JX Hoofddorp,
 Netherlands
 (540)

ZomaJet

(511)
 10 – Surgical, medical, dental and veterinary apparatus and instruments; artificial limbs, eyes and teeth; orthopaedic articles; suture materials.

(260) AM 2016 83696 A
 (800) 1021373
 (891) 2015 06 19
 (731) CYBEX GmbH
 Riedinger Strasse 18, 95448 Bayreuth,
 Germany

(540)



(591) Black and white
 (511)

3 – Bleaching preparations and other substances for laundry use; cleaning, polishing, scouring and abrasive preparations; soaps; perfumery, essential oils, cosmetics, hair lotions; dentifrices.

10 – Dummies for babies; clinical thermometers; babies' bottles.

12 – Vehicles, namely bicycles, tricycles (included in this class); pushchairs (included in this class), accessories especially adapted for the aforesaid vehicles, namely child seats, carrying bags, shopping baskets, all of plastic or textile; child safety seats for motor vehicles and parts therefor, including padding, safety harnesses for vehicle seats; child seats for motor vehicles and/or bicycles.

18 – Leather and imitations of leather, and goods made of these materials and not included in other classes; trunks and travelling bags; umbrellas; parasols and walking sticks; whips, harness and saddlery (included in this class); bags included in this class; purses (included in this class), pocket wallets, rucksacks, satchels; sling bags for carrying infants, all being rucksack-type bags; child carrier frames and baby swing carriers, all included in this class; bags for babies' accessories, included in this class; parasols for pushchairs, rain covers for pushchairs.

20 – Children's furniture and parts therefor, included in this class; aids for helping children to learn to walk; highchairs; table seats, infant changing tables; cradles, included in this class; sleeping bags for infants and small children, all for camping.

24 – Bed linen; crawling blankets.

25 – Clothing and shoes, in particular sportswear and sports shoes, children's clothing and children's shoes; bibs, not of paper.

28 – Gymnastic and sporting articles, included in this class; games and play things; rattles; dolls; baby rockers; baby swings.

(260) AM 2016 83745 A
 (800) 1262752
 (891) 2014 12 30
 (731) PRIVATE JOINT STOCK COMPANY
 "INDUSTRIAL ASSOCIATION "KONTI"
 Bul. Shevchenko, 6-b, Donetsk 83015,
 Ukraine

(540)

AMOUR
Dolci

(591) Black and White

(511)

30 – Coffee, tea, cocoa and artificial coffee; rice; tapioca and sago; flour and preparations made from cereals; bread, pastry and confectionery; ices; sugar, honey, treacle; yeast, baking-powder; salt; mustard; vinegar, sauces (condiments); spices; ice; aniseed; peanut confectionery; high-protein cereal bars; baking soda (bicarbonate of soda for cooking purposes); soya bean paste (condiment); bean meal; star aniseed; tapioca flour for food; flour; bread rolls; buns; sandwiches; vanillin (vanilla substitute); vanilla (flavoring); waffles; vermicelli (noodles); cream of tartar for culinary purposes; farinaceous foods; oatmeal; oat flakes; oat-based food; sea water for cooking; seaweed (condiment); binding agents for ice cream (edible ices); biscuits; cloves (spice); mustard meal; cake frosting (icing); glucose for culinary purposes; relish (condiment); gluten additives for culinary purposes; essences for foodstuffs, except etheric essences and essential oils; fruit jellies (confectionery); chewing gum; custard; leaven; rice-based snack food; cereal-based snack food; frozen yogurt (confectionery ices); frozen kefir (confectionery ices); flavorings, other than essential oils, for beverages; flavorings, other than essential oils, for cakes; flavorings, other than essential oils; wheat germ for human consumption; preparations for stiffening whipped cream; thickening agents for cooking foodstuffs; chips (cereal products); ginger (spice); unroasted coffee; coffee flavorings; coffee-based beverages; coffee beverages with milk; vegetal preparations for use as coffee substitutes; cocoa beverages with milk; cocoa-based beverages; cocoa-based ingredients for confectionery products; cocoa; cocoa mixes; cocoa powder; capers; caramels (candy); lozenges (confectionery); curry (spice); potato flour for food; ketchup (sauce); gluten prepared as foodstuff; confectionery with sugar; tortillas; cinnamon (spice); starch for food; hominy grits; groats for human food; corn, milled; corn, roasted; corn flour; pop corn; corn flakes; turmeric for food; couscous (semolina); salt for preserving foodstuffs; confectionery for decorating Christmas trees; edible ices; ice for refreshment; ice, natural or artificial; liquorice (confectionery); noodles; candy; flaxseed for human consumption; mayonnaise; macaroni; maltose; hominy; chow-chow (condiment); marinades; marzipan; royal jelly; honey; molasses for food; macarons (pastry); almond paste; almond confectionery; pancakes; spring rolls; gruel, with a milk base, for food; ice-cream; dessert mousses (confectionery); chocolate mousses; nutmegs; muesli; meat gravies; meat tenderizers, for household purposes; mint for

confectionery; peppermint sweets; infusions, not medicinal; husked oats; ravioli; pepper; pesto (sauce); beer vinegar; quiches; sweetmeats (candy); pizzas; pies; fondants (confectionery); powder for edible ices; pralines; condiments; dressings for salad; seasonings; unleavened bread; bee glue; gingerbread; puddings; cake powder; fruit coulis (sauces); rice cakes; baking powder; ferments for pastes; sago; garden herbs, preserved (seasonings); celery salt; golden syrup; salt for preserving foodstuffs; soya flour; soya sauce; malt for human consumption; malt biscuits; malt extract for food; tomato sauce; spaghetti; noodle-based prepared meals; ham glaze; rusks; breadcrumbs; petit-beurre biscuits; sushi; tabbouleh; tacos; tapioca; petits fours (cakes); crackers; cake dough; tarts; sorbets (ices); halvah; bread; chicory (coffee substitute); iced tea; tea-based beverages; chocolate-based beverages; chocolate beverages with milk; barley meal; crushed barley.

(260) AM 2016 83747 A

(800) 1262764

(891) 2015 03 24

(731) EGE SERAMİK SANAYİ VE TİCARET
ANONİM ŞİRKETİ
Ankara Asfaltı 26 Km P.K., TR-35170
KEMALPAŞA/İZMİR, Turkey

(540)



(591) blue, pink, Black and White

(526) TILE

(511)

19 – Ceramic tiles; glazed ceramic tiles; granite ceramic tiles; ceramic tiles for floors and coverings.

35 – Advertising; marketing and public relations; organization of exhibitions and trade fairs for commercial or advertising purposes; business management; business administration; office functions namely providing administrative and clerical service; business management and organization consultancy; accounting; financial statement preparation and analysis for businesses; import and export agencies; business appraisals; auctioneering; the bringing together, for the benefit of others, of a variety of materials for building, road construction and repair concrete, plasters, limes, cements, gypsum, plasters, filing plasters, ready concrete, ready mortars, ready colored mortars, natural stones, artificial stones, natural marbles, artificial marbles, ceramic tiles, mechanic and non-illuminating traffic signs for roads, monuments, statues made of concrete, stones or marbles, natural or synthetic surface coatings in blocks or strips for woods, chip woods and similar ones glassware for constructional purposes, prefabricated swimming pools sands (excluding the transport thereof), enab-

ling customers to conveniently view and purchase those goods; all the aforementioned retail services may be provided by retail stores, wholesale outlets, through mail order catalogues or by means of electronic media, including, through web sites or television shopping programmes.

(260) AM 2016 83774 A

(800) 1156214

(891) 2015 05 27

(731) Zakrytoe aktsionernoe obshchestvo
"PHARMFIRMA "SOTEX"
d. 11, pos. Belikovo, Selskoe poselenie
Bereznjakovskoe, Sergievo-Posadsky
municipalny rayon, RU-141345 Moscovskaya
obl., Russian Federation

(540)

ДОЛОМИН

(591) black and white

(511)

5 – Alkaloids for medical purposes; amino acids for veterinary purposes; amino acids for medical purposes; analgesics; anaesthetics; antibiotics; antiseptics; medicine cases, portable, filled; first-aid boxes, filled; germicides; balms for medical purposes; biocides; bracelets for medical purposes; anti-rheumatism bracelets; bromine for pharmaceutical purposes; vaccines; dietetic substances adapted for medical use; dietary fiber; mineral food supplements; nutritional supplements; albumin dietary supplements; dietary supplements for animals; enzyme dietary supplements; capsules for medicines; cachets for pharmaceutical purposes; headache pencils; acids for pharmaceutical purposes; corn rings for the feet; anti-rheumatism rings; candy, medicated; medicinal roots; dental lacquer; candy for medical purposes; adhesive plasters; sticking plasters; medicines for alleviating constipation; lotions for pharmaceutical purposes; liniments; ointments for pharmaceutical purposes; medicinal oils; teeth filling material; drugs for medical purposes; medicines for veterinary purposes; medicines for human purposes; medicinal drinks; dietetic beverages adapted for medical purposes; narcotics; medicinal infusions; tinctures for medical purposes; decoctions for pharmaceutical purposes; lozenges for pharmaceutical purposes; pastilles for pharmaceutical purposes; food for babies; poultices; compresses; bunion pads; veterinary preparations; vitamin preparations; diagnostic preparations for medical purposes; therapeutic preparations for the bath; preparations for callouses; preparations to facilitate teething; preparations for the treatment of burns; fumigation preparations for medical purposes; opotherapy preparations; eye-washes; bronchodilating preparations; preparations for reducing sexual activity; sterilising preparations;

corn remedies; pharmaceutical preparations for skin care; bath preparations, medicated; pharmaceutical preparations; chemico-pharmaceutical preparations; chilblain preparations; dietetic foods adapted for medical purposes; solvents for removing adhesive plasters; solutions for use with contact lenses; chewing gum for medical purposes; tissues impregnated with pharmaceutical lotions; syrups for pharmaceutical purposes; greases for medical purposes; soporifics; salts for medical purposes; adjuvants for medical purposes; disinfectants for hygiene purposes; febrifuges; depuratives; articles for headache; sedatives; tranquillizers; tonics [medicines]; nervines; suppositories; serums; antioxidant pills; vulnerary sponges; enzymes for veterinary purposes; enzymes for medical purposes; ferments for pharmaceutical purposes; formic aldehyde for pharmaceutical purposes; medicinal tea; herbal teas for medicinal purposes; elixirs [pharmaceutical preparations]; ethers for pharmaceutical purposes; esters for pharmaceutical purposes.

(260) AM 2016 83775 A

(800) 1156607

(891) 2015 05 27

(731) Zakrytoe aktsionernoe obshchestvo
"PHARMFIRMA "SOTEX"
d. 11, pos. Belikovo, selskoe, poselenie
Bereznjakovskoe, Sergievo-Posadsky,
municipalny rayon, RU-141345 Moscovskaya
obl., Russian Federation

(540)

Dolomin

(591) black and white

(511)

5 – Alkaloids for medical purposes; amino acids for veterinary purposes; amino acids for medical purposes; analgesics; anaesthetics; antibiotics; antiseptics; medicine cases, portable, filled; first-aid boxes, filled; germicides; balms for medical purposes; biocides; bracelets for medical purposes; anti-rheumatism bracelets; bromine for pharmaceutical purposes; vaccines; dietetic substances adapted for medical use; dietary fiber; mineral food supplements; nutritional supplements; albumin dietary supplements; dietary supplements for animals; enzyme dietary supplements; capsules for medicines; cachets for pharmaceutical purposes; headache pencils; acids for pharmaceutical purposes; corn rings for the feet; anti-rheumatism rings; candy, medicated; medicinal roots; dental lacquer; candy for medical purposes; adhesive plasters; sticking plasters; medicines for alleviating constipation; lotions for pharmaceutical purposes; liniments; ointments for pharmaceutical purposes; medicinal oils; teeth filling material; drugs

for medical purposes; medicines for veterinary purposes; medicines for human purposes; medicinal drinks; dietetic beverages adapted for medical purposes; narcotics; medicinal infusions; tinctures for medical purposes; decoctions for pharmaceutical purposes; lozenges for pharmaceutical purposes; pastilles for pharmaceutical purposes; food for babies; poultices; compresses; bunion pads; veterinary preparations; vitamin preparations; diagnostic preparations for the bath; preparations for callouses; preparations to facilitate teething; preparations for the treatment of burns; fumigation preparations for medical purposes; ootherapy preparations; eye-washes; bronchodilating preparations; preparations for reducing sexual activity; sterilising preparations; corn remedies; pharmaceutical preparations for skin care; bath preparations, medicated; pharmaceutical preparations; chemico-pharmaceutical preparations; chilblain preparations; dietetic foods adapted for medical purposes; solvents for removing adhesive plasters; solutions for use with contact lenses; chewing gum for medical purposes; tissues impregnated with pharmaceutical lotions; syrups for pharmaceutical purposes; greases for medical purposes; soporifics; salts for medical purposes; adjuvants for medical purposes; disinfectants for hygiene purposes; febrifuges; depuratives; articles for headache; sedatives; tranquillizers; tonics [medicines]; nervines; suppositories; serums; antioxidant pills; vulnerary sponges; enzymes for veterinary purposes; enzymes for medical purposes; ferments for pharmaceutical purposes; formic aldehyde for pharmaceutical purposes; medicinal tea; herbal teas for medicinal purposes; elixirs [pharmaceutical preparations]; ethers for pharmaceutical purposes; esters for pharmaceutical purposes.

(260) AM 2016 83776 A

(800) 1197498

(891) 2015 08 17

(731) L'ANTIC COLONIAL, S.A.

Ctra. Nacional, 340, Km. 55.500, E-12540

Villareal (Castellón), Spain

(540)

L'ANTIC COLONIAL

(591) black and white

(511)

19 – Non-metallic building materials; rigid pipes, not of metal, for building; asphalt, pitch and bitumen; transportable buildings, not of metal; monuments, not of metal; tiles not of metal for building, paving, ceramic paving and lining; semi-worked wood, wood paving; parquet flooring, parquet floor boards, decking.

(260) AM 2016 83847 A

(800) 1264112

(891) 2015 07 24

(731) CELGENE CORPORATION

86 Morris Avenue, Summit NJ 07901, USA

(540)

RAPVOTI

(591) black and white

(511)

5 – Pharmaceutical preparations for use in the treatment of beta thalassemia and myelodysplastic syndromes, autoinflammatory disease, autoimmune disease, blood disease, cancer, arthritis, musculoskeletal and skin diseases in the fields of oncology, immunology and inflammation; pharmaceutical preparations, namely, cytokine inhibitory drugs; pharmaceutical preparations that modulate the immune system.

(260) AM 2016 83848 A

(800) 1264131

(891) 2015 07 23

(731) CELGENE CORPORATION

86 Morris Avenue, Summit, NJ 07901, USA

(540)

INREBIC

(591) black and white

(511)

5 – Pharmaceutical preparations for use in the treatment of beta thalassemia and myelodysplastic syndromes, autoinflammatory disease, autoimmune disease, blood disease, cancer, arthritis, musculoskeletal and skin diseases in the fields of oncology, immunology and inflammation; pharmaceutical preparations, namely, cytokine inhibitory drugs; pharmaceutical preparations that modulate the immune system.

(260) AM 2016 83860 A

(800) 1029512

(891) 2015 06 16

(731) "NEOPHARM GLOBAL" OOD

j. k. "Razsadnika" bloc 30, vohod A, et. 4,

appart. 12, BG-1330 Sofia, Bulgaria

(540)

NeoralitSR

(511)

5 – Pharmaceutical and veterinary preparations; sanitary preparations for medical purposes; dietetic substances adapted for medical use; nutritional additives for medical purposes.

(260) AM 2016 83861 A

(800) 1136438

(891) 2015 06 16

(731) "NEOPHARM GLOBAL" OOD
j. k. "Razsadnika" bloc 30, vohod A, et. 4,
appart. 12, BG-1330 Sofia, Bulgaria

(540)



(591) Dark green, green, white, yellow, black and red

(511)

5 – Pharmaceutical and veterinary preparations; sanitary preparations for medical purposes; dietetic substances adapted for medical use; nutritional additives for medical purposes.

(260) AM 2016 83866 A

(800) 1263798

(891) 2015 06 09

(731) GSH TRADEMARKS LIMITED

Afroditis 25, 2nd Fl., Office 204, Nicosia,
Cyprus

(540)

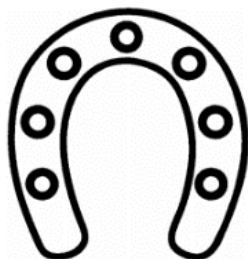

(591) Black, white

(511)

21 – Household or kitchen utensils and containers; combs and sponges; brushes (except paintbrushes); brush-making materials; articles for cleaning purposes; steelwool; unworked or semi-worked glass (except glass used in building); glassware porcelain and earthenware not included in other classes.

33 – Alcoholic beverages (except beers).

(260) AM 2016 83867 A

(800) 1264236

(891) 2015 01 21

(731) KRAFT FOODS DEUTSCHLAND
HOLDING GMBH

Langemarckstrasse 4-20, 28199 Bremen,
Germany

(540)



(591) Black, white and grey

(511)

11 – Electric apparatus for making beverages including coffee, tea and cocoa, electric coffee machines, electric coffee percolators.

21 – Coffee and tea cups; cups of paper or plastic; mugs; double wall cups; coffee and tea drinking glasses; tea services [tableware]; coffee services [tableware]; cream and sugar sets; serving trays; coffee grinders, hand-operated; non-electric coffee makers; non-electric coffee pots; non-electric coffee filters; coffee filters and holders thereof, not of paper, being part of non-electric coffee makers; tea infusers; tea strainers; tea pots; non-electric tea kettles; non-electric tea makers; coffee and tea boxes (tableware); insulating flasks; flasks; drip catchers.

30 – Coffee, coffee extracts, coffee substitutes, caffeine-free coffee, tea, tea-based and coffee-based beverages and preparations for such beverages, iced coffee, iced tea; cocoa, cocoa-based and chocolate-based beverages and preparations for making such beverages; sugar, natural sweeteners.

32 – Beer, mineral and aerated waters and other non-alcoholic beverages; syrups and other preparations for making beverages; isotonic beverages; essences for making beverages; preparations for making liquors; beverages containing soya; malt-based beverages.

43 – Food and drink catering; serving of food and drinks in restaurants and bars; coffee and tea bar services; office catering services for the provision of coffee, tea and non-alcoholic beverages; self-service, carry-out, drive-through restaurant services; cafe, caf terias, canteens, tea room, deli, snack bar services.

(260) AM 2016 83868 A

(800) 1264246

(891) 2015 01 28

(731) OLL unit s.r.o.

Letohradsk 755/50, CZ-170 00 Praha 7 –
Holešovice, Czech Republic

(540)

INTRAVITAL

(511)

5 – Pharmaceutical preparations; dietary supplements and dietetic preparations; dietetic preparations adapted for medical use; dietary and nutritional supplements; dietary supplemental drinks; dietary and nutritional supplements; dietetic foods adapted for invalids; health food supplements for persons with special dietary requirements; health food supplements made principally of minerals; health food supplements made principally of vitamins; mineral food supplements; multi-vitamin preparations; food for babies; food for infants; vitamin preparations; vi-

tamin and mineral supplements; vitamin drinks; medicinal tea; herbs for medicinal purposes.

44 – Pharmaceutical services; dietician services; dietetic advisory services; dietary guidance; nutrition counseling; consulting services relating to health care; professional consultancy relating to nutrition; health counseling; organisation and development of nutrition programmes and programmes for a healthy lifestyle.

(260) AM 2016 83871 A

(800) 1263837

(891) 2015 07 10

(731) AB ELECTROLUX

St Göransgatan 143, SE-105 45 Stockhol,
Sweden

(540)

MENALUX

(511)

3 – Carpet shampoos; stain-removers; stain removers; stain-removing preparations for household goods; cleaning compositions for spot removal; cleansers; oven cleaners; cleaning agents for deep freezers; cleaning agents for metal; cloths impregnated with a detergent for cleaning; polish for furniture and floors; polish in spray form; soap powders; pomanders (fragrances); fragrance preparations.

7 – Vacuum cleaners; suction nozzles for vacuum cleaners; vacuum cleaner hoses; brushes for vacuum cleaners; industrial vacuum cleaners for use in manufacturing; bags for use in vacuum cleaners; vacuum cleaner bags of cardboard; vacuum cleaner bags of cardboard; bags of plastic for vacuum cleaners; vacuum cleaner attachments for disseminating perfumes and disinfectants; dust separators; dishwashers; washing machines; filters for machines; filters (parts of machines or engines).

21 – Dusting brushes; dusting cloths; feather-dusters; pomanders (containers).

(260) AM 2016 83872 A

(800) 1264293

(891) 2015 04 16

(731) Fédération Internationale de Football
Association (FIFA)

FIFA-Strasse 20, CH-8044 Zürich,
Switzerland

(540)



(591) black, white, grey

(511)

1 – Chemical products for use in industry and science; chemicals for use in industry and/or manufacturing processes; synthetic materials for absorbing oil; detergent additives for fuels; chemical additives for fuel, for lubricants and for greases; hydraulic energy transmission oils and liquids; fluids for hydraulic circuits; hydraulic oils; transmission fluid; brake fluid; anti-freeze solution; coolant for vehicle engines; unexposed films; tanning materials; artificial sweeteners; solutions for checking the accuracy of blood glucose monitors; chemical substances for preserving foodstuffs.

3 – Cosmetic products; soaps; cosmetic preparations for baths; body and face powders, cosmetic and bath powders; perfumes; pre-shave and after-shave lotions; shaving creams; shampoos, hair rinsing lotions; dentifrices, dental rinses (mouthwashes); dental rinses, breath fresheners; dental bleaching creams; dental whitening products (strips and pastes); non-medicated denture cleaning tablets; deodorants and antiperspirants for personal use; hand creams, foot creams; treatment creams, beauty creams; facial cleansing creams; facial masks; anti-wrinkle formulas; anti-aging lotions and moisturizing products; skin care oils; skin care gels; face and body skin cleansers; make-up removing products; sun care lotions and creams; cosmetic sprays for the skin; baby shampoos; baby oils; baby lotions; body washing products for babies; talcum powder for babies; impregnated wipes for babies; baby wipes; cotton swabs for cosmetic use; cotton for cosmetic use; facial make-up; hair lotions, hair sprays; make-up products, make-up removing products; make-up foundations, foundations, eye shadows, mascaras; eyeliners; eye shadows, blushers, face blushers, concealers (cosmetics); eye shadows, face powders, cosmetic pencils; decorative transfers for cosmetic use; lip care preparations; lip glosses; lip pomades; lipsticks; lip liner pencils; cleaning, polishing, degreasing and abrasive preparations for household use; laundry powder detergents; synthetic household detergents; polish (creams) and waxes for footwear; polish for maintaining leather; wax for leather; cream for leather; pastes for polishing leather.

4 – Industrial oils and greases; lubricants; lubricating oils and greases; motor oils and spirit; gasoline (fuel); liquefied petroleum gas; raw or refined petroleum; diesel oil; diesel fuel; fuel gas; mazut; biofuel; natural gas; non-chemical additives for motor fuels, lubricants and greases; candles; waxes.

5 – Pharmaceutical products; creams, balms and sprays for the treatment of rheumatic pain, muscle sprains, bruises; molding wax for dentists; sanitary products for medical use; eye care medicines; medicinal teas; food additives for medical use or dietetic food additives for medical use; food for babies;

vitamin preparations; beverages enriched with added vitamins (for medical purposes); babies' diapers of paper; nutritional beverages for use as meal substitutes; air purifying products; deodorant products for vehicles; adhesive dressings, liquid dressings for skin wounds, dressings for household or personal use; first-aid creams, gels, liquids and sprays for the treatment of wounds, burns, blisters, blebs, itching and sunburns; antiseptic and antibacterial treatments; filled first-aid kits; ointments for the treatment of diaper rash; skin care ointments; dental adhesives; pharmaceutical pain relievers for sinus, allergy and anti-itch treatments; sleeping pills and tablets; cough treatment preparations; cold treatment preparations; anti-diarrhea medication; oral care products and products for treating yeast infections; pharmaceutical preparations for the treatment of gastric and digestive disorders; preparations for the treatment of motion sickness; non-medicated steam treatment preparations; calcium supplements in solid form for chewing; sanitary tampons, sanitary panties and towels; personal lubricants; menopause treatment preparations; breast-feeding pads; eye drops, liquids for contact lenses; medical blood testing strips; migraine treatment preparations; acne treatment medication; antibiotic preparations; disinfectants for sterilization; nutritional, dietetic and/or food supplements based on flours, plant extracts, cereals, rice, tapioca, sago, including those containing vitamins, minerals, essential fatty acids and trace elements, other than for medical use.

6 – Metal rings and chains for keys; figurines; ornaments; statues, statuettes, sculptures and trophies; badges of metal for vehicles; fixed dispensers for napkins; all the aforesaid goods made of common metals or their alloys; vehicle registration plates of metal; number plates, of metal; printed metal capsules to collect (pogs).

7 – Aerated beverage making machines; electric can openers; electric knives, electromechanical food preparation machines; mixing apparatus for household use; electric whisks for household use; electric fruit presses for household use; electric food processors; electric mixers for household use; dishwashers; washing machines for household use; spin driers; vacuum cleaners and accessories thereof included in this class; automatic electronic dispensers; vehicle engines; vehicle engine components, namely, fuel injection devices, radiator harnesses and heaters, carburetors, front wheel drive parts, emission control units, spare parts for engines, including for vehicle engines; stands for engines other than engines for land automobile vehicles, valve lifters; electronic systems for power trains, body and chassis electronic systems, water pumps, engine mounts, air filters, suspension shock absorbers and struts, oil filters, gas filters, transmission filters, spark plugs, fuel pumps, PCV valves, alternators; electric generators; cranes

(lifting and hoisting apparatus); bulldozers; tractor loaders; steamrollers.

8 – Hand tools and implements (hand-operated); electric and non-electric razors, including razor blades; cutlery, forks, spoons; pocket knives; nippers; scissors; flat irons.

9 – Spectacles, sunglasses, diving and swimming goggles, cases, cords and chains for sunglasses and spectacles; binoculars; magnets and decorative magnets; directional compasses; automobile batteries; groups of electronic monitoring instruments; radiator thermostats; remote control door locking systems; audio systems and hi-fi components; apparatus for recording, transmission, editing, mixing and reproduction of images and sound; radios; television apparatus; flat screens; liquid crystal display screens; high-definition and plasma screens; home cinema system apparatus; video recorders; compact disc players; personal CD players; DVD drives; MP3 players; players containing music in digital format; cassette players; personal cassette players; mini disk players; portable radio sets; loudspeakers; headphones; earphones; microphones; remote controls, voice-activated remote controls; navigation apparatus; personal digital assistants (PDAs); computers; data processing apparatus; computer keyboards; computer screens; modems; computer carrying cases; computer mice; mouse pads; electronic pocket translators; dictating apparatus; electronic notebooks and agendas; scanners; printers; photocopiers; facsimile machines; telephone apparatus; telephone answering machines; video telephones; cellular telephones; cases for cellular telephones; hands-free telephone apparatus; earphones and headsets for cellular telephones; keyboards for cellular telephones; cellular telephone straps; special bags for carrying cellular telephones; photographic cameras and video cameras integrated into cellular telephones; calculating machines; card readers for credit cards; cash exchanging machines; automated teller machines; video cameras, portable video cameras with built-in videocassette recorders (camcorders); photographic equipment, photographic apparatus, cameras (cinematographic apparatus), projectors, exposed films, photographic slides, flash-bulbs (photography); special cases and cords for photographic apparatus and instruments; electric batteries and cells; karaoke apparatus and programs for karaoke; video game disks; voice-activated or hand-operated game controllers; software (recorded computer programs), including software for games; computer programs; data bank management software; screensaver software; magnetic, digital or analog recording media, recorded or not, for sounds or images; video disks, video tapes, magnetic tapes, magnetic disks, DVDs, floppy disks, optical disks, compact disks, mini-disks, CD-ROMs, all the aforesaid goods are blank or pre-recorded with music, sound or images (which may be anima-

ted); holograms; magnetic cards (encoded), including gift vouchers; memory adapters (computer equipment); memory cards; memory keys (prerecorded or blank); integrated circuit cards (smart cards); magnetic or chip-based credit cards, magnetic or chip-based telephone cards, magnetic or chip-based cards for cash dispensers, magnetic or chip-based cards for automated teller machines and currency converters, prepaid magnetic or chip-based cards for mobile telephones, magnetic or chip-based travel and show admission cards, magnetic or chip-based check guarantee cards and magnetic or chip-based debit cards; non-magnetic credit cards; alarms (instruments); wind socks (for indicating wind direction); photovoltaic cells and solar electric panels; gauges; distance measuring apparatus; speed measurement and indication equipment; tire pressure sensors; tire pressure gauges; downloadable electronic publications; downloadable electronic road maps; audio receivers, sound amplifiers; television tubes; cathode ray tubes; computer software and hardware, including set top boxes, which can convert, supply, receive and transmit sound and visual data; disk drives for computers; semi-conductors; protected semi-conductors; integrated circuits containing programs for audio, video or computer data processing; rechargeable batteries; audio and video data processors and converters; cables for data transmission; speedometer cables and their spare parts; protective helmets for sports; magnetic identification bracelets; electronic tickets; tickets in the form of magnetic cards; contact lenses, receptacles for cleaning and storing contact lenses.

10 – Personal diagnosis apparatus for medical use; medical measurement apparatus and instruments; massage apparatus for personal use; apparatus for gymnastics for medical use; imaging apparatus for medical diagnosis; condoms; support bandages; ice and thermal bags for medical use; lancets for diabetics; devices for monitoring glucose for medical use; devices and equipment used in minimally invasive surgery; orthopedic products (subcutaneous internal implants only), excluding any form of footwear or soles; equipment for closing wounds; sterilization devices for medical use; equipment for blood typing and tests for blood screening; devices for monitoring blood glucose for medical use; artificial implants.

11 – Air conditioning installations and apparatus; air filters for air conditioning units; flashlights; flashlights for lighting; table lamps; decorative lamps; lamp shades; incandescent lamps; light bulbs; lighting apparatus; lights for bicycles; floodlights; lanterns; refrigerators; freezers; ovens; cookers (cooking stoves); gas stoves; electric cookers; barbecue grills, cooking ranges, microwave ovens; electric coffee machines; electric kettles; electric bread toasters; electric deep friers; electric laundry driers or hair driers; drying machines; water filters; drinking

water fountains; air conditioning apparatus, air-cooling fans for personal use; toilet seats; solar collectors for heating; radiator caps.

12 – Bicycles, motorcycles, scooters, automobiles, trucks, vans, motor homes, buses, refrigerated vehicles; airplanes; boats; air balloons, dirigible balloons [airships]; tires, inner tubes for pneumatic tires, rubber reinforcements for retreading tires, equipment and kits for repairing tires and inner tubes; adhesive patches for repairing tires and inner tubes, valves for tires, apparatus for inflating tires, anti-skid devices for vehicle tires such as spikes and chains; wheels, wheel rims, spacers for wheel rims, hubcaps; solid tires for vehicle wheels; vehicle wheel spokes; accessories for vehicles, namely, sun screens, roof racks, ski carriers, carriers for bicycles, seat cushions and covers for vehicles; protective covers for vehicles (vehicle accessories); headlight glasses; red tail light glasses; convertible roofs; deflectors; sun visors; grille guards; air bags for vehicles (airbags); fog lights; steering wheels; number plate holders; alarm systems for motor vehicles; spare vehicle parts; stands for land vehicle engines; safety belt pads; rearview mirror covers; baby carriages, strollers; safety seats for babies and children (for vehicles); engines and motors for land vehicles.

14 – Jewelry; necklaces; jewelry products; precious stones; crystals and gemstones; watches; wristwatches; watch straps; clocks; wall clocks; chronographs; chronometers, clocks, watch cases; medallions, pendants, brooches; bracelets, bracelets of leather; pins (jewelry); team and player pins (jewelry); tie clips and tie pins; cuff links; medals; commemorative medals of precious metal; medallions, trophies, statues and sculptures of precious metal; decorative pins for hats, all of precious metal; key rings [trinkets or fobs]; coins; medals and badges for clothing of precious metal; decorative key holders; medallions, not of precious metal; printed caps of precious metal for collecting (pogs).

15 – Musical instruments; musical boxes; electric and electronic musical instruments.

16 – Paper-clips; tablecloths of paper; napkins of paper; paper bags; invitation cards; greeting cards; gift-wrapping paper; glass or bottle coasters of paper, paper place and table mats; garbage bags of paper or of plastics; sachets for food; coffee filters; labels (not of textile), hand towels; wet hand towels; toilet paper; tissues of paper for removing make-up; boxed tissues; tissues of paper; writing materials and school supplies (except apparatus); typewriters; typewriter paper, paper for writing and copying paper (stationery); envelopes, themed paper pads; notepads; writing books; draft paper; binders, archiving boxes; document folders, book covers; bookmarks; lithographs; framed or unframed paintings (pictures); painting pads, drawing pads, books of games, cross-

swords and puzzles; luminous paper; self-adhesive labels, not of textile; crêpe paper; tissue paper, staples; staplers; flags of paper; pennants (flags) of paper; writing instruments; nibs; pencils; pens; pen sets; pencil sets; felt pens, felt-tip pens; ballpoint pens; felt-tip markers; ink; inking pads; rubber stamps; paint boxes; coloring and drawing pencils; chalks; decorations for pencils (stationery articles); printing blocks; magazines; newspapers; books and journals, particularly concerning athletes and sports events; printed teaching material; schedules (for recording results); event programs; event albums; photograph albums; autograph books; address books; diaries (planners); diaries (personal journals), road maps; entry tickets; air tickets and boarding cards; checks; printed timetables; circulars and pamphlets; comic strips; exchangeable trading cards; collectable trading cards in the field of sports; bumper stickers; stickers; sticker albums; calendars; posters; photographs; postcards; stamps; postage stamps, commemorative stamp sheets; advertising signs and banners of paper or cardboard; transfers [decalcomanias]; office requisites (except furniture); correcting fluids; rubber erasers; pencil sharpeners; stands for pens and pencils; paper clips; thumbtacks; drawing rulers, adhesive tapes for stationery; adhesive tape dispensers; stencils; stencil plates; clipboards; notepad holders; bookends; stamps (seals); telephone, ATM, travel and entertainment, check guarantee and account cards made of paper or cardboard, credit cards (not encoded) of paper or cardboard; luggage tags; passport holders.

18 – Leather and imitation leather; thongs [straps] of leather; umbrellas, parasols; sports bags (other than those adapted for products they are designed to contain); sport trolley bags; duffel bags; leisure bags; travel bags; backpacks; carrier bags; school bags; bags for hanging on belts; handbags; leather bags; ball-shaped leather bags; beach bags; garment bags for travel; suitcases; belts for suitcases; holdalls; briefcases of leather; document wallets; toiletry cases (vanity cases) (empty); toiletry sets; key cases of leather; business card cases; identity card holders; leather luggage tags; document holders; wallets; purses (coin purses); check holders; clothing for pets; collars for pets; leashes for animals.

20 – Mirrors; statues, statuettes, figurines, ornaments, souvenir trophies made of wood, wax, plaster or plastic; registration plates not of metal; badges, bracelets and key cards for identification (not encoded), all the aforesaid products of plastic; cushions; sleeping bags; furniture (furnishings); chairs and seats for indoor and outdoor use; racks; carts (furniture); display stands for goods; fixed towel dispensers (not of metal); coat hangers; fans for personal use; inflatable promotional objects made of plastic; advertising banners and materials of plastic; lanyards made of plastic; frames for photographs;

printed plastic caps to collect (pogs); plastics tool boxes.

21 – Household or kitchen utensils and containers (non-electric); portable cooking kits for outdoor use; glass bottles (containers); spoons for mixing (kitchen utensils); (non-electric) fruit presses for household purposes; cutting boards for the kitchen; trays for household needs; ice buckets; manual mixers (shakers); shakers; sugar bowls; beer mugs, beer jugs, goblets, cups and drinking glasses, decanters; plates and dishes, coasters for glasses and bottles, saucers, glasses; teapots; insulating kitchen gloves; gloves for household use; corkscrews; bottle openers; bottle cap removers; bottles; insulating flasks; non-electric containers for food and beverages; hair combs and brushes; toothbrushes; dental floss; cleaning devices using dental floss; inter-dental stimulators; statues, sculptures, figurines, ornaments and trophies made of terracotta or glass; small decorative bottles for cosmetic use; laundry driers; waste paper baskets; money boxes (not of metal); souvenir table plates; feeding bowls and cages for pets; commemorative plates.

24 – Bed linen; sheets [textile]; eiderdowns [quilts]; bed covers; pillowcases; curtains; shower curtains; curtain fabrics; linen; bath linen; tea towels and cloths; covers; handkerchiefs of textile; wall hangings; flags; car flags (not of paper); streamers; pennants; table linen of textile; labels of cloth.

25 – Clothing; footwear; headgear; shirts; knitwear (clothing); pullovers, sleeveless pullovers; tee-shirts; vests; singlets; dresses; skirts; underwear; swimsuits, two-piece swimsuits (bikinis); tankinis; dressing gowns (robes); shorts; trousers; sweaters; caps (bonnets); caps; hats; scarves; headscarves; sashes for wear; shawls; visors; caps with visors; tracksuits; sweatshirts; jackets; sports jackets; stadium jackets; blazers; waterproof clothing; coats; uniforms; neckties; wrist bands; headbands; gloves; aprons; bibs (not of paper); pajamas; play suits for infants and children; sleeping bags for babies (clothing); socks and stockings; garters; belts; suspenders; sandals, flip-flops; sports shoes, namely, outdoor shoes, hiking shoes, basketball shoes, cross-training shoes, cycling shoes, indoor sports shoes, footwear for track and field athletics, tap shoes, football shoes (indoor and outdoor), football boots, canvas shoes, tennis shoes, street sports shoes, sailing shoes, aerobic shoes; clothing for sport, namely, fleece pullovers, jogging suits, sweat pants, sport shirts, polo shirts, sweat shirts, football-style shirts, rugby-style shirts, socks, bathing suits, leg warmers and tights, tracksuits, functional underwear, singlets, bra tops, leotards, wrist bands, headbands, gloves, snow suits, snow jackets, snow pants.

26 – Braids; tassels (haberdashery); ribbons; ribbons for clothing; buttons; needles; sewing boxes; broac-

hes (clothing accessories); decorative pins and needles not of precious metal; ornament pins for hats not of precious metal; hair bands; hair pins of non-precious metal, hair ribbons; bands for clothing (suspenders); competitors' numbers used in competitions and for advertising purposes; shoe ornaments not of precious metal; badges and patches for applying with flat irons (heat transfer).

27 – Coverings for sports grounds made of artificial turf; artificial turf; carpets; doormats; mats; linoleum and other floor coverings; floor coverings of wood.

28 – Games and toys; play balloons; board games; tables for indoor football; dolls and plush toys; vehicles (toys); jigsaw puzzles; balloons; inflatable toys; playing cards; confetti; articles for gymnastics and sports; appliances for gymnastics; football equipment, namely footballs, gloves, knee guards, elbow guards, shoulder pads, shin guards, football goals; kick-at-goal walls; sports bags and containers (adapted to objects) for carrying sports articles; party hats (toys); hand-held electronic games adapted for use with television receivers only; video games; apparatus for video games; game consoles; electronic game machines with liquid crystal displays; electronic hand-held games other than those designed to be used only with a television receiver; games for tablets; steering wheels and dancing mats for video games; foam hands (toys); robots (toys) for entertainment, arcade games; model airplanes; toys for household pets; scratch cards; kites; roller skates; scooters (toys); skateboards.

29 – Meat; fish; poultry and game; meat extracts; preserved, frozen, dried and cooked fruits and vegetables; canned fruits and vegetables; deep-frozen meat, fish and poultry; edible oils and fats; potato chips; French fries; prepared walnuts; jams; marmalades; jellies; canned fish and meat; milk and milk beverages with milk predominating; drinking yogurts; milkshakes; dairy products; cheeses; soya milk (milk substitute); soups; bouillons.

30 – Coffee; coffee-based beverages; tea; cocoa; sugar; honey; molasses, yeast; artificial coffee; flour; soya; cereal preparations; cereals; bread; pastries; cakes, biscuits, cookies; crackers; candy; ices for food; confectionery; chocolate confectionery; chocolate; rice; dried cereal flakes; corn chips; mustard; vinegar; sauces (condiments); spices; salt; natural low-calorie sweeteners; pizzas; pizza bases; pizza dough; hamburgers; sandwiches; hotdogs (sandwiches); cheeseburgers (sandwiches); ice (hard or soft); tea-based beverages; iced tea; chocolate-based beverages; sauces (condiments).

31 – Foodstuffs for animals; grass seeds; fresh fruit; fresh berries; fresh vegetables; flowers; natural turf; natural turf for sports fields.

32 – Non-alcoholic beverages; concentrates, syrups and powders for making non-alcoholic beverages;

mineral and aerated waters; other non-alcoholic beverages; energy drinks, hypertonic beverages, isotonic beverages, hypotonic beverages; beverages and fruit and vegetable juices; light beverages; sports beverages; frozen fruit beverages; frozen, flavored, non-carbonated and non-alcoholic beverages; beverages enriched with added vitamins (not for medical purposes); beers; lagers and ales; non-alcoholic beers.

33 – Alcoholic beverages, except beers.

34 – Matches; lighters for smokers; cigarette cases, ashtrays, smokers' articles; cigarettes; tobacco.

35 – Advertising; business management; business administration; employment agencies; personnel recruitment; advertising services by sponsorship; on-line advertising services; information and advisory services in relation to commercial business management and commercial administration provided online or via the Internet; advertising and promotional services; dissemination of advertising and promotional materials; provision and rental of advertising space and advertising material; publication of advertising material and texts; rental of advertising time in film credits; television advertising, radio advertising; promotion of football-related sports events; promotion of the goods and services of others; company sponsorship research (sponsoring via advertising promotion) in relation to football competitions; compilation of advertisements as Web pages on the Internet or wireless electronic communication devices; provision of website space for advertising products and services; provision of an online marketplace for sellers and buyers of goods and services; on-line auction services; collection of directories for publication on the Internet and on a wireless electronic communication network; promotional marketing services; services provided by an agency for sports promotion and public relations; market study services; marketing research services; opinion polling services; organization of events, exhibitions, trade fairs and shows for commercial, promotional purposes; organization of advertising for trade fairs; data bank management services; compilation of statistics; collection of data, statistics and other information on sports performances; consultancy relating to company management and organization; business consultancy for companies; organization of promotional competitions; provision of commercial information; advertising for sports events in the field of football; retail services, including online retail services, in connection with articles of common metal, machines and machine tools, tools and utensils, optical, audio-visual, magnetic, electric and electronic equipment and apparatus, medical equipment and apparatus, apparatus and equipment for lighting, heating, cooking, refrigerating, drying and ventilation, vehicles and their accessories, articles of precious metal, jewelry and timepieces and chronometric instruments,

pins and badges, musical instruments, paper and cardboard articles, printed matter and stationery, tickets for sports events, leather and imitation leather articles, luggage and bags, umbrellas, furniture, household articles, promotional and exhibition articles, textile articles, clothing, footwear and headgear, fancy goods (embroidery) and ribbons, cords and goods thereof, floor coverings, games, toys, sporting articles, food and food products, alcoholic and non-alcoholic beverages, solvents, paraffin, wax, bitumen and petroleum, fuels, oils, lubricants, transmission liquids, anti-freeze agents, brake fluids, hydraulic fluids, coolants, greases, fuel, diesel fuel, fuel gas, biofuel, hub caps, tires, casings for pneumatic tires, alloys for wheels, sun screens, roof racks, holders for carrying sports equipment, seat covers, car covers, potato chips, french fries, milk, milk beverages, drinking yoghurt, milk shakes, dairy products, cheese, soya milk (milk substitute), non-alcoholic beverages, mineral and aerated waters, isotonic beverages, energy drinks, beverages and fruit and vegetable juices, beers, lagers and ales, non-alcoholic beer, coffee, tea, cocoa, cakes, biscuits, crackers, confectionery, sweets, edible ices, chocolate, chocolate confectionery, corn chips, mustard, vinegar, sauces (condiments), hamburgers (sandwiches), cheeseburgers, fish, meat or vegetable sandwiches (sandwiches), hotdogs (sandwiches), enabling customers to view and purchase these articles in store or via the Internet or wireless electronic communication; convenience store services in this category including the retail sale of food and beverages; retail sale and provision of food and beverages through vending machines; retail services, including online retail services, in connection with fuel, fuel gas, biofuel, engine oils and greases, lubricants and greases, hydraulic transmission oils and fluids, fluids for hydraulic circuits and hydraulic oils, enabling customers to view and purchase these articles in store or via the Internet or via wireless electronic communication; business administration services for the processing of sales made on the Internet or wireless electronic communication devices; promotion of sales, namely creation of preferential programs for customers; ticket sale promotion services; customer loyalty services and customer club services for commercial, promotional and/or advertising purposes; issuance and distribution of member loyalty cards, which can hold personal information about the identity of the cardholder and for controlling access to sports stadiums; compilation of data into a central file, namely, still or animated images.

36 – Insurance underwriting; financial services; monetary affairs; real estate services; issuance and management of credit cards and travelers' checks; banking services; credit and investment services; financial sponsorship of sports events; provision of online information in relation to financial, banking, insurance and investment services; Internet banking; pa-

yment services via wireless electronic communication apparatus and equipment; credit card services, debit card and electronic check transaction processing; retail banking services, namely, hire-purchase financing and loan, mortgage lending against the net value of a piece of real estate, lending of personal loans and credit spread and research relating thereto, credit for businesses and commercial credit and factoring services connected thereto, home loans, financing and leasing of equipment, management and syndication of mortgages and loans, financing and hire-purchase financing on automobiles, interest rate derivative products, foreign exchange and currency services, deposit activities, securing activities, letters of credit and documentary credit, sales and trading services, asset management, invoicing, coin and security instruments.

37 – Service station services, namely cleaning, lubricating, maintenance and repair of vehicles; anti-rust treatment for vehicles, engines and machines; cleaning, polishing, greasing, lubricating, maintenance and repair of aircraft and trailers; cleaning of motor vehicles; mounting and repair of tires for vehicles; installation and maintenance of wireless electronic communication networks (hardware); installation and repair of computer hardware; real estate construction services; construction, installation and repair of sports grounds of natural or artificial turf; construction and maintenance of electric power plants; construction and maintenance of pipelines; installation of structures for the extraction of crude oil; installation of equipment for the extraction of crude oil; installation of solar panels; installation of wind power systems; installation of hydraulic power systems; mining extraction services.

38 – Telecommunication services; communications by telephones and mobile telephones; electronic communication services by telephone; radio communications; facsimile communications; paging services; teleconferencing services; television program broadcasting; radio program broadcasting; news and press agency services; rental of telephone apparatus, facsimile and other telecommunication apparatus; transmission of commercial Internet pages on-line or via wireless electronic communication devices; services of broadcasting and transmitting of radio and television programs provided via satellite, cable or wireless networks; electronic transmission of messages; provision of access time to a blog, chatroom, bulletin board or discussion service; providing access to live chatrooms online and electronic bulletin boards enabling transmission of messages, comments and multimedia content between users, for creating a network of contacts; provision of access time to Internet sites containing road maps, information on itineraries and location coordinates of businesses; computer-aided transmission of messages and images; rental of access time to private and

commercial purchasing and ordering services via computer, a global computer network and/or interactive communication technologies; electronic mail services; provision of connections for telecommunications via data banks or the Internet; provision of access time to Websites for listening to digital music on the Internet via wireless electronic communication devices; broadcasting of radio and television programs related to sports and sports events; radio or television program broadcasting relating to sports and sports events; provision of connections to computer installations (telecommunication services); rental of access time to a centralized computer and to data banks rental of access time on the Internet via a global information network or via wireless electronic communication devices; real-time transmission (streaming) of video and audio material from the Internet; real-time transmission (streaming) of audio, video and television equipment; provision of access time to search engines.

39 – Travel agency services, namely, travel organization and reservation; reservation of travel tickets, information relating to travel and sale of travel tickets; airplane, train, boat, bus and truck transportation services; air transport services comprising frequent flier bonus programs; boat excursion services; tour operation services; vehicle rental services; rental of parking spaces; taxi services; delivery of goods; transport of goods by motor vehicles, trucks, trains, boats and airplanes; packaging of goods; transport and delivery of goods, namely documents, packages, parcels and letters; postal, messenger and courier services, particularly newspaper, magazine and book delivery services; warehousing; distribution of water, heating, gas or electricity; distribution (delivery) of films and sound and image recordings; distribution of tickets; satellite-assisted navigation services; distribution (transport), delivery and storage of gasoline, petroleum, hydrocarbons, gas, lubricants, solvents, paraffin, wax and bitumen; transmission and distribution of electricity; pipeline transport of oil and gas; transport and disposal of waste; consultancy relating to the delivery of energy and electricity.

40 – Processing of cinematographic films; enlarging of photographs; printing of photographs, development of photographic films; rental of machines and apparatus for photographic developing, printing, enlarging and finishing, printing services, waste disposal; waste management services (recycling); fashion designer services (dressmaking); oil (petroleum) refining; used lubricant and oil treatment services; gas and electricity production services; petroleum and gas processing services; processing and refining of organic substances; production of energy; refining of petrochemical products for others, namely, of petroleum derivatives, particularly of various kinds

of brake fluids; professional consultancy in connection with electricity and energy generation.

41 – Education; training; providing of training courses; entertainment; entertainment services during or in connection with sports events; entertainment services, namely, public retransmission of sports events; organization of sports and cultural events and activities; organization of lotteries and contests; organization of sporting events and competitions in the field of soccer; provision of sports infrastructures; leisure park services; health club (gym) services; rental of audio and video equipment; production, presentation, publication and/or rental of films, of sound and video recordings; publication and/or rental of interactive educational and entertainment products, namely, films, books, compact discs, mini discs, DVDs and CD-ROMs; publication of statistics and other information on sports performances; provision of radio and television reports of sports events; production and editing services for radio and television programs; photography services; photographic, sound and video recording services; production of cartoons; production of animated television programs; reservation of places for entertainment and sports events; ticket reservation services for entertainment and sports events; ticket sales agency services for sports events; timing of sports events; recording of sports events; organization of beauty contests; interactive entertainment; gambling services; provision of raffle services; on-line game services; providing online entertainment in the form of tournaments; organization of computer games competitions, including online games competitions; information relating to entertainment or education provided online from a computer data bank or over a global computer network (the Internet) or via wireless electronic communication devices; services in connection with electronic games provided via a global computer network (the Internet) or via wireless electronic communication devices (entertainment); editing of books; publication of electronic books and journals on-line; entertainment services in the form of chat rooms on a global computer network (the Internet) or via wireless electronic communication devices; entertainment services in the form of cinema performances; translation services; interpreter services; provision of entertainment infrastructures, namely VIP lounges and boxes inside and outside stadiums; reception and hospitality services, namely, customer reception services, including tickets in connection with sports or entertainment events; provision of online information concerning sport and sports events from a computer databank or the Internet.

42 – Rental of computer software and hardware for computers; computer consultancy services; data processing (programming); computer software development; creation, design, compilation and maintenance

of web sites or sites on wireless electronic communication networks; installation and maintenance of computer software; creation and maintenance of electronic communication networks; compilation of websites in computer networks (particularly the Internet) or via wireless electronic communication devices; uploading websites on the Internet or wireless electronic communication networks; hosting of websites on the Internet or on wireless electronic communication sites; provision of software; provision of search engines for the Internet; provision of downloadable software enabling users to create and share texts, documents, images, photos, videos, maps and road maps; development of computer systems, namely creation for users of virtual communities enabling the organization of groups and events, participation in discussions, and social, business and community networking; hosting websites on the Internet enabling others to organize colloquiums, events and interactive discussions via communication networks; application service provider (ASP) services, namely hosting software applications for others; development of software applications for computers; services of cloud computing; design and development of operating software for accessing and using a cloud computing network (cloud computing); provision of software enabling or facilitating uploading, downloading, streaming, posting, display, creation and updating of personal Internet sites (blogs), display of links, sharing and use of other electronic media or information on communication networks; provision of access to customized platforms on the Internet as well as on mobile Internet, including user-generated content or specific content, personal profiles, sounds, videos, images, texts, graphics and data; provision of temporary use of non-downloadable software for use of social networks establishing a virtual community, and transmission of audio and video data, of photographic images, texts, graphics and data; provision of software via an Internet site with technology enabling online users to create personal profiles featuring information on social networking and to transfer and share such information on multiple websites; prospecting for the purpose of locating oil and gas; analysis services for exploiting oilfields; research, development, analysis, advice, design and consultancy relating to technology in the oil industry; technical consulting, design and planning in the field of photovoltaic installations; technical consulting, design and planning of wind installations; research, development and analysis, expertise and consultancy in relation to electronic control units for managing solar electric and/or wind power installations; design of energy and electricity systems; analysis in connection with the energy and power requirements of others; development of energy and electricity management systems; project study services and professional consulting relating to

electricity and energy needs of others; design services for power plants.

43 – Services for providing food and drink, fast-food restaurant services; snack bar services; reception and hospitality services, namely, providing accommodation, food and beverages both on and off sports sites and during sporting events; temporary hospitality services, namely, provision of accommodation, food and beverages both on and off sports sites; food and drink catering; hotel services; provision of food and drink and accommodation, reservation of hotels and temporary accommodation.

45 – Copyright management of audio and visual recordings, computer programs and computer games; protection and security services; rental of clothing and suits; Internet based social networking services.

(260) AM 2016 83876 A

(800) 1264323

(891) 2015 06 02

(731) KALE KILIT VE KALIP SANAYI ANONİM SİRKETİ

Atatürk Caddesi, Başaklı Sok. No.24, GÜNGÖREN/İSTANBUL, Turkey

(540)

KALE KİLİT

(591) black and white

(511)

6 – Locks of metal, namely door locks and parts thereof, steel door locks, locks of metal, keys of metal, locks of metal for sliding doors, locks of metal for windows, key blank of metal, padlocks of metal, mortise lock of metal, suitcase locks, keys of metal for safe box, rim lock of metal, security locks for windows, lock of metal for glass doors, non-electric locks, locks of metal with alarm, built-in door locks; keys, included in this class; safe box of metal; espagnolette of metal; espagnolette of metal for doors with lock; espagnolette of metal for vertical and horizontal lock; handles of metal for doors and windows; metal parts for doors and windows.

9 – Smart cards; smart card readers; electronic lock systems; electronic security locks; magnetic and optic data carriers and computer software and programs recorded thereto; encoded magnetic and optic cards.

(260) AM 2016 83954 A

(800) 1264704

(891) 2015 06 25

(731) ZUCAMI POULTRY EQUIPMENT, S.L.U.

Polig. Ind. Morea Norte, C/C N° 2,
E-31191 BERIAIN (NAVARRA), Spain

(540)

ZUCAMI

(511)

6 – Poultry cages of metal; transportable buildings of metal.

7 – Incubators for eggs; incubators for poultry; modular egg conveyors; nesting boxes for domestic fowl; transporting cages; hoppers for feeding animals (machines).

37 – Installation, assembly and maintenance of poultry cages of metal, transportable buildings of metal, egg incubators, incubators for poultry, modular egg conveyors, nesting boxes for domestic fowl, transporting cages and hoppers for feeding animals (machines).

(260) AM 2016 83955 A

(800) 1264719

(891) 2015 05 06

(731) Toruńskie Zakłady Materiałów
Opatunkowych, Spółka Akcyjna
Żółkiewskiego 20/26, PL-87-100 Toruń,
Poland

(540)



(591) Dark navy blue, orange, white, gray, red and brown

(511)

5 – Adhesive tape for medical purposes.

(260) AM 2016 83956 A

(800) 1250464

(891) 2015 08 26

(731) Obshchestvo s ogranichennoy
otvetstvennost'yu "NATSIONAL'NAYA
KHIMICHESKAYA KOMPANIYA"
4A, str. 2, ul. Chistova, RU-109390 Moskva,
Russian Federation

(540)

Truske

(591) Black, white

(511)

9 – Scientific, nautical, surveying, photographic, cinematographic, optical, weighing, measuring, signalling, checking (supervision), life-saving and teaching apparatus and instruments; apparatus and instruments for conducting, switching, transforming, accumulating, regulating or controlling electricity;

apparatus for recording, transmission or reproduction of sound or images; magnetic data carriers, recording discs; compact discs, DVDs and other digital recording media; mechanisms for coin-operated apparatus; cash registers, calculating machines, data processing equipment, computers; computer software; fire-extinguishing apparatus; DVD players; 3D spectacles; ticket dispensers; coin-operated musical automata [juke boxes]; fire engines; answering machines; electrical adapters; accumulators, electric; accumulators, electric, for vehicles; accelerometers; actinometers; alidades; altimeters; ammeters; anemometers; anodes; antennas; anticathodes; apertometers [optics]; high-frequency apparatus; testing apparatus not for medical purposes; remote control apparatus; electro-dynamic apparatus for the remote control of railway points; electro-dynamic apparatus for the remote control of signals; monitoring apparatus, electric; sound recording apparatus; Global Positioning System [GPS] apparatus; distillation apparatus for scientific purposes; diffraction apparatus [microscopy]; air analysis apparatus; apparatus to check franking; sound transmitting apparatus; apparatus for fermentation [laboratory apparatus]; breathing apparatus for underwater swimming; breathing apparatus, except for artificial respiration; apparatus and installations for the production of X-rays, not for medical purposes; cash registers; electric apparatus for commutation; intercommunication apparatus; stills for laboratory experiments; projection apparatus; radiological apparatus for industrial purposes; X-ray apparatus not for medical purposes; blueprint apparatus; flashing lights [luminous signals]; stereoscopic apparatus; telephone apparatus; facsimile machines; phototelegraphy apparatus; igniting apparatus, electric, for igniting at a distance; acid hydrometers; salinometers; acidimeters for batteries; aerometers; beacons, luminous; battery jars; barometers; anode batteries; galvanic batteries; batteries for lighting; solar batteries; solar panels for the production of electricity; batteries, electric; balances [steelyards]; betatrons; binoculars; electronic tags for goods; lens hoods; magnetic tape units for computers; computer memory devices; fire hose nozzles; encoded identification bracelets, magnetic; safety tarpaulins; body armor; signalling buoys; life buoys; marking buoys; directional compasses; vacuum gauges; electrolyzers; variometers; verniers; scales; letter scales; weighbridges; precision balances; levelling staffs [surveying instruments]; camcorders; video baby monitors; video cassettes; video telephones; video screens; viewfinders, photographic; sockets, plugs and other contacts [electric connections]; micrometer screws for optical instruments; viscosimeters; circuit closers; wavemeters; voltmeters; mechanical signs; signs, luminous; switchboxes [electricity]; current rectifiers; gas testing instruments; gasometers [measuring instruments]; galvanometers; hands free kits for phones; heliographic apparatus;

hygrometers; hydrometers; weights; peepholes [magnifying lenses] for doors; holograms; plotters; loudspeakers; sounding leads; plumb bobs; range finders; densimeters; densitometers; optical goods; detectors; smoke detectors; counterfeit [false] coin detectors; transparencies [photography]; slide projectors; diaphragms [photography]; dictating machines; dynamometers; light-emitting diodes [LED]; floppy disks; sound recording discs; disks, magnetic; optical discs; circular slide rules; disk drives for computers; juke boxes for computers; DNA chips; electronic notice boards; bulletproof waistcoats [vests (Am.)]; life jackets; identification threads for electric wires; nose clips for divers and swimmers; locks, electric; bells [warning devices]; alarm bells, electric; electric door bells; signal bells; acoustic conduits; mirrors for inspecting work; road signs, luminous or mechanical; marine depth finders; probes for scientific purposes; buzzers; needles for record players; measures; pressure measuring apparatus; simulators for the steering and control of vehicles; inverters [electricity]; pressure indicators; temperature indicators; incubators for bacteria culture; measuring instruments; cosmographic instruments; mathematical instruments; levelling instruments; instruments containing eyepieces; surveying instruments; azimuth instruments; interfaces for computers; ionization apparatus not for the treatment of air or water; spark-guards; coaxial cables; fibre [fiber (Am.)] optic cables; cables, electric; calipers; slide calipers; screw-tapping gauges; calculating machines; pocket calculators; decompression chambers; cinematographic cameras; life-saving capsules for natural disasters; electronic pens [visual display units]; holders for electric coils; identity cards, magnetic; video game cartridges; toner cartridges, unfilled, for printers and photocopiers; memory cards for video game machines; encoded magnetic cards; riding helmets; protective helmets; carriers for dark plates [photography]; automated teller machines [ATM]; cathodes; spools [photography]; choking coils [impedance]; coils, electric; electromagnetic coils; cinematographic film, exposed; computer keyboards; solenoid valves [electromagnetic switches]; wire connectors [electricity]; encoded key cards; electronic book readers; electronic agendas; push buttons for bells; mouse pads; magnetic encoders; anti-glare visors; collectors, electric; calibrating rings; protective suits for aviators; commutators; compact discs [audio-video]; compact discs [read-only memory]; comparators; marine compasses; computers; laptop computers; tablet computers; notebook computers; condensers [capacitors]; contacts, electric; wind socks for indicating wind direction; traffic cones; branch boxes [electricity]; distribution boxes [electricity]; junction boxes [electricity]; battery boxes; cabinets for loudspeakers; diving suits; galena crystals [detectors]; reflecting discs for wear, for the prevention of traffic accidents; covers for

electric outlets; logs [measuring instruments]; lasers, not for medical purposes; lactodensimeters; lactometers; vacuum tubes [radio]; darkroom lamps [photography]; thermionic tubes; amplifying tubes; flashlights [photography]; head cleaning tapes [recording]; magnetic tapes; videotapes; surveying chains; fire escapes; rulers [measuring instruments]; slide-rules; contact lenses; correcting lenses [optics]; optical lenses; optical condensers; sounding lines; electricity conduits; measuring spoons; magnifying glasses [optics]; thread counters; magnets; decorative magnets; close-up lenses; crash test dummies; resuscitation mannequins [teaching apparatus]; mouse [computer peripheral]; pressure gauges; divers' masks; solderers' helmets; protective masks; materials for electricity mains [wires, cables]; voting machines; money counting and sorting machines; material testing instruments and machines; furniture especially made for laboratories; megaphones; portable media players; diaphragms [acoustics]; diaphragms for scientific apparatus; metal detectors for industrial or military purposes; metronomes; rules [measuring instruments]; carpenters' rules; dressmakers' measures; mechanisms for counter-operated apparatus; coin-operated mechanisms for television sets; shutter releases [photography]; micrometers; microprocessors; microscopes; microtomes; microphones; modems; lightning conductors [rods]; monitors [computer hardware]; monitors [computer programs]; terminals [electricity]; junction sleeves for electric cables; teeth protectors; temperature indicator labels, not for medical purposes; knee-pads for workers; headphones; surveyors' levels; sound recording carriers; magnetic data media; optical data media; socks, electrically heated; computer software, recorded; sheaths for electric cables; identification sheaths for electric wires; weighing machines; computer apparatus; punched card machines for offices; life saving apparatus and equipment; shoes for protection against accidents, irradiation and fire; objectives [lenses] [optics]; lenses for astrophotography; egg-candlers; fire extinguishers; electrified fences; limiters [electricity]; clothing for protection against accidents, irradiation and fire; clothing for protection against fire; asbestos clothing for protection against fire; clothing especially made for laboratories; ozonisers [ozonators]; octants; eyepieces; ohmmeters; wrist rests for use with computers; spectacle frames; eyeglass frames; oscillographs; plumb lines; mirrors [optics]; spectacles [optics]; sunglasses; goggles for sports; signalling panels, luminous or mechanical; radio pagers; pince-nez; electronic pocket translators; transmitters [telecommunication]; telephone transmitters; transmitters of electronic signals; switches, electric; periscopes; gloves for divers; gloves for protection against accidents; gloves for protection against X-rays for industrial purposes; asbestos gloves for protection against accidents; furnaces for laboratory use; pipettes; pyrometers; planimeters;

plane tables [surveying instruments]; plates for batteries; wafers for integrated circuits; printed circuit boards; compact disc players; cassette players; sound recording strips; X-ray films, exposed; films, exposed; life-saving rafts; laboratory trays; digital signs; semi-conductors; polarimeters; fire pumps; measuring glassware; life belts; fuses; circuit breakers; converters, electric; telerupters; food analysis apparatus; diagnostic apparatus, not for medical purposes; distance recording apparatus; distance measuring apparatus; speed measuring apparatus [photography]; appliances for measuring the thickness of leather; apparatus for measuring the thickness of skins; speed checking apparatus for vehicles; teaching apparatus; time recording apparatus; apparatus and instruments for astronomy; surveying apparatus and instruments; weighing apparatus and instruments; nautical apparatus and instruments; navigational instruments; optical apparatus and instruments; apparatus and instruments for physics; chemistry apparatus and instruments; measuring apparatus; measuring devices, electric; boiler control instruments; meteorological instruments; naval signalling apparatus; observation instruments; navigation apparatus for vehicles [on-board computers]; satellite navigational apparatus; regulating apparatus, electric; precision measuring apparatus; audio- and video-receivers; prisms [optics]; printers for use with computers; hemline markers; retorts' stands; apparatus for changing record player needles; drainers for use in photography; cleaning apparatus for sound recording discs; fire beaters; telescopic sights for firearms; telescopic sights for artillery; test tubes; pressure indicator plugs for valves; magnetic wires; telegraph wires; telephone wires; wires, electric; conductors, electric; copper wire, insulated; fuse wire; computer programmes [programs], recorded; computer game software; computer programs [downloadable software]; computer operating programs, recorded; record players; processors [central processing units]; rods for water diviners; electronic publications, downloadable; distribution consoles [electricity]; control panels [electricity]; radar apparatus; baby monitors; masts for wireless aerials; transmitting sets [telecommunication]; radios; vehicle radios; sprinkler systems for fire protection; frames for photographic transparencies; screens for photoengraving; walkie-talkies; voltage surge protectors; voltage regulators for vehicles; stage lighting regulators; light dimmers [regulators], electric; speed regulators for record players; cell switches [electricity]; washing trays [photography]; marking gauges [joinery]; time switches, automatic; relays, electric; safety restraints, other than for vehicle seats and sports equipment; X-ray photographs, other than for medical purposes; rheostats; respirators for filtering air; respiratory masks, other than for artificial respiration; retorts; refractometers; refractors; grids for batteries; speaking tubes; horns for loudspeakers;

saccharometers; optical fibers [fibres] [light conducting filaments]; traffic-light apparatus [signalling devices]; dog whistles; signalling whistles; sextants; inductors [electricity]; safety nets; nets for protection against accidents; fire alarms; signals, luminous or mechanical; sirens; scanners [data processing equipment]; smartphones; integrated circuit cards [smart cards]; connections for electric lines; couplings, electric; connectors [electricity]; sonars; sound locating instruments; lighting ballasts; resistances, electric; spectrograph apparatus; spectroscopes; speed indicators; alcoholmeters; satellites for scientific purposes; protection devices for personal use against accidents; audiovisual teaching apparatus; radiotelegraphy sets; radiotelephony sets; spectacle lenses; anti-glare glasses; optical glass; personal stereos; stereoscopes; stands for photographic apparatus; stroboscopes; fire boats; sulfimeters; bags adapted for laptops; drying racks [photography]; spherometers; integrated circuits; printed circuits; counters; parking meters; kilometer recorders for vehicles; revolution counters; abacuses; egg timers [sandglasses]; taximeters; ear plugs for divers; tachometers; television apparatus; telegraphs [apparatus]; telescopes; teleprompters; teleprinters; mobile telephones; cordless telephones; theodolites; thermometers, not for medical purposes; thermostats; thermostats for vehicles; crucibles [laboratory]; tone arms for record players; totalizers; transistors [electronic]; transponders; protractors [measuring instruments]; transformers [electricity]; step-up transformers; vehicle breakdown warning triangles; triodes; starter cables for motors; discharge tubes, electric, other than for lighting; capillary tubes; neon signs; Pitot tubes; X-ray tubes not for medical purposes; telephone receivers; gauges; quantity indicators; automatic indicators of low pressure in vehicle tires [tyres]; gasoline gauges; water level indicators; electric loss indicators; light-emitting electronic pointers; slope indicators; levels [instruments for determining the horizontal]; mercury levels; spirit levels; urinometers; amplifiers; particle accelerators; electric installations for the remote control of industrial operations; steering apparatus, automatic, for vehicles; balancing apparatus; video recorders; sound reproduction apparatus; invoicing machines; tape recorders; protection devices against X-rays, not for medical purposes; railway traffic safety appliances; data processing apparatus; oxygen transvasing apparatus; theft prevention installations, electric; film cutting apparatus; drying apparatus for photographic prints; optical character readers; centering apparatus for photographic transparencies; dosage dispensers; battery chargers; chargers for electric batteries; acoustic [sound] alarms; sounding apparatus and machines; editing appliances for cinematographic films; cathodic anti-corrosion apparatus; couplers [data processing equipment]; anti-theft warning apparatus; computer peripheral devices; anti-interference devi-

ces [electricity]; demagnetizing apparatus for magnetic tapes; acoustic couplers; alarms; fog signals, non-explosive; whistle alarms; adding machines; readers [data processing equipment]; heat regulating apparatus; photocopiers [photographic, electrostatic, thermic]; bar code readers; computer software applications, downloadable; downloadable ring tones for mobile phones; downloadable image files; downloadable music files; animated cartoons; filters [photography]; filters for respiratory masks; filters for ultraviolet rays, for photography; USB flash drives; magic lanterns; optical lamps; signal lanterns; cameras [photography]; glazing apparatus for photographic prints; shutters [photography]; darkrooms [photography]; photometers; flash-bulbs [photography]; digital photo frames; enlarging apparatus [photography]; photovoltaic cells; containers for contact lenses; spectacle cases; pince-nez cases; containers for microscope slides; cases especially made for photographic apparatus and instruments; chromatography apparatus for laboratory use; chronographs [time recording apparatus]; laboratory centrifuges; eyeglass chains; cyclotrons; compasses [measuring instruments]; frequency meters; time clocks [time recording devices]; Petri dishes; sleeves for laptops; fire blankets; chips [integrated circuits]; jigs [measuring instruments]; pedometers; meteorological balloons; electrified rails for mounting spot lights; asbestos screens for firemen; fire hose; protective helmets for sports; cell phone straps; eyeglass cords; tripods for cameras; switchboards; distribution boards [electricity]; screens [photography]; workmen's protective face-shields; projection screens; radiology screens for industrial purposes; fluorescent screens; exposure meters [light meters]; ducts [electricity]; galvanic cells; epidiascopes; ergometers; armatures [electricity]; temperature sensors; remote announcement flood sensors.

(260) AM 2016 83957 A
 (800) 1250989
 (891) 2015 07 28
 (731) KURT GEIGER LIMITED
 24 Britton Street, London EC1M 5UA,
 United Kingdom
 (540)



(591) Black, white
 (511)

3 – Soaps; perfumery, essential oils, cosmetics, non-medicated toiletries, bath and shower gels, skincare preparations hair care and hair colouring prepara-

tions, shampoos and conditioners, body lotions, hand lotions, non-medicated foot lotions; dentifrices; shoe cream, shoe polish, shoe wax.

9 – Magnetically encoded credit cards, debit cards, reward cards and payment cards; unencoded magnetic cards; smart cards; encoded bank cards; apparatus for recording, transmission or reproduction of sound or images, magnetic data carriers, recording discs; pre-recorded CDs; CD ROMs, tapes and discs; sunglasses, spectacles, sunglasses and spectacles cases and frames, contact lenses and contact lens containers.

14 – Jewellery; clocks and watches; cuff-links; buckles for watchbands; buckles for jewellery; precious stones; precious metals and their alloys and goods in precious metals or coated therewith coated therewith included in this class, namely, jewellery; horological and chronometric instruments.

18 – Leather and imitations of leather, and goods made of these materials included in this class; namely, attaché cases, hat boxes, suitcases, briefcases, briefcase-type portfolios, key cases, purses, wallets, credit card holders, tablet holders, shoulder bags, rucksacks, back packs, vanity cases sold empty, cosmetic cases sold empty, and carry-on bags; luggage; trunks; travelling bags; handbags, purses, and wallets; umbrellas and parasols; walking sticks.

25 – Footwear, shoes, boots, sandals, slippers, scarves, belts (clothing), gloves [clothing], headgear, namely, hats and caps.

35 – The bringing together, for the benefit of others, of a variety of goods, enabling customers to conveniently view and purchase those goods in retail department stores, retail stores, supermarkets, mail order catalogues, or from an Internet website; all of the above services being connected with goods in the field of footwear, shoes, sandals, slippers, sunglasses, spectacles, cases for sunglasses and spectacles, frames for sunglasses and spectacles, contact lenses, containers for contact lenses, jewellery and precious stones, clocks, watches, cufflinks, belts for clothing, belt buckles, horological and chronometric instruments, attaché cases, suitcases, briefcases, briefcase-type portfolios, key cases, purses, wallets, credit card holders, covers and cases for tablet computers, shoulder bags, rucksacks, backpacks, vanity cases sold empty, cosmetic cases sold empty, and carry-on bags, luggage, travelling trunks, travelling bags, handbags, umbrellas, parasols, walking sticks, scarves, gloves, beauty and personal care products, cosmetics, perfumes, and headgear, namely, hats and caps; advertising and promotional services; sales incentives; customer loyalty services and customer club services.

(260) AM 2016 83958 A

(800) 1264774

(891) 2015 05 21

(731) MELIKIAN DAVYD ARMENOVYCH
vul. Budonoho, 3, kv. 44, m. Andrushivka,
Zhytomyrska obl. 13400, Ukraine

(540)



(591) Black,white

(511)

29 – Meat, fish, poultry and game; meat extracts; preserved, frozen, dried and cooked fruits and vegetables; jellies, jams, compotes; eggs; milk and milk products; edible oils and fats; alginates for culinary purposes; anchovy; peanuts, prepared; peanut butter; bacon; albumen for culinary purposes; white of eggs; beans, preserved; bouillon; bouillon concentrates; marmalade; cream [dairy products]; whipped cream; oysters, not live; nuts, prepared; peas, preserved; mushrooms, preserved; hummus [chickpea paste]; potato fritters; jams; seaweed extracts for food; gelatine; meat jellies; bone oil, edible; lard; coconut fat; suet for food; coconut oil; fatty substances for the manufacture of edible fats; fat-containing mixtures for bread slices; fish roe, prepared; fish mousses; flaxseed oil for culinary purposes; fruit-based snack food; yolk of eggs; cranberry sauce [compote]; frozen fruits; salted fish; frosted fruits; raisins; caviar; yoghurt; chocolate nut butter; sauerkraut; potato flakes; potato chips; kefir [milk beverage]; isinglass for food; croquettes; corn oil; koumiss [kumiss] [milk beverage]; curd; sesame oil; spiny lobsters, not live; fruit pulp; fruit chips; meat, tinned [canned (Am.)]; meat, preserved; margarine; butter; marmalade; buttercream; almonds, ground; mussels, not live; milk beverages, milk predominating; kimchi [fermented vegetable dish]; shellfish, not live; sea-cucumbers, not live; vegetables, tinned [canned (Am.)]; vegetable salads; vegetable juices for cooking; vegetable soup preparations; vegetables, cooked; vegetable mousses; gherkins; olives, preserved; olive oil for food; lobsters, not live; herrings, not live; palm oil for food; palm kernel oil for food; lecithin for culinary purposes; toasted laver; liver pastes; pectin for culinary purposes; liver; pollen prepared as foodstuff; piccalilli; crayfish, not live; crustaceans, not live; fish, preserved; fish meal for human consumption; fish fillets; fish, tinned [canned (Am.)]; foods made from fish; colza oil for food; sardines, not live; pork; cheese; whey; rennet; preparations for making bouillon; tofu; soya beans, preserved, for food; salted meats; pickles; sunflower oil for food; sausages; sausages in batter; lentils, preserved; soups; seeds, prepared; sunflower seeds, prepared; preparations for making soup; tahini [sesame seed paste]; soya milk [milk substitute]; tripe;

tomato paste; tomato juice for cooking; truffles, preserved; tuna, not live; dates; fruit preserved in alcohol; fruit peel; fruit jellies; fruit, stewed; fruits, tinned [canned (Am.)]; fruit salads; edible birds' nests; onions, preserved; ham; silkworm chrysalis, for human consumption; apple puree; poultry, not live; preserved garlic; non-alcoholic eggnog; powdered eggs; snail eggs for consumption.

(260) AM 2016 83968 A

(800) 1264883

(891) 2015 07 07

(731) SANOFI BIOTECHNOLOGY
54 rue La Boétie F-75008 Paris, France

(540)

DECRELEN

(511)

5 – Pharmaceutical products.

(260) AM 2016 83969 A

(800) 1264898

(891) 2015 08 06

(731) HARRY WINSTON INC.
718 Fifth Avenue, New York, NY 10019,
USA

(540)

HARRY WINSTON

(511)

3 – Soaps; perfumery, essential oils, cosmetics.

(260) AM 2016 83970 A

(800) 1264915

(891) 2015 08 07

(731) NOVARTIS AG
CH-4002 Basel, Switzerland

(540)

CLAREON

(511)

10 – Medical and surgical ophthalmic instruments and apparatus; intraocular lenses.

(260) AM 2016 83971 A

(800) 1264916

(891) 2015 03 27

(731) Luigi DE CRISTOFARO
Via Bugnano, 54,I-81030 ORTA DI ATELLA
(CE), Italy

(540)



(591) Black,white

(511)

25 – Clothing, leather coats, leather jackets, leather trousers, leather skirts, leather tops, leather raincoats, leather long coats, leather overcoats, leather belts, leather braces for clothing, belts, suits, padded jackets, jackets, stuff jackets, jumpers, trousers, jeans, skirts, dresses, coats, overcoats, cloaks, raincoats, parkas, pullovers, shirts, T-shirts, blouses, sweaters, underwear, baby dolls being nightwear, bathrobes, bathing costumes, negligee, swim suits, dressing gowns, nightgowns, one-piece dresses, two-piece dresses, evening dresses, shawls, scarves, ties, neckties, gentlemen suits, dress shirts, aloha shirts, sweat shirts, undershirts, polo shirts, body suits, blazers, shorts, sport shirts; shoes, athletic shoes, slippers, overshoes, low heel shoes, leather shoes, rubber shoes, galoshes, golf shoes, wooden clogs, angler shoes, basketball shoes, dress shoes, heels, hiking shoes, rugby shoes, boxing shoes, baseball shoes, lacquered shoes, beach shoes, inner soles, soles for footwear, footwear uppers, heelpieces for shoes and boots, non-slipping pieces for shoes and boots, tips for footwear, rain shoes, track-racing shoes, work shoes, straw shoes, gymnastic shoes, boots, ski boots, half boots, arctic boots, football boots, laced boots, field hockey shoes, handball shoes, esparto shoes or sandals, sandals, bath sandals; socks, sock suspenders, stockings, garters, gloves, mittens, muffs, shawls, ties, neckties, gloves, winter gloves, leather gloves, mittens; hats and caps, visors (headgear), leather hats and caps.

(260) AM 2016 83972 A

(800) 1264924

(891) 2015 08 14

(731) The Swatch Group Management Services AG
(The Swatch Group Management Services SA) (The Swatch Group Management Services LTD)
Seevorstadt 6, CH-2502 Biel/Bienne,
Switzerland

(540)

CANOPUS GOLD

(511)

14 – Precious metals and their alloys.

(260) AM 2016 83977 A

(800) 1264941

(891) 2014 11 12

(731) H. Lundbeck A/S
Ottiliavej 9, DK-2500 Valby, Denmark

(540)



(591) Orange.

(511)

5 – Pharmaceutical preparations and substances; vaccines; pharmaceutical preparations and substances for the prevention and treatment of disorders and diseases in, generated by or acting on the central nervous system; pharmaceutical preparations and substances acting on the central nervous system; central nervous system stimulants; pharmaceutical preparations and substances for the prevention and treatment of psychiatric and neurological disorders and diseases; pharmaceutical preparations and substances for the prevention and treatment of Alzheimer's disease and disorder, stroke, depression, mood disorders, psychosis, anxiety, epilepsy, sclerosis, porphyria, Huntington's disease and disorder, insomnia, Parkinson's disease and disorder, schizophrenia, bipolar disorder and disease, oncology, pain, alcoholism and dependency; preparations, substances, reagents and agents for diagnostic and medical purposes.

(260) AM 2016 83978 A

(800) 1264947

(891) 2015 07 28

(731) MERCK KGAA

Frankfurter Str. 250, 64293 Darmstadt,
Germany

(540)

FREPENSO

(511)

5 – Pharmaceutical preparations for the treatment of neurological diseases and disorders.

(260) AM 2016 83980 A

(800) 1264950

(891) 2015 08 07

(731) MÄURER & WIRTZ GmbH & Co. KG

Zweifaller Str. 120, 52224 Stolberg, Germany

(540)

Pure Pastel Mint

(511)

3 – Soaps, cosmetics except such with coloring characteristics or effects, perfumery, essential oils, hair lotions, dentifrices.

(260) AM 2016 83981 A

(800) 1264959

(891) 2015 07 20

(731) L&O HUNTING GROUP GMBH

Ziegelstadel 1, 88316 Isny, Germany

(540)

Quattro

(511)

13 – Firearms, triggers for firearms [parts of firearms], the aforesaid goods except for firearms with four barrels (quadruplets); ammunition and projectiles; accessories for the aforesaid goods [included in this class], in particular gun bags, gun cases, cartridge belts, gun slings, cartridge cases.

(260) AM 2016 83982 A

(800) 1264971

(891) 2014 10 10

(731) ADP GAUSELMANN GMBH

Merkur-Allee 1-15,32339 Espelkamp,
Germany

(540)

Slot Aliens

(511)

9 – Scientific, nautical, surveying, photographic, cinematographic, optical, weighing, measuring, signalling, checking (supervision), life-saving and teaching apparatus and instruments; apparatus and instruments for conducting, switching, transforming, accumulating, regulating or controlling electricity; apparatus for recording, transmission or reproduction of sound or images; magnetic data carriers, recording discs; compact discs, DVDs and other digital recording media; cash registers, calculating machines, data processing equipment, computers; computer software; fire-extinguishing apparatus; musical jukeboxes and parts for the aforesaid automatic machines; automatic cash dispensers, automatic money counting and money changing machines; mechanisms for coin-operated apparatus; computer and video games software; games software for use on any computer platform, including electronic entertainment and games consoles; programs for computer games; computer games; video games (software); computer games provided through a global computer network or supplied by means of multi-media electronic broadcast or through telecommunications or electronic transmission or via the Internet; computer games, leisure and recreational software, video games and computer software, all provided in the form of storage media; programs for operating electric and electronic apparatus for games, amusement and/or entertainment purposes; automatic lottery machines; computer software for computer games on the Internet; online games (software); computer software in the form of an app for mobile devices and computers; calculating apparatus in coin operated machines and parts for the aforesaid goods; apparatus for recording, transmission, processing or reproduction of data, including sound or images, including parts for all the aforesaid goods, except radio sets, television receivers, hi-fi systems, video recorders, telephone apparatus, fax machines and telephone answering machines; computer hardware and software for casino and amusement arcade games,

for gaming machines, slot machines or video lottery gaming machines or games of chance via the Internet; electric, electronic, optical or automatic apparatus, for identifying data carriers, identity cards and credit cards, bank notes and coins; electric, electronic or optical alarm and monitoring installations, including video cameras and apparatus for image transmission and image processing; data processing equipment and computers, including data processing apparatus and computers being components for data networks and parts facilitating data network communications; electric wiring harnesses; circuit boards, printed board assemblies (electronic components) and combinations thereof being assemblies and equipment parts, included in this class.

28 – Games; toys; gymnastic and sporting articles not included in other classes; decorations for Christmas trees; gaming apparatus (including coin-operated apparatus); coin-operated arcade games (machines); games for amusement arcades (included in this class); coin-operated video gaming apparatus; video games apparatus adapted for use with external screens or monitors only; casino fittings, namely roulette tables, roulette wheels; coin-operated automatic gaming machines and gaming machines, in particular for gaming arcades, with or without a prize payout; electronic or electrotechnical gaming apparatus, gaming machines, games machines and slot machines operated by coins, tokens, banknotes, tickets or by means of electronic, magnetic or biometric storage media, in particular for commercial use in casinos and amusement arcades, with or without a prize payout; automatic gaming machines and gaming machines, in particular for commercial use in casinos and gaming arcades, with or without a prize payout; coin-operated gaming machines and/or electronic money-based gaming apparatus (machines), with or without prizes; housings adapted for gaming machines, gaming apparatus and automatic gaming machines, operated by means of coins, tokens, tickets or by means of electronic, magnetic or biometric storage media in particular for commercial use in casinos and gaming arcades, with or without a prize payout; electronic games; video output game machines; drawing apparatus for prize games and lotteries, draws or raffles; housings of metal, plastic and/or wood for coin-operated automatic machines; apparatus for games (including video games), other than adapted for use with external screens or monitors only; electronic bingo machines [gaming machines]; gaming tables, in particular for table football, billiards, sliding games; quoits (playthings) and darts; video lottery terminals [gaming machines]; LCD games consoles; automatic gaming machines; apparatus and devices for accepting and storing money, being fittings for the aforesaid automatic machines, included in this class.

41 – Education; providing of training; entertainment; sporting and cultural activities; rental of automatic slot machines and entertainment machines for casino

nos; arranging and conducting games; gambling; operating lotteries; conducting of games on the internet also on the mobile internet; online game services provided via a computer network; conducting quizzes by means of smartphone applications; providing casino facilities (gambling), betting offices; operating gaming establishments, arcades and/or online Internet casinos and betting platforms; gambling services via the Internet.

(260) AM 2016 83983 A
 (800) 1265039
 (891) 2015 04 30
 (731) HENKEL AG & CO. KGAA
 Henkelstr. 67, 40589 Düsseldorf,
 Germany
 (540)



(591) White and red.
 (511)
 1 – Chemicals for moisture absorption, included in this class; air desiccants.

(260) AM 2016 83986 A
 (800) 1265103
 (891) 2015 07 28
 (731) MERCK KGAA
 Frankfurter Strasse 250, 64293 Darmstadt,
 Germany
 (540)

SANZESA

(511)
 5 – Pharmaceutical preparations.

(260) AM 2016 83988 A
 (800) 1265204
 (891) 2015 07 27
 (731) UCB Biopharma SPRL
 Allée de la Recherche 60, B-1070 Bruxelles,
 Belgium
 (540)



(591) Black, white

(511)
 5 – Pharmaceutical and veterinary products; sanitary products for medical purposes; dietetic food and substances for medical or veterinary use, food for babies; food supplements for humans and animals; plasters, materials for dressings; material for dental fillings and dental impressions; disinfectants; products for destroying vermin; fungicides, herbicides.

(260) AM 2016 84102 A
 (800) 1266876
 (891) 2015 02 12
 (731) APPLE INC.
 1 Infinite Loop, Cupertino CA 95014, USA
 (540)



(591) Blue, white, green, red, and gray.
 (511)
 9 – Computer software for searching, transmitting, storing, accessing, finding, organizing and viewing geographic locations, and for providing traffic information, travel route planning, driving and walking directions, customized mapping of locations, electronic map display, and destination information.

(260) AM 2016 84105 A
 (800) 1266878
 (891) 2015 02 23
 (731) APPLE INC.
 1 Infinite Loop, Cupertino CA 95014, USA
 (540)



(591) red, orange, yellow, green, blue, purple, pink, gray, and white
 (511)
 9 – Computer software for organizing, storing, sharing, and viewing photos and video files.

(260) AM 2016 84106 A
 (800) 1266879
 (891) 2015 02 23
 (731) APPLE INC.
 1 Infinite Loop, Cupertino CA 95014, USA
 (540)



(591) black, blue, gray and white
 (511)
 9 – Computer software for organizing and viewing financial data and related news and information as a component feature of wearable wireless communication devices and mobile digital electronic devices.

(260) AM 2016 84123 A
 (800) 1266643
 (891) 2015 02 24
 (731) APPLE INC.
 1 Infinite Loop, Cupertino CA 95014, USA
 (540)

TAPTIC ENGINE

(511)
 14 – Horological and chronometric instruments; watches; timepieces; chronographs for use as timepieces; chronometers; watchstraps; watch bands; cases for watches, and horological and chronometric instruments; parts for watches and horological and chronometric instruments.

(260) AM 2016 84127 A
 (800) 1266656
 (891) 2015 02 24
 (731) APPLE INC.
 1 Infinite Loop, Cupertino CA 95014, USA
 (540)

TAPTIC ENGINE

(511)
 28 – Computer gaming machines; handheld electronic game units adapted for use with an external display screen or monitor; handheld computer games and electronic games.

(260) AM 2016 84131 A
 (800) 1266599
 (891) 2015 05 19
 (731) MARS, INCORPORATED
 6885 Elm Street, McLean, Virginia
 22101-3883, USA

(540)



(591) Red, black, brown, beige, white and golden
 (511)
 30 – Confectionery; chocolate; chocolate products; candies [sweets]; tarts; cookies; pastries; cakes; ice-cream; frozen yogurt [confectionery ices]; cereal-based snacks.

(260) AM 2016 84132 A
 (800) 1266704
 (891) 2015 06 10
 (731) BEIERSDORF AG
 Unnastrasse 48, 20253 Hamburg, Germany
 (540)

NIVEA MAKE-UP EXPERT

(511)
 3 – Cosmetics; cosmetic skin cleaning and skin care preparations.

(260) AM 2016 84134 A
 (800) 1266728
 (891) 2015 06 23
 (731) KIRA PLASTININA STYLE, LTD.
 app. 311 A, Building 3, 108, Dmitrovskoe
 shosse, RU-127591 Moscow, Russian
 Federation
 (540)



КИРА ПЛАСТИНИНА
 МАНУФАКТУРЫ
 KIRA PLASTININA MANUFACTURE

(591) black and white
 (511)
 25 – Wimples; bandanas [neckerchiefs]; underwear; sweat-absorbent underwear; berets; overalls; boas [necklets]; teddies [undergarments]; half-boots; ski boots; boots for sports; breeches for wear; trousers; football boots; brassieres; valenki [felted boots]; detachable collars; collars [clothing]; shirt yokes; veils [clothing]; gabardines [clothing]; galoshes; neckties; ascots; leggings [leg warmers]; gaiters; boot uppers; corselets; jerseys [clothing]; vests; sports jerseys; hosiery; heels; boxer shorts; hoods [clothing]; hat frames [skeletons]; pockets for clothing; neck scarfs

[mufflers]; visors [headwear]; cap peaks; tights; slips [undergarments]; combinations [clothing]; wet suits for water-skiing; bodices [lingerie]; corsets [underclothing]; suits; bathing suits; masquerade costumes; beach clothes; jackets [clothing]; stuff jackets [clothing]; fishing vests; leggings [trousers]; liveries; camisoles; cuffs; short-sleeve shirts; mantillas; coats; sleep masks; furs [clothing]; mittens; miters [hats]; muffs [clothing]; footmuffs, not electrically heated; heelpieces for footwear; bibs, not of paper; fur stoles; ear muffs [clothing]; socks; beach shoes; footwear; sports shoes; paper clothing; outer-clothing; ready-made clothing; motorists' clothing; cyclists' clothing; clothing for gymnastics; clothing of imitations of leather; clothing of leather; uniforms; clothing; fittings of metal for footwear; maniples; overcoats; parkas; pelerines; ski gloves; gloves [clothing]; pajamas (Am.); bathing trunks; shirt fronts; scarfs; pocket squares; dresses; waterproof clothing; headbands [clothing]; garters; sock suspenders; stocking suspenders; ready-made linings [parts of clothing]; dress shields; soles for footwear; braces for clothing [suspenders]; lace boots; ponchos; girdles; belts [clothing]; money belts [clothing]; layettes [clothing]; non-slipping devices for footwear; heelpieces for stockings; welts for footwear; chausables; shirts; wooden shoes; sandals; bath sandals; boots; sarongs; jumper dresses; saris; sweaters; footwear uppers; inner soles; albs; bath slippers; knitwear [clothing]; togas; underpants; gymnastic shoes; slippers; shoes; skull caps; turbans; headgear for wear; aprons [clothing]; tee-shirts; dressing gowns; bath robes; top hats; tips for footwear; stockings; sweat-absorbent stockings; shawls; paper hats [clothing]; caps [headwear]; shower caps; bathing caps; sashes for wear; studs for football boots; hats; babies' pants [clothing]; trouser straps; pelisses; esparto shoes or sandals; skirts; petticoats; skorts.

(260) AM 2016 84141 A

(800) 826445

(891) 2015 06 24

(731) DYNA, s.r.o.

Aleksince 231, SK-951 22 Aleksince,
Slovakia

(540)

DYNAMAX

(591) Black, white

(511)

1 – Industrial chemicals; fat-bleaching chemicals; chemical additives for motor fuel and oils; antifreeze; refrigerants (compounds); brake fluids.

3 – Chemical products for the cleaning of automobiles.

4 – Motor fuels; non-chemical additives to motor fuel; lubricants; combustible oils (fuel oil).

35 – Commercial business intermediary services in connection with the goods mentioned in classes 1, 3 and 4.

(260) AM 2016 84144 A

(800) 1037888

(891) 2015 09 10

(731) Societe Nationale d'Exploitation Industrielle des Tabacs et Allumettes, SASU
143 boulevard Romain Rolland, F-75014
Paris, France

(540)

GAULOISES

(511)

34 – Tobacco whether manufactured or unmanufactured; cigarettes; cigars; tobacco products; tobacco substitutes, none being for medicinal or curative purposes; matches and smokers' articles.

(260) AM 2016 84181 A

(800) 1267256

(891) 2015 06 26

(731) KYUNG DONG NAVIEN CO., LTD.

95, Suworam-gil, Seotan-myeon, Pyeongtaek-si Gyeonggi-do, Republic of Korea

(540)

Navien

(591) Black, white

(511)

11 – Water heaters; hot-water heating apparatus; apparatus for space heating; steam heating equipment; gas boilers; gas stoves; boilers for household purposes; hearths; dampers for heating; warming pans; radiator caps; radiators; petroleum stoves; instantaneous water heaters; hot air furnaces; fire pots; sinks; kitchen worktops; gas scrubbing apparatus; air purifying apparatus and machines; circulators for boiler; air conditioners; air purifiers.

(260) AM 2016 84186 A

(800) 1267332

(891) 2015 05 28

(731) FRUIT SHIPPERS LIMITED, A FOREIGN COMPANY UNDER BAHAMAS LAW
Zeevaartstraat 3, B-2000 Antwerpen, Belgium

(540)

BONITA

(511)

30 – Cocoa and preparations having a base of cocoa, chocolate, chocolate products, confectionery, sweets; sugar; natural sweeteners; bakery products, bread, yeast, pastries; biscuits, cakes, desserts of vegetable origin and other desserts based on cereals (ce-

reals predominating); pasta, baking-powder, flour, spices, and flavourings; puddings; edible ices, products for making edible ices; honey and honey substitutes; breakfast cereals, rice, pasta, food products based on rice, flour or cereals, also in the form of cooked dishes; fruit sauces; coffee; coffee extracts and coffee-based preparations; coffee substitutes and extracts of coffee substitutes; coffee beans; unroasted coffee; ground coffee; decaffeinated coffee; instant coffee; coffee drinks; coffee beverages; coffee mixtures; flavoured coffee; roasted coffee beans; ground coffee beans; prepared coffee and coffee-based beverages; coffee based drinks; coffee in brewed form; coffee in ground form; coffee beverages with milk; ice beverages with a coffee base; filters in the form of paper bags filled with coffee; tea, tea extracts and tea-based preparations.

(260) AM 2016 84187 A
 (800) 1267350
 (891) 2015 06 16
 (731) KRKA, tovarna zdravil, d.d., Novo mesto
 Šmarješka cesta 6, SI-8000 Novo mesto,
 Slovenia

(540)
LEBAKCEJA

(511)
 5 – Pharmaceutical preparations.

(260) AM 2016 84351 A
 (800) 1268590
 (891) 2015 05 06
 (731) TORUŃSKIE ZAKŁADY MATERIAŁÓW
 OPATRUNKOWYCH, SPÓŁKA AKCYJNA
 Żółkiewskiego 20/26, PL-87-100 Toruń,
 Poland



(591) Dark navy blue, orange, white, gray and green
 (511)
 5 – Adhesive tape for medical use.

(260) AM 2016 84356 A
 (800) 1269374
 (891) 2015 08 05
 (731) APPLE INC.
 1 Infinite Loop, Cupertino CA 95014, USA



(591) Black, white
 (526) MUSIC
 (511)
 9 – Computer software; computer software for use in playing, organizing, downloading, transmitting, manipulating, and reviewing audio files, and media files; computer software for use in the delivery, distribution and transmission of digital music and entertainment-related audio, video, text and multimedia content; computer software for creating searchable databases of information and data for peer-to-peer social networking databases; computer software to enable users to program and distribute audio, video, data, text and other multimedia content, including music, concerts, videos, radio, television, cultural events, and entertainment-related and educational programs via communication networks; computer software for accessing, browsing and searching on-line databases; computer software for setting up, configuring, operating and controlling mobile devices, wearable devices, mobile phones, computers, and computer peripherals, and audio and video players; downloadable audio and video recordings featuring music, music performances, and music videos; downloadable electronic books, magazines, periodicals, newsletters, newspapers, journals and other publications.

(260) AM 2016 84365 A
 (800) 1268596
 (891) 2015 06 05
 (731) WEWORK COMPANIES INC.
 222 Broadway, New York NY 10038,
 USA

(540)
WELIVE

(511)
 9 – Software and downloadable software for making restaurant reservations, placing orders for delivery of food to residences, and for organizing parties and events; software and downloadable software for signing up for classes at fitness and health clubs and exercise facilities and for making appointments for treatments at health spas; computer application software for mobile phones and handheld computers, namely, software for members of a residential community to participate in social networking, engage in virtual communities, manage their community membership, make rent payments, and sign up for and manage use of amenities such as library, media room, theater, gym, concierge, restaurants, cafes, kitchen.

36 – Leasing of real property and apartments; management of apartments and buildings.

41 – Health club services, namely, providing instruction and equipment in the field of physical exercise; providing fitness and exercise facilities; conducting fitness classes; providing swimming pools; libraries; entertainment services, namely, conducting parties for the purpose of dating and social introduction for adults; movie theaters; providing media room facilities.

43 – Providing temporary accommodations; providing temporary housing accommodations; hotel services; online booking and reservation services for temporary lodging; coffee bar services; providing community centers for social gatherings and meetings; rental of social function facilities for business and social events, namely, conferences, seminars, receptions, and parties; providing day care services; pet day care services; café and restaurant services; cafeteria services; catering services; providing of food and drink; providing conference, exhibition and meeting facilities.

45 – Concierge services for others comprising making requested personal arrangements and reservations and providing customer-specific information to meet individual needs rendered together in an apartment complex; online social networking services; personal concierge services for others comprising making requested personal arrangements and reservations, running errands and providing customer specific information to meet individual needs, all rendered in residential complexes.

(260) AM 2016 84368 A
(800) 1196250
(891) 2015 09 23
(731) BUSCEMI LLC
1545 Wilcox Ave, Ste. 202 Los Angeles CA
90028, US

(540)

Buscemi

(591) Black, white

(511)

25 – Footwear.

(260) AM 2016 84376 A
(800) 1268609
(891) 2015 05 07
(731) MAGIC PRODUCTION GROUP (M.P.G.)
SA
Findel Business Center, Complexe B,
Rue de Trèves, L-2632 FINDEL, Luxembourg

(540)

YOUNERGIK

(511)

28 – Games, toys; gymnastic and sporting articles not included in other classes; decorations for Christmas trees; building games, card games, games of skill, board games, action toys, construction toys; models [toys], scale model vehicles [toys]; jigsaw puzzles.

30 – Pastry and confectionery; ices for food; chocolate and chocolate-based products, cocoa and cocoa-based products.

41 – Education; providing of training; entertainment; sporting and cultural activities; entertainment provided via a global communication network, entertainment by means of radio, television and the Internet, provision of online non-downloadable comic books and graphic novels; interactive entertainment services; organization of competitions (education or entertainment); organization of entertainment events.

(260) AM 2016 84382 A
(800) 1269089
(891) 2015 08 05
(731) APPLE INC.
1 Infinite Loop, Cupertino CA 95014, USA

(540)



(591) Black

(526) MUSIC

(511)

38 – Broadcasting and transmission of voice, data, images, music, audio, video, multimedia, television, and radio by means of telecommunications networks; broadcast and transmission of streamed music, audio, video, and multimedia content by means of telecommunications networks; matching users for the transfer of music, audio, video, and multimedia by means of telecommunications networks; providing access to websites, databases, electronic bulletin boards, on-line forums, directories, music, and video and audio programs.

(260) AM 2016 84383 A
(800) 1269156
(891) 2015 03 19
(731) ALBRECHT JUNG GMBH & CO. KG
Volmestr. 1,58579 Schalksmühle,
Germany

(540)



(591) Black

(511)

9 – Electric connectors, in particular electric connection devices, couplings, adapters, electric sockets, plugs, terminals for electric cables; branch boxes (electricity); junction boxes (electricity); antennas; switchboards; alarms and alarm systems; indicators (electric/electronic); covering plates for covering of electro-technical and electronic apparatus for home and building technology; limiters (electricity); computer programs, recorded; computer software (recorded); inductor coils; anti-interference devices (electricity); remote control devices; fire alarms; electric/electronic equipment/apparatus, for house and building technology, connected using wireless and/or cable technology, in particular via an installation bus system, and for transmitting commands to modulate regulating, control, checking (supervision), measuring, transmission and recording equipment/apparatus; interfaces, in particular for home automation and building technology; couplers (data processing equipment); optical lamps; light emitting diodes (LEDs); light regulators, light signalling apparatus, in particular dimmers; photometers; regulating, control, checking (supervision), measuring, monitoring, switching and recording equipment/apparatus, in particular for home automation and building technology; electric/electronic switches, in particular installation switches, built-in switches for equipment, toggle switches, rocker switches, rotary switches, press-button switches, touch contacts, pull switches, slide switches and multiple circuit breakers; control consoles and panels (electricity); transmitters of electric and electronic signals; smart cards [integrated circuit cards]; battery chargers; coils (electric and electromagnetic); control panels (electricity); remote controls; rectifiers; converters, electric; current relays, in particular for lighting devices; sensors for detecting movements (movement indicators), sounds, brightness, gases, smoke, temperature and other physical variables for home automation and building technology, in particular for the control of lighting, room and building surveillance; electric/electronic transformers (combinational circuit parts); distribution boxes and boards (electricity); time switch apparatus, in particular for controlling electric equipment, lighting devices, blinds, roller blinds.

11 – Lighting apparatus and installations; lighting apparatus utilizing light emitting diodes (LEDs); lamps (electric and electronic); light diffusers; protective casings for lighting.

37 – Installation, maintenance and repair of electric apparatus (servicing).

(260) AM 2016 84386 A

(800) 1269201

(891) 2015 05 05

(731) İDATA INTERNATIONAL VİZE
HİZMETLERİ DIŞ TİCARET A.Ş.
Cumhuriyet Cad. No: 123 Giriş Kat, Harbiye
Şişli, İSTANBUL, Turkey

(540)

visametric

(591) Black

(511)

39 – Land, water and air transport services; rental of land, water or air vehicles; arranging of travel tours; travel reservation; issuing of tickets for travel; courier services (messages of merchandise); arranging for travel visas passports and travel documents for persons traveling abroad.

(260) AM 2016 84514 A

(800) 1270676

(891) 2015 09 23

(731) BUSCEMI LLC

528 N San Vicente Blvd., West Hollywood
CA 90048, USA

(540)

Buscemi

(591) black and white

(511)

18 – Leather bags, suitcases and wallets; Tote bags.

INTERNATIONAL TRADEMARKS PROTECTED IN GEORGIA

(260) AM 2015 78886 A
(800) 1216700
(151) 2014 07 21
(181) 2024 07 21
(891) 2014 07 21
(511) 33

(260) AM 2016 81146 A
(800) 1237347
(151) 2014 09 08
(181) 2024 09 08
(891) 2014 09 08
(511) 09

(260) AM 2015 78932 A
(800) 1216913
(151) 2014 07 07
(181) 2024 07 07
(891) 2014 07 07
(511) 33

(260) AM 2016 81174 A
(800) 1237700
(151) 2014 10 16
(181) 2024 10 16
(891) 2014 10 16
(511) 09

(260) AM 2015 78940 A
(800) 1217052
(151) 2014 07 07
(181) 2024 07 07
(891) 2014 07 07
(511) 33

(260) AM 2016 81634 A
(800) 1240739
(151) 2014 10 31
(181) 2024 10 31
(891) 2014 10 31
(511) 09

(260) AM 2016 79102 A
(800) 1218425
(151) 2014 07 07
(181) 2024 07 07
(891) 2014 07 07
(511) 30

(260) AM 2016 81658 A
(800) 1240957
(151) 2015 01 16
(181) 2025 01 16
(891) 2015 01 16
(511) 08

(260) AM 2016 79377 A
(800) 1220851
(151) 2014 07 03
(181) 2024 07 03
(891) 2014 07 03
(511) 04, 05

(260) AM 2016 81812 A
(800) 1242727
(151) 2014 12 30
(181) 2024 12 30
(891) 2014 12 30
(511) 09

(260) AM 2016 79799 A
(800) 1224232
(151) 2014 04 22
(181) 2024 04 22
(891) 2014 04 22
(511) 35, 36, 42

(260) AM 2016 81842 A
(800) 1178711
(151) 2013 09 04
(181) 2023 09 04
(891) 2015 04 20
(511) 30, 32, 43

(260) AM 2016 81062 A
(800) 1236428
(151) 2014 12 31
(181) 2024 12 31
(891) 2014 12 31
(511) 29

(260) AM 2016 81850 A
(800) 1242954
(151) 2014 09 26
(181) 2024 09 26
(891) 2014 09 26
(511) 03

(260) AM 2016 81852 A
(800) 1243047
(151) 2014 11 05
(181) 2024 11 05
(891) 2014 11 05
(511) 35, 36, 41, 42

(260) AM 2016 81962 A
(800) 1244061
(151) 2015 02 06
(181) 2025 02 06
(891) 2015 02 06
(511) 01, 04

(260) AM 2016 82035 A
(800) 1245822
(151) 2015 02 26
(181) 2025 02 26
(891) 2015 02 26
(511) 29, 30, 31

(260) AM 2016 82036 A
(800) 1245829
(151) 2015 02 24
(181) 2025 02 24
(891) 2015 02 24
(511) 30

(260) AM 2016 82037 A
(800) 1245868
(151) 2014 12 30
(181) 2024 12 30
(891) 2014 12 30
(511) 11, 14

(260) AM 2016 82038 A
(800) 1245000
(151) 2015 03 11
(181) 2025 03 11
(891) 2015 03 11
(511) 09

(260) AM 2016 82039 A
(800) 1245002
(151) 2015 03 02
(181) 2025 03 02
(891) 2015 03 02
(511) 03, 05

(260) AM 2016 82040 A
(800) 1245034
(151) 2014 08 18

(181) 2024 08 18
(891) 2014 08 18
(511) 29, 30, 31, 35

(260) AM 2016 82041 A
(800) 1245040
(151) 2014 10 21
(181) 2024 10 21
(891) 2014 10 21
(511) 19

(260) AM 2016 82043 A
(800) 1245093
(151) 2015 01 05
(181) 2025 01 05
(891) 2015 01 05
(511) 43

(260) AM 2016 82044 A
(800) 1245100
(151) 2014 11 26
(181) 2024 11 26
(891) 2014 11 26
(511) 05

(260) AM 2016 82045 A
(800) 1245101
(151) 2014 11 26
(181) 2024 11 26
(891) 2014 11 26
(511) 05

(260) AM 2016 82046 A
(800) 1245102
(151) 2014 11 26
(181) 2024 11 26
(891) 2014 11 26
(511) 05

(260) AM 2016 82048 A
(800) 1245176
(151) 2015 03 30
(181) 2025 03 30
(891) 2015 03 30
(511) 01, 16, 21

(260) AM 2016 82050 A
(800) 1245186
(151) 2014 11 20
(181) 2024 11 20
(891) 2014 11 20
(511) 05

(260) AM 2016 82051 A
(800) 1245208
(151) 2015 03 06
(181) 2025 03 06
(891) 2015 03 06
(511) 31

(260) AM 2016 82053 A
(800) 1245240
(151) 2015 02 13
(181) 2025 02 13
(891) 2015 02 13
(511) 29, 30, 31

(260) AM 2016 82054 A
(800) 1245242
(151) 2015 02 12
(181) 2025 02 12
(891) 2015 02 12
(511) 20

(260) AM 2016 82055 A
(800) 1245301
(151) 2014 11 26
(181) 2024 11 26
(891) 2014 11 26
(511) 05

(260) AM 2016 82058 A
(800) 1245318
(151) 2015 02 10
(181) 2025 02 10
(891) 2015 02 10
(511) 29, 30, 31, 32

(260) AM 2016 82059 A
(800) 1245321
(151) 2015 01 13
(181) 2025 01 13
(891) 2015 01 13
(511) 33

(260) AM 2016 82065 A
(800) 1245917
(151) 2014 11 14
(181) 2024 11 14
(891) 2014 11 14
(511) 03

(260) AM 2016 82066 A
(800) 1245958
(151) 2015 01 07

(181) 2025 01 07
(891) 2015 01 07
(511) 35, 38, 42

(260) AM 2016 82067 A
(800) 1245999
(151) 2015 03 05
(181) 2025 03 05
(891) 2015 03 05
(511) 03

(260) AM 2016 82068 A
(800) 1246017
(151) 2015 04 10
(181) 2025 04 10
(891) 2015 04 10
(511) 03

(260) AM 2016 82069 A
(800) 731318
(151) 2000 01 27
(181) 2020 01 27
(891) 2015 03 16
(511) 01

(260) AM 2016 82070 A
(800) 841840
(151) 2004 08 03
(181) 2024 08 03
(891) 2015 02 18
(511) 03

(260) AM 2016 82071 A
(800) 856671
(151) 2005 07 13
(181) 2025 07 13
(891) 2015 04 02
(511) 03

(260) AM 2016 82072 A
(800) 1126553
(151) 2012 07 18
(181) 2022 07 18
(891) 2015 02 03
(511) 10

(260) AM 2016 82073 A
(800) 1128714
(151) 2012 08 01
(181) 2022 08 01
(891) 2015 03 23
(511) 32

(260) AM 2016 82074 A
(800) 1140060
(151) 2012 08 20
(181) 2022 08 20
(891) 2015 03 04
(511) 06, 07, 08, 11, 17, 19, 20

(260) AM 2016 82075 A
(800) 1144740
(151) 2012 12 04
(181) 2022 12 04
(891) 2015 02 03
(511) 05

(260) AM 2016 82076 A
(800) 1154439
(151) 2013 02 05
(181) 2023 02 05
(891) 2015 02 03
(511) 05

(260) AM 2016 82077 A
(800) 1175868
(151) 2013 09 02
(181) 2023 09 02
(891) 2015 02 06
(511) 05

(260) AM 2016 82078 A
(800) 1234621
(151) 2014 09 17
(181) 2024 09 17
(891) 2015 05 11
(511) 33

(260) AM 2016 82080 A
(800) 1245332
(151) 2015 02 06
(181) 2025 02 06
(891) 2015 02 06
(511) 01, 02, 03, 04, 35, 42

(260) AM 2016 82082 A
(800) 1245334
(151) 2015 02 18
(181) 2025 02 18
(891) 2015 02 18
(511) 11

(260) AM 2016 82083 A
(800) 1245335
(151) 2015 02 20

(181) 2025 02 20
(891) 2015 02 20
(511) 30

(260) AM 2016 82084 A
(800) 1245357
(151) 2015 03 12
(181) 2025 03 12
(891) 2015 03 12
(511) 29, 30

(260) AM 2016 82086 A
(800) 1245392
(151) 2015 02 12
(181) 2025 02 12
(891) 2015 02 12
(511) 30, 35

(260) AM 2016 82089 A
(800) 1245440
(151) 2014 10 08
(181) 2024 10 08
(891) 2014 10 08
(511) 30

(260) AM 2016 82091 A
(800) 1245584
(151) 2015 02 10
(181) 2025 02 10
(891) 2015 02 10
(511) 30, 43

(260) AM 2016 82092 A
(800) 1245592
(151) 2014 12 19
(181) 2024 12 19
(891) 2014 12 19
(511) 30

(260) AM 2016 82094 A
(800) 1245661
(151) 2014 10 20
(181) 2024 10 20
(891) 2014 10 20
(511) 30

(260) AM 2016 82095 A
(800) 1245662
(151) 2014 10 20
(181) 2024 10 20
(891) 2014 10 20
(511) 30

(260) AM 2016 82096 A
(800) 1245667
(151) 2014 07 28
(181) 2024 07 28
(891) 2014 07 28
(511) 7, 8, 9, 11, 20, 21, 28, 35, 36, 37, 39, 41, 42

(260) AM 2016 82097 A
(800) 1245681
(151) 2014 11 14
(181) 2024 11 14
(891) 2014 11 14
(511) 01, 05, 31, 44

(260) AM 2016 82098 A
(800) 1245682
(151) 2014 11 14
(181) 2024 11 14
(891) 2014 11 14
(511) 01, 05, 31, 44

(260) AM 2016 82099 A
(800) 1245683
(151) 2014 11 14
(181) 2024 11 14
(891) 2014 11 14
(511) 01, 05, 31, 44

(260) AM 2016 82100 A
(800) 1245693
(151) 2014 12 02
(181) 2024 12 02
(891) 2014 12 02
(511) 42

(260) AM 2016 82101 A
(800) 1245726
(151) 2014 12 25
(181) 2024 12 25
(891) 2014 12 25
(511) 07

(260) AM 2016 82102 A
(800) 1245762
(151) 2014 11 26
(181) 2024 11 26
(891) 2014 11 26
(511) 05

(260) AM 2016 82103 A
(800) 1245763
(151) 2014 11 26

(181) 2024 11 26
(891) 2014 11 26
(511) 05

(260) AM 2016 82104 A
(800) 1245764
(151) 2014 11 26
(181) 2024 11 26
(891) 2014 11 26
(511) 05

(260) AM 2016 82105 A
(800) 1245765
(151) 2014 11 26
(181) 2024 11 26
(891) 2014 11 26
(511) 05

(260) AM 2016 82106 A
(800) 1245780
(151) 2015 02 09
(181) 2025 02 09
(891) 2015 02 09
(511) 05

(260) AM 2016 82107 A
(800) 1245782
(151) 2014 12 15
(181) 2024 12 15
(891) 2014 12 15
(511) 03

(260) AM 2016 82108 A
(800) 1245819
(151) 2015 02 13
(181) 2025 02 13
(891) 2015 02 13
(511) 08, 09, 11, 12, 21

(260) AM 2016 82114 A
(800) 1245482
(151) 2014 11 25
(181) 2024 11 25
(891) 2014 11 25
(511) 33, 34

(260) AM 2016 82117 A
(800) 1245521
(151) 2015 02 04
(181) 2025 02 04
(891) 2015 02 04
(511) 16, 36, 39

(260) AM 2016 82119 A
(800) 1245525
(151) 2015 03 16
(181) 2025 03 16
(891) 2015 03 16
(511) 03, 05, 16, 29, 30, 35

(260) AM 2016 82130 A
(800) 1246848
(151) 2014 12 24
(181) 2024 12 24
(891) 2014 12 24
(511) 01, 03, 04, 07, 12

(260) AM 2016 82139 A
(800) 1246062
(151) 2015 02 02
(181) 2025 02 02
(891) 2015 02 02
(511) 30

(260) AM 2016 82152 A
(800) 1246941
(151) 2015 02 27
(181) 2025 02 27
(891) 2015 02 27
(511) 33

(260) AM 2016 82154 A
(800) 1246942
(151) 2015 04 01
(181) 2025 04 01
(891) 2015 04 01
(511) 28

(260) AM 2016 82176 A
(800) 1246410
(151) 2014 03 31
(181) 2024 03 31
(891) 2014 03 31
(511) 05

(260) AM 2016 82178 A
(800) 1246426
(151) 2014 11 24
(181) 2024 11 24
(891) 2014 11 24
(511) 03

(260) AM 2016 82180 A
(800) 1246468
(151) 2015 03 18

(181) 2025 03 18
(891) 2015 03 18
(511) 25

(260) AM 2016 82182 A
(800) 1246492
(151) 2015 03 24
(181) 2025 03 24
(891) 2015 03 24
(511) 03, 05

(260) AM 2016 82183 A
(800) 1246518
(151) 2014 11 05
(181) 2024 11 05
(891) 2014 11 05
(511) 35, 42, 45

(260) AM 2016 82184 A
(800) 815866
(151) 2003 12 18
(181) 2023 12 18
(891) 2015 03 06
(511) 05, 29

(260) AM 2016 82185 A
(800) 883157
(151) 2006 02 22
(181) 2026 02 22
(891) 2015 04 27
(511) 05

(260) AM 2016 82186 A
(800) 931322
(151) 2007 07 10
(181) 2017 07 10
(891) 2015 04 03
(511) 41

(260) AM 2016 82187 A
(800) 1002151
(151) 2009 01 29
(181) 2019 01 29
(891) 2015 02 05
(511) 02

(260) AM 2016 82188 A
(800) 1017339
(151) 2009 08 31
(181) 2019 08 31
(891) 2015 02 18
(511) 03

(260) AM 2016 82189 A
(800) 1032843
(151) 2010 01 07
(181) 2020 01 07
(891) 2015 03 20
(511) 12, 19, 21

(260) AM 2016 82190 A
(800) 1068486
(151) 2010 12 07
(181) 2020 12 07
(891) 2015 03 26
(511) 05, 09, 10

(260) AM 2016 82191 A
(800) 1130917
(151) 2012 07 13
(181) 2022 07 13
(891) 2015 03 16
(511) 33

(260) AM 2016 82192 A
(800) 1246530
(151) 2014 06 10
(181) 2024 06 10
(891) 2014 06 10
(511) 09, 35, 39, 43

(260) AM 2016 82193 A
(800) 1130918
(151) 2012 07 13
(181) 2022 07 13
(891) 2015 03 16
(511) 33

(260) AM 2016 82194 A
(800) 1186735
(151) 2013 11 14
(181) 2023 11 14
(891) 2015 03 05
(511) 33

(260) AM 2016 82195 A
(800) 1210135
(151) 2013 10 10
(181) 2023 10 10
(891) 2015 04 23
(511) 09

(260) AM 2016 82196 A
(800) 1246532
(151) 2014 12 23

(181) 2024 12 23
(891) 2014 12 23
(511) 09, 14, 15, 16, 18, 25, 32, 33, 35, 38, 39, 41, 43

(260) AM 2016 82198 A
(800) 1246579
(151) 2014 08 11
(181) 2024 08 11
(891) 2014 08 11
(511) 05

(260) AM 2016 82199 A
(800) 1246638
(151) 2014 11 19
(181) 2024 11 19
(891) 2014 11 19
(511) 07

(260) AM 2016 82200 A
(800) 1246668
(151) 2014 11 13
(181) 2024 11 13
(891) 2014 11 13
(511) 09, 25, 41, 42

(260) AM 2016 82206 A
(800) 1239790
(151) 2014 11 21
(181) 2024 11 21
(891) 2015 03 20
(511) 12

(260) AM 2016 82267 A
(800) 1247038
(151) 2014 10 15
(181) 2024 10 15
(891) 2014 10 15
(511) 09, 42, 45

(260) AM 2016 82268 A
(800) 1247085
(151) 2015 03 30
(181) 2025 03 30
(891) 2015 03 30
(511) 28

(260) AM 2016 82273 A
(800) 1247502
(151) 2014 12 17
(181) 2024 12 17
(891) 2014 12 17
(511) 36

(260) AM 2016 82275 A
(800) 1247510
(151) 2014 12 19
(181) 2024 12 19
(891) 2014 12 19
(511) 09

(260) AM 2016 82284 A
(800) 1247602
(151) 2015 02 03
(181) 2025 02 03
(891) 2015 02 03
(511) 06, 07, 09, 11

(260) AM 2016 82285 A
(800) 1247606
(151) 2015 03 02
(181) 2025 03 02
(891) 2015 03 02
(511) 03, 16, 21

(260) AM 2016 82286 A
(800) 1247350
(151) 2015 01 21
(181) 2025 01 21
(891) 2015 01 21
(511) 03, 04, 05, 16, 20, 29, 30, 31, 35

(260) AM 2016 82291 A
(800) 1247637
(151) 2015 03 30
(181) 2025 03 30
(891) 2015 03 30
(511) 09

(260) AM 2016 82292 A
(800) 1247401
(151) 2014 07 14
(181) 2024 07 14
(891) 2014 07 14
(511) 07

(260) AM 2016 82293 A
(800) 1247704
(151) 2015 04 17
(181) 2025 04 17
(891) 2015 04 17
(511) 05

(260) AM 2016 82294 A
(800) 1247705
(151) 2015 04 17

(181) 2025 04 17
(891) 2015 04 17
(511) 05

(260) AM 2016 82295 A
(800) 1247403
(151) 2014 06 18
(181) 2024 06 18
(891) 2014 06 18
(511) 07, 09, 11, 12, 16, 28, 35, 36, 37, 38, 39, 40,
41, 42, 45

(260) AM 2016 82296 A
(800) 1247752
(151) 2015 03 13
(181) 2025 03 13
(891) 2015 03 13
(511) 03

(260) AM 2016 82297 A
(800) 1247706
(151) 2015 04 17
(181) 2025 04 17
(891) 2015 04 17
(511) 05

(260) AM 2016 82298 A
(800) 1247778
(151) 2015 03 27
(181) 2025 03 27
(891) 2015 03 27
(511) 30

(260) AM 2016 82299 A
(800) 1247707
(151) 2015 04 17
(181) 2025 04 17
(891) 2015 04 17
(511) 05

(260) AM 2016 82303 A
(800) 1247430
(151) 2014 10 25
(181) 2024 10 25
(891) 2014 10 25
(511) 01, 03, 05, 10, 16, 42

(260) AM 2016 82306 A
(800) 1247721
(151) 2015 03 19
(181) 2025 03 19
(891) 2015 03 19
(511) 36

(260) AM 2016 82307 A
(800) 1247722
(151) 2015 02 02
(181) 2025 02 02
(891) 2015 02 02
(511) 03

(260) AM 2016 82308 A
(800) 1247742
(151) 2015 01 27
(181) 2025 01 27
(891) 2015 01 27
(511) 19, 20

(260) AM 2016 82310 A
(800) 1095521
(151) 2010 11 19
(181) 2020 11 19
(891) 2015 03 02
(511) 16, 20, 24, 42

(260) AM 2016 82311 A
(800) 1100330
(151) 2011 10 26
(181) 2021 10 26
(891) 2015 04 30
(511) 03

(260) AM 2016 82317 A
(800) 1100935
(151) 2011 07 26
(181) 2021 07 26
(891) 2015 03 18
(511) 09

(260) AM 2016 82318 A
(800) 1102238
(151) 2011 11 09
(181) 2021 11 09
(891) 2015 03 09
(511) 11, 20, 21

(260) AM 2016 82319 A
(800) 1107838
(151) 2012 01 26
(181) 2022 01 26
(891) 2015 04 30
(511) 33

(260) AM 2016 82320 A
(800) 1247825
(151) 2014 12 17

(181) 2024 12 17
(891) 2014 12 17
(511) 09

(260) AM 2016 82321 A
(800) 1247831
(151) 2014 12 01
(181) 2024 12 01
(891) 2014 12 01
(511) 19

(260) AM 2016 82325 A
(800) 1247889
(151) 2015 02 17
(181) 2025 02 17
(891) 2015 02 17
(511) 01, 04, 41

(260) AM 2016 82326 A
(800) 1247890
(151) 2015 04 01
(181) 2025 04 01
(891) 2015 04 01
(511) 28

(260) AM 2016 82327 A
(800) 1247891
(151) 2015 04 01
(181) 2025 04 01
(891) 2015 04 01
(511) 28

(260) AM 2016 82328 A
(800) 1247899
(151) 2015 04 01
(181) 2025 04 01
(891) 2015 04 01
(511) 28

(260) AM 2016 82329 A
(800) 1247900
(151) 2015 04 01
(181) 2025 04 01
(891) 2015 04 01
(511) 28

(260) AM 2016 82330 A
(800) 1247901
(151) 2015 04 01
(181) 2025 04 01
(891) 2015 04 01
(511) 28

(260) AM 2016 82331 A
(800) 1247902
(151) 2015 04 01
(181) 2025 04 01
(891) 2015 04 01
(511) 28

(260) AM 2016 82332 A
(800) 1247903
(151) 2015 04 01
(181) 2025 04 01
(891) 2015 04 01
(511) 28

(260) AM 2016 82333 A
(800) 1247904
(151) 2015 04 01
(181) 2025 04 01
(891) 2015 04 01
(511) 28

(260) AM 2016 82334 A
(800) 369411
(151) 1970 06 20
(181) 2020 06 20
(891) 2015 02 12
(511) 05

(260) AM 2016 82335 A
(800) 1131832
(151) 2012 09 17
(181) 2022 09 17
(891) 2015 04 30
(511) 33

(260) AM 2016 82337 A
(800) 1189390
(151) 2013 10 01
(181) 2023 10 01
(891) 2015 03 12
(511) 29, 30, 43

(260) AM 2016 82338 A
(800) 1163209
(151) 2013 04 22
(181) 2023 04 22
(891) 2015 03 13
(511) 35, 39

(260) AM 2016 82340 A
(800) 1217689
(151) 2014 04 10
(181) 2024 04 10

(891) 2015 03 09
(511) 14, 35

(260) AM 2016 82368 A
(800) 1248258
(151) 2015 02 19
(181) 2025 02 19
(891) 2015 02 19
(511) 21, 32, 33

(260) AM 2016 82372 A
(800) 1248743
(151) 2015 04 17
(181) 2025 04 17
(891) 2015 04 17
(511) 05

(260) AM 2016 82373 A
(800) 1248306
(151) 2015 02 24
(181) 2025 02 24
(891) 2015 02 24
(511) 05

(260) AM 2016 82374 A
(800) 1248333
(151) 2014 11 13
(181) 2024 11 13
(891) 2014 11 13
(511) 05

(260) AM 2016 82375 A
(800) 1248338
(151) 2015 04 09
(181) 2025 04 09
(891) 2015 04 09
(511) 33

(260) AM 2016 82376 A
(800) 1248341
(151) 2014 12 24
(181) 2024 12 24
(891) 2014 12 24
(511) 05

(260) AM 2016 82378 A
(800) 1248355
(151) 2015 03 17
(181) 2025 03 17
(891) 2015 03 17
(511) 05

(260) AM 2016 82380 A
(800) 1248760
(151) 2015 04 28
(181) 2025 04 28
(891) 2015 04 28
(511) 01, 29

(260) AM 2016 82381 A
(800) 1248764
(151) 2015 04 27
(181) 2025 04 27
(891) 2015 04 27
(511) 05

(260) AM 2016 82383 A
(800) 1248774
(151) 2015 01 31
(181) 2025 01 31
(891) 2015 01 31
(511) 30

(260) AM 2016 82384 A
(800) 1248782
(151) 2014 07 10
(181) 2024 07 10
(891) 2014 07 10
(511) 07

(260) AM 2016 82385 A
(800) 1248801
(151) 2015 02 17
(181) 2025 02 17
(891) 2015 02 17
(511) 06, 09

(260) AM 2016 82386 A
(800) 1248818
(151) 2014 10 31
(181) 2024 10 31
(891) 2014 10 31
(511) 25, 35

(260) AM 2016 82389 A
(800) 1248835
(151) 2015 03 25
(181) 2025 03 25
(891) 2015 03 25
(511) 25, 35

(260) AM 2016 82395 A
(800) 1248912
(151) 2014 10 27
(181) 2024 10 27
(891) 2014 10 27
(511) 33, 35

(260) AM 2016 82396 A
(800) 1248929
(151) 2015 01 13
(181) 2025 01 13
(891) 2015 01 13
(511) 35, 36

(260) AM 2016 82397 A
(800) 877297
(151) 2006 02 08
(181) 2026 02 08
(891) 2015 04 28
(511) 33

(260) AM 2016 82399 A
(800) 907499
(151) 2006 10 09
(181) 2026 10 09
(891) 2015 03 31
(511) 43

(260) AM 2016 82400 A
(800) 1039957
(151) 2010 01 27
(181) 2020 01 27
(891) 2015 03 31
(511) 43

(260) AM 2016 82401 A
(800) 1061175
(151) 2010 11 16
(181) 2020 11 16
(891) 2015 01 16
(511) 03

(260) AM 2016 82402 A
(800) 1061957
(151) 2010 09 23
(181) 2020 09 23
(891) 2015 02 25
(511) 35, 43

(260) AM 2016 82403 A
(800) 1100907
(151) 2011 09 01

(181) 2021 09 01
(891) 2015 04 01
(511) 25, 35

(260) AM 2016 82406 A
(800) 1194719
(151) 2013 08 28
(181) 2023 08 28
(891) 2015 03 31
(511) 43

(260) AM 2016 82407 A
(800) 1203233
(151) 2014 04 02
(181) 2024 04 02
(891) 2015 02 23
(511) 07, 12

(260) AM 2016 82410 A
(800) 1227613
(151) 2014 11 11
(181) 2024 11 11
(891) 2015 03 05
(511) 05

(260) AM 2016 82411 A
(800) 1205604
(151) 2014 04 02
(181) 2024 04 02
(891) 2015 02 23
(511) 07, 12

(260) AM 2016 82412 A
(800) 1245696
(151) 2014 12 05
(181) 2024 12 05
(891) 2015 04 27
(511) 03, 05, 10

(260) AM 2016 82414 A
(800) 1248356
(151) 2014 12 29
(181) 2024 12 29
(891) 2014 12 29
(511) 09, 28, 35, 38, 41, 42

(260) AM 2016 82418 A
(800) 1248448
(151) 2015 04 01
(181) 2025 04 01

(891) 2015 04 01
(511) 28

(260) AM 2016 82420 A
(800) 1248478
(151) 2015 04 08
(181) 2025 04 08
(891) 2015 04 08
(511) 30, 32, 35, 43

(260) AM 2016 82421 A
(800) 1248503
(151) 2015 03 26
(181) 2025 03 26
(891) 2015 03 26
(511) 03, 35

(260) AM 2016 82422 A
(800) 1248504
(151) 2015 04 10
(181) 2025 04 10
(891) 2015 04 10
(511) 33

(260) AM 2016 82423 A
(800) 1248506
(151) 2015 02 24
(181) 2025 02 24
(891) 2015 02 24
(511) 30

(260) AM 2016 82424 A
(800) 1248562
(151) 2015 04 22
(181) 2025 04 22
(891) 2015 04 22
(511) 05

(260) AM 2016 82425 A
(800) 1248574
(151) 2015 04 22
(181) 2025 04 22
(891) 2015 04 22
(511) 05

(260) AM 2016 82426 A
(800) 1248598
(151) 2015 04 01
(181) 2025 04 01
(891) 2015 04 01
(511) 09

(260) AM 2016 82427 A
(800) 1248610
(151) 2015 04 21
(181) 2025 04 21
(891) 2015 04 21
(511) 05

(260) AM 2016 82428 A
(800) 1248645
(151) 2014 10 23
(181) 2024 10 23
(891) 2014 10 23
(511) 03, 08, 16, 21, 25

(260) AM 2016 82429 A
(800) 1248652
(151) 2015 01 26
(181) 2025 01 26
(891) 2015 01 26
(511) 01, 02, 04, 06, 35, 37, 39, 42

(260) AM 2016 82431 A
(800) 1248677
(151) 2015 03 13
(181) 2025 03 13
(891) 2015 03 13
(511) 06, 14

(260) AM 2016 82478 A
(800) 1249368
(151) 2014 08 27
(181) 2024 08 27
(891) 2014 08 27
(511) 03, 09, 14, 18, 25, 28, 35, 41

(260) AM 2016 82479 A
(800) 1249412
(151) 2015 02 11
(181) 2025 02 11
(891) 2015 02 11
(511) 01

(260) AM 2016 82482 A
(800) 1249420
(151) 2015 02 20
(181) 2025 02 20
(891) 2015 02 20
(511) 05

(260) AM 2016 82485 A
(800) 1249554
(151) 2014 09 16

(181) 2024 09 16
(891) 2014 09 16
(511) 09, 28

(260) AM 2016 82486 A
(800) 1249561
(151) 2014 11 25
(181) 2024 11 25
(891) 2014 11 25
(511) 12

(260) AM 2016 82500 A
(800) 1249716
(151) 2015 05 07
(181) 2025 05 07
(891) 2015 05 07
(511) 39, 43

(260) AM 2016 82502 A
(800) 1249733
(151) 2014 06 09
(181) 2024 06 09
(891) 2014 06 09
(511) 25

(260) AM 2016 82504 A
(800) 1249745
(151) 2014 09 01
(181) 2024 09 01
(891) 2014 09 01
(511) 05, 29, 30, 40

(260) AM 2016 82506 A
(800) 1249773
(151) 2014 12 01
(181) 2024 12 01
(891) 2014 12 01
(511) 35

(260) AM 2016 82507 A
(800) 1249780
(151) 2015 01 06
(181) 2025 01 06
(891) 2015 01 06
(511) 09, 42

(260) AM 2016 82550 A
(800) 1250059
(151) 2015 03 27
(181) 2025 03 27
(891) 2015 03 27
(511) 36

(260) AM 2016 82551 A
(800) 1250104
(151) 2014 10 27
(181) 2024 10 27
(891) 2014 10 27
(511) 05, 30

(260) AM 2016 82553 A
(800) 1250126
(151) 2014 10 30
(181) 2024 10 30
(891) 2014 10 30
(511) 06, 07

(260) AM 2016 82554 A
(800) 1250132
(151) 2014 12 08
(181) 2024 12 08
(891) 2014 12 08
(511) 10

(260) AM 2016 82556 A
(800) 1250153
(151) 2014 12 10
(181) 2024 12 10
(891) 2014 12 10
(511) 05

(260) AM 2016 82557 A
(800) 1250154
(151) 2014 12 10
(181) 2024 12 10
(891) 2014 12 10
(511) 05

(260) AM 2016 82558 A
(800) 1250155
(151) 2014 12 10
(181) 2024 12 10
(891) 2014 12 10
(511) 05

(260) AM 2016 82559 A
(800) 1250156
(151) 2014 12 10
(181) 2024 12 10
(891) 2014 12 10
(511) 05

(260) AM 2016 82560 A
(800) 1250157
(151) 2014 12 10

(181) 2024 12 10
(891) 2014 12 10
(511) 05

(260) AM 2016 82561 A
(800) 1250183
(151) 2015 01 22
(181) 2025 01 22
(891) 2015 01 22
(511) 20, 25, 28

(260) AM 2016 82564 A
(800) 1250209
(151) 2015 03 05
(181) 2025 03 05
(891) 2015 03 05
(511) 09, 36, 41

(260) AM 2016 82574 A
(800) 1250292
(151) 2015 04 22
(181) 2025 04 22
(891) 2015 04 22
(511) 12

(260) AM 2016 82625 A
(800) 1251164
(151) 2015 04 22
(181) 2025 04 22
(891) 2015 04 22
(511) 05

(260) AM 2016 82626 A
(800) 1251182
(151) 2015 05 12
(181) 2025 05 12
(891) 2015 05 12
(511) 05

(260) AM 2016 82627 A
(800) 1250485
(151) 2015 04 13
(181) 2025 04 13
(891) 2015 04 13
(511) 09

(260) AM 2016 82635 A
(800) 1250732
(151) 2015 01 26
(181) 2025 01 26
(891) 2015 01 26
(511) 02, 35

(260) AM 2016 82638 A
(800) 921844
(151) 2007 02 08
(181) 2017 02 08
(891) 2015 03 06
(511) 29, 30, 43

(260) AM 2016 82639 A
(800) 1015490
(151) 2009 01 08
(181) 2019 01 08
(891) 2015 03 05
(511) 05, 39, 40, 42, 44

(260) AM 2016 82642 A
(800) 1132957
(151) 2012 07 27
(181) 2022 07 27
(891) 2015 05 08
(511) 43

(260) AM 2016 82643 A
(800) 1154657
(151) 2012 11 07
(181) 2022 11 07
(891) 2015 04 09
(511) 01, 05, 29, 30, 32

(260) AM 2016 82644 A
(800) 1159981
(151) 2013 01 25
(181) 2023 01 25
(891) 2015 04 08
(511) 05

(260) AM 2016 82645 A
(800) 1250735
(151) 2015 02 04
(181) 2025 02 04
(891) 2015 02 04
(511) 31, 32

(260) AM 2016 82647 A
(800) 1250758
(151) 2015 03 10
(181) 2025 03 10
(891) 2015 03 10
(511) 06, 35

(260) AM 2016 82650 A
(800) 1250768
(151) 2015 03 09

(181) 2025 03 09
(891) 2015 03 09
(511) 33

(260) AM 2016 82651 A
(800) 1179572
(151) 2013 08 26
(181) 2023 08 26
(891) 2015 04 01
(511) 03

(260) AM 2016 82652 A
(800) 1202767
(151) 2014 02 21
(181) 2024 02 21
(891) 2015 02 04
(511) 25

(260) AM 2016 82653 A
(800) 1220440
(151) 2014 05 13
(181) 2024 05 13
(891) 2015 02 26
(511) 09, 11, 37

(260) AM 2016 82654 A
(800) 1236113
(151) 2014 11 07
(181) 2024 11 07
(891) 2015 03 04
(511) 03

(260) AM 2016 82655 A
(800) 1183519
(151) 2013 08 14
(181) 2023 08 14
(891) 2015 03 13
(511) 04, 07, 09, 35, 37, 39, 40, 42, 45

(260) AM 2016 82656 A
(800) 1250823
(151) 2015 03 23
(181) 2025 03 23
(891) 2015 03 23
(511) 18, 25

(260) AM 2016 82658 A
(800) 1250837
(151) 2015 05 01
(181) 2025 05 01
(891) 2015 05 01
(511) 09

(260) AM 2016 82662 A
(800) 1250845
(151) 2014 12 19
(181) 2024 12 19
(891) 2014 12 19
(511) 14

(260) AM 2016 82664 A
(800) 1250873
(151) 2014 12 11
(181) 2024 12 11
(891) 2014 12 11
(511) 14, 18, 25, 35

(260) AM 2016 82666 A
(800) 1250889
(151) 2014 10 20
(181) 2024 10 20
(891) 2014 10 20
(511) 01, 16, 17

(260) AM 2016 82667 A
(800) 1250937
(151) 2014 12 30
(181) 2024 12 30
(891) 2014 12 30
(511) 19

(260) AM 2016 82668 A
(800) 1250970
(151) 2014 07 02
(181) 2024 07 02
(891) 2014 07 02
(511) 09, 35, 36, 38, 39, 42, 43, 45

(260) AM 2016 82669 A
(800) 1250939
(151) 2015 02 11
(181) 2025 02 11
(891) 2015 02 11
(511) 09, 16, 38, 39, 40, 41, 42, 45

(260) AM 2016 82670 A
(800) 1250971
(151) 2014 07 18
(181) 2024 07 18
(891) 2014 07 18
(511) 09, 35, 38, 41

(260) AM 2016 82671 A
(800) 1250983
(151) 2014 08 14

(181) 2024 08 14
(891) 2014 08 14
(511) 24, 25, 35

(260) AM 2016 82752 A
(800) 1251841
(151) 2014 11 07
(181) 2024 11 07
(891) 2014 11 07
(511) 02, 09

(260) AM 2016 82763 A
(800) 1251884
(151) 2015 04 24
(181) 2025 04 24
(891) 2015 04 24
(511) 01, 03, 04

(260) AM 2016 82766 A
(800) 1251952
(151) 2014 07 14
(181) 2024 07 14
(891) 2014 07 14
(511) 09

(260) AM 2016 82767 A
(800) 1251969
(151) 2014 10 08
(181) 2024 10 08
(891) 2014 10 08
(511) 07, 11

(260) AM 2016 82769 A
(800) 1251980
(151) 2014 09 26
(181) 2024 09 26
(891) 2014 09 26
(511) 09

(260) AM 2016 82773 A
(800) 1252062
(151) 2014 12 16
(181) 2024 12 16
(891) 2014 12 16
(511) 36, 43

(260) AM 2016 82792 A
(800) 1252690
(151) 2014 11 24
(181) 2024 11 24
(891) 2014 11 24
(511) 35, 37, 42

(260) AM 2016 82805 A
(800) 940990
(151) 2007 08 27
(181) 2017 08 27
(891) 2015 06 08
(511) 16, 39

(181) 2025 01 23
(891) 2015 01 23
(511) 14

(260) AM 2016 82807 A
(800) 978272
(151) 2008 08 15
(181) 2018 08 15
(891) 2015 05 21
(511) 01

(260) AM 2016 82810 A
(800) 1056434
(151) 2010 10 14
(181) 2020 10 14
(891) 2015 06 09
(511) 25

(260) AM 2016 82811 A
(800) 1132181
(151) 2012 05 18
(181) 2022 05 18
(891) 2015 06 10
(511) 05

(260) AM 2016 82857 A
(800) 1253058
(151) 2015 02 10
(181) 2025 02 10
(891) 2015 02 10
(511) 25

(260) AM 2016 82858 A
(800) 1253113
(151) 2015 03 27
(181) 2025 03 27
(891) 2015 03 27
(511) 33, 35

(260) AM 2016 82861 A
(800) 1253257
(151) 2015 04 06
(181) 2025 04 06
(891) 2015 04 06
(511) 33

(260) AM 2016 82863 A
(800) 1253340
(151) 2015 01 23

APPELLATIONS OF ORIGIN

THE RIGHT TO USE OF REGISTERED APPELLATIONS OF ORIGIN

REGISTERED AO: **SAIRME**
OWNER OF RIGHT ON USE: LTD "SAIRME MINERAL WATERS"
Kurorti Sairme, 1000, Baghdatis R-ni, Georgia
REGISTRATION NUMBER: 823/1-16
IN FORCE: 27 06 2017

OFFICIAL NOTIFICATIONS

INVENTION

RENEWAL OF A PATENT

(11) P 2012 5580 B

(73) Gugu Kiknavelidze (GE)

(54) **DOUBLE-ACTING FOUR-CYLINDER STIRLING ENGINE**

DATE OF RENEWAL: 11 07 2016

UTILITY MODELS

RENEWAL OF A PATENT

(11) U 2010 1592 Y

(73) LTS "AVERSI-RATIONAL" (GE)

(54) **ANBER TABLET**

DATE OF RENEWAL: 11 07 2016

TRADEMARKS

RENEWAL OF REGISTRATIONS

(111) M 1995 1083 R2

(156) 2016 02 19

(186) 2025 09 29

(732) Budějovický Budvar, národní podnik
(also trading as Budweiser Budvar,
National Corporation, Budweiser
Budvar, Entreprise Nationale)
K. Světlé 512/4, České Budějovice 3,
370 04 České Budějovice, Delivering
No.:370 21, Czech Republic

(732) TORREFAZIONE IONIA S.p.A.

Via Trieste, 306, 95010 Santa Venerina
(CT), Italy

(111) M 2006 16518 R1

(156) 2016 03 16

(186) 2026 03 02

(732) LTD "TIFFLISKIY VINNY POGREB"
Iumashevis q. 27, 0198, Tbilisi, Georgia

(111) M 1995 1245 R3

(156) 2025 12 06

(186) 2025 12 06

(732) Koninklijke Douwe Egberts B.V.
OosterdokJSCtraat 80, 1011 DK Amsterdam,
Netherlands

(111) M 2006 16529 R1

(156) 2016 03 02

(186) 2026 03 02

(732) LTD "G-M-P"
Zemo Vedzisi Str. 103, 0160, Tbilisi, Georgia

(111) M 1995 1245 R3

(156) 2025 12 06

(186) 2025 12 06

(732) Koninklijke Douwe Egberts B.V.
OosterdokJSCtraat 80, 1011 DK Amsterdam,
Netherlands

(111) M 2006 16565 R1

(156) 2016 04 28

(186) 2026 04 13

(732) KING CAR FOOD INDUSTRIAL CO.,
LTD.
No.203, Roosevelt Road, Sec.3, Taipei,
Taiwan. R.O.C., China

(111) M 1995 1307 R2

(156) 2015 12 28

(186) 2025 12 28

(732) TORAY FINE CHEMICALS CO., LTD.
2-3-1, Kanda-Sudacho, Chiyoda-ku, Tokyo
101-0041, Japan

(111) M 2006 16571 R1

(156) 2016 04 17

(186) 2026 04 17

(732) JSC "TELAVI WINE CELLAR"
Sop. Kurdghelauri, 2200, Telavi, Georgia

(111) M 1996 1506 R2

(156) 2016 03 23

(186) 2026 02 09

(732) LANXEJSC DEUTSCHLAND GmbH
51369 Leverkusen, Germany

(111) M 2006 16572 R1

(156) 2016 04 17

(186) 2026 04 17

(732) MEIJI SEIKA PHARMA CO., LTD.
4-16, Kyobashi 2-chome, Chuo-ku, Tokyo,
Japan

(111) M 2006 16434 R1

(156) 2016 01 16

(186) 2026 01 16

(732) CONOPCO INC
700 Sylvan Avenue, Englewood Cliffs,
NJ07632, USA

(111) M 2006 16574 R1

(156) 2016 04 17

(186) 2026 04 17

(732) JSC "TELAVI WINE CELLAR"
Sop. Kurdghelauri, 2200, Telavi, Georgia

(111) M 2006 16476 R1

(156) 2016 04 06

(186) 2026 02 15

(111) M 2006 16575 R1

(156) 2016 04 17

(186) 2026 04 17

(732) Hayat Kimya Sanayi A.Ş.

Mahir Iz Caddesi No: 25 Altunizade üsküdar,
Istanbul, Turkey

(111) M 2006 16607 R1
(156) 2016 05 05
(186) 2026 05 01

(732) GENERAL MOTORS LLC
300 RenaiJSCance Center, City of Detroit,
State of Michigan 48265-3000, USA

(111) M 2006 16611 R1
(156) 2016 05 17
(186) 2026 05 17

(732) MONSOON ACCEJSCORIZE LIMITED
1 Nicholas Road, London, W11 4 AN,
United Kingdom

(111) M 2006 16614 R1
(156) 2016 05 17
(186) 2026 05 17

(732) THE PROCTER & GAMBLE COMPANY
One Procter & Gamble Plaza, Cincinnati,
Ohio, USA

(111) M 2006 16619 R1
(156) 2016 05 17
(186) 2026 05 17

(732) RADIJSCON HOTELS INTERNATIONAL,
INC. (a Delaware Corporation)
Carlson Parkway, P.O. Box 59159,
Minneapolis, Minnesota 55459-8249, USA

(111) M 2006 16634 R1
(156) 2016 05 17
(186) 2026 05 17

(732) LTD "AVERSI-PHARMA"
Davit Agmasheneblis gamz. 148/2, 0112,
Tbilisi, Georgia

(111) M 2006 16635 R1
(156) 2016 05 17
(186) 2026 05 17

(732) LTD "AVERSI-PHARMA"
Davit Agmasheneblis gamz. 148/2, 0112,
Tbilisi, Georgia

(111) M 2006 16636 R1
(156) 2016 05 17
(186) 2026 05 17

(732) LTD "AVERSI-PHARMA"
Davit Agmasheneblis gamz. 148/2, 0112,
Tbilisi, Georgia

(111) M 2006 16637 R1
(156) 2016 05 17
(186) 2026 05 17

(732) LTD "AVERSI-PHARMA"
Davit Agmasheneblis gamz. 148/2, 0112,
Tbilisi, Georgia

(111) M 2006 16638 R1
(156) 2016 05 17
(186) 2026 05 17

(732) LTD "AVERSI-PHARMA"
Davit Agmasheneblis gamz. 148/2, 0112,
Tbilisi, Georgia

(111) M 2006 16639 R1
(156) 2016 05 17
(186) 2026 05 17

(732) LTD "AVERSI-PHARMA"
Davit Agmasheneblis gamz. 148/2, 0112,
Tbilisi, Georgia

(111) M 2006 16640 R1
(156) 2016 05 17
(186) 2026 05 17

(732) LTD "AVERSI-PHARMA"
Davit Agmasheneblis gamz. 148/2, 0112,
Tbilisi, Georgia

(111) M 2006 16641 R1
(156) 2016 05 17
(186) 2026 05 17

(732) LTD "AVERSI-PHARMA"
Davit Agmasheneblis gamz. 148/2, 0112,
Tbilisi, Georgia

(111) M 2006 16642 R1
(156) 2016 05 17
(186) 2026 05 17

(732) LTD "AVERSI-PHARMA"
Davit Agmasheneblis gamz. 148/2, 0112,
Tbilisi, Georgia

(111) M 2006 16643 R1
(156) 2016 05 17
(186) 2026 05 17

(732) LTD "AVERSI-PHARMA"
Davit Agmasheneblis gamz. 148/2, 0112,
Tbilisi, Georgia

(111) M 2006 16644 R1
(156) 2016 05 17
(186) 2026 05 17

(732) LTD "AVERSI-PHARMA"
Davit Agmasheneblis gamz. 148/2, 0112,
Tbilisi, Georgia

(111) M 2006 16645 R1
(156) 2016 05 17
(186) 2026 05 17
(732) LTD "AVERSI-PHARMA"
Davit Agmasheneblis gamz. 148/2, 0112,
Tbilisi, Georgia

(111) M 2006 16646 R1
(156) 2016 05 17
(186) 2026 05 17
(732) LTD "AVERSI-PHARMA"
Davit Agmasheneblis gamz. 148/2, 0112,
Tbilisi, Georgia

(111) M 2006 16648 R1
(156) 2016 05 17
(186) 2026 05 17
(732) LTD "AVERSI-PHARMA"
Davit Agmasheneblis gamz. 148/2, 0112,
Tbilisi, Georgia

(111) M 2006 16649 R1
(156) 2016 05 17
(186) 2026 05 17
(732) LTD "AVERSI-PHARMA"
Davit Agmasheneblis gamz. 148/2, 0112,
Tbilisi, Georgia

(111) M 2006 16650 R1
(156) 2016 05 17
(186) 2026 05 17
(732) LTD "AVERSI-PHARMA"
Davit Agmasheneblis gamz. 148/2, 0112,
Tbilisi, Georgia

(111) M 2006 16651 R1
(156) 2016 05 17
(186) 2026 05 17
(732) LTD "AVERSI-PHARMA"
Davit Agmasheneblis gamz. 148/2, 0112,
Tbilisi, Georgia

(111) M 2006 16653 R1
(156) 2016 06 01
(186) 2026 06 01
(732) JAMAL ABDUL NAJSCER MAHMOOD
AL MAHAMID
P.O. Box. 81450, Dubai, United Arab
Emirates

(111) M 2006 16671 R1
(156) 2016 06 02
(186) 2026 06 02
(732) KAREN VARDANYAN
Baironis q.3, b.36, Erevani, Armenia

(111) M 2006 16672 R1
(156) 2016 06 02
(186) 2026 06 02
(732) KAREN VARDANYAN
Baironis q.3, b.36, Erevani, Armenia

(111) M 2006 16686 R1
(156) 2016 06 15
(186) 2026 06 15
(732) LTD "AVERSI-PHARMA"
Davit Agmasheneblis gamz. 148/2, 0112,
Tbilisi, Georgia

(111) M 1996 1669 R2
(156) 2016 03 04
(186) 2026 03 04
(732) ATNAHS PHARMA UK LTD
12 Helmet Row, London EC1Y 8JU, United
Kingdom

(111) M 2006 16690 R1
(156) 2016 06 23
(186) 2026 06 23
(732) LTD "G-M-P"
Zemo Vedzisi Str. 103, 0160, Tbilisi, Georgia

(111) M 2006 16692 R1
(156) 2016 06 26
(186) 2026 06 26
(732) CISCO TECHNOLOGY, INC.
170 West Tasman Drive, San Jose, California
95134, USA

(111) M 2006 16693 R1
(156) 2016 06 26
(186) 2026 06 26
(732) LEO Pharma A/S
Industriparken 55, 2750 Ballerup, Denmark

(111) M 2006 16694 R1
(156) 2016 06 26
(186) 2026 06 26
(732) CISCO TECHNOLOGY, INC.
170 West Tasman Drive, San Jose, California
95134, USA

(111) M 2006 16704 R1
(156) 2016 06 26
(186) 2026 06 26
(732) YILDIZ HOLDING A.S.
Kisikli mah. Ferah Cad. Kisikli Cesme Sk.
No:2/4 B. Camlica, Uskudar, ISTANBUL,
Turkey

(111) M 2006 16724 R1
(156) 2016 07 12
(186) 2026 07 12
(732) MERCK SHARP & DOHME CORP.
One Merck Drive, Whitehouse Station,
New Jersey 08889, USA

(111) M 1996 1676 R2
(156) 2016 06 02
(186) 2026 03 05
(732) CASE POCLAIN S.A.
F-60 330 LE PLEJSCIS-BELLEVILLE,
France

(111) M 2006 16765 R1
(156) 2016 08 01
(186) 2026 08 01
(732) Bata Brands SA
Avenue de Rhodanie 70, 1007 Lausanne,
Switzerland

(111) M 2006 16784 R1
(156) 2016 08 01
(186) 2026 08 01
(732) PLAYBOY ENTERPRISES
INTERNATIONAL, INC.
680 North Lake Shore Drive, Chicago,
Illinois 60611, USA

(111) M 2006 16835 R1
(156) 2016 08 31
(186) 2026 08 31
(732) SBARRO FRANCHISE CO. LLC.
1328 Dublin Road, Columbus, Ohio, 43215,
USA

(111) M 2006 16868 R1
(156) 2016 10 04
(186) 2026 10 04
(732) COLDWELL BANKER LLC
175 Park Avenue, Medison, New Jersey
07940, USA

(111) M 2006 16869 R1
(156) 2016 10 04
(186) 2026 10 04
(732) COLDWELL BANKER LLC
175 Park Avenue, Medison, New Jersey
07940, USA

(111) M 2006 16870 R1
(156) 2016 10 04
(186) 2026 10 04
(732) COLDWELL BANKER LLC
175 Park Avenue, Medison, New Jersey
07940, USA

(111) M 2006 16871 R1
(156) 2016 10 04
(186) 2026 10 04
(732) COLDWELL BANKER LLC
175 Park Avenue, Medison, New Jersey
07940, USA

(111) M 2006 17057 R1
(156) 2016 11 13
(186) 2026 11 13
(732) ADVANCE MAGAZINE PUBLISHERS
INC.
Four Times Square, New York, N. Y.
10036, USA

(111) M 2006 17137 R1
(156) 2016 12 14
(186) 2026 12 14
(732) LTD "VAZIANI COMPANY"
Mshvidobis q. 42, 2200, Telavi, Georgia

(111) M 2006 17195 R1
(156) 2016 12 15
(186) 2026 12 15
(732) POLICHEM S.A.
50, Val Fleuri, L-1526 LUXEMBOURG,
Luxembourg

(111) M 2006 17196 R1
(156) 2016 12 15
(186) 2026 12 15
(732) POLICHEM S.A.
50, Val Fleuri, L-1526 LUXEMBOURG,
Luxembourg

(111) M 1996 1723 R2
(156) 2016 03 24
(186) 2026 03 11

(732) AMERICAN EXPREJSC MARKETING &
DEVELOPMENT CORP.
200 Vesey St., 49-12, New York, N.Y.
10285, USA

(111) M 1996 1724 R2
(156) 2016 03 24
(186) 2026 03 12

(732) AMERICAN EXPREJSC MARKETING &
DEVELOPMENT CORP.
200 Vesey St., 49-12, New York, N.Y.
10285, USA

(111) M 1996 1725 R2
(156) 2016 03 24
(186) 2026 03 12

(732) AMERICAN EXPREJSC MARKETING &
DEVELOPMENT CORP.
200 Vesey St., 49-12, New York, N.Y.
10285, USA

(111) M 1996 1726 R2
(156) 2016 03 24
(186) 2026 03 12

(732) AMERICAN EXPREJSC MARKETING &
DEVELOPMENT CORP.
200 Vesey St., 49-12, New York, N.Y.
10285, USA

(111) M 1996 1727 R2
(156) 2016 03 24
(186) 2026 03 12

(732) AMERICAN EXPREJSC MARKETING &
DEVELOPMENT CORP.
200 Vesey St., 49-12, New York, N.Y.
10285, USA

(111) M 1996 1728 R2
(156) 2016 03 24
(186) 2026 03 12

(732) AMERICAN EXPREJSC MARKETING &
DEVELOPMENT CORP.
200 Vesey St., 49-12, New York, N.Y.
10285, USA

(111) M 1996 1829P R2
(156) 2016 03 21
(186) 2026 03 21

(732) KAO KABUSHIKI KAISHA (also trading as
Kao Corporation)
14-10 Nihonbashi, Kayaba-cho 1-chome,
chuo-ku, Tokyo, Japan

(111) M 1996 1841P R2
(156) 2016 03 25
(186) 2026 03 25

(732) KAO KABUSHIKI KAISHA (also trading as
Kao Corporation)
14-10 Nihonbashi, Kayaba-cho 1-chome,
chuo-ku, Tokyo, Japan

(111) M 1996 1876 R2
(156) 2016 04 01
(186) 2026 04 01

(732) MEDA Pharma GmbH & Co. KG
BenzstraJSCe 1, 61352 Bad Homburg,
Germany

(111) M 1996 1885 R2
(156) 2016 04 01
(186) 2026 04 01

(732) MEDA Pharma GmbH & Co. KG
BenzstraJSCe 1, 61352 Bad Homburg,
Germany

(111) M 1996 1883 R2
(156) 2016 04 01
(186) 2026 04 01

(732) MEDA Pharma GmbH & Co. KG
BenzstraJSCe 1, 61352 Bad Homburg,
Germany

(111) M 1996 1999 R2
(156) 2016 05 05
(186) 2026 04 30

(732) Budějovický Budvar, národní podnik (also
trading as Budweiser Budvar, National
Corporation, Budweiser Budvar, Entreprise
Nationale)
K. Světlé 512/4, České Budějovice 3,
370 04 České Budějovice, Delivering
No.:370 21, Czech Republic

(111) M 1996 2008 R2
(156) 2016 05 04
(186) 2026 04 30

(732) AUGUST STORCK KG
Waldstrase 27, D-13403 Berlin, Germany

(111) M 1996 2026 R2
(156) 2016 05 11
(186) 2026 05 07

(732) DAIMLER AG
MercedeJSCtraJSCe 137, 70327 Stuttgart,
Germany

(111) M 1996 2027 R2
 (156) 2016 05 10
 (186) 2026 05 08
 (732) DAIMLER AG
 MercedesJSCtraJSCe 137, 70327 Stuttgart,
 Germany

(111) M 1996 2033 R2
 (156) 2016 05 08
 (186) 2026 05 08
 (732) PIONEER HI-BRED INTERNATIONAL,
 INC.
 7100 N.W. 62 nd Avenue, P.O. Box 1014,
 Johnston, Iowa 50131-1014, USA

(111) M 1996 2043 R2
 (156) 2016 05 10
 (186) 2026 05 10
 (732) TECHNICOLOR USA, INC.
 101 W. 103rd Street, Indianapolis, Indiana
 46290, USA

(111) M 1996 2046 R2
 (156) 2016 05 10
 (186) 2026 05 10
 (732) DAIMLER AG
 MercedesJSCtraJSCe 137, 70327 Stuttgart,
 Germany

(111) M 1996 2047 R2
 (156) 2016 05 10
 (186) 2026 05 10
 (732) DAIMLER AG
 MercedesJSCtraJSCe 137, 70327 Stuttgart,
 Germany

(111) M 1996 2048 R2
 (156) 2016 05 10
 (186) 2026 05 10
 (732) DAIMLER AG
 MercedesJSCtraJSCe 137, 70327 Stuttgart,
 Germany

(111) M 1996 2050 R2
 (156) 2016 05 10
 (186) 2026 05 10
 (732) PIONEER HI-BRED INTERNATIONAL,
 INC.
 7100 N.W. 62 nd Avenue, P.O. Box
 1014, Johnston, Iowa 50131-1014, USA

(111) M 1996 2060 R2
 (156) 2016 05 16
 (186) 2026 05 14
 (732) MERCK SANTE, SAS
 37, rue St. Romain, 69008 Lyon, France

(111) M 1996 2061 R2
 (156) 2016 05 14
 (186) 2026 05 14
 (732) FYFFES INTERNATIONAL
 29 North Anne Street, Dublin 7, Ireland

(111) M 1996 2065 R2
 (156) 2016 05 14
 (186) 2026 05 14
 (732) SOCIÉTÉ DES PRODUITS NESTLÉ S.A.
 CH-1800 Vevey, Switzerland

(111) M 1996 2075 R2
 (156) 2016 05 15
 (186) 2026 05 15
 (732) TENNENT COMPANY
 701 North Lilac Drive, Minneapolis, MN
 55422, USA

(111) M 1996 2076 R2
 (156) 2016 05 15
 (186) 2026 05 15
 (732) S.C. JOHNSON & SON, INC.
 1525 Howe Street, Racine, Wisconsin
 53403-2236, USA

(111) M 1996 2081 R2
 (156) 2016 06 08
 (186) 2026 05 16
 (732) JANJSCEN PHARMACEUTICA N.V.
 Turnhoutseweg 30, B-2340 Beerse, Belgium

(111) M 1996 2082 R2
 (156) 2016 06 08
 (186) 2026 05 16
 (732) JANJSCEN PHARMACEUTICA N.V.
 Turnhoutseweg 30, B-2340 Beerse, Belgium

(111) M 1996 2092 R2
 (156) 2016 05 16
 (186) 2026 05 16
 (732) KUDELSKI S.A.
 Route de Geneve 22, 1033 Cheseaux-Sur-
 Lausanne, Switzerland

(111) M 1996 2096 R2
 (156) 2016 05 16
 (186) 2026 05 16
 (732) S.C. JOHNSON & SON, INC.
 1525 Howe Street, Racine, Wisconsin
 53403-2236, USA

1525 Howe Street, Racine, Wisconsin
 53403-2236, USA

(111) M 1996 2100 R2
 (156) 2016 05 17
 (186) 2026 05 17
 (732) LIPHATECH
 Bonnel, 47480 PONT-DU-CAJSCE, France

(111) M 1996 2125 R2
 (156) 2016 05 22
 (186) 2026 05 22
 (732) S.C. JOHNSON & SON, INC.
 1525 Howe Street, Racine, Wisconsin
 53403-2236, USA

(111) M 1996 2108 R2
 (156) 2016 05 21
 (186) 2026 05 21
 (732) S.C. JOHNSON & SON, INC.
 1525 Howe Street, Racine, Wisconsin
 53403-2236, USA

(111) M 1996 2126 R2
 (156) 2016 05 22
 (186) 2026 05 22
 (732) S.C. JOHNSON & SON, INC.
 1525 Howe Street, Racine, Wisconsin
 53403-2236, USA

(111) M 1996 2109 R2
 (156) 2016 05 27
 (186) 2026 05 21
 (732) POTAIN
 18, rue de Charbonnieres, F-69 130 Ecully,
 France

(111) M 1996 2127 R2
 (156) 2016 05 22
 (186) 2026 05 22
 (732) S.C. JOHNSON & SON, INC.
 1525 Howe Street, Racine, Wisconsin
 53403-2236, USA

(111) M 1996 2116 R2
 (156) 2016 05 21
 (186) 2026 05 21
 (732) COVIDIEN AG
 Victor von Bruns-StraJSCe 19, 8212
 Neuhausen am Rheinfall, Switzerland

(111) M 1996 2149 R2
 (156) 2016 05 27
 (186) 2026 05 27
 (732) KIMBERLY-CLARK WORLDWIDE, INC.
 NEENAH, WI 54956, USA

(111) M 1996 2119 R2
 (156) 2016 05 21
 (186) 2026 05 21
 (732) COVIDIEN AG
 Victor von Bruns-StraJSCe 19, 8212
 Neuhausen am Rheinfall, Switzerland

(111) M 1996 2150 R2
 (156) 2016 05 27
 (186) 2026 05 27
 (732) KIMBERLY-CLARK WORLDWIDE, INC.
 NEENAH, WI 54956, USA

(111) M 1996 2122 R2
 (156) 2016 05 22
 (186) 2026 05 22
 (732) S.C. Johnson & Son, Inc.
 1525 Howe Street, Racine, Wisconsin
 53403-2236, USA

(111) M 1996 2152 R2
 (156) 2016 05 28
 (186) 2026 05 28
 (732) KIMBERLY-CLARK WORLDWIDE, INC.
 NEENAH, WI 54956, USA

(111) M 1996 2124 R2
 (156) 2016 05 22
 (186) 2026 05 22
 (732) S.C. JOHNSON & SON, INC.

(111) M 1996 2153 R2
 (156) 2016 05 28
 (186) 2026 05 28
 (732) KIMBERLY-CLARK WORLDWIDE, INC.
 NEENAH, WI 54956, USA

(111) M 1996 2156 R2
 (156) 2016 05 28
 (186) 2026 05 28

(732) KIMBERLY-CLARK WORLDWIDE, INC.
NEENAH, WI 54956, USA

(111) M 1996 2165 R2
(156) 2016 05 29
(186) 2026 05 29

(732) CLININGEN HEALTHCARE LIMITED
Pitcairn House, First Avenue, Burton on
Trent, DE14 2 WW, United Kingdom

(111) M 1996 2175 R2
(156) 2016 05 29
(186) 2026 05 29

(732) GEORGIA-PACIFIC S.a.r.l.
25, route d'Esch, L-1470, Luxembourg

(111) M 1996 2186 R2
(156) 2016 05 30
(186) 2026 05 30

(732) HYUNDAI MOTOR COMPANY
140-2, Kye-Dong, Jongro-ku, Seoul,
Republic of Korea

(111) M 1996 2187 R2
(156) 2016 05 30
(186) 2026 05 30

(732) HYUNDAI MOTOR COMPANY
140-2, Kye-Dong, Jongro-ku, Seoul,
Republic of Korea

(111) M 1996 2188 R2
(156) 2016 05 30
(186) 2026 05 30

(732) Hyundai Motor Company
140-2, Kye-Dong, Jongro-ku, Seoul,
Republic of Korea

(111) M 1996 2189 R2
(156) 2016 05 30
(186) 2026 05 30

(732) NIJSCAN JIDOSHA KABUSHIKI KAISHA
(also trading as NiJSCan Motor Co., Ltd)
2 Takaracho, Kanagawa-ku, Yokohama-shi,
Kanagawa-Ken, Japan

(111) M 1996 2193 R2
(156) 2016 05 30
(186) 2026 05 30

(732) NIJSCAN JIDOSHA KABUSHIKI KAISHA
(also trading as NiJSCan Motor Co., LTD)
2 Takaracho, Kanagawa-Ku, Yokohama-shi,
Kanagawa-Ken, Japan

(111) M 1996 2195 R2
(156) 2016 05 30
(186) 2026 05 30

(732) NIJSCAN JIDOSHA KABUSHIKI KAISHA
(also trading as NiJSCan Motor Co., LTD)
2 Takaracho, Kanagawa-Ku, Yokohama-shi,
Kanagawa-Ken, Japan

(111) M 1996 2196 R2
(156) 2016 05 30
(186) 2026 05 30

(732) NIJSCAN JIDOSHA KABUSHIKI KAISHA
(also trading as NiJSCan Motor Co., LTD)
2 Takaracho, Kanagawa-Ku, Yokohama-shi,
Kanagawa-Ken, Japan

(111) M 1996 2244 R2
(156) 2016 06 05
(186) 2026 06 05

(732) HP HEWLETT PACKARD GROUP LLC
11445 Compaq Center Drive West, Houston,
Texas 77070, USA

(111) M 1996 2250 R2
(156) 2016 06 05
(186) 2026 06 05

(732) HP HEWLETT PACKARD GROUP LLC
11445 Compaq Center Drive West, Houston,
Texas 77070, USA

(111) M 1996 2252 R2
(156) 2016 06 05
(186) 2026 06 05

(732) HP HEWLETT PACKARD GROUP LLC
11445 Compaq Center Drive West, Houston,
Texas 77070, USA

(111) M 1996 2259 R2
(156) 2016 06 06
(186) 2026 06 06

(732) FMC TECHNOLOGIES, INC.
5875 North Sam Houston Parkway, West,
Houston, Texas 77986, USA

(111) M 1996 2261 R2
(156) 2016 06 06
(186) 2026 06 06

(732) NIJSCAN JIDOSHA KABUSHIKI KAISHA
(also trading as NiJSCan Motor Co., LTD)
2 Takaracho, Kanagawa-Ku, Yokohama-shi,
Kanagawa-Ken, Japan

(111) M 1996 2262 R2
(156) 2016 06 06
(186) 2026 06 06
(732) MEATPOINT B.V.
Twentepoort Oost 5, NL-7609 RG Almelo,
Netherlands

(111) M 1996 2272 R2
(156) 2016 06 07
(186) 2026 06 07
(732) FD MANAGEMENT, INC.
a Delaware corporation
300 Delaware Avenue, Wilmington,
Delaware 19801, USA

(111) M 1996 2283 R2
(156) 2016 06 10
(186) 2026 06 10
(732) DF ENTERPRISES, INC.
a Delaware corporation
300 Delaware Avenue, Wilmington,
Delaware 19801, USA

(111) M 1996 2299 R2
(156) 2016 06 10
(186) 2026 06 10
(732) THE DRAMBUIE LIQUEUR COMPANY
LIMITED
18 Westerton Road, Broxburn, Scotland
EH52 5AQ, United Kingdom

(111) M 1996 2310 R2
(156) 2016 06 11
(186) 2026 06 11
(732) Wm. WRIGLEY Jr. Company
1132 West Blackhawk Street, Chicago,
Illinois 60642, USA

(111) M 1996 2315 R2
(156) 2016 06 11
(186) 2026 06 11
(732) MAZDA MOTOR CORPORATION;
3-1, Shinchi, Fuchu-cho, Aki-gun,
Hiroshima-ken, Japan

(111) M 1996 2316 R2
(156) 2016 06 11
(186) 2026 06 11
(732) MAZDA MOTOR CORPORATION
3-1, Shinchi, Fuchu-cho, Aki-gun,
Hiroshima-ken, Japan

(111) M 1996 2317 R2
(156) 2016 06 11
(186) 2026 06 11
(732) DART INDUSTRIES INC.
14901 S. Orange BloJSCom Trail, Orlando,
Florida 32837, USA

(111) M 1996 2346 R2
(156) 2016 06 12
(186) 2026 06 12
(732) TENNECO AUTOMOTIVE OPERATING
COMPANY INC.
500 North Field Draive, Lake Forest,
Illinois 60045, USA

(111) M 1996 2349 R2
(156) 2016 06 12
(186) 2026 06 12
(732) ALBEMARLE CORPORATION
451 Florida Street, Baton Rouge, Louisiana,
70801, USA

(111) M 1996 2369 R2
(156) 2016 06 14
(186) 2026 06 14
(732) BAYER AG
D-51368 Leverkusen, Germany

(111) M 1996 2370 R2
(156) 2016 06 14
(186) 2026 06 14
(732) SOCIETE DES PRODUITS NESTLE S.A.
Vevey, Switzerland

(111) M 1996 2377 R2
(156) 2016 06 14
(186) 2026 06 14
(732) Budějovický Budvar, národní podnik (also
trading as Budweiser Budvar, National
Corporation, Budweiser Budvar, Entreprise
Nationale)
K. Světlé 512/4, České Budějovice 3,
370 04 České Budějovice, Delivering
No.:370 21, Czech Republic

(111) M 1996 2379 R2
(156) 2016 06 14
(186) 2026 06 14
(732) Budějovický Budvar, národní podnik (also
trading as Budweiser Budvar, National
Corporation, Budweiser Budvar, Entreprise
Nationale)
K. Světlé 512/4, České Budějovice 3,

370 04 České Budějovice, Delivering
No.:370 21, Czech Republic

(111) M 1996 2382 R2
(156) 2016 06 14
(186) 2026 06 14
(732) THE SERVICEMASTER COMPANY L.P.;
2300 Warrenville Road, Downers Grove,
IL 60515, USA

(111) M 1996 2399 R2
(156) 2016 06 17
(186) 2026 06 17
(732) INFINEUM INTERNATIONAL LIMITED
Corporrate Centre, P.O. Box 1, Milton Hill,
Abingdon, Oxfordshire, OX13 6 BB,
United Kingdom

(111) M 1996 2405 R2
(156) 2016 06 17
(186) 2026 06 17
(732) INFINEUM INTERNATIONAL LIMITED
P.O. Box 1, Milton Hill, Abingdon,
Oxfordshire, OX13 6 BB, United Kingdom

(111) M 1996 2420 R2
(156) 2016 06 18
(186) 2026 06 18
(732) NGK SPARK PLUG CO., LTD
14-18, Takatsuji-cho, Mizuho-ku, Nagoya
City, 467-8525, Japan

(111) M 1996 2421 R2
(156) 2016 06 19
(186) 2026 06 19
(732) SABIC Global Technologies B.V.
Plasticslaan 1, 4612 PX Bergen op Zoom,
Netherlands

(111) M 1996 2434 R2
(156) 2016 06 20
(186) 2026 06 20
(732) FD MANAGEMENT, INC., a Delaware
corporation
300 Delaware Avenue, Wilmington,
Delaware 19801, USA

(111) M 1996 2438 R2
(156) 2016 06 21
(186) 2026 06 21
(732) RENAULT S.A.S.
92100 BOULOGNE-BILLANCOURT,
France

(111) M 1996 2439 R2
(156) 2016 06 21
(186) 2026 06 21
(732) RENAULT S.A.S.
92100 BOULOGNE-BILLANCOURT,
France

(111) M 1996 2441 R2
(156) 2016 06 21
(186) 2026 06 21
(732) RENAULT S.A.S.
92100 BOULOGNE-BILLANCOURT,
France

(111) M 1996 2442 R2
(156) 2016 06 21
(186) 2026 06 21
(732) RENAULT S.A.S.
92100 BOULOGNE-BILLANCOURT,
France

(111) M 1996 2445 R2
(156) 2016 06 21
(186) 2026 06 21
(732) BARCLAYS CAPITAL INC., A
CONNECTICUT CORPORATION
745 Seventh Avenue New York, New York
10019, USA

(111) M 1996 2448 R2
(156) 2016 06 21
(186) 2026 06 21
(732) BIOFARMA
50, rue Carnot, 92284 Suresnes cedex, France

(111) M 1996 2449 R2
(156) 2016 06 23
(186) 2026 06 21
(732) BIOFARMA
50, rue Carnot, 92284 Suresnes cedex, France

(111) M 1996 2450 R2
(156) 2016 06 21
(186) 2026 06 21
(732) BIOFARMA
50, rue Carnot, 92284 Suresnes cedex, France

(111) M 1996 2454 R2
(156) 2016 06 21
(186) 2026 06 21
(732) BIOFARMA
50, rue Carnot, 92284 Suresnes cedex, France

(111) M 1996 2455 R2
 (156) 2016 06 21
 (186) 2026 06 21
 (732) BIOFARMA
 50, rue Carnot, 92284 Suresnes cedex, France

(111) M 1996 2456 R2
 (156) 2016 06 21
 (186) 2026 06 21
 (732) BIOFARMA
 50, rue Carnot, 92284 Suresnes cedex, France

(111) M 1996 2457 R2
 (156) 2016 06 21
 (186) 2026 06 21
 (732) LES LABORATOIRES SERVIER
 50 rue Carnot, 92284 Suresnes cedex, France

(111) M 1996 2464 R2
 (156) 2016 06 24
 (186) 2026 06 24
 (732) PANZANI
 4, rue Boileau, 69006 Lyon, France

(111) M 1996 2466 R2
 (156) 2016 06 24
 (186) 2026 06 24
 (732) COMPAGNIE GERVAIS DANONE,
 societe anonyme
 17 Boulevard HauJSCmann, 75009 Paris,
 France

(111) M 1996 2477 R2
 (156) 2016 06 24
 (186) 2026 06 24
 (732) SANOFI
 54, rue La Boétie, 75008 Paris, France

(111) M 1996 2481 R2
 (156) 2016 06 25
 (186) 2026 06 25
 (732) LOTTO SPORT ITALIA S.P.A.
 Via Montebelluna 5/7, 31040 Trevignano,
 Treviso, Italy

(111) M 1996 2482 R2
 (156) 2016 06 25
 (186) 2026 06 25
 (732) GIORGIO ARMANI S.p.A.
 Milan, SwiJSC Branch Mendrisio;
 Via Penate 4, 6850 Mendrisio, Switzerland

(111) M 1996 2493 R2
 (156) 2016 06 25
 (186) 2026 06 25
 (732) MERCK SHARP & DOHME CORP.
 One Merck Drive, Whitehouse Station,
 New Jersey 08889, USA

(111) M 1996 2499 R2
 (156) 2016 06 25
 (186) 2026 06 25
 (732) LOTTO SPORT ITALIA S.P.A.
 Via Montebelluna 5/7, 31040 Trevignano,
 Treviso, Italy

(111) M 1996 2500 R2
 (156) 2016 06 25
 (186) 2026 06 25
 (732) ELF AQUITAINE, Societe Anonyme
 2, place Jean Millier, La Defense 6,
 F-92400 Courbevoie, France

(111) M 1996 2502 R2
 (156) 2016 06 25
 (186) 2026 06 25
 (732) GIORGIO ARMANI S.p.A., Milan, SwiJSC
 Branch Mendrisio
 Via Penate 4, 6850 Mendrisio, Switzerland

(111) M 1996 2503 R2
 (156) 2016 06 27
 (186) 2026 06 27
 (732) GIORGIO ARMANI S.p.A., Milan, SwiJSC
 Branch Mendrisio
 Via Penate 4, 6850 Mendrisio, Switzerland

(111) M 1996 2509 R2
 (156) 2016 06 27
 (186) 2026 06 27
 (732) PIAGGIO & C. S.P.A.
 Viale Rinaldo Piaggio, 25, Pontedera (Pisa),
 Italy

(111) M 1996 2522 R2
 (156) 2016 06 28
 (186) 2026 06 28
 (732) RENAULT S.A.S.
 92100 BOULOGNE-BILLANCOURT,
 France

(111) M 1996 2524 R2
 (156) 2016 06 28
 (186) 2026 06 28

(732) RENAULT S.A.S.
92100 BOULOGNE-BILLANCOURT,
France

(111) M 1996 2527 R2
(156) 2016 06 28
(186) 2026 06 28

(732) RENAULT S.A.S.
92100 BOULOGNE-BILLANCOURT,
France

(111) M 1996 2530 R2
(156) 2016 06 28
(186) 2026 06 28

(732) CADBURY UK LIMITED
P.O. Box 12, Bournville Lane, Bournville,
Birmingham B30 2LU, United Kingdom

(111) M 1996 2541 R2
(156) 2016 07 01
(186) 2026 07 01

(732) SOCIÉTÉ DES PRODUITS NESTLÉ S.A.
1800 Vevey, Switzerland

(111) M 1996 2542 R2
(156) 2016 07 01
(186) 2026 07 01

(732) SOCIÉTÉ DES PRODUITS NESTLÉ S.A.
1800 Vevey, Switzerland

(111) M 1996 2545 R2
(156) 2016 07 01
(186) 2026 07 01

(732) SOCIÉTÉ DES PRODUITS NESTLÉ S.A.
1800 Vevey, Switzerland

(111) M 1996 2546 R2
(156) 2016 07 01
(186) 2026 07 01

(732) SOCIÉTÉ DES PRODUITS NESTLÉ S.A.
1800 Vevey, Switzerland

(111) M 1996 2547 R2
(156) 2016 07 01
(186) 2026 07 01

(732) SOCIÉTÉ DES PRODUITS NESTLÉ S.A.
1800 Vevey, Switzerland

(111) M 1996 2549 R2
(156) 2016 07 01
(186) 2026 07 01

(732) SOCIÉTÉ DES PRODUITS NESTLÉ S.A.
1800 Vevey, Switzerland

(111) M 1996 2550 R2
(156) 2016 07 02
(186) 2026 07 02

(732) SOCIÉTÉ DES PRODUITS NESTLÉ S.A.
1800 Vevey, Switzerland

(111) M 1996 2551 R2
(156) 2016 07 02
(186) 2026 07 02

(732) SOCIÉTÉ DES PRODUITS NESTLÉ S.A.
1800 Vevey, Switzerland

(111) M 1996 2576 R2
(156) 2016 07 05
(186) 2026 07 05

(732) DAIMLER AG
MercedeJSCtraJSCe 137, 70327 Stuttgart,
Germany

(111) M 1996 2577 R2
(156) 2016 07 05
(186) 2026 07 05

(732) DAIMLER AG
MercedeJSCtraJSCe 137, 70327 Stuttgart,
Germany

(111) M 1996 2582 R2
(156) 2016 07 08
(186) 2026 07 08

(732) GRUNENTHAL GmbH
ZieglerstraJSCe 6, D-52078 Aachen,
Germany

(111) M 1996 2587 R2
(156) 2016 07 08
(186) 2026 07 08

(732) PIONEER HI-BRED INTERNATIONAL,
INC.
7100 N.V. 62 nd Avenue, P.O. Box 1014,
Johnston, IA 50131-1014, USA

(111) M 1996 2608 R2
(156) 2016 07 12
(186) 2026 07 12

(732) VKR HOLDING A/S
Breeitevej 18, DK-2970 Horsholm, Denmark

(111) M 1996 2610 R2
 (156) 2016 07 12
 (186) 2026 07 12
 (732) ESCHMANN HOLDINGS LIMITED
 Peter Road, Lancing, West SuJSCex
 BN15 8TJ, United Kingdom

(111) M 1996 2633 R2
 (156) 2016 07 16
 (186) 2026 07 16
 (732) FIAT AUTO S.P.A.
 Corso Giovanni Agnelli 200, 10135 Torino,
 Italy

(111) M 1996 2634 R2
 (156) 2016 07 16
 (186) 2026 07 16
 (732) FIAT AUTO S.P.A.
 Corso Giovanni Agnelli 200, 10135 Torino,
 Italy

(111) M 1996 2635 R2
 (156) 2016 07 16
 (186) 2026 07 16
 (732) BROWN-FORMAN CORPORATION
 Delaware, USA

(111) M 1996 2636 R2
 (156) 2016 07 16
 (186) 2026 07 16
 (732) BROWN-FORMAN CORPORATION
 Delaware, USA

(111) M 1996 2667 R2
 (156) 2016 07 18
 (186) 2026 07 18
 (732) THE COCA-COLA COMPANY
 One Coca-Cola Plaza, Atlanta, Georgia
 30313, USA

(111) M 1996 2668 R2
 (156) 2016 07 18
 (186) 2026 07 18
 (732) THE COCA-COLA COMPANY
 One Coca-Cola Plaza, Atlanta, Georgia
 30313, USA

(111) M 1996 2669 R2
 (156) 2016 07 18
 (186) 2026 07 18
 (732) THE COCA-COLA COMPANY
 One Coca-Cola Plaza, Atlanta, Georgia
 30313, USA

(111) M 1996 2671 R2
 (156) 2016 07 18
 (186) 2026 07 18
 (732) THE COCA-COLA COMPANY
 One Coca-Cola Plaza, Atlanta, Georgia
 30313, USA

(111) M 1996 2687 R2
 (156) 2016 07 19
 (186) 2026 07 19
 (732) MERCK SHARP & DOHME CORP.
 One Merck Drive, Whitehouse Station,
 New Jersey 08889, USA

(111) M 1996 2707 R2
 (156) 2016 07 22
 (186) 2026 07 22
 (732) SEIKO HOLDINGS KABUSHIKI KAISHA
 (trading as SEIKO HOLDINGS
 CORPORATION)
 5-11, Ginza, 4-Chome, Chuo-ku, Tokyo,
 Japan

(111) M 1996 2708 R2
 (156) 2016 07 22
 (186) 2026 07 22
 (732) NIJSCAN JIDOSHA KABUSHIKI KAISHA
 (also trading as NIJSCAN MOTTOR Co., LTD)
 No. 2 Takaracho, Kanagawa-ku, Yokohama-
 shi, Kanagawa-ken, Japan

(111) M 1996 2761 R2
 (156) 2016 07 29
 (186) 2026 07 29
 (732) SAFT
 12, rue Sadi Carnot 93170 Bagnolet,
 France

(111) M 1996 2773 R2
 (156) 2016 07 29
 (186) 2026 07 29
 (732) KUWAIT PETROLEUM CORPORATION
 Safat, Kuwait

(111) M 1996 2784 R2
 (156) 2016 07 29
 (186) 2026 07 29
 (732) FANUC CORPORATION
 3850, Shibokusa Aza-Komanba, Oshino-
 Mura, Minamitsuru-Gun, Yamanashi,
 Japan

(111) M 1996 2785 R2
(156) 2016 07 30
(186) 2026 07 30
(732) FANUC CORPORATION
3850, Shibokusa Aza-Komanba, Oshino-
Mura, Minamitsuru-Gun, Yamanashi, Japan

(111) M 1996 2786 R2
(156) 2016 07 30
(186) 2026 07 30
(732) KRAFT FOODS GROUP BRANDS LLC
Three Lakes Drive, Northfield, Illinois
60093, USA

(111) M 1996 2858 R2
(156) 2016 08 22
(186) 2026 08 22
(732) L' OREAL
14 Rue Royale, 75008 Paris, France

(111) M 1996 2962 R2
(156) 2016 09 09
(186) 2026 09 09
(732) TRIUMPH INTERNATIONAL AG
80335 Munchen, DE , 80335, Germany

(111) M 1996 2963 R2
(156) 2016 09 09
(186) 2026 09 09
(732) TRIUMPH INTERNATIONAL AG
80335 Munchen, DE , 80335, Germany

(111) M 1996 2991 R2
(156) 2016 09 10
(186) 2026 09 10
(732) CARAN-D'ACHE S.A.
Geneva, Switzerland

(111) M 1996 3003 R2
(156) 2016 09 11
(186) 2026 09 11
(732) FOJSCIL GROUP, INC
901 South Central ExpreJSCway,
Richardson, Texas 75080, USA

(111) M 1996 3009 R2
(156) 2016 09 11
(186) 2026 09 11
(732) LANXEJSC DEUTSCHLAND GmbH
51369 Leverkusen, Germany

(111) M 1996 3035 R2
(156) 2016 09 12
(186) 2026 09 12
(732) CLUB MEDITERRANEE
25 Rue Vivienne, 75002 PARIS, France

(111) M 1996 3049 R2
(156) 2016 09 12
(186) 2026 09 12
(732) Philip Morris Brands SARL
Quai Jeanrenaud 3, 2000 Neuchâtel,
Switzerland

(111) M 1996 3061 R2
(156) 2016 09 13
(186) 2026 09 13
(732) KIKKOMAN CORPORATION
250, Noda, Noda City, Chiba, Japan

(111) M 1996 3066 R2
(156) 2016 09 13
(186) 2026 09 13
(732) KELLOGG COMPANY
One Kellogg Square, P.O. Box 3599
Battle Creek, Michigan 49016-3599, USA

(111) M 1996 3067 R2
(156) 2016 09 13
(186) 2026 09 13
(732) KELLOGG COMPANY
One Kellogg Square, P.O. Box 3599
Battle Creek, Michigan 49016-3599, USA

(111) M 1996 3068 R2
(156) 2016 09 13
(186) 2026 09 13
(732) KELLOGG COMPANY
One Kellogg Square, P.O. Box 3599
Battle Creek, Michigan 49016-3599, USA

(111) M 1996 3069 R2
(156) 2016 09 13
(186) 2026 09 13
(732) KELLOGG COMPANY
One Kellogg Square, P.O. Box 3599
Battle Creek, Michigan 49016-3599, USA

(111) M 1996 3131 R2
(156) 2016 09 16
(186) 2026 09 16
(732) PIAGGIO & C. S.P.A.
Viale Rinaldo Piaggio, 25, Pontedera (Pisa),
Italy

(111) M 1996 3134 R2
(156) 2016 09 16
(186) 2026 09 16
(732) TRW INTELLECTUAL PROPERTY
CORP., a Michigan corporation
12025 Tech Center Drive, Livonia,
Michigan 48150, USA

(111) M 1996 3135 R2
(156) 2016 09 16
(186) 2026 09 16
(732) TRW INTELLECTUAL PROPERTY
CORP., a Michigan corporation
12025 Tech Center Drive, Livonia,
Michigan 48150, USA

(111) M 1996 3136 R2
(156) 2016 09 16
(186) 2026 09 16
(732) TRW INTELLECTUAL PROPERTY
CORP., a Michigan corporation
12025 Tech Center Drive, Livonia,
Michigan 48150, USA

(111) M 1996 3150 R2
(156) 2016 09 17
(186) 2026 09 17
(732) THE PROCTER & GAMBLE COMPANY
One Procter & Gamble Plaza, Cincinnati,
Ohio, USA

(111) M 1996 3180 R2
(156) 2016 09 17
(186) 2026 09 17
(732) SUMITOMO CHEMICAL CO., LTD
27-1, Shinkawa 2-chome, Chuo-ku, Tokyo
104-8260, Japan

(111) M 1996 3234 R2
(156) 2016 09 19
(186) 2026 09 19
(732) SOCIETE BIC
14 rue Jeanne d'Asnieres, 92110 Clichy,
France

(111) M 1996 3235 R2
(156) 2016 09 19
(186) 2026 09 19
(732) SOCIETE BIC
14 rue Jeanne d'Asnieres, 92110 Clichy,
France

(111) M 1996 3236 R2
(156) 2016 09 19
(186) 2026 09 19
(732) SOCIETE BIC
14 rue Jeanne d'Asnieres, 92110 Clichy,
France

(111) M 1996 3244 R2
(156) 2016 09 20
(186) 2026 09 20
(732) AMERICAN DAIRY QUEEN
CORPORATION
7505 Metro Boulevard Edina, Minnesota
55439-0286, USA

(111) M 1996 3273 R2
(156) 2016 09 23
(186) 2026 09 23
(732) TRIUMPH INTERNATIONAL AG
80335 Munchen, DE , 80335, Germany

(111) M 1996 3281 R2
(156) 2016 09 23
(186) 2026 09 23
(732) TRIUMPH INTERTRADE AG
Triumphweg 6, 5330 Bad Zurzach,
Switzerland

(111) M 1996 3283 R2
(156) 2016 09 23
(186) 2026 09 23
(732) TRIUMPH INTERTRADE AG
Triumphweg 6, 5330 Bad Zurzach,
Switzerland

(111) M 1996 3306 R2
(156) 2016 09 24
(186) 2026 09 24
(732) BRANDBREW S.A.
5, rue Gabriel Lippmann, 5365 Munsbach,
Luxembourg

(111) M 1996 3341 R2
(156) 2016 09 25
(186) 2026 09 25
(732) DENKAVIT INTERNATIONAAL B.V.
Tolnegeweg 65,3781 PV Voorthuizen,
Netherlands

(111) M 1996 3451 R2
(156) 2016 09 30
(186) 2026 09 30

(732) TETRA LAVAL HOLDINGS & FINANCE
S.A.
Avenue General-Giusan 70, CH-1009 Pully,
Switzerland

(111) M 1996 3462 R2

(156) 2016 10 02

(186) 2026 10 02

(732) OMEGA PHARMA INNOVATION &
DEVELOPMENT NV
Venecoweg 26, 9810 Nazareth, Belgium

(111) M 1996 3471 R2

(156) 2016 10 02

(186) 2026 10 02

(732) STANLEY BLACK & DECKER, INC.
1000 Stanley Drive, New Britain,
Connecticut 06053, USA

(111) M 1996 3511 R2

(156) 2016 10 08

(186) 2026 10 08

(732) CONSITEX S.A.
Via-Ligornetto 13, 6855 Stabio, Switzerland

(111) M 1996 3514 R2

(156) 2016 10 08

(186) 2026 10 08

(732) LANIFICIO ERMENEGILDO ZEGNA &
FIGLI S.P.A.
13835 Trivero, Biella, Italy

(111) M 1996 3514P R2

(156) 2016 10 08

(186) 2026 10 08

(732) CONSITEX S.A.
Via-Ligornetto 13, 6855 Stabio, Switzerland

(111) M 1996 3584 R2

(156) 2016 10 10

(186) 2026 10 10

(732) ADVANCE MAGAZINE PUBLISHERS
INC.
Four Times Square, New York, New York
10036, USA

(111) M 1996 3585 R2

(156) 2016 10 10

(186) 2026 10 10

(732) ADVANCE MAGAZINE PUBLISHERS INC.
Four Times Square, New York, New York
10036, USA

(111) M 1996 3586 R2

(156) 2016 10 10

(186) 2026 10 10

(732) ADVANCE MAGAZINE PUBLISHERS INC.
Four Times Square, New York, New York
10036, USA

(111) M 1996 3588 R2

(156) 2016 10 10

(186) 2026 10 10

(732) BEST WESTERN INTERNATIONAL INC.
Arizona, USA

(111) M 1996 3625 R2

(156) 2016 10 16

(186) 2026 10 16

(732) TRIUMPH INTERTRADE AG
Triumphweg 6, 5330 Bad Zurzach,
Switzerland

(111) M 1996 3661 R2

(156) 2016 10 17

(186) 2026 10 17

(732) OPTREX LIMITED;
103-105 Bath Road, Stough, Berkshire, SL1
3UH, United Kingdom

(111) M 1996 3667 R2

(156) 2016 10 23

(186) 2026 10 23

(732) PHILIP MORRIS BRANDS SARL
Quai Jeanrenaud 3, 2000 Neuchâtel,
Switzerland

(111) M 1996 3669 R2

(156) 2016 10 23

(186) 2026 10 23

(732) PHILIP MORRIS BRANDS SARL
Quai Jeanrenaud 3, 2000 Neuchâtel,
Switzerland

(111) M 1996 3670 R2

(156) 2016 10 23

(186) 2026 10 23

(732) PHILIP MORRIS BRANDS SARL
Quai Jeanrenaud 3, 2000 Neuchâtel,
Switzerland

(111) M 1996 3671 R2

(156) 2016 10 23

(186) 2026 10 23

(732) PHILIP MORRIS BRANDS SARL

Quai Jeanrenaud 3, 2000 Neuchâtel,
Switzerland

(111) M 1996 3727 R2
(156) 2016 10 29
(186) 2026 10 29
(732) THE DOW CHEMICAL COMPANY
a Delaware Corporation
Midland, Michigan 48674, USA

(111) M 1996 3766 R2
(156) 2016 10 30
(186) 2026 10 30
(732) PHILIP MORRIS PRODUCTS S.A.
Quai Jeanrenaud 3, 2000 NEUCHATEL,
Switzerland

(111) M 1996 3767 R2
(156) 2016 10 30
(186) 2026 10 30
(732) PHILIP MORRIS BRANDS SARL
Quai Jeanrenaud 3, 2000 Neuchâtel,
Switzerland

(111) M 1996 3916 R2
(156) 2016 11 11
(186) 2026 11 11
(732) BLUE CROJSC AND BLUE SCHIELD
AJSCOCIATION
225 North Michigan Avenue, Chicago,
Illinois 60601, USA

(111) M 1996 4026 R2
(156) 2016 11 18
(186) 2026 11 18
(732) TRIUMPH INTERNATIONAL AG
80335 Munchen, DE , 80335, Germany

(111) M 1996 4154 R2
(156) 2016 12 05
(186) 2026 12 05
(732) WOLVERINE WORLD WIDE INC.
9341 COURTLAND DR. N.E. ROCKFORD,
MICHIGAN 49351, USA

(111) M 1996 4241 R2
(156) 2016 12 18
(186) 2026 12 18
(732) BRITISH AMERICAN TOBACCO
(BRANDS) INC.
2711 Centerville Road, Suite 300,
Wilmington, Delaware 19808, USA

(111) M 1997 4580 R4
(156) 2037 02 07
(186) 2027 02 07
(732) BURBERRY LIMITED
Horseferry House, Horseferry Road, London
SW1P 2AW, United Kingdom

COMPLETE TRANSFER OF RIGHTS

(111) M 2010 020756 R
(732) TRAVELPORT INTERNATIONAL
OPERATIONS LIMITED
Axis One, Axis Park, 10 Hurricane way,
Langley, Berkshire, SL3 8AG, United
Kingdom
(770) GALILEO INTERNATIONAL
TECHNOLOGI LLC
Ground Floor, ICB Building, Roebuck
Street, Bridgetown, Barbados, USA
(580) 2016 06 29

(111) M 2012 022863 R
(732) GR SWIISC JV, LLC
41-550 Eclectic Street, Suite 200, Palm
Desert, California 92260, USA
(770) GUTHY-RENKER LLC
41-550 Eclectic Street, Suite 200, Palm
Desert, California 92260, USA
(580) 2016 06 29

CHANGES IN NAMES AND/OR ADDRESSES OF OWNERS

(111) M 1996 001876 R2
 (732) MEDA Pharma GmbH & Co. KG
 BenzstraJSCe 1, 61352 Bad Homburg,
 Germany
 (770) VIATRIS GMBH & CO. KG
 BenzstraJSCe 1, D-61352 Bad Homburg,
 Germany
 (580) 2016 06 24

(111) M 1996 001883 R2
 (732) MEDA Pharma GmbH & Co. KG
 BenzstraJSCe 1, 61352 Bad Homburg,
 Germany
 (770) VIATRIS GMBH & CO. KG
 BenzstraJSCe 1, D-61352 Bad Homburg,
 Germany
 (580) 2016 06 24

(111) M 1996 001885 R2
 (732) MEDA Pharma GmbH & Co. KG
 BenzstraJSCe 1, 61352 Bad Homburg,
 Germany
 (770) VIATRIS GMBH & CO. KG
 BenzstraJSCe 1, D-61352 Bad Homburg,
 Germany
 (580) 2016 06 24

(111) M 1996 002043 R2
 (732) TECHNICOLOR USA, INC.
 101 W. 103rd Street, Indianapolis, indiana
 46290, USA
 (770) THOMSON INC.
 10330 N. Meridian Street, Indianapolis, IN
 46290, USA
 (580) 2016 06 24

(111) M 1996 002259 R2
 (732) FMC TECHNOLOGIES, INC.
 5875 North Sam Houston Parkway, West,
 Houston, Texas 77986, USA
 (770) FMC TECHNOLOGIES, INC.
 1803 Gears Road, Houston, Texas 77076,
 USA
 (580) 2016 06 24

(111) M 1996 002784 R2
 (732) FANUC CORPORATION
 3850, Shibokusa Aza-Komanba, Oshino-
 Mura, Minamitsuru-Gun, Yamanashi,
 Japan

(770) FANUC LTD
 3850, Shibokusa Aza-Komanda, Oshino-
 Mura, Minamitsuru-Gun, Yamanashi, Japan
 (580) 2016 06 24

(111) M 1996 002785 R2
 (732) FANUC CORPORATION
 3850, Shibokusa Aza-Komanba, Oshino-
 Mura, Minamitsuru-Gun, Yamanashi, Japan
 (770) FANUC LTD
 3850, Shibokusa Aza-Komanda, Oshino-
 Mura, Minamitsuru-Gun, Yamanashi, Japan
 (580) 2016 06 24

(111) M 2012 022396 R
 (732) LTD "BADAGONI"
 Sop. Zemo Khodasheni, 0910, Akhmetis
 raioni, Georgia
 (770) LTD "BADAGONI"
 Tavisuplebis moedani 4, 0105, Tbilisi,
 Georgia
 (580) 2016 06 24

CLASSIFICATION INDEXES

INVENTIONS

CONCORDANCE TABLE OF INTERNATIONAL CLASSIFICATION INDEX AND PUBLICATION NUMBERS

INTERNATIONAL CLASSIFICATION INDEXES (51)	NUMBER OF PUBLISHED APPLICATION (10)
A 21 D 8/02; A 21 D 13/04	AP 2016 13719 A
A 23 L 1/28	AP 2016 13553 A
A 61 B 17/32; A 61 B 17/34; A 61 F 2/10	AP 2016 13778 A
A 61 K 31/167; A 61 K 31/36; A 61 K 31/366; A 61 K 31/381; A 61 K 31/40; A 61 K 31/402; A 61 K 31/4035; A 61 K 31/404; A 61 K 31/4184; A 61 K 31/42; A 61 K 31/421; A 61 K 31/426; A 61 K 31/428; A 61 K 31/429; A 61 K 31/433; A 61 K 31/4406; A 61 K 31/4409; A 61 K 31/4453; A 61 K 31/4468; A 61 K 31/495; A 61 K 31/55; A 61 P 35/00; A 61 P 35/02; C 07 C 233/80; C 07 C 235/56; C 07 C 237/40; C 07 C 271/22; C 07 D 207/06; C 07 D 207/337; C 07 D 209/08; C 07 D 209/42; C 07 D 209/46; C 07 D 211/76; C 07 D 213/04; C 07 D 213/38; C 07 D 213/56; C 07 D 223/16; C 07 D 231/14; C 07 D 231/20; C 07 D 231/22; C 07 D 231/56; C 07 D 233/61; C 07 D 233/64; C 07 D 239/36; C 07 D 261/08; C 07 D 263/32; C 07 D 263/34; C 07 D 277/62; C 07 D 277/20; C 07 D 277/28; C 07 D 277/30; C 07 D 285/06; C 07 D 295/14; C 07 D 309/14; C 07 D 317/58; C 07 D 333/20; C 07 D 405/04; C 07 D 409/04; C 07 D 471/04; C 07 D 495/04; C 07 D 513/04	AP 2016 13405 A
A 62 C 2/06; E 21 F 43/12	AP 2016 13724 A
B 61 B 12/00; E 01 D 19/04	AP 2016 13827 A
C 07 D 491/08; C 07 D 491/18; C 07 D 498/08; C 07 D 498/18; C 07 D 498/22; C 07 D 513/18; A 61 K 31/4353; A 61 P 35/00	AP 2016 13564 A
H 02 P 9/00	AP 2016 13658 A

CONCORDANCE TABLE OF PUBLICATION NUMBERS AND INTERNATIONAL CLASSIFICATION INDEX

NUMBER OF PUBLISHED APPLICATION (10)	INTERNATIONAL CLASSIFICATION INDEXES (51)
1	2
AP 2016 13405 A	A 61 K 31/167; A 61 K 31/36; A 61 K 31/366; A 61 K 31/381; A 61 K 31/40; A 61 K 31/402; A 61 K 31/4035; A 61 K 31/404; A 61 K 31/4184; A 61 K 31/42; A 61 K 31/421; A 61 K 31/426; A 61 K 31/428; A 61 K 31/429; A 61 K 31/433; A 61 K 31/4406; A 61 K 31/4409; A 61 K 31/4453; A 61 K 31/4468; A 61 K 31/495; A 61 K 31/55; A 61 P 35/00; A 61 P 35/02; C 07 C 233/80; C 07 C 235/56; C 07 C 237/40; C 07 C 271/22; C 07 D 207/06; C 07 D 207/337; C 07 D 209/08; C 07 D 209/42; C 07 D 209/46; C 07 D 211/76; C 07 D 213/04; C 07 D 213/38; C 07 D 213/56; C 07 D 223/16; C 07 D 231/14; C 07 D 231/20; C 07 D 231/22; C 07 D 231/56; C 07 D 233/61; C 07 D 233/64; C 07 D 239/36; C 07 D 261/08; C 07 D 263/32; C 07 D 263/34; C 07 D 277/62; C 07 D 277/20; C 07 D 277/28; C 07 D 277/30; C 07 D 285/06; C 07 D 295/14; C 07 D 309/14; C 07 D 317/58; C 07 D 333/20; C 07 D 405/04; C 07 D 409/04; C 07 D 471/04; C 07 D 495/04; C 07 D 513/04

1	2
AP 2016 13553 A	A 23 L 1/28
AP 2016 13564 A	C 07 D 491/08; C 07 D 491/18; C 07 D 498/08; C 07 D 498/18; C 07 D 498/22; C 07 D 513/18; A 61 K 31/4353; A 61 P 35/00
AP 2016 13658 A	H 02 P 9/00
AP 2016 13719 A	A 21 D 8/02; A 21 D 13/04
AP 2016 13724 A	A 62 C 2/06; E 21 F 43/12
AP 2016 13778 A	A 61 B 17/32; A 61 B 17/34; A 61 F 2/10
AP 2016 13827 A	B 61 B 12/00; E 01 D 19/04

**CONCORDANCE TABLE OF INTERNATIONAL CLASSIFICATION INDEX,
PATENT NUMBERS AND PUBLICATION NUMBERS**

INTERNATIONAL CLASSIFICATION INDEX (51)	NUMBER OF PATENT (11)	NUMBER OF PUBLISHED APPLICATION (10)
A 01 N 43/42; A 61 K 31/47	P 2016 6506 B	AP 2016 12786 A
B 01 D 3/02; C 12 G 3/12	P 2016 6511 B	AP 2016 13559 A
B 29 D 7/24; B 29 C 55/10	P 2016 6509 B	AP 2016 13456 A
C 03 C 1/00; C 03 C 1/02; C 03 C 13/06	P 2016 6508 B	AP 2016 13169 A
C 07 D 471/04; C 07 D 473/28; C 07 D 487/04; C 07 D 498/04; A 61 K 31/4355; A 61 K 31/437; A 61 K 31/4427; A 61 K 31/4985; A 61 K 31/5025; A 61 K 31/519; A 61 K 31/52; A 61 P 25/18	P 2016 6507 B	AP 2016 12970 A
C 08 J 11/04; C 08 J 11/06; B 29 B 17/00; B 29 B 17/02; B 29 B 17/04; B 29 B 7/88; B 29 B 7/90; B 29 C 47/10	P 2016 6510 B	AP 2016 13484 A
C 23 C 14/35	P 2016 6512 B	AP 2016 13835 A

**CONCORDANCE TABLE OF PATENT NUMBERS,
PUBLICATION NUMBERS AND INTERNATIONAL CLASSIFICATION INDEX**

NUMBER OF PATENT (11)	NUMBER OF PUBLISHED APPLICATION (10)	INTERNATIONAL CLASSIFICATION INDEX (51)
P 2016 6506 B	AP 2016 12786 A	A 01 N 43/42; A 61 K 31/47
P 2016 6507 B	AP 2016 12970 A	C 07 D 471/04; C 07 D 473/28; C 07 D 487/04; C 07 D 498/04; A 61 K 31/4355; A 61 K 31/437; A 61 K 31/4427; A 61 K 31/4985; A 61 K 31/5025; A 61 K 31/519; A 61 K 31/52; A 61 P 25/18
P 2016 6508 B	AP 2016 13169 A	C 03 C 1/00; C 03 C 1/02; C 03 C 13/06
P 2016 6509 B	AP 2016 13456 A	B 29 D 7/24; B 29 C 55/10
P 2016 6510 B	AP 2016 13484 A	C 08 J 11/04; C 08 J 11/06; B 29 B 17/00; B 29 B 17/02; B 29 B 17/04; B 29 B 7/88; B 29 B 7/90; B 29 C 47/10
P 2016 6511 B	AP 2016 13559 A	B 01 D 3/02; C 12 G 3/12
P 2016 6512 B	AP 2016 13835 A	C 23 C 14/35

**CONCORDANCE TABLE OF APPLICATION NUMBERS, PUBLICATION NUMBERS
AND PATENTS**

NUMBER OF APPLICATION (21)	NUMBER OF PUBLISHED APPLICATION (10)	NUMBER OF PATENT (11)
AP 2010 012786	AP 2016 12786 A	P 2016 6506 B
AP 2011 012970	AP 2016 12970 A	P 2016 6507 B
AP 2011 013169	AP 2016 13169 A	P 2016 6508 B
AP 2014 013456	AP 2016 13456 A	P 2016 6509 B
AP 2011 013484	AP 2016 13484 A	P 2016 6510 B
AP 2014 013559	AP 2016 13559 A	P 2016 6511 B
AP 2015 013835	AP 2016 13835 A	P 2016 6512 B

UTILITY MODELS

**CONCORDANCE TABLE OF INTERNATIONAL CLASSIFICATION INDEX,
PATENT NUMBERS AND PUBLICATION NUMBERS**

INTERNATIONAL CLASSIFICATION INDEX (51)	NUMBER OF PATENT (11)	NUMBER OF PUBLISHED APPLICATION (10)
A 47 G 21/00	U 2016 1902 Y	AU 2016 13897 U
C 25 B 11/02	U 2016 1900 Y	AU 2016 13773 U
E 04 B 2/42	U 2016 1901 Y	AU 2016 13834 U

**CONCORDANCE TABLE OF PATENT NUMBERS,
PUBLICATION NUMBERS AND INTERNATIONAL CLASSIFICATION INDEX**

NUMBER OF PATENT (11)	NUMBER OF PUBLISHED APPLICATION (10)	INTERNATIONAL CLASSIFICATION INDEX (51)
U 2016 1900 Y	AU 2016 13773 U	C 25 B 11/02
U 2016 1901 Y	AU 2016 13834 U	E 04 B 2/42
U 2016 1902 Y	AU 2016 13897 U	A 47 G 21/00

**CONCORDANCE TABLE OF APPLICATION NUMBERS, PUBLICATION NUMBERS
AND PATENTS**

NUMBER OF APPLICATION (21)	NUMBER OF PUBLISHED APPLICATION (10)	NUMBER OF PATENT (11)
AU 2015 013773	AU 2016 13773 U	U 2016 1900 Y
AU 2015 013834	AU 2016 13834 U	U 2016 1901 Y
AU 2015 013897	AU 2016 13897 U	U 2016 1902 Y

DESIGNS**DESIGN REGISTERED ACCORDING TO THE
ACCELERATED PROCEDURE****CONCORDANCE TABLE OF INTERNATIONAL CLASSIFICATION INDEX
AND PATENTS NUMBERS**

INTERNATIONAL CLASSIFICATION INDEX (51)	NUMBER OF PATENT (11)
32-00	D 2016 683 S

**CONCORDANCE TABLE OF PATENT NUMBERS AND INTERNATIONAL
CLASSIFICATION INDEX**

NUMBER OF PATENT (11)	INTERNATIONAL CLASSIFICATION INDEX (51)
D 2016 683 S	32-00

**CONCORDANCE TABLE OF APPLICATION NUMBERS
AND PATENT NUMBERS**

NUMBER OF APPLICATION (21)	NUMBER OF PATENT (11)
AD 2016 000912	D 2016 683 S

TRADEMARKS

CONCORDANCE TABLE OF REGISTRATION NUMBERS, APPLICATION NUMBERS, PUBLICATION NUMBERS AND BULLETIN NUMBERS

NUMBER OF REGISTRATION (111)	NUMBER OF APPLICATIONS (210)	NUMBER OF PUBLISHED APPLICATIONS (260)	NUMBER OF BULLETIN
1	2	3	4
M 2016 27210 R	AM 87582	-	13(449)2016
M 2016 27211 R	AM 77482	AM 2015 77482 A	5(417)2015
M 2016 27212 R	AM 78169	AM 2016 78169 A	3(439)2016
M 2016 27213 R	AM 78233	AM 2015 78233 A	23(435)2015
M 2016 27214 R	AM 78904	AM 2015 78904 A	22(434)2015
M 2016 27215 R	AM 79048	AM 2015 79048 A	22(434)2015
M 2016 27216 R	AM 79268	AM 2015 79268 A	21(433)2015
M 2016 27217 R	AM 79775	AM 2016 79775 A	4(440)2016
M 2016 27218 R	AM 79777	AM 2016 79777 A	4(440)2016
M 2016 27219 R	AM 79780	AM 2016 79780 A	4(440)2016
M 2016 27220 R	AM 79781	AM 2016 79781 A	4(440)2016
M 2016 27221 R	AM 79782	AM 2016 79782 A	4(440)2016
M 2016 27222 R	AM 79783	AM 2016 79783 A	4(440)2016
M 2016 27223 R	AM 79982	AM 2016 79982 A	4 440)2016
M 2016 27224 R	AM 79984	AM 2015 79984 A	22(434)2015
M 2016 27225 R	AM 80020	AM 2016 80020 A	5(441)2016
M 2016 27226 R	AM 80212	AM 2016 80212 A	4(440)2016
M 2016 27227 R	AM 80380	AM 2015 80380 A	24(436)2015
M 2016 27228 R	AM 80489	AM 2015 80489 A	20(432)2015
M 2016 27229 R	AM 80609	AM 2015 80609 A	24(436)2015
M 2016 27230 R	AM 80621	AM 2015 80621 A	24(436)2015
M 2016 27231 R	AM 80676	AM 2016 80676 A	4(440)2016
M 2016 27232 R	AM 80928	AM 2015 80928 A	21(433)2015
M 2016 27233 R	AM 81026	AM 2015 81026 A	21(433)2015
M 2016 27234 R	AM 81035	AM 2016 81035 A	3(439)2016
M 2016 27235 R	AM 81043	AM 2015 81043 A	24(436)2015
M 2016 27236 R	AM 81061	AM 2015 81061 A	24(436)2015
M 2016 27237 R	AM 81253	AM 2015 81253 A	23(435)2015
M 2016 27238 R	AM 81305	AM 2015 81305 A	23(435)2015
M 2016 27239 R	AM 81313	AM 2015 81313 A	24(436)2015
M 2016 27240 R	AM 81396	AM 2015 81396 A	1(437)2016
M 2016 27341 R	AM 87566	-	13(449)2016
M 2016 2734 2 R	AM 87570	-	13(449)2016
M 2016 2734 3 R	AM 87573	-	13(449)2016
M 2016 27244 R	AM 81419	AM 2016 81419 A	3(439) 2016
M 2016 27245 R	AM 81439	AM 2015 81439 A	1(437)2016
M 2016 27246 R	AM 81475	AM 2015 81475 A	1(437)2016
M 2016 27247 R	AM 81625	AM 2016 81625 A	4(440)2016
M 2016 27248 R	AM 81735	AM 2016 81735 A	3(439)2016
M 2016 27249 R	AM 81930	AM 2015 81930 A	24(436)2015
M 2016 27250 R	AM 81969	AM 2016 81969 A	4(440)2016
M 2016 27251 R	AM 81985	AM 2016 81985 A	4(440)2016
M 2016 27252 R	AM 81986	AM 2016 81986 A	4(440)2016
M 2016 27253 R	AM 81993	AM 2016 81993 A	4(440)2016
M 2016 27254 R	AM 81994	AM 2016 81994 A	4(440)2016
M 2016 27255 R	AM 81999	AM 2016 81999 A	4(440)2016

1	2	3	4
M 2016 27256 R	AM 82030	AM 2016 82030 A	2(438)2016
M 2016 27257 R	AM 82034	AM 2016 82034 A	2(438)2016
M 2016 27258 R	AM 82061	AM 2016 82061 A	3(439)2016
M 2016 27259 R	AM 82062	AM 2016 82062 A	3(439)2016
M 2016 27260 R	AM 82063	AM 2016 82063 A	3(439)2016
M 2016 27261 R	AM 82064	AM 2016 82064 A	3(439)2016
M 2016 27262 R	AM 82118	AM 2016 82118 A	5(441)2016
M 2016 27263 R	AM 82134	AM 2016 82134 A	5(441)2016
M 2016 27264 R	AM 82218	AM 2016 82218 A	4(440)2016
M 2016 27268 R	AM 82229	AM 2016 82229 A	2(438)2016
M 2016 27269 R	AM 82251	AM 2016 82251 A	4(440)2016
M 2016 27270 R	AM 82252	AM 2016 82252 A	4(440)2016
M 2016 27271 R	AM 82254	AM 2016 82254 A	4(440)2016
M 2016 27272 R	AM 82255	AM 2016 82255 A	4(440)2016
M 2016 27273 R	AM 82259	AM 2016 82259 A	5(441)2016
M 2016 27274 R	AM 82282	AM 2016 82282 A	4(440)2016
M 2016 27275 R	AM 82345	AM 2016 82345 A	5(441)2016
M 2016 27276 R	AM 82357	AM 2016 82357 A	5(441)2016
M 2016 27277 R	AM 82390	AM 2016 82390 A	4(440)2016
M 2016 27278 R	AM 82391	AM 2016 82391 A	4(440)2016
M 2016 27279 R	AM 82434	AM 2016 82434 A	3(439)2016
M 2016 27280 R	AM 82435	AM 2016 82435 A	3(439)2016
M 2016 27281 R	AM 82439	AM 2016 82439 A	5(441)2016
M 2016 27282 R	AM 82440	AM 2016 82440 A	5(441)2016
M 2016 27283 R	AM 82441	AM 2016 82441 A	5(441)2016
M 2016 27284 R	AM 82442	AM 2016 82442 A	5(441)2016
M 2016 27285 R	AM 82444	AM 2016 82444 A	5(441)2016
M 2016 27286 R	AM 82445	AM 2016 82445 A	5(441)2016
M 2016 27287 R	AM 82493	AM 2016 82493 A	3(439)2016
M 2016 27288 R	AM 82547	AM 2016 82547 A	5(441)2016
M 2016 27289 R	AM 82548	AM 2016 82548 A	4(440)2016
M 2016 27290 R	AM 82549	AM 2016 82549 A	4(440)2016
M 2016 27291 R	AM 82566	AM 2016 82566 A	3(439)2016
M 2016 27292 R	AM 82569	AM 2016 82569 A	3(439)2016
M 2016 27293 R	AM 82614	AM 2016 82614 A	5(441)2016
M 2016 27294 R	AM 82615	AM 2016 82615 A	5(441)2016
M 2016 27295 R	AM 82633	AM 2016 82633 A	5(441)2016
M 2016 27296 R	AM 82636	AM 2016 82636 A	5(441)2016
M 2016 27297 R	AM 82676	AM 2016 82676 A	5(441)2016
M 2016 27298 R	AM 82677	AM 2016 82677 A	5(441)2016
M 2016 27299 R	AM 82678	AM 2016 82678 A	5(441)2016
M 2016 27300 R	AM 82679	AM 2016 82679 A	4(440)2016
M 2016 27301 R	AM 82822	AM 2016 82822 A	5(441)2016
M 2016 27302 R	AM 82823	AM 2016 82823 A	4(440)2016
M 2016 27303 R	AM 82824	AM 2016 82824 A	4(440)2016
M 2016 27304 R	AM 82825	AM 2016 82825 A	4(440)2016
M 2016 27305 R	AM 82965	AM 2016 82965 A	5(441)2016
M 2016 27306 R	AM 83243	AM 2016 83243 A	5(441)2016
M 2016 27307 R	AM 83383	AM 2016 83383 A	5(441)2016
M 2016 27308 R	AM 83464	AM 2016 83464 A	5(441)2016
M 2016 27309 R	AM 83485	AM 2016 83485 A	5(441)2016
M 2016 27310 R	AM 83512	AM 2016 83512 A	5(441)2016
M 2016 27311 R	AM 86909	-	13(449)2016
M 2016 27312 R	AM 87584	-	13(449)2016
M 2016 27313 R	AM 87627	-	13(449)2016
M 2016 27314 R	AM 87684	-	13(449)2016

**CONCORDANCE TABLE OF PUBLICATION NUMBERS
AND APPLICATION NUMBERS**

NUMBER OF PUBLISHED APPLICATION (260)	NUMBER OF APPLICATION (210)	1	2
1	2		
AM 2016 71960 A **	AM 71960 A **	AM 2016 84427 A	AM 84427 A
AM 2016 79686 A*	AM 79686 A*	AM 2016 84429 A	AM 84429 A
AM 2016 81347 A*	AM 81347 A*	AM 2016 84574 A	AM 84574 A
AM 2016 81987 A*	AM 81987 A*	AM 2016 84613 A	AM 84613 A
AM 2016 80913 A	AM 80913 A	AM 2016 84624 A	AM 84624 A
AM 2016 82659 A	AM 82659 A	AM 2016 84626 A	AM 84626 A
AM 2016 83543 A	AM 83543 A	AM 2016 84672 A	AM 84672 A
AM 2016 83859 A	AM 83859 A	AM 2016 84680 A	AM 84680 A
AM 2016 84090 A	AM 84090 A	AM 2016 84700 A	AM 84700 A
AM 2016 84152 A	AM 84152 A	AM 2016 84701 A	AM 84701 A
AM 2016 84161 A	AM 84161 A	AM 2016 84702 A	AM 84702 A
AM 2016 84169 A	AM 84169 A	AM 2016 84793 A	AM 84793 A
AM 2016 84176 A	AM 84176 A	AM 2016 84800 A	AM 84800 A
AM 2016 84207 A	AM 84207 A	AM 2016 84802 A	AM 84802 A
AM 2016 84208 A	AM 84208 A	AM 2016 84930 A	AM 84930 A
AM 2016 84258 A	AM 84258 A	AM 2016 84986 A	AM 84986 A
AM 2016 84390 A	AM 84390 A	AM 2016 84989 A	AM 84989 A
		AM 2016 84990 A	AM 84990 A
		AM 2016 85113 A	AM 85113 A
		AM 2016 85114 A	AM 85114 A
		AM 2016 85229 A	AM 85229 A
		AM 2016 85230 A	AM 85230 A

**CONCORDANCE TABLE OF INDEX OF GOODS AND/OR SERVICES
AND APPLICATION NUMBERS**

INDEX OF GOODS AND/OR SERVICES (511)	NUMBER OF PUBLISHED APPLICATIONS (260)	1	2
1	2		
3	AM 2016 82659 A	25	AM 2016 84208 A
3	AM 2016 84176 A	29	AM 2016 81347 A*
3	AM 2016 84800 A	29	AM 2016 84169 A
5	AM 2016 84429 A	29	AM 2016 84429 A
5	AM 2016 84700 A	30	AM 2016 84429 A
5	AM 2016 84701 A	30	AM 2016 84802 A
5	AM 2016 84702 A	33	AM 2016 81987 A*
5	AM 2016 85229 A	33	AM 2016 84090 A
5	AM 2016 85230 A	33	AM 2016 84624 A
9	AM 2016 84672 A	33	AM 2016 84626 A
9	AM 2016 84930 A	33	AM 2016 84680 A
10	AM 2016 80913 A	33	AM 2016 84990 A
10	AM 2016 84390 A	34	AM 2016 79686 A*
12	AM 2016 84258 A	34	AM 2016 83859 A
12	AM 2016 84793 A	34	AM 2016 84986 A
16	AM 2016 71960 A **	34	AM 2016 84989 A
19	AM 2016 84427 A	34	AM 2016 85113 A
25	AM 2016 84207 A	34	AM 2016 85114 A
		35	AM 2016 82659 A
		35	AM 2016 83543 A
		35	AM 2016 84207 A
		35	AM 2016 84208 A
		35	AM 2016 84427 A

1	2	1	2
35	AM 2016 84574 A	38	AM 2016 84930 A
35	AM 2016 84930 A	41	AM 2016 84672 A
36	AM 2016 71960 A **	42	AM 2016 84930 A
37	AM 2016 84613 A	43	AM 2016 84152 A
38	AM 2016 71960 A **	43	AM 2016 84161 A
38	AM 2016 84613 A	44	AM 2016 83543 A

**CONCORDANCE TABLE OF INDEX OF GOODS AND/OR SERVICES
AND NUMBERS OF TRADEMARKS REGISTERED ACCORDING
TO THE ACCELERATED PROCEDURE**

INDEX OF GOODS AND/OR SERVICES (511)	NUMBERS OF REGISTERED ACCORDING TO THE ACCELERATED PROCEDURE (111)
5	M 2016 27242 R
5	M 2016 27243 R
5	M 2016 27266 R
16	M 2016 27265 R
16	M 2016 27267 R
24	M 2016 27267 R
33	M 2016 27241 R
33	M 2016 27311 R
33	M 2016 27314 R
34	M 2016 27210 R
36	M 2016 27312 R
36	M 2016 27313 R

OFFICIAL BULLETIN OF THE INDUSTRIAL PROPERTY

13(449)

EDITOR-IN-CHIEF: N. Bebrishvili

EDITORS-TRANSLATORS: E. Gabunia

PROOFREADER: A. Shikhashvili

COMPUTER LAYOUT: M. Ordenidze
K. Svanidze

www.sakpatenti.org.ge

E-mail: info@sakpatenti.org.ge