

სამრეწველო საკუთრების ოფიციალური ბიულეტენი

გამოგონებები

სასარგებლო მოდელები

დიზაინები

სასაქონლო ნიშნები



საქართველოს ინტელექტუალური
საკუთრების ეროვნული ცენტრი

საქპატენტი

SAKPATENTI

NATIONAL INTELLECTUAL PROPERTY
CENTER OF GEORGIA

www.sakpatenti.gov.ge

14(617)

საერთაშორისო კოდები გიზლიობრაფიული მონაცემების იდენტიფიკაციისათვის

გამომონებები, სასარგებლო მოდელები

- (10) - ექსპერტიზაგაეული განაცხადის გამოქვეყნების ნომერი/ განაცხადის გამოქვეყნების ნომერი***
- (11) - პატენტის ნომერი/ პატენტის ნომერი*** რეგისტრირებული სასარგებლო მოდელების ნომერი***
- (21) - განაცხადის ნომერი
- (22) - განაცხადის შეტანის თარიღი
- (23) - საგამოფენო პრიორიტეტის თარიღი
- (24) - თარიღი, რომლიდანაც იწყება პატენტის მოქმედება
- (31) - საპრიორიტეტო განაცხადის ნომერი
- (32) - საპრიორიტეტო განაცხადის შეტანის თარიღი
- (33) - კოდი ქვეყნისა ან რეგიონული ორგანიზაციისა, რომლის უწყებამაც მიანიჭა ნომერი საპრიორიტეტო განაცხადს
- (43) - განაცხადის გამოქვეყნების თარიღი, ბიულეტენის ნომერი***
- (44) - დამცავი საბუთის ჯერ არმქონე, მაგრამ ექსპერტიზაგაეული განაცხადის გამოქვეყნების თარიღი და ბიულეტენის ნომერი
- (45) - პატენტის გამოქვეყნების თარიღი/ პატენტის გამოქვეყნების თარიღი*** რეგისტრირებული სასარგებლო მოდელების გამოქვეყნების თარიღი***
- (51) - საერთაშორისო საპატენტო კლასიფიკაციის ინდექსი
- (54) - გამოგონების დასახელება/ სასარგებლო მოდელების დასახელება
- (57) - რეზიუმე ტექსტი
- (60) - სრულ ექსპერტიზაგაეულ გამოგონებაზე უცხოური საპატენტო უწყების მიერ გაცემული დამცავი საბუთის ნომერი, თარიღი, რომლიდანაც იწყება ამ დამცავი საბუთის მოქმედება, და კოდი ქვეყნისა ან რეგიონული ორგანიზაციისა, რომლის უწყებამაც გაცა ეს დამცავი საბუთი
- (62) - ადრინდელი განაცხადის ნომერი და ნარდგენის თარიღი გამოყოფილი განაცხადის შემთხვევაში
- (71) - განმცხადებლის სახელი, გვარი ან დასახელება (ქვეყნის კოდი, მისამართი)
- (72) - გამომგონებლის სახელი, გვარი (ქვეყნის კოდი)
- (73) - პატენტმფლობელის/ პატენტმფლობელის***/ რეგისტრირებული სასარგებლო მოდელების მფლობელის*** სახელი, გვარი ან დასახელება (ქვეყნის კოდი, მისამართი)
- (74) - ნარმომადგენლის ან პატენტრწმუნებულის სახელი, გვარი
- (85) - საერთაშორისო (PCT) განაცხადის ეროვნული ფაზის დაწყების თარიღი
- (86) - საერთაშორისო (PCT) განაცხადის ნომერი და შეტანის თარიღი
- (87) - საერთაშორისო (PCT) განაცხადის გამოქვეყნების ნომერი და თარიღი
- (94) - დაცვის დამატებითი მოწმობით გაგრძელებული პატენტის მოქმედების ვადის ამონაწერის თარიღი

ლიზინები

- (10) - განაცხადის გამოქვეყნების ნომერი
- (11) - პატენტის ნომერი და სახეობის კოდი ან რეგისტრაციის ნომერი
- (15) - რეგისტრაციის თარიღი/პატენტის გაგრძელების თარიღი
- (18) - პატენტის ან რეგისტრაციის მოქმედების ვადის გასვლის საგარეულო თარიღი
- (21) - განაცხადის ნომერი
- (22) - განაცხადის შეტანის თარიღი
- (23) - საგამოფენო პრიორიტეტის თარიღი ან ადრინდელი პრიორიტეტის მქონე განაცხადის შეტანის თარიღი და, თუ შესაძლებელია, განაცხადის ნომერი
- (24) - თარიღი, რომლიდანაც იწყება პატენტის მოქმედება
- (28) - დიზაინების რაოდენობა განაცხადში
- (30) - საპრიორიტეტო მონაცემები (განაცხადის ნომერი, განაცხადის შეტანის თარიღი და ორსაიანი კოდი იმ ორგანიზაციის იდენტიფიკაციისათვის, სადაც იყო ნარდგენილი საპრიორიტეტო განაცხადი)
- (31) - საპრიორიტეტო განაცხადის ნომერი
- (32) - საპრიორიტეტო განაცხადის შეტანის თარიღი
- (33) - კოდი ქვეყნისა ან რეგიონული ორგანიზაციისა, რომლის უწყებამაც მიანიჭა ნომერი საპრიორიტეტო განაცხადს
- (34) - ისმო-ს სტანდარტის (მთ.3) შესაბამისი ორსაიანი კოდი იმ ორგანიზაციის იდენტიფიკაციისათვის, სადაც იყო ნარდგენილი საპრიორიტეტო განაცხადი
- (44) - დიზაინის გამოქვეყნების თარიღი და ბიულეტენის ნომერი (პირველი პუბლიკაცია)
- (45) - საერთაშორისო ბიუროს მიერ დარეგისტრირებული დიზაინის გამოქვეყნების თარიღი და ბიულეტენის ნომერი
- (51) - დიზაინების საერთაშორისო კლასიფიკაცია (ლოკარნოს კლასიფიკაციის კლასი და ქვეკლასი)
- (54) - დიზაინის დასახელება
- (55) - დიზაინის გამოსახულება
- (57) - დიზაინის არსებითი ნიშნების აღწერა, ფერის ჩათვლით
- (58) - ყველა სახის ცვლილების შესახებ რეესტრში ჩანაწერის შეტანის თარიღი
- (62) - ადრინდელი განაცხადის, რეგისტრაციის ან საბუთის ნომერი და, თუ შესაძლებელია, ნარდგენის თარიღი, გამოცალკევებული განაცხადის შემთხვევაში
- (71) - განმცხადებლის სახელი, გვარი (ქვეყნის კოდი), მისამართი
- (72) - ავტორის სახელი, გვარი ან დასახელება (ქვეყნის კოდი)
- (73) - პატენტმფლობელის სახელი, გვარი (ქვეყნის კოდი), მისამართი
- (74) - ნარმომადგენლის სახელი, გვარი ან მისამართი
- (81) - შესაბამისი მონაწილე მხარეები:
 - II. მონაწილე მხარეები, აღნიშნული 1960 წლის აქტის თანახმად
 - III. მონაწილე მხარეები, აღნიშნული 1999 წლის აქტის თანახმად
- (85) - მფლობელის მუდმივი საცხოვრებელი ადგილი
- (86) - მფლობელის მოქალაქეობა
- (87) - მფლობელის საცხოვრებელი ადგილი
- (88) - ქვეყანა, სადაც მფლობელს აქვს ნამდვილი და მოქმედი სამრეწველო ან სააქტრო სანარმო

სასაქონლო ნიშნები

- (111) - რეგისტრაციის ნომერი
- (151) - რეგისტრაციის თარიღი
- (156) - რეგისტრაციის ვადის გაგრძელების თარიღი
- (181) - რეგისტრაციის ვადის გასვლის საგარეულო თარიღი
- (186) - ვადის გაგრძელების ვადის საგარეულო თარიღი
- (141) - რეგისტრაციის მოქმედების ვადის გაუქმების თარიღი
- (210) - განაცხადის ნომერი
- (220) - განაცხადის შეტანის თარიღი
- (230) - საგამოფენო მონაცემები
- (260) - ნომერი განაცხადისა, რომელზედაც გამოტანილია ექსპერტიზის დადებითი გადაწყვეტილება რეგისტრაციის შესახებ (გამოქვეყნების ნომერი)
- (310) - პირველი განაცხადის ნომერი
- (320) - პირველი განაცხადის შეტანის თარიღი
- (330) - პირველი განაცხადის მიმღები ეროვნული ან რეგიონული უწყების ან ორგანიზაციის საიდენტიფიკაციო კოდი
- (511) - საქონლისა და მომსახურების საერთაშორისო კლასიფიკაცია სასაქონლო ნიშნის რეგისტრაციისათვის და/ან კლასიფიკირებული საქონლისა და/ან მომსახურების ჩამონათვალი
- (526) - დისკლამაცია
- (531) - სასაქონლო ნიშნის გამოსახულებითი ელემენტების აღწერა სასაქონლო ნიშნების გამოსახულებითი ელემენტების საერთაშორისო კლასიფიკაციის (ვენის კლასიფიკაცია) მიხედვით
- (540) - ნიშნის გამოსახულება
- (550) - სასაქონლო ნიშნის ტიპი ან სახეობა
- (551) - მითითება, რომ ნიშანი არის კოლექტიური, სასერტიფიკაციო ან საგარანტო
- (554) - სამგანზომილებიანი (მოცულობითი) ნიშანი
- (580) - განაცხადსა და ნიშნის რეგისტრაციისთან დაკავშირებული ყველა სახის ცვლილებაზე ჩანაწერის შეტანის თარიღი
- (591) - ინფორმაცია განაცხადებულ ფერებზე
- (731) - განმცხადებლის სახელი და მისამართი
- (732) - მფლობელის სახელი და მისამართი
- (740) - ნარმომადგენლის სახელი და მისამართი
- (750) - მიმონერის მისამართი
- (770) - ცვლილებამდე განმცხადებლის ან მფლობელის სახელი და მისამართი უფლების გადაცემის შემთხვევაში
- (771) - ცვლილებამდე განმცხადებლის ან მფლობელის სახელი და მისამართი უფლების გადაცემის გარეშე
- (791) - ლიცენზიატის სახელი და მისამართი
- (793) - ლიცენზიის პირობები და/ან შეზღუდვაზე მინიშნება (ლიცენზიის სახე, სალიცენზიო ხელშეკრულების ნომერი, სალიცენზიო ხელშეკრულების თარიღი, სალიცენზიო ხელშეკრულების მოქმედების ვადა)
- (800) - სასაქონლო ნიშნის რეგისტრაციის მონაცემები ნიშნების საერთაშორისო რეგისტრაციის მადრიდის ხელშეკრულებასთან დაკავშირებული პროტოკოლის მიხედვით (საერთაშორისო რეგისტრაციის ნომერი)
- (852) - ნაწილობრივ გაუქმებული საქონლის/მომსახურების ჩამონათვალი
- (891) - შემდგომი გაერცელების თარიღი

- (21) AP 0000 000000 - გამოგონების განაცხადის ნომერი
- (10) AP 0000 0000 A - გამოგონების განაცხადის გამოქვეყნების ნომერი
- (11) P 0000 0000 B - გამოგონების პატენტის ნომერი/ პატენტის ნომერი***
- (21) API 0000 000000 - შემოტანილი პატენტზე განაცხადის ნომერი
- (11) PI 0000 0000 A - შემოტანილი პატენტის ნომერი
- (21) AU 0000 000000 - სასარგებლო მოდელების განაცხადის ნომერი
- (10) AU 0000 000 U - სასარგებლო მოდელების განაცხადის გამოქვეყნების ნომერი
- (11) U 0000 000 Y - სასარგებლო მოდელების პატენტის ნომერი/ რეგისტრირებული სასარგებლო მოდელების ნომერი***
- (21) AD 0000 000000 - დიზაინზე განაცხადის ნომერი
- (10) AD 0000 000 S - დიზაინზე განაცხადის გამოქვეყნების ნომერი (პირველი პუბლიკაცია)
- (11) D 0000 000 S - რეგისტრირებული დიზაინი
- (21) AP 0000 000000 - გამოგონების განაცხადის ნომერი
- (10) AP 0000 0000 A - გამოგონების განაცხადის გამოქვეყნების ნომერი
- (11) P 0000 0000 B - გამოგონების პატენტის ნომერი/ პატენტის ნომერი***
- (21) API 0000 000000 - შემოტანილი პატენტზე განაცხადის ნომერი
- (11) PI 0000 0000 A - შემოტანილი პატენტის ნომერი
- (21) AU 0000 000000 - სასარგებლო მოდელების განაცხადის ნომერი
- (10) AU 0000 000 U - სასარგებლო მოდელების განაცხადის გამოქვეყნების ნომერი
- (11) U 0000 000 Y - სასარგებლო მოდელების პატენტის ნომერი/ რეგისტრირებული სასარგებლო მოდელების ნომერი***
- (21) AD 0000 000000 - დიზაინზე განაცხადის ნომერი
- (10) AD 0000 000 S - დიზაინზე განაცხადის გამოქვეყნების ნომერი (პირველი პუბლიკაცია)
- (11) D 0000 000 S - რეგისტრირებული დიზაინი

გამომონებებისა და სასარგებლო მოდელების საერთაშორისო კლასიფიკაციის ინდექსები

- განყოფილება A - ადამიანის პირველადი მოთხოვნების საგნები
- განყოფილება B - ტექნოლოგიური პროცესები; ტრანსპორტირება
- განყოფილება C - ქიმიკა; მეტალურგია
- განყოფილება D - საფეიქრო ნაწარმი; ქაღალდი
- განყოფილება E - მშენებლობა; სამთო საქმე; სტაციონარული ნაგებობები
- განყოფილება F - მექანიკა; განათება; გათბობა; იარაღი; ასაფეთქებელი საშუალებები
- განყოფილება G - ფიზიკა
- განყოფილება H - ელექტრობა

* საქპატენტის სააპელაციო პალატის გადაწყვეტილების შემდეგ გამოქვეყნებული განაცხადის ნომერი

** სასამართლოს გადაწყვეტილების შემდეგ გამოქვეყნებული განაცხადის ნომერი

*** საქართველოს საპატენტო კანონი 2023 წლის 16 მაისი (№2883-XIII-Xმბ) შეტანილი ცვლილების შესაბამისად გამოქვეყნებული მასალები

- M - სასაქონლო ნიშანი
- (210) AM 0000 000000 - განაცხადის ნომერი
- (260) AAM 0000 000000 A - განაცხადის გამოქვეყნების ნომერი
- (111) M 0000 00000 R - რეგისტრაციის ნომერი
- MMM0000 00000 Rn - მომდევნო ვადით რეგისტრაციის ნომერი, სადაც n = 1, 2, 3...
- M 0000 00000 R(P) - რეგისტრაციის ნომერი ნიშანზე უფლების ნაწილობრივი გადაცემისას

სამრეწველო საკუთრების ოფიციალური ბიულეტენი

გამოგონებები

სასარგებლო მოდელები

დიზაინები

სასაქონლო ნიშნები

შ ი ნ ა ა რ ს ი

გამოქვეყნებული ობიექტები	3
გამოგონებები	
• განაცხადები, რომლებზეც გამოტანილია გადაწყვეტილება პატენტის გაცემის შესახებ	4
• გამოგონების პატენტები	7
სასარგებლო მოდელები	
• განაცხადი, რომელზეც გამოტანილია გადაწყვეტილება პატენტის გაცემის შესახებ	8
• სასარგებლო მოდელის პატენტები	9
დიზაინები	
• რეგისტრირებული დიზაინი	10
• დიზაინები, რომლებიც რეგისტრირებულია საერთაშორისო ბიუროში საქართველოს ტერიტორიაზე უფლებათა გავრცელების მოთხოვნით	11
სასაქონლო ნიშნები	
• ეროვნული პროცედურით შემოტანილი განაცხადები, რომლებზეც გამოტანილია გადაწყვეტილება რეგისტრაციის შესახებ	19
• რეგისტრირებული სასაქონლო ნიშნები	48
• დაჩქარებული პროცედურით რეგისტრირებული სასაქონლო ნიშნები	52
• საერთაშორისო სასაქონლო ნიშნები, რომლებზეც გამოტანილია გადაწყვეტილება დაცვის მინიჭების შესახებ	58
• საერთაშორისო სასაქონლო ნიშნები, რომლებსაც მიენიჭა დაცვა საქართველოში	252
ოფიციალური შეტყობინება	
გამოგონებები	
• პატენტების მოქმედების აღდგენა	261
• პატენტების გაუქმება აღდგენის უფლებით	261
• პატენტების მოქმედების აღდგენის ვადის ამოწურვა	262
სასარგებლო მოდელები	
• პატენტების მოქმედების აღდგენა	265
• უფლების გადაცემა	266
დიზაინები	
• დიზაინების რეგისტრაციის მოქმედების ვადის გაგრძელება	266
• საერთაშორისო დიზაინების რეგისტრაციის მოქმედების გაუქმება	267
სასაქონლო ნიშნები	
• რეგისტრაციის მოქმედების ვადის გაგრძელება	269
• უფლებების სრული გადაცემა	271
• მფლობელების სახელის და/ან მისამართის ცვლილებები	272
• სასაქონლო ნიშნების რეგისტრაციის გაუქმება	273
სისტემური საძიებლები	
გამოგონებები	275
სასარგებლო მოდელები	276
დიზაინი	278
სასაქონლო ნიშნები	279

ბამოქვეყნებული ობიექტები

ბამობონებები

- ბანაცხადები, რომლებზეც ბამოტანილია გადაწყვეტილება პატენტის გაცემის შესახებ:
16003; 15366; 15648; 15921
- პატენტები:
7520, 7521

სასარბებლო მოდელები

- ბანაცხადი, რომელზეც ბამოტანილია გადაწყვეტილება პატენტის გაცემის შესახებ:
16090
- პატენტები:
2153, 2154

ღიზანები

- რეგისტრირებული ღიზანი:
974
- ღიზანები, რომლებიც რეგისტრირებულია სავრთავროდის ბიუროში საქართველოს ტერიტორიაზე უფლებათა გაცემის მოთხოვნით:
220870; 224843; 225041; 228828; 228833

სასაქონლო ნიშნები

- ეროვნული პროცედურით შემოტანილი ბანაცხადები, რომლებზეც ბამოტანილია გადაწყვეტილება რეგისტრაციის შესახებ:
119177; 119195; 119790; 119792; 119892, 119893; 120046; 120048; 120240; 120252; 120257; 120259; 120339; 120358, 120359; 120435; 120440; 120448; 120497-120499; 120504; 120510-120512; 120515; 120517; 120520; 120524; 120527; 120530, 120531; 120598; 120604; 120606-120608; 120610; 120612, 120613; 120618; 120628, 120629; 120735; 120827; 120833, 120834; 120837-120839; 120841; 120847; 120859; 120862; 120937; 120939; 120957-120959; 120975, 120976; 121041-121043; 121050; 121126
- რეგისტრირებული სასაქონლო ნიშნები:
37047-37084
- დაჩქარებული პროცედურით რეგისტრირებული სასაქონლო ნიშნები:
37032-37046
- სავრთავროდის სასაქონლო ნიშნები, რომლებზეც ბამოტანილია გადაწყვეტილება დაცვის მიზნების შესახებ:
116673; 116679, 116680; 116683, 116684; 117212*; 117373*; 118359; 118416; 118796; 118908; 119661; 119669; 119708, 119709; 119711-119717; 119720; 119731-119737; 119739; 119744; 119746; 119748; 119754; 119820-119825; 119828-119833; 119849-119853; 119864-119866; 119868; 119870-119873; 119877-119879; 119918-119921; 119923-119926; 119936; 119941-119959; 119961-119971; 119977-119982; 120053; 120056-120060; 120062-120069; 120071-120080; 120092-120103; 120107-120113; 120115, 120116; 120118-120125; 120184-120186, 120187; 120196; 120198-120203; 120206-120210; 120212-120215; 120217-120221; 120226; 120266, 120267; 120273-120275; 120277; 120279-120281; 120285-120289; 120291-120294; 120310, 120311; 120313-120317; 120323-120334; 120373-120377; 120389-120391; 120398-120400; 120402; 120419-120421; 120423, 120424; 120426-120428; 120430, 120431; 120538; 120551-120557; 120639-120645; 120684, 120685; 120687; 120695; 120879
- სავრთავროდის სასაქონლო ნიშნები, რომლებსაც მიენიჭა დაცვა საქართველოში:
113086; 114834; 114870; 115270; 116797; 117636; 117962; 118041, 118042; 118257; 118272; 118445-118453; 118455-118458; 118460; 118463, 118464; 118567; 118572, 118573; 118575-118583; 118585-118587; 118593, 118594; 118622-118628; 118666-118668; 118675-118701; 118703-118705; 118711; 118714; 118717; 118768; 118770, 118771; 118774-118780; 118782-118786; 118804; 118818-118821; 118823; 118825, 118826; 118865; 118881, 118882; 118894-118900; 118909-118915; 118943; 119035; 119037-119042; 119060

გამომგონებები

ბანაცხადები, რომლებზეც გამოტანილია გადაწყვეტილება პატენტის გაცემის შესახებ

გადაწყვეტილების გასაჩივრება შესაძლებელია საქპატენტის სააპელაციო პალატაში გამოქვეყნებიდან 3 თვის ვადაში ან მცხეთის რაიონული სასამართლოს ადმინისტრაციულ საქმეთა კოლეგიაში 1 თვის ვადაში (მის.: ქ. მცხეთა, სამხედროს ქ. №17).

ბანყოფილება A

A 01

(10) AP 2023 16003 A (51) Int. Cl. (2006)

A 01 J 5/14

A 01 J 5/007

(21) AP 2022 16003 (22) 2022 07 12

(71) სსიპ „სოფლის მეურნეობის სამეცნიერო-

კვლევითი ცენტრი“ (GE)

მარშალ გელოვანის გამზ. 6, 0159, თბილისი,
საქართველო (GE);

ვლადიმერ მირუაშვილი (GE)

დოლიძის ქ. 132, 0115, თბილისი,

საქართველო (GE);

გიორგი ქუთელია (GE)

ნოსტეს ქ. 7, 0101, თბილისი,

საქართველო (GE);

რუსუდან ზარკალაია (GE)

ნინოშვილის ქ. 20, თბილისი,

საქართველო (GE);

გიული გოგოლი (GE)

ვახისუბანი, 1 მკრ., კორპ. 8ა, ბ. 6, თბილისი,

საქართველო (GE)

(72) ვლადიმერ მირუაშვილი (GE);

გიორგი ქუთელია (GE);

რუსუდან ზარკალაია (GE);

გიული გოგოლი (GE)

(54) საწველი აპარატი

(57) აპარატი შეიცავს პულსატორ-კოლექტორის კორპუსს 1 მუდმივი 3 და ცვლადი ვაკუუმის 2 კამერებით, რომლებთანაც შესაბამისად მიერთებულია რემეგამტარი 4 და ვაკუუმგამტარი მილაკები, ავტომატურ მართვის სისტემას. ავტომატური მართვის სისტემა შეიცავს ელექტროამრაფთან 24 დაკავშირებულ და გარსაცმში 15 მოთავსებულ ბრუნვის შესაძლებლობის მქონე ცილინდრულ დოლს 16, რომლის ნაწილი 17 წაკვეთილი კონუსური ფორმით დაფარულია დენგამტარი მასალით, ხოლო დანარჩენი ნაწილი – დიელექტრიკული მასალით, ამასთან, დოლი

ბოლოვდება შესაბამისად დენგამტარი 18 და დიელექტრიკული მასალის 19 რგოლებით. გარდა ამისა, ავტომატური მართვის სისტემა შეიცავს რკალური ფორმის ცოციას 13 და პულსატორ-კოლექტორის რემეგამტარ მილაკში განთავსებულ მგრძობიარე ფირფიტას 6. დოლის დენგამტარი მასალის რგოლზე და ცოციაზე განთავსებულია ცვლადი ვაკუუმის კამერის ელექტრომაგნიტური სარქვლების 5 მკვებავი ჯაგრისები 20, 21 და 22, ხოლო ელექტროამრაფის კვების სისტემაში ჩართულია ცვლადი წინაღობის რეზისტორი 27.

მუხლები: 1 დამოუკიდებელი

ფიგურა: 6

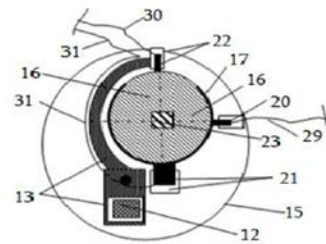

ფიგ. 5

A 61

(10) AP 2023 15366 A (51) Int. Cl. (2006)

A 61 P 35/00

C 07 K 16/28

(21) AP 2018 15366 (22) 2018 11 15

(31) 62/587,604

(32) 2017 11 17

(33) US

(71) მერკ შარპ & დოუმ ელელსი (US)

126 ისტ ლინკოლნ ავენიუ, საფოსტო ყუთი

2000, რაუვეი, ნიუ-ჯერსი 07065, აშშ (US)

(72) მაიკლ, ა. მილ (US);

ფილიპ ე. ბრენდიშ (US);

ლორენს ფაიადატ-დილმან (US);

ვერონიკა ცზიუიან (US);

კარლ მეჩკოვსკი (US);

ლატიკა სინგხ (US)

(74) შალვა გვარამაძე
 (85) 2020 06 15
 (86) PCT/US2018/061165, 2018 11 15
 (54) იმუნოპოლიმერული მსგავსი ტრანს-კრიპტი 3-ის (ILT3) მიმართ სპეციფიკური ანტი-სხეულები და მათი გამოყენება
 (57) წარმოდგენილია ჰუმანიზებული მონოკლონური ანტი-სხეულები სპეციფიკური იმუნოგლობულინის მსგავსი ტრანსკრიპტი 3-ის (ILT3) მიმართ, რომელიც ასევე ცნობილია LILRB4-ის სახელით. მათ იყენებენ კიბოს სამკურნალოდ.
 მუხლები: 8 დამოუკიდებელი
 8 დამოკიდებული
 ფიგურა: 15

ჩჯე ვუ (US);
 ენტონი, ტ. ჯინეტტი (US)
 (74) შალვა გვარამაძე
 (85) 2021 06 01
 (86) PCT/US2019/058999, 2019 10 31
 (54) 2-ამინო-N-ჰემიპროარილ-ნიკოტინამიდები რობოტც Nav1.8 ინჰიბიტორები
 (57) ნაერთი სტრუქტურული ფორმულით I:

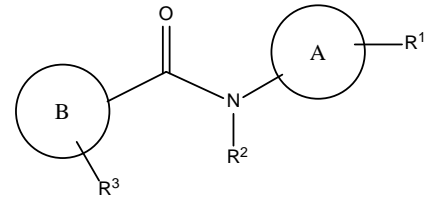

რომლის A, B, R¹, R², R³ ჩამნაცვლებლების მნიშვნელობები მოყვანილია გამოგონების ფორმულაში, ან მისი ფარმაცევტულად მისაღები მარილი, ფარმაცევტული კომპოზიცია მათ საფუძველზე და გამოყენება Nav1.8 არხის აქტიურობის ინჰიბირებაზე რეაგირებისუნარიანი დარღვევის, მდგომარეობის ან დაავადების, როგორცაა ტკივილი, ხველა, მწვავე ქავილი ან ქრონიკულ ქავილი, სამკურნალოდ.

მუხლები: 12 დამოუკიდებელი
 17 დამოკიდებული
 ცხრილი: 10

ბანყოფილება C

C 07

(10) AP 2023 15648 A (51) Int. Cl. (2006)
 C 07 D 401/14
 C 07 D 413/12
 C 07 D 413/14
 C 07 D 417/14
 C 07 D 471/04
 C 07 D 401/12
 (21) AP 2019 15648 (22) 2019 10 31
 (31) 62/754,742
 (32) 2018 11 02
 (33) US
 (71) მერკ შარპ & დოუმ ელელსი (US)
 126 ისტ ლინკოლნ ავენიუ, 07065, რაუეი, ნიუ-ჯერსი, აშშ (US)
 (72) აშოკ არასასპან (US);
 აიან, მ. ბელლ (US);
 მაიკლ, დჯ. ბრესლინ (US);
 კრისტოფერ ჯეიმს ბუნგარდ (US);
 კრისტოფერ, ს. ბერგი (US);
 ჰარრი, რ. ჩოზანიან (US);
 ჯეისონ, მ. კოკს (US);
 დეოდიალ გაი გუადინ (US);
 კრისტენ, ლ. დჯ. ჯონს (US);
 მარკ, ე. ლეიტონ (US);
 ხუნ ლიუ (US);
 ცზიან ლიუ (US);
 ჯეიმს, დჯ. პერკინს (US);
 შონ, დჯ. სტაჩელ (US);
 ლინდა, მ. სუენ-ლაი (US);

ბანყოფილება F

F 01

(10) AP 2023 15921 A (51) Int. Cl. (2006)
 F 01 K 21/04
 (21) AP 2020 15921 (22) 2020 09 03
 (31) 102019000015770; 102019000015776
 (32) 2019 09 06; 2019 09 06
 (33) IT; IT
 (71) ი.ვ.ა.რ. ს.პ.ა. (IT)
 ვია IV ნოვემბრე, 181, 25080 პრევალე (BS), იტალია (IT)
 (72) სერჯიო ოლივოტი (IT)
 (74) შალვა გვარამაძე
 (85) 2022 04 01
 (86) PCT/IB2020/058210, 2020 09 03
 (54) ხერხი და თბობრავა კომბინირებული თერმოდინამიკური ციკლის მისაღებად ენერჯის მისაღებად
 (57) ხერხი კომბინირებული თერმოდინამიკური ციკლის მისაღებად დენადი თბობატარების

მეშვეობით, რომელიც დენადი თბომატარებლის გათბობის, მუშა კამერაში შეწოვის, შეკუმშვის, გამოშვების და სხვა ოპერაციებთან ერთად ითვალისწინებს რეგენირებადი ორთქლის გენერატორის გამოყენებას, რომელსაც აქვს შესაძლებლობა ენერჯის იმ სხვაობის აღდგენისა, რომელიც არსებობს გაფართოების ზოლოს დენადი თბომატარებლის ტემპერატურას და იმ ტემპერატურას შორის, რომელიც გააჩნია დენად თბომატარებელს თითქმის სრული კონდენსაციის დროს. აღნიშნული მაღალი ენერჯის სხვაობის გამოყენებით რეგენირებადი ორთქლის გენერატორი გამოიმუშავებს გადამეტხურებულ წყლის ორთქლს, რომელიც მთლიანად გამოიყენება ციკლში ნარევის წინასწარ გაცხელებისთვის.

მუხლები: 2 დამოუკიდებელი

13 დამოკიდებული

ფიგურა: 10

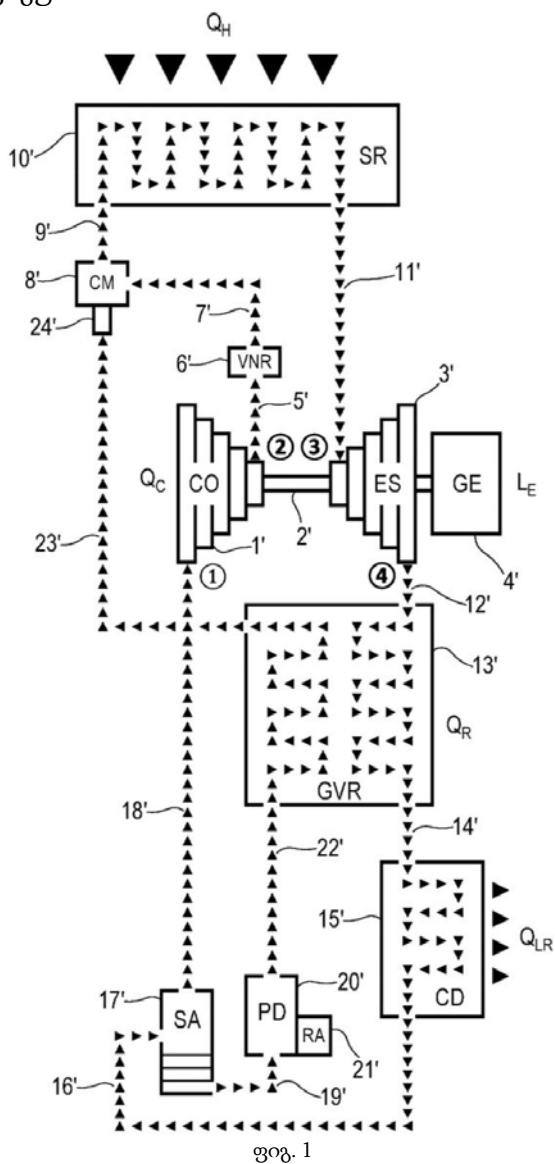

ბამრობონების პატენტები

ბანყოფილება A

(72) სავლე ჩხიტუნძიძე (GE)
(54) კმსი შახტაში

A 61

- (11) P 2023 7521 B (51) Int. Cl. (2006)
A 61 K 9/00
A 61 K 47/26
A 61 K 47/18
A 61 K 39/00
C 07 K 16/24
- (10) AP 2023 15302 A (44) 7(610)/2023
(21) AP 2018 15302
(22) 2018 08 29
(24) 2018 08 29
(31) 10-2017-0110426; 10-2017-0144521;
10-2018-0017449
(32) 2017 08 30; 2017 11 01; 2018 02 13
(33) KR; KR; KR
(86) PCT/KR2018/009998, 2018 08 29
(71) სელეტრიონ ინკ. (KR)
23, ეკედემი-რო, იონსუ-გუ ინჩხონ 22014,
კორეის რესპუბლიკა (KR)
(72) ხიუნ ჩულ ან (KR);
ჯი ხე სუხ (KR);
სუნ ჩუნ კიმ (KR);
სუნ ეუნ ლი (KR)
(74) ლარისა ამირხანიანი
(54) TNF α -სთან დაკავშირებული დაავადებების მკურნალობა

ბანყოფილება E

E 02

- (11) P 2023 7520 B (51) Int. Cl. (2006)
E 02 B 9/00
F 03 B 13/00
- (10) AP 2023 15484 A (44) 4(607)/2023
(21) AP 2020 15484
(22) 2020 11 03
(24) 2020 11 03
(73) სავლე ჩხიტუნძიძე (GE)
კ. ტიმირიაზევის ქ. 20, სოხუმი,
საქართველო (GE)

სასარბებლო მოდელები

ბანაცხადი, რომელზეც გამოტანილია გადაწყვეტილება კატენის ბაცემის შესახებ

გადაწყვეტილების გასაჩივრება შესაძლებელია საქპატენტის სააპელაციო პალატაში გამოქვეყნებიდან 3 თვის ვადაში ან მცხეთის რაიონული სასამართლოს ადმინისტრაციულ საქმეთა კოლეგიაში 1 თვის ვადაში (მის.: ქ. მცხეთა, სამხედროს ქ. №17).

ბანყოფილება H

H 01

(10) AU 2023 16090 U (51) Int. Cl. (2006)
H 01 B 7/295

(21) AU 2022 16090 (22) 2022 11 15

(31) U20220223

(32) 2022 09 29

(33) BY

(71) ერთობლივი დახურული სააქციო
საზოგადოება „ბელტელეკაბელ“ (BY)
სელიცკოვო სტრ. 21/5, 220075, მინსკი,
ბელარუსი (BY)

(72) ვალენტინ ვალენტინოვიჩი
მალოლეტნი (BY)

(74) ნიკოლოზ გოგილიძე

(54) კაბელი ციფრული მარკირებით სიზნა-
ლიზაციისა და დაბლოკვისთვის

(57) კაბელი შეიცავს ტენდამცავ გარსს გულა-
რით, მრავალსადენიან დენგამტარ სპილენძის
ან სპილენძის მოკალულ ძარღვებს ან ძარღვე-
ბის ჯგუფს იზოლაციით. საიდენტიფიკაციო
ნაჭდევები ინდივიდუალური ნომრით თითოე-
ული ძარღვისთვის შესრულებულია მთელ
სიგრძეზე L ინტერვალით ბოლოებიდან ან კა-
ბელის ნებისმიერ სხვა ლოკალურ მონაკვეთზე.
ინდივიდუალური ნომრის ნაჭდევი შესრულე-
ბულია მოცემული ფერის პიგმენტით სუპერკონ-
ცენტრატის შემადგენლობაში აქტიური ნივ-
თიერებით და დანამატებით კაბელისთვის ასო-
ციფრული აღნიშვნით. სუპერკონცენტრატი 1-
3%-ის ოდენობით განთავსებულია პოლიეთი-
ლენის იზოლაციის ზედაპირულ ფენაში, ამას-
თან, პიგმენტი შერჩეულია შემდეგი ფერები-
დან: წითელი, მწვანე, ლურჯი, შავი, ნაცრისფე-
რი და თეთრი.

მუხლები: 1 დამოუკიდებელი

3 დამოკიდებული

ფიგურა: 3

სასარბებლო მოდელების კატეგორიები

ბანყოფილება A

A 61

- (11) U 2023 2154 Y (51) Int. Cl. (2006)
A 61 G 10/00
- (10) AU 2023 16056 U (44) 7(610)/2023
- (21) AU 2022 16056
- (22) 2022 10 11
- (24) 2022 10 11
- (73) ნიკოლოზ კონსტანტინიდი (GE)
ნუცუბიძის ფერდობი III მ/რ., III კვ.,
კორპ. 6, ბ. 11, 0183, თბილისი,
საქართველო (GE)
- (72) ნიკოლოზ კონსტანტინიდი (GE)
- (54) ჰანგბაღის ყურე
-

ბანყოფილება G

G 10

- (11) U 2023 2153 Y (51) Int. Cl. (2006)
G 10 D 1/00
- (10) AU 2023 15837 U (44) 3(606)/2023
- (21) AU 2021 15837
- (22) 2021 12 24
- (24) 2021 12 24
- (73) მიხეილ რამიშვილი (GE)
ვაჟა-ფშაველას გამზ. 12, ბ. 46, 0160,
თბილისი, საქართველო (GE)
- (72) მიხეილ რამიშვილი (GE)
- (54) სიმეზიან საკრავზე თითების
საპარაფორმო მოწყობილობა
„კვაჭიჭო“
-

დიზაინები

რეგისტრირებული დიზაინი

- (11) D 2023 974 S (51) 11-01
(10) AD 2023 1284 S (44) 2023 04 10 №7
(21) AD 2022 1284
(22) 2022 11 21
(24) 2022 11 21
(28) 44
(18) 2027 11 21
(73) შპს „ზარაფხანა“ (GE)
ლუბლიანას ქ.15, 0162, თბილისი,
საქართველო (GE)
(72) თეა თეთრაძე (GE)
(54) 10. ჯვარი; 11.-12. ბეჭედი; 13.-14. საყურე;
15. სამაჯური; 16.-17. ბეჭედი; 18. სამაჯური;
19.-20. პერანბის სამაბრი; 1. სამაჯური;
21. ბეჭედი; 22.-24. სამაჯური; 25. საყურე;
26.-27. ბეჭედი; 28. ყელსაბამი; 29. საყურე;
2. საყურე; 30. ბეჭედი; 31. საყურე;
32. პერანბის სამაბრი; 33. ბეჭედი;
34.-44. ბულსაბნევი; 3. ყელსაბამი;
4.-5. ბეჭედი; 6. ყელსაბამი; 7. სამაჯური;
8.-9. საყურე
-

**ლიზანია, რომელიც რეგისტრირებულია საქართველოს
ბიუროში საქართველოს ტერიტორიაზე უფლებათა
ბავრცელების მოთხოვნით**

გადაწყვეტილების გასაჩივრება შესაძლებელია საქპატენტის სააპელაციო პალატაში გამოქვეყნებულიდან 3 თვის ვადაში ან მცხეთის რაიონული სასამართლოს ადმინისტრაციულ საქმეთა კოლეგიაში 1 თვის ვადაში (მის.: ქ. მცხეთა, სამხედროს ქ. №17).

- (11) DM/220 870 (51) 10-07
- (15) 2022 05 11 (44) 19/2023 (2023 05 12)
- (22) 2022 05 11
- (28) 1
- (73) Compagnie des Montres Longines, Francillon S.A. (Longines Watch Co. Francillon Ltd.)
Rue des Noyettes 8, 2610 St-Imier (CH)
- (85) CH
- (86) CH
- (87) CH
- (88) CH
- (89) CH
- (81) II. MA III. KG, LI, OM, CA, MK, GE, BA, NO, RU, EM, AM, MD, TN, GB, TR, MN, CH, KR, AL, UA,
SG, MC, ME, BZ, AZ
- (72) Gaïane DEMUR
c/o Compagnie des Montres Longines, Francillon S.A. Rue des Noyettes 8, 2610, Saint-Imier (CH)
- (74) The Swatch Group AG (The Swatch Group SA) (The Swatch Group Ltd.)
Faubourg du Lac 6, 2501 Biel/Bienne (CH)
- (46) 2023 05 12
- (54) 1. WATCH CASE
- (55)

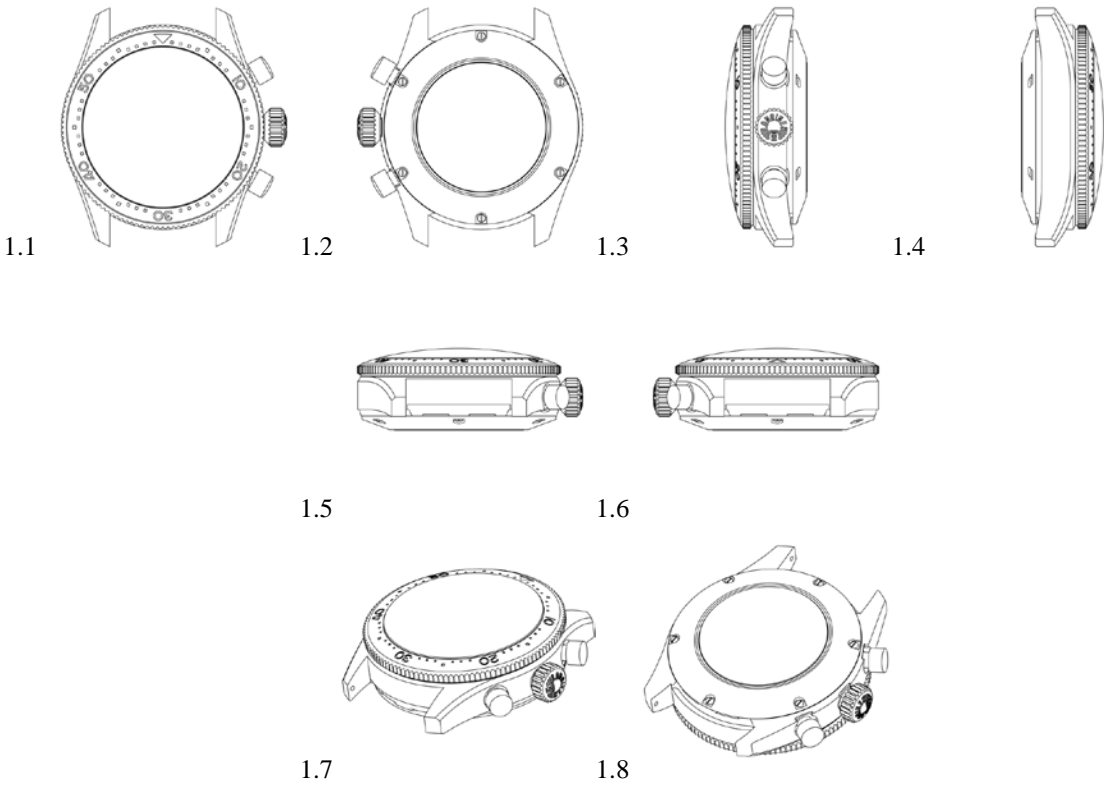

- (11) DM/224 843 (51) 10-07
 (15) 2022 11 08 (44) 19/2023 (2023 05 12)
 (22) 2022 11 08
 (28) 1
 (73) Mido AG (Mido SA) (Mido LTD.)
 17, Chemin des Tourelles, 2400 Le Locle (CH)
 (85) CH
 (86) CH
 (87) CH
 (88) CH
 (89) CH
 (81) III. KG, LI, CA, OM, MK, GE, BA, NO, RU, EM, AM, MD, TN, GB, TR, MN, CH, AL, UA, SG, MA, MC,
 BZ, ME, AZ
 (72) Filippo Lafranchi
 c/o Mido AG (Mido SA) (Mido Ltd.) Chemin des Tourelles 17, 2400, Le Locle (CH)
 (74) The Swatch Group SA (The Swatch Group AG) (The Swatch Group Ltd.)
 Faubourg du Lac 6, 2501 BIEL/BIENNE (CH)
 (46) 2023 05 12
 (54) 1. WATCH CASE
 (55)



1.1

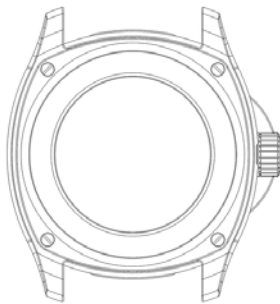

1.2



1.3



1.4



1.5



1.6

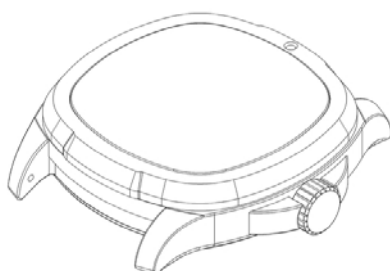

1.7

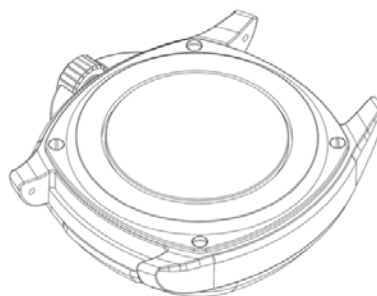

1.8

- (11) DM/225 041
- (15) 2022 11 14
- (22) 2022 11 14
- (28) 3
- (73) Harry Winston SA
Chemin Du Tourbillon 8, 1228 Plan-les-Ouates (CH)
- (85) CH
- (86) CH
- (87) CH
- (88) CH
- (89) CH
- (81) III. KG, LI, TR, GE, MK, OM, CA, BA, MN, NO, CH, EM, AL, UA, AM, MA, SG, MC, MD, ME, BZ, AZ, TN, GB
- (72) 1-2 Rie YATSUGI-KANG
C/o Harry Winston Inc. 718 Fifth Avenue, 10019, New York (US);
3 Tobias WUEST
C/o Harry Winston Inc. 718 Fifth Avenue, 10019, New York (US)
- (74) The Swatch Group AG (The Swatch Group SA) (The Swatch Group Ltd.)
Faubourg Du Lac 6, 2501 Biel/Bienne (CH)
- (46) 2023 05 19
- (54) 1. FINGER RING, 2. NECKLACE, 3. NECKLACE
- (55)



1.1



1.2



1.3



1.4



1.5



1.6



1.7



1.8



2.1



2.2



2.3



2.4



2.5



2.6



2.7



2.8



3.1



3.2



3.3



3.4



3.5



3.6



3.7



3.8

- (11) DM/228 828 (51) 25-03
- (15) 2022 10 03 (44) 20/2023 (2023 05 19)
- (22) 2022 10 03
- (28) 1
- (73) Hennadii Soroka
Pr.Gagarina 3, Ap.3, 49005 Dnipro, Dnipro Region (UA)
- (85) UA
- (86) UA
- (87) UA
- (88) UA
- (89) –
- (81) IL, NE, III, KG, LI, US, CA, GE, MK, BA, NO, RS, RU, EM, AM, TJ, MD, GB, TR, MN, IL, CH, JP, MX, CN, UA, SG, MC, ME, AZ
- (72) Hennadii Soroka
Pr.Gagarina 3, Ap.3, 49005 Dnipro, Dnipro Region (UA)
- (74) Yurii Okhromieiev
Voznesensky Uzviz 10a, Of.110, 04053 Kyiv, Kyiv Region (UA)
- (46) 2023 05 19
- (54) 1. PORTABLE CAPSULE ROOM FOR WORKING
- (55)



1.1



1.2



1.3



1.4

- (11) DM/228 833
- (15) 2022 04 12
- (22) 2022 04 12
- (28) 1
- (73) Foshan Alpicool Technology Co., Ltd.
No. 4-5, Xinye 3rd Road, Lingang Pioneer Park, Shunjiang Community, Beijiao Town, Shunde District, 528000 Foshan, Guangdong (CN)
- (85) CN
- (86) CN
- (87) CN
- (88) CN
- (89) CN
- (81) III. WS, LI, GE, CA, OM, MK, BA, EG, JM, RW, SY, IS, AM, BW, MD, BY, VN, TN, KH, SR, ST, GH, MX, UA, BN, OA, NA, MA, SG, BX, MC, ME, BZ, AZ, SM
- (72) Pizhi Zhao
No. 4-5, Xinye 3rd Road, Lingang Pioneer Park, Shunjiang Community, Beijiao Town, Shunde District, 528000, Foshan, Guangdong (CN);
Junjie Qin
No. 4-5, Xinye 3rd Road, Lingang Pioneer Park, Shunjiang Community, Beijiao Town, Shunde District, 528000, Foshan, Guangdong (CN)
- (46) 2023 05 19
- (54) 1. PREFABRICATED HOUSE
- (55)

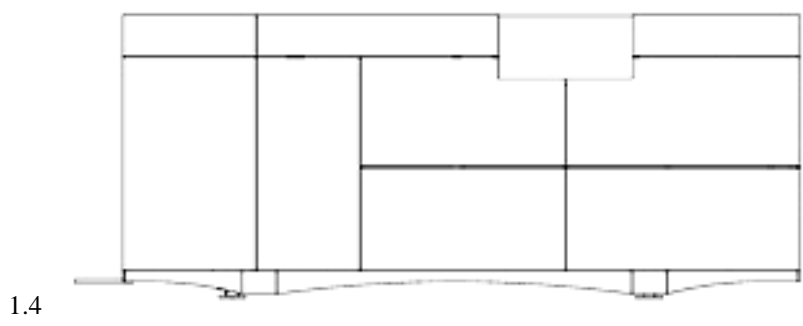
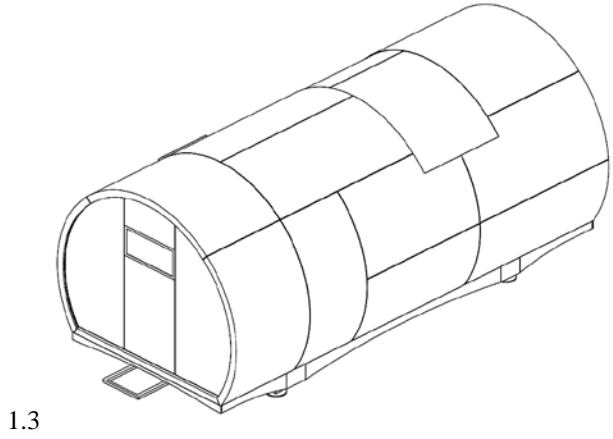
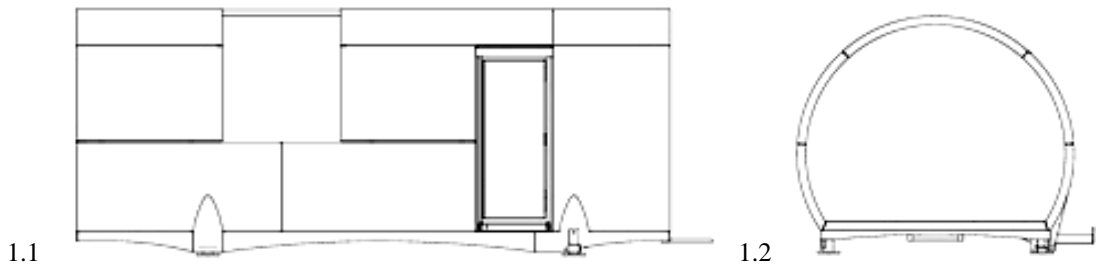

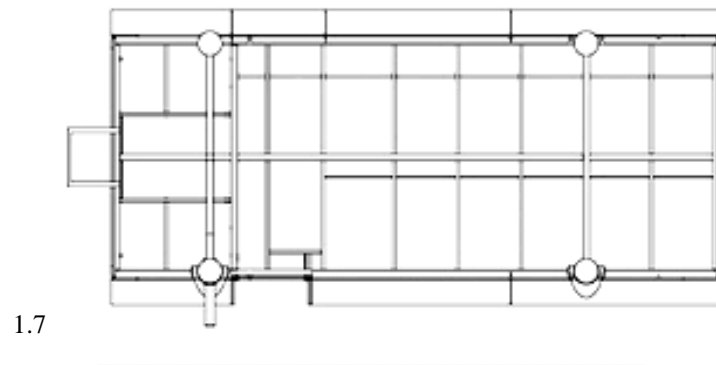
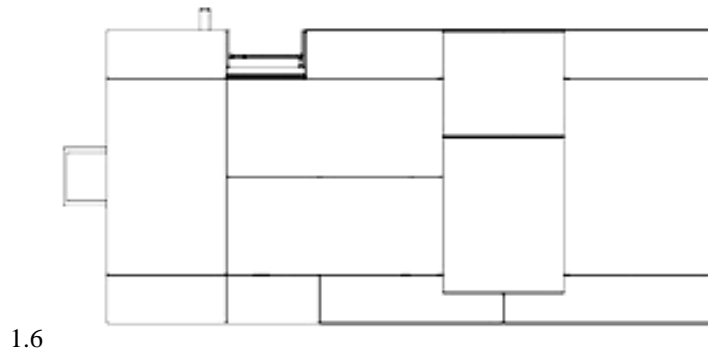
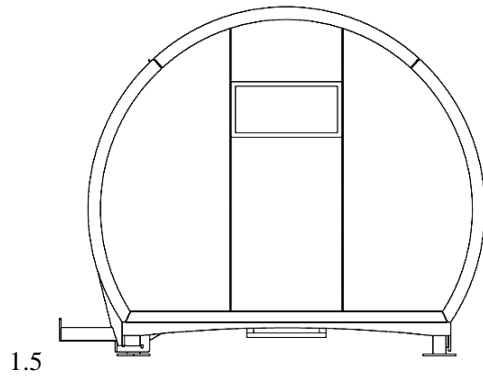

სასაქონლო ნიშნები

ეროვნული პროცედურით შემოტანილი ბანაცხავები, რომლებზეც ბამოტანილია გადაწყვეტილება რეგისტრაციის შესახებ

გადაწყვეტილების გასაჩივრება შესაძლებელია საქპატენტის სააპელაციო პალატაში გამოქვეყნებიდან 3 თვის ვადაში ან მცხეთის რაიონული სასამართლოს ადმინისტრაციულ საქმეთა კოლეგიაში 1 თვის ვადაში (მის.: ქ. მცხეთა, სამხედროს ქ. №17).

(260) AM 2023 119177 A

(210) AM 119177

(220) 2022 08 26

(731) ვასილი ბაბლუანი

ღრმადელის ქ., I შესახ. 55, 0192, თბილისი,
საქართველო

(540)



(591) FOF0F0 ღია რუხი, C7AB54 ოქროსფერი

(531) 03.13.01; 27.03.03; 27.05.01; 27.05.06;
27.05.08; 27.05.09; 29.01.12

(526) Racha

(511)

29 – ლორი, ნედლი კუპატი, დამარილებული ხორცი, ძეხვეული, ღორის ქონი, სისხლზე დამზადებული ძეხვი.

(260) AM 2023 119195 A

(210) AM 119195

(220) 2022 08 30

(731) ფონტერა ბრენდს (სინგაპურ) პტე

ლიმიტედ

182 ცესილ სტრიტ, # 15-01, ფრეზერს
ტაუერ, სინგაპური, 069547, სინგაპური

(740) თამარ კოჭლამაზაშვილი

(540)



(591) წითელი, თეთრი

(531) 18.04.02; 27.05.01; 27.07.01; 28.05; 29.01.01

(511)

5 – დიეტური საკვები პროდუქტები, ნივთიერებები, სასმელები და საკვების შემცველები,

რომლებიც ადაპტირებულია სამედიცინო გამოყენებისთვის; ჩვილების და ბავშვების კვების პროდუქტები, ჩვილებისთვის და ბავშვებისთვის განკუთვნილი რძის ფხვნილის ჩათვლით; კოქტეილები პროტეინის დანამატებით; პროტეინის საკვები დანამატები; საკვები დანამატები, რომლებიც განკუთვნილია ჩვეულებრივი რაციონის გაზრდისათვის ან ჯანმრთელობისთვის სარგებელის მიღებისთვის; ვიტამინები და ვიტამინების კომპოზიციები, რომლებიც განკუთვნილია ადამიანის მიერ მოხმარებისთვის; მინერალური დანამატები საკვები პროდუქტებისთვის; საკვები დანამატები. ბიო დანამატები, და ბაქტერიების კულტურები; პრობიოტიკური დანამატები და პრეპარატები სამედიცინო გამოყენებისთვის; პრობიოტიკური დანამატები; ბაქტერიული და ბიოლოგიური პრეპარატები სამედიცინო გამოყენებისთვის; ბაქტერიული და ბიოლოგიური პრეპარატები კვებაში გამოყენებისთვის; მიკროორგანიზმების კულტურები კვებაში გამოყენებისთვის; ფარმაცევტული პრეპარატები; საკვები დანამატები; ენერგეტიკული ბატონები; ენერგეტიკული ბატონები, რომლებიც გამოიყენება საკვები დანამატების სახით; საკვები დანამატები გამოყენებისთვის მზა პროტეინური ბატონების სახით; ადამიანებისთვის განკუთვნილი ვიტამინებით და მინერალებით გამდიდრებული საკვები პროდუქტები და სასმელები.

29 – რძის პროდუქტები; სასმელები და ფხვნილები რძის პროდუქტების საფუძველზე; რძის პროდუქტები; მშრალი რძე; ულტრაპასტერიზებული რძე; რძე გაზრდილი შენახვის ვადით (ESL რძე); შედედებული რძე; რძის შემცველები; ულაკტოზო რძე; რძის შემცველები არარძის პროდუქტების საფუძველზე; მცენარეული და ბოსტნეული რძის შემცველები; სოიის რძე (რძის შემცველი); სოიაზე დამზადებული სასმელები, რომლებიც წარმოადგენენ რძის შემცველებს; მუხუდოს რძე; პარკოსნებისგან მი-

ღებული რძე; მცენარეული წარმოშობის რძე; ქოქოსის რძე, რომელიც წარმოადგენს რძის შემცველს; სასმელები ქოქოსის რძისგან; საჭმლის მომზადებისთვის განკუთვნილი ქოქოსის რძე; თხილის რძე, რომელიც გამოიყენება რძის შემცველის სახით; ნუშის რძე (რძის შემცველი); სასმელები ნუშის რძის საფუძველზე; არაქისის რძე (რძის შემცველი); ქეშიუს რძე (რძის შემცველი); ფუნდუკის (ტყის თხილის) რძე (რძის შემცველი); რძე მარცვლოვანის საფუძველზე, რომელსაც იყენებენ რძის შემცველის სახით; სეზამის რძე (რძის შემცველი); შვრიის რძე; სასმელები შვრიის საფუძველზე (რძის შემცველი); ბრინჯის რძე (რძის შემცველი); სასმელები ბრინჯის საფუძველზე (რძის შემცველი), რომლებიც წარმოადგენენ თხევადი საკვების შემცველს; კანაფის რძე (რძის შემცველი); ფეტვის რძე (რძის შემცველი); ალაოს რძე (რძის შემცველი); სასმელები ალაოს რძის საფუძველზე; რძიანი სასმელები რძის ჭარბი შემცველობით; ჩიას რძე (რძის შემცველი); სოიაზე დამზადებული სასმელები, რომლებიც გამოიყენება რძის შემცველის სახით; რძის შემცველებზე დამზადებული იოგურტი; ფერმენტირებული რძის შემცველები; ფერმენტირებული რძის შემცველებზე დამზადებული სასმელები; რძის შემცველებზე დამზადებული სასმელები, რომლებიც არომატიზირებულია შოკოლადით, კაკაოთი, ყავით ან ჩაით; რძის შემცველების ფხვნილი; ნუშის რძე ფხვნილის სახით; რძის შემცველები მცენარეების, თხილის და ბოსტნეულის საფუძველზე ფხვნილის სახით კომბინაციაში შრატთან, კაზეინთან ან რძესთან ფხვნილის ფორმაში; ნამდვილი რძის ფხვნილი კომბინაციაში რძესთან მცენარეულ საფუძველზე; რძის ფხვნილის და მშრალი მცენარეული რძის კომბინაცია; რძის შემცველები; რძის პროდუქტები რძის შემცველების საფუძველზე; რძის კონცენტრატი; არომატიზირებული რძე; მშრალი არომატიზირებული რძე; თხის რძე; არომატიზირებული თხის რძე; თხის რძისგან დამზადებული პროდუქტები; მშრალი თხის რძე; არომატიზირებული თხის რძის ფხვნილი; ცხვრის რძე; ცხვრის რძის პროდუქტები; არომატიზირებული ცხვრის რძე; მშრალი ცხვრის რძე; არომატიზირებული მშრალი ცხვრის რძე; პროტეინის რძე; ნაღები (რძის პროდუქტი); ნაღების კარაქი; საკვები ზეთები; საკვები ცხიმები; ყველი; შრატი; იოგურტი; დესერტი, რომელიც ძირითადად დამზადებულია რძის პროდუქტებისგან; გაყინული დესერტები,

რომლებიც შედგება ხილისა და ნაღებისგან ან ნაღების შემცველებისგან; პრობიოტიკური რძის ბატონები საუზმისთვის; თესლების საფუძველზე დამზადებული ბატონები საუზმისთვის; თხილზე და ხმელ ხილზე დამზადებული ბატონები საუზმისთვის; პრობიოტიკური ნუშის საუზმეული ბატონები; პრობიოტიკური რძის საუზმეული ბატონები; პრობიოტიკული იოგურტის საუზმეული ბატონები; უმი ბოსტნეულის ბატონები; ხილის საუზმეული; ხილის საუზმეული ბატონები; სოიის პარკოსნებისგან დამზადებული სოიის ბატონები; სოიის ბატონები; თხილის საუზმეული; თხილზე დამზადებული საკვები ბატონები; საკვების შემცველები თხილეულის საფუძველზე; თხილის ბატონები; ხილის და თხილის საუზმეული ბატონები; თხილის და თესლის საუზმეული ბატონები; პრობიოტიკური თხილზე დამზადებული საუზმეული ბატონები; შოკოლადის სარკალით დაფარული ხილის და თხილის ბატონები; ჟელე საკვები პროდუქტებისთვის; ხილის ჟელეები [ჯემები]; ნაღებიანი დესერტები; მშრალი გამდიდრებული რძე.

32 – უალკოჰოლო სასმელები; უალკოჰოლო გაზიანი სასმელები; უალკოჰოლო შრატისგან დამზადებული სასმელები; ხილის წვენი; იზოტონური სასმელები; უალკოჰოლო პრეპარატივი სასმელების დასამზადებლად; ხილის წვენისგან დამზადებული უალკოჰოლო სასმელები; მინერალური წყალი; სმუზი; წყლები [სასმელები]; უალკოჰოლო ლიქიორები; სიროფები სასმელებისთვის; კონცენტრატები, სიროფები, უალკოჰოლო ესენციები, უალკოჰოლო ექსტრაქტები, ფხვნილები და სხვა უალკოჰოლო პრეპარატივი სასმელების დამზადებისთვის; კონცენტრატები ხილის სასმელების დამზადებისთვის; ფხვნილისებრი პრეპარატივი სპორტული სასმელებისთვის [არასამედიცინო დანიშნულების]; გამოყენებისთვის მზა სასმელები, რომლებიც შეიცავენ საკვებ დანამატებს და რომლებიც არ არის განკუთვნილი სამედიცინო მიზნებისათვის; ნარევი სმუზისთვის; მზა ფხვნილები და გელები სასმელებისთვის.

(260) AM 2023 119790 A

(210) AM 119790

(220) 2022 10 11

(731) ელენე შავდია

წყნეთის გზატ. 39, ბ. 1ა, 0162, თბილისი, საქართველო

(740) ღია შიხიაშვილი;
ზურაბ ბეჟაშვილი;
იოანე იარაჯული

(540)

SHAVDIA
MADE IN SAKARTVELO

(591) შავ-თეთრი

(531) 27.05.01; 27.05.10

(526) SAKARTVELO

(511)

25 – ტანსაცმელი, ფეხსაცმელი, თავსაბურავი.

(260) AM 2023 119792 A

(210) AM 119792

(220) 2022 10 12

(731) ალექსანდრე ჯოხაძე

სოფ. ვარხანი, ადიგენის რაიონი,

საქართველო

(540)



(591) შავი, ოქროსფერი

(531) 03.04.07; 03.04.26; 03.04.29; 24.01.03;

24.01.05; 24.01.07; 24.01.10; 24.01.13;

24.01.19; 24.01.20; 24.01.25; 24.09.02;

24.09.12; 25.01.10; 25.01.25; 27.05.01;

27.05.24; 28.19; 29.01.12

(526) აბასთუმანი, abastumani

(511)

32 – ლუდი; არაალკოჰოლური სასმელები; მინერალური და გაზიანი წყლები; ხილის სასმელები და წვენები; სიროფები და სხვა არაალკოჰოლური შედგენილობები სასმელების დასამზადებლად.

(260) AM 2023 119892 A

(210) AM 119892

(220) 2022 10 19

(731) შპს „აიდიეს ბორჯომი ბევერიჯიზ კომპანი“

პარერავეგის 45, კურასაო

(740) გიორგი ჯოხარიძე

(540)

მიიღე ბორჯომის მაცოცხლებელი ძალა

(591) შავ-თეთრი

(526) ბორჯომი

(511)

32 – მინერალური წყალი, წყაროს წყალი, არაალკოჰოლური სასმელები.

35 – რეკლამა.

(260) AM 2023 119893 A

(210) AM 119893

(220) 2022 10 19

(731) შპს „აიდიეს ბორჯომი ბევერიჯიზ კომპანი“

პარერავეგის 45, კურასაო

(740) გიორგი ჯოხარიძე

(540)

ბორჯომი დაგიბრუნებთ ჰარმონიას

(591) შავ-თეთრი

(526) ბორჯომი

(511)

32 – მინერალური წყალი, წყაროს წყალი, არაალკოჰოლური სასმელები.

35 – რეკლამა.

(260) AM 2023 120046 A

(210) AM 120046

(220) 2022 10 27

(731) ელენე შავდია

წყნეთის გზატ. 39, ბ. 1ა, 0162, თბილისი,

საქართველო

(740) იოანე იარაჯული;

ღია შიხიაშვილი;

ზურაბ ბეჟაშვილი

(540)



(591) რუხი, თეთრი

(531) 23.01.01; 28.19; 29.01.12

(526) საქართველო

(511)

25 – ტანსაცმელი, ფეხსაცმელი, თავსაბურავი.

(260) AM 2023 120048 A

(210) AM 120048

(220) 2022 10 27

(731) ოი კარლ ფაზერ აბ

ფაზერინტიე 6, 01230 ვანტა, ფინეთი

(740) შალვა გვარამაძე

(540)

WIENER NOUGAT

(591) შავ-თეთრი

(511)

30 – ბრინჯი, მაკარონი (პასტა) და ატრია; ტაპიოკა და საგო; ფქვილი და მარცვლეულისგან დამზადებული პრეპარატები; პური; საკვები ყინულები; შაქარი, თაფლი, ბადაგი; საფუარი, საცხობი ფხვნილი; მარილი, საკაზმები, სანელებლები, დაკონსერვებული მცენარეული; მმარი, სოუსები და სხვა სანელებლები; ყინული (გაყინული წყალი).

(260) AM 2023 120240 A

(210) AM 120240

(220) 2022 11 08

(731) ეკატერინე ცხადაძე

დავით გურამიშვილის გამზ. 1, ბ. 10,

თბილისი, საქართველო;

გიორგი ხეჩუაშვილი

ბადრი შოშიტაიშვილის ქ., ჩიხი 6, ბ. 9,

თბილისი, საქართველო

(540)



(591) შავ-თეთრი

(531) 05.01.01; 05.01.02; 05.01.08; 07.01.01;

07.01.08; 07.01.12; 27.05.01; 27.05.10

(511)

33 – ალკოჰოლური სასმელები, ლუდის გარდა; ალკოჰოლური შედგენილობები სასმელების დასამზადებლად.

35 – რეკლამა; ბიზნესის მართვა; ბიზნესის ადმინისტრირება; საოფისე მომსახურება.

(260) AM 2023 120252 A

(210) AM 120252

(220) 2022 11 09

(731) შპს „პატარა ჩილიკ“

დოლაბაურის მოედ. 4, ბ. 2, ისნის რაიონი,

თბილისი, საქართველო

(540)



(591) მუქი ლურჯი, ლურჯი, წითელი, თეთრი

(531) 26.04.16; 26.04.22; 26.13.25; 29.01.13

(511)

29 – ხორცი, თევზი, ფრინველი და ნანადირევი; ხორცის ექსტრაქტები; დაკონსერვებული, გაყინული, გამხმარი და მოხარშული ან შემწვარი ხილი და ბოსტნეული; ყელეები, ხილფაფები, კომპოტები; კვერცხი; რძე, ყველი, კარაქი, იოგურტი და რძის სხვა პროდუქტები; საკვები ზეთები და ცხიმები.

30 – ყავა, ჩაი, კაკაო და ყავის შემცვლელი; ბრინჯი, მაკარონი და ატრია; ტაპიოკა და საგო; ფქვილი და მარცვლეულის პროდუქტი; პურ-ფუნთუშეული, მაკარონი და საკონდიტრო ნაწარმი; შოკოლადი; ნაყინი, შარბათი და სხვა საკვები ყინული; შაქარი, თაფლი, ბადაგი; საფუარი, საცხობი ფხვნილები; მარილი, სანელებლები, საკმაზები, დაკონსერვებული მწვანილი; მმარი, საწებლები და სხვა საკმაზი; ყინული (გაყინული წყალი).

35 – რეკლამა; ბიზნესის მართვა; ბიზნესის ადმინისტრირება; საოფისე მომსახურება.

43 – საკვებით და სასმელით უზრუნველყოფა; დროებითი საცხოვრებელი უზრუნველყოფა.

(260) AM 2023 120257 A

(210) AM 120257

(220) 2022 11 10

(731) შპს „ჰეკა ბიოტექ“

ეგნატე ნინოშვილის ქ. 2, სართ. 15, ბ. 1506, 6010, ბათუმი, საქართველო

(740) გიორგი ბათლიძე

(540)



(591) 1E1A1A და შავი, 000000 მუქი შავი, 2762EA ლურჯი, 37BAFC ცისფერი, 00009B მუქი ლურჯი, FFFFFF თეთრი

(531) 01.13.01; 01.13.15; 27.05.01; 27.05.10; 29.01.12

(511)

3 – არასამკურნალო კოსმეტიკური პრეპარატები და ტუალეტის პრეპარატები; არასამკურნალო კბილის პასტები და კბილის ფხვნილები; პარფიუმერია, ეთერზეთები; მათეთრებელი პრეპარატები და სხვა სარეცხი საშუალებები; საწმენდი, საპრიალებელი, სახეხი და აბრაზიული პრეპარატები.

5 – ფარმაცევტული, სამედიცინო და ვეტერინარული პრეპარატები; სამედიცინო დანიშნულების ჰიგიენური პრეპარატები; სამედიცინო ან ვეტერინარული გამოყენებისთვის ვარგისი დიეტური საკვები და ნივთიერებები, საკვები ჩვილებისთვის; დიეტური დანამატები ადამიანებისა და ცხოველებისთვის; ლეიკოპლასტირი, სახვევი მასალა; კბილების დასამაგრებელი მასალა, სტომატოლოგიური ცვილი; სადეზინფექციო საშუალებები; მავნე მწერების გასანადგურებელი პრეპარატები; ფუნგიციდები, ჰერბიციდები.

44 – სამედიცინო მომსახურება; ვეტერინარული მომსახურება; ჰიგიენური და კოსმეტიკური მომსახურება ადამიანებისა და ცხოველებისთვის; მომსახურება სოფლის მეურნეობის, მეზღვეობისა და მეტყევეობის სფეროში.

(260) AM 2023 120259 A

(210) AM 120259

(220) 2022 11 10

(731) ტოიოტა ჯიდომა კაბუშიკი კაიმა

(მოვაჭრე, როგორც ტოიოტა მოტორ კორპორეიშენ)

1, ტოიოტა-ჩო, ტოიოტა-ში, აიჩი-კენ, იაპონია

(740) თამარ კოჭლამაზაშვილი

(540)

LFR

(591) შავ-თეთრი

(511)

12 – ავტომობილები და მათი ნაწილები, კონსტრუქციის ელემენტები, მათთვის განკუთვნილი მზიდი ნაწილები.

(260) AM 2023 120339 A

(210) AM 120339

(220) 2022 11 14

(731) დავითი გოგიჩაიშვილი

გუდამაყრის ქ. 4დ, ბ. 4, 0141, თბილისი, საქართველო

(740) მარიამ გოგიტიძე

(540)



ვილა გემრიელა

(591) შავ-თეთრი

(531) 03.07.03; 14.05.02; 27.05.01; 28.19

(511)

3 – არასამკურნალო კოსმეტიკური პრეპარატები და ტუალეტის პრეპარატები; არასამკურნალო კბილის პასტები და კბილის ფხვნილები; პარფიუმერია, ეთერზეთები; მათეთრებელი პრეპარატები და სხვა სარეცხი საშუალებები; საწმენდი, საპრიალებელი, სახეხი და აბრაზიული პრეპარატები.

30 – ყავა, ჩაი, კაკაო და ყავის შემცველები; ბრინჯი, მკარონი და ატრია; ტაპიოკა და საგო; ფქვილი და მარცვლეულის პროდუქტი; პურ-

ფუნთუშეული, მაკარონი და საკონდიტრო ნაწარმი; შოკოლადი; ნაყინი, შარბათი და სხვა საკვები ყინული; შაქარი, თაფლი, ბადაგი; საფუარი, საცხობი ფხვნილები; მარილი, სანელებლები, საკმაზები, დაკონსერვებული მწვანილი; ძმარი, საწებლები და სხვა საკმაზი; ყინული (გაყინული წყალი).

31 – სოფლის მეურნეობის, მეზღვეობის და მეტყვეობის დაუმუშავებელი პროდუქტი; ნედლი და დაუმუშავებელი მარცვლეული და თესლეული; ახალი ხილი და ბოსტნეული, ახალი მწვანილი; ბუნებრივი მცენარეულობა და ყვავილები; სათესლე ბოლქვები და თესლი; ცოცხალი ცხოველები; ცხოველთა საკვები და სასმელი ალაო.

32 – ლუდი; არალკოჰოლური სასმელები; მინერალური და გაზიანი წყლები; ხილის სასმელები და წვენები; სიროფები და სხვა არალკოჰოლური შედგენილობები სასმელების დასამზადებლად.

33 – ალკოჰოლური სასმელები, ლუდის გარდა; ალკოჰოლური შედგენილობები სასმელების დასამზადებლად.

39 – ტრანსპორტირება; საქონლის შეფუთვა და დასაწყობება; მოგზაურობის ორგანიზება.

43 – საკვებით და სასმელით უზრუნველყოფა; დროებითი საცხოვრებელი უზრუნველყოფა.

(260) AM 2023 120358 A

(210) AM 120358

(220) 2022 11 16

(731) შპს „ოცი“

სიმონ ჩიქოვანის ქ. 24ა, ბ. 62ა, თბილისი, საქართველო

(540)

OTSY

(591) შავ-თეთრი

(511)

43 – საკვებითა და სასმელით უზრუნველყოფა; საკვებისა და სასმელის მომზადების მომსახურება; რესტორნის მიერ გაწეული მომსახურება; საკვების შეკვეთით დამზადებისა და ადგილზე მიტანის მომსახურება (ქეითერინგი); ბარის მიერ გაწეული მომსახურება; სასაუზმეების მიერ გაწეული მომსახურება; კაფეტერიების მიერ გაწეული მომსახურება; კოქტეილ-ბარების მიერ გაწეული მომსახურება; ჩაის ოთახები; ბისტრო; პიცერია; ბარ-რესტორნების მიერ გაწეული მო-

მსახურება; თვითმომსახურების რესტორნების მიერ გაწეული მომსახურება; მობილური რესტორნების მიერ გაწეული მომსახურება; საკვებითა და სასმელით უზრუნველყოფა ინტერნეტ-კაფეებში; რესტორნები საკვების გატანის მომსახურებით; საკვების გასატანად მომზადების მომსახურება; ქველმოქმედების მომსახურება, კერძოდ, საკვებისა და სასმელის დარიგება გაჭირვებულებისათვის; რესტორნებსა და ბარებში საკვებისა და სასმელის მიწოდება; რესტორნებსა და ბარებში საკვებითა და სასმელით უზრუნველყოფა; დროებითი რესტორნების მიერ გაწეული მომსახურება; საკვებისა და სასმელის გატანის მომსახურება, კერძოდ, რესტორნიდან გატანის მომსახურება თვითონ ან მიტანით; საკვებისა და სასმელის მომზადება და მიწოდება დაუყოვნებლივ მოხმარებისათვის; დროებითი საცხოვრებელი უზრუნველყოფა; სასტუმროს მიერ გაწეული მომსახურება.

(260) AM 2023 120359 A

(210) AM 120359

(220) 2022 11 16

(731) პერსონალურ მონაცემთა დაცვის სამსახური ნ. ვაჩნაძის ქ. 7, 0105, თბილისი, საქართველო

(540)



(591) 5DA28F ღია ზურმუხტისფერი, 114656 მუქი ფირუზისფერი

(531) 02.09.14; 26.04.03; 26.11.03; 26.11.06; 26.11.09; 26.11.10; 26.11.11; 26.11.12; 29.01.12

(511)

45 – იურიდიული მომსახურება; მატერიალური ქონებისა და პიროვნებების ფიზიკური დაცვის სამსახური; პერსონალური და სოციალური მომსახურება, გაწეული სხვათა მიერ ინდივიდების საჭიროებების დასაკმაყოფილებლად.

(260) AM 2023 120435 A

(210) AM 120435

(220) 2022 11 21

(731) ინტელ კორპორეიშენ

2200 მიშენ კოლიჯ ბულვარი, სანტა-
კლარა, კალიფორნია 95052, აშშ
(740) თამაზ შილაკაძე
(540)

 **GRANULATE**

(591) შავ-თეთრი
(531) 25.07.03; 26.04.01; 26.04.09; 27.01.02;
27.05.01; 27.05.21
(511)

9 – პროგრამული უზრუნველყოფა ღრუბელზე დაფუძნებული აპლიკაციების ოპტიმიზაციისთვის; პროგრამული უზრუნველყოფა ქსელის ეფექტურობისა და ქსელური ანალიტიკის ასამაღლებლად.

(260) AM 2023 120440 A
(210) AM 120440
(220) 2022 11 22

(731) ტოიოტა ჯიდომა კაბუშიკი კაიმა
(მოვაჭრე, როგორც ტოიოტა მობორ
კორპორეიშენ)
1, ტოიოტა-ჩო, ტოიოტა-ში, აიჩი-კენ,
იაპონია

(740) თამარ კოჭლამაზაშვილი
(540)

RX450h+

(591) შავ-თეთრი
(511)
12 – ავტომობილები და მათი ნაწილები, კონსტრუქციის ელემენტები, მათთვის განკუთვნილი მზიდი ნაწილები.

(260) AM 2023 120448 A
(210) AM 120448
(220) 2022 11 24

(731) შპს „ფრაგმა“
გურამ რჩელიშვილის ქ. 11, 0179,
მთაწმინდის რაიონი, თბილისი,
საქართველო

(540)

 **FRAGMA
DEVELOPMENT**

(591) 000000 თეთრი, FFFFFFF შავი
(531) 26.03.23; 26.11.01; 26.11.08; 27.05.01;
27.05.22

(511)
37 – სამშენებლო მომსახურება.

(260) AM 2023 120497 A
(210) AM 120497
(220) 2022 11 25
(731) შპს „მ² ჯგუფი“
ალექსანდრე ყაზბეგის გამზ. 15, სართ. 4,
ბლოკი დ, 0179, თბილისი, საქართველო
(540)



(591) სტაფილოსფერი, ნარინჯისფერი, თეთრი
(531) 24.17.05; 24.17.07; 24.17.09; 24.17.25;
27.05.21; 27.07.21; 29.01.12

(511)
36 – დაზღვევა; ფინანსებთან დაკავშირებული საქმიანობა; ფულად-საკრედიტო ოპერაციები; უძრავ ქონებასთან დაკავშირებული ოპერაციები.

37 – მშენებლობა; რემონტი.

(260) AM 2023 120498 A
(210) AM 120498
(220) 2022 11 25

(731) შპს „მ² ჯგუფი“
ალექსანდრე ყაზბეგის გამზ. 15, სართ. 4,
ბლოკი დ, 0179, თბილისი, საქართველო
(540)



(591) სტაფილოსფერი, ნარინჯისფერი, შავი
(531) 24.17.05; 24.17.07; 24.17.09; 24.17.25;
26.04.01; 26.04.05; 26.04.18; 26.04.24;
27.05.21; 27.07.21; 29.01.13

(511)
36 – დაზღვევა; ფინანსებთან დაკავშირებული საქმიანობა; ფულად-საკრედიტო ოპერაციები; უძრავ ქონებასთან დაკავშირებული ოპერაციები.

37 – მშენებლობა; რემონტი.

(260) AM 2023 120499 A
(210) AM 120499
(220) 2022 11 25
(731) შპს „მ² ჯგუფი“

ალექსანდრე ყაზბეგის გამზ. 15, სართ. 4,
ბლოკი დ, 0179, თბილისი, საქართველო

(540)



(591) შავ-თეთრი
(531) 24.17.05; 24.17.07; 24.17.09; 26.04.01;
26.04.05; 26.04.18; 26.04.24; 27.05.21;
27.05.24; 27.07.21; 27.07.24

(511)
36 – დაზღვევა; ფინანსებთან დაკავშირებული საქმიანობა; ფულად-საკრედიტო ოპერაციები; უძრავ ქონებასთან დაკავშირებული ოპერაციები.

37 – მშენებლობა; რემონტი.

(260) AM 2023 120504 A
(210) AM 120504
(220) 2022 11 28

(731) შპს „კახური ტრადიციული მეღვინეობა“
სულხან ცინცაძის ქ. 12, სართ. 3, არასაცხოვრებელი ფართი 3-6, 0160, თბილისი, საქართველო

(540)

მამალი
mamali
мамали

(591) შავ-თეთრი
(511)
33 – ალკოჰოლური სასმელები, ლუდის გარდა.

(260) AM 2023 120510 A
(210) AM 120510
(220) 2022 11 28

(731) ვერონიკა გამიევა
მეტროლოგიჩნა სტ. 113, აპარტამენტ 42,
კიევი, უკრაინა
(740) ივანე გოგლიძე

(540)

WORLD
PROFICARE
ACADEMY

(591) EC268F ვარდისფერი, 373435 შავი
(531) 26.04.02; 26.04.22; 26.04.24; 27.05.12;
27.05.24; 29.01.12

(511)
41 – განათლება; სასწავლო პროცესის უზრუნველყოფა; გართობა; სპორტული და კულტურული ღონისძიებები.

(260) AM 2023 120511 A
(210) AM 120511
(220) 2022 11 28

(731) ვერონიკა გამიევა
მეტროლოგიჩნა სტ. 113, აპარტამენტ 42,
კიევი, უკრაინა
(740) ივანე გოგლიძე

(540)

WORLD
PROFICARE
GROUP

(591) 373435 შავი, EC268F ვარდისფერი
(531) 26.04.02; 26.04.05; 26.04.22; 26.04.24;
27.05.01; 27.05.24; 29.01.12

(511)
3 – არასამკურნალო კოსმეტიკური პრეპარატები და ტუალეტის პრეპარატები; არასამკურნალო კბილის პასტები და კბილის ფხვნილები; პარფიუმერია, ეთერზეთები; მათეთრებელი პრეპარატები და სხვა სარეცხი საშუალებები; საწმენდი, საპრიალებელი, სახეხი და აბრაზიული პრეპარატები.

11 – განათების, გათბობის, გაგრილების, ორთქლწარმოქმნის, საჭმლის მომზადების, საშრობი, სავენტილაციო, წყალმომარაგების და სანიტარული აპარატურა და დანადგარები.

43 – საკვებით და სასმელით უზრუნველყოფა; დროებითი საცხოვრებელი უზრუნველყოფა.

44 – სამედიცინო მომსახურება; ვეტერინარული მომსახურება; ჰიგიენური და კოსმეტიკური მომსახურება ადამიანებისა და ცხოველებისთვის; მომსახურება სოფლის მეურნეობის, მეზღვეობისა და მეტყვეობის სფეროში.

(260) AM 2023 120512 A

(210) AM 120512

(220) 2022 11 28

(731) შპს „999“

სოფ. მულანლო მე-16 ქ. 11, გარდაბნის რაიონი, საქართველო

(540)



(591) ცისფერი, მწვანე, თეთრი, ყვითელი, შავი

(531) 10.03.10; 10.03.11; 10.03.13; 25.05.02;

26.01.16; 26.01.22; 26.01.24; 28.19; 29.01.14

(511)

35 – რეკლამა; ბიზნესის მართვა; ბიზნესის ადმინისტრირება; საოფისე მომსახურება.

(260) AM 2023 120515 A

(210) AM 120515

(220) 2022 11 29

(731) სს „კოტეხი-გურჯაანის ღვინის ქარხანა“

კ. ქოროლიშვილის ქ. 38, 1500, გურჯაანი, საქართველო

(740) დიმიტრი ძამუკაშვილი

(540)

თბილისური ამბავი TBILISURI AMBAVI

(591) შავ-თეთრი

(511)

33 – ალკოჰოლიანი სასმელები (ლუდის გარდა).

(260) AM 2023 120517 A

(210) AM 120517

(220) 2022 11 29

(731) შპს „აიდიეს ბორჯომი ბევერიჯიზ კომპანი“

პარერავეგის 45, კურასაო

(740) გიორგი ჯოხარიძე

(540)

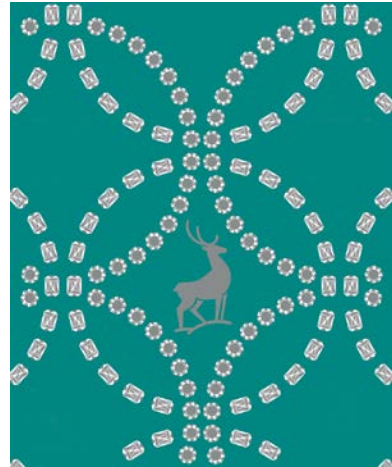

(591) მწვანე (ე.წ. „ბორჯომის მწვანე“ ან „ქართული მწვანე“), ნაცრისფერი, თეთრი, ღია ნაცრისფერი

(531) 01.15.19; 03.04.07; 25.01.25; 26.01.01; 26.04.02; 26.13.25; 29.01.03

(511)

32 – მინერალური წყლები, არაალკოჰოლური სასმელები.

35 – რეკლამა.

(260) AM 2023 120520 A

(210) AM 120520

(220) 2022 11 30

(731) შპს „იმპექსფარმი“

გიორგი სააკაძის II გასას. 17, 0160, თბილისი, საქართველო

(740) ნუგზარ ქსოვრელი

(540)

CLAVICID

(591) შავ-თეთრი

(511)

5 – ფარმაცევტული, სამედიცინო და ვეტერინარული პრეპარატები; სამედიცინო დანიშნულების ჰიგიენური პრეპარატები; სამედიცინო ან ვეტერინარული გამოყენებისთვის ვარგისი დიეტური საკვები და ნივთიერებები, საკვები ჩვილებისთვის; დიეტური დანამატები ადამიანებისა და ცხოველებისთვის; ლეიკოპლასტიკი, სახვევი მასალა; კბილების დასამაგრებელი მასალა, სტომატოლოგიური ცვილი; სადეზინფექციო საშუალებები; მავნე მწერების გასანადგურებელი პრეპარატები, ფუნგიციდები, ჰერბიციდები.

(260) AM 2023 120524 A
 (210) AM 120524
 (220) 2022 11 30
 (731) შპს „ეი-ბი-ეფ“
 სოფ. მარტყოფი, ვაზიანის დასახ. 1320,
 გარდაბანი, საქართველო
 (540)



(591) მოლოურჯო, თეთრი
 (531) 02.09.14; 05.07.10; 27.01.12; 29.01.04
 (511)

32 – ლუდი; არაალკოჰოლური სასმელები; მი-
 ნერალური და გაზიანი წყლები; ხილის სასმე-
 ლები და წვენები; სიროფები და სხვა არაალკო-
 ჰოლური შედგენილობები სასმელების დასამ-
 ზადებლად.

33 – ღვინოები, კერძოდ, სუფრის, ცქრიალა, შე-
 მაგრებული და დესერტის ღვინოები; ლიქიო-
 რი; ბრენდი; არაყი.

(260) AM 2023 120527 A
 (210) AM 120527
 (220) 2022 12 01
 (731) რუსლან ბოლქვაძე
 ივანე ჯავახიშვილის ქ. 78, ბ. 48, ბათუმი,
 საქართველო
 (540)

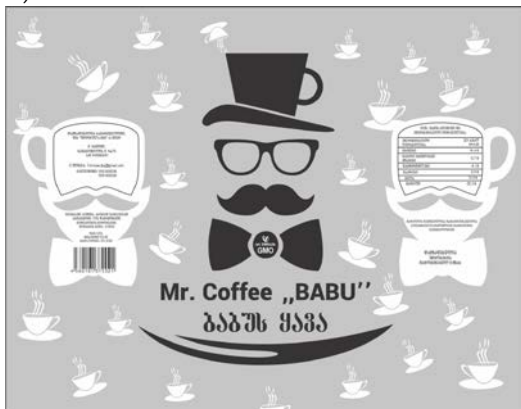

(591) შავი, თეთრი, რუხი
 (531) 01.15.11; 02.01.23; 02.09.12; 09.03.13;
 09.03.20; 11.03.04; 25.01.19; 25.07.25
 (511)
 30 – ყავა.

(260) AM 2023 120530 A
 (210) AM 120530
 (220) 2022 12 01
 (731) ენრიკო ბერიძე
 გ. ციციშვილის ქ. 18, თბილისი,
 საქართველო
 (740) სალომე ჯელაძე
 (540)



(591) შავ-თეთრი
 (531) 01.15.24; 05.07.10; 06.01.01; 06.01.04;
 24.13.01; 24.13.09; 24.13.22; 25.05.05;
 25.05.25; 26.05.01; 26.05.09; 26.11.13

(511)
 16 – ქაღალდი და მუყაო; ნაბეჭდი მასალა; საამ-
 კინძაო მასალა; ფოტოფირები; საკანცელარიო
 და საოფისე საკუთვნო, ავეჯის გარდა; საკანცე-
 ლარიო და საყოფაცხოვრებო დანიშნულების
 წებოები; მხატვრების საკუთვნო და სახატავი
 მასალა; სახატავი ფუნჯები; სასწავლო და სადე-
 მონსტრაციო მასალა; პლასტმასის ფურცლები,
 ფირები და ტომრები, როგორც შესაფუთი მასა-
 ლა; ტიპოგრაფიული შრიფტები, ტიპოგრაფიუ-
 ლი კლიშეები.

33 – ალკოჰოლური სასმელები, ლუდის გარდა;
 ალკოჰოლური შედგენილობები სასმელების
 დასამზადებლად.

35 – რეკლამა; ბიზნესის მართვა; ბიზნესის ად-
 მინისტრირება; საოფისე მომსახურება.

(260) AM 2023 120531 A
 (210) AM 120531
 (220) 2022 12 01
 (731) შენჟენ ფორსაით ინოვეიშენს ტექნოლოჯი
 კო., ლტდ.
 ფლორ 4, 1#ლიჩუნ ბილდინგ, ტაიპუავეუ-

ტონგ ინდასტრიალ პარკ, სანჯეი კომი-
უნითი, ჰანგჩენგ საბ-დისტრიქტ, ბაო'ან
დისტრიქტ, შენჯენი, ჩინეთის სახალხო
რესპუბლიკა

(740) გიორგი ქართველიშვილი
(540)

VOZOL

(591) შავ-თეთრი
(531) 27.05.01
(511)

34 – სიგარეტები; ელექტრო სიგარეტები; თხევადი ნიკოტინის ხსნარი ელექტრო სიგარეტებში გამოსაყენებლად; პირიდან გამოსაოროთქლებლები მწვევლთათვის; თამბაქოს შემცველები, გარდა სამედიცინო და სამკურნალო მიზნებისა; მუნდშტუკები; სიგარეტის მილაკები; პორტსიგარები; სიგარეტები თამბაქოს შემცველებით, არასამედიცინო მიზნებისთვის; არომატული ნივთიერებები ელექტრო სიგარეტებში გამოსაყენებლად, ეთერზეთების გარდა.

(260) AM 2023 120598 A
(210) AM 120598
(220) 2022 12 02
(731) შპს „ლიგალის სუფორტ“
ციფშიძის ქ. 9, ბ. 57, თბილისი,
საქართველო
(540)



(591) ყავისფერი, ლურჯი, ცისფერი
(531) 17.03.01; 17.03.02; 26.01.01; 26.01.16;
26.01.20; 27.05.01; 29.01.13
(511)

45 – იურიდიული მომსახურება; მატერიალური ქონებისა და პიროვნებების ფიზიკური დაცვის სამსახური; პერსონალური და სოციალური მომსახურება, გაწეული სხვათა მიერ ინდივიდუალის საჭიროებების დასაკმაყოფილებლად.

(260) AM 2023 120604 A
(210) AM 120604
(220) 2022 12 02
(731) ჰამიდი შარიათი
ციფშიძის ქ. 3ბ, თბილისი, საქართველო
(540)

IMPERATOR CLUB

იმპერატორის კლუბი

(591) 000000 შავი, FFFFFFFF თეთრი
(511)
43 – საკვებით და სასმელით უზრუნველყოფა; დროებითი საცხოვრებლით უზრუნველყოფა.

(260) AM 2023 120606 A
(210) AM 120606
(220) 2022 12 02
(731) ჰამიდი შარიათი
ციფშიძის ქ. 3ბ, თბილისი, საქართველო
(540)



(591) D31010 წითელი, FFFFFFFF თეთრი
(531) 26.02.07; 26.02.08; 26.02.12; 26.02.16; 28.01;
29.01.12
(511)
43 – საკვებით და სასმელით უზრუნველყოფა; დროებითი საცხოვრებლით უზრუნველყოფა.

(260) AM 2023 120607 A
(210) AM 120607
(220) 2022 12 02
(731) შპს „ამადაამ“
სულხან ცინცაძის ქ. 26, ბლოკი V, ბ. 8-01,
0160, საბურთალოს რაიონი, თბილისი,
საქართველო
(540)

დათამემ

(591) შავ-თეთრი
(511)
42 – სამეცნიერო და ტექნოლოგიური მომსახურება და შესაბამისი სამეცნიერო კვლევები და გაფორმება; სამრეწველო ანალიზი, სამრეწველო კვლევა და სამრეწველო დიზაინი; ხარისხის კო-

ნტროლისა და ავთენტურობის დადგენის სამსახური; კომპიუტერებისა და კომპიუტერული პროგრამების შექმნა და დამუშავება.

(260) AM 2023 120608 A

(210) AM 120608

(220) 2022 12 02

(731) შპს „ბატონო“

გოთუას ქ. 8, 0160, თბილისი, საქართველო

(540)



(591) თეთრი, მწვანე, რუხი, სპილენძისფერი,

შავი, წითელი

(531) 02.01.03; 05.01.03; 05.01.11; 06.01.02;

06.01.04; 07.01.03; 11.03.02; 19.09.02;

27.05.01; 28.05; 28.19; 29.01.15

(511)

33 – ალკოჰოლური სასმელები, ლუდის გარდა; ალკოჰოლური შედგენილობები სასმელების დასამზადებლად.

(260) AM 2023 120610 A

(210) AM 120610

(220) 2022 12 04

(731) სს „სადაზღვევო კომპანია ალდაგი“

დავით აღმაშენებლის ხეივანი 66ა, 0171,

საბურთალოს რაიონი, თბილისი,

საქართველო

(540)



(591) A88B74 მუქი ოქროსფერი, BBAC90

ოქროსფერი

(531) 02.09.17; 26.11.12; 28.19; 29.01.02

(511)

16 – ქაღალდი, მუყაო და მათი ნაკეთობა, რომელიც არ მიეკუთვნება სხვა კლასებს; ნაბეჭდი პროდუქცია; მასალები საამკინძაო სამუშაოებისთვის; ფოტოსურათები; საწერ-ქაღალდის საქონელი; საკანცელარიო და საყოფაცხოვრებო დანიშნულების მწებავი ნივთიერებები; მხატვართა საკუთნო; ფუნჯები; საბეჭდი მანქანები და ოფისის საკუთნო (ავეჯის გარდა); სასწავლო მასალა და თვალსაჩინოება (ხელსაწყოების გარდა); პლასტმასის შესაფუთი მასალა (რომელიც არ მიეკუთვნება სხვა კლასებს); შრიფტი; ტიპოგრაფიული კლიშე.

36 – დაზღვევა; ფინანსებთან დაკავშირებული საქმიანობა; ფულად-საკრედიტო ოპერაციები; უძრავ ქონებასთან დაკავშირებული ოპერაციები.

(260) AM 2023 120612 A

(210) AM 120612

(220) 2022 12 05

(731) შპს „კლინტექ“

ჩიტაძის ქ. 6, ოთახი 505, 0144, თბილისი,

საქართველო

(540)



(591) 0C0B0B შავი

(531) 26.11.08; 27.05.01; 27.05.09; 27.05.10;

27.05.11

(511)

3 – არასამკურნალო კოსმეტიკური პრეპარატები და ტუალეტის პრეპარატები; არასამკურნალო კბილის პასტები და კბილის ფხვნილები; პარ-

ფიუმერია, ეთერზეთები; მათეთრებელი პრეპარატები და სხვა სარეცხი საშუალებები; საწმენდი, საპრიალებელი, სახეხი და აბრაზიული პრეპარატები.

25 – ტანსაცმელი, ფეხსაცმელი, თავსაბურავი.

(260) AM 2023 120613 A

(210) AM 120613

(220) 2022 12 05

(731) სს „სადაზღვევო კომპანია ალდაგი“
დავით აღმაშენებლის ხეივანი 66ა, 0171,
საბურთალოს რაიონი, თბილისი,
საქართველო

(540)



(591) 17BEBB ცისფერი, 25FFDB ღია ცისფერი,
000000 შავი

(531) 24.15.02; 24.15.11; 24.15.15; 28.19; 29.01.13

(511)

16 – ქაღალდი, მუყაო და მათი ნაკეთობა, რომელიც არ მიეკუთვნება სხვა კლასებს; ნაბეჭდი პროდუქცია; მასალები საამკინძაო სამუშაოებისთვის; ფოტოსურათები; საწერ-ქაღალდის საქონელი; საკანცელარიო და საყოფაცხოვრებო დანიშნულების მწებავი ნივთიერებები; მხატვართა საკუთონო; ფუნჯები; საბეჭდი მანქანები და ოფისის საკუთონო (ავეჯის გარდა); სასწავლო მასალა და თვალსაჩინოება (ხელსაწყოების გარდა); პლასტმასის შესაფუთი მასალა (რომელიც არ მიეკუთვნება სხვა კლასებს); შრიფტი; ტიპოგრაფიული კლიში.

35 – რეკლამა; მართვა საქმიან სფეროში; ადმინისტრირება საქმიან სფეროში; საოფისე სამსახური.

36 – დაზღვევა; ფინანსებთან დაკავშირებული საქმიანობა; ფულად-საკრედიტო ოპერაციები; უძრავ ქონებასთან დაკავშირებული ოპერაციები.

(260) AM 2023 120618 A

(210) AM 120618

(220) 2022 12 05

(731) ფილიპ მორის პროდაქტს ს.ა.

კე ჟანრენო 3, 2000 ნევმატელი, შვეიცარია

(740) პავლე მეიფარიანი

(540)

ჰიტოს სათინ ვეივი

(591) შავ-თეთრი

(511)

34 – სადენიანი გამოსაორთქლებლები („ვაპორაიზერები“ ან „ვეიპორაიზერები“) ელექტრონული სიგარეტებისათვის და მოწვევისათვის განკუთვნილი ელექტრონული მოწყობილობებისათვის; დაუმუშავებელი ან დამუშავებული თამბაქო; თამბაქოს ნაწარმი სიგარეტის, სიგარეტების, პაპიროსების, სიგარილოების, თვითგახვევადი (თვითნაკეთი) სიგარეტებისათვის განკუთვნილი თამბაქოს, ჩიბუხის თამბაქოს, სადეჰი თამბაქოს, საბურნუთე თამბაქოსა და კრეტეკის ჩათვლით; სნუსი; თამბაქოს შემცვლელები (არასამედიცინო დანიშნულების); მწვევლთა საკუთვნო, სიგარეტის და პაპიროსის ქაღალდისა და მილაკების (ჰილზების), სიგარეტის ფილტრების, თამბაქოსათვის განკუთვნილი ქილების, სიგარეტის კოლოფების (პორტსიგარეტის), საფერფლებების, ჩიბუხების, სიგარეტის გასახვევად განკუთვნილი ჯიბის მოწყობილობებისა და სანთებლების ჩათვლით; ასანთი; თამბაქოს ჩხირები (თამბაქოს „სტიკები“), თამბაქოს ნაწარმი მათი შემდგომი გახურების მიზნით, ელექტრონული მოწყობილობები და მათი ნაწილები სიგარეტების ან თამბაქოს გასახურებლად ნიკოტინის შემცველი აეროზოლის გამოყოფისათვის შესუნთქვის მიზნით; თხევადი ნიკოტინის ხსნარები ელექტრონულ სიგარეტებში გამოსაყენებლად; მოწვევისათვის განკუთვნილი ელექტრონული მოწყობილობები; ელექტრონული სიგარეტები; ელექტრონული სიგარეტები, როგორც ტრადიციული სიგარეტების შემცვლელი; ელექტრონული მოწყობილობები ნიკოტინის შემცველი აეროზოლის შესუნთქვისათვის; ორალური დანიშნულების გამოსაორთქლებელი მოწყობილობები მწვევლთათვის, თამბაქოს პროდუქცია და თამბაქოს შემცვლელი; მწვევლთა საკუთვნო ელექტრონული სიგარეტებისათვის; ნაწილები და ფიტინგები 34-ე კლასში შემავალი ზემოთ ჩამოთვლილი ნაწარმისათვის; მოწყობილობები გახურებული სიგარეტების, სიგარეტის და, ასევე, გახურებული თამბაქოს ჩხირების ჩასაქრობად; პორტსიგარები (კოლოფები) ელექტრონული მრავალჯერადად დასატენი სიგარეტებისათვის.

(260) AM 2023 120628 A
(210) AM 120628
(220) 2022 12 08
(731) შპს „კახური ტრადიციული მეღვინეობა“
ს. ცინცაძის ქ. 12, 0160, თბილისი,
საქართველო
(540)

ბატონელი
Batoneli
Батонели

(591) შავ-თეთრი
(511)
33 – ალკოჰოლური სასმელები (ლუდის გარდა).

(260) AM 2023 120629 A
(210) AM 120629
(220) 2022 12 08
(731) შპს „კახური ტრადიციული მეღვინეობა“
ს. ცინცაძის ქ. 12, 0160, თბილისი,
საქართველო
(540)

ია ბატონიშვილი
Ia Batonishvili
Ия Батонишвили

(591) შავ-თეთრი
(511)
33 – ალკოჰოლური სასმელები (ლუდის გარდა).

(260) AM 2023 120735 A
(210) AM 120735
(220) 2022 12 15
(731) შპს „ოროველა“
სოფ. ჩაბინაანი, 0910, ახმეტის რაიონი,
საქართველო
(540)

შავი შაშვი
shavi shashvi

(591) შავ-თეთრი
(511)
32 – ლუდი; არაალკოჰოლური სასმელები; მი-
ნერალური და გაზიანი წყლები; ხილის სასმე-
ლები და წვენები; სიროფები და სხვა არაალკო-

ჰოლური შედგენილობები სასმელების დასამ-
ზადებლად.

33 – ალკოჰოლური სასმელები, ლუდის გარდა;
ალკოჰოლური შედგენილობები სასმელების
დასამზადებლად.

(260) AM 2023 120827 A
(210) AM 120827
(220) 2022 12 20
(731) მონსტერ ენერჯი კომპანი, დელავერის
შტატის კორპორაცია
1 მონსტერ უეი, კორონა, კალიფორნიის
შტატი 92879, აშშ
(740) თამაზ შილაკაძე
(540)

PREDATOR ENERGY GOLD
STRIKE

(591) შავ-თეთრი
(511)
32 – უალკოჰოლო სასმელები.

(260) AM 2023 120833 A
(210) AM 120833
(220) 2022 12 20
(731) ნობელ ფუდ ინდასტრი ლლკ
ნიზამის დასახ. ჰეიდარ ალიევის გამზ.,
სახლი 92ა, ბლოკი 2023, ბაქო, AZ1029,
აზერბაიჯანი
(740) მარიამ გოგიტიძე
(540)

Nuitz

(591) შავ-თეთრი
(511)
29 – კარტოფილის ჩიფსები, დამუშავებული ქო-
ქოსი, გამომშრალი ქიშმიში, კრისტალიზებული
ხილი, გაყინული ხილი და ბოსტნეული, ფინი-
კი, თხილი, დამუშავებული არაქისი, ხილის
ჩიფსები, დამუშავებული მზესუმზირის თეს-
ლი, თესლი, უცხიმო კარტოფილის ჩიფსები /
დაბალ ცხიმოვანი კარტოფილის ჩიფსები, დამუ-
შავებული ხილის კომპოზიციები, დამაქრუ-
ლი/კარამელიზებული თხილი, არომატიზირე-
ბული თხილი / არომატიზირებული თხილეუ-
ლი, თხილი, გადამუშავებული ტკბილი სიმინ-
დი, გადამუშავებული ხილი; გამხმარი ხილი
და ბოსტნეული, გამომშრალი თხილეული.

30 – ორხეობილა, შოკოლადი, ტკბილეული,
მარცვლეულისგან დამზადებული პროდუქტე-

ბი, საკონდიტრო ნაწარმი / შაქრის საკონდიტრო ნაწარმი, სიმინდის ფანტელები, პოპკორნი, მოხალული სიმინდი, მოხალული ნუშის საკონდიტრო ნაწარმი, არაქისის საკონდიტრო ნაწარმი, ძირტკვილას ჯოხი [საკონდიტრო ნაწარმი], მარცვლეულის პროდუქტები/ჩიფსები, ხილის ჟელე, მუსლი, მარცვლეულის ფილა, შოკოლადით დაფარული თხილი, ხილის საკონდიტრო ნაწარმი.

31 – თხილი, ნუში, თხილეული, ნედლი და დაუმუშავებელი მარცვლეული და თესლეული; ახალი ხილი და ბოსტნეული, ქოქოსი.

35 – რეკლამა; ბიზნესის მართვა; ბიზნესის ადმინისტრირება; საოფისე მომსახურება.

(260) AM 2023 120834 A

(210) AM 120834

(220) 2022 12 20

(731) შპს „იფელი“

ევგენი ხარაძის ქ. 2ა, 0153, თბილისი, საქართველო

(540)

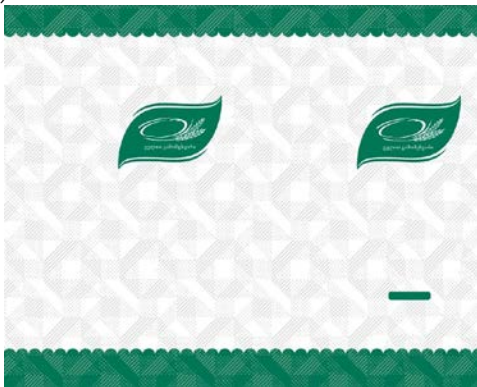

(554) მოცულობითი

(591) თეთრი, ნაცრისფერი, ღია მწვანე, მუქი მწვანე

(531) 05.03.13; 05.07.02; 19.03.24; 25.07.08; 29.01.13

(511)

30 – ყავა, ჩაი, კაკაო და ყავის შემცვლელეები; ბრინჯი, მაკარონი და ატრია; ტაპიოკა და საგო; ფქვილი და მარცვლეულის პროდუქტი; პურფუნთუშეული, მაკარონი და საკონდიტრო ნაწარმი; შოკოლადი; ნაყინი, შარბათი და სხვა საკვები ყინული; შაქარი, თაფლი, ბადაგი; საფუარი, საცხობი ფხვნილები; მარილი, სანელებლები, საკმაზები, დაკონსერვებული მწვანილი; ძმარი, საწებლები და სხვა საკმაზი; ყინული (გაყინული წყალი).

(260) AM 2023 120837 A

(210) AM 120837

(220) 2022 12 20

(731) შპს „იფელი“

ევგენი ხარაძის ქ. 2ა, 0153, თბილისი, საქართველო

(540)

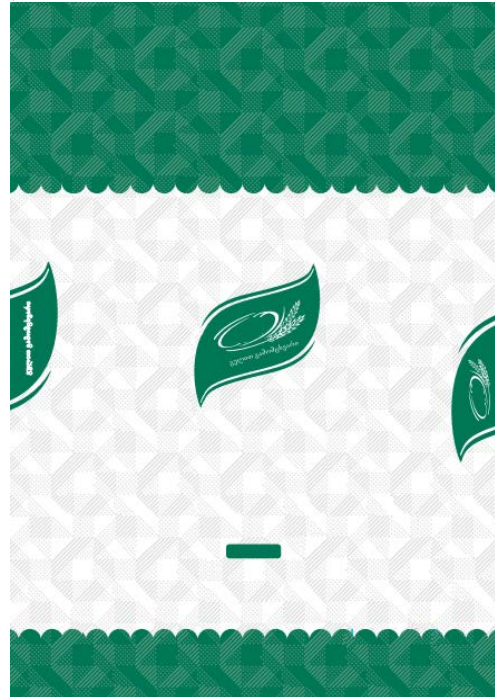

(554) მოცულობითი

(591) ღია მწვანე, მუქი მწვანე, ნაცრისფერი, თეთრი

(531) 05.03.13; 05.07.02; 19.03.24; 25.07.08; 29.01.13

(511)

30 – ყავა, ჩაი, კაკაო და ყავის შემცვლელეები; ბრინჯი, მაკარონი და ატრია; ტაპიოკა და საგო; ფქვილი და მარცვლეულის პროდუქტი; პურფუნთუშეული, მაკარონი და საკონდიტრო ნაწარმი; შოკოლადი; ნაყინი, შარბათი და სხვა საკვები ყინული; შაქარი, თაფლი, ბადაგი; საფუარი, საცხობი ფხვნილები; მარილი, სანელებლები, საკმაზები, დაკონსერვებული მწვანილი; ძმარი, საწებლები და სხვა საკმაზი; ყინული (გაყინული წყალი).

(260) AM 2023 120838 A

(210) AM 120838

(220) 2022 12 20

(731) შპს „იფელი“

ევგენი ხარაძის ქ. 2ა, 0153, თბილისი, საქართველო

(540)



(554) მოცულობითი
(591) ღია ნარინჯისფერი, ნარინჯისფერი, ღია მწვანე, მწვანე, ნაცრისფერი, თეთრი
(531) 05.03.13; 05.07.02; 19.03.24; 25.07.08; 29.01.13

(511)
30 – ყავა, ჩაი, კაკაო და ყავის შემცველები; ბრინჯი, მაკარონი და ატრია; ტაპიოკა და საგო; ფქვილი და მარცვლეულის პროდუქტი; პურ-ფუნთუშეული, მაკარონი და საკონდიტრო ნაწარმი; შოკოლადი; ნაყინი, შარბათი და სხვა საკვები ყინული; შაქარი, თაფლი, ბადაგი; საფუარი, საცხობი ფხვნილები; მარილი, სანელებლები, საკმაზები, დაკონსერვებული მწვანილი; ძმარი, საწებლები და სხვა საკმაზი; ყინული (გაყინული წყალი).

(260) AM 2023 120839 A
(210) AM 120839
(220) 2022 12 20
(731) შპს „იფელი“
ევგენი ხარაძის ქ. 2ა, 0153, თბილისი, საქართველო

(540)

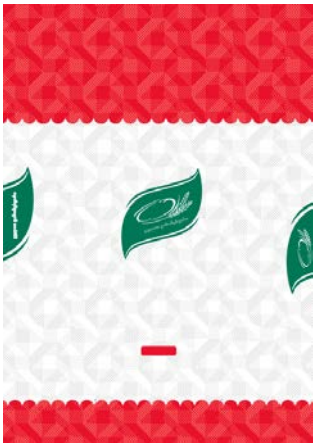

(554) მოცულობითი
(591) მწვანე, ღია მწვანე, წითელი, ღია წითელი, ნაცრისფერი, თეთრი
(531) 05.03.13; 05.07.02; 19.03.24; 25.07.08; 29.01.13

(511)
30 – ყავა, ჩაი, კაკაო და ყავის შემცველები; ბრინჯი, მაკარონი და ატრია; ტაპიოკა და საგო; ფქვილი და მარცვლეულის პროდუქტი; პურ-ფუნთუშეული, მაკარონი და საკონდიტრო ნაწარმი; შოკოლადი; ნაყინი, შარბათი და სხვა საკვები ყინული; შაქარი, თაფლი, ბადაგი; საფუარი, საცხობი ფხვნილები; მარილი, სანელებლები, საკმაზები, დაკონსერვებული მწვანილი; ძმარი, საწებლები და სხვა საკმაზი; ყინული (გაყინული წყალი).

(260) AM 2023 120841 A
(210) AM 120841
(220) 2022 12 21
(731) შპს „ევრობილდი“
ც. დადიანის ქ. 2, ბ. 3, 2100, ზუგდიდი, საქართველო

(540)



(591) წითელი, ლურჯი, ნაცრისფერი, ნარინჯისფერი
(531) 07.01.09; 26.05.18; 27.05.01; 28.19; 29.01.14
(511)

6 – მავთულის ბადეები.

19 – ბეტონი; ბეტონის სამშენებლო ელემენტები; ენერჯის გადამცემი ბოძები, არალითონური; ღორღი.

(260) AM 2023 120847 A
(210) AM 120847
(220) 2022 12 21
(731) შპს „ხოდ“
სოფ. ყარაჯალა, მე-11 ქ. 4, თელავი, საქართველო
(740) ნინო ბახტაძე

(540)

HAUZER

(591) შავ-თეთრი

(511)

7 – სასოფლო-სამეურნეო ინსტრუმენტები, ხელის იარაღების გარდა; ინკუბატორები კვერცხებისთვის; ავტომატური სავაჭრო აპარატები.

21 – საოჯახო და სამზარეულო ჭურჭელი და ჭურჭლეული, მათ შორის, კერამიკის ან ლითონის (მათ შორის, ალუმინის) მასალისგან დამზადებული (კეთილშობილი ლითონებისაგან დამზადებულის ან დაფარულის გარდა); მათ შორის, ტაფები; ქვაბები; ჭურჭლის ნაკრები; ტაფების ნაკრები; ქვაბების ნაკრები; სავარცხლები და ღრუბლები; ჯაგრისები (ფუნჯების გარდა); მასალები ჯაგრისის ნაკეთობისათვის; სამარჯვები წმენდისა და დასუფთავებისათვის; ლითონის ნეჭა; დაუმუშავებელი ან ნახევრადამუშავებული მინა (სამშენებლო მინის გარდა), მათ შორის, აერო გრილის შუშა; მინის, ფაიფურისა და ქაშანურის ნაკეთობა, რომელიც არ მიეკუთვნება სხვა კლასებს.

(260) AM 2023 120859 A

(210) AM 120859

(220) 2022 12 22

(731) შპს „კომპანია ბესინი“

გამრეკელის ქ. 19, ვაკე-საბურთალოს რაიონი, თბილისი, საქართველო

(540)



(591) შავ-თეთრი

(531) 05.01.19; 05.03.19; 05.07.10; 09.01.09;

09.01.16; 27.05.04

(511)

33 – ალკოჰოლური სასმელები, ლუდის გარდა; ალკოჰოლური შედგენილობები სასმელების დასამზადებლად.

(260) AM 2023 120862 A

(210) AM 120862

(220) 2022 12 22

(731) სტერლინგ პარფიუმზ ინდასტრიზ

(ლლკა)

პი.ო. ბოქს: 40769, დუბაი, არაბთა

გაერთიანებული საამიროები

(740) ლილიანა დარახველიძე

(540)



(591) შავ-თეთრი

(531) 26.11.08; 27.05.09; 27.05.10; 27.05.11;

27.05.22

(511)

3 – სუნამოები; პარფიუმერია; ეთერზეთები; ჰაერის არომატიზატორები; არომატიზატორები; არასამკურნალო კოსმეტიკა.

(260) AM 2023 120937 A

(210) AM 120937

(220) 2022 12 26

(731) ჯეოქს ს.პ.ა.

ვია ფელტრინა ჩენტრო, 16, 31044 ბიადენე დი მონტებელუნა (ტრევიზო), იტალია

(740) გიორგი თაქთაქიშვილი

(540)

ჯეოქსი

(591) შავ-თეთრი

(511)

25 – ტანსაცმელი, ფეხსაცმელი, ფეხსაცმლის ლანჩები, ფეხსაცმლის დეტალები, თავსაბურავი; ჩექმის ქუსლსაკრავები; მოცურების საწინააღმდეგო მოწყობილობები ჩექმისთვის; რანტები ჩექმებისათვის; ფეხსაცმლის ჭვინტები; ფეხსაცმლის წინა ნაწილის პირები; ფეხსაცმლის ქუსლსაკრავები; მაღალყელიანი წინდის ორმაგი ქუსლები; ქუსლები; დაბამები; მზა სარჩული [ტანსაცმლის დეტალი]; მოცურების საწინააღმდეგო მოწყობილობები ფეხსაცმლისთვის; ჯიბეები ტანსაცმლისათვის; ფეხსაცმლის ქუსლსაკრავები; ლითონის ნაწილები ფეხსაცმლისთვის; მოცურების საწინააღმდეგო მოწყობილობები ფეხსაცმლისთვის; ბუცების [ფეხბურთის

ფეხსაცმელი] კოტები; წინაფრები; რანტები ფეხსაცმლისათვის; ჩექმის წინა ნაწილის პირები; ლითონის ნაწილები ფეხსაცმლისთვის; წინაფრები [თავსაბურავი].

35 – რეკლამა; ბიზნესის მართვა; ბიზნესის ადმინისტრირება; საოფისე სამსახური (მომსახურება მესამე პირთათვის); ეკონომიკური პროგნოზირება; გამოფენების ორგანიზება კომერციული ან სარეკლამო მიზნით; იმპორტ-ექსპორტის სააგენტოების მომსახურება; ბაზრის კვლევა; ბაზრის შესწავლა; მოდელირება რეკლამის ან გაყიდვების ხელშეწყობის მიზნით; ახალი ამბების პრეს-სამსახური; ოფისის მანქანებისა და აღჭურვილობის გაქირავება; საზოგადოებრივი აზრის შესწავლა; ბაზრობების ორგანიზება კომერციული ან სარეკლამო მიზნებისათვის; მომარაგების მომსახურება მესამე პირთათვის [საქონლისა და მომსახურების შესყიდვა სხვა მეწარმეებისათვის]; ფსიქოლოგიური ტესტირება პერსონალის შესარჩევად; საზოგადოებასთან ურთიერთობის მომსახურება; სარეკლამო მასალის გაქირავება; სარეკლამო დროის გაქირავება მასობრივი ინფორმაციის საშუალებებში; ფოტოპირების გადამღები მანქანების გაქირავება; სავაჭრო ავტომატების გაქირავება; ვიტრინების გაფორმება; სტატისტიკური ინფორმაცია.

(260) AM 2023 120939 A

(210) AM 120939

(220) 2022 12 26

(731) შპს „ტფილისის მარანი“

ფალიაშვილის ქ. 33, ბ. 6, 0179, თბილისი, საქართველო

(540)

გამარჯვება Гамарджвеба Gamarjveba

(591) შავ-თეთრი

(531) 28.19

(511)

32 – ლუდი; უალკოჰოლო სასმელები; მინერალური და გაზიანი წყლები; ხილის სასმელები და წვენები; სიროფები და სასმელების დასამზადებელი სხვა უალკოჰოლო შედგენილობები.

33 – ალკოჰოლიანი სასმელები, ლუდის გარდა; სასმელების დასამზადებელი ალკოჰოლიანი შედგენილობები.

(260) AM 2023 120957 A

(210) AM 120957

(220) 2022 12 29

(731) ბაინენს ტექნოლოჯის ლიმიტიდ
6 ფლორი, საუთ ბენკ ჰაუსი, ბაროუ
სტრიტი, დუბლინი 4, ირლანდია

(740) თამაზ შილაკაძე

(540)

BINANCE

(591) შავ-თეთრი

(511)

9 – კომპიუტერის პროგრამული უზრუნველყოფა, აპარატურული უზრუნველყოფა და პროგრამულ-აპარატურული უზრუნველყოფა; ელექტრონული ვაჭრობის სფეროში გამოყენებული კომპიუტერის პროგრამული უზრუნველყოფა და პროგრამები; ამოცნობის პროგრამული უზრუნველყოფა; ჩამოსატვირთი კომპიუტერის პროგრამული უზრუნველყოფის აპლიკაციები; კომპიუტერის პროგრამული უზრუნველყოფის პაკეტები; კომპიუტერის პროგრამული უზრუნველყოფა მონაცემთა ბაზების სამართავად; ფინანსების მართვის კომპიუტერიზებული საინფორმაციო სისტემები; კომპიუტერული აპარატურა და აღჭურვილობა; ელექტრონული მოწყობილობები; მონაცემების დასამუშავებელი მოწყობილობები და აპარატები; ხმის ან გამოსახულების ჩაწერის, გადაცემის ან აღწარმოების აპარატურა; მანქანამონიტორები; მონაცემთა ტერმინალები; მონაცემთა შენახვის ბლოკები; ჯიბის ვალუტის გადამყვანები; ელექტრონული გამოცემები; მობილური ტელეფონის აპლიკაციები, ჩამოსატვირთი; ელექტრონული ვალუტის გადამყვანები; კომპიუტერული თამაშების პროგრამული უზრუნველყოფა; ვირტუალური რეალობის თამაშების პროგრამული უზრუნველყოფა; ვირტუალური რეალობის ყურსასმენები, რომლებიც ადაპტირებულია ვიდეო-თამაშებში გამოსაყენებლად; სახის ამომცნობი მოწყობილობა; ბიომეტრიული იდენტიფიკაციის აპარატი; ბიომეტრიული იდენტიფიკაციის სისტემები; ბიომეტრიული პასპორტები; კრიპტოვალუტის საფულეები, ჩამოსატვირთი; ჩამოსატვირთი ციფრული საფულეები; ჩამოსატვირთი მობილური საფულეები; ჩამოსატვირთი ვირტუალური საფულეები.

ლები; ჩამოსატვირთი კომპიუტერის პროგრამული უზრუნველყოფა კრიპტო აქტივების ტრანზაქციების მართვისთვის ბლოკჩეინის ტექნოლოგიის გამოყენებით; ჩამოსატვირთი კომპიუტერის პროგრამული უზრუნველყოფა კრიპტოვალუტის ტრანზაქციების მართვისთვის ბლოკჩეინის ტექნოლოგიის გამოყენებით; ჩამოსატვირთი კრიპტოგრაფიული გასაღებები კრიპტო აქტივების მიღებისა და ხარჯვისთვის; ჩამოსატვირთი კრიპტოგრაფიული გასაღებები კრიპტოვალუტის მიღებისა და ხარჯვისთვის; თვითმასინქრონიზებული ციფრული შიფრატორები; ჩამოსატვირთი ციფრული ფაილები იდენტიფიცირებული არაჩანაცვლებადი ტოკენებით [NFTs]; ჩამოსატვირთი აუდიო-ფაილები იდენტიფიცირებული არაჩანაცვლებადი ტოკენებით [NFTs]; ჩამოსატვირთი ვიდეო-ფაილები იდენტიფიცირებული არაჩანაცვლებადი ტოკენებით [NFTs]; საკრედიტო, სადებეტო, გადახდის და საიდენტიფიკაციო; ჩიპ-ბარათები და სმარტ-ბარათები; ბანკომატები; ფულადი გზავნილების ელექტრონული მანქანები; საკრედიტო და სადებეტო ბარათების შემოწმების აპარატები; უსაფრთხო წვდომის ტოკენები (და შიფრის მოწყობილობები); ელექტრონული გადახდის დამუშავების აპარატები; ელექტრონული და მაგნიტური ID ბარათები, რომელიც გამოიყენება მომსახურებისთვის გადასახადის გადახდისთვის; მანქანით წაკითხვადი მოწყობილობები უნაღდო გადახდის სისტემებისთვის; მესამე პირებისთვის და მესამე პირებისგან ელექტრონული გადახდების დასამუშავებელი კომპიუტერის პროგრამული უზრუნველყოფა და პროგრამები; ელექტრონული გადახდის ტერმინალები.

35 – ბიზნესის მართვისა და ბიზნესის ადმინისტრირების სამსახურები; მომხმარებელთა ლოიალობის პროგრამების ადმინისტრირება; ბიზნესთან დაკავშირებული საკონსულტაციო მომსახურება; ბიზნეს-მონაცემების ანალიზი; კომპიუტერიზებული საფინანსო სისტემების ადმინისტრაციული მართვა; მონაცემების დამუშავება; აუქციონით გაყიდვა; საბუღალტრო აღრიცხვა; ფინანსური აუდიტი; ბიზნეს-ინფორმაცია; ბიზნეს-საშუამავლო მომსახურება, დაკავშირებული პოტენციური კერძო ინვესტორების შერჩევასთან დაფინანსების საჭიროების მქონე მეწარმეებისთვის; კონსულტაცია ბიზნესის მართვისა და ორგანიზაციის საკითხებში; კომერციული ინფორმაცია და რჩევები მომხმარებლებისთვის საქონლის და მომსახურების შერჩევაში;

საზოგადოებრივი ურთიერთობის სფეროში გაწეული მომსახურება; საგადასახადო დეკლარაციის შედგენა; რეკლამა; საქონლისა და მომსახურების ლიცენზირების კომერციული ადმინისტრირება მესამე პირთათვის; კომერციული გარიგებების მოლაპარაკებები და დასკვნების გამოტანა მესამე პირთათვის; საკრედიტო ბარათების რეგისტრაცია [ადმინისტრირება]; სადებეტო ბარათების რეგისტრაცია [ადმინისტრირება]; ფასდაკლების ბარათების ლოიალობის სქემების ორგანიზება და მართვა; გაყიდვების ხელშეწყობა მესამე პირებისთვის პრივილეგირებული მომხმარებლის ბარათების საშუალებით; კონკურენტული გარემოს შესწავლის სამსახურები; ანგარიშების მდგომარეობაზე ანგარიშის შედგენა; ბაზრის შესწავლის სამსახურები; ბაზრის კვლევასთან დაკავშირებული ინფორმაციის შეგროვება; ბაზრების ანალიზი; ბიზნეს-კვლევები; საზოგადოებრივი აზრის შესწავლა; სარეკლამო და მარკეტინგული მომსახურება; გამოფენების ორგანიზება კომერციული ან სარეკლამო მიზნით; ბაზრობების ორგანიზება კომერციული ან სარეკლამო მიზნით; ბიზნეს ინფორმაციის მიწოდება ვებ-საიტების მეშვეობით; საქონლისა და მომსახურების მყიდველებისა და გამყიდველებისთვის ონლაინ ბაზრების უზრუნველყოფა; საქონლის საცალო და საბითუმო გაყიდვები, მათ შორის, ონლაინ რეჟიმში; მესამე პირებისთვის კომერციული ტრანზაქციების მოწყობა, მათ შორის, ელექტრონული კომერციის ფარგლებში; ონლაინ ბაზრების მომსახურება, კერძოდ, ციფრული სავალუტო აქტივების მყიდველებისა და გამყიდველებისთვის ბაზრის უზრუნველყოფა; აქტივების რეესტრის წარმოება მესამე პირებისთვის; კრიპტოვალუტის ტრანზაქციებთან დაკავშირებული საფინანსო ინსტრუმენტებისა და საფინანსო მომსახურების რეკლამა; კომპიუტერიზებული ონლაინ შეკვეთის მომსახურება და საცალო მაღაზიის მომსახურება ციფრული აქტივების გამოყენებით.

36 – საფინანსო მომსახურება; საბანკო მომსახურება; საშუამავლო საქმიანობა; სავალუტო საშუამავლო ოპერაციები; ვალუტის ყიდვა-გაყიდვა; საბირჟო საშუამავლო საქმიანობა; კაპიტალის ინვესტიცია; ინვესტიციები; კლირინგი და საფინანსო-საკლირინგო პალატები; ფასეულობის შენახვა; ფულადი სახსრების გადარიცხვა ელექტრონული ანგარიშგების სისტემაში; ფულის გადაცვლა; ფინანსური ანალიზი; ფინანსებთან დაკავშირებული კონსულტაციები;

რჩევები საფინანსო საკითხებში; ფინანსებთან დაკავშირებული ინფორმაცია; დაფინანსება; ფასიანი ქაღალდების გამოშვება; ონლაინ საბანკო მომსახურება; საფინანსო ტრანზაქციების დამუშავება; ფინანსური ინფორმაციის მიწოდება ვებ საიტების მეშვეობით; სეიფში შენახვა; საბირჟო შუამავლობა; საფონდო ბირჟის საბროკერო მომსახურება; საბირჟო კოტირება; სესხები; ფულადი სახსრების შემოწმება; ინვესტიციების შემოწმება; საინვესტიციო კვლევა; ეკონომიკური და ფინანსური კვლევა; ფინანსური მოდელირება; ინფორმაციის, კონსულტაციისა და რჩევების მიწოდება ფინანსური შეფასების სფეროში; ბიტკოინებით ვაჭრობა და გაცვლა; სავაჭრო ვალუტის ყიდვა, გაყიდვა და გაცვლა; ციფრული ვალუტის გადაცვლის მომსახურება; ფასიანი ქაღალდებით ვაჭრობა; ფასიანი ქაღალდების გამოშვება; ციფრული ფასიანი ქაღალდების გამოშვება; ონლაინ ვალუტით ვაჭრობა რეალურ დროში; ვირტუალური ვალუტის გაცვლის მომსახურება; საკრედიტო ბარათით გადახდების დამუშავება; სადებეტო ბარათით გადახდების დამუშავება; ფასდაკლების უზრუნველყოფა მესამე პირების მონაწილე დაწესებულებებში საწევრო ბარათის გამოყენებით; ციფრული საფულით გადახდის მომსახურება; საკრედიტო ბარათების გამოშვება; ელექტრონული გადახდის ბარათების გაცემა ბონუსებისა და ჯილდოების სქემებთან დაკავშირებით; კრიპტოვალუტით ვაჭრობის მომსახურება; კრიპტოვალუტის აქტივების მართვა; კრიპტოვალუტის საინვესტიციო მომსახურება; კრიპტოვალუტის გაცვლის მომსახურება; კრიპტოვალუტისა და კრიპტო აქტივებისთვის კასტო-დიალური მომსახურება კრიპტოვალუტის აქტივებზე მფლობელობის შენარჩუნების სახით ფინანსური მართვისა და სავაჭრო მიზნებისთვის; აქტივებისა და პორტფელის მენეჯმენტი; ფსონის დადება კრიპტოვალუტაზე; ფასიანი ქაღალდების დაზღვევა; აქტივების შეფასება; დაზღვევასთან დაკავშირებული საშუალებო საქმიანობა კრიპტო აქტივების გამოყენებით; კრიპტოვალუტით და/ან ციფრული აქტივებით სალომბარდო საშუალებო საქმიანობა; საგარანტიო მომსახურება კრიპტო აქტივების გამოყენებით; კრიპტო აქტივების ელექტრონული გადაცემა; კრიპტო აქტივებით ფინანსური გაცვლა.

41 – ინფორმაცია (აღზრდასა და განათლებასთან დაკავშირებული); საგანმანათლებლო მომსახურება; სწავლება; გამოფენების მოწყობა

კულტურული ან საგანმანათლებლო მიზნებისთვის; მასტერ-კლასების ორგანიზება და ჩატარება (training); კოლოკვიუმების ორგანიზება და ჩატარება; სპორტული ღონისძიებების ორგანიზება და ჩატარება; ბილეთების დაჯავშნა სპექტაკლებზე; ორგანიზება (სასწავლო ან გასართობი კონკურსების); გასართობი ღონისძიებების ჩატარება; კონფერენციების ორგანიზება და ჩატარება; დაუსწრებელი სწავლება ციფრულ აქტივებსა და მასთან დაკავშირებულ საკითხებზე; ელექტრონულ სპორტთან დაკავშირებული მომსახურება; საგანმანათლებლო სერტიფიცირების მომსახურება, კერძოდ, სწავლებისა და გამოცდების ჩატარების უზრუნველყოფა; ონლაინ კომპიუტერული თამაშების მიწოდება; გასართობი საშუალებებით უზრუნველყოფა; ონლაინ ელექტრონული გამოცემებით უზრუნველყოფა, არაჩამოსატვირთი; წიგნების გამოცემა; ონლაინ ვიდეოების მიწოდება, არაჩამოსატვირთი; პოდკასტების წარმოება; ტექსტების გამოცემა სარეკლამო ტექსტების გარდა; ტელედა რადიო-პროგრამების მონტაჟი.

42 – პლატფორმა მომსახურების სახით [PaaS]; პროგრამული უზრუნველყოფა მომსახურების სახით [SaaS]; ონლაინ, არაჩამოსატვირთი პროგრამული უზრუნველყოფის მიწოდება; კომპიუტერის აპარატურული და პროგრამული უზრუნველყოფის შემუშავება და განვითარება; ვებსაიტის საშუალებით ხელმისაწვდომი არაჩამოსატვირთი პროგრამული აპლიკაციების დროებითი გამოყენების უზრუნველყოფა; ვებ-პორტალების ჰოსტინგი; პროგრამული უზრუნველყოფის პროგრამირება ელექტრონული ვაჭრობის პლატფორმებისთვის; ვირტუალური გარემოს შექმნა; კრიპტოვალუტის მაინინგი; კრიპტოვალუტის ფსონინგი; მონაცემთა კრიპტოლოგიის სერვისები; კრიპტოგრაფიული ინჟინერია; ელექტრონული მონაცემების შენახვა; კომპიუტერიზებული ბიზნეს-ინფორმაციის შენახვა; მონაცემების მაინინგი; მონაცემების ჩვენების, შეტანის, გამოტანის, დამუშავების და შენახვის სისტემების შემუშავება და განვითარება; კომპიუტერიზებული მონაცემების, ფაილების, აპლიკაციების და ინფორმაციის ჰოსტინგი; ინტერნეტში ციფრული შინაარსის ჰოსტინგი; კომპიუტერული საშუალებებით უზრუნველყოფა ციფრული მონაცემების ელექტრონული შენახვისთვის; ციფრული შინაარსის კროს-პლატფორმული კონვერტაცია ციფრული შინაარსის სხვა ფორმებად; ციფრული წყლის ნიშნებით დანიშვნა; მონაცემების დამუშავებასთან დაკავ-

შირეული კვლევა; ტექნიკური მონაცემების ანალიზის მომსახურება; ტრანზაქციის და მოწყობილობის მუშაობის ელექტრონული მონიტორინგი თაღლითობის გამოსავლენად ინტერნეტის მეშვეობით; კომპიუტერული უსაფრთხოების საშიშროების ანალიზი მონაცემების დასაცავად; ტექნიკური მონაცემების ანალიზის მომსახურება; ღრუბლოვანი გამოთვლა; კომპიუტერული უსაფრთხოების მომსახურება ქსელში არაავტორიზებული წვდომისგან დასაცავად; კონსულტაცია კომპიუტერული პროგრამული უზრუნველყოფის საკითხებში; კონსულტაცია მონაცემთა დაცვის საკითხებში; ციფრული მონაცემების დაშიფვრის მომსახურება; პერსონალური ინფორმაციის ელექტრონული მონიტორინგი ინტერნეტის მეშვეობით პირადი ინფორმაციის მოპარვის გამოსავლენად; კომპიუტერული სისტემების მონიტორინგი არაავტორიზებული წვდომის ან მონაცემების გაჟონვის გამოსავლენად; სერვერის ჰოსტინგი; ციფრული და ელექტრონული ხელმოწერის შემოწმების მომსახურება [ელექტრონული კრიპტოლოგიის მომსახურება]; ავთენტიფიკაციის მომსახურება კომპიუტერული უსაფრთხოებისთვის; მომხმარებლის ავთენტიფიკაციის მომსახურება ბლოკჩეინის ტექნოლოგიის გამოყენებით; მომხმარებლის ავთენტიფიკაციის მომსახურება ერთჯერადად შესვლის ტექნოლოგიის გამოყენებით ონლაინ პროგრამული უზრუნველყოფის აპლიკაციებისთვის; მონაცემების დაცვის მომსახურება [„ცეცხლოვანი კედლები“]; ციფრულ ტრანსფორმაციასთან დაკავშირებული ტექნოლოგიური კონსულტაციები; ტექნოლოგიური კვლევა; კომპიუტერის პროგრამულ უზრუნველყოფასთან დაკავშირებული კონსულტაციები.

(260) AM 2023 120958 A

(210) AM 120958

(220) 2022 12 29

(731) ბაინენს ტექნოლოჯის ლიმიტიდ
6 ფლორი, საუთ ბენჯ ჰაუსი, ბაროუ
სტრიტი, დუბლინი 4, ირლანდია

(740) თამაზ შილაკაძე

(540)



(591) შავ-თეთრი

(531) 26.04.03; 26.04.12

(511)

9 – კომპიუტერის პროგრამული უზრუნველყოფა, აპარატურული უზრუნველყოფა და პროგრამულ-აპარატურული უზრუნველყოფა; ელექტრონული ვაჭრობის სფეროში გამოყენებული კომპიუტერის პროგრამული უზრუნველყოფა და პროგრამები; ამოცნობის პროგრამული უზრუნველყოფა; ჩამოსატვირთი კომპიუტერის პროგრამული უზრუნველყოფის აპლიკაციები; კომპიუტერის პროგრამული უზრუნველყოფის პაკეტები; კომპიუტერის პროგრამული უზრუნველყოფა მონაცემთა ბაზების სამართავად; ფინანსების მართვის კომპიუტერიზებული საინფორმაციო სისტემები; კომპიუტერული აპარატურა და აღჭურვილობა; ელექტრონული მოწყობილობები; მონაცემების დასამუშავებელი მოწყობილობები და აპარატები; ხმის ან გამოსახულების ჩაწერის, გადაცემის ან აღწარმოების აპარატურა; მანქანა-მონიტორები; მონაცემთა ტერმინალები; მონაცემთა შენახვის ბლოკები; ჯიბის ვალუტის გადამყვანები; ელექტრონული გამოცემები; მობილური ტელეფონის აპლიკაციები, ჩამოსატვირთი; ელექტრონული ვალუტის გადამყვანები; კომპიუტერული თამაშების პროგრამული უზრუნველყოფა; ვირტუალური რეალობის თამაშების პროგრამული უზრუნველყოფა; ვირტუალური რეალობის ყურსასმენები, რომლებიც ადაპტირებულია ვიდეო-თამაშებში გამოსაყენებლად; სახის ამომცნობი მოწყობილობა; ბიომეტრიული იდენტიფიკაციის აპარატი; ბიომეტრიული იდენტიფიკაციის სისტემები; ბიომეტრიული პასპორტები; კრიპტოვალუტის საფულეები, ჩამოსატვირთი; ჩამოსატვირთი ციფრული საფულეები; ჩამოსატვირთი მობილური საფულეები; ჩამოსატვირთი ვირტუალური საფულეები; ჩამოსატვირთი კომპიუტერის პროგრამული უზრუნველყოფა კრიპტო აქტივების ტრანზაქციების მართვისთვის ბლოკჩეინის ტექნოლოგიის გამოყენებით; ჩამოსატვირთი კომპიუტერის პროგრამული უზრუნველყოფა კრიპტოვალუტის ტრანზაქციების მართვისთვის ბლოკჩეინის ტექნოლოგიის გამოყენებით; ჩამოსატვირთი კრიპტოგრაფიული გასაღებები კრიპტო აქტივების მიღებისა და ხარჯვისთვის; ჩამოსატვირთი კრიპტოგრაფიული გასაღებები კრიპტოვალუტის მიღებისა და ხარჯვისთვის; თვითმასინქრონიზებული ციფრული შიფრატორები; ჩამოსატვირთი ციფრული ფაილები იდენტიფიცირებული არაჩანაცვლებადი ტოკე-

ნებით [NFTs]; ჩამოსატვირთი აუდიო-ფაილები იდენტიფიცირებული არაჩანაცვლებადი ტოკენებით [NFTs]; ჩამოსატვირთი ვიდეო-ფაილები იდენტიფიცირებული არაჩანაცვლებადი ტოკენებით [NFTs]; საკრედიტო, სადებეტო, გადახდის და საიდენტიფიკაციო; ჩივ-ბარათები და სმარტ-ბარათები; ბანკომატები; ფულადი გზავნილების ელექტრონული მანქანები; საკრედიტო და სადებეტო ბარათების შემოწმების აპარატები; უსაფრთხო წვდომის ტოკენები (დაშიფვრის მოწყობილობები); ელექტრონული გადახდის დამუშავების აპარატები; ელექტრონული და მაგნიტური ID ბარათები, რომელიც გამოიყენება მომსახურებისთვის გადასახადის გადახდისთვის; მანქანით წაკითხვადი მოწყობილობები უნაღდო გადახდის სისტემებისთვის; მესამე პირებისთვის და მესამე პირებისგან ელექტრონული გადახდების დასამუშავებელი კომპიუტერის პროგრამული უზრუნველყოფა და პროგრამები; ელექტრონული გადახდის ტერმინალები.

35 – ბიზნესის მართვისა და ბიზნესის ადმინისტრირების სამსახურები; მომხმარებელთა ლოიალობის პროგრამების ადმინისტრირება; ბიზნესთან დაკავშირებული საკონსულტაციო მომსახურება; ბიზნეს-მონაცემების ანალიზი; კომპიუტერიზებული საფინანსო სისტემების ადმინისტრაციული მართვა; მონაცემების დამუშავება; აუქციონით გაყიდვა; საბუღალტრო აღრიცხვა; ფინანსური აუდიტი; ბიზნეს-ინფორმაცია; ბიზნეს-საშუამავლო მომსახურება, დაკავშირებული პოტენციური კერძო ინვესტორების შერჩევასთან დაფინანსების საჭიროების მქონე მეწარმეებისთვის; კონსულტაცია ბიზნესის მართვისა და ორგანიზაციის საკითხებში; კომერციული ინფორმაცია და რჩევები მომხმარებლებისთვის საქონლის და მომსახურების შერჩევაში; საზოგადოებრივი ურთიერთობის სფეროში გაწეული მომსახურება; საგადასახადო დეკლარაციის შედგენა; რეკლამა; საქონლისა და მომსახურების ლიცენზირების კომერციული ადმინისტრირება მესამე პირთათვის; კომერციული გარიგებების მოლაპარაკებები და დასკვნების გამოტანა მესამე პირთათვის; საკრედიტო ბარათების რეგისტრაცია [ადმინისტრირება]; სადებეტო ბარათების რეგისტრაცია [ადმინისტრირება]; ფასდაკლების ბარათების ლოიალობის სქემების ორგანიზება და მართვა; გაყიდვების ხელშეწყობა მესამე პირებისთვის პრივილეგირებული მომხმარებლის ბარათების საშუალებით; კონკურენტული გარემოს შესწავლის სამ-

სახურები; ანგარიშების მდგომარეობაზე ანგარიშის შედგენა; ბაზრის შესწავლის სამსახურები; ბაზრის კვლევასთან დაკავშირებული ინფორმაციის შეგროვება; ბაზრების ანალიზი; ბიზნეს-კვლევები; საზოგადოებრივი აზრის შესწავლა; სარეკლამო და მარკეტინგული მომსახურება; გამოფენების ორგანიზება კომერციული ან სარეკლამო მიზნით; ბაზრობების ორგანიზება კომერციული ან სარეკლამო მიზნით; ბიზნეს ინფორმაციის მიწოდება ვებ-საიტების მეშვეობით; საქონლისა და მომსახურების მყიდველებისა და გამყიდველებისთვის ონლაინ ბაზრების უზრუნველყოფა; საქონლის საცალო და საბითუმო გაყიდვები, მათ შორის, ონლაინ რეჟიმში; მესამე პირებისთვის კომერციული ტრანზაქციების მოწყობა, მათ შორის, ელექტრონული კომერციის ფარგლებში; ონლაინ ბაზრების მომსახურება, კერძოდ, ციფრული სავალუტო აქტივების მყიდველებისა და გამყიდველებისთვის ბაზრის უზრუნველყოფა; აქტივების რეესტრის წარმოება მესამე პირებისთვის; კრიპტოვალუტის ტრანზაქციებთან დაკავშირებული საფინანსო ინსტრუმენტებისა და საფინანსო მომსახურების რეკლამა; კომპიუტერიზებული ონლაინ შეკვეთის მომსახურება და საცალო მაღაზიის მომსახურება ციფრული აქტივების გამოყენებით.

36 – საფინანსო მომსახურება; საბანკო მომსახურება; საშუამავლო საქმიანობა; სავალუტო საშუამავლო ოპერაციები; ვალუტის ყიდვა-გაყიდვა; საბირჟო საშუამავლო საქმიანობა; კაპიტალის ინვესტიცია; ინვესტიციები; კლირინგი და საფინანსო-საკლირინგო პალატები; ფასეულობის შენახვა; ფულადი სახსრების გადარიცხვა ელექტრონული ანგარიშგების სისტემაში; ფულის გადაცვლა; ფინანსური ანალიზი; ფინანსებთან დაკავშირებული კონსულტაციები; რჩევები საფინანსო საკითხებში; ფინანსებთან დაკავშირებული ინფორმაცია; დაფინანსება; ფასიანი ქაღალდების გამოშვება; ონლაინ საბანკო მომსახურება; საფინანსო ტრანზაქციების დამუშავება; ფინანსური ინფორმაციის მიწოდება ვებ საიტების მეშვეობით; სეიფში შენახვა; საბირჟო შუამავლობა; საფონდო ბირჟის საბროკერო მომსახურება; საბირჟო კოტირება; სესხები; ფულადი სახსრების შემოწმება; ინვესტიციების შემოწმება; საინვესტიციო კვლევა; ეკონომიკური და ფინანსური კვლევა; ფინანსური მოდელირება; ინფორმაციის, კონსულტაციისა და რჩევების მიწოდება ფინანსური შეფასების სფეროში; ბიტკოინებით ვაჭრობა და გაცვლა;

სავაჭრო ვალუტის ყიდვა, გაყიდვა და გაცვლა; ციფრული ვალუტის გადაცვლის მომსახურება; ფასიანი ქაღალდებით ვაჭრობა; ფასიანი ქაღალდების გამოშვება; ციფრული ფასიანი ქაღალდების გამოშვება; ონლაინ ვალუტით ვაჭრობა რეალურ დროში; ვირტუალური ვალუტის გაცვლის მომსახურება; საკრედიტო ბარათით გადახდების დამუშავება; სადებეტო ბარათით გადახდების დამუშავება; ფასდაკლების უზრუნველყოფა მესამე პირების მონაწილე დაწესებულებებში საწევრო ბარათის გამოყენებით; ციფრული საფულით გადახდის მომსახურება; საკრედიტო ბარათების გამოშვება; ელექტრონული გადახდის ბარათების გაცემა ბონუსებისა და ჯილდოების სქემებთან დაკავშირებით; კრიპტოვალუტით ვაჭრობის მომსახურება; კრიპტოვალუტის აქტივების მართვა; კრიპტოვალუტის საინვესტიციო მომსახურება; კრიპტოვალუტის გაცვლის მომსახურება; კრიპტოვალუტისა და კრიპტო აქტივებისთვის კასტოდიალური მომსახურება კრიპტოვალუტის აქტივებზე მფლობელობის შენარჩუნების სახით ფინანსური მართვისა და სავაჭრო მიზნებისთვის; აქტივებისა და პორტფელის მენეჯმენტი; ფსონის დადება კრიპტოვალუტაზე; ფასიანი ქაღალდების დაზღვევა; აქტივების შეფასება; დაზღვევასთან დაკავშირებული საშუაშაგლო საქმიანობა კრიპტო აქტივების გამოყენებით; კრიპტოვალუტით და/ან ციფრული აქტივებით სალომბარდო საშუაშაგლო საქმიანობა; საგარანტიო მომსახურება კრიპტო აქტივების გამოყენებით; კრიპტო აქტივების ელექტრონული გადაცემა; კრიპტო აქტივებით ფინანსური გაცვლა.

41 – ინფორმაცია (აღზრდასა და განათლებასთან დაკავშირებული); საგანმანათლებლო მომსახურება; სწავლება; გამოფენების მოწყობა კულტურული ან საგანმანათლებლო მიზნებისთვის; მასტერ-კლასების ორგანიზება და ჩატარება (training); კოლოკვიუმების ორგანიზება და ჩატარება; სპორტული ღონისძიებების ორგანიზება და ჩატარება; ბილეთების დაჯავშნა სპექტაკლებზე; ორგანიზება (სასწავლო ან გასართობი კონკურსების); გასართობი ღონისძიებების ჩატარება; კონფერენციების ორგანიზება და ჩატარება; დაუსწრებელი სწავლება ციფრულ აქტივებსა და მასთან დაკავშირებულ საკითხებზე; ელექტრონულ სპორტთან დაკავშირებული მომსახურება; საგანმანათლებლო სერტიფიცირების მომსახურება, კერძოდ, სწავლებისა და გამოცდების ჩატარების უზრუნველყოფა; ონ-

ლაინ კომპიუტერული თამაშების მიწოდება; გასართობი საშუალებებით უზრუნველყოფა; ონლაინ ელექტრონული გამოცემებით უზრუნველყოფა, არაჩამოსატვირთი; წიგნების გამოცემა; ონლაინ ვიდეოების მიწოდება, არაჩამოსატვირთი; პოდკასტების წარმოება; ტექსტების გამოცემა სარეკლამო ტექსტების გარდა; ტელე- და რადიო-პროგრამების მონტაჟი.

42 – პლატფორმა მომსახურების სახით [PaaS]; პროგრამული უზრუნველყოფა მომსახურების სახით [SaaS]; ონლაინ, არაჩამოსატვირთი პროგრამული უზრუნველყოფის მიწოდება; კომპიუტერის აპარატურული და პროგრამული უზრუნველყოფის შემუშავება და განვითარება; ვებსაიტის საშუალებით ხელმისაწვდომი არაჩამოსატვირთი პროგრამული აპლიკაციების დროებითი გამოყენების უზრუნველყოფა; ვებ-პორტალების ჰოსტინგი; პროგრამული უზრუნველყოფის პროგრამირება ელექტრონული ვაჭრობის პლატფორმებისთვის; ვირტუალური გარემოს შექმნა; კრიპტოვალუტის მაინინგი; კრიპტოვალუტის ფსონინგი; მონაცემთა კრიპტოლოგიის სერვისები; კრიპტოგრაფიული ინჟინერია; ელექტრონული მონაცემების შენახვა; კომპიუტერიზებული ბიზნეს-ინფორმაციის შენახვა; მონაცემების მაინინგი; მონაცემების ჩვენების, შეტანის, გამოტანის, დამუშავების და შენახვის სისტემების შემუშავება და განვითარება; კომპიუტერიზებული მონაცემების, ფაილების, აპლიკაციების და ინფორმაციის ჰოსტინგი; ინტერნეტში ციფრული შინაარსის ჰოსტინგი; კომპიუტერული საშუალებებით უზრუნველყოფა ციფრული მონაცემების ელექტრონული შენახვისთვის; ციფრული შინაარსის კროს-პლატფორმული კონვერტაცია ციფრული შინაარსის სხვა ფორმებად; ციფრული წყლის ნიშნებით დანიშვნა; მონაცემების დამუშავებასთან დაკავშირებული კვლევა; ტექნიკური მონაცემების ანალიზის მომსახურება; ტრანზაქციის და მოწყობილობის მუშაობის ელექტრონული მონიტორინგი თაღლითობის გამოსავლენად ინტერნეტის მეშვეობით; კომპიუტერული უსაფრთხოების საშიშროების ანალიზი მონაცემების დასაცავად; ტექნიკური მონაცემების ანალიზის მომსახურება; ღრუბლოვანი გამოთვლა; კომპიუტერული უსაფრთხოების მომსახურება ქსელში არავტორიზებული წვდომისგან დასაცავად; კონსულტაცია კომპიუტერული პროგრამული უზრუნველყოფის საკითხებში; კონსულტაცია მონაცემთა დაცვის საკითხებში; ციფრული მონაცემების დამიფერის მომსახურება.

რება; პერსონალური ინფორმაციის ელექტრონული მონიტორინგი ინტერნეტის მეშვეობით პირადი ინფორმაციის მოპარვის გამოსავლენად; კომპიუტერული სისტემების მონიტორინგი არაავტორიზებული წვდომის ან მონაცემების გაჟონვის გამოსავლენად; სერვერის ჰოსტინგი; ციფრული და ელექტრონული ხელმოწერის შემოწმების მომსახურება [ელექტრონული კრიპტოლოგიის მომსახურება]; ავთენტიფიკაციის მომსახურება კომპიუტერული უსაფრთხოებისთვის; მომხმარებლის ავთენტიფიკაციის მომსახურება ბლოკჩეინის ტექნოლოგიის გამოყენებით; მომხმარებლის ავთენტიფიკაციის მომსახურება ერთჯერადად შესვლის ტექნოლოგიის გამოყენებით ონლაინ პროგრამული უზრუნველყოფის აპლიკაციებისთვის; მონაცემების დაცვის მომსახურება [„ცეცხლოვანი კედლები“]; ციფრულ ტრანსფორმაციასთან დაკავშირებული ტექნოლოგიური კონსულტაციები; ტექნოლოგიური კვლევა; კომპიუტერის პროგრამულ უზრუნველყოფასთან დაკავშირებული კონსულტაციები.

(260) AM 2023 120959 A

(210) AM 120959

(220) 2022 12 29

(731) ბაინენს ტექნოლოჯის ლიმიტიდ
6 ფლორი, საუთ ბენკ ჰაუსი, ბაროუ
სტრიტი, დუბლინი 4, ირლანდია

(740) თამაზ შილაკაძე

(540)



(591) შავ-თეთრი

(531) 26.15.09

(511)

9 – კომპიუტერის პროგრამული უზრუნველყოფა, აპარატურული უზრუნველყოფა და პროგრამულ-აპარატურული უზრუნველყოფა; ელექტრონული ვაჭრობის სფეროში გამოყენებული კომპიუტერის პროგრამული უზრუნველყოფა და პროგრამები; ამოცნობის პროგრამული უზრუნველყოფა; ჩამოსატვირთი კომპიუტერის პროგრამული უზრუნველყოფის აპლიკაციები; კომპიუტერის პროგრამული უზრუნველყოფის პაკეტები; კომპიუტერის პროგრამული უზრუნველყოფა მონაცემთა ბაზების სამარ-

თავად; ფინანსების მართვის კომპიუტერიზებული საინფორმაციო სისტემები; კომპიუტერები; კომპიუტერული აპარატურა და აღჭურვილობა; ელექტრონული მოწყობილობები; მონაცემების დასამუშავებელი მოწყობილობები და აპარატები; ხმის ან გამოსახულების ჩაწერის, გადაცემის ან აღწარმოების აპარატურა; მანქანა-მონიტორები; მონაცემთა ტერმინალები; მონაცემთა შენახვის ბლოკები; ჯიბის ვალუტის გადამყვანები; ელექტრონული გამოცემები; მობილური ტელეფონის აპლიკაციები, ჩამოსატვირთი; ელექტრონული ვალუტის გადამყვანები; კომპიუტერული თამაშების პროგრამული უზრუნველყოფა; ვირტუალური რეალობის თამაშების პროგრამული უზრუნველყოფა; ვირტუალური რეალობის ყურსასმენები, რომლებიც ადაპტირებულია ვიდეო-თამაშებში გამოსაყენებლად; სახის ამომცნობი მოწყობილობა; ბიომეტრიული იდენტიფიკაციის აპარატი; ბიომეტრიული იდენტიფიკაციის სისტემები; ბიომეტრიული პასპორტები; კრიპტოვალუტის საფულეები, ჩამოსატვირთი; ჩამოსატვირთი ციფრული საფულეები; ჩამოსატვირთი მობილური საფულეები; ჩამოსატვირთი ვირტუალური საფულეები; ჩამოსატვირთი კომპიუტერის პროგრამული უზრუნველყოფა კრიპტო აქტივების ტრანზაქციების მართვისთვის ბლოკჩეინის ტექნოლოგიის გამოყენებით; ჩამოსატვირთი კომპიუტერის პროგრამული უზრუნველყოფა კრიპტოვალუტის ტრანზაქციების მართვისთვის ბლოკჩეინის ტექნოლოგიის გამოყენებით; ჩამოსატვირთი კრიპტოგრაფიული გასაღებები კრიპტო აქტივების მიღებისა და ხარჯვისთვის; ჩამოსატვირთი კრიპტოგრაფიული გასაღებები კრიპტოვალუტის მიღებისა და ხარჯვისთვის; თვითმასინქრონიზებული ციფრული შიფრატორები; ჩამოსატვირთი ციფრული ფაილები იდენტიფიცირებული არაჩანაცვლებადი ტოკენებით [NFTs]; ჩამოსატვირთი აუდიო-ფაილები იდენტიფიცირებული არაჩანაცვლებადი ტოკენებით [NFTs]; ჩამოსატვირთი ვიდეო-ფაილები იდენტიფიცირებული არაჩანაცვლებადი ტოკენებით [NFTs]; საკრედიტო, სადებეტო, გადახდის და საიდენტიფიკაციო; ჩიპ-ბარათები და სმარტ-ბარათები; ბანკომატები; ფულადი გზავნილების ელექტრონული მანქანები; საკრედიტო და სადებეტო ბარათების შემოწმების აპარატები; უსაფრთხო წვდომის ტოკენები (და-შიფრის მოწყობილობები); ელექტრონული გადახდის დამუშავების აპარატები; ელექტრონული და მაგნიტური ID ბარათები, რომელიც გამოიყენება მომსახურებისთვის გადასახადის გა-

დახდისთვის; მანქანით წაკითხვადი მოწყობილობები უნაღდო გადახდის სისტემებისთვის; მესამე პირებისთვის და მესამე პირებისგან ელექტრონული გადახდების დასამუშავებელი კომპიუტერის პროგრამული უზრუნველყოფა და პროგრამები; ელექტრონული გადახდის ტერმინალები.

35 – ბიზნესის მართვისა და ბიზნესის ადმინისტრირების სამსახურები; მომხმარებელთა ლოიალობის პროგრამების ადმინისტრირება; ბიზნესთან დაკავშირებული საკონსულტაციო მომსახურება; ბიზნეს-მონაცემების ანალიზი; კომპიუტერიზებული საფინანსო სისტემების ადმინისტრაციული მართვა; მონაცემების დამუშავება; აუქციონით გაყიდვა; საბუღალტრო აღრიცხვა; ფინანსური აუდიტი; ბიზნეს-ინფორმაცია; ბიზნეს-საშუამავლო მომსახურება, დაკავშირებული პოტენციური კერძო ინვესტორების შერჩევასთან დაფინანსების საჭიროების მქონე მეწარმეებისთვის; კონსულტაცია ბიზნესის მართვისა და ორგანიზაციის საკითხებში; კომერციული ინფორმაცია და რჩევები მომხმარებლებისთვის საქონლის და მომსახურების შერჩევაში; საზოგადოებრივი ურთიერთობის სფეროში გაწეული მომსახურება; საგადასახადო დეკლარაციის შედგენა; რეკლამა; საქონლისა და მომსახურების ლიცენზირების კომერციული ადმინისტრირება მესამე პირთათვის; კომერციული გარიგებების მოლაპარაკებები და დასკვნების გამოტანა მესამე პირთათვის; საკრედიტო ბარათების რეგისტრაცია [ადმინისტრირება]; სადებეტო ბარათების რეგისტრაცია [ადმინისტრირება]; ფასდაკლების ბარათების ლოიალობის სქემების ორგანიზება და მართვა; გაყიდვების ხელშეწყობა მესამე პირებისთვის პრივილეგირებული მომხმარებლის ბარათების საშუალებით; კონკურენტული გარემოს შესწავლის სამსახურები; ანგარიშების მდგომარეობაზე ანგარიშის შედგენა; ბაზრის შესწავლის სამსახურები; ბაზრის კვლევასთან დაკავშირებული ინფორმაციის შეგროვება; ბაზრების ანალიზი; ბიზნეს-კვლევები; საზოგადოებრივი აზრის შესწავლა; სარეკლამო და მარკეტინგული მომსახურება; გამოფენების ორგანიზება კომერციული ან სარეკლამო მიზნით; ბაზრობების ორგანიზება კომერციული ან სარეკლამო მიზნით; ბიზნეს ინფორმაციის მიწოდება ვებ-საიტების მეშვეობით; საქონლისა და მომსახურების მიწოდებისა და გამყიდველებისთვის ონლაინ ბაზრების უზრუნველყოფა; საქონლის საცალო და საბითუმო გაყიდვები, მათ შორის, ონლაინ

რეჟიმში; მესამე პირებისთვის კომერციული ტრანზაქციების მოწყობა, მათ შორის, ელექტრონული კომერციის ფარგლებში; ონლაინ ბაზრების მომსახურება, კერძოდ, ციფრული სავალუტო აქტივების მიწოდებისა და გამყიდველებისთვის ბაზრის უზრუნველყოფა; აქტივების რეესტრის წარმოება მესამე პირებისთვის; კრიპტოვალუტის ტრანზაქციებთან დაკავშირებული საფინანსო ინსტრუმენტებისა და საფინანსო მომსახურების რეკლამა; კომპიუტერიზებული ონლაინ შეკვეთის მომსახურება და საცალო მაღაზიის მომსახურება ციფრული აქტივების გამოყენებით.

36 – საფინანსო მომსახურება; საბანკო მომსახურება; საშუამავლო საქმიანობა; სავალუტო საშუამავლო ოპერაციები; ვალუტის ყიდვა-გაყიდვა; საბირჟო საშუამავლო საქმიანობა; კაპიტალის ინვესტიცია; ინვესტიციები; კლირინგი და საფინანსო-საკლირინგო პალატები; ფასეულობის შენახვა; ფულადი სახსრების გადარიცხვა ელექტრონული ანგარიშგების სისტემაში; ფულის გადაცვლა; ფინანსური ანალიზი; ფინანსებთან დაკავშირებული კონსულტაციები; რჩევები საფინანსო საკითხებში; ფინანსებთან დაკავშირებული ინფორმაცია; დაფინანსება; ფასიანი ქაღალდების გამოშვება; ონლაინ საბანკო მომსახურება; საფინანსო ტრანზაქციების დამუშავება; ფინანსური ინფორმაციის მიწოდება ვებ-საიტების მეშვეობით; სეიფში შენახვა; საბირჟო შუამავლობა; საფონდო ბირჟის საბროკერო მომსახურება; საბირჟო კოტირება; სესხები; ფულადი სახსრების შემოწმება; ინვესტიციების შემოწმება; საინვესტიციო კვლევა; ეკონომიკური და ფინანსური კვლევა; ფინანსური მოდელირება; ინფორმაციის, კონსულტაციისა და რჩევების მიწოდება ფინანსური შეფასების სფეროში; ბიტკოინებით ვაჭრობა და გაცვლა; სავაჭრო ვალუტის ყიდვა, გაყიდვა და გაცვლა; ციფრული ვალუტის გადაცვლის მომსახურება; ფასიანი ქაღალდებით ვაჭრობა; ფასიანი ქაღალდების გამოშვება; ციფრული ფასიანი ქაღალდების გამოშვება; ონლაინ ვალუტით ვაჭრობა რეალურ დროში; ვირტუალური ვალუტის გაცვლის მომსახურება; საკრედიტო ბარათით გადახდების დამუშავება; სადებეტო ბარათით გადახდების დამუშავება; ფასდაკლების უზრუნველყოფა მესამე პირების მონაწილე დაწესებულებებში საწევრო ბარათის გამოყენებით; ციფრული საფულით გადახდის მომსახურება; საკრედიტო ბარათების გამოშვება; ელექტრონული გადახდის ბარათების გაცემა ბონუს-

სებისა და ჯილდოების სქემებთან დაკავშირებით; კრიპტოვალუტით ვაჭრობის მომსახურება; კრიპტოვალუტის აქტივების მართვა; კრიპტოვალუტის საინვესტიციო მომსახურება; კრიპტოვალუტის გაცვლის მომსახურება; კრიპტოვალუტისა და კრიპტო აქტივებისთვის კასტო-დიალური მომსახურება კრიპტოვალუტის აქტივებზე მფლობელობის შენარჩუნების სახით ფინანსური მართვისა და სავაჭრო მიზნებისთვის; აქტივებისა და პორტფელის მენეჯმენტი; ფსონის დადება კრიპტოვალუტაზე; ფასიანი ქაღალდების დაზღვევა; აქტივების შეფასება; დაზღვევასთან დაკავშირებული საშუალო საქმიანობა კრიპტო აქტივების გამოყენებით; კრიპტოვალუტით და/ან ციფრული აქტივებით სალომბარდო საშუალო საქმიანობა; საგარანტიო მომსახურება კრიპტო აქტივების გამოყენებით; კრიპტო აქტივების ელექტრონული გადაცემა; კრიპტო აქტივებით ფინანსური გაცვლა.

41 – ინფორმაცია (აღზრდასა და განათლებასთან დაკავშირებული); საგანმანათლებლო მომსახურება; სწავლება; გამოფენების მოწყობა კულტურული ან საგანმანათლებლო მიზნებისთვის; მასტერ-კლასების ორგანიზება და ჩატარება (training); კოლოკვიუმების ორგანიზება და ჩატარება; სპორტული ღონისძიებების ორგანიზება და ჩატარება; ბილეთების დაჯავშნა სპექტაკლებზე; ორგანიზება (სასწავლო ან გასართობი კონკურსების); გასართობი ღონისძიებების ჩატარება; კონფერენციების ორგანიზება და ჩატარება; დაუსწრებელი სწავლება ციფრულ აქტივებსა და მასთან დაკავშირებულ საკითხებზე; ელექტრონულ სპორტთან დაკავშირებული მომსახურება; საგანმანათლებლო სერტიფიცირების მომსახურება, კერძოდ, სწავლებისა და გამოცდების ჩატარების უზრუნველყოფა; ონლაინ კომპიუტერული თამაშების მიწოდება; გასართობი საშუალებებით უზრუნველყოფა; ონლაინ ელექტრონული გამოცემებით უზრუნველყოფა, არაჩამოსატვირთი; წიგნების გამოცემა; ონლაინ ვიდეოების მიწოდება, არაჩამოსატვირთი; პოდკასტების წარმოება; ტექსტების გამოცემა სარეკლამო ტექსტების გარდა; ტელედა რადიო-პროგრამების მონტაჟი.

42 – პლატფორმა მომსახურების სახით [PaaS]; პროგრამული უზრუნველყოფა მომსახურების სახით [SaaS]; ონლაინ, არაჩამოსატვირთი პროგრამული უზრუნველყოფის მიწოდება; კომპიუტერის აპარატურული და პროგრამული უზრუნველყოფის შემუშავება და განვითარება;

ვებსაიტის საშუალებით ხელმისაწვდომი არაჩამოსატვირთი პროგრამული აპლიკაციების დროებითი გამოყენების უზრუნველყოფა; ვებ-პორტალების ჰოსტინგი; პროგრამული უზრუნველყოფის პროგრამირება ელექტრონული ვაჭრობის პლატფორმებისთვის; ვირტუალური გარემოს შექმნა; კრიპტოვალუტის მაინინგი; კრიპტოვალუტის ფსონინგი; მონაცემთა კრიპტოლოგიის სერვისები; კრიპტოგრაფიული ინჟინერია; ელექტრონული მონაცემების შენახვა; კომპიუტერიზებული ბიზნეს-ინფორმაციის შენახვა; მონაცემების მაინინგი; მონაცემების ჩვენების, შეტანის, გამოტანის, დამუშავების და შენახვის სისტემების შემუშავება და განვითარება; კომპიუტერიზებული მონაცემების, ფაილების, აპლიკაციების და ინფორმაციის ჰოსტინგი; ინტერნეტში ციფრული შინაარსის ჰოსტინგი; კომპიუტერული საშუალებებით უზრუნველყოფა ციფრული მონაცემების ელექტრონული შენახვისთვის; ციფრული შინაარსის კროს-პლატფორმული კონვერტაცია ციფრული შინაარსის სხვა ფორმებად; ციფრული წყლის ნიშნებით დანიშვნა; მონაცემების დამუშავებასთან დაკავშირებული კვლევა; ტექნიკური მონაცემების ანალიზის მომსახურება; ტრანზაქციის და მოწყობილობის მუშაობის ელექტრონული მონიტორინგი თაღლითობის გამოსავლენად ინტერნეტის მეშვეობით; კომპიუტერული უსაფრთხოების საშიშროების ანალიზი მონაცემების დასაცავად; ტექნიკური მონაცემების ანალიზის მომსახურება; ღრუბლოვანი გამოთვლა; კომპიუტერული უსაფრთხოების მომსახურება ქსელში არაავტორიზებული წვდომისგან დასაცავად; კონსულტაცია კომპიუტერული პროგრამული უზრუნველყოფის საკითხებში; კონსულტაცია მონაცემთა დაცვის საკითხებში; ციფრული მონაცემების დამიფერის მომსახურება; პერსონალური ინფორმაციის ელექტრონული მონიტორინგი ინტერნეტის მეშვეობით პირადი ინფორმაციის მოპარვის გამოსავლენად; კომპიუტერული სისტემების მონიტორინგი არაავტორიზებული წვდომის ან მონაცემების გაჟონვის გამოსავლენად; სერვერის ჰოსტინგი; ციფრული და ელექტრონული ხელმოწერის შემოწმების მომსახურება [ელექტრონული კრიპტოლოგიის მომსახურება]; ავთენტიფიკაციის მომსახურება კომპიუტერული უსაფრთხოებისთვის; მომხმარებლის ავთენტიფიკაციის მომსახურება ბლოკჩეინის ტექნოლოგიის გამოყენებით; მომხმარებლის ავთენტიფიკაციის მომსახურება ერთჯერადად შესვლის ტექნოლოგიის გამოყენებით ონლაინ პროგრამული

უზრუნველყოფის აპლიკაციებისთვის; მონაცემების დაცვის მომსახურება [„ცეცხლოვანი კედლები“]; ციფრულ ტრანსფორმაციასთან დაკავშირებული ტექნოლოგიური კონსულტაციები; ტექნოლოგიური კვლევა; კომპიუტერის პროგრამულ უზრუნველყოფასთან დაკავშირებული კონსულტაციები.

(260) AM 2023 120975 A

(210) AM 120975

(220) 2022 12 30

(731) ექსონ მობილ კორპორეიშნ

5959 ლას კოლინას ბულვარი, ირვინგი,

ტექსასის შტატი 75039-2298, აშშ

(740) შალვა გვარამაძე

(540)

Mobil
Delvac

LEGEND

(591) თეთრი, შავი, ყვითელი, ლურჯი, წითელი

(531) 26.04.02; 26.04.22; 26.04.24; 27.05.01;

27.05.10; 29.01.14

(511)

4 – ტექნიკური ზეთები და საპოხები, ცვილები; ლუბრიკანტები; მტვრის შთამნთქმელი, დამტენიანებელი და შემკვრელი შედგენილობები; საწვავი და გამანათებელი ნივთიერებები; სანთლები და პატრუქები განათებისთვის; ძრავის ზეთები.

(260) AM 2023 120976 A

(210) AM 120976

(220) 2022 12 30

(731) ექსონ მობილ კორპორეიშნ

5959 ლას კოლინას ბულვარი, ირვინგი,

ტექსასის შტატი 75039-2298, აშშ

(740) შალვა გვარამაძე

(540)

Mobil
Delvac

ULTRA

(591) თეთრი, შავი, ყვითელი, ლურჯი, წითელი

(531) 26.04.02; 26.04.22; 26.04.24; 27.05.01;

27.05.10; 29.01.14

(511)

4 – ტექნიკური ზეთები და საპოხები, ცვილები; ლუბრიკანტები; მტვრის შთამნთქმელი, დამტენიანებელი და შემკვრელი შედგენილობები; საწვავი და გამანათებელი ნივთიერებები; სანთლები და პატრუქები განათებისთვის; ძრავის ზეთები.

(260) AM 2023 121041 A

(210) AM 121041

(220) 2022 12 30

(731) სს „სტუმარი ჯგუფი“

სოფ. თოხლიაური, მე-13 ქუჩის I შესახ. 9,

საგარეჯოს მუნიციპალიტეტი,

საქართველო

(740) გიორგი თაქთაქიშვილი

(540)

STUMARI

(591) შავ-თეთრი

(511)

5 – მცენარეული ჩაი, სამედიცინო დანიშნულების; ღვინის ჩაი, სამედიცინო დანიშნულების.

30 – ფევილი და მარცვლეულის პროდუქტი; საკონდიტრო ნაწარმი; ნაყინი, შარბათი, და სხვა საკვები ყინული; ორცხობილები; ბისკვიტები; ალას ნამცხვარი; საკონდიტრო ნაწარმი, კანფეტები; კანფეტები; ვაფლი; ბრიოშები; კაკაო; ყავა; მოუხალავი ყავა; ყავის შემცვლელი, მცენარეული; ნამცხვრები; მარცვლეულის ნაწარმი; ჩაი; შოკოლადი; მარციპანი; ტკბილეული; შაქრის ტკბილეული; სიმინდის ფანტელები; სიმინდის ბურბუმელა; ბატიბუტი; ბლინები; თაფლაკვრები; შაქარი; ნამცხვრის პუდრა; ნამცხვრის ცომი; საკვები ბურღულეული; კაკაოს რძიანი სასმელები; ყავის რძიანი სასმელები; შოკოლადზე დამზადებული რძიანი სასმელები; მაკარონის ნაწარმი; პური; თაფლი; ღვეზელები; სენდვიჩები; ფუნთუშები; პიცა; პუდინგები; შაქარში მოხალული ნიგოზი ან ნუში, პრალინე; რავიოლი [პელმენის სახეობა]; ბრინჯი; საგო; მანანის ბურღული; სპაგეტი; ტაპიოკა; ღვეზელები ხილკენკრის შიგთავსით; ვერმიშელი; ხორციანი ღვეზელები; პამტეტის ღვეზელი; შვრიაზე დამზადებული საკვები; შვრიის ფანტელები; ყავაზე დამზადებული სასმელები; კაკაოზე დამზადებული სასმელები; შოკოლადზე დამზადებული სასმელები; ყავის შემცვლელი; შაქარყინული; ჩიპსები [მარცვლეულის ნაწარმი]; მუსლი; ბრინჯის კვრები; გაყინული

იოგურტი [გაყინული საკონდიტრო ნაწარმი]; ჩაი ყინულით; ჩაიზე დამზადებული სასმელები; ჰალვა; მარცვლეულზე დამზადებული მსუბუქი საუზმეული; ბრინჯის საუზმეული; შოკოლადის მუსი; საკონდიტრო ნაწარმი მუსის სახით; ხილის პიურეები [სოუსები]; ყვავილები და ფოთლები, როგორც ჩაის შემცვლელი; პელმენები; შოკოლადის მორთულობა ნამცხვრებისთვის; ნამცხვრების მოსართავი კანფეტები; შოკოლადში ამოვლებული თხილი; ბრინჯის პუდინგი; შოკოლადის კრემი თხილის შემცველობით; გვირილაზე დამზადებული სასმელები; ბურღულეული; ხილის საკონდიტრო ნაწარმი; კრუსანები; შოკოლადიანი ქაღები; კრემ-ბრიულე; ყავის კაფსულები, შევსებული; ნუგა; ჩაის სასმელები რძით; მცენარეული ჩაი; ღვინის ჩაი; ჩაის შემცვლელი; კაკაოს შემცვლელი.

(260) AM 2023 121042 A

(210) AM 121042

(220) 2022 12 30

(731) სს „სტუმარი ჯგუფი“

სოფ. თოხლიაური, მე-13 ქუჩის I შესახ. 9,
საგარეჯოს მუნიციპალიტეტი,
საქართველო

(740) გიორგი თაქთაქიშვილი

(540)



(591) შავ-თეთრი

(531) 05.07.10

(511)

5 – მცენარეული ჩაი, სამედიცინო დანიშნულების; ღვინის ჩაი, სამედიცინო დანიშნულების.

30 – ფქვილი და მარცვლეულის პროდუქტი; საკონდიტრო ნაწარმი; ნაყინი, შარბათი, და სხვა საკვები ყინული; ორცხობილები; ბისკვიტები; ალას ნამცხვარი; საკონდიტრო ნაწარმი, კანფეტები; კანფეტები; ვაფლი; ბრიოშები; კაკაო; ყავა; მოუხალავი ყავა; ყავის შემცვლელი, მცენარეული; ნამცხვრები; მარცვლეულის ნაწარმი; ჩაი; შოკოლადი; მარციპანი; ტკბილეული; შაქრის ტკბილეული; სიმინდის ფანტელები; სიმინდის ბურბუშელა; ბატიბუტი; ბლინები; თაფლაკვერები; შაქარი; ნამცხვრის პუდრა; ნამცხვრის ცომი; საკვები ბურღულეული; კაკაოს რძიანი სასმელები; ყავის რძიანი სასმელები;

შოკოლადზე დამზადებული რძიანი სასმელები; მაკარონის ნაწარმი; პური; თაფლი; ღვეზელები; სენდვიჩები; ფუნთუშები; პიცა; პუდინგები; შაქარში მოხალული ნიგოზი ან ნუში, პრალინე; რავიოლი [პელმენის სახეობა]; ბრინჯი; საგო; მანანის ბურღული; სპაგეტი; ტაპიოკა; ღვეზელები ხილკენკრის შიგთავსით; ვერმიშელი; ხორციანი ღვეზელები; პამტეტის ღვეზელი; შვრიაზე დამზადებული საკვები; შვრიის ფანტელები; ყავაზე დამზადებული სასმელები; კაკაოზე დამზადებული სასმელები; შოკოლადზე დამზადებული სასმელები; ყავის შემცვლელი; შაქარყინული; ჩიპსები [მარცვლეულის ნაწარმი]; მუსლი; ბრინჯის კვერები; გაყინული იოგურტი [გაყინული საკონდიტრო ნაწარმი]; ჩაი ყინულით; ჩაიზე დამზადებული სასმელები; ჰალვა; მარცვლეულზე დამზადებული მსუბუქი საუზმეული; ბრინჯის საუზმეული; შოკოლადის მუსი; საკონდიტრო ნაწარმი მუსის სახით; ხილის პიურეები [სოუსები]; ყვავილები და ფოთლები, როგორც ჩაის შემცვლელი; პელმენები; შოკოლადის მორთულობა ნამცხვრებისთვის; ნამცხვრების მოსართავი კანფეტები; შოკოლადში ამოვლებული თხილი; ბრინჯის პუდინგი; შოკოლადის კრემი თხილის შემცველობით; გვირილაზე დამზადებული სასმელები; ბურღულეული; ხილის საკონდიტრო ნაწარმი; კრუსანები; შოკოლადიანი ქაღები; კრემ-ბრიულე; ყავის კაფსულები, შევსებული; ნუგა; ჩაის სასმელები რძით; მცენარეული ჩაი; ღვინის ჩაი; ჩაის შემცვლელი; კაკაოს შემცვლელი.

(260) AM 2023 121043 A

(210) AM 121043

(220) 2022 12 30

(731) სს „სტუმარი ჯგუფი“

სოფ. თოხლიაური, მე-13 ქუჩის I შესახ. 9,
საგარეჯოს მუნიციპალიტეტი,
საქართველო

(740) გიორგი თაქთაქიშვილი

(540)



(591) შავ-თეთრი
(531) 05.07.10
(511)

5 – მცენარეული ჩაი, სამედიცინო დანიშნულები; ღვინის ჩაი, სამედიცინო დანიშნულები.

30 – ფქვილი და მარცვლეულის პროდუქტი; საკონდიტრო ნაწარმი; ნაყინი, შარბათი, და სხვა საკვები ყინული; ორცხოზილები; ბისკვიტები; ალას ნამცხვარი; საკონდიტრო ნაწარმი, კანფეტები; კანფეტები; ვაფლი; ბრიოშები; კაკაო; ყავა; მოუხალავი ყავა; ყავის შემცვლელი, მცენარეული; ნამცხვრები; მარცვლეულის ნაწარმი; ჩაი; შოკოლადი; მარციპანი; ტკბილეული; შაქრის ტკბილეული; სიმინდის ფანტელები; სიმინდის ბურბუშელა; ბატიბუტი; ბლინები; თაფლაკვერები; შაქარი; ნამცხვრის პუდრა; ნამცხვრის ცომი; საკვები ბურღულეული; კაკაოს რძიანი სასმელები; ყავის რძიანი სასმელები; შოკოლადზე დამზადებული რძიანი სასმელები; მაკარონის ნაწარმი; პური; თაფლი; ღვეზელები; სენდვიჩები; ფუნთუშები; პიცა; პუდინგები; შაქარში მოხალული ნიგოზი ან ნუში, პრალინე; რავიოლი [პელმენის სახეობა]; ბრინჯი; საგო; მანანის ბურღული; სპაგეტი; ტაპიოკა; ღვეზელები ხილკენკრის შიგთავსით; ვერმიშელი; ხორციანი ღვეზელები; პაშტეტის ღვეზელი; შვრიანზე დამზადებული საკვები; შვრის ფანტელები; ყავაზე დამზადებული სასმელები; კაკაოზე დამზადებული სასმელები; შოკოლადზე დამზადებული სასმელები; ყავის შემცვლელი; შაქარყინული; ჩიპსები [მარცვლეულის ნაწარმი]; მუსლი; ბრინჯის კვერები; გაყინული იოგურტი [გაყინული საკონდიტრო ნაწარმი]; ჩაი ყინულით; ჩაიზე დამზადებული სასმელები; ჰალვა; მარცვლეულზე დამზადებული მსუბუქი საუზმეული; ბრინჯის საუზმეული; შოკოლადის მუსი; საკონდიტრო ნაწარმი მუსის სახით; ხილის პიურეები [სოუსები]; ყვავილები და ფოთლები, როგორც ჩაის შემცვლელი; პელმენები; შოკოლადის მორთულობა ნამცხვრებისთვის; ნამცხვრების მოსართავი კანფეტები; შოკოლადში ამოვლებული თხილი; ბრინჯის პუდინგი; შოკოლადის კრემი თხილის შემცვლელით; გვირილაზე დამზადებული სასმელები; ბურღულეული; ხილის საკონდიტრო ნაწარმი; კრუსანები; შოკოლადიანი ქაღები; კრემ-ბრიულე; ყავის კაფსულები, შევსებული; ნუგა; ჩაის სასმელები რძით; მცენარეული ჩაი; ღვინის ჩაი; ჩაის შემცვლელი; კაკაოს შემცვლელი.

(260) AM 2023 121050 A

(210) AM 121050

(220) 2023 01 04

(731) ოი კარლ ფაზერ აბ

ფაზერინტიე 6, 01230 ვანტა, ფინეთი

(740) შალვა გვარამაძე

(540)



(591) შავი, ყვითელი, ნაცრისფერი

(531) 26.04.02; 26.04.05; 26.04.22; 26.04.24;
27.01.12; 27.05.01; 27.05.24

(511)

30 – ყავა, ჩაი, კაკაო და მათი შემცვლელი; ბრინჯი, მაკარონი (პასტა) და ატრია; ტაპიოკა და საგო; ფქვილი და მარცვლეულისგან დამზადებული პრეპარატები; პური, საკონდიტრო ნაწარმი და ტკბილეული; შოკოლადი; ნაყინი, სორბეტი, და სხვა საკვები ყინულები; შაქარი, თაფლი, ბადაგი; საფუარი, საცხობი ფხვნილი; მარილი, საკაზმები, სანელებლები, დაკონსერვებული მწვანილი; ძმარი, სოუსები და სხვა სანელებლები; ყინული (გაყინული წყალი).

(260) AM 2023 121126 A

(210) AM 121126

(220) 2023 01 10

(731) ოი კარლ ფაზერ აბ

ფაზერინტიე 6, 01230 ვანტა, ფინეთი

(740) შალვა გვარამაძე

(540)

FINLANDIA

(591) შავ-თეთრი

(511)

30 – ყავა, ჩაი, კაკაო და მათი შემცვლელი; ფქვილი და მარცვლეულისგან დამზადებული პრეპარატები; პური, საკონდიტრო ნაწარმი და ტკბილეული; შოკოლადი; ნაყინი, სორბეტი და სხვა საკვები ყინულები; შაქარი, თაფლი, ბადაგი; ყინული (გაყინული წყალი).

რეგისტრირებული სასაქონლო ნიშნები

(111) M 2023 37047 R (151) 2023 07 11 (181) 2033 07 11 (260) AM 2022 118862 A (220) 2022 08 04 (732) ცოტნე მანდარია გლდანი, V მკრ., კორპ. 1, ბ. 25, 0107, თბილისი, საქართველო; რატი მანდარია გლდანი, V მკრ., კორპ. 1, ბ. 25, 0107, თბილისი, საქართველო	ვაჟა-ფშაველას გამზ. 70, ვაკის რაიონი, თბილისი, საქართველო
(111) M 2023 37048 R (151) 2023 07 11 (181) 2033 07 11 (260) AM 2020 109440 A (220) 2020 08 20 (732) შპს „ჰოტელს მენეჯმენტ გრუპ – HMG“ დიდველი, 1200, ბაკურიანი, საქართველო	(111) M 2023 37052 R (151) 2023 07 11 (181) 2033 07 11 (260) AM 2022 119194 A (220) 2022 08 29 (732) შპს „ნუკი“ ა. რაზმაძის ქ. 52, ბ. 21, 0179, ვაკის რაიონი, თბილისი, საქართველო
(111) M 2023 37049 R (151) 2023 07 11 (181) 2033 07 11 (260) AM 2022 119099 A (220) 2022 08 24 (732) შპს „ფიტნეს ვან“ ვაჟა-ფშაველას გამზ. 71, ვაკის რაიონი, თბილისი, საქართველო	(111) M 2023 37053 R (151) 2023 07 11 (181) 2033 07 11 (260) AM 2022 118079 A (220) 2022 06 09 (732) შპს „ლორდ ჰანი“ სოფ. ახალსოფელი, ყვარლის რაიონი, საქართველო
(111) M 2023 37050 R (151) 2023 07 11 (181) 2033 07 11 (260) AM 2022 119092 A (220) 2022 08 24 (732) შპს „ფიტნეს ვან“ ვაჟა-ფშაველას გამზ. 71, ვაკის რაიონი, თბილისი, საქართველო	(111) M 2023 37054 R (151) 2023 07 11 (181) 2033 07 11 (260) AM 2022 118845 A (220) 2022 08 03 (732) შპს „არაკი“ პეტრე ბაგრატიონის ქ. 53, 0132, თბილისი, საქართველო
(111) M 2023 37051 R (151) 2023 07 11 (181) 2033 07 11 (260) AM 2022 118927 A (220) 2022 08 09 (732) შპს „სითი დეველოპმენტ“	(111) M 2023 37055 R (151) 2023 07 11 (181) 2033 07 11 (260) AM 2022 119084 A (220) 2022 08 23 (732) ტარასი გაგნიძე ნ. ყიფშიძის ქ. 8/24, 0162, თბილისი, საქართველო
	(111) M 2023 37056 R (151) 2023 07 11 (181) 2033 07 11 (260) AM 2022 119111 A

(220) 2022 08 25 (732) ალექსანდრე სუქიაშვილი ვარკეთილი, III მასივი, კორპ. 34, ბ. 27, 0182, თბილისი, საქართველო	(732) ქეი თი & ჯი კორპორეიშნ 71, ბეოტკვოტ-გილ, დაედოკ-გუ, ტეჯონი, კორეის რესპუბლიკა
(111) M 2023 37057 R (151) 2023 07 11 (181) 2033 07 11 (260) AM 2022 118854 A (220) 2022 08 04 (732) ორანჯ ბრენდ სერვისიზ ლიმიტედ 3 მორ ლონდონ რივერსაიდი, ლონდონი, SE1 2AQ, გაერთიანებული სამეფო	(111) M 2023 37062 R (151) 2023 07 11 (181) 2033 07 11 (260) AM 2022 118749 A (220) 2022 07 26 (732) ქეი თი & ჯი კორპორეიშნ 71, ბეოტკვოტ-გილ, დაედოკ-გუ, ტეჯონი, კორეის რესპუბლიკა
(111) M 2023 37058 R (151) 2023 07 11 (181) 2033 07 11 (260) AM 2022 118393 A (220) 2022 07 05 (732) თორნიკე ზუმბაძე ტაშკენტის ქ. 23/1, ბ. 7, თბილისი, საქართველო	(111) M 2023 37063 R (151) 2023 07 11 (181) 2033 07 11 (260) AM 2022 118767 A (220) 2022 07 29 (732) ქეი თი & ჯი კორპორეიშნ 71, ბეოტკვოტ-გილ, დაედოკ-გუ, ტეჯონი, კორეის რესპუბლიკა
(111) M 2023 37059 R (151) 2023 07 11 (181) 2033 07 11 (260) AM 2022 118830 A (220) 2022 07 29 (732) ჰაქან ოქთარ ულუს მაჰალესი ლეილაქ სოქ ულუს ვადი ქონუთრალი B3/7, ბეშიქთაში, სტამბოლი, 1111, თურქეთი	(111) M 2023 37064 R (151) 2023 07 11 (181) 2033 07 11 (260) AM 2022 119091 A (220) 2022 08 23 (732) ქეი თი & ჯი კორპორეიშნ 71, ბეოტკვოტ-გილ, დაედოკ-გუ, ტეჯონი, კორეის რესპუბლიკა
(111) M 2023 37060 R (151) 2023 07 11 (181) 2033 07 11 (260) AM 2022 118747 A (220) 2022 07 26 (732) ქეი თი & ჯი კორპორეიშნ 71, ბეოტკვოტ-გილ, დაედოკ-გუ, ტეჯონი, კორეის რესპუბლიკა	(111) M 2023 37065 R (151) 2023 07 11 (181) 2033 07 11 (260) AM 2022 119090 A (220) 2022 08 23 (732) ქეი თი & ჯი კორპორეიშნ 71, ბეოტკვოტ-გილ, დაედოკ-გუ, ტეჯონი, კორეის რესპუბლიკა
(111) M 2023 37061 R (151) 2023 07 11 (181) 2033 07 11 (260) AM 2022 118748 A (220) 2022 07 26	(111) M 2023 37066 R (151) 2023 07 11 (181) 2033 07 11 (260) AM 2022 118745 A (220) 2022 07 26 (732) ქეი თი & ჯი კორპორეიშნ

<p>71, ბეოტკვოტ-გილ, დაედეოკ-გუ, ტეჯონი, კორეის რესპუბლიკა</p>	<p>(111) M 2023 37072 R (151) 2023 07 11 (181) 2033 07 11 (260) AM 2022 118740 A (220) 2022 07 26 (732) ქეი თი & ჯი კორპორეიშნ 71, ბეოტკვოტ-გილ, დაედეოკ-გუ, ტეჯონი, კორეის რესპუბლიკა</p>
<p>(111) M 2023 37067 R (151) 2023 07 11 (181) 2033 07 11 (260) AM 2022 118744 A (220) 2022 07 26 (732) ქეი თი & ჯი კორპორეიშნ 71, ბეოტკვოტ-გილ, დაედეოკ-გუ, ტეჯონი, კორეის რესპუბლიკა</p>	<p>(111) M 2023 37073 R (151) 2023 07 11 (181) 2033 07 11 (260) AM 2022 118741 A (220) 2022 07 26 (732) ქეი თი & ჯი კორპორეიშნ 71, ბეოტკვოტ-გილ, დაედეოკ-გუ, ტეჯონი, კორეის რესპუბლიკა</p>
<p>(111) M 2023 37068 R (151) 2023 07 11 (181) 2033 07 11 (260) AM 2022 118743 A (220) 2022 07 26 (732) ქეი თი & ჯი კორპორეიშნ 71, ბეოტკვოტ-გილ, დაედეოკ-გუ, ტეჯონი, კორეის რესპუბლიკა</p>	<p>(111) M 2023 37074 R (151) 2023 07 11 (181) 2033 07 11 (260) AM 2022 118738 A (220) 2022 07 26 (732) ქეი თი & ჯი კორპორეიშნ 71, ბეოტკვოტ-გილ, დაედეოკ-გუ, ტეჯონი, კორეის რესპუბლიკა</p>
<p>(111) M 2023 37069 R (151) 2023 07 11 (181) 2033 07 11 (260) AM 2022 118379 A (220) 2022 07 03 (732) ქეი თი & ჯი კორპორეიშნ 71, ბეოტკვოტ-გილ, დაედეოკ-გუ, ტეჯონი, კორეის რესპუბლიკა</p>	<p>(111) M 2023 37075 R (151) 2023 07 11 (181) 2033 07 11 (260) AM 2022 118638 A (220) 2022 07 17 (732) ქეი თი & ჯი კორპორეიშნ 71, ბეოტკვოტ-გილ, დაედეოკ-გუ, ტეჯონი, კორეის რესპუბლიკა</p>
<p>(111) M 2023 37070 R (151) 2023 07 11 (181) 2033 07 11 (260) AM 2022 118739 A (220) 2022 07 26 (732) ქეი თი & ჯი კორპორეიშნ 71, ბეოტკვოტ-გილ, დაედეოკ-გუ, ტეჯონი, კორეის რესპუბლიკა</p>	<p>(111) M 2023 37076 R (151) 2023 07 11 (181) 2033 07 11 (260) AM 2022 118380 A (220) 2022 07 03 (732) ქეი თი & ჯი კორპორეიშნ 71, ბეოტკვოტ-გილ, დაედეოკ-გუ, ტეჯონი, კორეის რესპუბლიკა</p>
<p>(111) M 2023 37071 R (151) 2023 07 11 (181) 2033 07 11 (260) AM 2022 118742 A (220) 2022 07 26 (732) ქეი თი & ჯი კორპორეიშნ 71, ბეოტკვოტ-გილ, დაედეოკ-გუ, ტეჯონი, კორეის რესპუბლიკა</p>	

(111) M 2023 37077 R
 (151) 2023 07 11
 (181) 2033 07 11
 (260) AM 2022 118381 A
 (220) 2022 07 03
 (732) ქეი თი & ჯი კორპორეიშნ
 71, ბეოტკკოტ-გილ, დაედეოკ-გუ,
 ტეჯონი, კორეის რესპუბლიკა

(111) M 2023 37082 R
 (151) 2023 07 11
 (181) 2033 07 11
 (260) AM 2022 118635 A
 (220) 2022 07 17
 (732) ქეი თი & ჯი კორპორეიშნ
 71, ბეოტკკოტ-გილ, დაედეოკ-გუ,
 ტეჯონი, კორეის რესპუბლიკა

(111) M 2023 37078 R
 (151) 2023 07 11
 (181) 2033 07 11
 (260) AM 2022 118637 A
 (220) 2022 07 17
 (732) ქეი თი & ჯი კორპორეიშნ
 71, ბეოტკკოტ-გილ, დაედეოკ-გუ,
 ტეჯონი, კორეის რესპუბლიკა

(111) M 2023 37083 R
 (151) 2023 07 11
 (181) 2033 07 11
 (260) AM 2022 118634 A
 (220) 2022 07 17
 (732) ქეი თი & ჯი კორპორეიშნ
 71, ბეოტკკოტ-გილ, დაედეოკ-გუ,
 ტეჯონი, კორეის რესპუბლიკა

(111) M 2023 37079 R
 (151) 2023 07 11
 (181) 2033 07 11
 (260) AM 2022 118382 A
 (220) 2022 07 03
 (732) ქეი თი & ჯი კორპორეიშნ
 71, ბეოტკკოტ-გილ, დაედეოკ-გუ,
 ტეჯონი, კორეის რესპუბლიკა

(111) M 2023 37084 R
 (151) 2023 07 11
 (181) 2033 07 11
 (260) AM 2022 118746 A
 (220) 2022 07 26
 (732) ქეი თი & ჯი კორპორეიშნ
 71, ბეოტკკოტ-გილ, დაედეოკ-გუ,
 ტეჯონი, კორეის რესპუბლიკა

(111) M 2023 37080 R
 (151) 2023 07 11
 (181) 2033 07 11
 (260) AM 2022 118636 A
 (220) 2022 07 17
 (732) ქეი თი & ჯი კორპორეიშნ
 71, ბეოტკკოტ-გილ, დაედეოკ-გუ,
 ტეჯონი, კორეის რესპუბლიკა

(111) M 2023 37081 R
 (151) 2023 07 11
 (181) 2033 07 11
 (260) AM 2022 118383 A
 (220) 2022 07 04
 (732) ქეი თი & ჯი კორპორეიშნ
 71, ბეოტკკოტ-გილ, დაედეოკ-გუ,
 ტეჯონი, კორეის რესპუბლიკა

დაჩქარებული პროცედურით რეგისტრირებული სასაქონლო ნიშნები

რეგისტრაციის გაუქმების მოთხოვნით საჩივრის შეტანა შესაძლებელია საქპატენტის სააპელაციო პალატაში გამოქვეყნებიდან 3 თვის ვადაში.

(111) M 2023 37032 R

(151) 2023 07 11

(181) 2033 07 11

(210) AM 123104

(220) 2023 06 01

(732) ფილიპ მორის ბრენდს სარლ

კე ჟანრენო 3, 2000 ნევშატელი, შვეიცარია

(740) პავლე მეიფარიანი

(540)

**UNIQUE
FLAVOR
UNIQUE
EXPERIENCE**



(591) წითელი, შავი, თეთრი

(531) 24.07.01; 24.07.13; 27.05.01; 27.05.15;

29.01.12

(511)

34 – დაუმუშავებელი ან დამუშავებული თამბაქო; თამბაქოს ნაწარმი; სიგარები, სიგარეტები, პაპიროსები, სიგარილოები, თვითგახვეული (თვითნაკეთი) სიგარეტებისათვის განკუთვნილი თამბაქო, ჩიბუხის თამბაქო, საღეჭი თამბაქო, საბურნუთე თამბაქო, კრეტეკი; სნუსი; თამბაქოს შემცველები (არასამედიცინო დანიშნულების); ელექტრონული სიგარეტები; თამბაქოს ნაწარმი მათი შემდგომი გახურების მიზნით; ელექტრონული მოწყობილობები და მათი ნაწილები სიგარეტების ან თამბაქოს გასახურებლად ნიკოტინის შემცველი აეროზოლის გამოყოფისათვის შესუნთქვის მიზნით; თხევადი ნიკოტინის ხსნარები ელექტრონულ სიგარეტებში გამოსაყენებლად; მწველთა საკუთვნო, სიგარეტის და პაპიროსის ქაღალდი, სიგარეტის და პაპიროსის მილაკები (სიგარეტის და პაპიროსის ჰილზები), სიგარეტის ფილტრები, თამბაქოსათვის განკუთვნილი ქილები, სიგარეტის კოლოფები (პორტსიგარები), საფერფლები, ჩიბუხები, სიგარეტის გასახვევად განკუთვნილი ჯიბის მოწყობილობები, სანთებლები, ასანთი.

(111) M 2023 37033 R

(151) 2023 07 11

(181) 2033 07 11

(210) AM 123165

(220) 2023 06 02

(732) ფილიპ მორის ბრენდს სარლ

კე ჟანრენო 3, 2000 ნევშატელი, შვეიცარია

(740) პავლე მეიფარიანი

(540)



Marlboro

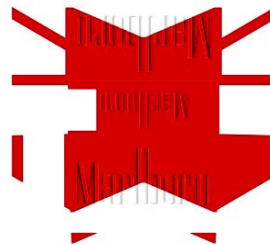

(591) წითელი, რუხი, თეთრი

(531) 19.03.24; 24.07.13; 25.01.25

(511)

34 – დაუმუშავებელი ან დამუშავებული თამბაქო; თამბაქოს ნაწარმი; სიგარები, სიგარეტები, პაპიროსები, სიგარილოები, თვითგახვეული (თვითნაკეთი) სიგარეტებისათვის განკუთვნილი თამბაქო, ჩიბუხის თამბაქო, საღეჭი თამბაქო, საბურნუთე თამბაქო, კრეტეკი; სნუსი; თამბაქოს შემცველები (არასამედიცინო დანიშნულების); ელექტრონული სიგარეტები; თამბაქოს ნაწარმი მათი შემდგომი გახურების მიზნით; ელექტრონული მოწყობილობები და მათი ნაწილები სიგარეტების ან თამბაქოს გასახურებლად ნიკოტინის შემცველი აეროზოლის გამოყოფისათვის შესუნთქვის მიზნით; თხევადი ნიკოტინის ხსნარები ელექტრონულ სიგარეტებში

გამოსაყენებლად; მწველთა საკუთვნო, სიგარეტის და პაპიროსის ქაღალდი, სიგარეტის და პაპიროსის მილაკები (სიგარეტის და პაპიროსის ჰილზები), სიგარეტის ფილტრები, თამბაქოსათვის განკუთვნილი ქილები, სიგარეტის კოლოფები (პორტსიგარები), საფერფლეები, ჩიბუხები, სიგარეტის გასახვევად განკუთვნილი ჯიბის მოწყობილობები, სანთებლები, ასანთი.

(111) M 2023 37034 R

(151) 2023 07 11

(181) 2033 07 11

(210) AM 123171

(220) 2023 06 02

(732) ფილიპ მორის ბრენდს სარლ

კე ჟანრენო 3, 2000 ნევშატელი, შვეიცარია

(740) პავლე მეიფარიანი

(540)



(591) წითელი, ლურჯი, რუხი, თეთრი

(531) 19.03.24; 24.07.13; 25.01.01; 27.05.24; 29.01.14

(511)

34 – დაუმუშავებელი ან დამუშავებული თამბაქო; თამბაქოს ნაწარმი; სიგარები, სიგარეტები, პაპიროსები, სიგარილოები, თვითგახვეული (თვითნაკეთი) სიგარეტებისათვის განკუთვნილი თამბაქო, ჩიბუხის თამბაქო, საღეჭი თამბაქო, საბურნუთე თამბაქო, კრეტეკი; სნუსი; თამბაქოს შემცველები (არასამედიცინო დანიშნულების); ელექტრონული სიგარეტები; თამბაქოს ნაწარმი მათი შემდგომი გახურების მიზნით; ელექტრონული მოწყობილობები და მათი ნა-

წილები სიგარეტების ან თამბაქოს გასახურებლად ნიკოტინის შემცველი აეროზოლის გამოყოფისათვის შესუნთქვის მიზნით; თხევადი ნიკოტინის ხსნარები ელექტრონულ სიგარეტებში გამოსაყენებლად; მწველთა საკუთვნო, სიგარეტის და პაპიროსის ქაღალდი, სიგარეტის და პაპიროსის მილაკები (სიგარეტის და პაპიროსის ჰილზები), სიგარეტის ფილტრები, თამბაქოსათვის განკუთვნილი ქილები, სიგარეტის კოლოფები (პორტსიგარები), საფერფლეები, ჩიბუხები, სიგარეტის გასახვევად განკუთვნილი ჯიბის მოწყობილობები, სანთებლები, ასანთი.

(111) M 2023 37035 R

(151) 2023 07 11

(181) 2033 07 11

(210) AM 123172

(220) 2023 06 02

(732) ფილიპ მორის ბრენდს სარლ

კე ჟანრენო 3, 2000 ნევშატელი, შვეიცარია

(740) პავლე მეიფარიანი

(540)



(591) ოქროსფერი, ცისფერი, ლურჯი, თეთრი

(531) 19.03.24; 24.07.13; 25.01.25; 27.05.01; 27.05.24; 29.01.14

(511)

34 – დაუმუშავებელი ან დამუშავებული თამბაქო; თამბაქოს ნაწარმი; სიგარები, სიგარეტები, პაპიროსები, სიგარილოები, თვითგახვეული (თვითნაკეთი) სიგარეტებისათვის განკუთვნილი თამბაქო, ჩიბუხის თამბაქო, საღეჭი თამბაქო, საბურნუთე თამბაქო, კრეტეკი; სნუსი; თამ-

ბაქოს შემცვლელი (არასამედიცინო დანიშნულების); ელექტრონული სიგარეტები; თამბაქოს ნაწარმი მათი შემდგომი გახურების მიზნით; ელექტრონული მოწყობილობები და მათი ნაწილები სიგარეტების ან თამბაქოს გასახურებლად ნიკოტინის შემცველი აეროზოლის გამოყოფისათვის შესუნთქვის მიზნით; თხევადი ნიკოტინის ხსნარები ელექტრონულ სიგარეტებში გამოსაყენებლად; მწველთა საკუთვნო, სიგარეტის და პაპიროსის ქაღალდი, სიგარეტის და პაპიროსის მილაკები (სიგარეტის და პაპიროსის ჰილზები), სიგარეტის ფილტრები, თამბაქოსათვის განკუთვნილი ქილები, სიგარეტის კოლოფები (პორტსიგარები), საფერფლეები, ჩიბუხები, სიგარეტის გასახვევად განკუთვნილი ჯიბის მოწყობილობები, სანთებლები, ასანთი.

- (111) M 2023 37036 R
- (151) 2023 07 11
- (181) 2033 07 11
- (210) AM 123173
- (220) 2023 06 02
- (732) ფილიპ მორის ბრენდუ სარლ
კე ჟანრენო 3, 2000 ნევმატელი, შვეიცარია
- (740) პავლე მეიფარიანი
- (540)

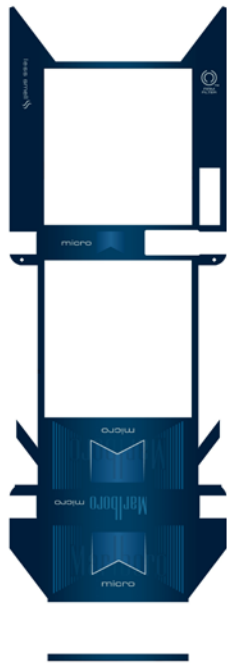

- (591) მუქი ლურჯი, ღია ლურჯი, თეთრი
- (531) 19.03.24; 24.07.13; 25.01.25; 29.01.13
- (511)
- 34 – დაუმუშავებელი ან დამუშავებული თამბაქო; თამბაქოს ნაწარმი; სიგარები, სიგარეტები,

პაპიროსები, სიგარილოები, თვითგახვეული (თვითნაკეთი) სიგარეტებისათვის განკუთვნილი თამბაქო, ჩიბუხის თამბაქო, სადეჰი თამბაქო, საბურნუთე თამბაქო, კრეტეკი; სნუსი; თამბაქოს შემცვლელი (არასამედიცინო დანიშნულების); ელექტრონული სიგარეტები; თამბაქოს ნაწარმი მათი შემდგომი გახურების მიზნით; ელექტრონული მოწყობილობები და მათი ნაწილები სიგარეტების ან თამბაქოს გასახურებლად ნიკოტინის შემცველი აეროზოლის გამოყოფისათვის შესუნთქვის მიზნით; თხევადი ნიკოტინის ხსნარები ელექტრონულ სიგარეტებში გამოსაყენებლად; მწველთა საკუთვნო, სიგარეტის და პაპიროსის ქაღალდი, სიგარეტის და პაპიროსის მილაკები (სიგარეტის და პაპიროსის ჰილზები), სიგარეტის ფილტრები, თამბაქოსათვის განკუთვნილი ქილები, სიგარეტის კოლოფები (პორტსიგარები), საფერფლეები, ჩიბუხები, სიგარეტის გასახვევად განკუთვნილი ჯიბის მოწყობილობები, სანთებლები, ასანთი.

- (111) M 2023 37037 R
- (151) 2023 07 11
- (181) 2033 07 11
- (210) AM 123174
- (220) 2023 06 02
- (732) ფილიპ მორის ბრენდუ სარლ
კე ჟანრენო 3, 2000 ნევმატელი, შვეიცარია
- (740) პავლე მეიფარიანი
- (540)

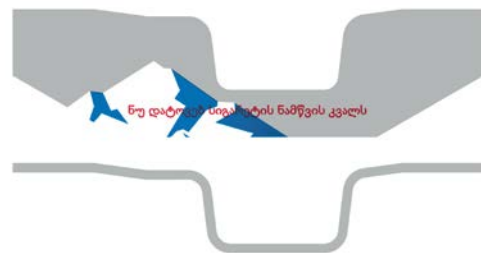

- (591) რუხი, ლურჯი, წითელი, თეთრი
- (531) 19.03.24; 26.13.25; 29.01.14
- (511)
- 34 – დაუმუშავებელი ან დამუშავებული თამბაქო; თამბაქოს ნაწარმი; სიგარები, სიგარეტები, პაპიროსები, სიგარილოები, თვითგახვეული (თვითნაკეთი) სიგარეტებისათვის განკუთვნილი თამბაქო, ჩიბუხის თამბაქო, სადეჰი თამბაქო, საბურნუთე თამბაქო, კრეტეკი; სნუსი; თამბაქოს შემცვლელი (არასამედიცინო დანიშნულების); ელექტრონული სიგარეტები; თამბაქოს ნაწარმი მათი შემდგომი გახურების მიზნით; ელექტრონული მოწყობილობები და მათი ნა-

წილები სიგარეტების ან თამბაქოს გასახურებლად ნიკოტინის შემცველი აეროზოლის გამოყოფისათვის შესუნთქვის მიზნით; თხევადი ნიკოტინის ხსნარები ელექტრონულ სიგარეტებში გამოსაყენებლად; მწველთა საკუთვნო, სიგარეტის და პაპიროსის ქაღალდი, სიგარეტის და პაპიროსის მილაკები (სიგარეტის და პაპიროსის ჰილზები), სიგარეტის ფილტრები, თამბაქოსათვის განკუთვნილი ქილები, სიგარეტის კოლოფები (პორტსიგარები), საფერფლეები, ჩიბუხები, სიგარეტის გასახვევად განკუთვნილი ჯიბის მოწყობილობები, სანთებლები, ასანთი.

(111) M 2023 37038 R

(151) 2023 07 11

(181) 2033 07 11

(210) AM 123175

(220) 2023 06 02

(732) ფილიპ მორის ბრენდუ სარლ

კე ჟანრენო 3, 2000 ნევმატელი, შვეიცარია

(740) პავლე მეიფარიანი

(540)



(591) ცისფერი, ლურჯი, ოქროსფერი, თეთრი

(531) 19.03.24; 26.13.25; 29.01.14

(511)

34 – დაუმუშავებელი ან დამუშავებული თამბაქო; თამბაქოს ნაწარმი; სიგარები, სიგარეტები, პაპიროსები, სიგარილოები, თვითგახვეული (თვითნაკეთი) სიგარეტებისათვის განკუთვნილი თამბაქო, ჩიბუხის თამბაქო, სადეჭი თამბაქო, საბურნუთე თამბაქო, კრეტეკი; სნუსი; თამბაქოს შემცვლელი (არასამედიცინო დანიშნულების); ელექტრონული სიგარეტები; თამბაქოს ნაწარმი მათი შემდგომი გახურების მიზნით; ელექტრონული მოწყობილობები და მათი ნაწილები სიგარეტების ან თამბაქოს გასახურებლად ნიკოტინის შემცველი აეროზოლის გამოყოფისათვის შესუნთქვის მიზნით; თხევადი ნიკოტინის ხსნარები ელექტრონულ სიგარეტებში გამოსაყენებლად; მწველთა საკუთვნო, სიგარეტის და პაპიროსის ქაღალდი, სიგარეტის და პაპიროსის მილაკები (სიგარეტის და პაპიროსის ჰილზები), სიგარეტის ფილტრები, თამბაქოსათვის განკუთვნილი ქილები, სიგარეტის კოლოფები (პორტსიგარები), საფერფლეები, ჩიბუხები, სიგარეტის გასახვევად განკუთვნილი ჯიბის მოწყობილობები, სანთებლები, ასანთი.

ჰილზები), სიგარეტის ფილტრები, თამბაქოსათვის განკუთვნილი ქილები, სიგარეტის კოლოფები (პორტსიგარები), საფერფლეები, ჩიბუხები, სიგარეტის გასახვევად განკუთვნილი ჯიბის მოწყობილობები, სანთებლები, ასანთი.

(111) M 2023 37039 R

(151) 2023 07 11

(181) 2033 07 11

(210) AM 123176

(220) 2023 06 02

(732) ფილიპ მორის ბრენდუ სარლ

კე ჟანრენო 3, 2000 ნევმატელი, შვეიცარია

(740) პავლე მეიფარიანი

(540)

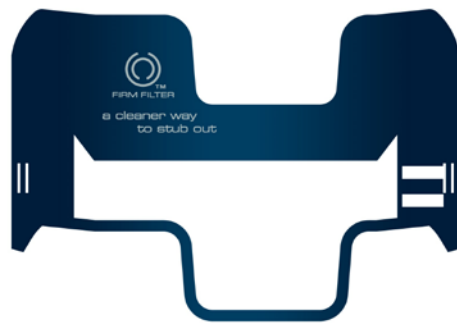

(591) ლურჯი, თეთრი

(531) 19.03.24; 26.13.25; 29.01.12

(511)

34 – დაუმუშავებელი ან დამუშავებული თამბაქო; თამბაქოს ნაწარმი; სიგარები, სიგარეტები, პაპიროსები, სიგარილოები, თვითგახვეული (თვითნაკეთი) სიგარეტებისათვის განკუთვნილი თამბაქო, ჩიბუხის თამბაქო, სადეჭი თამბაქო, საბურნუთე თამბაქო, კრეტეკი; სნუსი; თამბაქოს შემცვლელი (არასამედიცინო დანიშნულების); ელექტრონული სიგარეტები; თამბაქოს ნაწარმი მათი შემდგომი გახურების მიზნით; ელექტრონული მოწყობილობები და მათი ნაწილები სიგარეტების ან თამბაქოს გასახურებლად ნიკოტინის შემცველი აეროზოლის გამოყოფისათვის შესუნთქვის მიზნით; თხევადი ნიკოტინის ხსნარები ელექტრონულ სიგარეტებში გამოსაყენებლად; მწველთა საკუთვნო, სიგარეტის და პაპიროსის ქაღალდი, სიგარეტის და პაპიროსის მილაკები (სიგარეტის და პაპიროსის ჰილზები), სიგარეტის ფილტრები, თამბაქოსათვის განკუთვნილი ქილები, სიგარეტის კოლოფები (პორტსიგარები), საფერფლეები, ჩიბუხები, სიგარეტის გასახვევად განკუთვნილი ჯიბის მოწყობილობები, სანთებლები, ასანთი.

(111) M 2023 37040 R
(151) 2023 07 11
(181) 2033 07 11
(210) AM 123218
(220) 2023 06 08
(732) შპს „Bolero & Company“
ქუჩიშვილის ქ. 12-14-16, 0159, თბილისი,
საქართველო
(540)



გორი მოლი - GORI MALL

(591) თეთრი, წითელი, ცისფერი, ლურჯი,
მწვანე, იასამნისფერი, ყვითელი,
ნარინჯისფერი, ვარდისფერი
(531) 01.15.07; 01.15.21; 10.03.10; 10.03.11;
27.05.02; 28.19; 29.01.15
(526) გორი gori
(511)
35 – რეკლამა; ბიზნესის მართვა; ბიზნესის ად-
მინისტრირება; საოფისე მომსახურება.

(111) M 2023 37041 R
(151) 2023 07 11
(181) 2033 07 11
(210) AM 123582
(220) 2023 07 04
(732) სს „ელიტ ელექტრონიკსი“
პეტრე ქავთარაძის ქ. 3, 0180, თბილისი,
საქართველო
(740) შოთა მინდელი
(540)



(591) F26868 წითელი, თეთრი
(531) 26.04.02; 26.04.03; 26.04.22; 26.04.24;
27.05.22; 27.05.24; 29.01.12
(511)
35 – რეკლამა; ბიზნესის მართვა; ბიზნესის ად-
მინისტრირება; საოფისე მომსახურება.

(111) M 2023 37042 R
(151) 2023 07 11
(181) 2033 07 11
(210) AM 123497

(220) 2023 06 27
(732) შპს „ფუდ ბოლს ჯორჯია“
ქინძმარაულის ქ. 5, (ნაკვეთი 1/99), 0145,
სამგორის რაიონი, თბილისი,
საქართველო
(540)

Food Balls

(591) შავ-თეთრი
(511)
43 – საკვებით და სასმელით უზრუნველყოფა;
დროებითი საცხოვრებელი უზრუნველყოფა.

(111) M 2023 37043 R
(151) 2023 07 11
(181) 2033 07 11
(210) AM 123412
(220) 2023 06 19
(732) ალექსანდრა მარია დე ალმეიდა ალვეს
ჟარდინო
რუა ხოსე გომეს მონტეირო 8,4C
ოდეველას 2675-296, პორტუგალია
(740) საბა ქევხიშვილი
(540)



(591) შავ-თეთრი
(531) 03.01.08; 26.01.01; 26.01.15; 27.05.07;
27.07.11; 27.07.17
(511)
35 – ბიზნეს პროექტების მართვის მომსახურება
სამშენებლო პროექტებისთვის.
37 – მშენებლობა.
42 – გაფორმება (ინტერიერის); დაგეგმვა (მშენ-
ებლობის); ინტერიერის დიზაინი.
44 – დიზაინი (ლანდშაფტის).

(111) M 2023 37044 R
(151) 2023 07 11
(181) 2033 07 11
(210) AM 123415
(220) 2023 06 20
(310) UK00003917611

(320) 2023 05 31

(330) UK

(732) კრისტალ კასტლ ლიმიტიდ
სი მიდოუ ჰაუს, პ.ო. ბოქს 116, როუდ
თაუნ, ტორტოლა, ვირჯინის კუნძულები
(ბრიტანეთის)

(740) გიორგი ქართველიშვილი

(540)

EBCREATE

(591) შავ-თეთრი

(511)

34 – თამბაქო; სიგარეტები თამბაქოს შემცველებით, არასამედიცინო დანიშნულების; ელექტრო სიგარეტები; თხევადი ნიკოტინის ხსნარი ელექტრო სიგარეტებში გამოსაყენებლად; ფილტრიანი სიგარეტები; პირიდან გამოსაორთქლებლები მწვევლთათვის; თხევადი ნიკოტინის ხსნარები ელექტრონულ სიგარეტში გამოსაყენებლად; სიგარეტის ფილტრები; სიგარეტები; არომატული ნივთიერებები ელექტრო სიგარეტებში გამოსაყენებლად, ეთერზეთების გარდა; კარტრიჯები ელექტრო სიგარეტებისთვის; ხელსაწყოები თამბაქოს გასახურებლად ინჰალაციის მიზნით; ელექტრო ჩიბუხები; პორტსიგარები; სიგარები; მოსაწევი ბალახები; ელექტრო სიგარები; ელექტრო სიგარეტის პორტსიგარები; ელექტრო სიგარეტის ცვლადი და სტრუქტურული ნაწილები; ელექტრო სიგარეტის პულვერიზატორები.

(111) M 2023 37045 R

(151) 2023 07 11

(181) 2033 07 11

(210) AM 123505

(220) 2023 06 28

(732) შპს „ელექტრონიკა 2014“
ჯავახიშვილის ქ. 1, 0108, დიდუბე-
ჩუღურეთის რაიონი, თბილისი,
საქართველო

(740) იოანე იარაჯული

(540)

MIMI

(591) შავ-თეთრი

(511)

7 – მანქანები და მანქანა-დანადგარები, სიმძლავრეზე მომუშავე მანქანა-დანადგარები; მოტორები და ძრავები, სახმელეთო ტრანსპორტის მოტორებისა და ძრავების გარდა; გადასაბმელი და გადამცემი კომპონენტები მანქანებისთვის,

სახმელეთო ტრანსპორტისთვის განკუთვნილის გარდა; სასოფლო-სამეურნეო ინსტრუმენტები, ხელის იარაღების გარდა; ინკუბატორები კვერცხებისთვის; ავტომატური სავაჭრო აპარატები [სასმელების, შოკოლადის და სხვა პროდუქტებისთვის].

11 – განათების, გათბობის, გაგრილების, ორთქლწარმოქმნის, საჭმლის მომზადების, საშრობი, სავენტილაციო, წყალმომარაგების და სანიტარული აპარატურა და დანადგარები.

24 – ქსოვილები და მათი შემცველები; საოჯახო თეთრეული; ფარდები, ქსოვილის ან პლასტმასის.

(111) M 2023 37046 R

(151) 2023 07 11

(181) 2033 07 11

(210) AM 123506

(220) 2023 06 28

(732) შპს „ელექტრონიკა 2014“
ჯავახიშვილის ქ. 1, 0108, დიდუბე-
ჩუღურეთის რაიონი, თბილისი,
საქართველო

(740) იოანე იარაჯული

(540)

BAUF

(591) შავ-თეთრი

(511)

7 – მანქანები და მანქანა-დანადგარები, სიმძლავრეზე მომუშავე მანქანა-დანადგარები; მოტორები და ძრავები, სახმელეთო ტრანსპორტის მოტორებისა და ძრავების გარდა; გადასაბმელი და გადამცემი კომპონენტები მანქანებისთვის, სახმელეთო ტრანსპორტისთვის განკუთვნილის გარდა; სასოფლო-სამეურნეო ინსტრუმენტები, ხელის იარაღების გარდა; ინკუბატორები კვერცხებისთვის; ავტომატური სავაჭრო აპარატები [სასმელების, შოკოლადის და სხვა პროდუქტებისთვის].

11 – განათების, გათბობის, გაგრილების, ორთქლწარმოქმნის, საჭმლის მომზადების, საშრობი, სავენტილაციო, წყალმომარაგების და სანიტარული აპარატურა და დანადგარები.

საერთაშორისო სასაქონლო ნიშნები, რომლებზეც გამოტანილია გადაწყვეტილება დაცვის მინიჭების შესახებ

გადაწყვეტილების გასაჩივრება შესაძლებელია საქპატენტის სააპელაციო პალატაში გამოქვეყნებიდან 3 თვის ვადაში ან მცხეთის რაიონული სასამართლოს ადმინისტრაციულ საქმეთა კოლეგიაში 1 თვის ვადაში (მის.: ქ. მცხეთა, სამხედროს ქ. №17).

(260) AM 2023 116673 A
(800) 1644423
(151) 2021 12 10
(891) 2021 12 10
(731) GlovoAPP23 S.L.
Carrer Pallars, 190, E-08005 Barcelona, Spain
(540)

GlovoBusiness?

(591) Black, yellow
(531) 18.05.06; 24.17.24; 27.05.01; 29.01.12
(511)
35 – Advertising; commercial business management; commercial business management organization; commercial business management and advice; advisory services relating to commercial business management; administration of commercial affairs; commercial company management administration; office functions; company management assistance in the operation of restaurants; company management assistance in the establishment and operation of restaurants.
36 – Financial affairs; monetary affairs; consulting in connection with real estate business.
42 – Scientific and technological services; industrial analysis and research services.

(260) AM 2023 116679 A
(800) 1644466
(151) 2021 12 10
(891) 2021 12 10
(731) GlovoAPP23 S.L.
Carrer Pallars, 190, E-08005 Barcelona, Spain
(540)

Glovoaccess

(591) Black, green
(531) 02.09.01; 27.05.09; 29.01.12
(511)
39 – Transport; collection of goods; storage of beverages; storage of frozen food in warehouses; storage of food; charitable services, namely providing transportation.
40 – Preservation of food; preservation of drink.

(260) AM 2023 116680 A
(800) 1644467
(151) 2021 12 10
(891) 2021 12 10
(731) GlovoAPP23 S.L.
Carrer Pallars, 190, E-08005 Barcelona, Spain
(540)

Glovo Last Mile

(591) Green, orange, white
(531) 27.05.09; 29.01.13
(511)
35 – Advertising, marketing and promotional services; sales promotion for others; sales promotion; preparation of advertising campaigns; wholesale ordering services.

(260) AM 2023 116683 A
(800) 1644471
(151) 2021 12 10
(891) 2021 12 10
(731) GlovoAPP23 S.L.
Carrer Pallars, 190, E-08005 Barcelona, Spain
(540)

**FO
CORNER**
by **Glovo?**

(591) Black, white
(531) 18.05.06; 24.17.04; 27.05.01; 27.05.05;
27.05.09; 27.05.17
(511)
35 – Retail services relating to food; advertising; marketing; on-line ordering services in the field of restaurant take-out and delivery.
36 – Rental of real estate; leasing and rental of commercial premises.
39 – Transport; collection of goods.
40 – Preservation of food.
43 – Take-away food services; take-away fast food services; take-out restaurant services; services for the preparation of food and drink.

(260) AM 2023 116684 A
 (800) 1644472
 (151) 2021 12 10
 (891) 2021 12 10
 (731) GlovoAPP23 S.L.
 Carrer Pallars, 190, E-08005 Barcelona, Spain
 (540)

Food Corner by Glovo

(591) Black, white
 (511)
 36 – Rental of real estate; leasing and rental of commercial premises.
 39 – Transport; collection of goods.
 40 – Preservation of food.
 43 – Take-away food services; take-away fast food services; take-out restaurant services; services for the preparation of food and drink.

(260) AM 2023 117212 A*
 (800) 1651573
 (151) 2021 12 24
 (891) 2021 12 24
 (731) LG Corp.
 128, Yeoui-daero, Yeongdeungpo-gu, Seoul
 07336, Republic of Korea
 (540)



(591) Black, white
 (531) 24.17.02; 26.01.01; 26.01.03; 26.01.18;
 26.01.24; 27.05.09; 27.05.22; 27.05.24
 (511)
 1 – Powdered carbon for secondary cell batteries; plumbago for secondary cell batteries; artificial graphite for secondary cell batteries; natural graphite for secondary cell batteries; active negative polar substances for secondary cell batteries; electrolyte additives for lithium ion batteries; battery electrolytes; chemical compositions for electrodes of lithium ion batteries; anti-frothing solutions for batteries; battery anti-sulphurizing agents; chemical coating agents for industrial purposes; polymer compositions for industrial purposes; chemicals for use in the processing of plastics; polymer resins, unprocessed; chemicals and adhesives used in industry; plastic adhesives for industrial purposes; synthetic resins, unprocessed; artificial resins, unprocessed; polypropylene resins; polyethylene resins; lithium; unprocessed polyester resins; unprocessed polyethylene resins; polymerization plastics; polyethylene terephthalate resins; chemical preparations for leather treatment; surface-active chemical agents; synthetic polyvinyl chloride resins for use in the manufacture of rubber substitute; stiffening agents for industrial purposes; chemicals used in industry and photography; industrial chemicals; adhesi-

ves for industrial purposes; carbon black for industrial purposes; phenol for industrial purposes; industrial bleaching products; chemicals used in industry and unprocessed artificial resins; methyl benzene; chemical preparations for the treatment of water; unprocessed acrylonitrile butadiene styrene resins; unprocessed artificial and synthetic resins; unprocessed ultra absorbent polymer compositions; unprocessed plastics; synthetic polyvinyl chloride resins for use in the manufacture of rubber substitute; chemicals used in industry/science and photography; polyvinyl chloride resins for use in the manufacture of rubber substitute; adhesives for wallpaper and for applying floor tiles; antifreeze; butadiene; polymethyl methacrylate resins for use in the manufacture of aeroplanes, automobiles and textiles; polyester resins for use in the manufacture of textiles; ethylene; stem cells for research or scientific purposes; polyethylene terephthalate resins for manufacturing dyestuffs; artificial sweeteners [chemical preparations]; compounds of plastic for industrial purposes for use in the manufacture of automobiles and mobile devices; mold-release compounds of plastic for industrial purposes for the manufacture of automobiles and cellular phones; synthetic polyethylene resins for the manufacture of electric insulators; polybutylene terephthalate resins for the manufacture of electric insulators, paper coating preparations and prostheses; synthetic polystyrene resins for the manufacture of electronic apparatus parts; synthetic acrylate resin for the manufacture of electronic apparatus parts; epoxy resins for the manufacture of adhesives and dyestuffs; polyethylene resins for the manufacture of kitchen utensils, packaging materials and electric insulators; toluene; compositions for the manufacture of technical ceramics; chemical pulp for the manufacture of packaging materials; propylene (propene); casein resins for the manufacture of plastic injection product, adhesives and paints.

(260) AM 2023 117373 A*
 (800) 1653864
 (151) 2021 12 24
 (891) 2021 12 24
 (731) LG Corp.
 128, Yeoui-daero, Yeongdeungpo-gu, Seoul
 07336, Republic of Korea
 (540)



(591) Black, white
 (531) 24.17.02; 26.01.01; 26.01.03; 26.01.18;
 26.01.24; 27.05.09; 27.05.22; 27.05.24
 (511)
 1 – Powdered carbon for secondary cell batteries; plumbago for secondary cell batteries; artificial graphite for secondary cell batteries; natural graphite for secondary cell batteries; active negative polar substances for secondary cell batteries; electrolyte additives

for lithium ion batteries; battery electrolytes; chemical compositions for electrodes of lithium ion batteries; anti-frothing solutions for batteries; battery anti-sulphurizing agents; chemical coating agents for industrial purposes; polymer compositions for industrial purposes; chemicals for use in the processing of plastics; polymer resins, unprocessed; chemicals and adhesives used in industry; plastic adhesives for industrial purposes; synthetic resins, unprocessed; artificial resins, unprocessed; polypropylene resins; polyethylene resins; lithium; unprocessed polyester resins; unprocessed polyethylene resins; polymerization plastics; polyethylene terephthalate resins; chemical preparations for leather treatment; surface-active chemical agents; synthetic polyvinyl chloride resins for use in the manufacture of rubber substitute; stiffening agents for industrial purposes; chemicals used in industry and photography; industrial chemicals; adhesives for industrial purposes; carbon black for industrial purposes; phenol for industrial purposes; industrial bleaching products; chemicals used in industry and unprocessed artificial resins; methyl benzene; chemical preparations for the treatment of water; unprocessed acrylonitrile butadiene styrene resins; unprocessed artificial and synthetic resins; unprocessed ultra absorbent polymer compositions; unprocessed plastics; synthetic polyvinyl chloride resins for use in the manufacture of rubber substitute; chemicals used in industry/science and photography; polyvinyl chloride resins for use in the manufacture of rubber substitute; adhesives for wall-paper and for applying floor tiles; antifreeze; butadiene; polymethyl metacrylate resins for use in the manufacture of aeroplanes, automobiles and textiles; polyester resins for use in the manufacture of textiles; ethylene; stem cells for research or scientific purposes; polyethylene terephthalate resins for manufacturing dyestuffs; artificial sweeteners [chemical preparations]; compounds of plastic for industrial purposes for use in the manufacture of automobiles and mobile devices; mold-release compounds of plastic for industrial purposes for the manufacture of automobiles and cellular phones; synthetic polyethylene resins for the manufacture of electric insulators; polybutylene terephthalate resins for the manufacture of electric insulators, paper coating preparations and prostheses; synthetic polystyrene resins for the manufacture of electronic apparatus parts; synthetic acrylate resin for the manufacture of electronic apparatus parts; epoxy resins for the manufacture of adhesives and dyestuffs; polyethylene resins for the manufacture of kitchen utensils, packaging materials and electric insulators; toluene; compositions for the manufacture of technical ceramics; chemical pulp for the manufacture of packaging materials; propylene (propene); casein resins for the manufacture of plastic injection product, adhesives and paints.

(260) AM 2023 118359 A
 (800) 1364703
 (151) 2017 04 06
 (891) 2022 05 16
 (731) ASSA Abloy AB
 P.O Box 70340, SE-107 23 Stockholm, Sweden
 (540)



(591) Yellow and black
 (531) 26.01.03; 26.01.20; 29.01.12
 (511)

6 – Metal hardware; architectural hardware made of common metal and alloys thereof; small items of metal hardware; builder's hardware; screen and door hardware; fittings and mountings for doors and windows as well as other door and window hardware; locks; lock cylinders; locksets; lock cases; lock bodies; lock mechanisms; push button locks; bicycle locks; locks of metal for vehicles; cabinet locks; checklocks; combination locks; cylinder locks; door locks; drawer locks; hookbolt locks; furniture locks; mortise locks; multi-point locks; nightlatch locks; rim locks; gate locks; patio door locks; sash locks; screw locks; spring locks; stay locks; swingbolt locks; utility locks; window locks; lockable window handles; bolts; deadbolts; door bolts; hinge bolts; panic bolts; patio bolts; stay bolts; window bolts; metal escutcheon plates for locks; handlesets; lock hasps; lock cover plates; striking plates; hinges; deadlocks; padlocks; armored padlocks; metal push plates; latches; latch retainers; keys; key blanks; safes; door chains; security chains; security stays; springs; door springs; wind breaks; drawer pulls; tumbler cylinders; master key systems; door bells; door cases; frames of metal for building; door frames; door knockers; metal door closers, non-electric; door openers; emergency and panic devices for doors and windows; door holders; door panels; door scrapers; door stops; doors; windows; door viewers; letterboxes; metal pins for lock cylinders; door rebate sets; door knobs and handles of metal; parts and fittings included in this class for all the aforesaid goods; all the aforesaid goods being of metal or predominantly of metal.

9 – CCTV systems; zoom cam cameras (cameras with built-in zoom), CCTV cameras, CCTV camera lenses, video switching systems for CCTV, CCTV camera-controlled apparatus, CCTV apparatus, devices and instruments; tracking apparatus, devices and instruments in particular for vehicles; apparatus for recording, transmission or reproduction of sound and images, apparatus for transmission of communications;

cameras containing a linear image sensor, car video recorders, combination video players and recorders, digital cameras, digital video recorders, digital video cameras, wireless cameras, wired cameras, Internet protocol (IP) cameras, network video recorders (NVR), flash (memory) card readers, flash memory cards, infrared cameras, motion picture cameras, mounting devices for cameras and monitors; multiplexers, programmable digital television recorders, recording and playing devices for sound and image carriers; time and date stamping machines; digital door viewers; video intercom systems; electric and electronic apparatus, namely, electrified and electronic control systems, electrified and electronic control apparatus, electrified and electronic locking systems, electrified and electronic entry systems and electronic components; electric and electronic security or alarm apparatus; electric and electromechanical door and window hardware; electric, electronic and electromechanical locks and lock goods; electrical control apparatus for doors; electronic or magnetic access control cards and smart cards; electronic or magnetic access control card readers and smart card readers; keycards; keycard readers; keyboard actuated electric or magnetic locks; electronically controlled locks; key operated controls; electronic keys; infra red keys; electrical and electronic locking devices; alarms (not for vehicles); alarm locks; electric and electronic door bells; push button electric and electronic locks; computer control apparatus for coding keyboards, decoders, transformers, electronic key pads, power supplies, sirens, electric door strikes, infra red and magnetic contact detectors; cabling; batteries, rechargeable batteries; electronic lock cylinders; electric striking plates; door magnets; electronic and magnetic sensors; apparatus and instruments for signaling and checking, namely checking and/or controlling people's movement within, entrance to and exit from buildings and through doors and gates and/or for use with locks; magnetic and electronic identity cards; magnetic data carriers and computer software; parts and fittings included in this class for all the aforesaid goods.

(260) AM 2023 118416 A
 (800) 1669937
 (151) 2022 04 13
 (891) 2022 04 13
 (731) Mey Alkollü İçkiler Sanayii Ve Ticaret Anonim Şirketi
 Esentepe Mah. Bahar Sk. Özdilek, 13 25 Şişli, İstanbul, Türkiye

(540)



(591) Blue, red, grey, white
 (531) 03.09.01; 05.07.10; 05.07.21; 05.07.22;
 16.01.13; 20.01.03; 20.05.05; 22.01.21;
 24.01.15; 24.17.12; 25.01.15; 27.05.22;
 29.01.13
 (511)
 33 – Rakis, Protected Geographical Indication (PGI).

(260) AM 2023 118796 A
 (800) 1674940
 (151) 2022 06 02
 (891) 2022 06 02
 (731) Ulkar Kimya Sanayii Ve Ticaret Anonim Şirketi
 Saray Mah., Dr. Adnan Büyükdeniz
 Cad. No: 14, Ümraniye/ İstanbul, Türkiye

(540)

TYLOL HOT

(591) Black, white
 (511)
 5 – Sanitary preparations for personal hygiene, other than toiletries; deodorants, other than for human beings or for animals; medicated shampoos, soaps, lotions and dentifrices; dietary supplements intended to supplement a normal diet or to have health benefits; meal replacements and dietetic food and beverages adapted for medical or veterinary use; antibiotics; drugs for medical purposes; biological preparations for medical purposes; biological preparations for veterinary purposes; capsules for medicines; chemical preparations for medical purposes; chemical preparations for pharmaceutical purposes; medicines for human purposes; medicines for veterinary purposes; pharmaceutical preparations; vitamin preparations; vitamin supplement patches.

(260) AM 2023 118908 A
 (800) 826827
 (151) 2004 03 30
 (891) 2022 06 02
 (731) Ulkar Kimya Sanayii Ve Ticaret Anonim Şirketi
 Saray Mah., Dr. Adnan Büyükdeniz
 Cad. No: 14, Ümraniye/ İstanbul, Türkiye

(540)

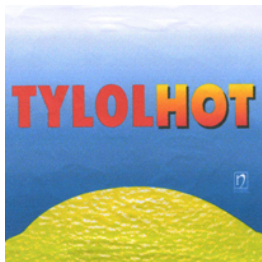

(591) Blue, yellow, brown, light brown
 (531) 05.07.12; 05.07.22; 27.05.01; 29.01.14
 (511)
 5 – Pharmaceuticals.

(260) AM 2023 119661 A
 (800) 1687107
 (151) 2022 08 22
 (891) 2022 08 22
 (731) Claris International Inc.
 One Apple Park Way, Cupertino
 CA 95014, USA

(540)

CLARIS STUDIO

(591) Black, white
 (511)
 42 – Providing software as a service for creating web-forms and sharing web forms with others; providing software as a service for application development, application deployment, application management, and database management; providing software as a service for application development; providing a platform as a service with software development tools for storing, managing, and sharing electronic data and information.

(260) AM 2023 119669 A
 (800) 1279243
 (151) 2015 05 22
 (891) 2022 08 28
 (731) Mercury Distribution Limited
 P. O. Box 583, Stoney Grove, Charlestown,
 Nevis, West Indies, Saint Kitts and Nevis

(540)



(591) Amaranth
 (531) 27.05.01; 29.01.01
 (511)
 14 – Precious metals and their alloys and goods made of these materials or coated therewith not included in other classes; jewelry and caskets for jewelry trade; jewelry products; precious stones; timepieces and chronometric instruments; watch straps; watch chains; presentation cases for timepieces; paste jewelry; charms; amulets [jewelry]; key rings [trinkets or fobs]; ornaments [jewelry]; jewelry cases [caskets or

boxes]; boxes of precious metal; works of art of precious metal; jewelry caskets (cases), not made of precious metals.

20 – Picture frames; containers, not of metal, for liquid fuel; bamboo; bamboo curtains; pulleys of plastics for blinds; cork plugs; casks of wood for decanting wine; casks, not of metal; busts of wood, wax, plaster or plastic; costume stands; bolsters; fans (non-electric); hooks, not of metal, for clothes rails; shoulder poles [yokes]; coat hangers; hat stands; display stands; newspaper display stands; wax figures; signboards of wood or plastic; curtain holders not of textile materials; packaging containers made of plastic; planters; curtain tie-backs; valves, not of metal, other than parts of machines; cable clips, not of metal; locks, not of metal, for vehicles; locks (non-electric), not made of metal; bead curtains for decoration; bottle closures not of metal; caps for bottles, not made of glass, of metal nor of rubber; closures not of metal for containers; latches, not of metal; mirrors; coral; meerschäum; unworked or semi-worked whalebone; stag antlers; shells; animal horns; rattan; unworked or semi-worked ivory; screens for fireplaces [furniture]; reeds (plaiting materials); curtain rods; reels of wood for yarn, silk, cord; plastic key cards (non-encoded); brush mountings; wind chimes (decoration); curtain rings; containers, not made of metal (storage, transport); floating containers, not of metal; hampers (baskets); bakers' bread baskets; wood racks for bottles; coat hooks not made of metal; non-metal hooks for clothes rails; curtain hooks; clothes hooks not of metal; cases not of metal; chests (furniture) not made of metal; dressmaker dummies; mannequins; tailor dummies; wind chimes (decoration); inflatable publicity objects; house numbers, not made of metal nor luminous; tortoiseshell; mother-of-pearl (rough or semi-worked); mirror tiles; number plates, not of metal; identity plates not of metal; wickerwork; plaited straw (except matting); magazine racks, flower-pot pedestals; trestles (furniture); drum stands, not made of metal; pillows; air cushions, not for medical uses; removable mats for sinks; wood ribbons; straw edgings; silvered glass (mirrors); bedding (except linen); corks for bottles; corks; bungs, not of metal; fixed dispensers, not made of metal, for towels; moldings for picture frames; tanks not of metal nor masonry; tool handles, not of metal; corozo; sleeping bags for camping; statuettes of wood, wax, plaster or plastic; figurines made of wood, wax, gypsum or plastic; statues of wood, wax, plaster or plastic materials; oyster shells; pegs [pins], not of metal; pins not made of metal; counters (tables); umbrella stands; gun racks; placards of wood or plastics; boxes made of wood; troughs, not of metal, for mixing mortar; straw plaits; straw mattresses; decorations of plastic for foodstuffs; wall plaques made of plastic or wood; bottle caps not of metal; stoppers, not of metal; door fittings not of metal; picture rods [frames]; window fittings, not of metal; art objects of wood, wax, plaster or plastic; cabinet

parts; covers for clothing (wardrobes); garment covers (storage); poles, not of metal; slatted indoor blinds; ambroid plates; ambroid bars; yellow amber; fodder racks; cases of wood or plastic; boxes of wood or plastic; wood or plastic racks; toy chests; chests (furniture), not made of metal; bottle racks.

(260) AM 2023 119708 A
 (800) 1687235
 (151) 2022 05 11
 (891) 2022 05 11
 (731) Egis Gyógyszergyár Zrt.
 Keresztúri út 30-38., H-1106 Budapest,
 Hungary

(540)

AFISUAL

(591) Black, white
 (511)
 5 – Pharmaceutical preparations for human use; dietic substances adapted for medical use; dietary supplements.

(260) AM 2023 119709 A
 (800) 1687240
 (151) 2022 08 31
 (891) 2022 08 31
 (731) Powin LLC
 20550 SW 115th Ave., Tualatin OR 97062,
 USA

(540)

POWIN

(591) Black, white
 (511)
 9 – Energy storage systems comprised of electrical storage batteries for commercial, residential and vehicle-power charging station purposes, including automobile power-charging stations.
 11 – Lighting fixtures.
 42 – Engineering services; electrical systems design services; design and integration of battery systems.

(260) AM 2023 119711 A
 (800) 1687251
 (151) 2022 05 11
 (891) 2022 05 11
 (731) Egis Gyógyszergyár Zrt.
 Keresztúri út 30-38., H-1106 Budapest,
 Hungary

(540)

VISIFLIB

(591) Black, white

(511)
 5 – Pharmaceutical preparations for human use; dietic substances adapted for medical use; dietary supplements.

(260) AM 2023 119712 A
 (800) 1687252
 (151) 2022 05 11
 (891) 2022 05 11
 (731) Egis Gyógyszergyár Zrt.
 Keresztúri út 30-38., H-1106 Budapest,
 Hungary

(540)

AFLEB

(591) Black, white
 (511)
 5 – Pharmaceutical preparations for human use; dietic substances adapted for medical use; dietary supplements.

(260) AM 2023 119713 A
 (800) 1687254
 (151) 2022 05 11
 (891) 2022 05 11
 (731) Egis Gyógyszergyár Zrt.
 Keresztúri út 30-38., H-1106 Budapest,
 Hungary

(540)

LARNEX

(591) Black, white
 (511)
 5 – Pharmaceutical preparations for human use; dietic substances adapted for medical use; dietary supplements.

(260) AM 2023 119714 A
 (800) 1687255
 (151) 2022 06 02
 (891) 2022 06 02
 (731) Euro Games Technology Ltd.
 4, "Maritsa" Str., "Vranya-Lozen-
 Triugulnika", BG-1151 Sofia, Bulgaria

(540)

Shining Diamond

(591) Black, white
 (511)
 9 – Software; computer gaming software; computer software packages; computer operating system software; computer software, recorded; software drivers; virtual reality software; games software; entertainment software for computer games; computer programs for network management; operating computer software for main frame computers; monitors (compu-

ter hardware); computer hardware; apparatus for recording images; monitors (computer programs); computer game programs; computer programs for recorded games; apparatus for recording, transmission or reproduction of sound or images; communications servers [computer hardware]; electronic components for gambling machines; computer application software featuring games and gaming; computer software for the administration of on-line games and gaming; computer hardware for games and gaming; hardware and software for gambling, gambling machines, gambling games on the Internet and via telecommunication network.

28 – Gaming machines for gambling; chips for gambling; mah-jong; arcade games; gambling machines operating with coins, notes and cards; games; electronic games; parlor games; gaming chips; gaming tables; slot machines [gaming machines]; LCD game machines; slot machines and gaming devices; coin-operated amusement machines; roulette chips; poker chips; chips and dice [gaming equipment]; gaming equipment for casinos; roulette tables; gaming roulette wheels; casino games; gambling machines and amusement machines, automatic and coin-operated; coin-operated amusement machines and/or electronic coin-operated amusement machines with or without the possibility of gain; boxes for coin-operated machines, slot machines and gaming machines; electronic or electrotechnical amusement machines and apparatus, gaming machines, coin-operated entertainment machines; housings for coin-operated machines, gaming equipment, gaming machines, machines for gambling; electropneumatic and electrical gambling machines (slot machines).

41– Gambling; entertainment services related to gambling; gaming services for entertainment purposes; casino, gaming and gambling services; training in the development of software systems; provision of gaming equipment for gambling halls; providing casino equipment [gambling]; gaming machine entertainment services; providing casino facilities [gambling]; gaming hall services; amusement arcade services; games equipment rental; rental of gaming machines; providing amusement arcade services; rental of gaming machines with images of fruits; editing or recording of sounds and images; sound recording and video entertainment services; hire of sound reproducing apparatus; provision of gaming equipment for casinos; providing of casino facilities; online gambling services; casino, gaming and gambling services; provision of gaming facilities, gaming hall facilities, Internet casinos and online gambling services.

(260) AM 2023 119715 A
 (800) 1687256
 (151) 2022 06 02
 (891) 2022 06 02

(731) Euro Games Technology Ltd.
 4, "Maritsa" Str., "Vranya-Lozen-
 Triugulnika", BG-1151 Sofia, Bulgaria

(540)

Valhalla Thunderstorm

(591) Black, white

(511)

9 – Software; computer gaming software; computer software packages; computer operating system software; computer software, recorded; software drivers; virtual reality software; games software; entertainment software for computer games; computer programs for network management; operating computer software for main frame computers; monitors (computer hardware); computer hardware; apparatus for recording images; monitors (computer programs); computer game programs; computer programs for recorded games; apparatus for recording, transmission or reproduction of sound or images; communications servers [computer hardware]; electronic components for gambling machines; computer application software featuring games and gaming; computer software for the administration of on-line games and gaming; computer hardware for games and gaming; hardware and software for gambling, gambling machines, gambling games on the Internet and via telecommunication network.

28 – Gaming machines for gambling; chips for gambling; mah-jong; arcade games; gambling machines operating with coins, notes and cards; games; electronic games; parlor games; gaming chips; gaming tables; slot machines [gaming machines]; LCD game machines; slot machines and gaming devices; coin-operated amusement machines; roulette chips; poker chips; chips and dice [gaming equipment]; gaming equipment for casinos; roulette tables; gaming roulette wheels; casino games; gambling machines and amusement machines, automatic and coin-operated; coin-operated amusement machines and/or electronic coin-operated amusement machines with or without the possibility of gain; boxes for coin-operated machines, slot machines and gaming machines; electronic or electrotechnical amusement machines and apparatus, gaming machines, coin-operated entertainment machines; housings for coin-operated machines, gaming equipment, gaming machines, machines for gambling; electropneumatic and electrical gambling machines (slot machines).

41– Gambling; entertainment services related to gambling; gaming services for entertainment purposes; casino, gaming and gambling services; training in the development of software systems; provision of gaming equipment for gambling halls; providing casino equipment [gambling]; gaming machine entertainment services; providing casino facilities [gambling]; gaming hall services; amusement arcade services; games equipment rental; rental of gaming machines; provi-

ding amusement arcade services; rental of gaming machines with images of fruits; editing or recording of sounds and images; sound recording and video entertainment services; hire of sound reproducing apparatus; provision of gaming equipment for casinos; providing of casino facilities; online gambling services; casino, gaming and gambling services; provision of gaming facilities, gaming hall facilities, Internet casinos and online gambling services.

(260) AM 2023 119716 A

(800) 1687257

(151) 2022 06 08

(891) 2022 06 08

(731) Euro Games Technology Ltd.

4, "Maritsa" Str., "Vranya-Lozen-Triugulnika", BG-1151 Sofia, Bulgaria

(540)

Fury Cash

(591) Black, white

(511)

9 – Software; computer gaming software; computer software packages; computer operating system software; computer software, recorded; software drivers; virtual reality software; games software; entertainment software for computer games; computer programs for network management; operating computer software for main frame computers; monitors (computer hardware); computer hardware; apparatus for recording images; monitors (computer programs); computer game programs; computer programs for recorded games; apparatus for recording, transmission or reproduction of sound or images; communications servers [computer hardware]; electronic components for gambling machines; computer application software featuring games and gaming; computer software for the administration of on-line games and gaming; computer hardware for games and gaming; hardware and software for gambling, gambling machines, gambling games on the Internet and via telecommunication network.

28 – Gaming machines for gambling; chips for gambling; mah-jong; arcade games; gambling machines operating with coins, notes and cards; games; electronic games; parlor games; gaming chips; gaming tables; slot machines [gaming machines]; LCD game machines; slot machines and gaming devices; coin-operated amusement machines; roulette chips; poker chips; chips and dice [gaming equipment]; gaming equipment for casinos; roulette tables; gaming roulette wheels; casino games; gambling machines and amusement machines, automatic and coin-operated; coin-operated amusement machines and/or electronic coin-operated amusement machines with or without the possibility of gain; boxes for coin-operated machines, slot machines and gaming machines; electronic or electrotechnical amusement machines and apparatus,

gaming machines, coin-operated entertainment machines; housings for coin-operated machines, gaming equipment, gaming machines, machines for gambling; electropneumatic and electrical gambling machines (slot machines).

41– Gambling; entertainment services related to gambling; gaming services for entertainment purposes; casino, gaming and gambling services; training in the development of software systems; provision of gaming equipment for gambling halls; providing casino equipment [gambling]; gaming machine entertainment services; providing casino facilities [gambling]; gaming hall services; amusement arcade services; games equipment rental; rental of gaming machines; providing amusement arcade services; rental of gaming machines with images of fruits; editing or recording of sounds and images; sound recording and video entertainment services; hire of sound reproducing apparatus; provision of gaming equipment for casinos; providing of casino facilities; online gambling services; casino, gaming and gambling services; provision of gaming facilities, gaming hall facilities, Internet casinos and online gambling services.

(260) AM 2023 119717 A

(800) 1687258

(151) 2022 06 08

(891) 2022 06 08

(731) Euro Games Technology Ltd.

4, "Maritsa" Str., "Vranya-Lozen-Triugulnika", BG-1151 Sofia, Bulgaria

(540)

9 Burning Bonanza

(591) Black, white

(511)

9 – Software; computer gaming software; computer software packages; computer operating system software; computer software, recorded; software drivers; virtual reality software; games software; entertainment software for computer games; computer programs for network management; operating computer software for main frame computers; monitors (computer hardware); computer hardware; apparatus for recording images; monitors (computer programs); computer game programs; computer programs for recorded games; apparatus for recording, transmission or reproduction of sound or images; communications servers [computer hardware]; electronic components for gambling machines; computer application software featuring games and gaming; computer software for the administration of on-line games and gaming; computer hardware for games and gaming; hardware and software for gambling, gambling machines, gambling games on the Internet and via telecommunication network.

28 – Gaming machines for gambling; chips for gam-

bling; mah-jong; arcade games; gambling machines operating with coins, notes and cards; games; electronic games; parlor games; gaming chips; gaming tables; slot machines [gaming machines]; LCD game machines; slot machines and gaming devices; coin-operated amusement machines; roulette chips; poker chips; chips and dice [gaming equipment]; gaming equipment for casinos; roulette tables; gaming roulette wheels; casino games; gambling machines and amusement machines, automatic and coin-operated; coin-operated amusement machines and/or electronic coin-operated amusement machines with or without the possibility of gain; boxes for coin-operated machines, slot machines and gaming machines; electronic or electrotechnical amusement machines and apparatus, gaming machines, coin-operated entertainment machines; housings for coin-operated machines, gaming equipment, gaming machines, machines for gambling; electropneumatic and electrical gambling machines (slot machines).

41– Gambling; entertainment services related to gambling; gaming services for entertainment purposes; casino, gaming and gambling services; training in the development of software systems; provision of gaming equipment for gambling halls; providing casino equipment [gambling]; gaming machine entertainment services; providing casino facilities [gambling]; gaming hall services; amusement arcade services; games equipment rental; rental of gaming machines; providing amusement arcade services; rental of gaming machines with images of fruits; editing or recording of sounds and images; sound recording and video entertainment services; hire of sound reproducing apparatus; provision of gaming equipment for casinos; providing of casino facilities; online gambling services; casino, gaming and gambling services; provision of gaming facilities, gaming hall facilities, Internet casinos and online gambling services.

(260) AM 2023 119720 A
 (800) 1687410
 (151) 2022 06 08
 (891) 2022 06 08
 (731) Euro Games Technology Ltd.
 4, "Maritsa" Str., "Vranya-Lozen-
 Triugulnika", BG-1151 Sofia, Bulgaria
 (540)

Keep & Spin

(591) Black, white
 (511)
 9 – Software; computer gaming software; computer software packages; computer operating system software; computer software, recorded; software drivers; virtual reality software; games software; entertainment software for computer games; computer programs for network management; operating computer software for main frame computers; monitors (com-

puter hardware); computer hardware; apparatus for recording images; monitors (computer programs); computer game programs; computer programs for recorded games; apparatus for recording, transmission or reproduction of sound or images; communications servers [computer hardware]; electronic components for gambling machines; computer application software featuring games and gaming; computer software for the administration of on-line games and gaming; computer hardware for games and gaming; hardware and software for gambling, gambling machines, gambling games on the Internet and via telecommunication network.

28 – Gaming machines for gambling; chips for gambling; mah-jong; arcade games; gambling machines operating with coins, notes and cards; games; electronic games; parlor games; gaming chips; gaming tables; slot machines [gaming machines]; LCD game machines; slot machines and gaming devices; coin-operated amusement machines; roulette chips; poker chips; chips and dice [gaming equipment]; gaming equipment for casinos; roulette tables; gaming roulette wheels; casino games; gambling machines and amusement machines, automatic and coin-operated; coin-operated amusement machines and/or electronic coin-operated amusement machines with or without the possibility of gain; boxes for coin-operated machines, slot machines and gaming machines; electronic or electrotechnical amusement machines and apparatus, gaming machines, coin-operated entertainment machines; housings for coin-operated machines, gaming equipment, gaming machines, machines for gambling; electropneumatic and electrical gambling machines (slot machines).

41 – Gambling; entertainment services related to gambling; gaming services for entertainment purposes; casino, gaming and gambling services; training in the development of software systems; provision of gaming equipment for gambling halls; providing casino equipment [gambling]; gaming machine entertainment services; providing casino facilities [gambling]; gaming hall services; amusement arcade services; games equipment rental; rental of gaming machines; providing amusement arcade services; rental of gaming machines with images of fruits; editing or recording of sounds and images; sound recording and video entertainment services; hire of sound reproducing apparatus; provision of gaming equipment for casinos; providing of casino facilities; online gambling services; casino, gaming and gambling services; provision of gaming facilities, gaming hall facilities, Internet casinos and online gambling services.

(260) AM 2023 119731 A
 (800) 1687761
 (151) 2022 07 07
 (891) 2022 07 07

(731) Noblewood Limited
Arch. Makariou III, 206, Chrysalia Court,
5TH Floor, CY-3030 Limassol, Cyprus

(540)

CASA DEL LOROS

(591) Black, white

(511)

33 – Aperitifs; arrack; brandy; wine; piquette; whiskey; vodka; anisette [liqueur]; kirsch; gin; digesters [liqueurs and spirits]; cocktails; anise [liqueur]; liqueurs; pre-mixed alcoholic beverages, other than beer-based; alcoholic beverages, except beer; alcoholic beverages containing fruit; spirits [beverages]; distilled beverages; mead (hydromel); peppermint liqueurs; bitters; nira (sugarcane-based alcoholic beverage); rum; sake; perry; cider; rice alcohol; alcoholic extracts; alcoholic fruit extracts; alcoholic essences.

(260) AM 2023 119732 A

(800) 1687764

(151) 2022 08 05

(891) 2022 08 05

(731) Vitabiotics Ltd

1 Apsley Way, London NW2 7HF, United Kingdom

(540)

NEUROMIND

(591) Black, white

(511)

5 – Pharmaceutical preparations, vitamin and mineral preparations, nutrient, herbal and botanical preparations for the brain and cognitive function.

(260) AM 2023 119733 A

(800) 1687813

(151) 2022 07 08

(891) 2022 07 08

(731) Cointreau

Carrefour Molière, F-49124 Saint-Barthelemy-D'anjou, France

(540)

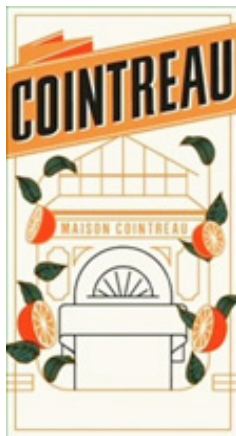

(591) Cream white Pantone 11-0507 CTX, green Pantone 5545 C, orange Pantone 172 C, black Pantone 6 C and copper Pantone 7576 C

(531) 05.03.13; 05.07.11; 05.07.22; 07.01.08; 07.01.24; 25.01.06; 25.01.09; 25.01.10; 25.01.15; 27.05.03; 27.05.09; 29.01.15

(511)

32 – Mineral and carbonated waters and other non-alcoholic beverages, namely carbonated beverages, fruit juices and fruit beverages; syrups and concentrates for making carbonated beverages, non-carbonated beverages, fruit drinks and non-alcoholic cocktails based on fruit juices and fruit drinks.

33 – Alcoholic beverages except beers, namely, wines, gin, vodka, whisky, cider, liqueurs, spirits, brandies, alcoholic liqueur-based cocktails, alcoholic wine-based aperitifs, alcoholic liqueur-based aperitifs.

(260) AM 2023 119734 A

(800) 1687864

(151) 2022 02 23

(891) 2022 02 23

(731) PSA Automobiles SA

2-10 boulevard de l'Europe, F-78300 Poissy, France

(540)

SUSTAINERA

(591) Black, white

(511)

1 – Chemical products for use in industry, science, photography, agriculture, horticulture and forestry; soil fertilizers (natural and artificial); fire-extinguishing compositions; chemical preparations for tempering and welding; chemical substances for preserving foodstuffs; tanning materials; adhesive substances for industrial use; anti-freeze solution; fluids for hydraulic installations and apparatus.

2 – Paints, varnishes, lacquers; preservatives against rust and against deterioration of wood; anti-corrosive solutions; dyestuffs; mordants; Unprocessed natural resins; metals in foil and powder form for painters and decorators.

3 – Laundry preparations, bleaching preparations and other substances for laundry use; cleaning, polishing, degreasing and abrasive preparations; polishing wax; pastes and liquid preparations for cleaning, polishing and protecting painted, varnished and polished metal surfaces; soaps; perfumery, essential oils, cosmetics, hair lotions; dentifrices.

4 – Industrial oils and greases (other than edible oils and fats and essential oils); lubricants; dust binding compositions; fuels (including motor spirit) and lighting fuel; tapers, candles, nightlights and wicks for lighting.

7 – Machines and machine tools; connecting rods for

internal combustion engines, motors and engines (except for land vehicles), couplings and transmission belts (except for land vehicles); agricultural implements other than hand-operated; incubators for eggs; hand-held tools and implements other than hand-operated; crank shafts, bearings and jacks for automobiles; air filters and oil purifiers for internal combustion engines.

8 – Cutlery, forks and spoons; side arms, other than firearms.

9 – Scientific, nautical, surveying, electric (including wireless), photographic, cinematographic, optical, weighing, measuring, signaling, checking (supervision), life-saving and teaching apparatus and instruments; fuel level indicators and oil level indicators; radio receiving apparatus and bodies thereof, batteries for accumulators, insulated wires and cables, electric ignition apparatus and bodies thereof, switches, horns and electric warning apparatus and bodies thereof; automatic coin or token-operated apparatus; talking machines; cash registers, calculating machines; extinguishing apparatus.

11 – Installations for lighting, heating, steam generating, cooking, refrigerating, drying, ventilating, water distribution and sanitary installations; electric lamps, water heaters and their parts, particularly heat exchangers, fans, blowers, distributors and regulators with manual control; electric fans.

12 – Vehicles, apparatus for locomotion by land, motor vehicles, component parts thereof, namely suspension shock absorbers for vehicles; shock absorbers (springs) for vehicles; motors and engines for land vehicles; gear boxes for land vehicles; vehicle chassis; vehicle bodies; transmission shafts for land vehicles; hydraulic circuits for vehicles; torque converters for land vehicles; clutches for land vehicles; axles; vehicle brakes; vehicle wheels; vehicle wheel rims; hub caps for wheels; hubs for vehicle wheels; tires; steering wheels for vehicles; vehicle seats; headrests for vehicle seats; security devices for vehicles such as safety belts and air bags; rearview mirrors; windshield wipers; torsion bars for vehicles; vehicle bumpers; protective molding rods for vehicles; deflectors for vehicles; spoilers for vehicles; windshields; retractable roofs for vehicles; windows for vehicles; caps for vehicle fuel tanks; luggage carriers for vehicles.

17 – Rubber, gutta-percha, gum, asbestos, mica being unprocessed or semi-processed and substitutes of all these materials; plastic materials and resins in extruded form used in manufacturing operations; packing, stopping and insulating materials; flexible pipes not of metal.

24 – Textiles and substitutes thereof; household linen; curtains of textile or plastic materials.

37 – Construction services; installation and repair services; mining, oil and gas drilling.

40 – Treatment of materials; recycling of trash and waste; air purification and water treatment; printing services; food and beverage preservation.

(260) AM 2023 119735 A

(800) 1687892

(151) 2022 05 19

(891) 2022 05 19

(731) Euro Games Technology Ltd.

4, "Maritsa" Str., "Vranya-Lozen-

Triugulnika", BG-1151 Sofia, Bulgaria

(540)

HOT FLY

(591) Black, white

(511)

9 – Software; computer gaming software; computer software packages; computer operating system software; computer software, recorded; software drivers; virtual reality software; games software; entertainment software for computer games; computer programs for network management; operating computer software for main frame computers; monitors (computer hardware); computer hardware; apparatus for recording images; monitors (computer programs); computer game programs; computer programs for recorded games; apparatus for recording, transmission or reproduction of sound or images; communications servers [computer hardware]; electronic components for gambling machines; computer application software featuring games and gaming; computer software for the administration of on-line games and gaming; computer hardware for games and gaming; hardware and software for gambling, gambling machines, gambling games on the Internet and via telecommunication network.

28 – Gaming machines for gambling; chips for gambling; mah-jong; arcade games; gambling machines operating with coins, notes and cards; games; electronic games; parlor games; gaming chips; gaming tables; slot machines [gaming machines]; LCD game machines; slot machines and gaming devices; coin-operated amusement machines; roulette chips; poker chips; chips and dice [gaming equipment]; equipment for casinos; roulette tables; gaming roulette wheels; casino games; automats and gambling machines; coin-operated machines and/or electronic coin-operated machines with or without the possibility of gain; boxes for coin-operated machines, slot machines and gaming machines; electronic or electrotechnical gaming devices, automats and machines, coin-operated machines; housings for coin-operated machines, gaming equipment, gaming machines, machines for gambling; electropneumatic and electrical gambling machines (slot machines).

41 – Gambling; services related to gambling; gaming services for entertainment purposes; casino, gaming

and gambling services; training in the development of software systems; provision of gaming equipment for gambling halls; providing casino equipment [gambling]; gaming machine entertainment services; providing casino facilities [gambling]; halls with gaming machines; amusement arcade services; games equipment rental; rental of gaming machines; providing amusement arcade services; rental of gaming machines with images of fruits; editing or recording of sounds and images; sound recording and video entertainment services; hire of sound reproducing apparatus; provision of gaming equipment for casinos; providing of casino facilities; online gambling services; casino management services; operation of gaming establishments, gaming halls, Internet casinos, online gambling sites.

(260) AM 2023 119736 A
 (800) 1687893
 (151) 2022 05 19
 (891) 2022 05 19
 (731) Euro Games Technology Ltd.
 4, "Maritsa" Str., "Vranya-Lozen-
 Triugulnika", BG-1151 Sofia, Bulgaria
 (540)

Flamy Hit

(591) Black, white
 (511)
 9 – Software; computer gaming software; computer software packages; computer operating system software; computer software, recorded; software drivers; virtual reality software; games software; entertainment software for computer games; computer programs for network management; operating computer software for main frame computers; monitors (computer hardware); computer hardware; apparatus for recording images; monitors (computer programs); computer game programs; computer programs for recorded games; apparatus for recording, transmission or reproduction of sound or images; communications servers [computer hardware]; electronic components for gambling machines; computer application software featuring games and gaming; computer software for the administration of on-line games and gaming; computer hardware for games and gaming; hardware and software for gambling, gambling machines, gambling games on the Internet and via telecommunication network.

28 – Gaming machines for gambling; chips for gambling; mah-jong; arcade games; gambling machines operating with coins, notes and cards; games; electronic games; parlor games; gaming chips; gaming tables; slot machines [gaming machines]; LCD game machines; slot machines and gaming devices; coin-operated amusement machines; roulette chips; poker chips; chips and dice [gaming equipment]; equipment for casinos; roulette tables; gaming roulette wheels;

casino games; automats and gambling machines; coin-operated machines and/or electronic coin-operated machines with or without the possibility of gain; boxes for coin-operated machines, slot machines and gaming machines; electronic or electrotechnical gaming devices, automats and machines, coin-operated machines; housings for coin-operated machines, gaming equipment, gaming machines, machines for gambling; electropneumatic and electrical gambling machines (slot machines).

41 – Gambling; services related to gambling; gaming services for entertainment purposes; casino, gaming and gambling services; training in the development of software systems; provision of gaming equipment for gambling halls; providing casino equipment [gambling]; gaming machine entertainment services; providing casino facilities [gambling]; halls with gaming machines; amusement arcade services; games equipment rental; rental of gaming machines; providing amusement arcade services; rental of gaming machines with images of fruits; editing or recording of sounds and images; sound recording and video entertainment services; hire of sound reproducing apparatus; provision of gaming equipment for casinos; providing of casino facilities; online gambling services; casino management services; operation of gaming establishments, gaming halls, Internet casinos, online gambling sites.

(260) AM 2023 119737 A
 (800) 1687907
 (151) 2021 11 18
 (891) 2021 11 18
 (731) Yonder Technology Ltd
 69 Old St, London EC1V 9HX, United
 Kingdom
 (540)

YONDER

(591) Black, white
 (511)
 35 – Advertising, marketing and promotional services; business management; business administration; business advisory and consultancy services; office functions; loyalty, incentive and bonus program services; market research services; publicity services; online and offline retail and wholesale services in relation to the sale of scientific, research, navigation, surveying, photographic, cinematographic, audiovisual, optical, weighing, measuring, signalling, detecting, testing, inspecting, life-saving and teaching apparatus and instruments, apparatus and instruments for conducting, switching, transforming, accumulating, regulating or controlling the distribution or use of electricity, apparatus and instruments for recording, transmitting, reproducing or processing sound, images or data, recorded and downloadable media, computer software, blank digital or analogue recording and sto-

rage media, computer hardware, computer software, computer programs, mobile apps, computer hardware, computer software, computer programs and mobile apps for facilitating and administering electronic payments, electronic processing and transmission of payment data, cash disbursement, transaction authentication, authenticating user identification, routing, authorization and settlement services, fraud detection and control, and disaster recovery and encryption services, computer hardware, computer software, computer programs and mobile apps for creating encryption keys, digital certificates, and digital signatures, computer hardware, computer software, computer programs and mobile apps for tracking, management and analysis of financial accounts via a global computer network, computer hardware, computer software, computer programs and mobile apps that facilitate the identification and authentication of near field communication (NFC) devices and radio frequency identification (RFID) devices, computer hardware, computer software, computer programs and mobile apps for mobile devices comprising a digital wallet that stores customer account information and permits consumers to access coupons, vouchers, voucher codes and rebates at retailers and to obtain loyalty or monetary rewards that can be credited to their accounts, e-commerce and e-payment software, downloadable electronic publications, telecommunication and electrical apparatus and instruments, telecommunication and electrical apparatus and instruments, namely, apparatus for the recording, transmission and reproduction of data including sound and images, downloadable electronic publications, namely, newsletters, magazines and books in the fields of payments and financial services, printing apparatus for data processing systems and financial transaction systems, encoders and decoders, bank cards, credit and debit cards, magnetic encoded cards and payment cards, cards encoded with security features for authentication and identification purposes, payment card readers, magnetic coded card readers, magnetic encoded cards and cards containing an integrated circuit chip in the nature of banking cards, credit cards, debit cards and smart cards all containing programming used to process payments, electronic data carrier card readers, point-of-sale terminals and downloadable software for making contactless payments, point of sale transaction terminals and computer software for transmitting, displaying and storing transaction, identification and financial information for use in the financial services, banking and telecommunications industries, radio frequency identification devices, namely, transponders, cash dispensing machines, mechanisms for coin-operated apparatus, cash registers, calculating devices, computers and computer peripheral devices, none of the aforesaid services in relation to brand design, brand consulting services and market research; none of the aforesaid services being retail and online retail services of household cleaning products, personal cleaning products,

household appliances, and lighting products; none of the aforesaid services in relation to career advisory services and career counselling; none of the aforesaid relating to software in connection with assisting businesses reaching specific business and product need; none of the aforesaid services being for or in relation to software for robotic applications or in relation to pick and place machines and robotics.

36 – Financial, monetary and banking services; insurance services; financial services, namely, banking; financial services, namely, transaction and payment processing services, payment verification services, payment card transaction authorisation, reconciliation and settlement services; loan and credit, and lease-finance services; finance leasing; electronic funds transfer services; currency exchange services; value exchange services, namely, secure electronic cash transactions over computer networks to facilitate electronic commerce; processing of financial transactions at point of sale and online via a global computer network or via telecommunication, mobile or wireless devices; financial services, namely, check verification, check cashing, deposit access and automated teller machine services; financial services, namely, the provision of contactless mobile payments processing through merchants at retail, online and wholesale locations; financial assessment and risk management services for others in the field of consumer credit; dissemination of financial information via a global computer network; financial analysis and consultation; bill payment services; payment card services; bank card services; credit card services; debit card services; assistance with electronic transfers of money; foreign currency exchange services; issuing bank cards, credit cards, debit cards, and payment cards; consulting services regarding payment solutions, banking, credit cards, debit cards and payment cards; real estate affairs; information, advisory and consultancy services relating to all the aforesaid services; none of the aforesaid services in relation to fund investment.

42 – Scientific and technological services and research and design relating thereto; industrial analysis, industrial research and industrial design services; quality control and authentication services; design, development, maintenance and update of computer hardware, computer software, computer programs and mobile apps; design, development, maintenance and update of computer hardware and application software for mobile devices; consultancy in the design and development of computer hardware; computer software consultancy; computer programming; support and consultation services for managing computer systems, databases and applications; providing temporary use of non-downloadable software and applications for managing, locating, activating and revoking authentication and digital credentials of near field communication (NFC) devices; authentication services, namely, providing user and identity authentication services

using software and hardware technology; computer and Internet related services, namely, providing online electronic databases via a global computer network in the field of identity authentication and verification, payment cards, fraud and risk management, and banking; data encryption and decryption of financial information; digital signature authentication services for authentication of others, namely, data encryption and data integrity; digital certificate verification, authentication, issuance, distribution and management; consulting services in the fields of computer programming, financial computer networks, data processing, secure communications, data encryption and decryption and local area network security; data storage and retrieval services; data repository and client profile information services; information, advisory and consultancy services relating to all the aforesaid services; none of the aforesaid services in relation to brand design, brand consulting services and market research; none of the aforesaid services relating to machine tools, motors and engines; none of the aforesaid services in relation to pick and place machines and robotics; none of the aforesaid services being for or in relation to software for robotic applications.

(260) AM 2023 119739 A
 (800) 1688032
 (151) 2022 08 10
 (891) 2022 08 10
 (731) GAC Aion New Energy Automobile Co., LTD.
 No.36, Longying Road, Panyu District,
 Guangzhou, 511400 Guangdong, China
 (540)

AION

(591) Black, white
 (531) 27.05.01
 (511)
 7 – Vehicle washing installations; machines for battery industry; carburetters; starters for engines; radiators [cooling] for automobile engines; starters for motors and engines; pistons [parts of machines or engines]; shock absorbers for machines; bearings for vehicles; shock absorbers [parts of machines].

12 – Remote control vehicles, other than toys; vehicles for locomotion by land, air, water or rail; cars; automobile bodies; shock absorbers for automobiles; brake pads for automobiles; wheels for automobiles; electric vehicles; driverless cars [autonomous cars]; motor homes; self-driving cars; automobile chassis; gear boxes for land vehicles; clutches for land vehicles; gasoline engines for land vehicles; diesel engines for land vehicles; jet engines for land vehicles; hoods for vehicle engines; steering wheels for vehicles; caps for vehicle fuel tanks; motorcycles; bumpers for automobiles; air bags [safety devices for automobiles];

bodies for vehicles; motors for land vehicles; bicycles; self-balancing scooters; tires for vehicle wheels; air vehicles; water vehicles; head-rests for vehicle seats; safety seats for children, for vehicles; upholstery for vehicles; windscreens.

(260) AM 2023 119744 A
 (800) 1688108
 (151) 2022 09 16
 (891) 2022 09 16
 (731) Bolotov Oleksii Oleksandrovych
 vul. Dvirtseva, 42, kv. 127, m. Kramatorsk,
 Donetska obl. 84301, Ukraine
 (540)

SIKVARULI

(591) Black, white
 (511)
 33 – Alcoholic beverages, except beer; alcoholic preparations for making beverages; alcoholic beverages containing fruit; distilled alcoholic beverages; aperitifs; alcoholic fruit beverages; fruit based alcoholic drinks; brandy; fruit brandy; vermouth; wine; wines; grape wine; table wine; dessert wines; sparkling wines; vintage wines; still wines; sweet wines; aperitifs with a wine base; acanthopanax wine; sparkling alcoholic beverages; fortified wines; mulled wine; table wines; wine punches; vodka; fruit brandies; digestifs [liqueurs and spirits]; cocktails*; cream liqueurs; liqueurs; pre-mixed alcoholic beverages, other than beer-based; bitters; piquette; cider; low alcohol drinks, except beers; spirits [beverages]; distilled beverages.

(260) AM 2023 119746 A
 (800) 1688233
 (151) 2022 03 15
 (891) 2022 03 15
 (731) Far Elektrik Teknolojileri Sanayi Ve Ticaret Anonim Şirketi
 Eyüp Sultan Mah. Müminler CAD. 79,
 Sancaktepe, İstanbul, Türkiye
 (540)



(591) Green and gray.
 (531) 26.13.25; 27.05.01; 27.05.19; 29.01.12
 (526) ®
 (511)
 9 – Measurement apparatus, equipment and digital indicators including those for scientific and laboratory use, laboratory equipment and apparatus; apparatus for recording, transmission or reproduction of sound or images; data processing apparatus, telecommunication apparatus, sound or image reproducing apparatus, computer peripheral devices; magnetic and optic data

carriers and computer software and programmes recorded thereto, downloadable and recordable electronic publications, encoded magnetic and optic cards; antennas, satellite antennas, amplifiers for antennas, parts of the aforementioned goods; ticket dispensers, automatic teller machines (ATM); electronic components used in the electronic parts of machines and apparatus; counters and quantity indicators for measuring the quantity of consumption, automatic time switches; clothing for protection against accidents, irradiation and fire, safety vests and life-saving apparatus and equipment; eyeglasses, sunglasses, optical lenses and cases, containers, parts and components thereof; apparatus and instruments for conducting, transforming, accumulating or controlling electricity; electric cables and electrical power supplies, batteries, electric accumulators; alarms and anti-theft alarms, other than for vehicles, electric bells; signalling apparatus and instruments, luminous or mechanical signs for traffic use; fire extinguishing apparatus, fire engines, fire hose and fire hose nozzles; radar apparatus, sonars, night vision apparatus and instruments; decorative magnets.

(260) AM 2023 119748 A
(800) 1688325
(151) 2022 07 14
(891) 2022 07 14
(731) PET360 S.R.L.
Via Per Formigine, 45/D, I-41051
Castelnuovo Rangone (MO), Italy
(540)



(591) Red, white, ochre, light green and dark green
(531) 25.01.18; 26.11.03; 26.11.13; 27.05.24;
27.07.24; 29.01.14
(511)
31 – Litter for animals; meal for animals; bran mash for animal consumption; grains for animal consumption; beverages for pets; pet food; edible chews for animals; animal fattening preparations; strengthening animal forage; aromatic sand [litter] for pets; sand for pet toilets; dog biscuits; bird food.

(260) AM 2023 119754 A
(800) 1515577
(151) 2020 01 16
(891) 2022 09 15
(731) Claris International Inc.
One Apple Park Way, Cupertino CA 95014,
USA

(540)
CLARIS CONNECT

(591) Black, white
(511)
42 – Platform as a service (PAAS) featuring software for third party application integration and data linking.

(260) AM 2023 119820 A
(800) 1688443
(151) 2022 05 19
(891) 2022 05 19
(731) Euro Games Technology Ltd.
4, "Maritsa" Str., "Vranya-Lozen-Triugulnika",
BG-1151 Sofia, Bulgaria

(540)
HOT WIN

(591) Black, white
(511)
9 – Software; computer gaming software; computer software packages; computer operating system software; computer software, recorded; software drivers; virtual reality software; games software; entertainment software for computer games; computer programs for network management; operating computer software for main frame computers; monitors (computer hardware); computer hardware; apparatus for recording images; monitors (computer programs); computer game programs; computer programs for recorded games; apparatus for recording, transmission or reproduction of sound or images; communications servers [computer hardware]; electronic components for gambling machines; computer application software featuring games and gaming; computer software for the administration of on-line games and gaming; computer hardware for games and gaming; hardware and software for gambling, gambling machines, gambling games on the Internet and via telecommunication network.

28 – Gaming machines for gambling; chips for gambling; mah-jong; arcade games; gambling machines operating with coins, notes and cards; games; electronic games; parlor games; gaming chips; gaming tables; slot machines [gaming machines]; LCD game machines; slot machines and gaming devices; coin-operated amusement machines; roulette chips; poker chips; chips and dice [gaming equipment]; gaming equipment for casinos; roulette tables; gaming roulette wheels; casino games; gambling machines and amusement machines, automatic and coin-operated; coin-

operated amusement machines and/or electronic coin-operated amusement machines with or without the possibility of gain; boxes for coin-operated machines, slot machines and gaming machines; electronic or electrotechnical amusement machines and apparatus, gaming machines, coin-operated entertainment machines; housings for coin-operated machines, gaming equipment, gaming machines, machines for gambling; electropneumatic and electrical gambling machines (slot machines).

41 – Gambling; entertainment services related to gambling; gaming services for entertainment purposes; casino, gaming and gambling services; training in the development of software systems; provision of gaming equipment for gambling halls; providing casino equipment [gambling]; gaming machine entertainment services; providing casino facilities [gambling]; gaming hall services; amusement arcade services; games equipment rental; rental of gaming machines; providing amusement arcade services; rental of gaming machines with images of fruits; editing or recording of sounds and images; sound recording and video entertainment services; hire of sound reproducing apparatus; provision of gaming equipment for casinos; providing of casino facilities; online gambling services; casino, gaming and gambling services; provision of gaming facilities, gaming hall facilities, Internet casinos and online gambling services.

(260) AM 2023 119821 A
 (800) 1688452
 (151) 2022 08 31
 (891) 2022 08 31
 (731) Rigo Trading S.A.
 6, Route de Trèves, EBBC, Building E,
 L-2633 Senningerberg, Luxembourg

(540)



(591) Pink, orange, green and blue
 (531) 01.15.15; 02.09.04; 16.03.17; 27.03.02;
 27.03.15; 27.05.03; 27.05.04; 27.05.17;
 29.01.15
 (511)
 30 – Confectionery.

(260) AM 2023 119822 A
 (800) 1688453
 (151) 2022 08 31
 (891) 2022 08 31
 (731) Rigo Trading S.A.
 6, Route de Trèves, EBBC, Building E,
 L-2633 Senningerberg, Luxembourg

(540)



(591) Blue, yellow, orange, green and red
 (531) 05.01.12; 18.03.10; 27.03.15; 27.05.01;
 27.05.04; 27.05.09; 27.05.17; 29.01.15
 (511)
 30 – Confectionery.

(260) AM 2023 119823 A
 (800) 1688514
 (151) 2022 08 12
 (891) 2022 08 12
 (731) Velinor AG
 c/o Dr. iur. Adrian von Segesser, Kapellplatz 1,
 CH-6004 Luzern, Switzerland

(540)



(591) Yellow
 (531) 26.11.25; 26.13.25; 29.01.02
 (511)
 5 – Pharmaceutical preparations; pharmaceutical preparations for the treatment and prevention of cancer; pharmaceutical preparations and substances for the treatment of neuroblastoma.

(260) AM 2023 119824 A
 (800) 1688591
 (151) 2022 07 12
 (891) 2022 07 12
 (731) LLC "Gexa – Nonwoven Materials"
 Tsentralnaya street, dom 3, litera A, A1, A2,
 a, pomeschenie 304, d. Golievo, RU-143405
 g. Krasnogorsk, Moskovskaya oblast, Russian
 Federation

(540)



(591) Black, white
 (531) 27.05.01; 27.05.17
 (511)
 17 – Shock-absorbing buffers of rubber; fittings, not of metal, for compressed air lines; asbestos; cellulose acetate, semi-processed; balata; floating anti-pollution barriers; asbestos paper; paper for electrical capacitors; insulating paper; cotton wool for packing [caulking]; mineral wool [insulator]; asbestos felt; insulating felt; asbestos fibres; plastic fibres, other than for

textile use; carbon fibres, other than for textile use; vulcanized fibre; gutta-percha; foam supports for flower arrangements [semi-finished products]; dielectrics [insulators]; lute; insulators; insulators for railway tracks; insulators for electric mains; insulators for cables; asbestos millboards; liquid rubber; synthetic rubber; rubber, raw or semi-worked; valves of india-rubber or vulcanized fibre; clack valves of rubber; rings of rubber; water-tight rings; insulating paints; insulating varnish; latex [rubber]; duct tapes; insulating bands; adhesive tapes, other than stationery and not for medical or household purposes; self-adhesive tapes, other than stationery and not for medical or household purposes; asbestos sheets; viscose sheets, other than for wrapping; foil of regenerated cellulose, other than for wrapping; insulating oils; insulating oil for transformers; reinforcing materials, not of metal, for pipes; weatherstripping compositions; caulking materials; brake lining materials, partly processed; soundproofing materials; insulating materials; insulating refractory materials; padding materials of rubber or plastics; rubber material for recapping tyres; non-conducting materials for retaining heat; boiler composition to prevent the radiation of heat; packing [cushioning, stuffing] materials of rubber or plastics; sealant compounds for joints; filtering materials of semi-processed foams of plastic; filtering materials of semi-processed films of plastic; compositions to prevent the radiation of heat; bags [envelopes, pouches] of rubber, for packaging; pipe muffers, not of metal; rubber sleeves for protecting parts of machines; asbestos packing; clutch linings; threads of plastic for soldering; plastic filaments for 3D printing; threads of plastic materials, other than for textile use; threads of rubber, other than for textile use; elastic yarns, other than for textile use; door stops of rubber; window stops of rubber; stops of rubber; dock bumpers of rubber; insulating gloves; plastic substances, semi-processed; plastic sheeting for agricultural purposes; plastic film, other than for wrapping; anti-glare films for windows [tinted films]; asbestos coverings; bark coverings for sound insulation; asbestos cloth; rubber stoppers; expansion joint fillers; cylinder jointings; washers of rubber or vulcanized fibre; pipe gaskets; draught excluder strips; gaskets; rubber solutions; gum, raw or semi-worked; mica, raw or partly processed; acrylic resins, semi-processed; synthetic resins, semi-processed; junctions, not of metal, for pipes; substances for insulating buildings against moisture; chemical compositions for repairing leaks; acrylic glass, semi-processed; organic glass, semi-processed; glass wool for insulation; fibreglass for insulation; asbestos fabrics; fibreglass fabrics for insulation; insulating fabrics; flexible hoses, not of metal; hoses of textile material; connecting hose for vehicle radiators; waterproof packings; rubber seals for jars; fittings, not of metal, for flexible pipes; fittings, not of metal, for rigid pipes; foils of metal for insulating; ebonite moulds; insulating inks; asbestos slate; slag wool [insulator]; wa-

tering hose; canvas hose pipes; cords of rubber; asbestos safety curtains; insulating plaster; ebonite.

19 – Aquaria [structures]; alabaster; door frames, not of metal; asbestos cement; asphalt; beams, not of metal; balustrades, not of metal; huts; swimming pools [structures], not of metal; silos, not of metal; arbours [structures], not of metal; concrete; bitumen; plastic landscape edgings; joists, not of metal; telephone booths, not of metal; beacons, not of metal, non-luminous; building paper; busts of stone, concrete or marble; bird baths [structures], not of metal; binding agents for making briquettes; binding material for road repair; stained-glass windows; felt for building; aviaries [structures], not of metal; gates, not of metal; diving boards, not of metal; geotextiles; gypsum [building material]; plaster; potters' clay; earth for bricks; clay; roofing shingles; gravel; aquarium gravel; granite; tar; armoured doors, not of metal; doors, not of metal; swing doors, not of metal; accordion doors, not of metal; folding doors, not of metal; coal tar; chimney pots, not of metal; prefabricated houses [kits], not of metal; parquet floor boards; floating floor boards, not of metal; memorial plaques, not of metal; wood for making household utensils; veneer wood; mouldable wood; chimney shafts, not of metal; jalousies, not of metal; roof gutters, not of metal; street gutters, not of metal; agglomerated bagasses of cane [building material]; road signs, non-luminous and non-mechanical, not of metal; non-luminous and non-mechanical signs, not of metal; limestone; lime; fences, not of metal; works of stonemasonry; works of art of stone, concrete or marble; cabanas, not of metal; soundproof booths, transportable, not of metal; stone; rubble; artificial stone; building stone; paint spraying booths, not of metal; gravestones; reeds for building; horticultural frames, not of metal; framework, not of metal, for building; greenhouse frames, not of metal; cornices, not of metal; bitumen paper for building; wood pulp board for building; paperboard for building; skating rinks [structures], not of metal; quartz; caissons for construction work under water; bricks; firebricks; water-pipe valves, not of metal or plastic; drain traps [valves], not of metal or plastic; cask wood; mooring bollards, not of metal; cement posts; pillars, not of metal, for building; chimney cowls, not of metal; brackets, not of metal, for building; buildings, not of metal; buildings, transportable, not of metal; stringers [parts of staircases], not of metal; silica [quartz]; roofing, not of metal; roofing, not of metal, incorporating photovoltaic cells; manhole covers, not of metal; xylolith; chicken-houses, not of metal; manufactured timber; sawn timber; building timber; wood, semi-worked; staircases, not of metal; road marking sheets and strips of synthetic material; reinforcing materials, not of metal, for building; bituminous products for building; road coating materials; materials for making and coating roads; fireclay; pitch; building materials, not of metal; refractory construction materials, not of metal; masts [poles], not of metal; raw chalk; calca-

reous marl; mosaics for building; mouldings, not of metal, for building; marble; slate powder; porches [structures], not of metal; tombs, not of metal; flashing, not of metal, for building; roof flashing, not of metal; perches; duckboards, not of metal; wall claddings, not of metal, for building; mouldings, not of metal, for cornices; coatings [building materials]; tomb or grave enclosures, not of metal; grave or tomb enclosures, not of metal; laths, not of metal; wood panelling; wall linings, not of metal, for building; palings, not of metal; crash barriers, not of metal, for roads; latticework, not of metal; windows, not of metal; olivine for building; shuttering, not of metal, for concrete; posts, not of metal, for power lines; props, not of metal; rubber bearings for seismic isolation of buildings; branching pipes, not of metal; fair huts; tombs [monuments], not of metal; monuments, not of metal; acoustic panels, not of metal; wainscotting, not of metal; signalling panels, non-luminous and non-mechanical, not of metal; building panels, not of metal; parquet flooring; partitions, not of metal; lintels, not of metal; casement windows, not of metal; aquarium sand; play sand; silver sand; sand, except foundry sand; sandstone for building; tarred strips for building; planks of wood for building; rocket launching platforms, not of metal; platforms, prefabricated, not of metal; wall tiles, not of metal; floor tiles, not of metal; tiles, not of metal, for building; paving slabs, not of metal; cement slabs; grave slabs, not of metal; tile floorings, not of metal; slabs, not of metal, for building; scaffolding, not of metal; armour-plating, not of metal; asphalt paving; wood paving; paving blocks, not of metal; luminous paving blocks; macadam; fire-proof cement coatings; bituminous coatings for roofing; roof coverings, not of metal; wooden floor boards; cladding, not of metal, for building; linings, not of metal, for building; fireplace mantles, not of metal; door panels, not of metal; floors, not of metal; sills, not of metal; porphyry [stone]; ceilings, not of metal; floating docks, not of metal, for mooring boats; agglomerated cork for building; window frames, not of metal; mortar for building; asbestos mortar; tanks of masonry; scantlings [carpentry]; furrings of wood; vinyl siding; pilings, not of metal; pigsties, not of metal; insect screens, not of metal; burial vaults, not of metal; schists; outdoor blinds, not of metal and not of textile; shutters, not of metal; statues of stone, concrete or marble; statuettes of stone, concrete or marble; alabaster glass; safety glass; glass granules for road marking; window glass for building; window glass, other than vehicle window glass; building glass; plate glass [windows] for building; insulating glass for building; enamelled glass, for building; tombstone stelae, not of metal; stables, not of metal; advertisement columns, not of metal; posts, not of metal; telegraph posts, not of metal; hips for roofing; stair-treads [steps], not of metal; tombstone plaques, not of metal; greenhouses, transportable, not of metal; terra-cotta [building material]; penstock pipes, not of metal; wa-

ter-pipes, not of metal; gutter pipes, not of metal; ducts, not of metal, for ventilating and air-conditioning installations; drain pipes, not of metal; chimneys, not of metal; rigid pipes, not of metal, for building; sandstone pipes; turnstiles, not of metal; tufa; angle irons, not of metal; lengthening pieces, not of metal, for chimneys; bicycle parking installations, not of metal; plywood; figurines of stone, concrete or marble; flagpoles [structures], not of metal; foundry moulds, not of metal; rock crystal; cement for blast furnaces; cement for furnaces; magnesia cement; cement; pantiles, not of metal; roofing tiles, not of metal; slate; roofing slates; slag [building material]; slag stone; railway sleepers, not of metal; wood veneers; clinker ballast; concrete building elements; letter boxes of masonry.

24 – Frieze [cloth]; banners of textile or plastic; velvet; household linen; diapered linen; bath linen, except clothing; bed linen; table linen, not of paper; sew-on tags of textile for clothing; adhesive tags of textile for bags; cot bumpers [bed linen]; buckram; fustian; sleeping bag liners; felt; bunting of textile or plastic; gauze [cloth]; damask; jersey [fabric]; table runners, not of paper; drugget; shower curtains of textile or plastic; curtains of textile or plastic; net curtains; zephyr [cloth]; canvas for tapestry or embroidery; dimity; bolting cloth; mats of textile for beer glasses; baby buntings; crepe [fabric]; crepon; marabouts [cloth]; furniture coverings of textile; fabrics for textile use; filtering materials of textile; wall hangings of textile; non-woven textile fabrics; plastic material [substitute for fabrics]; textile material; tablemats of textile; bivouac sacks being covers for sleeping bags; sleeping bags; sleeping bags for babies; moleskin [fabric]; muslin fabric; pillowcases; mattress covers; bed blankets; blankets for household pets; brocades; diaper changing cloths for babies; handkerchiefs of textile; picnic blankets; travelling rugs [lap robes]; coasters of textile; bed valances; linings [textile]; hat linings, of textile, in the piece; curtain holders of textile material; bed covers; bed covers of paper; furniture coverings of plastic; face towels of textile; dish towels; towels of textile; tea towels; hemp cloth; gummed cloth, other than for stationery purposes; printers' blankets of textile; cloth; door curtains; bedsheets; eiderdowns [down coverlets]; bath mitts; shrouds; glass cloths [towels]; cloths for removing make-up; place mats of textile; table napkins of textile; mosquito nets; calico; oilcloth for use as tablecloths; tablecloths, not of paper; billiard cloth; taffeta [cloth]; ticks [mattress covers]; tick [linen]; lingerie fabric; fabric, impervious to gases, for aeronautical balloons; jute fabric; fabric for footwear; ramie fabric; esparto fabric; rayon fabric; fibreglass fabrics for textile use; adhesive fabric for application by heat; linen cloth; upholstery fabrics; hemp fabric; lining fabric for footwear; reusable wax coated fabrics for wrapping food; traced cloths for embroidery; chenille fabric; printed calico cloth; knitted fabric; cotton fabrics; silk

fabrics for printing patterns; woollen cloth; elastic woven fabrics; fabric; fabric imitating animal skins; haircloth [sackcloth]; cheese cloth; tulle; flags of textile or plastic; flannel [fabric]; trellis [cloth]; covers for cushions; fitted toilet lid covers of fabric; covers [loose] for furniture; pillow shams; cheviots [cloth]; silk [cloth]; labels of textile.

(260) AM 2023 119825 A
(800) 1688611
(151) 2022 08 12
(891) 2022 08 12
(731) Al Muqarram Auto Parts LLC
P.O. Box: 60235, Dubai, United Arab Emirates
(540)



(591) Red and gray
(531) 18.01.21; 27.05.01; 27.05.03; 29.01.12
(511)
12 – Vehicles; apparatus for locomotion by land, air or water.

(260) AM 2023 119828 A
(800) 1688828
(151) 2022 07 04
(891) 2022 07 04
(731) HL Holdings Corporation
46, Giheungdanji-ro, Giheung-gu, Yongin-si, Gyeonggi-do, Republic of Korea
(540)

HL Mando

(591) Black, white
(511)
1 – Antifreeze; brake fluid; power steering fluid; hydraulic oils.
3 – Windscreen cleaning liquids; automobile cleaners; automobile polish; degreasers for cars.
4 – Engine oils; lubricating grease; lubricating oils; lubricating oil for motor vehicle engines; cutting oils.
7 – Alternators; alternating current servo motors; starters for motors and engines; starter alternators; motors (except for land vehicles); current generators; driving motors other than for vehicles; servo motors other than for vehicles; electric motors other than for vehicles; DC motors other than for vehicles; driving motors, other than for land vehicles; motors, other than for land vehicles; motors, electric, other than for land vehicles; direct current motors; DC generators.
9 – Automatic indicators of pressure in vehicle tyres; distance between cars measuring apparatus for vehi-

les; portable telecommunications apparatus; global positioning instruments; telecommunication apparatus for use in cars; cameras for vehicles; radar systems; object detecting sensors; brake pad wear sensors; tire pressure sensor; software for GPS navigation systems.

10 – Portable oxygen concentrators for medical purposes; medical machines and instruments.

11 – Heating and cooling systems for motor cars, not being parts of engines or motors; air conditioners for automobiles; ventilation (air-conditioning) installations and apparatus for automobiles; heaters for automobiles; gas recovery apparatus.

12 – Motorcycles; parts and fittings for motorcycles; two-wheeled motor vehicles; air bags [safety devices for automobiles]; steering wheels for automobiles; reversing alarms for automobiles; parts and fittings for automobiles; electric cars; mopeds; parts and fittings for bicycles; suspension springs for motor cars; spiral springs for vehicles; shock absorbing springs for vehicles; spring-assisted hydraulic shock absorbers for vehicles; air springs for vehicles; suspension shock absorbers for vehicles; vehicle suspension springs; shock absorbers for automobiles; brakes for motor cars; brakes for vehicles; nonskid devices for vehicle tires; brakes for motorcycles; electric bicycles; self-driving cars; self-driving robots for delivery; civilian drones.

(260) AM 2023 119829 A
(800) 1688873
(151) 2022 09 09
(891) 2022 09 09
(731) Apple Inc.
One Apple Park Way, Cupertino CA 95014, USA
(540)

A16 BIONIC

(591) Black, white
(511)
9 – Computer hardware, namely, integrated circuits and computer chips.

(260) AM 2023 119830 A
(800) 1688885
(151) 2022 04 04
(891) 2022 04 04
(731) Union des Associations Européennes de Football (UEFA)
Route de Genève 46, CH-1260 Nyon, Switzerland
(540)

UEFA EURO 2024

(591) Black, white

(511)

3 – Cosmetic products; soaps; cosmetic preparations for baths; powders for the body, the face, for cosmetic use and for the bath; perfumes, eaux de Cologne; pre-shave and after-shave lotions; shaving creams; shampoos, conditioners; dentifrices, mouthwashes not for medical use; deodorants and antiperspirants for personal use; care creams, cosmetic creams; make-up removing creams for the face; make-up removing preparations; lip balms; lip gloss; lip balms [non-medicated]; lipstick; lip liner pencils; breath freshening products; tooth whitening creams; tooth whitening products (tapes or pastes); sun-tanning creams and lotions; hair lotions, hair sprays; toiletry creams; make-up products, eye shadows, face powders, cosmetic pencils; decorative transfers for cosmetic use; cotton sticks for cosmetic use; cotton balls for cosmetic use; shampoos for babies; baby oils [toiletries]; baby lotions [toiletries]; liquid soaps for babies' bodies; talcum powder for babies; wet wipes for infants; baby wipes; cleaning, polishing, scouring and abrasive preparations for household use; laundry powder detergents; synthetic cleaning products; shoe waxes and creams; leather care products.

4 – Lubricants; engine oils and fuels, including gasoline, diesel oil, gases and bio-fuels; candles; waxes; industrial greases; natural gas; liquid gases; industrial oils; lubricating oils and greases; carburants; liquefied petroleum gas; non-chemical additives for fuel, lubricants and greases; dust absorbing, wetting and binding compositions; lighting fuel; lubricants, oils and greases, and lubricating preparations for industrial use; cutting oils for industrial use; milling oils; cutting fluids for milling.

9 – Exposed films, slides, video game disks; software (recorded programs), including game software; computer databases and programs; recorded or downloaded sounds, images or data; videotapes, magnetic tapes, magnetic disks, DVDs, mini-disks, diskettes, optical disks, compact disks, CD-ROMs, videodisks, memory cards, USB flash drives, whether blank or prerecorded with music, sound or images (which may be animated cartoons); holograms; electronic publications provided by means of CD-ROMs, databases and the Internet; spectacles, sunglasses, diving and swimming goggles; cases, cords and chains for sunglasses and spectacles; binoculars; magnets and decorative magnets; directional compasses; sound and image recording, transmitting and reproducing apparatus; satellite dishes; decoders, namely, electronic hardware and software which can convert, supply and transmit audio and video data; television sets; flat screens, liquid crystal display screens, high-definition screens and plasma screens; radios; home cinema systems; video recorders; CD players; DVD players; MP3 players; cassette players; mini-disk players; digital music players; loudspeakers; headphones, earphones; computers, including laptop computers and electronic tab-

lets; karaoke systems; systems for editing sounds and for mixing sounds; systems for editing video images, and for mixing video images; apparatus for computer data processing; computer keyboards; computer screens; modems; accessories for computers included in this class; computer mice, mouse pads; navigation apparatus; PDAs (personal digital assistants); electronic pocket translators; dictating machines; electronic agendas; scanners; printers; photocopiers; facsimile machines; telephones; answering machines; video telephones; cellular telephones; accessories for cellular telephones included in this class, namely, cases for cellular telephones, apparatus for using hands-free cellular telephones, earphones and headsets for cellular telephones, keypads for cellular telephones, straps for cellular telephones, special cases for carrying cellular telephones, cameras and video cameras integrated in cellular telephones, and portable telephone covers; remote controls for television sets and video systems; teleconferencing systems; calculating machines; credit card readers; currency converting machines; automated teller machines; video cameras, portable video cameras with built-in videocassette recorders (camcorders); photographic equipment, photographic apparatus, cameras (cinematographic apparatus), projectors, flash lamps, special cases and cords for photographic apparatus and instruments, electric cells and batteries; screen saver programs for computers; magnetic, digital or analog recording media, recorded or not, for sounds or images; magnetic cards (encoded); memory cards; integrated circuit cards (smart cards); microchip or magnetic credit cards, microchip or magnetic telephone cards, microchip or magnetic cards for cash dispensers, microchip or magnetic cards for automated teller machines and money exchange machines, prepaid microchip or magnetic cards for cellular telephones, microchip or magnetic travel and show admission cards, microchip or magnetic check guarantee cards and microchip or magnetic debit cards; alarms; wind socks (for indicating wind direction); distance-measuring apparatus; apparatus for measuring and displaying speed; protective gloves; audio receivers, sound amplifiers; television tubes; cathode ray tubes; decoders, namely computer hardware and software which can convert, supply and transmit audio and video data; disk drives for computers; protected semi-conductors; integrated circuits containing programs for processing audio, visual or computer data; rechargeable batteries; audio and video data processors and converters; data transmission cables; payment apparatus for electronic commerce; protective helmets for sports; magnetic identification bracelets; components of electronic instruments; fuel/air coefficient analyzers; remote control devices for locking cars; photovoltaic cells; video game cassettes; scientific, weighing, measuring, signaling, checking (supervision), emergency (life-saving) and teaching apparatus and instruments, included in this class; burglar alarms, anti-theft alarm apparatus, fire alarms; measu-

ring apparatus and instruments; remote control equipment, remote controls; navigation apparatus, navigational instruments; telematic apparatus; telematic terminals; encoded electronic tickets; tickets in the form of magnetic cards; electronic apparatus for electricity distribution.

12 – Bicycles, motorcycles, motor cars, trucks, vans, utility vehicles, buses, camper vans, refrigerated vehicles; airplanes and boats; air balloons, dirigible balloons [airships]; vehicle accessories, namely sun visors, pneumatic tires, tire covers, luggage racks, ski racks, rims and hub caps for wheels; seat linings, vehicle covers, baby carriages, strollers, safety seats for infants and children (for vehicles); engines and motors for land vehicles; bull bars; headlamp covers; steering wheels for vehicles; trailers; motors, engines and distributors for land vehicles; alarm systems for vehicles, anti-theft devices for vehicles.

14 – Jewelry, necklaces; jewelry; watches; wristwatches, clocks; chronographs; pendulum clocks; medallions, pendants, brooches; bracelets; pins (jewelry); lapel pins (jewelry); tie clips and tie pins; cuff links; commemorative medals of precious metal; prize cups, commemorative plates, trophies, statues, sculptures, all of precious metal; decorative hat pins, key rings (trinkets or fobs), printed metal disks for collection purposes (pogs), all made of precious metal; decorative key holders; collection coins; medals for clothing; cases for watches; badges of precious metal; alarm clocks; badges and pins (jewelry); leather bracelets; bracelets of plastic materials; ornamental key rings of plastic materials.

16 – Coloring and drawing books; activity books; magazines; newspapers; books and journals, including those concerning sportsmen, sportswomen or sports events; bookmarks; printed teaching material; score sheets; event programs; albums for events; photograph albums; autograph books; printed timetables; pamphlets; collectible photographs of players; bumper stickers, stickers, albums, sticker albums; posters; photographs; tablecloths of paper; towels of paper; bags of paper; invitation cards; greeting cards; gift wrapping paper; coasters and place mats of paper; garbage bags of paper or of plastics; food wrapping paper; small bags for preserving foodstuffs; coffee filters of paper; labels (not of textile); hand towels of paper; wet hand-wipes of paper; toilet paper; tissues of paper for removing make-up; paper and cardboard boxes for pocket handkerchiefs; handkerchiefs of paper; stationery and instructional and teaching material (except apparatus); typewriter paper; copying paper; envelopes; notepads; folders for papers; tissue paper; writing books; paper sheets for note-taking; writing paper; binder paper; files; covering paper; luminous paper; adhesive paper for notes; paperweights; crêpe paper; tissue paper; badges or insignia of paper; flags of paper; pennants (flags) of paper; writing instruments; fountain pens; pencils; ballpoint pens; ball-

point pen and pencil sets; felt-tip pens (marking pens); fiber-tip pens and felt-tip pens; marking pens; writing ink, pen ink, stamp pads, rubber stamps; typewriters (electric or non-electric); lithograph prints, lithographic works of art; paintings (pictures), framed or unframed; paint boxes, paints and colored pencils; chalks; pencil ornaments [stationery]; printing blocks; address books; diaries (planners); personal organizers of paper; road maps; tickets, entry tickets; checks; comic books; calendars; postcards; advertising boards, banners and material included in this class; transfers (decalcomanias); sticking labels; office requisites (except furniture); correction fluids; rubber erasers; pencil sharpeners; stands for pens and pencils; paper clips; thumbtacks; drawing rulers; adhesive tapes for stationery purposes, adhesive tape dispensers; staples; stencils; document holders (stationery); paper clips; holders for notepads; bookends; stamps (seals); postage stamps, foreign postage stamps, collectible postage stamps, postage stamps for collectors; commemorative stamp sheets; credit cards, telephone cards, ATM cards, cards for traveling and for shows, check guarantee cards and debit cards, non-magnetic, and of paper or cardboard; baggage tags of paper; passport cases; travelers' checks; holders for checkbooks; money clips of metal; letter trays.

18 – Leather and imitations of leather; leather straps; umbrellas, parasols; sports bags (other than those adapted for products they are designed to contain); leisure bags; travel bags, backpacks; school bags; bags for hanging on belts; handbags, leather bags; beach bags; garment bags; suitcases; document cases; identity card holders; belts for suitcases; briefcases (leather goods); cases for toiletry articles known as vanity cases (not fitted); toiletry bags; key cases (leather goods); business card cases; wallets; purses; whips; collars for animals; luggage tags of leather.

25 – Clothing; shoes and footwear; headwear; shirts; knitwear (clothing); pullovers; slipovers; tee-shirts; vests; jerseys; sleeveless jerseys, dresses; skirts; underwear, functional underwear, brassieres; swimsuits; bathrobes; shorts; trousers; sweaters; stocking caps; caps; hats; long scarves; scarves, shawls; peaked caps; tracksuits; sweatshirts; jackets, sports jackets, stadium jackets (jumpers); blazers; waterproof clothing; coats; uniforms; neckties; wrist bands; headbands; gloves; aprons; bibs (not of paper); pajamas; play suits for infants and children; socks and stockings; tights and leggings, garters; belts; suspenders; sandals; sports shoes, namely, shoes for outdoor sports, basketball shoes, multi-sport shoes, cycling shoes, indoor sports shoes, track and field shoes, football shoes (indoor and outdoor), canvas shoes, tennis shoes, sneakers, sailing shoes, shoes for aerobics; hiking boots; flip-flops; sportswear, namely, fleece tops, jogging suits, sportswear of knitted fabric, casual sports pants, polo shirts, sweatshirts, tracksuit pants, football jerseys, rugby shirts, swimwear, sports jerseys, leotards, wri-

tbands [clothing], ski suits, ski jackets, ski pants; wrist bands [clothing].

26 – Braids; tassels (haberdashery); ribbons; buttons; sewing needles; sewing boxes; badges for clothing (other than of precious metal); brooches (clothing accessories); decorative pins and needles not of precious metal; ornament pins for hats not of precious metal; hair nets, hair bands; barrettes (hair slides); hair pins; hair ribbons; pins not of precious metal; cords for clothing; bands for clothing (strips); competitors' numbers for advertising use; shoe ornaments not of precious metal; other decorative articles for the hair included in this class; badges of all kinds not of precious metal (including numbers and letters); plastic badges; badges and lapel pins (badges not of precious metal).

28 – Games and toys; sports balls; play balloons; table-top games; tables for indoor football; dolls and plush toys; vehicles (toys); jigsaw puzzles; balloons; inflatable toys; play disks (pogs); playing cards; confetti; gymnastic and sporting articles; football equipment, namely balls for football, gloves, knee guards, elbow guards, shoulder guards, shin guards; football goals; sports bags and containers (adapted to objects) for carrying sports articles; party hats (toys); small electronic games designed for use with a television set; video game apparatus; game consoles, electronic games other than those adapted for use with television receivers only; steering wheels for video games and mats for video games (for dancing upon); hands made of rubber or foam (toys); entertainment robots; appliances for gymnastics; kites; roller skates; scooters; skateboards; coin-operated video games for game halls (arcade games); electronic games with liquid crystal display; joysticks for video games, manually or voice-activated joysticks for video games; lottery tickets; lottery cards, scratch tickets for lottery games; toys for household pets; computer game joysticks; voice-activated or manually operated computer game joysticks.

29 – Meat; fish; poultry; game; meat extracts; canned fish and meat; cooked fruits and vegetables; canned fruits and vegetables; edible oils and fats; potato chips; French fries; prepared walnuts; jams; marmalades and jellies; milk; milk products (milk predominating), dairy products; cheeses; soy milk (milk substitute); consommés; broths.

30 – Coffee; tea; cocoa; chocolates; sugar; honey; coffee substitutes; flours; cereal preparations; cereals; bread; pastry; pastes (pastry); pasta; cakes; biscuits and cookies; crackers; candy; edible ices; confectionery; rice; dried cereal flakes; mustard; vinegar; sauces (condiments); spices; salt; honey, molasses, yeast, salt, mustard, vinegar or spices; salt and salt-based products for preserving foodstuffs; pizzas; fresh pizzas; pizza doughs; burgers inserted in brioche bread, namely hamburgers; hot dogs (sandwiches); sandwich-

es filled with meat; cheeseburgers (sandwiches); fish sandwiches; tea-based beverages; iced tea; instant cocoa.

32 – Non-alcoholic beverages; syrups and powders for making non-alcoholic beverages; mineral and aerated waters; energy drinks, isotonic drinks, hypertonic and hypotonic drinks; fruit and vegetable beverages; fruit and vegetable juices; sports beverages; frozen fruit drinks, frozen flavored drinks, non-carbonated and non-alcoholic; drinks enriched with added vitamins, not for medical use; beers; strong dark beers; lagers and ales; non-alcoholic or low-alcohol beers.

35 – Employment agencies; personnel recruitment; advertising services; services provided by an agency publishing advertising texts; advertising agency services; advertising agency services on a global computer network (the Internet) or via wireless electronic communication devices; dissemination of advertisements; rental of advertising space; rental of advertising time in film credits; television advertising, radio advertising; advertising in the form of animated cartoons; promotion agency services, promotion agency services for sports and public relations; promotion of football events; market study services; market research services; public opinion polling services; organization of exhibitions for commercial or advertising purposes; organization of advertising for trade fairs; compilation and systematization of data in data banks; data bank management services; establishing statistics; advertising for sports events in the field of football; retail sale services for and bringing together of various goods for the benefit of others (excluding the transport thereof), namely clothing, footwear, headgear, sports articles, stationery, apparatus for recording, transmission and reproduction of sound and images, books, newspapers, magazines, publications, video games, toys, dolls, badges of all kinds, key rings, tickets, watches and jewelry, souvenir items in connection with football, bags, luggage, briefcases, umbrellas, flags and pennants, alcoholic and non-alcoholic beverages, confectionery, medical apparatus and instruments, vehicles and accessories for motor cars; retail sale services for solvents, paraffin, waxes, bitumen and petroleum; bringing together of the following goods for the benefit of others (excluding transport) to enable customers to conveniently view and purchase these goods in a store or on a global computer network (the Internet) or via wireless electronic communication devices, namely clothing, shoes, headgear, sports articles, stationery, apparatus for recording, transmission and reproduction of sound and images, books, newspapers, magazines, publications, video games, toys, dolls, badges of all kinds, key rings, tickets, watches and jewelry, souvenir items in connection with football, bags, luggage, briefcases, umbrellas, flags and pennants, alcoholic and non-alcoholic beverages, confectionery, medical apparatus and

instruments, vehicles and accessories for motor cars; advertising and promotion services, information services with regard to advertising and promotion, commercial information agencies, all the aforesaid services provided on-line from a computer database or via a global computer network (the Internet) or via wireless electronic communication devices; design and compilation of advertisements for use as a web site on a global computer network (the Internet) or via wireless electronic communication devices; provision of space on web sites, for advertising of goods and services; auctioneering on a global computer network (the Internet) or via wireless electronic communication devices; collection of directories for publication on the Internet and on wireless electronic communication networks; business administration services for processing commercial services on a global computer network (Internet) or via wireless electronic communication devices; compilation, creation and management of databases, namely collection of domain names in a register; sales promotion, namely creation of preferential programs for customers; implementation of bonus programs for customers in stadiums by distributing encoded loyalty and membership cards which can contain the personal data of the user; development, launch and administration of loyalty programs, namely issuing loyalty cards to fans, containing personal information on the identity of the card holder; electronic commerce (e-commerce) services, namely provision of information on goods via telecommunication networks for advertising or sales purposes; compilation of data into a computer database, especially still or animated images; e-commerce services, namely on-line services for providing contracts for the purchase and sale of goods on behalf of others; promotion of sports events in the field of football; promotion of the goods and services of others, through contractual agreements, particularly partnership (sponsoring) and licensing agreements, providing them with increased notoriety and enhanced image derived from cultural and sporting events, particularly international events; compilation and recording of data and information on sporting performances; provision of personnel, particularly for selling beverages and foods; promotion of football events; retail sale of interactive educational and entertainment products, interactive compact disks, CD-ROMs and computer games; retail sale services, particularly on a global computer network, for interactive educational and entertainment products, interactive compact disks, CD-ROMs and computer games; presentation of computer programs for retail sale purposes; procurement services for others [purchasing goods and services for other businesses]; procurement services for others [purchasing goods and services for other businesses] for sports events or entertainment; promotion of the goods and services of others, through contractual agreements, particularly partnership (sponsoring) and licensing agreements, providing them with increased notoriety and/or enhanced image

and/or affinity derived from cultural and sporting events, particularly international events; retail and wholesale services for motor vehicles, motor vehicle parts and motor vehicle accessories; retail and wholesale trading services on the Internet for motor vehicles, motor vehicle parts and motor vehicle accessories; compilation of data in computer data banks.

36 – Issuance and management of credit cards and travelers' checks; financial services; banking, credit and investment services; insurance services; lease-purchase financing; hire-purchase services; financial sponsorship of sports events; information services related to finance and insurance, provided from a computer database or the Internet or on all wireless electronic communication networks; home banking services; banking services on the Internet or on all wireless electronic communication networks; payment services, including services provided from a computer database or via the Internet or via mobile telephones; safe deposit services; issue of vouchers, namely issue of loyalty cards to fans, which contain personal data on the identity of the cardholder and are used for access control at sports stadiums; financing for the promotion of events in the field of football; financial payment services for electronic commerce, namely transfer of funds, all via electronic communication networks; financial sponsorship search for football competitions; financial payment services for electronic commerce in connection with the purchase of goods and services provided by others, all via electronic communication networks, and clearing and settlement of financial transactions via electronic communication networks; issue of vouchers in the form of travel vouchers.

38 – Telecommunication services; communication by mobile telephones; communication by telex; communication via electronic computer terminals linked to telecommunication networks, data banks and the Internet or via wireless electronic communication devices; communication by telegraphs; communication by telephones; communications by facsimile; paging services; telephone or video conferencing services; television program broadcasting; broadcasting of cable television programs; radio program broadcasting; transmission of radio and television programs of sports and sports events; news and press agency services; other message transmission services; rental of telephones, facsimile machines and other telecommunication apparatus; transmission of commercial Internet pages online or via wireless electronic communication devices; services for transmitting and broadcasting television and radio programs provided via the Internet or via any wireless electronic communication network; electronic transmission of messages; simultaneous broadcasting of film recordings and sound and video recordings; provision of access to telematic servers and real-time chat forums; computer-aided transmission of messages and images; telecommuni-

cation via fiber-optic networks; provision of access to a global computer network or interactive communication technologies for access to private and commercial purchasing and ordering services; transmission of information and other data via websites and computers; transmission of information (including sites by telematic means) via telecommunication, computer programs and other data; transmission of information, computer programs and other data by telematic means; electronic mail services; provision of access via the Internet or on any wireless electronic communication network (telecommunication services); providing connections for telecommunications with a global computer network (the Internet) or data banks; provision of access to websites offering digital music on the Internet by means of a global computer network or via wireless electronic communication devices; rental of access time to MP3 websites on the Internet, via a global computer network or via wireless electronic communication devices; rental of access time to a database server center (telecommunication services); rental of access time to a computer database (telecommunication services); transmission of digital music by telecommunications; online transmission of electronic publications; digital music transmission via the Internet or on any wireless electronic communication network; digital music transmission via MP3 Internet sites; simultaneous broadcasting and/or netcasting of film recordings and sound and video recordings (telecommunications); simultaneous broadcasting and/or netcasting of interactive educational and entertainment products, interactive compact disks, CD-ROMs, computer programs and computer games (telecommunications); providing access to blackboards (display and advertisement notice boards) a blog, and to discussion forums (chat rooms) in real time via a global computer network; rental and provision of access time to blackboards (boards for displaying information and advertisements) and to chat rooms in real time by means of a global computer network (communication services); telecommunication services dedicated to retail sale by means of interactive communications with customers; multimedia telecommunication; videotext and teletext transmission services; information transmission via communication satellite, microwave or by electronic, digital or analog means; transmission of digital information by cable, wire or fiber; transmission of information by mobile telephones, telephones, facsimile and telex; telecommunication services for receiving and exchanging information, messages, images and data; telecommunication services for setting up discussion groups on the Internet and on any wireless electronic communication network; provision of access to search engines on the Internet, provision of access to platforms on the Internet (also on the mobile Internet) in the form of customized online pages featuring information defined or specified by users, personal profiles, audio contents, video contents, photographic images, texts, graphic

illustrations and data; provision of access to search engines for obtaining data and information on global networks.

39 – Services of a travel agency, namely, travel arrangement and reservation; ticket reservation and information services for travel; transport by airplane, railway, bus and truck; boat transport; boat travel services; tourist travel services; rental of vehicles and automobiles; rental of parking spaces; taxi services; boat transport services for goods; distribution of water, heat, gas or electricity; distribution of newspapers, magazines and books; postal services, mail delivery and courier services; storage of merchandise; delivery of solvents, paraffins, waxes, bitumens and oil products, excluding liquid gas; distribution (delivery) of films and sound and image recordings; distribution (delivery) of interactive educational and entertainment products, interactive compact disks, CD-ROMs, computer programs and computer games; ticket distribution (transport); navigation services by global positioning system; advice relating to power and electricity distribution; transport services; packaging and storage of goods; towing, transport and taxi; car transport; rental of vehicles, especially automobiles; motor vehicle fleet tracking and monitoring services using electronic positioning and navigation devices; assistance services relating to energy and electricity distribution.

41 – Education; training; entertainment; organization of lotteries, raffles and competitions; betting and gaming services in connection with sports; provision of entry tickets and information brochures on sports for VIPs, as well as guiding and gathering VIPs for sports or entertainment events, provision of online information in the field of sports or sports events from a computer database or the Internet; customer reception services (entertainment services) including provision of access tickets during sports or entertainment events; entertainment services relating to sporting events; entertainment services in the form of public gatherings during the retransmission of sports events; sporting and cultural activities; organization of sporting and cultural events and activities; amusement park services; sports club services [health and fitness training]; organization of sports competitions; organization of events in the field of football; sports camp services; providing sports facilities; rental of video and audiovisual installations; production, presentation, distribution and/or rental of film recordings and sound and video recordings; presentation, distribution and/or rental of interactive educational and entertainment products, interactive compact disks, CD-ROMs, and computer games; radio and television coverage of sporting events; production services for radio, television programs and video films; ticket reservation services and information services for sports or entertainment events; timing services relating to sports events; organization of beauty contests; interactive

entertainment; on-line betting and gaming services on the Internet or on any wireless electronic communication network; information in the field of entertainment (including in the field of sports), provided on-line from a computer database or via the Internet or via any wireless electronic communication network; electronic game services transmitted via the Internet or on mobile telephones; editing of books; publication of books and electronic journals on-line; audio and video recording services; production of animated cartoons for the cinema, production of animated cartoons for television; rental of sound and image recordings for entertainment purposes; information in the field of education provided on-line from a computer database or via the Internet or any wireless electronic communication network; translation services; photography services; provision of entertainment infrastructure; ticket agencies in connection with sports events; entertainment information in the field of sports; provision of information in the field of sports events; publication of statistics; publication of statistics and information on sports performances; provision of entertainment infrastructure, namely VIP boxes and boxes inside and outside stadiums.

43 – Providing food and drink, snack-bars; hospitality services, namely provision of food and drink; catering services; hotel services; providing accommodation and food and drink, booking hotels and temporary accommodation; hospitality services, namely provision of food and drink during sports or entertainment events.

(260) AM 2023 119831 A
 (800) 1688896
 (151) 2022 07 14
 (891) 2022 07 14
 (731) Estetra SRL
 Rue Saint-Georges 5, B-4000 Liège, Belgium
 (540)



(591) Blue, pink, purple and white
 (531) 26.04.09; 26.04.16; 26.04.24; 26.11.12;
 26.13.01; 29.01.14
 (511)
 5 – Chemical contraceptives; contraceptive preparations; pharmaceutical products in the field of gynaecology and women's health.

(260) AM 2023 119832 A
 (800) 1688985
 (151) 2022 08 08
 (891) 2022 08 08
 (731) Financiera Maderera S.A.
 Formarís s/n, E-15707 Santiago de Compostela
 (A Coruña), Spain
 (540)

FINSA

(591) Black, white
 (511)
 19 – Panels of wood and panels not of metal for construction; building timber; semi-worked wood; building materials, not of metal; transportable buildings, not of metal; ground cover layer made of wood, vinyl, vinyl or PVC sheets; skirtings of the following materials: wood, building timber, vinyl or PVC and materials derived from wood, building timber, vinyl or PVC; floor materials of wood and products derived from wood, vinyl or PVC; wood materials and processed wood for construction; non-metallic laminated boards for walls; interior linings of wood and products derived from wood, vinyl or PVC for construction; wall linings, not of metal, for building; covering for boards (not of metal); vinyl floor coverings for forming a floor; vinyl siding; parquet floor; floors made of sheets; rigid pipes, not of metal, for building; asphalt, pitch and bitumen; monuments, not of metal; non-metallic boards for floor coverings; boards, not of metal, for building; boards, not of metal, for walls and partitions; boards not of metal for doors; laminated particleboards; laminated boards (not of metal) for building; plywood boards; veneered boards; boards of wood fiber bound with resin and particleboards; laminated fiberboards; wood boards; wood particle boards; boards for floors (not of metal); laminated floors of wood and products derived from wood; floors, not of metal; wall claddings, not of metal, for building; floor boards of wood; boards of wood for floors; elements of wood for building; planks of wood for building; components of wood for building; bamboo flooring; other flooring made made of wood fiber or chips; PVC flooring; flooring made of wood and plastic; non-metallic flooring consisting primarily of linoleum; ceramic tiles for flooring and covering; moldings, not of metal, for building; finishing of wood; moldable wood; molded wood; wood for sawing; wood for hobby use; tiles of wood; wood fiber boards; wood fiber and particle boards; structural reinforcement (non-metallic) for construction purposes; prefabrica-

ted components for constructions (not of metal); interior partition walls made of non-metallic materials; bridge supports based on wood and products derived from wood, vinyl or PVC [building materials]; ceiling and roof coverings based on wood and products derived from wood, vinyl or PVC; covers of wood and products derived from wood, vinyl or PVC for construction purposes; vinyl or PVC columns for building; columns of wood for building; beams of wood and products derived from wood, vinyl or PVC; beams of wood; trellis of wood and products derived from wood, vinyl or PVC for building; parts and accessories for all the aforesaid goods.

20 – Panels of wood for furniture; doors for furniture; furniture; furniture of wood; decorative wooden panels [furniture]; picture frames; goods of plastic, in particular panels for furniture, doors, furniture, decorative panels, accessories for doors, storage chests, coffins, barrels, boxes, drawers, beds, wall decor, furniture partitions, garden furniture shelves, picture and photo moldings, works of art, louver screens, blinds, plates, door knobs, prefabricated doors; containers (other than for household or kitchen use), bed bases, window fasteners, drawer pulls, door stops, screws (not of metal); mirrors [looking glasses]; containers not of metal for storage or transport; bone, horn, whalebone or mother-of-pearl, unwrought or semiwrought; shells; meerschaum; yellow amber; door fittings of wood; storage chests of wood; coffins of wood; barrels of wood; wooden boxes; drawers of wood; wooden beds; kennels for animals; wall decorations of wood; furniture partitions of wood; shelves of wood [furniture]; garden furniture made of wood; picture and photo moldings of wood; works of art made of wood; louver screens of wood; blinds of wood; plaques of wood; door knobs of wood; prefabricated doors of wood for furniture; containers of wood (other than for household or kitchen use); bed bases made of flexible wood; window fasteners of wood; drawer pulls of wood; door stops of wood; wood screws (non-metallic); outdoor furniture; files for storing magazines [furniture]; pedestals for planters and flowerpots; parasol supports; seat cushions.

(260) AM 2023 119833 A
 (800) 1688987
 (151) 2022 07 08
 (891) 2022 07 08
 (731) Cointreau
 Carrefour Molière, F-49124 Saint-Barthelemy-D'anjou, France

(540)



(591) Cream white Pantone 11-0507 CTX, green Pantone 5545 C, orange Pantone 172 C, black Pantone 6 C, copper Pantone 7576 C and amber Pantone 7565 C

(531) 05.03.13; 05.07.11; 05.07.22; 07.01.24; 19.07.02; 19.07.10; 25.01.06; 25.01.09; 25.01.10; 25.01.15; 27.01.08; 27.05.03; 29.01.15

(511)

32 – Mineral and carbonated waters and other non-alcoholic beverages, namely carbonated beverages, fruit juices and fruit beverages; syrups and concentrates for making carbonated beverages, non-carbonated beverages, fruit drinks and non-alcoholic cocktails based on fruit juices and fruit drinks.

33 – Alcoholic beverages except beers, namely, wines, gin, vodka, whisky, cider, liqueurs, spirits, brandies, alcoholic liqueur-based cocktails, alcoholic wine-based aperitifs, alcoholic liqueur-based aperitifs.

(260) AM 2023 119849 A
 (800) 1689474
 (151) 2022 08 10
 (891) 2022 08 10
 (731) Unipharm Inc.
 350 Fifth Avenue, Suite 6701, New York
 NY 10118, USA

(540)



(591) White, black and shades of blue.
 (531) 26.01.18; 27.05.22; 29.01.13

(511)

3 – Non-medicated cosmetics and toiletry preparations; non-medicated dentifrices; perfumery, essential oils; bleaching preparations and other substances for

laundry use; cleaning, polishing, scouring and abrasive preparations.

5 – Pharmaceuticals, medical and veterinary preparations; sanitary preparations for medical purposes; dietetic food and substances adapted for medical or veterinary use, food for babies; dietary supplements for human being and animals; plasters, materials for dressings, material for stopping teeth, dental wax; disinfectants; preparations for destroying vermin; fungicides, herbicides.

10 – Surgical, medical, dental and veterinary apparatus and instruments; artificial limbs, eyes and teeth; orthopaedic articles; suture materials; therapeutic and assistive devices adapted for persons with disabilities; massage apparatus; apparatus, devices and articles for nursing infants; sexual activity apparatus, devices and articles.

16 – Paper and cardboard; printed matter; bookbinding material; photographs; stationery and office requisites, except furniture; adhesives for stationery or household purposes; drawing materials and materials for artists; paintbrushes; instructional and teaching materials; plastic sheets, films and bags for wrapping and packaging; printers' type, printing blocks.

32 – Beers; non-alcoholic beverages; mineral and aerated waters; fruit beverages and fruit juices; syrups and other non-alcoholic preparations for making beverages.

35 – Advertising; business management, organization and administration; office functions.

(260) AM 2023 119850 A

(800) 1689506

(151) 2022 08 01

(891) 2022 08 01

(731) Doktor Tarsa Tarım San.Ve Tic.A.Ş.
AOSB2KISIM MAH. 22. CAD. 10,
Döşemealtı Antalya, Türkiye

(540)

Powerfol

(591) Black, white

(531) 27.05.17

(511)

1 – Chemicals used in industry, science, photography, agriculture, horticulture and forestry; manures and soils.

(260) AM 2023 119851 A

(800) 1689514

(151) 2022 08 12

(891) 2022 08 12

(731) Shenzhen Tisenc Medical Devices Co., Ltd.
11F, 11G, Kechuang Building, Quanzhi
Science and Innovation Park, Maozhoushan

Industrial Park, Houting Community, ShaJing
Street, BaoAn District, 518104 ShenZhen,
China

(540)

TISENC

(591) Black, white

(531) 27.05.01

(511)

5 – Chemical reagents for medical or veterinary purposes; diagnostic biomarker reagents for medical purposes; reagent paper for medical purposes; chemical preparations for the diagnosis of pregnancy; diagnostic strips for testing breast milk for medical purposes; diagnostic preparations for medical purposes; biological preparations for medical purposes; enzyme preparations for medical purposes; diagnostic preparations for veterinary purposes.

10 – Surgical apparatus and instruments; veterinary apparatus and instruments; medical apparatus and instruments; apparatus for use in medical analysis; testing apparatus for medical purposes; diagnostic apparatus for medical purposes; apparatus for DNA and RNA testing for medical purposes; body composition monitors.

(260) AM 2023 119852 A

(800) 1689542

(151) 2022 02 23

(891) 2022 02 23

(731) ASOS Holdings Limited

Greater London House, Hampstead Road,
London NW1 7FB, United Kingdom

(540)

TOPSHOP

(591) Black, white

(511)

25 – Clothing, footwear, headwear; outerwear; sportswear; activewear; overcoats; coats; jackets; mantillas; parkas; pelerines; ponchos; anoraks; dresses; skirts; ball gowns; prom dresses; lace dresses; wedding dresses; embroidered dresses; bridesmaid dresses; tea dresses; satin dresses; jerseys; jumper dresses; knitwear; jumpers; cardigans; pullovers; sweaters; hooded tops; hooded sweatshirts; sweatshirts; suits; uniforms; suits; wedding suits; cummerbunds; blouses; shirts; shirt fronts; short-sleeve shirts; t-shirts; tee-shirts; polo shirts; tops; tunics; trousers; pants; jeans; dungarees; shorts; jogging pants; chinos; trouser straps; braces; clothing of imitations of leather; clothing of leather; clothing of synthetic leather; bandanas; caps; beanies; berets; scarves; shower caps; earmuffs; hats; paper hats; headbands; hoods; cap peaks; top hats; turbans; veils; scarfs; shawls; ready-made clothing; shoes; boots; sandals; trainers; sneakers; leather shoes; suede shoes; heeled shoes; canvas footwear; beach shoes; footmuffs; non-slipping devices for footwear; tips for

footwear; heelpieces for footwear; half-boots; heels; lace boots; slippers; soles for footwear; inner soles; footwear uppers; boot uppers; flip-flops for use as footwear; sliders being footwear; belts; money belts; bibs (not of paper); brassieres; camisoles; corsets; capes; bodices; dressing gowns; bath robes; layettes; petticoats; slips; morning coats; wristbands; collars; detachable collars; articles made from faux fur, namely, clothing, footwear and headgear; gloves; mittens; muffs; leggings; leg warmers; hosiery; socks; stocking suspenders; stockings; tights; leotards; ready-made linings; sleep masks; face masks [clothing]; face coverings [clothing]; neckties; ties; bow ties; playsuits; jumpsuits; pocket squares; pockets for clothing; lingerie; underpants; underwear; bralettes; lace underwear; satin underwear; satin sleepwear; satin camisoles; velvet camisoles; nightwear; loungewear; pyjamas; nighties; sleepsuits; saris; sarongs; togas; shoulder wraps for clothing; beachwear; swimwear; swimsuits; bathing trunks; swimming costumes; bikinis; bikini tops; waistcoats; vests; tank tops; base layer clothing; bodysuits; coordinates [clothing]; costumes; fancy dress costumes; aprons; tracksuits; football clothing; football kits (football uniform); replica football kits; football boots [shoes]; studs for football boots [shoes]; socks for football; sportswear, including sportswear for football, five-a-side football, volleyball, rugby, basketball, tennis, skiing, golf, baseball, running, gymnastics and exercise in general, not included in other classes; clothing for dance; sports shoes; ballet shoes; jazz shoes; articles of golf clothing; golf shorts; golf shirts; golf caps; golf trousers; moisture-wicking sports pants; moisture-wicking sports shirts; sports bras; moisture-wicking sports bras; articles of clothing, footwear, headgear.

35 – Advertising; business management, organization and administration; office functions; advertising, marketing and promotional services; distribution of samples; development of advertising concepts; shop window dressing; production of teleshopping programmes; organization of trade fairs and exhibitions for commercial or advertising purposes; search engine optimization for sales promotion; administration of consumer loyalty programs; wholesale, retail and online retail services connected with the sale of non-medicated cosmetics and toiletry preparations, perfumery, bathing and personal cleansing and care products, home cleaning preparations, candles and wicks for lighting, hand-operated tools and implements for personal use, electric and non-electric hand implements for personal grooming, audio-visual and information technology equipment, safety and life-saving equipment, eyewear, spectacles, sunglasses, downloadable mobile application software, mobile phone cases, face masks, headphones, speakers, encoded gift cards, bags adapted for laptops, bags and cases for cameras and photographic equipment, environmental control apparatus and installations for the purposes of lighting, cooking, cooling and sanitizing, precious

metals and their alloys, jewellery, precious and semi-precious stones, horological and chronometric instruments, clocks, watches, musical instruments and their parts and accessories, paper, cardboard, stationery, calendars, books, printed matter, drawing materials, bags for wrapping and packaging, leather, imitations of leather, bags, luggage, wallets, purses, handbags and other carrying bags, animal apparel, furniture, furnishings and decorations for the home, mirrors, containers (not of metal), household and kitchen utensils and apparatus, tableware, glassware, household and bed linen, towels, sleeping bags, household linen, yarns and threads for textile use, clothing, footwear, headwear, sportswear, activewear, coats, jackets, dresses, hooded tops, sweatshirts, jeans, jumpers, cardigans, lingerie, underwear, nightwear, loungewear, shorts, skirts, socks, tights, suits, swimwear, beachwear, tops, trousers, dungarees, joggers, chinos, leggings, tracksuits, leggings, waistcoats, t-shirts, shirts, polo shirts, vests, tank tops, blouses, scarves, gloves, hats, caps, shoes, boots, trainers, sneakers, sandals, accessories for apparel, dressmakers' articles, lace, braid and embroidery, synthetic hair for wear and hair adornments, hair accessories, floor and wall coverings, rugs, wall hangings, games, toys, amusement and novelty items, gymnastic and sporting equipment; the bringing together, for the benefit of others, non-medicated cosmetics and toiletry preparations, perfumery, bathing and personal cleansing and care products, home cleaning preparations, candles and wicks for lighting, hand-operated tools and implements for personal use, electric and non-electric hand implements for personal grooming, audio-visual and information technology equipment, safety and life-saving equipment, eyewear, spectacles, sunglasses, downloadable mobile application software, mobile phone cases, face masks, headphones, speakers, encoded gift cards, bags adapted for laptops, bags and cases for cameras and photographic equipment, environmental control apparatus and installations for the purposes of lighting, cooking, cooling and sanitizing, precious metals and their alloys, jewellery, precious and semi-precious stones, horological and chronometric instruments, clocks, watches, musical instruments and their parts and accessories, paper, cardboard, stationery, calendars, books, printed matter, drawing materials, bags for wrapping and packaging, leather, imitations of leather, bags, luggage, wallets, purses, handbags and other carrying bags, animal apparel, furniture, furnishings and decorations for the home, mirrors, containers (not of metal), household and kitchen utensils and apparatus, tableware, glassware, household and bed linen, towels, sleeping bags, household linen, yarns and threads for textile use, clothing, footwear, headwear, sportswear, activewear, coats, jackets, dresses, hooded tops, sweatshirts, jeans, jumpers, cardigans, lingerie, underwear, nightwear, loungewear, shorts, skirts, socks, tights, suits, swimwear, beachwear, tops, trousers, dungarees, joggers, chinos, leg-

gings, tracksuits, leggings, waistcoats, t-shirts, shirts, polo shirts, vests, tank tops, blouses, scarves, gloves, hats, caps, shoes, boots, trainers, sneakers, sandals, accessories for apparel, dressmakers' articles, lace, braid and embroidery, synthetic hair for wear and hair adornments, hair accessories, floor and wall coverings, rugs, wall hangings, games, toys, amusement and novelty items, gymnastic and sporting equipment, excluding the transport thereof, enabling customers to conveniently view and purchase those goods from an online retail store, physical retail store, social media platform and downloadable app; retail and online retail services connected with the sale of downloadable and non-downloadable virtual goods, namely, clothing, footwear, headgear, eyewear, bags, handbags, jewellery and cosmetics, for use online and in online virtual worlds.

(260) AM 2023 119853 A

(800) 1689555

(151) 2022 08 16

(891) 2022 08 16

(731) Apple Inc.

One Apple Park Way, Cupertino CA 95014,
USA

(540)

CARPLAY

(591) Black, white

(511)

42 – Computer programming; design and development of computer hardware and software; providing online non-downloadable software for providing travel and tourism information, travel planning, navigation, travel route planning, geographic, destination, transportation and traffic information, driving and walking directions, customized mapping of locations, street atlas information, electronic map display, and destination information; computer services, namely, providing search engines for obtaining data via the internet and other electronic communications networks; computer services, namely, creating computer network-based indexes of online information, sites and other resources available on global computer networks for others; information and advisory services relating to all the aforesaid.

(260) AM 2023 119864 A

(800) 1689796

(151) 2022 04 04

(891) 2022 04 04

(731) Limited Liability Manufacturing And Trading
Company "ACME"

5 Promyslova Str., Ukrainka, Obukhivsky r-n,
Kyivska obl. 08720, Ukraine

(540)

RE: FORM

(591) Black, white

(531) 24.17.01; 27.05.01; 27.05.10

(511)

3 – Non-medicated cosmetics and toiletry preparations; non-medicated dentifrices; perfumery, essential oils; bleaching preparations and other substances for laundry use; cleaning, polishing, scouring and abrasive preparations; abrasives; sandcloth; glass cloth [abrasive cloth]; abrasive paper; breath freshening sprays; cooling sprays for cosmetic purposes; diamantine [abrasive]; alum stones [astringents]; amber [perfume]; ammonia [volatile alkali] [detergent]; antiperspirants [toiletries]; antistatic preparations for household purposes; flavourings for beverages [essential oils]; cake flavourings [essential oils]; food flavourings [essential oils]; joss sticks; aromatics [essential oils]; potpourris [fragrances]; balms, other than for medical purposes; basma [cosmetic dye]; bergamot oil; whitening; lip glosses; nail glitter; body glitter; badian essence; vaginal washes for personal sanitary or deodorant purposes; petroleum jelly for cosmetic purposes; cotton wool for cosmetic purposes; cotton wool impregnated with make-up removing preparations; cotton swabs for cosmetic purposes; bleaching soda; laundry bleach; bleaching preparations [decolorants] for cosmetic purposes; bleaching preparations [decolorants] for household purposes; bleaching salts; decorative transfers for cosmetic purposes; shoe wax; moustache wax; depilatory wax; wax for parquet floors; floor wax; volcanic ash for cleaning; astringents for cosmetic purposes; cloths impregnated with a detergent for cleaning; gaultheria oil; dental bleaching gels; heliotropine; geraniol; make-up; lipsticks; deodorants for pets; deodorants for human beings or for animals; scented wood; detergents, other than for use in manufacturing operations and for medical purposes; scented water; extracts of flowers [perfumes]; herbal extracts for cosmetic purposes; ethereal essences; essential oils; essential oils for aromatherapy use; essential oils of cedarwood; essential oils of lemon; essential oils of citron; Javelle water; jasmine oil; greases for cosmetic purposes; colorants for toilet purposes; leather preservatives [polishes]; colour-removing preparations; degreasers, other than for use in manufacturing processes; ionone [perfumery]; shaving stones [astringents]; silicon carbide [abrasive]; carbides of metal [abrasives]; adhesives for affixing false eyelashes; adhesives for affixing false hair; adhesives for cosmetic purposes; collagen preparations for cosmetic purposes; quillaia bark for washing; corundum [abrasive]; cosmetics; eyebrow cosmetics; cosmetics for children; cosmetics for animals; beauty masks; cosmetic preparations for baths; cosmetic pre-

parations for eyelashes; cosmetic preparations for skin care; cosmetic preparations for slimming purposes; tailors' wax; shoe cream; skin whitening creams; creams for leather; polishing creams; cosmetic creams; essential oil-based creams for aromatherapy use; starch glaze for laundry purposes; starch for laundry purposes; lavender water; lavender oil; incense; hair spray; nail varnish; hair lotions; lotions for cosmetic purposes; after-shave lotions; massage gels, other than for medical purposes; massage candles for cosmetic purposes; non-slipping wax for floors; almond oil; almond milk for cosmetic purposes; washing soda, for cleaning; deodorant soap; shaving soap; soap for brightening textile; cakes of toilet soap; almond soap; antiperspirant soap; soap for foot perspiration; soap; musk [perfumery]; mint for perfumery; mint essence [essential oil]; cosmetic kits; emery; emery cloth; emery paper; nail art stickers; neutralizers for permanent waving; fumigation preparations [perfumes]; eau de Cologne; eyebrow pencils; cosmetic pencils; oils for toilet purposes; oils for perfumes and scents; oils for cosmetic purposes; oils for cleaning purposes; oil of turpentine for degreasing; mouthwashes, not for medical purposes; drying agents for dishwashing machines; cleansing milk for toilet purposes; cleansers for intimate personal hygiene purposes, non medicated; scouring solutions; perfumery; perfumes; pastes for razor strops; toothpaste; gel eye patches for cosmetic purposes; pumice stone; hydrogen peroxide for cosmetic purposes; polishing wax; polishing paper; polishing rouge; polishing stones; polishing preparations; polish for furniture and flooring; pomades for cosmetic purposes; fabric softeners for laundry use; laundry blueing; laundry preparations; air fragrancng preparations; bath preparations, not for medical purposes; leather bleaching preparations; floor wax removers [scouring preparations]; rust removing preparations; varnish-removing preparations; paint stripping preparations; descaling preparations for household purposes; stain removers; lacquer-removing preparations; hair straightening preparations; shaving preparations; depilatory preparations; nail care preparations; hair waving preparations; laundry soaking preparations; sun-tanning preparations [cosmetics]; make-up removing preparations; make-up preparations; shining preparations [polish]; laundry glaze; preparations to make the leaves of plants shiny; breath freshening preparations for personal hygiene; shoe polish; denture polishes; preparations for unblocking drain pipes; smoothing preparations [starching]; dry-cleaning preparations; dentifrices; preparations for cleaning dentures; wallpaper cleaning preparations; aloe vera preparations for cosmetic purposes; toiletry preparations; air fragrance reed diffusers; make-up powder; nail varnish removers; windscreen cleaning liquids; non-slipping liquids for floors; wax melts [fragrancng preparations]; eye-washes, not for medical purposes; saffrol; sachets for perfuming linen; baby wipes impregnated with cleaning preparations; antistatic dryer

sheets; tissues impregnated with cosmetic lotions; tissues impregnated with make-up removing preparations; colour run prevention laundry sheets; turpentine for degreasing; teeth whitening strips; breath freshening strips; soda lye; bath salts, not for medical purposes; sunscreen preparations; douching preparations for personal sanitary or deodorant purposes [toiletries]; canned pressurized air for cleaning and dusting purposes; double eyelid tapes; talcum powder, for toilet use; terpenes [essential oils]; tripoli stone for polishing; rose oil; toilet water; mascara; beard dyes; hair dyes; cosmetic dyes; phytocosmetic preparations; lipstick cases; colour-brightening chemicals for household purposes [laundry]; henna [cosmetic dye]; cleaning chalk; cleaning preparations; chemical cleaning preparations for household purposes; shampoos for pets [non-medicated grooming preparations]; shampoos for animals [non-medicated grooming preparations]; dry shampoos; shampoos; cobblers' wax; shoemakers' wax; sandpaper; smoothing stones; grinding preparations; false eyelashes; false nails.

(260) AM 2023 119865 A

(800) 1689830

(151) 2022 04 18

(891) 2022 04 18

(731) Sinochem Corporation

28 Fuxingmennei Street, Xicheng District,
Beijing, China

(540)



(591) Black, dark blue, light blue, white

(531) 05.05.16; 05.05.19; 05.05.20; 05.05.21;

26.13.25; 27.05.01; 28.03; 29.01.13

(511)

1 – Adhesives for industrial purposes; auxiliary fluids for use with abrasives; acetates (chemicals); acetone; acids; chemical additives to drilling muds; chemical additives to motor fuel; detergent additives to petrol; activated carbon; propellant gases for aerosols; agricultural chemicals, except fungicides, herbicides, insecticides and parasiticides; alkalies; alkaline-earth metals; alcohol; ethyl alcohol; aldehydes; seaweeds (fertilizers); chemical substances for preserving foodstuffs; chemical preparations for facilitating the alloying of metals; soil conditioning preparations; animal charcoal; antifreeze; anti-incrustants; size for use in the textile industry; engine-decarbonising chemicals; nitrogenous fertilizers; galvanizing baths; baryta; chemicals, except pigments, for the manufacture of enamel; benzene derivatives; benzoic acid; saccharin; concrete-aeration chemicals; biochemical catalysts; drilling muds; plasticizers; rubber preservatives; catalysts; cellulose; paper pulp; ketones; animal carbon

preparations; industrial chemicals; chemical preparations for scientific purposes, other than for medical or veterinary use; chemical reagents, other than for medical or veterinary purposes; chemical substances for analyses in laboratories, other than for medical or veterinary purposes; cement-waterproofing chemicals, except paints; citric acid for industrial purposes; preservatives for use in the pharmaceutical industry; chemical preparations for use in photography; leather-dressing chemicals; separating and unsticking [ungluing] preparations; oil-separating chemicals; gum solvents; distilled water; purification preparations; fertilizers; enzymes for industrial purposes; gas purifying preparations; esters; ethers; ethyl ether; stain-preventing chemicals for use on fabrics; fire extinguishing compositions; fireproofing preparations; fluorspar compounds; graphite for industrial purposes; foundry moulding preparations; chemical additives to insecticides; chemical additives to fungicides; fulling preparations; brake fluid; protective gases for welding; solidified gases for industrial purposes; horticultural chemicals, except fungicides, herbicides, insecticides and parasiticides; oil-purifying chemicals; textile-waterproofing chemicals; isotopes for industrial purposes; metal annealing preparations; chemical preparations to prevent mildew; hydrogen peroxide for industrial purposes; phenol for industrial purposes; plastics, unprocessed; protein (raw material); synthetic resins, unprocessed; refrigerants; salts (chemical preparations); seed preserving substances; sulfides; soldering chemicals; sulfuric acid; chemicals for use in forestry, except fungicides, herbicides, insecticides and parasiticides; calcium salts; surface-active chemical agents; preparations for preventing the tarnishing of glass; toluol; peat (fertilizer); alkaloids; aluminium acetate; colour-brightening chemicals for industrial purposes; chemicals for the manufacture of paints; biological preparations, other than for medical or veterinary purposes; sensitized films, unexposed; carbon black for industrial purposes; dispersions of plastics; artificial sweeteners (chemical preparations); water-purifying chemicals; filtering materials of chemical substances; plant growth regulating preparations; preparations of trace elements for plants; chemical intensifiers for rubber; chemical additives for oils; oil cement (putty); glucose for the food industry; lecithin for the food industry; lactose for the food industry; tea extracts for use in the manufacture of pharmaceuticals; antioxidants for use in the manufacture of pharmaceuticals; proteins for the food industry.

2 – Dyestuffs; pigments; food dyes; printing ink; paints; anti-corrosive preparations; mastic (natural resin); dyes; coatings (paints); mordants; protective preparations for metals; food dyes.

4 – Coal; fuel; wax (raw material); wax for lighting; industrial wax; coke; mineral fuel; dust removing preparations; gas for lighting; lubricating oil; petrol; diesel oil; fuel gas; oil-gas; kerosene; lubricants; naph-

tha; paraffin; petroleum, raw or refined; fuel oil; industrial oil; solidified gases (fuel); motor oil; electrical energy.

5 – Air purifying preparations; albuminous preparations for medical purposes; preparations for destroying noxious animals; mothproofing preparations; bacterial preparations for medical and veterinary use; biocides; capsules for medicines; pharmaceutical preparations; wadding for medical purposes; chemico-pharmaceutical preparations; compresses; vitamin preparations; chemical conductors for electrocardiograph electrodes; solutions for contact lenses; cotton for medical purposes; vaccines; teeth filling material; dental lacquer; dressings, medical; depuratives; drugs for medical purposes; fungicides; germicides; medicinal herbs; semen for artificial insemination; liquorice for pharmaceutical purposes; herbicides; nutritive substances for microorganisms; chemical preparations for treating wheat blight; sanitary towels; phenol for pharmaceutical purposes; parasiticides; herbal teas for medicinal purposes; soil-sterilizing preparations; veterinary preparations; vermin destroying preparations; acetates for pharmaceutical purposes; food for babies; biological preparations for medical purposes; gases for medical purposes; chemical preparations for pharmaceutical purposes; medicines for human purposes; medicines for veterinary purposes; isotopes for medical purposes; dietetic substances adapted for medical use; biological preparations for veterinary purposes; chemical preparations for medical purposes; chemical preparations for veterinary purposes; chemical reagents for medical or veterinary purposes; amino acids for medical purposes; amino acids for veterinary purposes; nutritional supplements; acaricides; antibiotics; dietary supplements for animals; protein dietary supplements; protein supplements for animals; pesticides; diapers for pets; disinfectants; surgical glues; medicated animal feed; diagnostic preparations for veterinary purposes; powdered milk for babies; plant extracts for pharmaceutical purposes; phytotherapy preparations for medical purposes; herbal extracts for medical purposes.

17 – Rubber, raw or semi-worked; flexible hoses, not of metal; insulating materials; junctions, not of metal, for pipes; adhesive bands, other than stationery and not for medical or household purposes; plastic substances, semi-processed; packing (cushioning, stuffing) materials of rubber or plastics; floating anti-pollution barriers; plastic sheeting for agricultural purposes; insulating refractory materials.

35 – Advertising; providing business information; providing commercial information and advice for consumers in the choice of products and services; commercial administration of the licensing of the goods and services of others; sales promotion for others; import-export agency services; provision of an online marketplace for buyers and sellers of goods and services; personnel management consultancy; systemize-

tion of information into computer databases; accounting; rental of vending machines; sponsorship search; rental of sales stands; retail services for pharmaceutical, veterinary and sanitary preparations and medical supplies.

36 – Insurance underwriting; providing financial information; art appraisal; real estate management; financial customs brokerage services; surety services; charitable fund raising; trusteeship; lending against security; financial research.

42 – Chemistry services; technological research; industrial design; material testing; meteorological information; geological prospecting; authenticating works of art; computer software design; dress designing; graphic arts design; quality control; biological research; cloud seeding; handwriting analysis (graphology); cartography services; business card design; graphic design of promotional materials; rental of meters for the recording of energy consumption.

(260) AM 2023 119866 A

(800) 1689831

(151) 2022 05 04

(891) 2022 05 04

(731) Sew-Eurodrive GmbH & Co KG

Ernst-Blickle-Str. 42, 76646 Bruchsal,
Germany

(540)



(591) Black and white

(531) 26.04.05; 27.05.01; 27.05.09; 27.05.10;

27.05.17

(511)

7 – Electric motors; asynchronous motors; synchronous motors; linear motors; reluctance motors; magnet wheel motors; eddy-current motors; ultrasonic motors; electrical lifting cylinders; motors with integrated inverter; compact drives; control units for machinery and motors; geared motors; gearboxes, other than for land vehicles; torque converters; reduction gears; servo gears; right-angle gear units; variable-speed gear units; industrial gear units; electric drives for electrified monorails; gear wheels for machines; electric generators; wind generators, namely for electricity charging stations; mechanical energy storages, namely flywheel energy storages; actuators; linear actuators; machine parts, namely controllers; housings for electric motors and reduction gears; machine parts, namely adapters; machine parts, namely stators; machine parts, namely swing bases; ventilators for machinery; cooling units for motors; machine parts, namely bearings; machine parts, namely gaskets; machine parts,

namely gasket rings; couplings; brakes for machines; magnetic brakes; eddy-current brakes; brake magnets; input shafts; electric roller drives; roller conveyors; parts of all aforesaid goods, as far as contained in class 7 (other than for land vehicles).

9 – Apparatus and instruments for conducting, switching, converting, storing, regulating and/or controlling electricity; inverters; exchange inverters; drive inverters; current converters; voltage converters; frequency converters; waveguides; hollow-core cable; slotted waveguide; electric coils; current coils for inductive power supply; regenerative power supply units; electronic controls; programmable logic controls; electric cables; electric connectors; electric wires; distributors for electric energy and/or information; electric facilities for the remote control of industrial operations; electric connection parts; electronic display panels; LCD-displays; LED-displays; operating terminals for controlling machines; remote controls; electronic and electro-technical measuring instruments; rotary speed sensors; encoders; incremental encoders; integrated circuits; semiconductors; electric and electronic control apparatus; sonic sensors; oil sensors; temperature sensors; structure-borne sound sensors; electronic publications (downloadable); electronic positioning controls; computer software for controlling machines; computer software for controlling industrial processes; computer software for monitoring industrial processes; computer software for planning electric drives; computer software for planning industrial facilities; software for data communication; software protocols for data communication; data bus protocols; safety-related data bus protocols; parameter boxes [machine-readable data collections]; opto-couplers; electro-optical converter; data bus converter; data bus cables; data bus plugs; field bus converter; fieldbus cables; fieldbus plugs; electronic nameplates for electric drives; PCs; lap-tops; industrial PCs, wireless devices; network devices; network devices for wireless networks; current transformers; devices for inductively contactless supplying and/or charging of electric drives, electric storages, and electric vehicles with electric energy, namely line conductors, pick-up coils, current converters, antennas, receiver, transceiver, charging mat; electric charging devices for charging of electric drives, electric storages and electric vehicles; energy storage aggregates; batteries; accumulators; capacitors; capacitor modules consisting of capacitor, housing and circuit board; charging cables; charging plugs; loading stations; electric charging stations for electric vehicles supplied from the general electricity network and/or from renewable energy sources (and parts and accessories thereof); solar cells in particular for electric charging stations; navigation devices for vehicles; navigation instruments; navigation instruments for industrial use; electronic parking assistants; bus bars; sonic cameras; parts of all aforesaid goods, as far as contained in class 9.

37 – Installation, assembly, maintenance, repair and upkeep of electronic, electric and/or mechanical drives and drive components; maintenance and replacement of brakes; machine-diagnosis; sound-analysis and structure-borne sound-analysis of electric drives; assembly service; start-up-support; installation service; lubrication control service; lubrication change service; maintenance of electric drives using photography and thermography; mobile maintenance service; project management for plant and mechanical engineering; placement of technicians within the framework of the organisation of repairs; conclusion of service and maintenance agreements; pick-up and delivery service of electric drives and electric drive components; vehicle retrofitting with electric drives and charging electronics.

(260) AM 2023 119868 A
 (800) 1689871
 (151) 2022 07 14
 (891) 2022 07 14
 (731) Raytron Technology Co., Ltd.
 No. 11, Guiyang Street, Development Zone,
 Yantai, Shandong, China
 (540)



(591) Black, white
 (531) 26.01.03; 26.01.19; 26.01.24; 27.05.01
 (511)
 9 – Detectors; temperature indicators; telescopes; chips [integrated circuits]; infrared sensors; photoelectric sensors; sensors for determining temperature; temperature sensors; remote sensors for use in measuring thermal and infrared radiation energy waves; vibration sensors; optical sensors; touchscreen sensors; motion sensors; electric sensors; alarm sensors; vehicle mounted GPS sensor for determining the rate of motion for a vehicle; theft prevention installations, electric; protection devices for personal use against accidents; electric and electronic video surveillance installations; thermal imaging cameras; infrared detectors; ultrasonic sensors; cell phones; radar apparatus; distance measuring apparatus; laser range finders; humanoid robots with artificial intelligence for use in scientific research; telepresence robots; security surveillance robots; smartglasses; computer software applications, downloadable; wearable video display monitors; camcorders; telescopic sights for artillery; navigational instruments; semi-conductors.

(260) AM 2023 119870 A
 (800) 1689895
 (151) 2022 08 19
 (891) 2022 08 19

(731) GHC Systems Inc.
 2-501 Cartwright Street, Saskatoon
 SK S7T 1E1, Canada

(540)



(591) Black, white
 (531) 27.05.01; 27.05.09; 27.05.10
 (511)
 3 – Hair shampoo and conditioner; styling products, namely hair repair tonics and treatments, hair shine oils, hair spray, smoothing cream, hair styling gels, pastes, waxes, pomades and creams, hair repair treatments, mousse for hairstyling, lotions for hair, hair curling and straightening chemicals, hair color.

(260) AM 2023 119871 A
 (800) 1689906
 (151) 2022 08 10
 (891) 2022 08 10
 (731) Gac Aion New Energy Automobile Co., LTD.
 No.36, Longying Road, Panyu District,
 Guangzhou, 511400 Guangdong, China
 (540)



(591) Black, white
 (531) 27.05.01; 27.05.17
 (511)
 7 – Shock absorbers [parts of machines]; bearings for vehicles; pistons [parts of machines or engines]; starters for motors and engines; carburettors; radiators [cooling] for automobile engines; machines for battery industry; shock absorbers for machines; starters for engines.
 12 – Driverless cars [autonomous cars]; cars; vehicle chassis; automobile chassis; gear boxes for land vehicles; clutches for land vehicles; gasoline engines for land vehicles; diesel engines for land vehicles; bodies for vehicles; jet engines for land vehicles; wheels for automobiles; hoods for vehicle engines; steering wheels for vehicles; upholstery for vehicles; caps for vehicle fuel tanks; tires for vehicle wheels; motorcycles; bicycles; bumpers for automobiles; air bags [safety devices for automobiles]; vehicles for locomotion by land, air, water or rail; remote control vehicles, other than toys; electric vehicles.

(260) AM 2023 119872 A
 (800) 1689936
 (151) 2022 09 12
 (891) 2022 09 12
 (731) Roxane and Dara Co.
 Land piece No. 826, No. 24, 2nd St., Azadi
 Boulevard, Kaveh Industrial City, Kaveh

Industrial Town, Taraz Nahid Village, Central District, Saveh, Markazi Province, Islamic Republic of Iran

(540)

NATURE LEAN

(591) Black, white

(531) 27.05.01

(526) NATURE

(511)

29 – Beans, preserved; soured milk, sweet cucumber, preserved; hazelnuts, prepared; peanut milk for culinary purposes; almond milk for culinary purposes; gelatin; rice milk; malt milk; nuts; powdered milk; processed lemons; processed eggplants; pickles; corn, preserved; fruit, processed; fruit, preserved; yogurt drink; shrimps, preserved; pickles, preserved; processed olives, preserved; salty olives, preserved; cooked rice, preserved; preserved pickles; salted okra, preserved; tomato, preserved; spinach, preserved; green beans, preserved; pea and lentils, preserved; mung bean, preserved; salty cucumber, preserved; mixed vegetables, tinned; mushrooms, preserved; beans and mushrooms, preserved; green peas, preserved; pinto beans, preserved; salty mushroom, preserved; banana, preserved; olives, preserved; marmalade; carbonated yogurt drink; non-carbonated yogurt drink; pinto beans, preserved in tomato sauce; onions, preserved; peas, preserved; soy milk; vegetable consommé; fruit milk; potatoes, preserved; low-fat potato chips; vegetable mousses; kefir; soy whey; soy cheese; soy drink; soy yogurt; concentrated fruit powder; powdered yogurt; albumin milk; protein milk; preserved peppers; dates, preserved; condensed milk; yogurt; vegetables, tinned; vegetables, dried; tomato paste; ginger jam; fruit preserved; dried fruits; carbonated yogurt or yogurt drink; jams; milk.

(260) AM 2023 119873 A

(800) 1689953

(151) 2022 08 25

(891) 2022 08 25

(731) AIMA Technology Group Co., LTD
No. 5 Aima Road, South Zone of Jinghai
Economic Development Zone, 300000,
Tianjin, China

(540)

SCOOX

(591) Black, white

(531) 27.05.17

(511)

12 – Motorcycles; cars; electric cars; bodies for vehicles; electric bicycles; electric tricycles; bicycles; bicycle frames; push scooters [vehicles]; self-balancing one-wheeled electric scooters; self-balancing two-wheeled electric scooters; trolleys; tyres for vehicle wheels; safety seats for children, for vehicles.

(260) AM 2023 119877 A

(800) 1456541

(151) 2018 10 18

(891) 2022 09 15

(731) OMT Belforte S.R.L.

Via Madonna d'Antegiano 2, I-62031 Belforte
Del Chienti (MC), Italy

(540)



(591) Black, white

(531) 24.15.02; 27.05.22

(511)

7 – Electric coffee grinders; power-operated coffee grinders; electrical appliances used in kitchen for milling; pepper mills, other than hand-operated; spice grinders (electric -); food processors, electric; electric kitchen appliances for chopping, mixing, pressing; kitchen machines, electric; electric kitchen tools; electric coffee frothers; electric milk frothers; beverage making machines; electric mixers for household purposes; food preparation machines, electromechanical; food whisks (electric -); electric food blenders; graters, electric; vending machines.

11 – Coffee percolators, electric; espresso machines, electric; coffee machines, electric; electric wireless coffee pots; automatic installations for making coffee; coffee roasters; coffee roasting ovens; electric coffee filters; coffee roasting machines; electric chocolate makers; heating and cooling apparatus for dispensing hot and cold beverages; apparatus for keeping hot drinks warm; thermoelectric apparatus for heating beverages; refrigerated dispensing units for beverages; beverage cooling apparatus; refrigerating apparatus and machines; refrigerators; apparatus for heating, steam generating, cooking, drying and water supply.

(260) AM 2023 119878 A

(800) 1458072

(151) 2018 10 18

(891) 2022 09 15

(731) OMT Belforte S.R.L.

Via Madonna d'Antegiano 2, I-62031 Belforte
Del Chienti (MC), Italy

(540)



(591) Black, white

(531) 03.07.17; 27.05.01

(511)

7 – Electric coffee grinders; power-operated coffee grinders; electrical appliances used in kitchen for milling; pepper mills, other than hand-operated; spice grinders (electric -); food processors, electric; electric

kitchen appliances for chopping, mixing, pressing; kitchen machines, electric; electric kitchen tools; electric coffee frothers; electric milk frothers; beverage making machines; electric mixers for household purposes; food preparation machines, electromechanical; food whisks (electric -); electric food blenders; graters, electric; vending machines.

11 – Coffee percolators, electric; espresso machines, electric; coffee machines, electric; electric wireless coffeepots; automatic installations for making coffee; coffee roasters; coffee roasting ovens; electric coffee filters; coffee roasting machines; electric chocolate makers; heating and cooling apparatus for dispensing hot and cold beverages; apparatus for keeping hot drinks warm; thermoelectric apparatus for heating beverages; refrigerated dispensing units for beverages; beverage cooling apparatus; refrigerating apparatus and machines; refrigerators; apparatus for heating, steam generating, cooking, drying and water supply.

(260) AM 2023 119879 A

(800) 1666849

(151) 2022 03 25

(891) 2022 09 21

(731) Aeroports De Paris

1 rue de France, F-93290 Tremblay-En-France, France

(540)



(591) Blue, white

(531) 26.04.07; 26.04.12; 27.05.01; 29.01.04

(511)

9 – Software; application software; data processing software; software for creating, managing, updating and using databases; software and applications in the field of transport and indication of routes, parking, booking of services for people, booking of catering services; automatic dispensers for tickets, cards, passenger tickets; equipment for data processing and computers; multimedia terminals; magnetic or optical data media; recording media for sound, images and data, in particular, sound recording disks, compact disks (audio, video, multimedia); memory or microprocessor or magnetic or chip cards, bank cards; access control apparatus; magnetic and electronic access cards, magnetic and electronic traffic cards for transport networks.

35 – Administrative management of airports; organizational management of airports; assistance with the management of business activities; commercial management of shops at airports; recruitment of ground crew for airports; airport personnel management ser-

vices; advertising services in airports; providing commercial information about products and services to customers; advertising; dissemination of advertisements and advertising material; promoting the products and services of others through loyalty reward card programs; loyalty programs; retail, especially in duty-free shops, of soap, perfumes, cosmetics, lotions for the hair, dentifrices, make-up removing products, razors, shaving products, herbal teas, pharmaceutical products, sanitary towels, cameras, video cameras, compact discs, DVDs, Blu-ray discs, integrated circuit cards (smart cards), computers, computer peripheral devices, tablet computers, e-readers, telephones, smartphones, headphones, software (recorded programs), spectacles, eyewear, diving masks, bags adapted for laptops, smartwatches, electric batteries, ventilation apparatus, flashlights, fine jewelry, jewelry, horological and chronometric instruments, watches, watch cases, novelty key rings, musical instruments, printed matter, photographs, stationery, cards, books, newspapers, brochures, calendars, handkerchiefs of paper, face towels of paper, toilet paper, bags (envelopes, pouches) of paper or plastic materials for packaging, trunks and suitcases, umbrellas and parasols, walking sticks, wallets, purses, credit card holders (wallets), bags, vanity cases, not fitted, collars for animals, clothing for animals, mirrors (looking glasses), cushions, boxes of wood or plastic, household utensils, kitchen utensils, combs, brushes (except paint brushes), bottles, toiletry utensils, toiletry cases, glasses (receptacles), crockery, bags (envelopes, pouches) of textile, for packaging, household linen, table linen not of paper, bath linen except clothing, clothing, footwear, headwear, artificial plants, games, toys, video game consoles, controllers for video game consoles, decorations and party ornaments and artificial Christmas trees, balls for games, card games, board games, scooters (toys), sporting articles and equipment, models (toys), figurines (toys), meat, preserved fruits, dried fruits, cooked fruits, preserved vegetables, dried vegetables, cooked vegetables, jellies, jams, compotes, milk products, edible oils and fats, charcuterie, crustaceans (not live), canned meat, canned fish, cheese, milk beverages with milk predominating, coffee, tea, cocoa, sugar, rice, preparations made from cereals, bread, pastry, confectionery, edible ices, honey, salt, mustard, sauces (condiments), spices, sandwiches, pasta, pizzas, pancakes (foodstuffs), cookies (biscuits), cakes, sugar confectionery, chocolate, cocoa-based beverages, coffee-based beverages, tea-based beverages, fresh fruits, fresh vegetables, plants, beers, mineral waters (beverages), carbonated waters, fruit-based beverages, preparations for making beverages, lemonades, soda waters, alcohol-free aperitifs, alcoholic beverages, wines, tobacco, articles for smokers, electronic cigarettes; information and consulting services concerning the aforesaid services.

39 – Airport services; providing airport installations for aviation; transport services; airport transfer servi-

ces; airport check-in services; booking and organizing access to airport lounges; ground traffic control services for aircraft; loading and unloading of airplanes; airport baggage handling; ground assistance services provided at airports in the framework of handling freight; airport parking services; information and consulting services concerning the aforesaid services; travel organization services; travel guide and traveler escort services; escorting of travelers; providing travel information; providing flight arrival and departure information.

43 – Services for providing food and beverages; temporary accommodation; accommodation agencies (hotels, boarding houses); bar services; coffee shops; caf terias; day-nurseries [cr ches]; hotel services; hotel reservation; self-service restaurants; rental of temporary accommodation; rental of meeting rooms; temporary accommodation reservation; fast-food restaurants, snack bars; providing food and beverages (meals).

(260) AM 2023 119918 A

(800) 1690018

(151) 2022 05 19

(891) 2022 05 19

(731) Euro Games Technology Ltd.

4, "Maritsa" Str., "Vranya-Lozen-

Triugulnika", BG-1151 Sofia, Bulgaria

(540)

Burning Hit

(591) Black, white

(511)

9 – Software; computer gaming software; computer software packages; computer operating system software; computer software, recorded; software drivers; virtual reality software; games software; entertainment software for computer games; computer programs for network management; operating computer software for main frame computers; monitors (computer hardware); computer hardware; apparatus for recording images; monitors (computer programs); computer game programs; computer programs for recorded games; apparatus for recording, transmission or reproduction of sound or images; communications servers [computer hardware]; electronic components for gambling machines; computer application software featuring games and gaming; computer software for the administration of on-line games and gaming; computer hardware for games and gaming; hardware and software for gambling, gambling machines, gambling games on the Internet and via telecommunication network.

28 – Gaming machines for gambling; chips for gambling; mah-jong; arcade games; gambling machines operating with coins, notes and cards; games; electronic games; parlor games; gaming chips; gaming tab-

les; slot machines [gaming machines]; LCD game machines; slot machines and gaming devices; coin-operated amusement machines; roulette chips; poker chips; chips and dice [gaming equipment]; gaming equipment for casinos; roulette tables; gaming roulette wheels; casino games; gambling machines and amusement machines, automatic and coin-operated; coin-operated amusement machines and/or electronic coin-operated amusement machines with or without the possibility of gain; boxes for coin-operated machines, slot machines and gaming machines; electronic or electrotechnical amusement machines and apparatus, gaming machines, coin-operated entertainment machines; housings for coin-operated machines, gaming equipment, gaming machines, machines for gambling; electropneumatic and electrical gambling machines (slot machines).

41 – Gambling; entertainment services related to gambling; gaming services for entertainment purposes; casino, gaming and gambling services; training in the development of software systems; provision of gaming equipment for gambling halls; providing casino equipment [gambling]; gaming machine entertainment services; providing casino facilities [gambling]; gaming hall services; amusement arcade services; games equipment rental; rental of gaming machines; providing amusement arcade services; rental of gaming machines with images of fruits; editing or recording of sounds and images; sound recording and video entertainment services; hire of sound reproducing apparatus; provision of gaming equipment for casinos; providing of casino facilities; online gambling services; casino, gaming and gambling services; provision of gaming facilities, gaming hall facilities, Internet casinos and online gambling services.

(260) AM 2023 119919 A

(800) 1690036

(151) 2022 03 02

(891) 2022 03 02

(731) ASOS Holdings Limited

Greater London House, Hampstead Road,

London NW1 7FB, United Kingdom

(540)

MISS SELFRIDGE

(591) Black, white

(511)

25 – Clothing, footwear, headwear; outerwear; sportswear; activewear; overcoats; coats; jackets; mantillas; parkas; pelerines; ponchos; anoraks; dresses; skirts; ball gowns; prom dresses; lace dresses; wedding dresses; embroidered dresses; bridesmaid dresses; tea dresses; satin dresses; jerseys; jumper dresses; knitwear; jumpers; cardigans; pullovers; sweaters; hooded tops; hooded sweatshirts; sweatshirts; suits; uniforms; suits; wedding suits; cummerbunds; blouses; shirts; shirt fronts; short-sleeve shirts; t-shirts; tee-shirts; po-

lo shirts; tops; tunics; trousers; pants; jeans; dungarees; shorts; jogging pants; chinos; trouser straps; braces; clothing of imitations of leather; clothing of leather; clothing of synthetic leather; bandanas; caps; beanies; berets; scarves; shower caps; earmuffs; hats; paper hats; headbands; hoods; cap peaks; top hats; turbans; veils; scarfs; shawls; ready-made clothing; shoes; boots; sandals; trainers; sneakers; leather shoes; suede shoes; heeled shoes; canvas footwear; beach shoes; footmuffs; non-slipping devices for footwear; tips for footwear; heelpieces for footwear; half-boots; heels; lace boots; slippers; soles for footwear; inner soles; footwear uppers; boot uppers; flip-flops for use as footwear; sliders being footwear; belts; money belts; bibs (not of paper); brassieres; camisoles; corsets; capes; bodices; dressing gowns; bath robes; layettes; petticoats; slips; morning coats; wristbands; collars; detachable collars; articles made from faux fur, namely, clothing, footwear and headgear; gloves; mittens; muffs; leggings; leg warmers; hosiery; socks; stocking suspenders; stockings; tights; tutus; leotards; ready-made linings; sleep masks; face masks [clothing]; face coverings [clothing]; neckties; ties; bow ties; playsuits; jumpsuits; pocket squares; pockets for clothing; lingerie; underpants; underwear; bralettes; lace underwear; satin underwear; satin sleepwear; satin camisoles; velvet camisoles; nightwear; loungewear; pyjamas; nighties; sleepsuits; saris; sarongs; togas; shoulder wraps for clothing; beachwear; swimwear; swimsuits; bathing trunks; swimming costumes; bikinis; bikini tops; waistcoats; vests; tank tops; base layer clothing; bodysuits; coordinates [clothing]; costumes; fancy dress costumes; aprons; tracksuits; football clothing; football kits (football uniform); replica football kits; football boots [shoes]; studs for football boots [shoes]; socks for football; sportswear, including sportswear for football, five-a-side football, volleyball, rugby, basketball, tennis, skiing, golf, baseball, running, gymnastics and exercise in general, not included in other classes; clothing for dance; sports shoes; ballet shoes; jazz shoes; articles of golf clothing; golf shorts; golf shirts; golf caps; golf trousers; moisture-wicking sports pants; moisture-wicking sports shirts; sports bras; moisture-wicking sports bras; articles of clothing, footwear, headgear.

(260) AM 2023 119920 A
 (800) 1690101
 (151) 2022 08 03
 (891) 2022 08 03
 (731) Kosters Olha Mykhailivna
 Prospekt Nauky, 34, kv. 22, m. Kyiv 03028,
 Ukraine

(540)



(591) Pink and white
 (531) 27.05; 27.05.01; 29.01.01
 (511)
 3 – Nail polish, including gel nail polishes; nail art stickers.

(260) AM 2023 119921 A
 (800) 1690114
 (151) 2022 08 31
 (891) 2022 08 31
 (731) DAW SE
 Roßdörfer Str. 50, 64372 Ober-Ramstadt,
 Germany
 (540)

CapaGreen

(591) Black, white
 (511)
 2 – Paints, varnishes, lacquers, glazes, coatings, preservatives against rust; primers; colorants, dyestuffs, dye pastes, mordants; paint thickeners; fixatives for paints; siccatives for paints; raw natural resins; thinning and binding preparations for paints and lacquers; solvents for thinning paints; preparations for preserving wood, wood mordants and wood preserving oils; paints, including structuring paints; bactericidal and/or fungicidal paints; anti-corrosion preparations; protective preparations for metals; metals in foil and powder form for painters, decorators, printers and artists.

17 – Sealing, thermal protection and insulating materials; insulating paints, insulating varnishes, insulating fabrics, insulating plaster; substances for insulating buildings against moisture; artificial and synthetic resins (semi-finished products); fabrics in the form of parts for composite heat insulation systems; insulating tapes; heat insulators; insulating panels; grid mats of glass fiber fabric and/or plastics, in the form of parts for composite heat insulation systems; plastic films, other than for wrapping purposes; adhesive tapes and strips for building.

19 – Building materials, not of metal or mainly not of metal, in particular profile rails and corner irons, finishing profiles; adjusting and levelling parts, spacers for building, sills, all not of metal or mainly not of metal; natural and artificial stone; mortar (building materials); quartz; plaster [building materials]; coatings

(building materials); wall and ceiling panels (not of metal or mainly not of metal, for building); fabric embedding compounds for building; fillers (building materials); fabrics for building, not of metal or mainly not of metal, in particular stabilising fabrics.

24 – Textile wall hangings; non-woven fabrics; fabrics for textile use.

27 – Wall hangings (non-textile), even structuring in connection with paints; wallpaper.

37 – Painting; constructions; construction consultancy; building insulating; scaffolding; wallpapering; consultancy with regard to the use of paints, plasters and other coating materials in the construction industry.

42 – Architectural services; consultancy in the field of energy-saving; architectural consultancy with regard to the interior and exterior color designing for buildings (buildings and constructions).

(260) AM 2023 119923 A

(800) 1690245

(151) 2022 04 16

(891) 2022 04 16

(731) Ceren İthalat Ve Dağıtım Anonim Şirketi
İkitelli OSB. Eski Turgut Özal Cd., Haseyad
1. Kısım 25 101 Başakşehir, İstanbul,
2. Türkiye

(540)



(591) Red.

(531) 03.13.01; 03.13.24; 27.05.01; 27.05.10;
27.05.22; 29.01.12

(511)

16 – Printing blocks and types; bookbinding material; printed publications; printed matter; books, magazines, newspapers, bill books, printed dispatch notes, printed vouchers, calendars; posters; photographs [printed]; paintings; stickers [stationery]; postage stamps; stationery, office stationery, instructional and teaching material [except furniture and apparatus]; writing and drawing implements; artists' materials; paper products for stationery purposes; adhesives for stationery purposes, pens, pencils, erasers, adhesive tapes for stationery purposes, cardboard cartons [artists' materials], writing paper, copying paper, paper rolls for cash registers, drawing materials, chalkboards, painting pencils, watercolors [paintings]; office requisites.

28 – Games and toys; arcade video game machines; game apparatus and machines for use with an external display screen and monitor, including those coin-

operated; toys for animals; toys for outdoor playgrounds, parks and game parks; gymnastic and sporting articles not included in other classes; fishing tackle, artificial fishing bait, decoys for hunting and fishing; Christmas trees of artificial material, ornaments for Christmas trees, artificial snow for Christmas trees, rattles (playthings), novelties for parties, dances (party favors), paper party hats.

(260) AM 2023 119924 A

(800) 1690256

(151) 2022 09 22

(891) 2022 09 22

(731) Roche Diagnostics GmbH
Sandhofer Strasse 116, 68305 Mannheim,
Germany

(540)

COBAS EVOLVE

(591) Black, white

(511)

9 – Scientific instrument and apparatus; laboratory instruments for use in research and science; laboratory instruments for research and diagnostic purposes; laboratory apparatus for pre-analytical and post-analytical treatment of samples for scientific purposes; laboratory equipment, namely automated sample handling equipment; computer hardware and software for medical and diagnostic purposes; computer software for the provision of automated diagnostic laboratory processes; computer software and hardware for use with laboratory instruments, namely, for use in providing remote automated control, connection, data analysis, and data management.

(260) AM 2023 119925 A

(800) 1690257

(151) 2022 09 22

(891) 2022 09 22

(731) Roche Diagnostics GmbH
Sandhofer Strasse 116, 68305 Mannheim,
Germany

(540)

COBAS BOOST

(591) Black, white

(511)

9 – Scientific instrument and apparatus; laboratory instruments for use in research and science; laboratory instruments for research and diagnostic purposes; laboratory apparatus for pre-analytical and post-analytical treatment of samples for scientific purposes; laboratory equipment, namely automated sample handling equipment; computer hardware and software for medical and diagnostic purposes; computer software for the provision of automated diagnostic laboratory processes; computer software and hardware for use with laboratory instruments, namely, for use in pro-

viding remote automated control, connection, data analysis, and data management.

(260) AM 2023 119926 A

(800) 1690307

(151) 2022 08 08

(891) 2022 08 08

(731) Viorica – Cosmetic S.A.

Str. Mesager nr. 1, MD-2069 Chişinău,

Republic of Moldova

(540)

COSMEPLANT

(591) Black, white

(531) 27.05.01

(511)

3 – Non-medicated cosmetics and toiletry preparations; non-medicated dentifrices; perfumery, essential oils; bleaching preparations and other substances for laundry use; cleaning, polishing, scouring and abrasive preparations.

5 – Disinfectants; medicated shampoos, sanitary preparations for personal hygiene, other than toiletries; medicated soaps, medicated lotions and toothpastes.

(260) AM 2023 119936 A

(800) 1690586

(151) 2022 03 28

(891) 2022 03 28

(731) Uždaroji akcinė bendrovė "Umaras"

Pramonės g. 19A, Utena, Lithuania

(540)



(591) Green and grey

(531) 25.01.09; 26.04.04; 26.04.05; 26.04.18;

27.05.01; 27.05.09; 27.05.10; 29.01.13

(511)

17 – Cellulose acetate, semi-processed; acrylic glass, semi-processed; acrylic resins, semi-processed; carbon fibres, other than for textile use; asbestos safety curtains; asbestos; asbestos fabrics; asbestos coverings; asbestos packing; asbestos millboards; asbestos sheets; asbestos cloth; asbestos fibres; asbestos paper; asbestos felt; asbestos slate; balata; canvas hose pipes; foil of regenerated cellulose, other than for wrapping; chemical compositions for repairing leaks; cylinder jointings; dielectrics [insulators]; synthetic resins, semi-processed; ebonite; ebonite moulds; elastic yarns, other than for textile use; paper for electrical capacitors; insulators for electric mains; soundproofing materials; insulators for railway tracks; lute; shock-absorbing buffers of rubber; padding materials of rubber or plastics; door stops of rubber; rubber stoppers; win-

dow stops of rubber; bags [envelopes, pouches] of rubber, for packaging; threads of rubber, other than for textile use; clack valves of rubber; rings of rubber; stops of rubber; dock bumpers of rubber; rubber sleeves for protecting parts of machines; cords of rubber; padding materials of rubber or plastics; packing [cushioning, stuffing] materials of rubber or plastics; washers of rubber or vulcanized fibre; rubber material for recapping tyres; gutta-percha; foam supports for flower arrangements [semi-finished products]; insulating fabrics; insulating paints; insulating varnish; insulating paper; insulating inks; fibreglass for insulation; insulating plaster; insulating felt; foils of metal for insulating; insulating bands; insulating materials; insulating gloves; insulating refractory materials; insulators; expansion joint fillers; insulators for cables; cotton wool for packing [caulking]; caulking materials; boiler composition to prevent the radiation of heat; rubber solutions; watering hose; latex [rubber]; self-adhesive tapes, other than stationery and not for medical or household purposes; adhesive bands, other than stationery and not for medical or household purposes; mineral wool [insulator]; gum, raw or semi-worked; valves of india-rubber or vulcanized fibre; rubber, raw or semi-worked; flexible hoses, not of metal; junctions, not of metal, for pipes; fittings, not of metal, for compressed air lines; reinforcing materials, not of metal, for pipes; fittings, not of metal, for flexible pipes; fittings, not of metal, for rigid pipes; pipe mufflers, not of metal; organic glass, semi-processed; substances for insulating buildings against moisture; plastic filaments for 3d printing; threads of plastic for soldering; threads of plastic materials, other than for textile use; filtering materials of semi-processed films of plastic; plastic sheeting for agricultural purposes; plastic substances, semi-processed; plastic fibres, other than for textile use; plastic film, other than for wrapping; weatherstripping compositions; draught excluder strips; floating anti-pollution barriers; filtering materials of semi-processed foams of plastic; water-tight rings; clutch linings; synthetic rubber; synthetic resins, semi-processed; liquid rubber; brake lining materials, partly processed; rubber seals for jars; fibreglass fabrics for insulation; glass wool for insulation; sealant compounds for joints; gaskets; anti-glare films for windows [tinted films]; hoses of textile material; insulating oil for transformers; connecting hose for vehicle radiators; duct tapes; pipe gaskets; water-tight rings; waterproof packings; viscose sheets, other than for wrapping; vulcanized fibre; non-conducting materials for retaining heat; compositions to prevent the radiation of heat; slag wool [insulator]; bark coverings for sound insulation; mica, raw or partly processed.

35 – Payroll preparation; business management of performing artists; rental of office equipment in co-working facilities; rental of office machines and equipment; book-keeping; negotiation of business contracts for others; wholesale services for pharmaceu-

tical, veterinary and sanitary preparations and medical supplies; data search in computer files for others; data processing services [office functions]; economic forecasting; arranging subscriptions to electronic toll collection [etc] services for others; financial auditing; photocopying services; rental of photocopying machines; writing of curriculum vitae for others; import-export agency services; compiling indexes of information for commercial or advertising purposes; compilation of information into computer databases; systemization of information into computer databases; online retail services for downloadable and pre-recorded music and movies; online retail services for downloadable ring tones; online retail services for downloadable digital music; provision of an online marketplace for buyers and sellers of goods and services; online ordering services in the field of restaurant take-out and delivery; price comparison services; cash register rental; administration of consumer loyalty programs; commercial or industrial management assistance; commercial intermediation services; organization of trade fairs; conducting of commercial events; commercial information and advice for consumers in the choice of products and services; commercial lobbying services; commercial information agency services; provision of commercial and business contact information; updating and maintenance of data in computer databases; computerized management of medical records and files; computerized file management; competitive intelligence services; corporate communications services; interim business management; arranging newspaper subscriptions for others; business management for freelance service providers; reception services for visitors [office functions]; organization of fashion shows for promotional purposes; layout services for advertising purposes; retail services for pharmaceutical, veterinary and sanitary preparations and medical supplies; retail services relating to bakery products; retail services for works of art provided by art galleries; administrative services for medical referrals; modelling for advertising or sales promotion; tax preparation; tax filing services; news clipping services; opinion polling; gift registry services; search engine optimization for sales promotion; auctioneering services; rental of sales stands; shop window dressing; exhibitions for commercial or advertising purposes; outsourcing services [business assistance]; distribution of samples; personnel recruitment; personnel management consultancy; lead generation services; transcription of communications [office functions]; promotion of goods and services through sponsorship of sports events; sales promotion for others; presentation of goods on communication media, for retail purposes; promotion of goods through influencers; demonstration of goods; administrative processing of purchase orders; negotiation and conclusion of commercial transactions for third parties; marketing in the framework of software publishing; psychological testing for the selection of personnel; radio advertising; registra-

tion of written communications and data; updating and maintenance of information in registries; advertising; pay per click advertising; direct mail advertising; production of advertising films; dissemination of advertising matter; writing of publicity texts; publication of publicity texts; development of advertising concepts; publicity material rental; updating of advertising material; advertising agency services; rental of advertising time on communication media; advertising services to create brand identity for others; advertising by mail order; consultancy regarding advertising communication strategies; rental of billboards [advertising boards]; rental of advertising space; marketing; influencer marketing; market studies; market intelligence services; marketing research; media relations services; sponsorship search; employment agency services; cost price analysis; scriptwriting for advertising purposes; secretarial services; business consulting services for digital transformation; bill-posting; administration of frequent flyer programs; rental of vending machines; typing; compilation of statistics; business project management services for construction projects; shorthand; appointment scheduling services [office functions]; appointment reminder services [office functions]; drawing up of statements of accounts; invoicing; word processing; telephone answering for unavailable subscribers; providing telephone directory information; telephone switchboard services; arranging subscriptions to telecommunication services for others; production of teleshopping programmes; telemarketing services; television advertising; procurement services for others [purchasing goods and services for other businesses]; targeted marketing; commercial administration of the licensing of the goods and services of others; outsourced administrative management for companies; providing user reviews for commercial or advertising purposes; consumer profiling for commercial or marketing purposes; providing user rankings for commercial or advertising purposes; business auditing; business efficiency expert services; business information; providing business information via a web site; business investigations; business appraisals; business organization consultancy; business inquiries; preparation of business profitability studies; business consulting; business intermediary services relating to the matching of potential private investors with entrepreneurs needing funding; business intermediary services relating to the matching of various professionals with clients; business research; business management of sports people; business management and organization consultancy; business management consultancy; business management assistance; advisory services for business management; online advertising on a computer network; outdoor advertising; business management of hotels; public relations services; consultancy regarding public relations communication strategies; web site traffic optimization; web indexing for commercial or advertising purposes; the bringing together, for the benefit of

others (excluding the transport thereof) of plastic films, plastic packaging, plastic products, enabling customers to conveniently view and purchase those goods in retail or wholesale stores, via mail order catalogs or by electronic means on websites or teleshopping.

(260) AM 2023 119941 A
 (800) 1690665
 (151) 2022 09 16
 (891) 2022 09 16
 (731) VAMED Aktiengesellschaft
 Stengasse 5, A-1230 Wien, Austria
 (540)



(591) Black, dark blue, light blue, white
 (531) 01.05.02; 20.05.07; 26.11.11; 26.11.22;
 27.05.10; 29.01.12

(511)
 9 – Computer software relating to the medical field; software and applications for mobile devices; computer software for use in medical decision support systems; none of the goods for platforms for app development.

41 – Education and instruction services; training services for medical visitors.

44 – Medical services; mobile medical clinic services; rental of equipment for human healthcare.

(260) AM 2023 119942 A
 (800) 1690756
 (151) 2022 06 03
 (891) 2022 06 03
 (731) Fashion Co Doo, Beograd (Novi Beograd)
 Bulevar Mihajla Pupina 115b, 11000 Beograd,
 Serbia
 (540)



(591) Black and burgundy PANTONE 7427C
 (531) 24.17.09; 24.17.25; 27.05.08; 27.05.17;
 27.05.21; 29.01.12

(511)
 3 – Bleaching preparations and other substances for laundry use, cleaning, polishing, degreasing and abrasive preparations, cleaning preparations and oils, preservatives for leather (polishes), leather bleaching preparation, polishing creams, creams for leather, shoe polish, wax for furniture, wax for cobblers; perfumery; perfumes; eaux de toilette; eaux de parfum, eaux de Cologne, perfume bases, flower extracts, essential oils; air fragrancing preparations, scented potpourris, incense; cosmetic preparations for skin and lip care; cosmetic preparations for slimming; lotions for cosmetic use, beauty masks, cosmetic preparations for the hands, face and body; hair care products, hair lotions, hair bleaches, hair dyes, hair creams or hair-styling gels; hair sprays, depilatory creams, depilatory waxes; shaving products, shaving soaps, shaving foams, after-shave products; sun protection products for cosmetic use, preparations for cosmetic use for tanning, self-tanning preparations for cosmetic use, toiletries, dentifrices, soaps, shampoos, shower gels, bath gels, bath oils, bath salts, bath foams, bath pearls, talcum powder for toilet use, cleansing milks, deodorants, make-up products, lipsticks, mascara, make-up, make-up powders, eye shadows, make-up pencils, make-up removing products, decorative transfers for cosmetic use, temporary tattoos for the body and nails, cosmetic kits mainly containing mascara, lipsticks, eyebrow pencils, makeup, make-up foundation and lip gloss, nail care and styling products, nail polish, lacquered nail polish, nail polish removers [cosmetics], false nails for the hands and feet, false nail kit, adhesives for false nails.

16 – Articles of paper or cardboard, particularly bags and paper for packaging, bags and boxes of paper or cardboard, hat boxes of paper, aquarelles, drawings, stage scenery, architectural models; printed matter, particularly posters, albums, atlases, brochures, geographical maps, postcards, catalogs, non-textile labels, printed material, books, newspapers, periodicals, magazines, diaries, adhesive tapes; bookbinding articles, photographs; stationery, particularly pads of paper, drawing pads, blotting papers, note books, calendars, notepads, envelopes, writing paper, indexes; adhesives for stationery and household use; modeling materials for artists; paintbrushes; typewriters and office requisites (with the exception of furniture), particularly slates, ink pads, letter trays, letter openers, pencils, writing boards, inkwells, paperweights, pencil holders, pens, balls and nibs for pens; instructional or teaching material (except apparatus); small bags [envelopes, pouches] of plastic materials for packaging [not included in other classes]; printing type; printing blocks.

18 – Leather and imitations of leather; trunks and suitcases, traveling bags, sports bags; handbags; backpacks, beach bags, school bags, satchels, shopping bags; trunks, suitcases for clothing and footwear; a-

taché cases and briefcases, attaché cases for documents (leather goods); handbags, wallets, business card cases in the form of wallets, pouches not of precious metals, key cases (leather goods); boxes of leather or imitation leather; suitcase sets (leatherware), toiletry bags, not fitted; pouches of leather, clutch bags [handbags]; parasols; umbrellas; clothing for animals, animal carriers [bags].

25 – Clothing; tee-shirts; shirts; short-sleeved shirts, overalls; overalls; jackets and pullovers; jerseys (clothing); knitwear (clothing); coats; blousons; anoraks; raincoats; overcoats; ponchos; suits; combinations (clothing); dresses, skirts, skorts; shorts; trousers; briefs; leggings (trousers); lingerie and underwear; pajamas; nightgowns; dressing gowns (robes); dressing gowns; bathing suits for women; bathing suits for men; corsets (underwear); collars (clothing); detachable collars; Ascot ties; cuffs (clothing); kimonos; layettes (clothing); belts (clothing); money belts [clothing]; scarves and long scarves; shawls; stoles; bandanas (neckerchiefs); pocket squares; neckties; suspenders; gloves (clothing); fingerless gloves; fingerless gloves; muffs (clothing); ear muffs (clothing); scarves and neck warmers; headwear; hats; stocking caps; bandeaux (clothing); caps; visors; socks; stockings; tights; sleep masks; footwear; pocket squares; shoes; sports shoes; boots; ankle boots; esparto shoes or sandals; sandals; gaiters; snow boots; mules and slippers.

35 – Retail services for perfumery, clothing, footwear and headwear, textile products, products of leather or imitation leather, bags, spectacles and sunglasses, jewelry, timepieces and chronometric instruments; online retail services, rendered via the global computer network, offering perfumery, clothing, footwear and headwear, textile products, products of leather or imitation leather, bags, spectacles and sunglasses, jewelry, timepieces and chronometric instruments; advertising and promotional services, particularly via electronic means; rental of advertising space; publication of advertising texts; direct mail advertising; advertising online on the computer network; opinion polling, market studies, services related to commercial promotional activity in all its forms, particularly sponsorship and exhibition services and information and promotional campaigns.

(260) AM 2023 119943 A

(800) 1690757

(151) 2022 06 03

(891) 2022 06 03

(731) Fashion Co Doo, Beograd (Novi Beograd)

Bulevar Mihajla Pupina 115b, 11000 Beograd, Serbia

(540)

FASHION&FRIENDS

(591) Black and burgundy Pantone 7427C

(531) 24.17.09; 24.17.25; 27.05.17; 29.01.12

(511)

3 – Bleaching preparations and other substances for laundry use, cleaning, polishing, degreasing and abrasive preparations, cleaning preparations and oils, preservatives for leather (polishes), leather bleaching preparation, polishing creams, creams for leather, shoe polish, wax for furniture, wax for cobblers; perfumery; perfumes; eaux de toilette; eaux de parfum, eaux de Cologne, perfume bases, flower extracts, essential oils; air fragrancing preparations, scented pot-pourris, incense; cosmetic preparations for skin and lip care; cosmetic preparations for slimming; lotions for cosmetic use, beauty masks, cosmetic preparations for the hands, face and body; hair care products, hair lotions, hair bleaches, hair dyes, hair creams or hair-styling gels; hair sprays, depilatory creams, depilatory waxes; shaving products, shaving soaps, shaving foams, after-shave products; sun protection products for cosmetic use, preparations for cosmetic use for tanning, self-tanning preparations for cosmetic use, toilettries, dentifrices, soaps, shampoos, shower gels, bath gels, bath oils, bath salts, bath foams, bath pearls, talcum powder for toilet use, cleansing milks, deodorants, make-up products, lipsticks, mascara, make-up, make-up powders, eye shadows, make-up pencils, make-up removing products, decorative transfers for cosmetic use, temporary tattoos for the body and nails, cosmetic kits mainly containing mascara, lipsticks, eyebrow pencils, makeup, make-up foundation and lip gloss, nail care and styling products, nail polish, lacquered nail polish, nail polish removers [cosmetics], false nails for the hands and feet, false nail kit, adhesives for false nails.

16 – Articles of paper or cardboard, particularly bags and paper for packaging, bags and boxes of paper or cardboard, hat boxes of paper, aquarelles, drawings, stage scenery, architectural models; printed matter, particularly posters, albums, atlases, brochures, geographical maps, postcards, catalogs, non-textile labels, printed material, books, newspapers, periodicals, magazines, diaries, adhesive tapes; bookbinding articles, photographs; stationery, particularly pads of paper, drawing pads, blotting papers, note books, calendars, notepads, envelopes, writing paper, indexes; adhesives for stationery and household use; modeling materials for artists; paintbrushes; typewriters and office requisites (with the exception of furniture), particularly slates, ink pads, letter trays, letter openers, pencils, writing boards, inkwells, paperweights, pencil holders, pens, balls and nibs for pens; instructional or teaching material (except apparatus); small bags [envelopes, pouches] of plastic materials for packaging (not included in other classes); printing type; printing blocks.

18 – Leather and imitations of leather; trunks and suitcases, traveling bags, sports bags; handbags; back-

packs, beach bags, school bags, satchels, shopping bags; trunks, suitcases for clothing and footwear; attaché cases and briefcases, attaché cases for documents (leather goods); handbags, wallets, business card cases in the form of wallets, pouches not of precious metals, key cases (leather goods); boxes of leather or imitation leather; suitcase sets (leatherware), toiletry bags, not fitted; pouches of leather, clutch bags [handbags]; parasols; umbrellas; clothing for animals, animal carriers [bags].

25 – Clothing; tee-shirts; shirts; short-sleeved shirts, overalls; overalls; jackets and pullovers; jerseys (clothing); knitwear (clothing); coats; blousons; anoraks; raincoats; overcoats; ponchos; suits; combinations (clothing); dresses, skirts, shorts; trousers; briefs; leggings (trousers); lingerie and underwear; pajamas; nightgowns; dressing gowns (robes); dressing gowns; bathing suits for women; bathing suits for men; corsets (underwear); collars (clothing); detachable collars; Ascot ties; cuffs (clothing); kimonos; layettes (clothing); belts (clothing); money belts [clothing]; scarves and long scarves; shawls; stoles; bandanas (neckerchiefs); pocket squares; neckties; suspenders; gloves (clothing); fingerless gloves; fingerless gloves; muffs (clothing); ear muffs (clothing); scarves and neck warmers; headwear; hats; stocking caps; bandeaux (clothing); caps; visors; socks; stockings; tights; sleep masks; footwear; pocket squares; shoes; sports shoes; boots; ankle boots; esparto shoes or sandals; sandals; gaiters; snow boots; mules and slippers.

35 – Retail services for perfumery, clothing, footwear and headwear, textile products, products of leather or imitation leather, bags, spectacles and sunglasses, jewelry, timepieces and chronometric instruments; online retail services, rendered via the global computer network, offering perfumery, clothing, footwear and headwear, textile products, products of leather or imitation leather, bags, spectacles and sunglasses, jewelry, timepieces and chronometric instruments; advertising and promotional services, particularly via electronic means; rental of advertising space; publication of advertising texts; direct mail advertising; advertising online on the computer network; opinion polling, market studies, services related to commercial promotional activity in all its forms, particularly sponsorship and exhibition services and information and promotional campaigns.

(260) AM 2023 119944 A
 (800) 1690758
 (151) 2022 06 03
 (891) 2022 06 03
 (731) FASHION CO DOO, BEOGRAD (NOVI BEOGRAD)
 Bulevar Mihajla Pupina 115b, 11000 Beograd, Serbia

(540)

SHOEZEN

(591) Black and ocher

(531) 27.05.09; 29.01.12

(511)

3 – Bleaching preparations and other substances for laundry use, cleaning, polishing, degreasing and abrasive preparations, cleaning preparations and oils, preservatives for leather (polishes), leather bleaching preparation, polishing creams, creams for leather, shoe polish, wax for furniture, wax for cobblers; perfumery; perfumes; eaux de toilette; eaux de parfum, eaux de Cologne, perfume bases, flower extracts, essential oils; air fragrancing preparations, scented potpourris, incense; cosmetic preparations for skin and lip care; cosmetic preparations for slimming; lotions for cosmetic use, beauty masks, cosmetic preparations for the hands, face and body; hair care products, hair lotions, hair bleaches, hair dyes, hair creams or hair-styling gels; hair sprays, depilatory creams, depilatory waxes; shaving products, shaving soaps, shaving foams, after-shave products; sun protection products for cosmetic use, preparations for cosmetic use for tanning, self-tanning preparations for cosmetic use, toiletries, dentifrices, soaps, shampoos, shower gels, bath gels, bath oils, bath salts, bath foams, bath pearls, talcum powder for toilet use, cleansing milks, deodorants, make-up products, lipsticks, mascara, make-up, make-up powders, eye shadows, make-up pencils, make-up removing products, decorative transfers for cosmetic use, temporary tattoos for the body and nails, cosmetic kits mainly containing mascara, lipsticks, eyebrow pencils, makeup, make-up foundation and lip gloss, nail care and styling products, nail polish, lacquered nail polish, nail polish removers [cosmetics], false nails for the hands and feet, false nail kit, adhesives for false nails.

16 – Articles of paper or cardboard, particularly bags and paper for packaging, bags and boxes of paper or cardboard, hat boxes of paper, aquarelles, drawings, stage scenery, architectural models; printed matter, particularly posters, albums, atlases, brochures, geographical maps, postcards, catalogs, non-textile labels, printed material, books, newspapers, periodicals, magazines, diaries, adhesive tapes; bookbinding articles, photographs; stationery, particularly pads of paper, drawing pads, blotting papers, note books, calendars, notepads, envelopes, writing paper, indexes; adhesives for stationery and household use; modeling materials for artists; paintbrushes; typewriters and office requisites (with the exception of furniture), particularly slates, ink pads, letter trays, letter openers, pencils, writing boards, inkwells, paperweights, pencil holders, pens, balls and nibs for pens; instructional or teaching material (except apparatus); small bags [envelopes, pouches] of plastic materials for packaging

[not included in other classes]; printing type; printing blocks.

18 – Leather and imitations of leather; trunks and suitcases, traveling bags, sports bags; handbags; backpacks, beach bags, school bags, satchels, shopping bags; trunks, suitcases for clothing and footwear; attaché cases and briefcases, attaché cases for documents (leather goods); handbags, wallets, business card cases in the form of wallets, pouches not of precious metals, key cases (leather goods); boxes of leather or imitation leather; suitcase sets (leatherware), toiletry bags, not fitted; pouches of leather, clutch bags [handbags]; parasols; umbrellas; clothing for animals, animal carriers [bags].

25 – Clothing; tee-shirts; shirts; short-sleeved shirts, overalls; overalls; jackets and pullovers; jerseys (clothing); knitwear (clothing); coats; blousons; anoraks; raincoats; overcoats; ponchos; suits; combinations (clothing); dresses, skirts, skorts; shorts; trousers; briefs; leggings (trousers); lingerie and underwear; pajamas; nightgowns; dressing gowns (robes); dressing gowns; bathing suits for women; bathing suits for men; corsets (underwear); collars (clothing); detachable collars; Ascot ties; cuffs (clothing); kimonos; layettes (clothing); belts (clothing); money belts [clothing]; scarves and long scarves; shawls; stoles; bandanas (neckerchiefs); pocket squares; neckties; suspenders; gloves (clothing); fingerless gloves; fingerless gloves; muffs (clothing); ear muffs (clothing); scarves and neck warmers; headwear; hats; stocking caps; bandeaux (clothing); caps; visors; socks; stockings; tights; sleep masks; footwear; pocket squares; shoes; sports shoes; boots; ankle boots; esparto shoes or sandals; sandals; gaiters; snow boots; mules and slippers.

35 – Retail services for perfumery, clothing, footwear and headwear, textile products, products of leather or imitation leather, bags, spectacles and sunglasses, jewelry, timepieces and chronometric instruments; online retail services, rendered via the global computer network, offering perfumery, clothing, footwear and headwear, textile products, products of leather or imitation leather, bags, spectacles and sunglasses, jewelry, timepieces and chronometric instruments; advertising and promotional services, particularly via electronic means; rental of advertising space; publication of advertising texts; direct mail advertising; advertising online on the computer network; opinion polling, market studies, services related to commercial promotional activity in all its forms, particularly sponsorship and exhibition services and information and promotional campaigns.

(260) AM 2023 119945 A
 (800) 1690759
 (151) 2022 06 03
 (891) 2022 06 03
 (731) Fashion Co Doo, Beograd (Novi Beograd)

Bulevar Mihajla Pupina 115b, 11000 Beograd, Serbia

(540)



(591) Black and burgundy PANTONE 7427C
 (531) 24.17.09; 24.17.25; 27.05.12; 27.05.17;
 29.01.12

(511)

3 – Bleaching preparations and other substances for laundry use, cleaning, polishing, degreasing and abrasive preparations, cleaning preparations and oils, preservatives for leather (polishes), leather bleaching preparation, polishing creams, creams for leather, shoe polish, wax for furniture, wax for cobblers; perfumery; perfumes; eaux de toilette; eaux de parfum, eaux de Cologne, perfume bases, flower extracts, essential oils; air fragranting preparations, scented potpourris, incense; cosmetic preparations for skin and lip care; cosmetic preparations for slimming; lotions for cosmetic use, beauty masks, cosmetic preparations for the hands, face and body; hair care products, hair lotions, hair bleaches, hair dyes, hair creams or hair-styling gels; hair sprays, depilatory creams, depilatory waxes; shaving products, shaving soaps, shaving foams, after-shave products; sun protection products for cosmetic use, preparations for cosmetic use for tanning, self-tanning preparations for cosmetic use, toiletries, dentifrices, soaps, shampoos, shower gels, bath gels, bath oils, bath salts, bath foams, bath pearls, talcum powder for toilet use, cleansing milks, deodorants, make-up products, lipsticks, mascara, make-up, make-up powders, eye shadows, make-up pencils, make-up removing products, decorative transfers for cosmetic use, temporary tattoos for the body and nails, cosmetic kits mainly containing mascara, lipsticks, eyebrow pencils, makeup, make-up foundation and lip gloss, nail care and styling products, nail polish, lacquered nail polish, nail polish removers [cosmetics], false nails for the hands and feet, false nail kit, adhesives for false nails.

16 – Articles of paper or cardboard, particularly bags and paper for packaging, bags and boxes of paper or cardboard, hat boxes of paper, aquarelles, drawings, stage scenery, architectural models; printed matter, particularly posters, albums, atlases, brochures, geographical maps, postcards, catalogs, non-textile labels, printed material, books, newspapers, periodicals, magazines, diaries, adhesive tapes; bookbinding articles, photographs; stationery, particularly pads of paper, drawing pads, blotting papers, note books, calendars, notepads, envelopes, writing paper, indexes; adhesives for stationery and household use; modeling materials for artists; paintbrushes; typewriters and office

requisites (with the exception of furniture), particularly slates, ink pads, letter trays, letter openers, pencils, writing boards, inkwells, paperweights, pencil holders, pens, balls and nibs for pens; instructional or teaching material (except apparatus); small bags [envelopes, pouches] of plastic materials for packaging [not included in other classes]; printing type; printing blocks.

(260) AM 2023 119946 A

(800) 1690795

(151) 2022 04 07

(891) 2022 04 07

(731) "Azersun Holding" Limited Liability Company
Heydar Aliyev ave. 92a, AZ-1029 Baku,
Azerbaijan

(540)



(591) Green, blue and white

(531) 01.01.10; 26.11.02; 26.11.12; 27.05.01;
27.05.11; 29.01.13

(511)

5 – Pharmaceutical and veterinary preparations; sanitary preparations for medical purposes; dietetic food and substances adapted for medical or veterinary use, food for babies; dietary supplements for humans and animals; plasters, materials for dressings; material for stopping teeth, dental wax; disinfectants; preparations for destroying vermin; fungicides, herbicides.

6 – Common metals and their alloys; metal building materials; transportable buildings of metal; materials of metal for railway tracks, non-electric cables and wires of common metal; ironmongery, small items of metal hardware; pipes and tubes of metal; safes; goods of common metal not included in other classes; ores.

7 – Machines and machine tools; motors and engines (except for land vehicles); machine coupling and transmission components (except for land vehicles); agricultural implements other than hand-operated; incubators for eggs; automatic vending machines; vending machines.

8 – Hand tools and implements (hand-operated); cutlery; side arms; razors.

9 – Scientific, nautical, surveying, photographic, cinematographic, optical, weighing, measuring, signalling, checking (supervision), life-saving and teaching apparatus and instruments; apparatus and instruments for

conducting, switching, transforming, accumulating, regulating or controlling electricity; apparatus for recording, transmission or reproduction of sound or images; magnetic data carriers, recording discs; mechanisms for coin-operated apparatus; cash registers, calculating machines, data processing equipment, computers; fire-extinguishing apparatus.

10 – Surgical, medical, dental and veterinary apparatus and instruments, artificial limbs, eyes and teeth; orthopedic articles; suture materials.

11 – Apparatus for lighting, heating, steam generating, cooking, refrigerating, drying, ventilating, water supply and sanitary purposes.

12 – Vehicles; apparatus for locomotion by land, air or water.

13 – Firearms; ammunition and projectiles; explosives; fireworks.

14 – Precious metals and their alloys and goods in precious metals or coated therewith, not included in other classes; jewellery, precious stones; horological and chronometric instruments.

15 – Musical instruments.

16 – Paper, cardboard and goods made from these materials, not included in other classes; printed matter; bookbinding material; photographs; stationery; adhesives for stationery or household purposes; artists' materials; paint brushes; typewriters and office requisites (except furniture); instructional and teaching material (except apparatus); plastic materials for packaging (not included in other classes); printers' type; printing blocks.

17 – Rubber, gutta-percha, gum, asbestos, mica and goods made from these materials and not included in other classes; plastics in extruded form for use in manufacture; packing, stopping and insulating materials; flexible pipes, not of metal.

18 – Leather and imitations of leather, and goods made of these materials and not included in other classes; animal skins, hides; trunks and travelling bags; umbrellas and parasols; walking sticks; whips, harness and saddlery.

19 – Building materials (non-metallic); non-metallic rigid pipes for building; asphalt, pitch and bitumen; non-metallic transportable buildings; monuments, not of metal.

20 – Furniture, mirrors, picture frames; goods (not included in other classes) of wood, cork, reed, cane, wicker, horn, bone, ivory, whalebone, shell, amber, mother-of-pearl, meerschaum and substitutes for all these materials, or of plastics.

21 – Household or kitchen utensils and containers; combs and sponges; brushes (except paintbrushes); brush-making materials; articles for cleaning purposes; steelwool; unworked or semi-worked glass (ex-

cept glass used in building); glassware, porcelain and earthenware not included in other classes.

22 – Ropes, string, nets, tents, awnings, tarpaulins, sails, sacks and bags (not included in other classes); padding and stuffing materials (except of rubber or plastics); raw fibrous textile materials.

23 – Yarns and threads, for textile use.

24 – Textiles and textile goods, not included in other classes; bed covers; table covers.

25 – Clothing, footwear, headgear.

26 – Lace and embroidery, ribbons and braid; buttons, hooks and eyes, pins and needles; artificial flowers.

27 – Carpets, rugs, mats and matting, linoleum and other materials for covering existing floors; wall hangings (non-textile).

28 – Games and playthings; gymnastic and sporting articles not included in other classes; decorations for christmas trees.

29 – Meat, fish, poultry and game; meat extracts; preserved, frozen, dried and cooked fruits and vegetables; jellies, jams, compotes; eggs; milk and milk products; edible oils and fats.

30 – Coffee, tea, cocoa and coffee substitutes; rice; tapioca and sago; flour and preparations made from cereals; bread, pastry and confectionery; edible ices; sugar, honey, treacle; yeast, baking-powder; salt; mustard; vinegar, sauces (condiments); spices; ice.

31 – Grains and agricultural, horticultural and forestry products not included in other classes; live animals; fresh fruits and vegetables; seeds; natural plants and flowers; foodstuffs for animals; malt.

32 – Beers; mineral and aerated waters and other non-alcoholic beverages; fruit beverages and fruit juices; syrups and other preparations for making beverages.

33 – Alcoholic beverages (except beers).

34 – Tobacco; smokers' articles; matches.

35 – Advertising; business management; business administration; office functions.

36 – Insurance; financial affairs; monetary affairs; real estate affairs.

37 – Building construction; repair; installation services.

38 – Telecommunications.

39 – Transport; packaging and storage of goods; travel arrangement.

40 – Treatment of materials.

41 – Education; providing of training; entertainment; sporting and cultural activities.

42 – Scientific and technological services and research and design relating thereto; industrial analysis and research services; design and development of computer hardware and software.

43 – Services for providing food and drink; temporary accommodation.

44 – Medical services; veterinary services; hygienic and beauty care for human beings or animals; agriculture, horticulture and forestry services.

45 – Legal services; security services for the protection of property and individuals; personal and social services rendered by others to meet the needs of individuals.

(260) AM 2023 119947 A

(800) 1690832

(151) 2022 06 20

(891) 2022 06 20

(731) European Organisation for the Safety of Air Navigation (Eurocontrol), in French Organisation Européenne pour la Sécurité de la Navigation Aérienne (Eurocontrol) Rue de la Fusée 96, B-1130 Brussels, Belgium

(540)



(591) Light blue and dark blue

(531) 26.03.01; 26.03.07; 26.03.19; 26.03.24; 27.05.04; 27.05.08; 27.05.11; 27.05.17; 27.05.25; 29.01.04

(511)

9 – Scientific research and laboratory apparatus, educational apparatus and simulators; artificial intelligence software; artificial intelligence software for analysis; artificial intelligence software for surveillance; artificial intelligence software for vehicles; artificial intelligence and machine learning software; software for the integration of artificial intelligence and machine learning in the field of big data; electronic publications; electronic publications, downloadable; machine learning software for analysis; databases; data processors; data networks; databases (electronic), all aforementioned goods relating to the field of aviation.

16 – Promotional publications; publication paper, all aforementioned goods relating to the field of aviation.

35 – Analysis of market research data; business intelligence services; market intelligence services; data processing; data management; database management; electronic data processing; collection of data; data

management services; compilation of data in computer databases, all aforementioned services relating to the field of aviation.

39 – Provision of airport information services relating to aviation; provision of navigational information relating to the aviation; air traffic control, including in the context of air traffic management services; air navigation services; all aforementioned services relating to the field of aviation.

41 – Educational research; courses (training -) relating to research and development; training; providing training; training courses; training services; educational certification services, namely, providing training and educational examination; publication services; publication of leaflets; publication of brochures, all aforementioned services relating to the field of aviation.

42 – Industrial research; software research; scientific research; technological research; research in the field of computer hardware and software; computer software research; product research and development services; research of new products for others; scientific research and analysis; research relating to data processing; research relating to mechanical engineering; research relating to computer programming; research relating to computer programs; research relating to environmental protection; research relating to telecommunication techniques; technical research projects and studies; scientific research conducted using databases; research in the field of telecommunication technology; environmental protection (research in the field of -); research in the area of environmental protection; consultancy in the field of technological research; research in the field of climate change; preparation of reports relating to scientific research; research in the field of communications technology; research in the field of electrical engineering; research in the field of environmental protection; research in the field of telecommunications technology; research relating to the development of computer programs and software; research in the field of technology provided by engineers; research in the field of artificial intelligence; providing artificial intelligence computer programs on data networks; technology consultation in the field of artificial intelligence; research in the field of artificial intelligence technology; platforms for artificial intelligence as software as a service [saas]; software as a service [saas] featuring computer software platforms for artificial intelligence; certification of data via blockchain; data warehousing; online data storage; hosting of databases; development of database system; telecommunication network security consultancy; IT security services in the nature of protection and recovery of computer data; consultancy in the field of data security; consultancy in the field of security software; computer security threat analysis for protecting data; computer security services for

protection against illegal network access, all aforementioned services relating to the field of aviation.

(260) AM 2023 119948 A

(800) 1690846

(151) 2022 09 14

(891) 2022 09 14

(731) Apple Inc.

One Apple Park Way, Cupertino CA 95014, USA

(540)

DYNAMIC ISLAND

(591) Black, white

(511)

9 – Personal digital assistants sold as a component feature of computers and smartphones; controllers for use with interactive digital multimedia content sold as a component feature of computers and smartphones; display screens sold as a component feature of computers and smartphones; interactive touchscreens sold as a component feature of computers and smartphones; remote controls for controlling computers, mobile telephones, wearable peripherals, smartwatches, smart speakers, earphones, headphones, headsets, audio and video players, set top boxes, handheld digital electronic devices, and home entertainment systems sold as a component feature of computers and smartphones; interfaces for computers and smartphones; parts for computers, mobile electronic devices, mobile telephones, and smartphones; recorded computer software; recorded computer software for providing notifications, alerts, and other data from concurrently running software applications, which is sold as a component feature of recorded computer operating software for computers and smartphones; recorded computer software for setting up, configuring, operating, and controlling computers, computer peripherals, smartphones, smartwatches, smart speakers, smart home hubs, earbuds, headphones, headsets, handheld digital electronic devices, televisions, set top boxes, audio and video players, and home entertainment systems, which is sold as a component feature of recorded computer operating software for computers and smartphones; recorded software for processing, transmitting and displaying text, data, images, audio, audio visual content, and other multimedia content which is sold as a component feature of recorded computer operating software for computers and smartphones; recorded software for sending and receiving electronic messages, alerts, notifications and reminders which is sold as a component feature of recorded computer operating software for computers and smartphones; recorded computer software for providing geographic information, interactive maps and satellite and aerial images which is sold as a component feature of recorded computer operating software for computers and smartphones; recorded computer software for fa-

cilitating commercial transactions through mobile telecommunication devices which is sold as a component feature of recorded computer operating software for computers and smartphones.

(260) AM 2023 119949 A

(800) 1690853

(151) 2022 06 27

(891) 2022 06 27

(731) Ünsal Yapı Ve Dayanıklı Tüketim

Mallsan.Tic A.Ş

Başakşehir Mahallesi, Hürriyet Bulvarı,

No:119/2, Başakşehir – İstanbul, Türkiye

(540)



(591) Blue

(531) 27.05.01; 29.01.04

(511)

7 – 3D printers; bulldozers, diggers (machines), excavators, road construction and road paving machines, drilling machines, rock drilling machines, road sweeping machines; lifting, loading and transmission machines and robotic mechanisms (machines) for lifting, loading and transmission purposes; elevators, escalators and cranes; brakes other than for vehicles, brake linings for engines, crankshafts, transmission gears for machines, cylinders for engines, pistons for engines, turbines, not for land vehicles, filters for engines and motors, oil, air and fuel filters for land vehicle engines, exhausts for land vehicle engines, exhaust manifolds for land vehicle engines, engine cylinders for land vehicles, engine cylinder heads for land vehicles, pistons for land vehicle engines, carburetors for land vehicles, fuel conversion apparatus for land vehicle engines, injectors for land vehicle engines, fuel economisers for land vehicle engines, pumps for land vehicle engines, valves for land vehicle engines, starters for motors and engines, dynamos for land vehicle engines, sparking plugs for land vehicle engines; bearings (parts of machines), roller or ball bearings; machines for mounting and detaching tires; vehicle washing installations, robotic mechanisms (machines) with the abovementioned functions; electric and gas-operated welding apparatus, electric arc welding apparatus, electric soldering apparatus, electric arc cutting apparatus, electrodes for welding machines, industrial robots (machines) with the abovementioned functions; printing machines; packaging machines, filling, plugging and sealing machines, labellers (machines), sorting machines, industrial robots (machines) with the abovementioned functions, electric packing machines for plugging and scaling of plastics; automatic vending machines; galvanizing and electroplating machines; electric door openers and closers.

9 – Clothing for protection against accidents, irradiation and fire, safety vests and life-saving apparatus

and equipment; eyeglasses, sunglasses, optical lenses and cases, containers, parts and components thereof; fire extinguishing apparatus, fire engines, fire hose and fire hose nozzles.

(260) AM 2023 119950 A

(800) 1690861

(151) 2022 02 03

(891) 2022 02 03

(731) Orhan Atasay

Üniversite Mahallesi Civan Sokak, Allure

Tower No: 1/117, Avcıla, İstanbul,

Türkiye

(540)



(591) Blue, green, white

(531) 26.07.25; 27.05.01; 28.01; 29.01.13

(511)

7 – Construction equipment: dozers, buckets, excavators, road construction and paving machines, drilling machines, rock drilling machines, sweeping machines and robotic mechanisms with the same function; machinery and robotic mechanisms used in agriculture, animal husbandry, agriculture and grain/fruit/vegetable/food processing, beverage making and processing machinery; bearings, ball or roller bearings; alternators, generators, electric generators, solar powered generators; electric and gas welding machines, electric arc welding devices, electric soldering devices, electric arc cutting devices, electric welding machine electrodes and robots with the same function; packaging machines, fill-plug and seal machines, labeling machines, sorters, and robots and robotic mechanisms (including electrical plastic closing/sealing devices [packing]); pumps without machinery or engine parts (including fuel filling and distribution pumps and their guns); automatic vending machines; electric opening and closing mechanisms; machines for the processing and shaping of wood, metal, glass and plastic materials and mines, machine tools and industrial robots used for this purpose, three-dimensional printers; lifting, transporting and conveying machinery: elevators, escalators, cranes, robotic mechanisms with the same function; engines, electric motors, parts and assemblies, except for land vehicles: hydraulic, pneumatic controls, brakes, linings, crankshafts, gears, cylinders, pistons, turbines, filters, except for land vehicles; parts used in land vehicles and included in this class: oil, fuel and air filters for vehicles, exhausts, exhaust manifolds, cylinders, cylinder heads, pistons, carburetors, fuel conversion devices, injectors, fuel saving devices, pumps, valves, starters, dynamos, spark plugs bearings, ball or roller bearings; tire removal and mounting machines; paint machines, auto-

matic paint spray guns, electric, hydraulic and pneumatic punching machines and guns, electric glue guns, compressed air or spray guns for machines, power drills, chainsaws, jigsaws, spiral machines, compressed air generators, compressors, car wash machines and robots that have the same function as the machines and tools listed above; printing machines; textile machines, sewing machines and industrial robots with the same function; kitchen power tools for chopping, grinding, mashing, whisking and crumbling; washing machines (including washing/dishwashing machines, non-heated centrifugal tumble dryers); electric machines, vacuum cleaners and parts thereof for cleaning floors, carpets or upholstery; galvanize coating and electrolysis (current coating) machines; cylinder seals for machinery and engines.

9 – Devices for recording, transferring or reproducing (reproducing) sound and image: cameras, cameras, televisions, videos, cd-dvd recording and player devices, mp3 players, computers, desktop-tablet computers, wearable technological devices, namely, smartwatches, smart wristbands and head-mounted cameras, microphones, speakers, headphones; communication and duplication devices and computer peripheral equipment: mobile phones and their cases, fixed telephones, telephone exchanges, computer printers, scanners, copiers; antennas, satellite dishes, amplifiers and parts thereof; elements used in the electronics of machines and devices: semiconductors, electronic circuits, integrated chips (chips), diodes, transistors, magnetic heads, deflectors; electronic locks, photocells, electronic opening and closing mechanisms, sensors; protective clothing, protection and life-saving equipment; electrical energy transmission, conversion, storage control devices and tools: plugs, junction boxes, switches, breakers, fuses, ballasts, starters, electrical panels, resistors, sockets, transformers, adapters, chargers, cables used in electricity, electronics, batteries, accumulators, solar panels for electricity generation; signaling, signaling devices and tools for use in traffic; radars, submarine radars (sonars), night vision devices and devices; metronomes; measuring instruments, instruments, including those for science, nautical, topography, meteorology, industrial and laboratory use: non-medical thermometers, barometers, ammeters, voltmeters, humidity meters, test equipment, telescopes, periscopes, compasses; vehicle indicators; materials used in laboratories: microscopes, magnifying glasses, binoculars, experimental materials and devices; magnetic and optical record carriers and computer programs and software recorded on them; electronic publications that can be downloaded via computer networks and recorded on magnetic and optical media; cards with magnetic/optical reader, motion pictures, serials and video music clips recorded on magnetic, optical and electronic media; ticket vending machines, cash machines; counters and timers that measure the amount of consumption per unit time; eyeglasses, sunglasses, lenses and their cases, ca-

ses, parts and accessories; devices whose main function is warning and alarm (except vehicle alarms), electric bells; fire-fighting appliances and devices, including fire-fighting vehicles (including fire-fighting hoses and fire-fighting valves); decorative magnets.

11 – Solid, liquid, gas fueled and electrical heating devices: combi boilers, boilers, heater cores, heat exchangers, stoves, cookers; solar collectors; air conditioning and ventilation devices; electric and gas powered appliances, machines and appliances for cooking, drying and boiling: ovens, electric pots, electric kettles, barbecues, barbecues, electric clothes dryers, hair dryers and hand dryers; water softening equipment, water treatment equipment, water treatment plant, waste treatment plant; filters and filter-motor combinations for aquariums; pasteurizing and sterilizing machines; lighting devices (vehicles, indoor and outdoor lighting fixtures); steam, gas and fog (smoke) generators (generators): steam generators (boilers), acetylene generators, oxygen generators, nitrogen generators; coolers and freezers; sanitary ware products: taps, shower sets, toilet bowl inserts, bath-shower cabinets, bathtubs, toilet bowls, sinks, washbasins, gaskets for taps, gaskets (faucet inner set); non-medical electric mats and electric blankets, heating pads, electric or non-electric foot warmers, hot water bags (thermophores), electric heated socks; industrial type cooking, drying and cooling installation.

35 – Advertising, marketing and public relations services, organization of exhibitions and fairs for commercial and advertising purposes, development of advertising concepts; providing an online marketplace for buyers and sellers of goods and services; office functions; secretarial services, newspaper subscription editing services, compilation of statistics, rental of office machines, systematization of information in computer databases, telephone answering services; business management, administration and consultancy on these issues, accounting and financial consultancy services, personnel job placement, recruitment, personnel selection, personnel supply services, import-export agency services, temporary personnel assignment (invoicing on behalf of someone else, tax payment, traffic business tracking) services; organization and execution of auctions; the bringing together, for the benefit of others, of machines, machine tools and industrial robots used for this purpose, three-dimensional printers for processing and shaping wood, metal, glass and plastic materials and metals, construction equipment: dozers, buckets, excavators, road construction and paving machines, drilling machines, rock drilling machines, sweeping machines and robotic mechanisms with the same function, lifting, transporting and conveying machinery: elevators, escalators, cranes, robotic mechanisms with the same function, machinery and robotic mechanisms used in agriculture, animal husbandry, agriculture and grain/fruit/vegetable/food processing, beverage making and processing

machinery, engines, electric motors, parts and assemblies, except for land vehicles: hydraulic, pneumatic controls, brakes, linings, crankshafts, gears, cylinders, pistons, turbines, filters, except for land vehicles, parts used in land vehicles and included in this class: oil, fuel and air filters for vehicles, exhausts, exhaust manifolds, cylinders, cylinder heads, pistons, carburetors, fuel conversion devices, injectors, fuel saving devices, pumps, valves, starters, dynamos, spark plugs bearings, ball or roller bearings, tire removal and mounting machines, alternators, generators, electric generators, solar powered generators, paint machines, automatic paint spray guns, electric, hydraulic and pneumatic punching machines and guns, electric glue guns, compressed air or spray guns for machines, power drills, chainsaws, jigsaws, spiral machines, compressed air generators, compressors, car wash machines and robots that have the same function as the machines and tools listed above, electric and gas welding machines, electric arc welding devices, electric soldering devices, electric arc cutting devices, electric welding machine electrodes and robots with the same function, printing machines, packaging machines, fill-plug and seal machines, labeling machines, sorters, and robots and robotic mechanisms (including electrical plastic closing/sealing devices [packing]), textile machines, sewing machines and industrial robots with the same function, pumps without machinery or engine parts (including fuel filling and distribution pumps and their guns), kitchen power tools for chopping, grinding, mashing, whisking and crumbling, washing machines (including washing/dishwashing machines, non-heated centrifugal tumble dryers), electric machines, vacuum cleaners and parts thereof for cleaning floors, carpets or upholstery, vending machines, galvanize coating and electrolysis (current coating) machines, electric opening and closing mechanisms, cylinder seals for machinery and engines, measuring instruments, instruments, including those for science, nautical, topography, meteorology, industrial and laboratory use: non-medical thermometers, barometers, ammeters, voltmeters, humidity meters, test equipment, telescopes, periscopes, compasses, vehicle indicators, materials used in laboratories: microscopes, magnifiers, binoculars, experimental materials and devices, devices for recording, transferring or reproducing (reproducing) sound and image: cameras, cameras, televisions, videos, cd-dvd recording and player devices, mp3 players, computers, desktop-tablet computers, wearable technological devices, namely, smartwatches, smart wristbands and head-mounted cameras, microphones, speakers, headphones, communication and reproduction devices and computer peripheral equipment: mobile phones and their cases, fixed telephones, telephone exchanges, computer printers, scanners, copiers, magnetic and optical record carriers and computer programs and software recorded on them, electronic publications that can be downloaded via computer networks and recorded on

magnetic and optical media, cards with magnetic/optical reader, motion pictures, serials and video music clips recorded on magnetic, optical and electronic media, antennas, satellite dishes, amplifiers and parts thereof, ticket vending machines, cash machines, elements used in the electronics of machines and devices: semiconductors, electronic circuits, ics, chips (chips), diodes, transistors, magnetic heads, deflectors, electronic locks, photocells, electronic opening and closing mechanisms, sensors, counters and timers that measure the amount of consumption per unit time, protective clothing, protection and life-saving equipment, eyeglasses, sunglasses, lenses and their cases, cases, parts and accessories, electrical energy transmission, conversion, storage control devices and tools: plugs, junction boxes, switches, breakers, fuses, ballasts, starters, electrical panels, resistors, sockets, transformers, adapters, chargers, cables used in electricity, electronics, batteries, accumulators, solar panels for electricity generation, devices whose main function is warning and alarm (except vehicle alarms), electric bells, signaling, signaling devices and vehicles for use in traffic, fire-fighting appliances and devices, including fire-fighting vehicles (including fire-fighting hoses and fire-fighting valves), radars, submarine radars (sonars), night vision devices and devices; decorative magnets, metronomes, lighting devices (vehicles, indoor and outdoor lighting fixtures), solid, liquid, gas fueled and electrical heating devices: combi boilers, boilers, heater cores, heat exchangers, stoves, cookers, solar collectors, steam, gas and fog (smoke) generators (generators): steam generators (boilers), acetylene generators, oxygen generators, nitrogen generators, air conditioning and ventilation devices, coolers and freezers, electric and gas powered appliances, machines and appliances for cooking, drying and boiling: ovens, electric pots, electric kettles, barbecues, barbecues, electric clothes dryers, hair dryers and hand dryers, sanitary ware products: taps, shower sets, toilet bowl inserts, bath-shower cabinets, bathtubs, toilet bowls, sinks, washbasins, gaskets for taps, gaskets (faucet inner set), water softening equipment, water treatment equipment, water treatment plant, waste treatment plant, non-medical electric mats and electric blankets, heating pads, electric or non-electric foot warmers, hot water bags (thermophores), electric heated socks filters and filter-motor combinations for aquariums, industrial type cooking, drying and cooling installation, pasteurizing and sterilizing machines, assembly services, enabling customers to conveniently view and purchase those goods, such services may be provided by retail stores, wholesale outlets, through vending machines, mail order catalogues or by means of electronic media.

(260) AM 2023 119951 A
(800) 1690936
(151) 2022 03 15
(891) 2022 03 15
(731) Yuga Labs, Inc.
1430 S. Dixie Hwy, Ste. 105 1075, Coral
Gables FL 33146, USA

(540)

MAYC

(591) Black, white

(511)

9 – Computer hardware; smartwatches; smart jewelry; eyewear; sunglasses; virtual reality glasses; headphones; headsets; gaming headsets; computer gaming peripherals; cases for computers, smartphones, headphones and headsets; light emitting diode (LED) signs; neon signs; downloadable computer software for blockchain technology; computer software for cryptocurrency; cryptocurrency hardware wallet; non-fungible token (NFT) multimedia files; non-fungible token (NFT) music files; non-fungible token (NFT) image files; non-fungible token (NFT) video files; non-fungible token (NFT) text files; non-fungible token (NFT) audio files; image, music, audio, video and multimedia files authenticated by non-fungible tokens (NFTs); downloadable electronic publications; digital images, audio, video and multimedia files; computer graphics; software; blockchain software; distributed ledger software; cryptography software; software for use with cryptocurrency; software for use with digital currency; software for use with virtual currency; software for minting, creating, and issuing digital assets, digital tokens, crypto-tokens, utility tokens, non-fungible tokens (NFTs), digital collectibles, crypto-collectibles, cryptocurrencies, digital currencies and virtual currencies; software for viewing and providing access to digital assets, digital tokens, crypto-tokens, utility tokens, non-fungible tokens (NFTs), digital collectibles, crypto-collectibles, cryptocurrencies, digital currencies and virtual currencies; software for distributing, trading, storing, sending, receiving, accepting, and transmitting digital assets, digital tokens, crypto-tokens, utility tokens, non-fungible tokens (NFTs), digital collectibles, crypto-collectibles, cryptocurrencies, digital currencies and virtual currencies; software for decentralized finance; software for creating and executing smart contracts; software for developing decentralized applications; software for recording, managing, tracking, and transferring ownership interests in decentralized autonomous organizations; software for management and governance of decentralized autonomous organizations; software for participating and voting in decentralized autonomous organizations; software for executing and recording financial transactions; distributed ledger software for use in processing financial transactions; software for electronic funds transfer; software for use as a cryptocurrency wallet; software for use as an electronic wallet; software for creating and managing electronic wallets;

software for digital currency payment and exchange transactions; software for managing and validating transactions involving digital assets, digital tokens, crypto-tokens, utility tokens, non-fungible tokens (NFTs), digital collectibles, crypto-collectibles, cryptocurrencies, digital currencies and virtual currencies; electronic payment processing software; game software; virtual reality software; software for creating NFTs; software for managing and verifying transactions on a blockchain; software for game development; gaming software development tools; blockchain gaming software; software for cryptocurrency mining; software for cryptocurrency farming; software for arranging and conducting auctions; software for voting; software for social networking; software development tools; software for creating, managing, and interacting with an online community; software for creating, managing and accessing groups within virtual communities; file sharing software; communications software; software for sending and receiving electronic messages, graphics, images, audio and audio visual content via the internet and communication networks; software for creating, editing, uploading, downloading, accessing, viewing, posting, displaying, tagging, blogging, streaming, linking, annotating, indicating sentiment about, commenting on, voting on, embedding, transmitting, and sharing or otherwise providing electronic media or information via computer and communication networks; software for processing images, graphics, audio, video, and text; software for the collection, managing, editing, organizing, modifying, transmission, sharing, and storage of data and information; software for transmitting, sharing, receiving, downloading, displaying, interacting with and transferring content, text, visual works, audio works, audiovisual works, literary works, data, files, documents and electronic works; e-commerce software; e-commerce software to allow users to perform electronic business transactions via a global computer the internet and communication networks; software for processing electronic transactions; software for organizing, searching for and managing events; software for creating accounts and maintaining and managing information about financial transactions on distributed ledgers and peer to peer payment networks; software for use in financial trading; software for use in financial exchange; software for providing authentication of parties to a financial transaction; software for maintaining ledgers for financial transactions; software for the management of cryptographic security of electronic transmissions across computer networks; software for encrypting and enabling secure transmission of digital information over the Internet; software for currency conversion.

14 – Jewelry; imitation jewelry; watches; keychains; key rings.

16 – Printed publications; books; magazines; pictures; posters; stationery; trading cards.

18 – Bags; backpacks; luggage; wallets.

24 – Blankets; bedspreads.

25 – Clothing; hats; headwear; jackets; jerseys; pants; shirts; t-shirts; sweaters; sweatshirts; shoes; scarves; sneakers; socks.

27 – Rugs; carpets; mats.

28 – Toys, games and playthings; toy figurines; plush toys; action figures; balls; basketballs; playing cards; trading cards; hand-held units for playing electronic, computer, interactive, and video games; gaming devices; mobile gaming devices; amusement game machines; game consoles; game controllers for computer and video games; computer game joysticks; video game joysticks; gaming mice; gaming keypads; skateboards; skateboard decks; cases for gaming devices; game cards.

32 – Beer; energy drinks; non-alcoholic beverages; soft drinks.

33 – Alcoholic beverages; wine; liquor; spirits; liquors; cocktails.

35 – Retail services; advertising services; marketing services; market research; promotion services; business consulting services; facilitating the exchange and sale of products and services via computer and communication networks; providing online facilities for connecting buyers with sellers; providing an online marketplace; providing an online marketplace for digital assets, digital tokens, crypto-tokens, utility tokens, non-fungible tokens (NFTs), digital collectibles, crypto-collectibles, cryptocurrencies, digital currencies and virtual currencies; providing an online marketplace for buyers and sellers of digital goods authenticated by non-fungible tokens (NFTs); providing online marketplace to rent, borrow, and trade digital assets, digital tokens, crypto-tokens, utility tokens, non-fungible tokens (NFTs), digital collectibles, crypto-collectibles, cryptocurrencies, digital currencies and virtual currencies; providing a virtual marketplace for digital assets, digital tokens, crypto-tokens, utility tokens, non-fungible tokens (NFTs), digital collectibles, crypto-collectibles, cryptocurrencies, digital currencies and virtual currencies; providing a virtual marketplace for buyers and sellers of digital goods authenticated by non-fungible tokens (NFTs); providing a virtual marketplace to rent, borrow, and trade non-fungible tokens (NFTs); facilitating the exchange and sale of services and products of third parties via computer and communication networks; providing online marketplaces for sellers of goods and/or services; auction services; administration of voting services; promoting the goods and services of others via computer and communication networks; organization, management and administration of decentralized autonomous organizations (DAOs); administration services consisting of recording, management and trac-

king of ownership interests in decentralized autonomous organizations (DAOs).

36 – Financial services; monetary services; financial transaction services; financial exchange services; banking services; cryptocurrency services; digital currency services; electronic currency services; virtual currency services; cryptocurrency exchange services; cryptocurrency trading services; cryptocurrency payment processing; electronic payment services; electronic wallet services; currency exchange services; currency trading services; payment processing services; loan services; issuance of digital assets, digital tokens, crypto-tokens, utility tokens, non-fungible tokens (NFTs), digital collectibles, crypto-collectibles, cryptocurrencies, digital currencies and virtual currencies; distribution, trading, lending, exchange, and transmission of digital assets, digital tokens, crypto-tokens, utility tokens, non-fungible tokens (NFTs), digital collectibles, crypto-collectibles, cryptocurrencies, digital currencies and virtual currencies; providing financial information; providing information in the fields of digital assets, digital tokens, crypto-tokens, utility tokens, non-fungible tokens (NFTs), digital collectibles, crypto-collectibles, cryptocurrencies, digital currencies and virtual currencies; financial affairs, namely, financial management, financial planning, financial forecasting, financial portfolio management and financial analysis and consultation; financial information provided by electronic means; brokerage services; currency dealing services; investment management services; electronic commerce payment services; blockchain-based payment verification services.

38 – Communications services; telecommunications; broadcasting services; electronic messaging services; streaming of audio, video and digital media content on the internet; streaming of electronic and video games; providing internet chat rooms; providing online forums for transmission of messages among computer users; streaming of data; computer aided transmission of information and images; providing an online community forum for users to share and stream information, audio, video, real-time news, entertainment content, and information; providing user access to digital images, text, audio, video, games, multimedia content, digital collectibles, crypto-collectibles, and non-fungible tokens (NFTs); electronic transmission of virtual and augmented reality content and data.

41 – Entertainment services; production and distribution of films, motion pictures, radio, television and web programs; production and post-production of multimedia entertainment content; providing non-downloadable movies, television shows, webcasts, audiovisual, and multimedia works via the internet; production of sound, video and multimedia recordings; providing online electronic, computer and video games; virtual reality arcade services; virtual reality game services; electronic publishing services; entertainment services, namely, providing virtual rea-

lity, augmented reality and mixed reality interactive entertainment, games, content and experiences; entertainment services, namely, providing online virtual reality, augmented reality and mixed reality environments; production of virtual reality, augmented reality and mixed reality video for entertainment purposes; multimedia entertainment production and publishing services; organizing exhibitions, events, and conferences for entertainment and cultural purposes.

42 – Software as a service (SaaS); platform as a service (PaaS); cloud computing services; design and development of computer hardware and software; computer, electronic and video game development services; design and development of decentralized applications; development and implementation of smart contracts; information technology services; providing online non-downloadable software featuring electronic publications; providing online non-downloadable software featuring digital images, audio, video and multimedia files; providing online non-downloadable software featuring computer graphics; providing non-downloadable software; providing non-downloadable blockchain software; providing non-downloadable distributed ledger software; providing non-downloadable cryptography software; providing non-downloadable software for use with cryptocurrency; providing non-downloadable software for use with digital currency; providing non-downloadable software for use with virtual currency; providing non-downloadable software for minting, creating, and issuing digital assets, digital tokens, crypto-tokens, utility tokens, non-fungible tokens (NFTs), digital collectibles, crypto-collectibles, cryptocurrencies, digital currencies and virtual currencies; providing non-downloadable software for viewing and providing access to digital assets, digital tokens, crypto-tokens, utility tokens, non-fungible tokens (NFTs), digital collectibles, crypto-collectibles, cryptocurrencies, digital currencies and virtual currencies; providing non-downloadable software for distributing, trading, storing, sending, receiving, accepting, and transmitting digital assets, digital tokens, crypto-tokens, utility tokens, non-fungible tokens (NFTs), digital collectibles, crypto-collectibles, cryptocurrencies, digital currencies and virtual currencies; providing non-downloadable software for decentralized finance; providing non-downloadable software for creating and executing smart contracts; providing non-downloadable software for developing decentralized applications; providing non-downloadable software for recording, managing, tracking, and transferring ownership interests in decentralized autonomous organizations; providing non-downloadable software for management and governance of decentralized autonomous organizations; providing non-downloadable software for participating and voting in decentralized autonomous organizations; providing non-downloadable software for executing and recording financial transactions; providing non-downloadable distributed ledger software for use in processing fi-

nancial transactions; providing non-downloadable software for electronic funds transfer; providing non-downloadable software for use as a cryptocurrency wallet; providing non-downloadable software for use as an electronic wallet; providing non-downloadable software for creating and managing electronic wallets; providing non-downloadable software for digital currency payment and exchange transactions; providing non-downloadable software for managing and validating transactions involving digital assets, digital tokens, crypto-tokens, utility tokens, non-fungible tokens (NFTs), digital collectibles, crypto-collectibles, cryptocurrencies, digital currencies and virtual currencies; providing non-downloadable electronic payment processing software; providing non-downloadable game software; providing non-downloadable virtual reality software; providing non-downloadable software for creating NFTs; providing non-downloadable software for managing and verifying transactions on a blockchain; providing non-downloadable software for game development; providing non-downloadable gaming software development tools; providing non-downloadable blockchain gaming software; providing non-downloadable software for cryptocurrency mining; providing non-downloadable software for cryptocurrency farming; providing non-downloadable software for arranging and conducting auctions; providing non-downloadable software for voting; providing non-downloadable software for social networking; providing non-downloadable software development tools; providing non-downloadable software for creating, managing, and interacting with an online community; providing non-downloadable software for creating, managing and accessing groups within virtual communities; providing non-downloadable file sharing software; providing non-downloadable communications software; providing non-downloadable software for sending and receiving electronic messages, graphics, images, audio and audio visual content via the internet and communication networks; providing non-downloadable software for creating, editing, uploading, downloading, accessing, viewing, posting, displaying, tagging, blogging, streaming, linking, annotating, indicating sentiment about, commenting on, voting on, embedding, transmitting, and sharing or otherwise providing electronic media or information via computer and communication networks; providing non-downloadable software for processing images, graphics, audio, video, and text; providing non-downloadable software for the collection, managing, editing, organizing, modifying, transmission, sharing, and storage of data and information; providing non-downloadable software for transmitting, sharing, receiving, downloading, displaying, interacting with and transferring content, text, visual works, audio works, audiovisual works, literary works, data, files, documents and electronic works; providing non-downloadable e-commerce software; providing non-downloadable e-commerce software to allow users to per-

form electronic business transactions via a global computer the internet and communication networks; providing non-downloadable software for processing electronic transactions; providing non-downloadable software for organizing, searching for and managing events; providing non-downloadable software for creating accounts and maintaining and managing information about financial transactions on distributed ledgers and peer to peer payment networks; providing non-downloadable software for use in financial trading; providing non-downloadable software for use in financial exchange; providing non-downloadable software for providing authentication of parties to a financial transaction; providing non-downloadable software for maintaining ledgers for financial transactions; providing non-downloadable software for the management of cryptographic security of electronic transmissions across computer networks; providing non-downloadable software for encrypting and enabling secure transmission of digital information over the Internet; providing non-downloadable software for currency conversion; creation of digital assets, digital tokens, crypto-tokens, utility tokens, non-fungible tokens (NFTs), digital collectibles, crypto-collectibles, cryptocurrencies, digital currencies and virtual currencies; electronic storage of digital assets, digital tokens, crypto-tokens, utility tokens, non-fungible tokens (NFTs), digital collectibles, crypto-collectibles, cryptocurrencies, digital currencies and virtual currencies; data and information security services; providing temporary use of non-downloadable software for enabling members of an online community buying, selling, trading, and discussing and exchanging information about digital assets, digital tokens, crypto-tokens, utility tokens, non-fungible tokens (NFTs), digital collectibles, crypto-collectibles, cryptocurrencies, digital currencies and virtual currencies.

43 – Restaurant services; bar services; hotel services.

45 – Online social networking services; providing authentication services for personal identification information; identity verification services.

(260) AM 2023 119952 A

(800) 1690939

(151) 2022 03 15

(891) 2022 03 15

(731) Yuga Labs Inc.

1430 S. Dixie Hwy, Ste. 105 1075, Coral Gables FL 33146, USA

(540)

BORED APE YACHT CLUB

(591) Black, white

(511)

9 – Computer hardware; smartwatches; smart jewelry; eyewear; sunglasses; virtual reality glasses; headphones; headsets; gaming headsets; computer gaming peripherals; cases for computers, smartphones, head-

phones and headsets; light emitting diode (LED) signs; neon signs; downloadable computer software for blockchain technology; computer software for cryptocurrency; cryptocurrency hardware wallet; non-fungible token (NFT) multimedia files; non-fungible token (NFT) music files; non-fungible token (NFT) image files; non-fungible token (NFT) video files; non-fungible token (NFT) text files; non-fungible token (NFT) audio files; image, music, audio, video and multimedia files authenticated by non-fungible tokens (NFTs); downloadable electronic publications; digital images, audio, video and multimedia files; computer graphics; software; blockchain software; distributed ledger software; cryptography software; software for use with cryptocurrency; software for use with digital currency; software for use with virtual currency; software for minting, creating, and issuing digital assets, digital tokens, crypto-tokens, utility tokens, non-fungible tokens (NFTs), digital collectibles, crypto-collectibles, cryptocurrencies, digital currencies and virtual currencies; software for viewing and providing access to digital assets, digital tokens, crypto-tokens, utility tokens, non-fungible tokens (NFTs), digital collectibles, crypto-collectibles, cryptocurrencies, digital currencies and virtual currencies; software for distributing, trading, storing, sending, receiving, accepting, and transmitting digital assets, digital tokens, crypto-tokens, utility tokens, non-fungible tokens (NFTs), digital collectibles, crypto-collectibles, cryptocurrencies, digital currencies and virtual currencies; software for creating and executing smart contracts; software for developing decentralized applications; software for recording, managing, tracking, and transferring ownership interests in decentralized autonomous organizations; software for management and governance of decentralized autonomous organizations; software for participating and voting in decentralized autonomous organizations; software for executing and recording financial transactions; distributed ledger software for use in processing financial transactions; software for electronic funds transfer; software for use as a cryptocurrency wallet; software for use as an electronic wallet; software for creating and managing electronic wallets; software for digital currency payment and exchange transactions; software for managing and validating transactions involving digital assets, digital tokens, crypto-tokens, utility tokens, non-fungible tokens (NFTs), digital collectibles, crypto-collectibles, cryptocurrencies, digital currencies and virtual currencies; electronic payment processing software; game software; virtual reality software; software for creating NFTs; software for managing and verifying transactions on a blockchain; software for game development; gaming software development tools; blockchain gaming software; software for cryptocurrency mining; software for cryptocurrency farming; software for arranging and conducting auctions; software for voting; software for social networking; software development

tools; software for creating, managing, and interacting with an online community; software for creating, managing and accessing groups within virtual communities; file sharing software; communications software; software for sending and receiving electronic messages, graphics, images, audio and audio visual content via the internet and communication networks; software for creating, editing, uploading, downloading, accessing, viewing, posting, displaying, tagging, blogging, streaming, linking, annotating, indicating sentiment about, commenting on, voting on, embedding, transmitting, and sharing or otherwise providing electronic media or information via computer and communication networks; software for processing images, graphics, audio, video, and text; software for the collection, managing, editing, organizing, modifying, transmission, sharing, and storage of data and information; software for transmitting, sharing, receiving, downloading, displaying, interacting with and transferring content, text, visual works, audio works, audiovisual works, literary works, data, files, documents and electronic works; e-commerce software; e-commerce software to allow users to perform electronic business transactions via a global computer the internet and communication networks; software for processing electronic transactions; software for organizing, searching for and managing events; software for creating accounts and maintaining and managing information about financial transactions on distributed ledgers and peer to peer payment networks; software for use in financial trading; software for use in financial exchange; software for providing authentication of parties to a financial transaction; software for maintaining ledgers for financial transactions; software for the management of cryptographic security of electronic transmissions across computer networks; software for encrypting and enabling secure transmission of digital information over the Internet; software for currency conversion.

14 – Jewelry; imitation jewelry; watches; keychains; key rings.

16 – Printed publications; books; magazines; pictures; posters; stationery; trading cards.

18 – Bags; backpacks; luggage; wallets.

24 – Blankets; bedspreads.

25 – Clothing; hats; headwear; jackets; jerseys; pants; shirts; t-shirts; sweaters; sweatshirts; shoes; scarves; sneakers; socks.

27 – Rugs; carpets; mats.

28 – Toys, games and playthings; toy figurines; plush toys; action figures; balls; basketballs; playing cards; trading cards; hand-held units for playing electronic, computer, interactive, and video games; gaming devices; mobile gaming devices; amusement game machines; game consoles; game controllers for computer and video games; computer game joysticks; video ga-

me joysticks; gaming mice; gaming keypads; skateboards; skateboard decks; cases for gaming devices; game cards.

32 – Beer; energy drinks; non-alcoholic beverages; soft drinks.

33 – Alcoholic beverages; wine; liquor; spirits; liquors; cocktails.

35 – Retail services; advertising services; marketing services; market research; promotion services; business consulting services; facilitating the exchange and sale of products and services via computer and communication networks; providing online facilities for connecting buyers with sellers; providing an online marketplace; providing an online marketplace for digital assets, digital tokens, crypto-tokens, utility tokens, non-fungible tokens (NFTs), digital collectibles, crypto-collectibles, cryptocurrencies, digital currencies and virtual currencies; providing an online marketplace for buyers and sellers of digital goods authenticated by non-fungible tokens (NFTs); providing online marketplace to rent, borrow, and trade digital assets, digital tokens, crypto-tokens, utility tokens, non-fungible tokens (NFTs), digital collectibles, crypto-collectibles, cryptocurrencies, digital currencies and virtual currencies; providing a virtual marketplace for digital assets, digital tokens, crypto-tokens, utility tokens, non-fungible tokens (NFTs), digital collectibles, crypto-collectibles, cryptocurrencies, digital currencies and virtual currencies; providing a virtual marketplace for buyers and sellers of digital goods authenticated by non-fungible tokens (NFTs); providing a virtual marketplace to rent, borrow, and trade non-fungible tokens (NFTs); facilitating the exchange and sale of services and products of third parties via computer and communication networks; providing online marketplaces for sellers of goods and/or services; auction services; administration of voting services; promoting the goods and services of others via computer and communication networks; organization, management and administration of decentralized autonomous organizations (DAOs); administration services consisting of recording, management and tracking of ownership interests in decentralized autonomous organizations (DAOs).

36 – Financial services; monetary services; financial transaction services; financial exchange services; banking services; cryptocurrency services; digital currency services; electronic currency services; virtual currency services; cryptocurrency exchange services; cryptocurrency trading services; cryptocurrency payment processing; electronic payment services; electronic wallet services; currency exchange services; currency trading services; payment processing services; loan services; issuance of digital assets, digital tokens, crypto-tokens, utility tokens, non-fungible tokens (NFTs), digital collectibles, crypto-collectibles, cryptocurrencies, digital currencies and virtual currencies;

distribution, trading, lending, exchange, and transmission of digital assets, digital tokens, crypto-tokens, utility tokens, non-fungible tokens (NFTs), digital collectibles, crypto-collectibles, cryptocurrencies, digital currencies and virtual currencies; providing financial information; providing information in the fields of digital assets, digital tokens, crypto-tokens, utility tokens, non-fungible tokens (NFTs), digital collectibles, crypto-collectibles, cryptocurrencies, digital currencies and virtual currencies; financial affairs, namely, financial management, financial planning, financial forecasting, financial portfolio management and financial analysis and consultation; financial information provided by electronic means; brokerage services; currency dealing services; investment management services; electronic commerce payment services; blockchain-based payment verification services.

38 – Communications services; telecommunications; broadcasting services; electronic messaging services; streaming of audio, video and digital media content on the internet; streaming of electronic and video games; providing internet chat rooms; providing on-line forums for transmission of messages among computer users; streaming of data; computer aided transmission of information and images; providing an online community forum for users to share and stream information, audio, video, real-time news, entertainment content, and information; providing user access to digital images, text, audio, video, games, multimedia content, digital collectibles, crypto-collectibles, and non-fungible tokens (NFTs); electronic transmission of virtual and augmented reality content and data.

41 – Entertainment services; production and distribution of films, motion pictures, radio, television and web programs; production and post-production of multimedia entertainment content; providing non-downloadable movies, television shows, webcasts, audiovisual, and multimedia works via the internet; production of sound, video and multimedia recordings; providing online electronic, computer and video games; virtual reality arcade services; virtual reality game services; electronic publishing services; entertainment services, namely, providing virtual reality, augmented reality and mixed reality interactive entertainment, games, content and experiences; entertainment services, namely, providing online virtual reality, augmented reality and mixed reality environments; production of virtual reality, augmented reality and mixed reality video for entertainment purposes; multimedia entertainment production and publishing services; organizing exhibitions, events, and conferences for entertainment and cultural purposes.

42 – Software as a service (SaaS); platform as a service (PaaS); cloud computing services; design and development of computer hardware and software; computer, electronic and video game development services; design and development of decentralized applications; development and implementation of smart con-

tracts; information technology services; providing online non-downloadable software featuring electronic publications; providing online non-downloadable software featuring digital images, audio, video and multimedia files; providing online non-downloadable software featuring computer graphics; providing non-downloadable software; providing non-downloadable blockchain software; providing non-downloadable distributed ledger software; providing non-downloadable cryptography software; providing non-downloadable software for use with cryptocurrency; providing non-downloadable software for use with digital currency; providing non-downloadable software for use with virtual currency; providing non-downloadable software for minting, creating, and issuing digital assets, digital tokens, crypto-tokens, utility tokens, non-fungible tokens (NFTs), digital collectibles, crypto-collectibles, cryptocurrencies, digital currencies and virtual currencies; providing non-downloadable software for viewing and providing access to digital assets, digital tokens, crypto-tokens, utility tokens, non-fungible tokens (NFTs), digital collectibles, crypto-collectibles, cryptocurrencies, digital currencies and virtual currencies; providing non-downloadable software for distributing, trading, storing, sending, receiving, accepting, and transmitting digital assets, digital tokens, crypto-tokens, utility tokens, non-fungible tokens (NFTs), digital collectibles, crypto-collectibles, cryptocurrencies, digital currencies and virtual currencies; providing non-downloadable software for decentralized finance; providing non-downloadable software for creating and executing smart contracts; providing non-downloadable software for developing decentralized applications; providing non-downloadable software for recording, managing, tracking, and transferring ownership interests in decentralized autonomous organizations; providing non-downloadable software for management and governance of decentralized autonomous organizations; providing non-downloadable software for participating and voting in decentralized autonomous organizations; providing non-downloadable software for executing and recording financial transactions; providing non-downloadable distributed ledger software for use in processing financial transactions; providing non-downloadable software for electronic funds transfer; providing non-downloadable software for use as a cryptocurrency wallet; providing non-downloadable software for use as an electronic wallet; providing non-downloadable software for creating and managing electronic wallets; providing non-downloadable software for digital currency payment and exchange transactions; providing non-downloadable software for managing and validating transactions involving digital assets, digital tokens, crypto-tokens, utility tokens, non-fungible tokens (NFTs), digital collectibles, crypto-collectibles, cryptocurrencies, digital currencies and virtual currencies; providing non-downloadable electronic payment processing software; providing non-downloadable ga-

me software; providing non-downloadable virtual reality software; providing non-downloadable software for creating NFTs; providing non-downloadable software for managing and verifying transactions on a blockchain; providing non-downloadable software for game development; providing non-downloadable gaming software development tools; providing non-downloadable blockchain gaming software; providing non-downloadable software for cryptocurrency mining; providing non-downloadable software for cryptocurrency farming; providing non-downloadable software for arranging and conducting auctions; providing non-downloadable software for voting; providing non-downloadable software for social networking; providing non-downloadable software development tools; providing non-downloadable software for creating, managing, and interacting with an online community; providing non-downloadable software for creating, managing and accessing groups within virtual communities; providing non-downloadable file sharing software; providing non-downloadable communications software; providing non-downloadable software for sending and receiving electronic messages, graphics, images, audio and audio visual content via the internet and communication networks; providing non-downloadable software for creating, editing, uploading, downloading, accessing, viewing, posting, displaying, tagging, blogging, streaming, linking, annotating, indicating sentiment about, commenting on, voting on, embedding, transmitting, and sharing or otherwise providing electronic media or information via computer and communication networks; providing non-downloadable software for processing images, graphics, audio, video, and text; providing non-downloadable software for the collection, managing, editing, organizing, modifying, transmission, sharing, and storage of data and information; providing non-downloadable software for transmitting, sharing, receiving, downloading, displaying, interacting with and transferring content, text, visual works, audio works, audiovisual works, literary works, data, files, documents and electronic works; providing non-downloadable e-commerce software; providing non-downloadable e-commerce software to allow users to perform electronic business transactions via a global computer the internet and communication networks; providing non-downloadable software for processing electronic transactions; providing non-downloadable software for organizing, searching for and managing events; providing non-downloadable software for creating accounts and maintaining and managing information about financial transactions on distributed ledgers and peer to peer payment networks; providing non-downloadable software for use in financial trading; providing non-downloadable software for use in financial exchange; providing non-downloadable software for providing authentication of parties to a financial transaction; providing non-downloadable software for maintaining ledgers for financial transactions; provi-

ding non-downloadable software for the management of cryptographic security of electronic transmissions across computer networks; providing non-downloadable software for encrypting and enabling secure transmission of digital information over the Internet; providing non-downloadable software for currency conversion; creation of digital assets, digital tokens, crypto-tokens, utility tokens, non-fungible tokens (NFTs), digital collectibles, crypto-collectibles, cryptocurrencies, digital currencies and virtual currencies; electronic storage of digital assets, digital tokens, crypto-tokens, utility tokens, non-fungible tokens (NFTs), digital collectibles, crypto-collectibles, cryptocurrencies, digital currencies and virtual currencies; data and information security services; providing temporary use of non-downloadable software for enabling members of an online community buying, selling, trading, and discussing and exchanging information about digital assets, digital tokens, crypto-tokens, utility tokens, non-fungible tokens (NFTs), digital collectibles, crypto-collectibles, cryptocurrencies, digital currencies and virtual currencies.

43 – Restaurant services; bar services; hotel services.

45 – Online social networking services; providing authentication services for personal identification information; identity verification services.

(260) AM 2023 119953 A
 (800) 1690941
 (151) 2022 03 15
 (891) 2022 03 15
 (731) Yuga Labs Inc.
 1430 S. Dixie Hwy, Ste. 105 1075, Coral
 Gables FL 33146, USA
 (540)

BAYC

(591) Black, white
 (511)
 9 – Computer hardware; smartwatches; smart jewelry; eyewear; sunglasses; virtual reality glasses; headphones; headsets; gaming headsets; computer gaming peripherals; cases for computers, smartphones, headphones and headsets; light emitting diode (LED) signs; neon signs; downloadable computer software for blockchain technology; computer software for cryptocurrency; cryptocurrency hardware wallet; non-fungible token (NFT) multimedia files; non-fungible token (NFT) music files; non-fungible token (NFT) image files; non-fungible token (NFT) video files; non-fungible token (NFT) text files; non-fungible token (NFT) audio files; image, music, audio, video and multimedia files authenticated by non-fungible tokens (NFTs); downloadable electronic publications; digital images, audio, video and multimedia files; computer graphics; software; blockchain software; distributed ledger software; cryptography software; software for

use with cryptocurrency; software for use with digital currency; software for use with virtual currency; software for minting, creating, and issuing digital assets, digital tokens, crypto-tokens, utility tokens, non-fungible tokens (NFTs), digital collectibles, crypto-collectibles, cryptocurrencies, digital currencies and virtual currencies; software for viewing and providing access to digital assets, digital tokens, crypto-tokens, utility tokens, non-fungible tokens (NFTs), digital collectibles, crypto-collectibles, cryptocurrencies, digital currencies and virtual currencies; software for distributing, trading, storing, sending, receiving, accepting, and transmitting digital assets, digital tokens, crypto-tokens, utility tokens, non-fungible tokens (NFTs), digital collectibles, crypto-collectibles, cryptocurrencies, digital currencies and virtual currencies; software for decentralized finance; software for creating and executing smart contracts; software for developing decentralized applications; software for recording, managing, tracking, and transferring ownership interests in decentralized autonomous organizations; software for management and governance of decentralized autonomous organizations; software for participating and voting in decentralized autonomous organizations; software for executing and recording financial transactions; distributed ledger software for use in processing financial transactions; software for electronic funds transfer; software for use as a cryptocurrency wallet; software for use as an electronic wallet; software for creating and managing electronic wallets; software for digital currency payment and exchange transactions; software for managing and validating transactions involving digital assets, digital tokens, crypto-tokens, utility tokens, non-fungible tokens (NFTs), digital collectibles, crypto-collectibles, cryptocurrencies, digital currencies and virtual currencies; electronic payment processing software; game software; virtual reality software; software for creating NFTs; software for managing and verifying transactions on a blockchain; software for game development; gaming software development tools; blockchain gaming software; software for cryptocurrency mining; software for cryptocurrency farming; software for arranging and conducting auctions; software for voting; software for social networking; software development tools; software for creating, managing, and interacting with an online community; software for creating, managing and accessing groups within virtual communities; file sharing software; communications software; software for sending and receiving electronic messages, graphics, images, audio and audio visual content via the internet and communication networks; software for creating, editing, uploading, downloading, accessing, viewing, posting, displaying, tagging, blogging, streaming, linking, annotating, indicating sentiment about, commenting on, voting on, embedding, transmitting, and sharing or otherwise providing electronic media or information via computer and communication networks; software for processing images,

graphics, audio, video, and text; software for the collection, managing, editing, organizing, modifying, transmission, sharing, and storage of data and information; software for transmitting, sharing, receiving, downloading, displaying, interacting with and transferring content, text, visual works, audio works, audiovisual works, literary works, data, files, documents and electronic works; e-commerce software; e-commerce software to allow users to perform electronic business transactions via a global computer the internet and communication networks; software for processing electronic transactions; software for organizing, searching for and managing events; software for creating accounts and maintaining and managing information about financial transactions on distributed ledgers and peer to peer payment networks; software for use in financial trading; software for use in financial exchange; software for providing authentication of parties to a financial transaction; software for maintaining ledgers for financial transactions; software for the management of cryptographic security of electronic transmissions across computer networks; software for encrypting and enabling secure transmission of digital information over the Internet; software for currency conversion.

14 – Jewelry; imitation jewelry; watches; keychains; key rings.

16 – Printed publications; books; magazines; pictures; posters; stationery; trading cards.

18 – Bags; backpacks; luggage; wallets.

24 – Blankets; bedspreads.

25 – Clothing; hats; headwear; jackets; jerseys; pants; shirts; t-shirts; sweaters; sweatshirts; shoes; scarves; sneakers; socks.

27 – Rugs; carpets; mats.

28 – Toys, games and playthings; toy figurines; plush toys; action figures; balls; basketballs; playing cards; trading cards; hand-held units for playing electronic, computer, interactive, and video games; gaming devices; mobile gaming devices; amusement game machines; game consoles; game controllers for computer and video games; computer game joysticks; video game joysticks; gaming mice; gaming keypads; skateboards; skateboard decks; cases for gaming devices; game cards.

32 – Beer; energy drinks; non-alcoholic beverages; soft drinks.

33 – Alcoholic beverages; wine; liquor; spirits; liquors; cocktails.

35 – Retail services; advertising services; marketing services; market research; promotion services; business consulting services; facilitating the exchange and sale of products and services via computer and communication networks; providing online facilities for

connecting buyers with sellers; providing an online marketplace; providing an online marketplace for digital assets, digital tokens, crypto-tokens, utility tokens, non-fungible tokens (NFTs), digital collectibles, crypto-collectibles, cryptocurrencies, digital currencies and virtual currencies; providing an online marketplace for buyers and sellers of digital goods authenticated by non-fungible tokens (NFTs); providing online marketplace to rent, borrow, and trade digital assets, digital tokens, crypto-tokens, utility tokens, non-fungible tokens (NFTs), digital collectibles, crypto-collectibles, cryptocurrencies, digital currencies and virtual currencies; providing a virtual marketplace for digital assets, digital tokens, crypto-tokens, utility tokens, non-fungible tokens (NFTs), digital collectibles, crypto-collectibles, cryptocurrencies, digital currencies and virtual currencies; providing a virtual marketplace for buyers and sellers of digital goods authenticated by non-fungible tokens (NFTs); providing a virtual marketplace to rent, borrow, and trade non-fungible tokens (NFTs); facilitating the exchange and sale of services and products of third parties via computer and communication networks; providing online marketplaces for sellers of goods and/or services; auction services; administration of voting services; promoting the goods and services of others via computer and communication networks; organization, management and administration of decentralized autonomous organizations (DAOs); administration services consisting of recording, management and tracking of ownership interests in decentralized autonomous organizations (DAOs).

36 – Financial services; monetary services; financial transaction services; financial exchange services; banking services; cryptocurrency services; digital currency services; electronic currency services; virtual currency services; cryptocurrency exchange services; cryptocurrency trading services; cryptocurrency payment processing; electronic payment services; electronic wallet services; currency exchange services; currency trading services; payment processing services; loan services; issuance of digital assets, digital tokens, crypto-tokens, utility tokens, non-fungible tokens (NFTs), digital collectibles, crypto-collectibles, cryptocurrencies, digital currencies and virtual currencies; distribution, trading, lending, exchange, and transmission of digital assets, digital tokens, crypto-tokens, utility tokens, non-fungible tokens (NFTs), digital collectibles, crypto-collectibles, cryptocurrencies, digital currencies and virtual currencies; providing financial information; providing information in the fields of digital assets, digital tokens, crypto-tokens, utility tokens, non-fungible tokens (NFTs), digital collectibles, crypto-collectibles, cryptocurrencies, digital currencies and virtual currencies; financial affairs, namely, financial management, financial planning, financial forecasting, financial portfolio management and financial analysis and consultation; financial information provided by electronic means; brokerage services;

currency dealing services; investment management services; electronic commerce payment services; blockchain-based payment verification services.

38 – Communications services; telecommunications; broadcasting services; electronic messaging services; streaming of audio, video and digital media content on the internet; streaming of electronic and video games; providing internet chat rooms; providing on-line forums for transmission of messages among computer users; streaming of data; computer aided transmission of information and images; providing an online community forum for users to share and stream information, audio, video, real-time news, entertainment content, and information; providing user access to digital images, text, audio, video, games, multimedia content, digital collectibles, crypto-collectibles, and non-fungible tokens (NFTs); electronic transmission of virtual and augmented reality content and data.

41 – Entertainment services; production and distribution of films, motion pictures, radio, television and web programs; production and post-production of multimedia entertainment content; providing non-downloadable movies, television shows, webcasts, audiovisual, and multimedia works via the internet; production of sound, video and multimedia recordings; providing online electronic, computer and video games; virtual reality arcade services; virtual reality game services; electronic publishing services; entertainment services, namely, providing virtual reality, augmented reality and mixed reality interactive entertainment, games, content and experiences; entertainment services, namely, providing online virtual reality, augmented reality and mixed reality environments; production of virtual reality, augmented reality and mixed reality video for entertainment purposes; multimedia entertainment production and publishing services; organizing exhibitions, events, and conferences for entertainment and cultural purposes.

42 – Software as a service (SaaS); platform as a service (PaaS); cloud computing services; design and development of computer hardware and software; computer, electronic and video game development services; design and development of decentralized applications; development and implementation of smart contracts; information technology services; providing online non-downloadable software featuring electronic publications; providing online non-downloadable software featuring digital images, audio, video and multimedia files; providing online non-downloadable software featuring computer graphics; providing non-downloadable software; providing non-downloadable blockchain software; providing non-downloadable distributed ledger software; providing non-downloadable cryptography software; providing non-downloadable software for use with cryptocurrency; providing non-downloadable software for use with digital currency; providing non-downloadable software for use with virtual currency; providing non-downloa-

dable software for minting, creating, and issuing digital assets, digital tokens, crypto-tokens, utility tokens, non-fungible tokens (NFTs), digital collectibles, crypto-collectibles, cryptocurrencies, digital currencies and virtual currencies; providing non-downloadable software for viewing and providing access to digital assets, digital tokens, crypto-tokens, utility tokens, non-fungible tokens (NFTs), digital collectibles, crypto-collectibles, cryptocurrencies, digital currencies and virtual currencies; providing non-downloadable software for distributing, trading, storing, sending, receiving, accepting, and transmitting digital assets, digital tokens, crypto-tokens, utility tokens, non-fungible tokens (NFTs), digital collectibles, crypto-collectibles, cryptocurrencies, digital currencies and virtual currencies; providing non-downloadable software for decentralized finance; providing non-downloadable software for creating and executing smart contracts; providing non-downloadable software for developing decentralized applications; providing non-downloadable software for recording, managing, tracking, and transferring ownership interests in decentralized autonomous organizations; providing non-downloadable software for management and governance of decentralized autonomous organizations; providing non-downloadable software for participating and voting in decentralized autonomous organizations; providing non-downloadable software for executing and recording financial transactions; providing non-downloadable distributed ledger software for use in processing financial transactions; providing non-downloadable software for electronic funds transfer; providing non-downloadable software for use as a cryptocurrency wallet; providing non-downloadable software for use as an electronic wallet; providing non-downloadable software for creating and managing electronic wallets; providing non-downloadable software for digital currency payment and exchange transactions; providing non-downloadable software for managing and validating transactions involving digital assets, digital tokens, crypto-tokens, utility tokens, non-fungible tokens (NFTs), digital collectibles, crypto-collectibles, cryptocurrencies, digital currencies and virtual currencies; providing non-downloadable electronic payment processing software; providing non-downloadable game software; providing non-downloadable virtual reality software; providing non-downloadable software for creating NFTs; providing non-downloadable software for managing and verifying transactions on a blockchain; providing non-downloadable software for game development; providing non-downloadable gaming software development tools; providing non-downloadable blockchain gaming software; providing non-downloadable software for cryptocurrency mining; providing non-downloadable software for cryptocurrency farming; providing non-downloadable software for arranging and conducting auctions; providing non-downloadable software for voting; providing non-downloadable software for social networking;

providing non-downloadable software development tools; providing non-downloadable software for creating, managing, and interacting with an online community; providing non-downloadable software for creating, managing and accessing groups within virtual communities; providing non-downloadable file sharing software; providing non-downloadable communications software; providing non-downloadable software for sending and receiving electronic messages, graphics, images, audio and audio visual content via the internet and communication networks; providing non-downloadable software for creating, editing, uploading, downloading, accessing, viewing, posting, displaying, tagging, blogging, streaming, linking, annotating, indicating sentiment about, commenting on, voting on, embedding, transmitting, and sharing or otherwise providing electronic media or information via computer and communication networks; providing non-downloadable software for processing images, graphics, audio, video, and text; providing non-downloadable software for the collection, managing, editing, organizing, modifying, transmission, sharing, and storage of data and information; providing non-downloadable software for transmitting, sharing, receiving, downloading, displaying, interacting with and transferring content, text, visual works, audio works, audiovisual works, literary works, data, files, documents and electronic works; providing non-downloadable e-commerce software; providing non-downloadable e-commerce software to allow users to perform electronic business transactions via a global computer the internet and communication networks; providing non-downloadable software for processing electronic transactions; providing non-downloadable software for organizing, searching for and managing events; providing non-downloadable software for creating accounts and maintaining and managing information about financial transactions on distributed ledgers and peer to peer payment networks; providing non-downloadable software for use in financial trading; providing non-downloadable software for use in financial exchange; providing non-downloadable software for providing authentication of parties to a financial transaction; providing non-downloadable software for maintaining ledgers for financial transactions; providing non-downloadable software for the management of cryptographic security of electronic transmissions across computer networks; providing non-downloadable software for encrypting and enabling secure transmission of digital information over the Internet; providing non-downloadable software for currency conversion; creation of digital assets, digital tokens, crypto-tokens, utility tokens, non-fungible tokens (NFTs), digital collectibles, crypto-collectibles, cryptocurrencies, digital currencies and virtual currencies; electronic storage of digital assets, digital tokens, crypto-tokens, utility tokens, non-fungible tokens (NFTs), digital collectibles, crypto-collectibles, cryptocurrencies, digital currencies and virtual currencies; data and in-

formation security services; providing temporary use of non-downloadable software for enabling members of an online community buying, selling, trading, and discussing and exchanging information about digital assets, digital tokens, crypto-tokens, utility tokens, non-fungible tokens (NFTs), digital collectibles, crypto-collectibles, cryptocurrencies, digital currencies and virtual currencies.

43 – Restaurant services; bar services; hotel services.

45 – Online social networking services; providing authentication services for personal identification information; identity verification services.

(260) AM 2023 119954 A

(800) 1690942

(151) 2022 03 15

(891) 2022 03 15

(731) Yuga Labs Inc.

1430 S. Dixie Hwy, Ste. 105 1075, Coral

Gables FL 33146, USA

(540)

MUTANT APE YACHT CLUB

(591) Black, white

(511)

9 – Computer hardware; smartwatches; smart jewelry; eyewear; sunglasses; virtual reality glasses; headphones; headsets; gaming headsets; computer gaming peripherals; cases for computers, smartphones, headphones and headsets; light emitting diode (LED) signs; neon signs; downloadable computer software for blockchain technology; computer software for cryptocurrency; cryptocurrency hardware wallet; non-fungible token (NFT) multimedia files; non-fungible token (NFT) music files; non-fungible token (NFT) image files; non-fungible token (NFT) video files; non-fungible token (NFT) text files; non-fungible token (NFT) audio files; image, music, audio, video and multimedia files authenticated by non-fungible tokens (NFTs); downloadable electronic publications; digital images, audio, video and multimedia files; computer graphics; software; blockchain software; distributed ledger software; cryptography software; software for use with cryptocurrency; software for use with digital currency; software for use with virtual currency; software for minting, creating, and issuing digital assets, digital tokens, crypto-tokens, utility tokens, non-fungible tokens (NFTs), digital collectibles, crypto-collectibles, cryptocurrencies, digital currencies and virtual currencies; software for viewing and providing access to digital assets, digital tokens, crypto-tokens, utility tokens, non-fungible tokens (NFTs), digital collectibles, crypto-collectibles, cryptocurrencies, digital currencies and virtual currencies; software for distributing, trading, storing, sending, receiving, accepting, and transmitting digital assets, digital tokens, crypto-tokens, utility tokens, non-fungible tokens (NFTs), digital collectibles, crypto-collectibles, cryptocurren-

cies, digital currencies and virtual currencies; software for decentralized finance; software for creating and executing smart contracts; software for developing decentralized applications; software for recording, managing, tracking, and transferring ownership interests in decentralized autonomous organizations; software for management and governance of decentralized autonomous organizations; software for participating and voting in decentralized autonomous organizations; software for executing and recording financial transactions; distributed ledger software for use in processing financial transactions; software for electronic funds transfer; software for use as a cryptocurrency wallet; software for use as an electronic wallet; software for creating and managing electronic wallets; software for digital currency payment and exchange transactions; software for managing and validating transactions involving digital assets, digital tokens, crypto-tokens, utility tokens, non-fungible tokens (NFTs), digital collectibles, crypto-collectibles, cryptocurrencies, digital currencies and virtual currencies; electronic payment processing software; game software; virtual reality software; software for creating NFTs; software for managing and verifying transactions on a blockchain; software for game development; gaming software development tools; blockchain gaming software; software for cryptocurrency mining; software for cryptocurrency farming; software for arranging and conducting auctions; software for voting; software for social networking; software development tools; software for creating, managing, and interacting with an online community; software for creating, managing and accessing groups within virtual communities; file sharing software; communications software; software for sending and receiving electronic messages, graphics, images, audio and audio visual content via the internet and communication networks; software for creating, editing, uploading, downloading, accessing, viewing, posting, displaying, tagging, blogging, streaming, linking, annotating, indicating sentiment about, commenting on, voting on, embedding, transmitting, and sharing or otherwise providing electronic media or information via computer and communication networks; software for processing images, graphics, audio, video, and text; software for the collection, managing, editing, organizing, modifying, transmission, sharing, and storage of data and information; software for transmitting, sharing, receiving, downloading, displaying, interacting with and transferring content, text, visual works, audio works, audiovisual works, literary works, data, files, documents and electronic works; e-commerce software; e-commerce software to allow users to perform electronic business transactions via a global computer the internet and communication networks; software for processing electronic transactions; software for organizing, searching for and managing events; software for creating accounts and maintaining and managing information about financial transactions on distributed ledgers

and peer to peer payment networks; software for use in financial trading; software for use in financial exchange; software for providing authentication of parties to a financial transaction; software for maintaining ledgers for financial transactions; software for the management of cryptographic security of electronic transmissions across computer networks; software for encrypting and enabling secure transmission of digital information over the Internet; software for currency conversion.

14 – Jewelry; imitation jewelry; watches; keychains; key rings.

16 – Printed publications; books; magazines; pictures; posters; stationery; trading cards.

18 – Bags; backpacks; luggage; wallets.

24 – Blankets; bedspreads.

25 – Clothing; hats; headwear; jackets; jerseys; pants; shirts; t-shirts; sweaters; sweatshirts; shoes; scarves; sneakers; socks.

27 – Rugs; carpets; mats.

28 – Toys, games and playthings; toy figurines; plush toys; action figures; balls; basketballs; playing cards; trading cards; hand-held units for playing electronic, computer, interactive, and video games; gaming devices; mobile gaming devices; amusement game machines; game consoles; game controllers for computer and video games; computer game joysticks; video game joysticks; gaming mice; gaming keypads; skateboards; skateboard decks; cases for gaming devices; game cards.

32 – Beer; energy drinks; non-alcoholic beverages; soft drinks.

33 – Alcoholic beverages; wine; liquor; spirits; liqueurs; cocktails.

35 – Retail services; advertising services; marketing services; market research; promotion services; business consulting services; facilitating the exchange and sale of products and services via computer and communication networks; providing online facilities for connecting buyers with sellers; providing an online marketplace; providing an online marketplace for digital assets, digital tokens, crypto-tokens, utility tokens, non-fungible tokens (NFTs), digital collectibles, crypto-collectibles, cryptocurrencies, digital currencies and virtual currencies; providing an online marketplace for buyers and sellers of digital goods authenticated by non-fungible tokens (NFTs); providing online marketplace to rent, borrow, and trade digital assets, digital tokens, crypto-tokens, utility tokens, non-fungible tokens (NFTs), digital collectibles, crypto-collectibles, cryptocurrencies, digital currencies and virtual currencies; providing a virtual marketplace for digital assets, digital tokens, crypto-tokens, utility tokens, non-fungible tokens (NFTs), digital collectib-

les, crypto-collectibles, cryptocurrencies, digital currencies and virtual currencies; providing a virtual marketplace for buyers and sellers of digital goods authenticated by non-fungible tokens (NFTs); providing a virtual marketplace to rent, borrow, and trade non-fungible tokens (NFTs); facilitating the exchange and sale of services and products of third parties via computer and communication networks; providing online marketplaces for sellers of goods and/or services; auction services; administration of voting services; promoting the goods and services of others via computer and communication networks; organization, management and administration of decentralized autonomous organizations (DAOs); administration services consisting of recording, management and tracking of ownership interests in decentralized autonomous organizations (DAOs).

36 – Financial services; monetary services; financial transaction services; financial exchange services; banking services; cryptocurrency services; digital currency services; electronic currency services; virtual currency services; cryptocurrency exchange services; cryptocurrency trading services; cryptocurrency payment processing; electronic payment services; electronic wallet services; currency exchange services; currency trading services; payment processing services; loan services; issuance of digital assets, digital tokens, crypto-tokens, utility tokens, non-fungible tokens (NFTs), digital collectibles, crypto-collectibles, cryptocurrencies, digital currencies and virtual currencies; distribution, trading, lending, exchange, and transmission of digital assets, digital tokens, crypto-tokens, utility tokens, non-fungible tokens (NFTs), digital collectibles, crypto-collectibles, cryptocurrencies, digital currencies and virtual currencies; providing financial information; providing information in the fields of digital assets, digital tokens, crypto-tokens, utility tokens, non-fungible tokens (NFTs), digital collectibles, crypto-collectibles, cryptocurrencies, digital currencies and virtual currencies; financial affairs, namely, financial management, financial planning, financial forecasting, financial portfolio management and financial analysis and consultation; financial information provided by electronic means; brokerage services; currency dealing services; investment management services; electronic commerce payment services; blockchain-based payment verification services.

38 – Communications services; telecommunications; broadcasting services; electronic messaging services; streaming of audio, video and digital media content on the internet; streaming of electronic and video games; providing internet chat rooms; providing on-line forums for transmission of messages among computer users; streaming of data; computer aided transmission of information and images; providing an online community forum for users to share and stream information, audio, video, real-time news, entertainment content, and information; providing user access to digital

images, text, audio, video, games, multimedia content, digital collectibles, crypto-collectibles, and non-fungible tokens (NFTs); electronic transmission of virtual and augmented reality content and data.

41 – Entertainment services; production and distribution of films, motion pictures, radio, television and web programs; production and post-production of multimedia entertainment content; providing non-downloadable movies, television shows, webcasts, audiovisual, and multimedia works via the internet; production of sound, video and multimedia recordings; providing online electronic, computer and video games; virtual reality arcade services; virtual reality game services; electronic publishing services; entertainment services, namely, providing virtual reality, augmented reality and mixed reality interactive entertainment, games, content and experiences; entertainment services, namely, providing online virtual reality, augmented reality and mixed reality environments; production of virtual reality, augmented reality and mixed reality video for entertainment purposes; multimedia entertainment production and publishing services; organizing exhibitions, events, and conferences for entertainment and cultural purposes.

42 – Software as a service (SaaS); platform as a service (PaaS); cloud computing services; design and development of computer hardware and software; computer, electronic and video game development services; design and development of decentralized applications; development and implementation of smart contracts; information technology services; providing online non-downloadable software featuring electronic publications; providing online non-downloadable software featuring digital images, audio, video and multimedia files; providing online non-downloadable software featuring computer graphics; providing non-downloadable software; providing non-downloadable blockchain software; providing non-downloadable distributed ledger software; providing non-downloadable cryptography software; providing non-downloadable software for use with cryptocurrency; providing non-downloadable software for use with digital currency; providing non-downloadable software for use with virtual currency; providing non-downloadable software for minting, creating, and issuing digital assets, digital tokens, crypto-tokens, utility tokens, non-fungible tokens (NFTs), digital collectibles, crypto-collectibles, cryptocurrencies, digital currencies and virtual currencies; providing non-downloadable software for viewing and providing access to digital assets, digital tokens, crypto-tokens, utility tokens, non-fungible tokens (NFTs), digital collectibles, crypto-collectibles, cryptocurrencies, digital currencies and virtual currencies; providing non-downloadable software for distributing, trading, storing, sending, receiving, accepting, and transmitting digital assets, digital tokens, crypto-tokens, utility tokens, non-fungible tokens (NFTs), digital collectibles, crypto-collectibles,

cryptocurrencies, digital currencies and virtual currencies; providing non-downloadable software for decentralized finance; providing non-downloadable software for creating and executing smart contracts; providing non-downloadable software for developing decentralized applications; providing non-downloadable software for recording, managing, tracking, and transferring ownership interests in decentralized autonomous organizations; providing non-downloadable software for management and governance of decentralized autonomous organizations; providing non-downloadable software for participating and voting in decentralized autonomous organizations; providing non-downloadable software for executing and recording financial transactions; providing non-downloadable distributed ledger software for use in processing financial transactions; providing non-downloadable software for electronic funds transfer; providing non-downloadable software for use as a cryptocurrency wallet; providing non-downloadable software for use as an electronic wallet; providing non-downloadable software for creating and managing electronic wallets; providing non-downloadable software for digital currency payment and exchange transactions; providing non-downloadable software for managing and validating transactions involving digital assets, digital tokens, crypto-tokens, utility tokens, non-fungible tokens (NFTs), digital collectibles, crypto-collectibles, cryptocurrencies, digital currencies and virtual currencies; providing non-downloadable electronic payment processing software; providing non-downloadable game software; providing non-downloadable virtual reality software; providing non-downloadable software for creating NFTs; providing non-downloadable software for managing and verifying transactions on a blockchain; providing non-downloadable software for game development; providing non-downloadable gaming software development tools; providing non-downloadable blockchain gaming software; providing non-downloadable software for cryptocurrency mining; providing non-downloadable software for cryptocurrency farming; providing non-downloadable software for arranging and conducting auctions; providing non-downloadable software for voting; providing non-downloadable software for social networking; providing non-downloadable software development tools; providing non-downloadable software for creating, managing, and interacting with an online community; providing non-downloadable software for creating, managing and accessing groups within virtual communities; providing non-downloadable file sharing software; providing non-downloadable communications software; providing non-downloadable software for sending and receiving electronic messages, graphics, images, audio and audio visual content via the internet and communication networks; providing non-downloadable software for creating, editing, uploading, downloading, accessing, viewing, posting, displaying, tagging, blogging, streaming, linking, an-

notating, indicating sentiment about, commenting on, voting on, embedding, transmitting, and sharing or otherwise providing electronic media or information via computer and communication networks; providing non-downloadable software for processing images, graphics, audio, video, and text; providing non-downloadable software for the collection, managing, editing, organizing, modifying, transmission, sharing, and storage of data and information; providing non-downloadable software for transmitting, sharing, receiving, downloading, displaying, interacting with and transferring content, text, visual works, audio works, audiovisual works, literary works, data, files, documents and electronic works; providing non-downloadable e-commerce software; providing non-downloadable e-commerce software to allow users to perform electronic business transactions via a global computer the internet and communication networks; providing non-downloadable software for processing electronic transactions; providing non-downloadable software for organizing, searching for and managing events; providing non-downloadable software for creating accounts and maintaining and managing information about financial transactions on distributed ledgers and peer to peer payment networks; providing non-downloadable software for use in financial trading; providing non-downloadable software for use in financial exchange; providing non-downloadable software for providing authentication of parties to a financial transaction; providing non-downloadable software for maintaining ledgers for financial transactions; providing non-downloadable software for the management of cryptographic security of electronic transmissions across computer networks; providing non-downloadable software for encrypting and enabling secure transmission of digital information over the Internet; providing non-downloadable software for currency conversion; creation of digital assets, digital tokens, crypto-tokens, utility tokens, non-fungible tokens (NFTs), digital collectibles, crypto-collectibles, cryptocurrencies, digital currencies and virtual currencies; electronic storage of digital assets, digital tokens, crypto-tokens, utility tokens, non-fungible tokens (NFTs), digital collectibles, crypto-collectibles, cryptocurrencies, digital currencies and virtual currencies; data and information security services; providing temporary use of non-downloadable software for enabling members of an online community buying, selling, trading, and discussing and exchanging information about digital assets, digital tokens, crypto-tokens, utility tokens, non-fungible tokens (NFTs), digital collectibles, crypto-collectibles, cryptocurrencies, digital currencies and virtual currencies.

43 – Restaurant services; bar services; hotel services.

45 – Online social networking services; providing authentication services for personal identification information; identity verification services.

(260) AM 2023 119955 A
 (800) 1690943
 (151) 2022 03 15
 (891) 2022 03 15
 (731) Yuga Labs Inc.
 1430 S. Dixie Hwy, Ste. 105 1075, Coral
 Gables FL 33146, USA

(540)

BORED APE KENNEL CLUB

(591) Black, white

(511)

9 – Computer hardware; smartwatches; smart jewelry; eyewear; sunglasses; virtual reality glasses; headphones; headsets; gaming headsets; computer gaming peripherals; cases for computers, smartphones, headphones and headsets; light emitting diode (LED) signs; neon signs; downloadable computer software for blockchain technology; computer software for cryptocurrency; cryptocurrency hardware wallet; non-fungible token (NFT) multimedia files; non-fungible token (NFT) music files; non-fungible token (NFT) image files; non-fungible token (NFT) video files; non-fungible token (NFT) text files; non-fungible token (NFT) audio files; image, music, audio, video and multimedia files authenticated by non-fungible tokens (NFTs); downloadable electronic publications; digital images, audio, video and multimedia files; computer graphics; software; blockchain software; distributed ledger software; cryptography software; software for use with cryptocurrency; software for use with digital currency; software for use with virtual currency; software for minting, creating, and issuing digital assets, digital tokens, crypto-tokens, utility tokens, non-fungible tokens (NFTs), digital collectibles, crypto-collectibles, cryptocurrencies, digital currencies and virtual currencies; software for viewing and providing access to digital assets, digital tokens, crypto-tokens, utility tokens, non-fungible tokens (NFTs), digital collectibles, crypto-collectibles, cryptocurrencies, digital currencies and virtual currencies; software for distributing, trading, storing, sending, receiving, accepting, and transmitting digital assets, digital tokens, crypto-tokens, utility tokens, non-fungible tokens (NFTs), digital collectibles, crypto-collectibles, cryptocurrencies, digital currencies and virtual currencies; software for decentralized finance; software for creating and executing smart contracts; software for developing decentralized applications; software for recording, managing, tracking, and transferring ownership interests in decentralized autonomous organizations; software for management and governance of decentralized autonomous organizations; software for participating and voting in decentralized autonomous organizations; software for executing and recording financial transactions; distributed ledger software for use in processing financial transactions; software for electronic funds transfer; software for use as a cryptocurrency wallet; software for use as an electronic wallet; software for creating and managing electronic wallets;

software for digital currency payment and exchange transactions; software for managing and validating transactions involving digital assets, digital tokens, crypto-tokens, utility tokens, non-fungible tokens (NFTs), digital collectibles, crypto-collectibles, cryptocurrencies, digital currencies and virtual currencies; electronic payment processing software; game software; virtual reality software; software for creating NFTs; software for managing and verifying transactions on a blockchain; software for game development; gaming software development tools; blockchain gaming software; software for cryptocurrency mining; software for cryptocurrency farming; software for arranging and conducting auctions; software for voting; software for social networking; software development tools; software for creating, managing, and interacting with an online community; software for creating, managing and accessing groups within virtual communities; file sharing software; communications software; software for sending and receiving electronic messages, graphics, images, audio and audio visual content via the internet and communication networks; software for creating, editing, uploading, downloading, accessing, viewing, posting, displaying, tagging, blogging, streaming, linking, annotating, indicating sentiment about, commenting on, voting on, embedding, transmitting, and sharing or otherwise providing electronic media or information via computer and communication networks; software for processing images, graphics, audio, video, and text; software for the collection, managing, editing, organizing, modifying, transmission, sharing, and storage of data and information; software for transmitting, sharing, receiving, downloading, displaying, interacting with and transferring content, text, visual works, audio works, audiovisual works, literary works, data, files, documents and electronic works; e-commerce software; e-commerce software to allow users to perform electronic business transactions via a global computer the internet and communication networks; software for processing electronic transactions; software for organizing, searching for and managing events; software for creating accounts and maintaining and managing information about financial transactions on distributed ledgers and peer to peer payment networks; software for use in financial trading; software for use in financial exchange; software for providing authentication of parties to a financial transaction; software for maintaining ledgers for financial transactions; software for the management of cryptographic security of electronic transmissions across computer networks; software for encrypting and enabling secure transmission of digital information over the Internet; software for currency conversion.

14 – Jewelry; imitation jewelry; watches; keychains; key rings.

16 – Printed publications; books; magazines; pictures; posters; stationery; trading cards.

18 – Bags; backpacks; luggage; wallets.

24 – Blankets; bedspreads.

25 – Clothing; hats; headwear; jackets; jerseys; pants; shirts; t-shirts; sweaters; sweatshirts; shoes; scarves; sneakers; socks.

27 – Rugs; carpets; mats.

28 – Toys, games and playthings; toy figurines; plush toys; action figures; balls; basketballs; playing cards; trading cards; hand-held units for playing electronic, computer, interactive, and video games; gaming devices; mobile gaming devices; amusement game machines; game consoles; game controllers for computer and video games; computer game joysticks; video game joysticks; gaming mice; gaming keypads; skateboards; skateboard decks; cases for gaming devices; game cards.

32 – Beer; energy drinks; non-alcoholic beverages; soft drinks.

33 – Alcoholic beverages; wine; liquor; spirits; liquors; cocktails.

35 – Retail services; advertising services; marketing services; market research; promotion services; business consulting services; facilitating the exchange and sale of products and services via computer and communication networks; providing online facilities for connecting buyers with sellers; providing an online marketplace; providing an online marketplace for digital assets, digital tokens, crypto-tokens, utility tokens, non-fungible tokens (NFTs), digital collectibles, crypto-collectibles, cryptocurrencies, digital currencies and virtual currencies; providing an online marketplace for buyers and sellers of digital goods authenticated by non-fungible tokens (NFTs); providing online marketplace to rent, borrow, and trade digital assets, digital tokens, crypto-tokens, utility tokens, non-fungible tokens (NFTs), digital collectibles, crypto-collectibles, cryptocurrencies, digital currencies and virtual currencies; providing a virtual marketplace for digital assets, digital tokens, crypto-tokens, utility tokens, non-fungible tokens (NFTs), digital collectibles, crypto-collectibles, cryptocurrencies, digital currencies and virtual currencies; providing a virtual marketplace for buyers and sellers of digital goods authenticated by non-fungible tokens (NFTs); providing a virtual marketplace to rent, borrow, and trade non-fungible tokens (NFTs); facilitating the exchange and sale of services and products of third parties via computer and communication networks; providing online marketplaces for sellers of goods and/or services; auction services; administration of voting services; promoting the goods and services of others via computer and communication networks; organization, management and administration of decentralized autonomous organizations (DAOs); administration services consisting of recording, management and tracking of ow-

nership interests in decentralized autonomous organizations (DAOs).

36 – Financial services; monetary services; financial transaction services; financial exchange services; banking services; cryptocurrency services; digital currency services; electronic currency services; virtual currency services; cryptocurrency exchange services; cryptocurrency trading services; cryptocurrency payment processing; electronic payment services; electronic wallet services; currency exchange services; currency trading services; payment processing services; loan services; issuance of digital assets, digital tokens, crypto-tokens, utility tokens, non-fungible tokens (NFTs), digital collectibles, crypto-collectibles, cryptocurrencies, digital currencies and virtual currencies; distribution, trading, lending, exchange, and transmission of digital assets, digital tokens, crypto-tokens, utility tokens, non-fungible tokens (NFTs), digital collectibles, crypto-collectibles, cryptocurrencies, digital currencies and virtual currencies; providing financial information; providing information in the fields of digital assets, digital tokens, crypto-tokens, utility tokens, non-fungible tokens (NFTs), digital collectibles, crypto-collectibles, cryptocurrencies, digital currencies and virtual currencies; financial affairs, namely, financial management, financial planning, financial forecasting, financial portfolio management and financial analysis and consultation; financial information provided by electronic means; brokerage services; currency dealing services; investment management services; electronic commerce payment services; blockchain-based payment verification services.

38 – Communications services; telecommunications; broadcasting services; electronic messaging services; streaming of audio, video and digital media content on the internet; streaming of electronic and video games; providing internet chat rooms; providing online forums for transmission of messages among computer users; streaming of data; computer aided transmission of information and images; providing an online community forum for users to share and stream information, audio, video, real-time news, entertainment content, and information; providing user access to digital images, text, audio, video, games, multimedia content, digital collectibles, crypto-collectibles, and non-fungible tokens (NFTs); electronic transmission of virtual and augmented reality content and data.

41 – Entertainment services; production and distribution of films, motion pictures, radio, television and web programs; production and post-production of multimedia entertainment content; providing non-downloadable movies, television shows, webcasts, audiovisual, and multimedia works via the internet; production of sound, video and multimedia recordings; providing online electronic, computer and video games; virtual reality arcade services; virtual reality game services; electronic publishing services; entertainment services, namely, providing virtual rea-

lity, augmented reality and mixed reality interactive entertainment, games, content and experiences; entertainment services, namely, providing online virtual reality, augmented reality and mixed reality environments; production of virtual reality, augmented reality and mixed reality video for entertainment purposes; multimedia entertainment production and publishing services; organizing exhibitions, events, and conferences for entertainment and cultural purposes.

42 – Software as a service (SaaS); platform as a service (PaaS); cloud computing services; design and development of computer hardware and software; computer, electronic and video game development services; design and development of decentralized applications; development and implementation of smart contracts; information technology services; providing online non-downloadable software featuring electronic publications; providing online non-downloadable software featuring digital images, audio, video and multimedia files; providing online non-downloadable software featuring computer graphics; providing non-downloadable software; providing non-downloadable blockchain software; providing non-downloadable distributed ledger software; providing non-downloadable cryptography software; providing non-downloadable software for use with cryptocurrency; providing non-downloadable software for use with digital currency; providing non-downloadable software for use with virtual currency; providing non-downloadable software for minting, creating, and issuing digital assets, digital tokens, crypto-tokens, utility tokens, non-fungible tokens (NFTs), digital collectibles, crypto-collectibles, cryptocurrencies, digital currencies and virtual currencies; providing non-downloadable software for viewing and providing access to digital assets, digital tokens, crypto-tokens, utility tokens, non-fungible tokens (NFTs), digital collectibles, crypto-collectibles, cryptocurrencies, digital currencies and virtual currencies; providing non-downloadable software for distributing, trading, storing, sending, receiving, accepting, and transmitting digital assets, digital tokens, crypto-tokens, utility tokens, non-fungible tokens (NFTs), digital collectibles, crypto-collectibles, cryptocurrencies, digital currencies and virtual currencies; providing non-downloadable software for decentralized finance; providing non-downloadable software for creating and executing smart contracts; providing non-downloadable software for developing decentralized applications; providing non-downloadable software for recording, managing, tracking, and transferring ownership interests in decentralized autonomous organizations; providing non-downloadable software for management and governance of decentralized autonomous organizations; providing non-downloadable software for participating and voting in decentralized autonomous organizations; providing non-downloadable software for executing and recording financial transactions; providing non-downloadable distributed ledger software for use in processing fi-

nancial transactions; providing non-downloadable software for electronic funds transfer; providing non-downloadable software for use as a cryptocurrency wallet; providing non-downloadable software for use as an electronic wallet; providing non-downloadable software for creating and managing electronic wallets; providing non-downloadable software for digital currency payment and exchange transactions; providing non-downloadable software for managing and validating transactions involving digital assets, digital tokens, crypto-tokens, utility tokens, non-fungible tokens (NFTs), digital collectibles, crypto-collectibles, cryptocurrencies, digital currencies and virtual currencies; providing non-downloadable electronic payment processing software; providing non-downloadable game software; providing non-downloadable virtual reality software; providing non-downloadable software for creating NFTs; providing non-downloadable software for managing and verifying transactions on a blockchain; providing non-downloadable software for game development; providing non-downloadable gaming software development tools; providing non-downloadable blockchain gaming software; providing non-downloadable software for cryptocurrency mining; providing non-downloadable software for cryptocurrency farming; providing non-downloadable software for arranging and conducting auctions; providing non-downloadable software for voting; providing non-downloadable software for social networking; providing non-downloadable software development tools; providing non-downloadable software for creating, managing, and interacting with an online community; providing non-downloadable software for creating, managing and accessing groups within virtual communities; providing non-downloadable file sharing software; providing non-downloadable communications software; providing non-downloadable software for sending and receiving electronic messages, graphics, images, audio and audio visual content via the internet and communication networks; providing non-downloadable software for creating, editing, uploading, downloading, accessing, viewing, posting, displaying, tagging, blogging, streaming, linking, annotating, indicating sentiment about, commenting on, voting on, embedding, transmitting, and sharing or otherwise providing electronic media or information via computer and communication networks; providing non-downloadable software for processing images, graphics, audio, video, and text; providing non-downloadable software for the collection, managing, editing, organizing, modifying, transmission, sharing, and storage of data and information; providing non-downloadable software for transmitting, sharing, receiving, downloading, displaying, interacting with and transferring content, text, visual works, audio works, audiovisual works, literary works, data, files, documents and electronic works; providing non-downloadable e-commerce software; providing non-downloadable e-commerce software to allow users to perform

electronic business transactions via a global computer the internet and communication networks; providing non-downloadable software for processing electronic transactions; providing non-downloadable software for organizing, searching for and managing events; providing non-downloadable software for creating accounts and maintaining and managing information about financial transactions on distributed ledgers and peer to peer payment networks; providing non-downloadable software for use in financial trading; providing non-downloadable software for use in financial exchange; providing non-downloadable software for providing authentication of parties to a financial transaction; providing non-downloadable software for maintaining ledgers for financial transactions; providing non-downloadable software for the management of cryptographic security of electronic transmissions across computer networks; providing non-downloadable software for encrypting and enabling secure transmission of digital information over the Internet; providing non-downloadable software for currency conversion; creation of digital assets, digital tokens, crypto-tokens, utility tokens, non-fungible tokens (NFTs), digital collectibles, crypto-collectibles, cryptocurrencies, digital currencies and virtual currencies; electronic storage of digital assets, digital tokens, crypto-tokens, utility tokens, non-fungible tokens (NFTs), digital collectibles, crypto-collectibles, cryptocurrencies, digital currencies and virtual currencies; data and information security services; providing temporary use of non-downloadable software for enabling members of an online community buying, selling, trading, and discussing and exchanging information about digital assets, digital tokens, crypto-tokens, utility tokens, non-fungible tokens (NFTs), digital collectibles, crypto-collectibles, cryptocurrencies, digital currencies and virtual currencies.

43 – Restaurant services; bar services; hotel services.

45 – Online social networking services; providing authentication services for personal identification information; identity verification services.

(260) AM 2023 119956 A

(800) 1690947

(151) 2022 03 15

(891) 2022 03 15

(731) Yuga Labs Inc.

1430 S. Dixie Hwy, Ste. 105 1075, Coral Gables FL 33146, USA

(540)

BAKC

(591) Black, white

(511)

9 – Computer hardware; smartwatches; smart jewelry; eyewear; sunglasses; virtual reality glasses; headphones; headsets; gaming headsets; computer gaming pe-

ripherals; cases for computers, smartphones, headphones and headsets; light emitting diode (LED) signs; neon signs; downloadable computer software for blockchain technology; computer software for cryptocurrency; cryptocurrency hardware wallet; non-fungible token (NFT) multimedia files; non-fungible token (NFT) music files; non-fungible token (NFT) image files; non-fungible token (NFT) video files; non-fungible token (NFT) text files; non-fungible token (NFT) audio files; image, music, audio, video and multimedia files authenticated by non-fungible tokens (NFTs); downloadable electronic publications; digital images, audio, video and multimedia files; computer graphics; software; blockchain software; distributed ledger software; cryptography software; software for use with cryptocurrency; software for use with digital currency; software for use with virtual currency; software for minting, creating, and issuing digital assets, digital tokens, crypto-tokens, utility tokens, non-fungible tokens (NFTs), digital collectibles, crypto-collectibles, cryptocurrencies, digital currencies and virtual currencies; software for viewing and providing access to digital assets, digital tokens, crypto-tokens, utility tokens, non-fungible tokens (NFTs), digital collectibles, crypto-collectibles, cryptocurrencies, digital currencies and virtual currencies; software for distributing, trading, storing, sending, receiving, accepting, and transmitting digital assets, digital tokens, crypto-tokens, utility tokens, non-fungible tokens (NFTs), digital collectibles, crypto-collectibles, cryptocurrencies, digital currencies and virtual currencies; software for decentralized finance; software for creating and executing smart contracts; software for developing decentralized applications; software for recording, managing, tracking, and transferring ownership interests in decentralized autonomous organizations; software for management and governance of decentralized autonomous organizations; software for participating and voting in decentralized autonomous organizations; software for executing and recording financial transactions; distributed ledger software for use in processing financial transactions; software for electronic funds transfer; software for use as a cryptocurrency wallet; software for use as an electronic wallet; software for creating and managing electronic wallets; software for digital currency payment and exchange transactions; software for managing and validating transactions involving digital assets, digital tokens, crypto-tokens, utility tokens, non-fungible tokens (NFTs), digital collectibles, crypto-collectibles, cryptocurrencies, digital currencies and virtual currencies; electronic payment processing software; game software; virtual reality software; software for creating NFTs; software for managing and verifying transactions on a blockchain; software for game development; gaming software development tools; blockchain gaming software; software for cryptocurrency mining; software for cryptocurrency farming; software for arranging and conducting auctions; software for vo-

ting; software for social networking; software development tools; software for creating, managing, and interacting with an online community; software for creating, managing and accessing groups within virtual communities; file sharing software; communications software; software for sending and receiving electronic messages, graphics, images, audio and audio visual content via the internet and communication networks; software for creating, editing, uploading, downloading, accessing, viewing, posting, displaying, tagging, blogging, streaming, linking, annotating, indicating sentiment about, commenting on, voting on, embedding, transmitting, and sharing or otherwise providing electronic media or information via computer and communication networks; software for processing images, graphics, audio, video, and text; software for the collection, managing, editing, organizing, modifying, transmission, sharing, and storage of data and information; software for transmitting, sharing, receiving, downloading, displaying, interacting with and transferring content, text, visual works, audio works, audiovisual works, literary works, data, files, documents and electronic works; e-commerce software; e-commerce software to allow users to perform electronic business transactions via a global computer the internet and communication networks; software for processing electronic transactions; software for organizing, searching for and managing events; software for creating accounts and maintaining and managing information about financial transactions on distributed ledgers and peer to peer payment networks; software for use in financial trading; software for use in financial exchange; software for providing authentication of parties to a financial transaction; software for maintaining ledgers for financial transactions; software for the management of cryptographic security of electronic transmissions across computer networks; software for encrypting and enabling secure transmission of digital information over the Internet; software for currency conversion.

14 – Jewelry; imitation jewelry; watches; keychains; key rings.

16 – Printed publications; books; magazines; pictures; posters; stationery; trading cards.

18 – Bags; backpacks; luggage; wallets.

24 – Blankets; bedspreads.

25 – Clothing; hats; headwear; jackets; jerseys; pants; shirts; t-shirts; sweaters; sweatshirts; shoes; scarves; sneakers; socks.

27 – Rugs; carpets; mats.

28 – Toys, games and playthings; toy figurines; plush toys; action figures; balls; basketballs; playing cards; trading cards; hand-held units for playing electronic, computer, interactive, and video games; gaming devices; mobile gaming devices; amusement game machines; game consoles; game controllers for computer

and video games; computer game joysticks; video game joysticks; gaming mice; gaming keypads; skateboards; skateboard decks; cases for gaming devices; game cards.

36 – Financial services; monetary services; financial transaction services; financial exchange services; banking services; cryptocurrency services; digital currency services; electronic currency services; virtual currency services; cryptocurrency exchange services; cryptocurrency trading services; cryptocurrency payment processing; electronic payment services; electronic wallet services; currency exchange services; currency trading services; payment processing services; loan services; issuance of digital assets, digital tokens, crypto-tokens, utility tokens, non-fungible tokens (NFTs), digital collectibles, crypto-collectibles, cryptocurrencies, digital currencies and virtual currencies; distribution, trading, lending, exchange, and transmission of digital assets, digital tokens, crypto-tokens, utility tokens, non-fungible tokens (NFTs), digital collectibles, crypto-collectibles, cryptocurrencies, digital currencies and virtual currencies; providing financial information; providing information in the fields of digital assets, digital tokens, crypto-tokens, utility tokens, non-fungible tokens (NFTs), digital collectibles, crypto-collectibles, cryptocurrencies, digital currencies and virtual currencies; financial affairs, namely, financial management, financial planning, financial forecasting, financial portfolio management and financial analysis and consultation; financial information provided by electronic means; brokerage services; currency dealing services; investment management services; electronic commerce payment services; blockchain-based payment verification services.

38 – Communications services; telecommunications; broadcasting services; electronic messaging services; streaming of audio, video and digital media content on the internet; streaming of electronic and video games; providing internet chat rooms; providing on-line forums for transmission of messages among computer users; streaming of data; computer aided transmission of information and images; providing an online community forum for users to share and stream information, audio, video, real-time news, entertainment content, and information; providing user access to digital images, text, audio, video, games, multimedia content, digital collectibles, crypto-collectibles, and non-fungible tokens (NFTs); electronic transmission of virtual and augmented reality content and data.

41 – Entertainment services; production and distribution of films, motion pictures, radio, television and web programs; production and post-production of multimedia entertainment content; providing non-downloadable movies, television shows, webcasts, audiovisual, and multimedia works via the internet; production of sound, video and multimedia recordings; providing online electronic, computer and video games; virtual reality arcade services; virtual rea-

lity game services; electronic publishing services; entertainment services, namely, providing virtual reality, augmented reality and mixed reality interactive entertainment, games, content and experiences; entertainment services, namely, providing online virtual reality, augmented reality and mixed reality environments; production of virtual reality, augmented reality and mixed reality video for entertainment purposes; multimedia entertainment production and publishing services; organizing exhibitions, events, and conferences for entertainment and cultural purposes.

42 – Software as a service (SaaS); platform as a service (PaaS); cloud computing services; design and development of computer hardware and software; computer, electronic and video game development services; design and development of decentralized applications; development and implementation of smart contracts; information technology services; providing online non-downloadable software featuring electronic publications; providing online non-downloadable software featuring digital images, audio, video and multimedia files; providing online non-downloadable software featuring computer graphics; providing non-downloadable software; providing non-downloadable blockchain software; providing non-downloadable distributed ledger software; providing non-downloadable cryptography software; providing non-downloadable software for use with cryptocurrency; providing non-downloadable software for use with digital currency; providing non-downloadable software for use with virtual currency; providing non-downloadable software for minting, creating, and issuing digital assets, digital tokens, crypto-tokens, utility tokens, non-fungible tokens (NFTs), digital collectibles, crypto-collectibles, cryptocurrencies, digital currencies and virtual currencies; providing non-downloadable software for viewing and providing access to digital assets, digital tokens, crypto-tokens, utility tokens, non-fungible tokens (NFTs), digital collectibles, crypto-collectibles, cryptocurrencies, digital currencies and virtual currencies; providing non-downloadable software for distributing, trading, storing, sending, receiving, accepting, and transmitting digital assets, digital tokens, crypto-tokens, utility tokens, non-fungible tokens (NFTs), digital collectibles, crypto-collectibles, cryptocurrencies, digital currencies and virtual currencies; providing non-downloadable software for decentralized finance; providing non-downloadable software for creating and executing smart contracts; providing non-downloadable software for developing decentralized applications; providing non-downloadable software for recording, managing, tracking, and transferring ownership interests in decentralized autonomous organizations; providing non-downloadable software for management and governance of decentralized autonomous organizations; providing non-downloadable software for participating and voting in decentralized autonomous organizations; providing non-downloadable software for executing and recording

financial transactions; providing non-downloadable distributed ledger software for use in processing financial transactions; providing non-downloadable software for electronic funds transfer; providing non-downloadable software for use as a cryptocurrency wallet; providing non-downloadable software for use as an electronic wallet; providing non-downloadable software for creating and managing electronic wallets; providing non-downloadable software for digital currency payment and exchange transactions; providing non-downloadable software for managing and validating transactions involving digital assets, digital tokens, crypto-tokens, utility tokens, non-fungible tokens (NFTs), digital collectibles, crypto-collectibles, cryptocurrencies, digital currencies and virtual currencies; providing non-downloadable electronic payment processing software; providing non-downloadable game software; providing non-downloadable virtual reality software; providing non-downloadable software for creating NFTs; providing non-downloadable software for managing and verifying transactions on a blockchain; providing non-downloadable software for game development; providing non-downloadable gaming software development tools; providing non-downloadable blockchain gaming software; providing non-downloadable software for cryptocurrency mining; providing non-downloadable software for cryptocurrency farming; providing non-downloadable software for arranging and conducting auctions; providing non-downloadable software for voting; providing non-downloadable software for social networking; providing non-downloadable software development tools; providing non-downloadable software for creating, managing, and interacting with an online community; providing non-downloadable software for creating, managing and accessing groups within virtual communities; providing non-downloadable file sharing software; providing non-downloadable communications software; providing non-downloadable software for sending and receiving electronic messages, graphics, images, audio and audio visual content via the internet and communication networks; providing non-downloadable software for creating, editing, uploading, downloading, accessing, viewing, posting, displaying, tagging, blogging, streaming, linking, annotating, indicating sentiment about, commenting on, voting on, embedding, transmitting, and sharing or otherwise providing electronic media or information via computer and communication networks; providing non-downloadable software for processing images, graphics, audio, video, and text; providing non-downloadable software for the collection, managing, editing, organizing, modifying, transmission, sharing, and storage of data and information; providing non-downloadable software for transmitting, sharing, receiving, downloading, displaying, interacting with and transferring content, text, visual works, audio works, audiovisual works, literary works, data, files, documents and electronic works; providing non-downloa-

dable e-commerce software; providing non-downloadable e-commerce software to allow users to perform electronic business transactions via a global computer the internet and communication networks; providing non-downloadable software for processing electronic transactions; providing non-downloadable software for organizing, searching for and managing events; providing non-downloadable software for creating accounts and maintaining and managing information about financial transactions on distributed ledgers and peer to peer payment networks; providing non-downloadable software for use in financial trading; providing non-downloadable software for use in financial exchange; providing non-downloadable software for providing authentication of parties to a financial transaction; providing non-downloadable software for maintaining ledgers for financial transactions; providing non-downloadable software for the management of cryptographic security of electronic transmissions across computer networks; providing non-downloadable software for encrypting and enabling secure transmission of digital information over the Internet; providing non-downloadable software for currency conversion; creation of digital assets, digital tokens, crypto-tokens, utility tokens, non-fungible tokens (NFTs), digital collectibles, crypto-collectibles, cryptocurrencies, digital currencies and virtual currencies; electronic storage of digital assets, digital tokens, crypto-tokens, utility tokens, non-fungible tokens (NFTs), digital collectibles, crypto-collectibles, cryptocurrencies, digital currencies and virtual currencies; data and information security services; providing temporary use of non-downloadable software for enabling members of an online community buying, selling, trading, and discussing and exchanging information about digital assets, digital tokens, crypto-tokens, utility tokens, non-fungible tokens (NFTs), digital collectibles, crypto-collectibles, cryptocurrencies, digital currencies and virtual currencies.

43 – Restaurant services; bar services; hotel services.

45 – Online social networking services; providing authentication services for personal identification information; identity verification services.

- (260) AM 2023 119957 A
- (800) 1691121
- (151) 2022 08 17
- (891) 2022 08 17
- (731) Tronios Group International B.V.
Bedrijvenpark Twente N 18, NL-7602 KR
Almelo, Netherlands
- (540)

FUZZIX

(591) Black, white

(511)
11 – Lighting apparatus; lighting and effect lighting apparatus for use in discotheques, restaurants, ballrooms, living rooms and vehicles, as well as outdoors; lighting and laser light effect apparatus; professional and consumer lighting/effects apparatus for light, smoke machines and laser effects; colour-changing lighting apparatus; led lighting installations; neon lighting; smoke machines; snow cannons; foam generators for entertainment purposes; smoke generating machines and lighting effect equipment; fixtures for light, smoke and laser light effects; fans [air-conditioning] and electric fans adapted for use with light and sound apparatus; fans [air-conditioning] and electric fans for use in combination with light, smoke and sound effects; lamps; laser light projectors; fixtures for lighting, fixtures for smoke machines and lighting and laser light effect apparatus; lamps for the aforesaid goods; fittings included in this class for the aforesaid lighting and lighting effects, including the following goods: tripods, transport crates, cables and plugs.

(260) AM 2023 119958 A
(800) 1691126
(151) 2022 08 17
(891) 2022 08 17
(731) Tronios Group International B.V.
Bedrijvenpark Twente N 18, NL-7602
KR Almelo, Netherlands

(540)
FÜZZIX

(591) Black, white
(531) 27.05.01; 27.05.17
(511)
11 – Lighting apparatus; lighting and effect lighting apparatus for use in discotheques, restaurants, ballrooms, living rooms and vehicles, as well as outdoors; lighting and laser light effect apparatus; professional and consumer lighting/effects apparatus for light, smoke machines and laser effects; colour-changing lighting apparatus; led lighting installations; neon lighting; smoke machines; snow cannons; foam generators for entertainment purposes; smoke generating machines and lighting effect equipment; fixtures for light, smoke and laser light effects; fans [air-conditioning] and electric fans adapted for use with light and sound apparatus; fans [air-conditioning] and electric fans for use in combination with light, smoke and sound effects; lamps; laser light projectors; fixtures for lighting, fixtures for smoke machines and lighting and laser light effect apparatus; lamps for the aforesaid goods; fittings included in this class for the aforesaid lighting and lighting effects, including the following goods: tripods, transport crates, cables and plugs.

(260) AM 2023 119959 A
(800) 1691227
(151) 2022 05 19
(891) 2022 05 19
(731) Euro Games Technology Ltd.
4, "Maritsa" Str., "Vranya-Lozen-
Triugulnika", BG-1151 Sofia, Bulgaria

(540)
Lucky Hit

(591) Black, white
(511)
9 – Software; computer gaming software; computer software packages; computer operating system software; computer software, recorded; software drivers; virtual reality software; games software; entertainment software for computer games; computer programs for network management; operating computer software for main frame computers; monitors (computer hardware); computer hardware; apparatus for recording images; monitors (computer programs); computer game programs; computer programs for recorded games; apparatus for recording, transmission or reproduction of sound or images; communications servers [computer hardware]; electronic components for gambling machines; computer application software featuring games and gaming; computer software for the administration of on-line games and gaming; computer hardware for games and gaming; hardware and software for gambling, gambling machines, gambling games on the Internet and via telecommunication network.

28 – Gaming machines for gambling; chips for gambling; mah-jong; arcade games; gambling machines operating with coins, notes and cards; games; electronic games; parlor games; gaming chips; gaming tables; slot machines [gaming machines]; LCD game machines; slot machines and gaming devices; coin-operated amusement machines; roulette chips; poker chips; chips and dice [gaming equipment]; gaming equipment for casinos; roulette tables; gaming roulette wheels; casino games; gambling machines and amusement machines, automatic and coin-operated; coin-operated amusement machines and/or electronic coin-operated amusement machines with or without the possibility of gain; boxes for coin-operated machines, slot machines and gaming machines; electronic or electrotechnical amusement machines and apparatus, gaming machines, coin-operated entertainment machines; housings for coin-operated machines, gaming equipment, gaming machines, machines for gambling; electropneumatic and electrical gambling machines (slot machines).

41 – Gambling; entertainment services related to gambling; gaming services for entertainment purposes; casino, gaming and gambling services; training in the development of software systems; provision of gaming equipment for gambling halls; providing casino

equipment [gambling]; gaming machine entertainment services; providing casino facilities [gambling]; gaming hall services; amusement arcade services; games equipment rental; rental of gaming machines; providing amusement arcade services; rental of gaming machines with images of fruits; editing or recording of sounds and images; sound recording and video entertainment services; hire of sound reproducing apparatus; provision of gaming equipment for casinos; providing of casino facilities; online gambling services; casino, gaming and gambling services; provision of gaming facilities, gaming hall facilities, Internet casinos and online gambling services.

(260) AM 2023 119961 A
 (800) 1691230
 (151) 2022 08 03
 (891) 2022 08 03
 (731) Koters Olha Mykhailivna
 Prospekt Nauky, 34, kv. 22, m. Kyiv 03028,
 Ukraine
 (540)



(591) Black, white
 (531) 25.03.01; 27.05.01; 27.05.09; 27.05.24
 (511)
 3 – Base gels for artificial nails; nail glitter; adhesives for nails; colored gels for artificial nails; nail polish, including gel nail polishes; varnish-removing preparations; nail care preparations; protective gels for artificial nails; nail polish removers; special cosmetic gels.

(260) AM 2023 119962 A
 (800) 1691237
 (151) 2022 09 12
 (891) 2022 09 12
 (731) Cortex Havacılık Ve Turizm Ticaret
 Anonim Şirketi
 Şenlikköy Mah. Billur Sk. 7 / 1 2 Bakırköy,
 İstanbul, Türkiye
 (540)



(591) Red, white and grey
 (531) 26.04.05; 27.05.01; 27.05.09; 27.05.10;
 29.01.12
 (511)
 39 – Land, water and air transport services, rental of land, water or air vehicles, arranging of tours, travel reservation, issuing of tickets for travel, courier services (messages or merchandise), car parking, garage

rental, boat storage, transport by pipeline, electricity distribution, water supplying, rescue operations for vehicles and goods, storage, wrapping and packaging of goods, transport and storage of trash, transport and storage of waste.

(260) AM 2023 119963 A
 (800) 1691320
 (151) 2022 09 19
 (891) 2022 09 19
 (731) Kia Corporation
 12, Heolleung-ro, Seocho-gu, Seoul 06797,
 Republic of Korea
 (540)

Kia

(591) Black, white
 (511)
 10 – Surgical robots; nanorobots for medical purposes; robotic exoskeleton suits for medical purposes; body rehabilitation apparatus for medical purposes; electroencephalographs; pulse measuring devices; apparatus for nerve location; artificial limbs; artificial joints; medical instruments; medical apparatus and instruments; artificial limbs, eyes and teeth; massaging apparatus for personal use; feeding bottles; sterilised clothing for surgical purposes; gloves for medical purposes.

(260) AM 2023 119964 A
 (800) 1691321
 (151) 2022 09 19
 (891) 2022 09 19
 (731) Kia Corporation
 12, Heolleung-ro, Seocho-gu, Seoul 06797,
 Republic of Korea
 (540)

Kia

(591) Black, white
 (511)
 25 – Footwear; sportswear; motorists' clothing; athletic pants; clothing; uniforms; leotards and tights; overcoats (except wear for exclusive use for sports and Korean traditional dress); jackets [clothing]; jumpers; short trousers; undergarments; short-sleeved T-shirts; long-sleeved T-shirts; socks; gloves for clothing having touch technology of electronic products; caps being headwear; winter face masks (clothing); face masks [clothing], not for medical or sanitary purposes; leather belts [clothing].

(260) AM 2023 119965 A
 (800) 1691322
 (151) 2022 09 19
 (891) 2022 09 19

(731) Kia Corporation
12, Heolleung-ro, Seocho-gu, Seoul 06797,
Republic of Korea
(540)

Kia

(591) Black, white
(511)
36 – Financing relating to automobiles; automobile lease financing; financial guarantee services for the reimbursement of expenses incurred as a result of vehicle breakdown; financial guarantee services for the reimbursement of expenses incurred as a result of vehicle accident; hire purchase financing services; credit and debit card services; factoring; processing of credit card payments; agencies for rent collection of parking; agencies for charge of parking; financial services for the management of prepaid credit cards with membership card function; providing information relating to financial and monetary affairs; automobile insurance services; consultancy and brokerage services relating to vehicle insurance; automobile insurance information; motor vehicle insurance brokerage; virtual money brokerage; on-line financial transactions; trading brokerage for blockchain-based non-fungible token (NFT); financial customs brokerage services; automobile appraisal; appraisal of used automobiles; providing information relating to the appraisal of used automobiles; collection of monetary donations for charitable purposes; providing information relating to the appraisal of automobiles.

(260) AM 2023 119966 A
(800) 1691323
(151) 2022 09 19
(891) 2022 09 19
(731) Kia Corporation
12, Heolleung-ro, Seocho-gu, Seoul 06797,
Republic of Korea
(540)

Kia

(591) Black, white
(511)
37 – Installation/maintenance/repair of compressed natural gas charger; garage services for the maintenance and repair of motor vehicles; automobile battery replacement services; vehicle battery charging; vehicle repair services; maintenance, servicing and repair of vehicles; electric motor vehicle maintenance and repair; hydrogen gas refuelling service for vehicles; vehicle service stations [refuelling and maintenance]; repair and maintenance of automobiles and parts thereof; providing information relating to the repair or maintenance of automobiles; motor vehicle maintenance and repair; automobile internals repair; repair and maintenance of vehicles; inspection of automobiles and parts thereof prior to maintenance and

repair; natural gas refuelling service for motor vehicles; tires maintenance and repair; recharging services for electric vehicles; repair and maintenance of engines for motor vehicles; repair of braking devices; installation, maintenance and repair of batteries and accumulators; recharging of batteries and accumulators; installation of automotive remote start systems; automobile cleaning and car washing; disinfecting for vehicles; custom installation of exterior, interior and mechanical parts of vehicles [tuning]; tuning of motor vehicles.

(260) AM 2023 119967 A
(800) 1691357
(151) 2022 02 01
(891) 2022 02 01
(731) Beymen Perakende Ve Tekstil Yatirimlari
Anonim Sirketi
Ayazağa Mah. Azerbaycan Cad., 3A 3 O 3
Sarıyer, İstanbul, Türkiye

(540)
B E Y M E N

(591) Black, white
(531) 27.05.01
(511)
18 – All-purpose carrying bags; all-purpose leather straps; all-purpose sports bags; artificial fur; backpacks for carrying babies; bags; handbags, bags [envelopes, pouches] of leather, for packaging; leather and imitation leather bags; clutch bags; coin purses of leather; coin purses of precious metal; wallets; multi-purpose purses [handbags]; credit card cases and holders [leather ware]; bags for campers; school satchels; shoe bags for travel; reusable shopping bags; bags for climbers; beach bags; book bags; hat boxes of leather; boxes of leather or imitation leather; briefcases; business card cases; carrying bags; clothing for pets and animals; collars, leashes and clothing for animals; cosmetic bags and cases sold empty; shaving bags sold empty; tool bags sold empty; covers for pets and animals; bags for carrying animals; fastenings for saddles; fur; furniture coverings of leather; handles for canes and walking sticks; harnesses; harness fittings; harness for animals; harness straps; imitation leather; infant carriers worn on the body; sling bags for carrying babies; pouch baby carriers; key bags and cases; labels of leather; leather, unworked or semi-worked; music cases and bags; reins [harness]; rucksacks; saddlebags; saddlery; shoulder belts [straps] of leather; stirrups; trunks; suitcases, luggage, travelling bags; travelling trunks; trimmings of leather for furniture; trolley suitcases; umbrellas; umbrellas and parasols; walking sticks; whips, harness and saddlery.
25 – Clothing, footwear and headwear for human beings namely clothing; outer clothing; waterproof clothing; overalls; overcoats; paper clothing; parkas; pe-

lerines; pelisses; petticoats; pockets for clothing; ponchos; rash guards; ready-made clothing; shirt fronts; shirts; shirt yokes; short-sleeve shirts; coats; collars [clothing]; combinations [clothing]; suits; dresses; dressing gowns; dress shields; sweaters; aprons [clothing]; jackets [clothing]; mantillas; masquerade costumes; leggings [leg warmers]; leggings [trousers]; leotards; tee-shirts; tights; trousers; trouser straps; uniforms; vests babies' pants [underwear]; bibs, not of paper; layettes [clothing]; bathing caps; bathing suits; bathing trunks; bath robes; bath sandals; bath slippers; beach clothes; beach shoes; wet suits for water-skiing; cyclists' clothing jackets [clothing]; jerseys [clothing]; sports uniforms; jumper dresses; kimonos; knitwear [clothing]; fishing vests; furs [clothing]; fur stoles; clothing containing slimming substances; clothing for gymnastics; clothing incorporating LEDs; motorists' clothing; belts [clothing]; money belts [clothing]; headwear; berets; caps being headwear; hats; headbands [clothing]; headscarves; hoods [clothing]; visors being headwear; ear muffs [clothing]; cuffs; detachable collars; gloves [clothing]; mittens; muffs [clothing]; neck gaiters; neckties; paper hats [clothing]; shower caps; ready-made linings [parts of clothing]; saris; sarongs; sashes for wear; scarfs; shawls; veils [clothing]; togas; turbans; bandanas [neckerchiefs]; ascots; bodices [lingerie]; camisoles; corselets; corsets [underclothing]; garters; girdles; boxer shorts; braces for clothing [suspenders]; gaiters; pyjamas; panties; brassieres; underpants; slips [underclothing]; underwear; sweat-absorbent underwear; hosiery; stockings; stocking suspenders; footwear; shoes; footwear uppers; boots; boots for sports; boot uppers; sandals; football boots; foot muffs, not electrically heated; gymnastic shoes; half-boots; heelpieces for footwear; heelpieces for stockings; heel protectors for shoes; heels; inner soles; galoshes; non-slipping devices for footwear; ski boots; ski gloves; skirts; shorts; skull caps; sleep masks; slippers; socks; sock suspenders; soles for footwear; sports jerseys; sports shoes; sports singlets.

35 – Advertising, marketing and public relations, organization of exhibitions and trade fairs for commercial or advertising purposes, office functions, secretarial services, compilation of statistics, systemization of information into computer databases, business management, business administration and business consultancy, accounting, commercial consultancy services, import-export agencies, arranging commercial transactions for others via online shops, advertising services to promote public awareness of the benefits of shopping, retail department stores featuring a bonus incentive program for customers, business management and consultation in the field of fee refund to customers, business consulting related to commerce and e-commerce, business management consultancy services, commercial intermediation services, commercial information agency services, commercial or industrial management assistance, provision of com-

mercial and business contact information, web indexing for commercial or advertising purposes, commercial information and advice for consumers, administration of consumer loyalty programs, administrative processing of purchase orders, business management of reimbursement programmes for others, compilation of information into computer databases, computerized file management, cost price analysis, market studies, marketing research, provision of on-line marketplace for buyers and sellers of goods and services, price comparison services, sales promotion for others, search engine optimization for sales promotion, telemarketing services, provision of online marketplace for buyers and sellers of goods and services, bringing together, for the benefit of others, of a variety of goods namely adhesives, paints, dyes, cosmetics, perfumery, toiletries, dentifrices, soaps, detergents, deodorants for personal use and household use, bleaching and cleaning preparations, dental care preparations, dentifrices, mouth washes, polishing preparations, candles, wax, liquid and gas fuel, pharmaceuticals, veterinary and medical preparations, disinfectants, dietary supplements, baby food, herbs and herbal beverages, sanitary preparations, sanitary diapers, sanitary pads, preparations for destroying vermin, fungicides, herbicides, goods and materials of common metal used for storage, wrapping, packaging and sheltering purposes, containers of metal (storage, transport), buildings, poles, frames of metal, metal boxes, packaging containers of metal, aluminium foil, fences made of metal, storage containers of metal, metal containers for the transportation of goods, ladders of metal, ironmongery, small hardware of metal, safes of metal, metal pallets and metal ropes for lifting, loading and transportation purposes, metal hangers, ties, straps, tapes and bands used for load-lifting and load-carrying, machines, machine tools and industrial robots for processing and shaping wood, metals, glass, plastics and minerals, 3D printers, machines and robotic mechanisms (machines) for use in agriculture and animal breeding, machines and robotic mechanisms (machines) for processing cereals, fruits, vegetables and food, electric kitchen machines for chopping, grinding, crushing, mixing and mincing foodstuff, washing machines, laundry washing machines, dishwashers, spin driers (not heated), electric cleaning machines for cleaning floors, carpets or floorings, vacuum cleaners and parts thereof, forks, spoons, knives and non-electric cutters, slicers, peelers for kitchen use, including those made of precious metals, tools and apparatus for personal beauty care use: tools and apparatus for shaving, epilation, manicure and pedicure, electric hand implements for straightening and curling hair, scissors, hand-operated hand tools for the repair of machines, apparatus and vehicles and for use in construction, agriculture, horticulture and forestry, electric or non-electric irons, steam irons, measurement apparatus and equipment including those for scientific, nautical, topographic, meteorological, industrial

and laboratory purposes, thermometers, barometers, ammeters, voltmeters, hygrometers, testing apparatus, telescopes, periscopes, directional compasses, speed indicators, laboratory apparatus, microscopes, magnifying glasses, stills, ovens and furnaces for laboratory experiments, apparatus for recording, transmission or reproduction of sound or images, cameras, photographic cameras, television apparatus, video recorders, CD and DVD players and recorders, MP3 players, computers, desktop computers, tablet computers, microphones, loudspeakers, earphones, telecommunications apparatus, apparatus for the reproduction of sound or images, computer peripheral devices, cell phones, covers for cell phones, telephone apparatus, computer printers, scanners as data processing equipment, photocopiers, magnetic and optic data carriers and computer software and programmes recorded thereto, downloadable and recordable electronic publications, encoded magnetic and optic cards, antennas, electronic components used in the electronic parts of machines and apparatus, semi-conductors, electronic circuits, integrated circuits, chips as integrated circuits, diodes, electronic transistors, magnetic heads for electronic apparatus, electronic locks, photocells, remote control apparatus for opening and closing doors, optical sensors, counters, clothing for protection against accidents, irradiation and fire, safety vests and life-saving apparatus and equipment, eyeglasses, sunglasses, optical lenses and cases, containers, parts and components thereof, apparatus and instruments for conducting, transforming, accumulating or controlling electricity, electric plugs, electricity junction boxes, electric switches, circuit breakers, fuses, lighting ballasts, battery starter cables, electrical circuit boards, electric resistances, electric sockets, electricity transformers, electrical adapters, battery chargers, electric door bells, electric and electronic cables, batteries, electric accumulators, alarms and anti-theft alarms, electric bells, fire extinguishing apparatus, fire engines, fire hose and fire hose nozzles, radar apparatus, sonars, night vision apparatus and instruments, decorative magnets, metronomes, medical orthopaedic articles, corsets for medical purposes, orthopaedic shoes, elastic bandages and supportive bandages, condoms, babies' bottles, babies' pacifiers, teats, teeters for babies, lighting installations, lights for vehicles and interior-exterior spaces, heating installations using solid, liquid or gas fuels or electricity, central heating boilers, boilers for heating installations, radiators, heat exchangers, stoves, kitchen stoves, solar thermal collectors, steam, gas and fog generators, steam boilers, acetylene generators, oxygen generators, nitrogen generators, installations for air-conditioning and ventilating, cooling installations and freezers, electric and gas-powered devices, installations and apparatus for cooking, drying and boiling: cookers, electric cooking pots, electric water heaters, barbecues, electric laundry driers, hair driers, hand drying apparatus, sanitary installations, taps [faucets], shower installations, toi-

lets, shower and bathing cubicles, bath tubs, toilet seats, sinks, wash-hand basins, water softening apparatus, water purification apparatus, water purification installations, waste water purification installations, electric bed warmers and electric blankets, not for medical use, electric pillow warmers, electric or non-electric foot warmers, hot water bottles, pasteurizers and sterilizers, motor land vehicles, motorcycles, mopeds, engines and motors for land vehicles, parts thereof, bicycles, vehicle seats, head-rests for vehicle seats, safety seats for children, for vehicles, seat covers for vehicles, vehicle covers, sun-blinds adapted for vehicles, wipers for vehicles, tires for vehicles, mirrors for vehicles, anti-skid chains for vehicles, air pumps for inflating tires, anti-theft alarms for vehicles, horns for vehicles, baby carriages, wheelchairs, pushchairs, shopping carts, shopping trolleys, vehicles for locomotion by water, vehicles for locomotion by air, fireworks, sprays for personal defence, jewellery, watches, statuettes and figurines of precious metal, clocks, watches, parts thereof, chronometers, music instruments, their cases, paper and cardboard, paper and cardboard for packaging and wrapping purposes, cardboard boxes, paper towels, toilet paper, paper napkins, plastic materials for packaging and wrapping purposes, printed publications, printed matter, books, magazines, newspapers, bill books, printed dispatch notes, printed vouchers, calendars, posters, photographs [printed], paintings, stickers [stationery], postage stamps, stationery, office stationery, instructional and teaching material [except furniture and apparatus], writing and drawing implements, artists' materials, paper products for stationery purposes, adhesives for stationery purposes, pens, pencils, erasers, adhesive tapes for stationery purposes, cardboard cartons [artists' materials], writing paper, copying paper, paper rolls for cash registers, drawing materials, chalkboards, painting pencils, watercolours [paintings], stationery, instructional and teaching material, writing and drawing implements, artists' materials, paper products for stationery purposes, adhesives for stationery purposes, pens, pencils, erasers, adhesive tapes for stationery purposes, cardboard cartons [artists' materials], writing paper, copying paper, paper rolls for cash registers, drawing materials, chalkboards, painting pencils, watercolours [paintings], pint roller, paint brushes, rosaries, goods made of leather, imitations of leather or other materials, designed for carrying items, bags, wallets, straps, boxes and trunks made of leather or stout leather, key cases, trunks [luggage], suitcases, umbrellas, parasols, walking sticks, monuments and statuettes of stone, concrete and marble, furniture, mattresses, pillows, air mattresses and cushions, sleeping bags for camping, water beds, mirrors, bouncing chairs for babies, playpens for babies, cradles, infant walkers, display boards, frames for pictures and paintings, identification plates, identification tags, nameplates, identification labels made of wood or synthetic materials, packaging containers of wood or plastics,

casks for use in transportation or storage, barrels, storage, drums, tanks, boxes, storage containers, transportation containers, chests, loading pallets and closures for the aforementioned goods, of wood or plastics, small hardware goods of wood or synthetic materials, furniture fittings, of wood or synthetic materials, opening and closing mechanisms of wood or synthetic materials, ornaments and decorative goods of wood, cork, reed, cane, wicker, horn, bone, ivory, whalebone, shell, amber, mother-of-pearl, meerschaum, beeswax, plastic or plaster, figurines, holiday ornaments for walls and sculptures, baskets, kennels, nesting boxes and beds for household pets, cages for household pets, indoor aquariums, vivarium and indoor terrariums for animals and plant cultivation, portable ladders, bamboo curtains, roller indoor blinds [for interiors], slatted indoor blinds, strip curtains, bead curtains for decoration, curtain hooks, curtain rings, curtain tie-backs, curtain rods, hand-operated non-electric cleaning instruments and appliances, brushes, other than paintbrushes, steel chips for cleaning, sponges for cleaning, steel wool for cleaning, cloths of textile for cleaning, gloves for dishwashing, non-electric polishing machines for household purposes, brooms for carpets, mops, tooth brushes, shaving brushes, hair brushes, non-electric household or kitchen utensils, service dishes, pots and pans, bottle openers, flower pots, drinking straws, non-electric cooking utensils, ironing boards and shaped covers therefor, drying racks for washing, clothes drying hangers, ornaments and decorative goods of glass, porcelain, earthenware or clay, statues, figurines and vases, perfume burners, perfume sprayers, perfume vaporizers, electric or non-electric make-up removing appliances, powder puffs, toilet cases, plant watering devices and containers, ropes, strings, hammocks, tents, bags of textile, yarns, threads, textile goods for household use, curtains, bed covers, sheets (textile), pillowcases, blankets, quilts, towels, flags, labels, blankets, clothing, headgear, footwear, swimwear, scarves, hats, caps, laces and embroidery, guipures, festoons, ribbons (haberdashery), ribbons and braid, fastening tapes for clothing, cords for clothing, letters and numerals for marking linen, embroidered emblems, badges for wear, not of precious metal, shoulder pads for clothing, buttons for clothing, fasteners for clothing, eyelets for clothing, zippers, buckles for shoes and belts, fasteners, shoe and belt buckles, pins, other than jewellery, adhesive patches for decoration of textile articles, laces, needles, sewing needles, needles for sewing machines, needles for knitting and embroidery, boxes for needles, needle cushions, artificial flowers, artificial fruits, hair pins, hair buckles, hair bands, decorative articles for the hair, wigs, hair extensions, electric or non-electric hair curlers, carpets, rugs, mats, wallpaper, wall hangings, games, toys, gymnastic and sporting articles, fishing tackle, artificial fishing bait, decoys for hunting and fishing, Christmas trees of artificial material, ornaments for Christmas trees, artificial snow, rattles

(playthings), novelties for parties, paper party hats, foodstuff, beverages, matches, tobacco and tobacco products enabling customers to conveniently view and purchase those goods, such services may be provided by retail stores, wholesale outlets, through vending machines, mail order catalogues or by means of electronic media, for example, through web sites or television shopping programmes.

(260) AM 2023 119968 A
 (800) 1691429
 (151) 2022 07 25
 (891) 2022 07 25
 (731) Bausch & Lomb Incorporated
 1400 N. Goodman Street, Rochester
 NY 14609, USA

(540)
ENVISTA ENVY
 (591) Black, white
 (531) 27.05.01
 (511)
 10 – Medical device, namely intraocular lenses for surgical implantation.

(260) AM 2023 119969 A
 (800) 1691488
 (151) 2022 08 23
 (891) 2022 08 23
 (731) Alpen Pharma AG
 Finkenhubelweg 16, CH-3012 Bern,
 Switzerland

(540)

 (591) Black, white
 (531) 27.05.01; 27.05.10
 (511)
 5 – Pharmaceutical products, medical and veterinary preparations; dietary supplements for humans and animals.

(260) AM 2023 119970 A
 (800) 1691489
 (151) 2022 08 23
 (891) 2022 08 23
 (731) Alpen Pharma AG
 Finkenhubelweg 16, CH-3012 Bern,
 Switzerland

(540)

(591) Black, white
 (531) 05.03.13; 05.03.14; 26.13.25; 27.05.01
 (511)
 5 – Pharmaceutical products, medical and veterinary preparations; dietary supplements for humans and animals.

(260) AM 2023 119971 A
 (800) 1691491
 (151) 2022 03 23
 (891) 2022 03 23
 (731) Midea Group Co., Ltd.
 B26-28F, Midea Headquarter Building,
 No.6 Midea Avenue, Beijiao, Shunde,
 Foshan, Guangdong, China
 (540)



(591) Black, white
 (531) 26.01.03; 26.01.19; 27.05.21
 (511)
 35 – Retail services for pharmaceutical, veterinary and sanitary preparations and medical supplies; rental of sales stands; sponsorship search; rental of vending machines; accounting; compilation of information into computer databases; personnel management consultancy, sales promotion for others; provision of an online marketplace for buyers and sellers of goods and services; marketing; commercial administration of the licensing of the goods and services of others; organization of exhibitions for commercial or advertising purposes; providing business information via a web site; providing commercial information and advice for consumers in the choice of products and services; business investigations; commercial information agency services; online advertising on a computer network; presentation of goods on communication media, for retail purposes; publicity.

42 – Software as a service [saas]; computer software design; updating of computer software; consultancy in the design and development of computer hardware; maintenance of computer software; computer system analysis; computer system design; installation of computer software; computer software consultancy; cloud computing.

(260) AM 2023 119977 A
 (800) 1456385
 (151) 2019 02 13
 (891) 2022 09 28
 (731) Symborg S.L.
 Avda. Campus de Espinardo, 7 CEEIM,
 E-30100 Murcia, Spain

(540)

BLUEN

(591) Black, white
 (511)
 1 – Chemical products for use in industry, science and photography, as well as in agriculture, horticulture and forestry; soil fertilizers; agricultural chemicals, except fungicides, herbicides, insecticides and parasiticides; seaweed [fertilizers]; anti-sprouting products for vegetables; expanded clay for hydroponic plant cultivation [substrate]; bacterial preparations other than for medical or veterinary purposes; bactericides for use in wine making [chemicals used in wine making]; bacteriological preparations other than for medical or veterinary use; biological preparations other than for medical or veterinary use; grafting wax for trees; compost; cultures of microorganisms other than for medical or veterinary use; plasters for use in forestry; slag [fertilizer]; fertilizers; fertilizers made of fish flour; fertilizing products; phosphates [fertilizers]; chemical additives for fungicides; genes of seeds for agricultural production; guano; hormones for hastening the ripening of fruit; chemical products for use in horticulture, except fungicides, herbicides, insecticides and parasiticides; humus; chemical additives for insecticides; peat pots for horticulture; grafting mastic for trees; fillers for tree cavities [forestry]; chemicals for protection against mildew; mineral acids; nitrogenous fertilizers; nitrogen; chemical preparations for scientific use other than for medical or veterinary use; salts [fertilizers]; seed preserving products; chemical products for use in forestry, except fungicides, herbicides, insecticides and parasiticides; superphosphates [fertilizers]; substrates for soil-free growing [agriculture]; agricultural soil; diatomaceous earth; loam; peat [fertilizer]; chemical products for protection against vine disease.

(260) AM 2023 119978 A
 (800) 1591148
 (151) 2021 03 05
 (891) 2022 09 16
 (731) Apple Inc.
 One Apple Park Way, Cupertino CA 95014,
 USA
 (540)

CERAMIC SHIELD

(591) Black, white
 (511)
 9 – Display screens for computers, mobile telephones and mobile electronic devices; covers for computers, mobile telephones and mobile digital electronic devices.

(260) AM 2023 119979 A
 (800) 1622441
 (151) 2021 05 06
 (891) 2022 09 27
 (731) S&S Brand Holdings LLC
 (a company incorporated and registered in the State of New York)
 240 Madison Avenue, 15th Floor, New York
 NY 10016, USA

(540)



(591) Black, white
 (531) 25.01.25; 27.05.01; 27.05.04; 27.05.21
 (511)
 25 – Clothing, footwear, headgear; goods made of leather and imitations of leather, namely belts.

(260) AM 2023 119980 A
 (800) 1631282
 (151) 2021 10 11
 (891) 2022 09 27
 (731) Conceptum Logistics Group Holding GmbH
 Pinnaßberg 47, 20359 Hamburg, Germany
 (540)



(591) Black, white
 (531) 26.11.01; 26.11.13; 27.05.22
 (511)
 9 – Computer software with regard to logistics, supply chain management and e-business portals.

35 – Professional business planning and development of goods storage, consignment stocks and transshipment centres; professional business consultancy in connection with the planning and development of goods storage, consignment stocks and transshipment centres; drawing up all transit documents; creating, establishing, managing, updating, archiving, coordinating, selecting, formatting, analysing, organising and rental of addresses or address data files.

36 – Insurance; shipping insurance; insurance brokerage, in particular transport insurance brokerage; customs brokerage; electronic commerce payment services, namely, establishing funded accounts used to purchase goods and services on the Internet, electronic credit card transactions; financial affairs.

39 – Transport, in particular transport of goods by

motor vehicle, lorry, rail, ship and aeroplane; packaging and storage of goods; transportation information; freight brokerage services; shipbrokerage, brokerage of ships' cargoes, freight forwarding, transport brokerage, unloading of freight; storage information; courier services; logistics in the transport sector; information technology-aided parcelled transport; logistics consultancy in the transport sector; collection, transport and delivery of goods, in particular documents, packages, parcels, letters and pallets; freighting by ship, aeroplane, rail, motor vehicle and lorry; tracking by means of the electronic tracking of goods, in particular documents, packages, parcels, letters and pallets, included in this class; warehouse management, organisation and handling of returned goods (returns management); rental of storage containers; letter, freight and express services; logistics consultancy; dispatch handling/conducting; organising goods and dispatch data; providing information relating to handling, transport and logistics, in particular the handling of documents, letters, packages, parcels and pallets; providing information in the field of the transport, storage and packaging of goods; rental of storage containers, warehousing, rental of warehouses; rental of motor vehicles, cars and wagons; courier services for goods.

42 – Technical planning and development of goods storage, consignment stocks and transshipment centres as well as technical consultancy in connection with the planning and development of goods storage, consignment stocks and transshipment centres; development of computer software for logistics, supply chain management and commercial Internet platforms (e-business portals); technical consultancy in the field of the setting up and development of e-business portals as well as supply chain management.

(260) AM 2023 119981 A
 (800) 1650889
 (151) 2022 02 03
 (891) 2022 10 05
 (731) Duvel Moortgat, Naamloze Vennootschap
 Breendonkdorp 58, B-2870 Puurs, Belgium
 (540)



(591) Red and gold
 (531) 01.01.04; 01.01.10; 04.01.02; 04.01.04;
 11.03.02; 25.01.25; 27.05.01; 27.05.17;
 29.01.13
 (511)
 32 – Ales; beers.

(260) AM 2023 119982 A
 (800) 1669612
 (151) 2022 03 10
 (891) 2022 09 21
 (731) JULES
 152 avenue Alfred Motte, F-59100 ROUBAIX,
 France
 (540)

JULES

(591) Green: Pantone 336
 (531) 27.05.01; 29.01.03
 (511)
 25 – Clothing, footwear, headwear; clothing of leather or imitation of leather; belts (clothing); furs (clothing); gloves (clothing); scarves; neckties; hosiery; socks; bedroom slippers; beach, ski or sports footwear; underwear; hats; caps; berets; stocking caps; long scarves; bandanas [neckerchiefs]; bow ties; shirts; short-sleeve shirts; overalls; tee-shirts; sweaters; sweaters; pullovers; sweatshirts; hooded sweatshirts; trousers; shorts; swimming shorts; sports shorts; Bermuda shorts; skirts; dresses; tights; stockings; jackets; coats; raincoats; suits; dressing gowns (robes); pajamas; bathing suits; bathrobes; footwear.

(260) AM 2023 120053 A
 (800) 1691547
 (151) 2022 09 07
 (891) 2022 09 07
 (731) Xyfil Ltd
 15-19 Sedgwick Street, Preston, Lancashire
 PR1 1TP, United Kingdom
 (540)

POD SALT Hit the Spot

(591) Black, white
 (511)
 34 – E-liquid for use in electronic cigarettes; electronic cigarette device.

(260) AM 2023 120056 A
 (800) 1691619
 (151) 2022 07 14
 (891) 2022 07 14
 (731) Sattorov Abduraxim Abdug'affor O'g'li
 h.14, 2-tor Sayguzar street, Shayhantoxur
 district, Tashkent city 100174, Uzbekistan
 (540)

VERANDA

(591) Black, white
 (531) 27.05.01
 (511)
 29 – Peas, preserved; mushrooms, preserved; beans, preserved; vegetables, canned; fruits, canned; corn oil for food; olive oil for food; vegetables, preserved; olives, preserved; fruit, preserved.

(260) AM 2023 120057 A
 (800) 1691635
 (151) 2022 09 16
 (891) 2022 09 16
 (731) Joint Stock Company "Fats and Oil Integrated Works"
 Ul. Titova 27, Ekaterinburg, RU-620085
 Sverdlovskaya Oblast, Russian Federation
 (540)

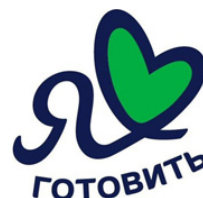

(591) Blue and green
 (531) 02.09.01; 28.05; 29.01.12
 (511)
 29 – Frozen prepared dishes consisting principally of meat; ham; cabbage rolls stuffed with meat; milk substitutes; buttercream; croquettes; margarine; oils for food, including flavoured oil for food; blended oil for food; peanut butter; cocoa butter for food; coconut oil for food; coconut butter; maize oil for food; sesame oil for food; linseed oil for food; extra virgin olive oil for food; olive oil for food; palm oil for food; palm kernel oil for food; sunflower oil for food; rape oil for food; soya bean oil for food; milk; peanut milk; peanut milk for culinary purposes; coconut milk; coconut milk for culinary purposes; almond milk; almond milk for culinary purposes; oat milk; rice milk; rice milk for culinary purposes; condensed milk; soured milk; soya milk; powdered milk; fermented baked milk; meat, including fresh meat; meat, frozen; fresh pre-cooked meat; frozen pre-cooked meat; frozen meat products; meat, preserved; peanut milk-based beverages; coconut milk-based beverages; almond milk-based beverages; liver pâté; liver; milk products; pork; cream [dairy products]; whipped cream; tripe; vegetable-based cream; fat-containing mixtures for bread slices; preparations for making bouillon; mixes for making soup, preparations for making soup, liquid preparations for making soup; preparations and mixes for making second courses consisting principally of dried vegetables; soups, including frozen soups; nut-based spreads; cottage cheese; strained soft white cheeses; vegetable yogurt; broth; frozen vegetables; frozen vegetable mixes.

30 – Mustard; buckwheat, processed; pasta; dressings for salad; dressings for soup; ketchup [sauce]; dulce de leche; hominy grits; semolina; oatmeal; crushed barley; groats for human food; mayonnaise; macaroni; cocoa beverages with milk; coffee beverages with milk; chocolate beverages with milk; pies; pizzas; condiments; rice; soya sauce; tomato sauce; sauces [condiments], including cream sauce; pasta sauce; preparations and mixes for making second courses consisting principally of groats; preparations and mixes for making second courses consisting principally

of pasta; dough, including frozen dough; pastry dough; frozen pastry dough; pastries.

(260) AM 2023 120058 A
 (800) 1691727
 (151) 2022 09 22
 (891) 2022 09 22
 (731) Hyundai Motor Company
 12, Heolleung-ro, Seocho-gu, Seoul 06797,
 Republic of Korea
 (540)



(591) Blue, red, black and white.
 (531) 24.11.25; 26.01.03; 26.01.18; 27.05.01;
 27.05.09; 29.01.14
 (511)
 25 – Footwear; sports shoes; sports overcoats; sportswear; athletic uniforms; sports shirts; driving gloves; clothing; outer clothing; children's clothing; overcoats (except wear for exclusive use for sports and Korean traditional dress); underwear; nighties; undergarments; ear muffs [clothing]; winter gloves; socks; sashes for wear; gloves including those made of skin, hide or fur; gloves for clothing having touch technology of electronic products; headwear; winter face masks (clothing); face coverings [clothing], not for medical or sanitary purposes; belts [clothing]; waterproof clothing.

(260) AM 2023 120059 A
 (800) 1691744
 (151) 2022 08 04
 (891) 2022 08 04
 (731) LTD "Valenta-Intellekt"
 ul. Ryabinovaya, d.26, str.10, k.6-26,
 RU-121471 Moscow, Russian Federation
 (540)



(591) Blue and white
 (531) 26.01.03; 26.01.16; 26.01.17; 26.01.24;
 27.07.01; 27.07.21; 27.07.24; 28.05;
 29.01.12
 (511)
 3 – Abrasives; amber [perfume]; descaling preparations for household purposes; antistatic preparations for

household purposes; aromatics [essential oils]; air fragrancing preparations; cake flavourings [essential oils]; flavourings for beverages [essential oils]; food flavourings [essential oils]; breath freshening sprays; canned pressurized air for cleaning and dusting purposes; balms, other than for medical purposes; basma [cosmetic dye]; lip glosses; nail glitter; polishing stones; abrasive paper; emery paper; polishing paper; petroleum jelly for cosmetic purposes; shoe polish; cobblers' wax; cotton wool for cosmetic purposes; sachets for perfuming linen; drying agents for dishwashing machines; adhesives for cosmetic purposes; scented water; Javelle water; lavender water; toilet water; wax for parquet floors; floor wax; non-slipping wax for floors; depilatory wax; moustache wax; tailors' wax; creams for leather; polish for furniture and flooring; shoemakers' wax; polishing wax; massage gels, other than for medical purposes; heliotropine; dental bleaching gels; geraniol; make-up; deodorants for pets; deodorants for human beings or for animals; depilatory preparations; air fragrance reed diffusers; scented wood; perfumes; non-slipping liquids for floors; windscreen cleaning liquids; greases for cosmetic purposes; volcanic ash for cleaning; perfumery; decorative transfers for cosmetic purposes; ionone [perfumery]; shaving stones [astringents]; smoothing stones; eyebrow pencils; cosmetic pencils; silicon carbide [abrasive]; carbides of metal [abrasives]; alum stones [astringents]; tripoli stone for polishing; adhesives for affixing false eyelashes; adhesives for affixing false hair; hair conditioners; quillaia bark for washing; corundum [abrasive]; beard dyes; colorants for toilet purposes; cosmetic dyes; laundry starch; laundry glaze; shoe cream; polishing creams; cosmetic creams; skin whitening creams; polishing rouge; incense; hair spray; nail varnish; hair lotions; lotions for cosmetic purposes; after-shave lotions; beauty masks; oils for perfumes and scents; oils for cosmetic purposes; maternity cosmetic oils; oils for toilet purposes; essential oils; essential oils of cedarwood; essential oils of lemon; essential oils of citron; oils for cleaning purposes; bergamot oil; gaultheria oil; jasmine oil; lavender oil; almond oil; rose oil; oil of turpentine for degreasing; whitening; cleaning chalk; almond milk for cosmetic purposes; cleansing milk for toilet purposes; musk [perfumery]; soap; deodorant soap; shaving soap; soap for brightening textile; cakes of toilet soap; antiperspirant soap; soap for foot perspiration; almond soap; mint for perfumery; cosmetic kits; emery; gel eye patches for cosmetic purposes; nail art stickers; false nails; eau de Cologne; extracts of flowers [perfumes]; joss sticks; pastes for razor strops; toothpaste; pumice stone; lipstick cases; hydrogen peroxide for cosmetic purposes; breath freshening strips; teeth whitening strips; sandcloth; glass cloth [abrasive cloth]; lipsticks; pomades for cosmetic purposes; dentifrices; shaving preparations; cosmetic preparations for baths; bath preparations, not for medical purposes; hair straightening preparations; hair

waving preparations; laundry soaking preparations; grinding preparations; smoothing preparations [starching]; colour-removing preparations; leather bleaching preparations; polishing preparations; denture polishes; mouthwashes, not for medical purposes; cosmetic preparations for slimming purposes; starch glaze for laundry purposes; preparations to make the leaves of plants shiny; eye-washes, not for medical purposes; fabric softeners for laundry use; laundry bleaching preparations; dry-cleaning preparations; paint stripping preparations; lacquer removing preparations; make-up removing preparations; floor wax removers [scouring preparations]; varnish-removing preparations; rust removing preparations; nail care preparations; cleaning preparations; preparations for cleaning dentures; wallpaper cleaning preparations; preparations for unblocking drain pipes; chemical cleaning preparations for household purposes; collagen preparations for cosmetic purposes; bleaching preparations [decolorants] for household purposes; laundry preparations; aloe vera preparations for cosmetic purposes; sunscreen preparations; colour-brightening chemicals for household purposes [laundry]; breath freshening preparations for personal hygiene; shining preparations [polish]; make-up powder; diamantine [abrasive]; stain removers; nail varnish removers; vaginal washes for personal sanitary or deodorant purposes; scouring solutions; false eyelashes; baby wipes impregnated with cleaning preparations; tissues impregnated with cosmetic lotions; tissues impregnated with make-up removing preparations; saffrol; massage candles for cosmetic purposes; laundry blueing; turpentine for degreasing; potpourris [fragrances]; bleaching soda; washing soda, for cleaning; bath salts, not for medical purposes; bleaching salts; fumigation preparations [perfumes]; leather preservatives [polishes]; ammonia [volatile alkali] [detergent]; astringents for cosmetic purposes; eyebrow cosmetics; make-up preparations; sun-tanning preparations [cosmetics]; hair dyes; neutralizers for permanent waving; cosmetic preparations for eyelashes; cosmetic preparations for skin care; shoe wax; cosmetics; maternity care cosmetics; cosmetics for children; cosmetics for animals; cosmetic preparations for skin during pregnancy; mascara; cosmetic preparations for the treatment of skin stretch marks; skin moisturizers used as cosmetics; cleansers for intimate personal hygiene purposes, non medicated; douching preparations for personal sanitary or deodorant purposes [toiletries]; detergents, other than for use in manufacturing operations and for medical purposes; degreasers, other than for use in manufacturing processes; bleaching preparations [decolorants] for cosmetic purposes; toiletry preparations; antiperspirants [toiletries]; phytocosmetic preparations; talcum powder, for toilet use; cotton swabs for cosmetic purposes; terpenes [essential oils]; emery cloth; cloths impregnated with a detergent for cleaning; henna [cosmetic dye]; shampoos; shampoos for animals [non-medicated grooming preparations];

shampoos for pets [non-medicated grooming preparations]; dry shampoos; sandpaper; soda lye; herbal extracts for cosmetic purposes; ethereal essences; badian essence; mint essence [essential oil].

5 – Acaricides; aconitine; alkaloids for medical purposes; alginates for pharmaceutical purposes; algicides; aldehydes for pharmaceutical purposes; dental amalgams of gold; dental amalgams; amino acids for veterinary purposes; amino acids for medical purposes; analgesics; anaesthetics; antibiotics; antiseptics; medicine cases, portable, filled; first-aid boxes, filled; aluminium acetate for pharmaceutical purposes; acetates for pharmaceutical purposes; germicides; balms for medical purposes; bandages for dressings; diagnostic biomarker reagents for medical purposes; biocides; bracelets impregnated with insect repellent; bromine for pharmaceutical purposes; paper for mustard plasters; fly catching paper; reagent paper for veterinary purposes; reagent paper for medical purposes; mothproofing paper; petroleum jelly for medical purposes; vaccines; oxygen baths; antiseptic cotton; aseptic cotton; absorbent cotton; wadding for medical purposes; cotton for medical purposes; dietetic substances adapted for medical use; radiological contrast substances for medical purposes; nutritive substances for microorganisms; radioactive substances for medical purposes; bismuth subnitrate for pharmaceutical purposes; prenatal vitamins, including prenatal vitamins with folic acid; melissa water for pharmaceutical purposes; seawater for medicinal bathing; mineral waters for medical purposes; thermal water; dietary fibre; moulding wax for dentists; gases for medical purposes; guaiacol for pharmaceutical purposes; sexual stimulant gels; haematogen; haemoglobin; hydrastine; hydrastinine; glycerine for medical purposes; glycerophosphates; glucose for medical purposes; gentian for pharmaceutical purposes; hormones for medical purposes; mustard for pharmaceutical purposes; mustard plasters; mud for baths; medicinal mud; gamboge for medical purposes; gurgun balsam for medical purposes; disinfectants; air deodorizing preparations; deodorants, other than for human beings or for animals; deodorants for clothing and textiles; diastase for medical purposes; digitalin; vitamin supplement patches; mineral dietary supplements; dietary supplements; albumin dietary supplements; dietary supplements for animals; yeast dietary supplements; alginate dietary supplements; glucose dietary supplements; casein dietary supplements; lecithin dietary supplements; linseed oil dietary supplements; propolis dietary supplements; protein dietary supplements; protein supplements for animals; royal jelly dietary supplements; pollen dietary supplements; wheat germ dietary supplements; linseed dietary supplements; acai powder dietary supplements; dietary supplements with a cosmetic effect; enzyme dietary supplements; yeast for pharmaceutical purposes; gelatine for medical purposes; cod liver oil; isotopes for medical purposes; immunostimulants; insecticides; iodine for

pharmaceutical purposes; iodides for pharmaceutical purposes; alkaline iodides for pharmaceutical purposes; iodoform; calomel [fungicide]; cream of tartar for pharmaceutical purposes; tartar for pharmaceutical purposes; camphor for medical purposes; capsules for medicines; cachets for pharmaceutical purposes; capsules made of dendrimer-based polymers, for pharmaceuticals; haemostatic pencils; wart pencils; caustic pencils; carbolineum [parasiticide]; caustics for pharmaceutical purposes; cachou for pharmaceutical purposes; quassia for medical purposes; quebracho for medical purposes; oxygen for medical purposes; gallic acid for pharmaceutical purposes; acids for pharmaceutical purposes; adhesives for dentures; surgical glues; stem cells for veterinary purposes; stem cells for medical purposes; cocaine for medical purposes; collagen for medical purposes; collodion for pharmaceutical purposes; corn rings for the feet; medicated sweets; angostura bark for medical purposes; barks for pharmaceutical purposes; cedar wood for use as an insect repellent; condurango bark for medical purposes; croton bark; mangrove bark for pharmaceutical purposes; myrobalan bark for pharmaceutical purposes; quinquina for medical purposes; medicated animal feed; medicinal roots; rhubarb roots for pharmaceutical purposes; lint for medical purposes; starch for dietetic or pharmaceutical purposes; creosote for pharmaceutical purposes; blood for medical purposes; cultures of microorganisms for medical or veterinary use; curare; dental lacquer; liquorice for pharmaceutical purposes; milk sugar for pharmaceutical purposes; candy for medical purposes; adhesive plasters; medicines for alleviating constipation; adhesive tapes for medical purposes; lecithin for medical purposes; lotions for veterinary purposes; medicated hair lotions; lotions for pharmaceutical purposes; medicated aftershave lotions; personal sexual lubricants; lupulin for pharmaceutical purposes; magnesia for pharmaceutical purposes; liniments; ointments for pharmaceutical purposes; sunburn ointments; mercurial ointments; frostbite salve for pharmaceutical purposes; gauze for dressings; medicinal oils; mustard oil for medical purposes; camphor oil for medical purposes; castor oil for medical purposes; oil of turpentine for pharmaceutical purposes; dill oil for medical purposes; dental mastics; dental abrasives; dental impression materials; teeth filling material; dressings, medical; surgical dressings; drugs for medical purposes; medicines for veterinary purposes; serotherapeutic medicines; medicines for human purposes; medicines for dental purposes; menthol; medicinal drinks; moleskin for medical purposes; almond milk for pharmaceutical purposes; powdered milk for babies; royal jelly for pharmaceutical purposes; milk ferments for pharmaceutical purposes; Irish moss for medical purposes; flour for pharmaceutical purposes; linseed meal for pharmaceutical purposes; fish meal for pharmaceutical purposes; fly glue; antibacterial soap; disinfectant soap; medicated soap; freeze-dried meat adapted for medical purposes;

mint for pharmaceutical purposes; dietetic beverages adapted for medical purposes; malted milk beverages for medical purposes; injectable dermal fillers; medicinal infusions; tincture of iodine; eucalyptol for pharmaceutical purposes; tinctures for medical purposes; opium; opodeldoc; decoctions for pharmaceutical purposes; antiparasitic collars for animals; cotton swabs for medical purposes; stick liquorice for pharmaceutical purposes; sulfur sticks [disinfectants]; pastilles for pharmaceutical purposes; medicated toothpaste; pectin for pharmaceutical purposes; pepsins for pharmaceutical purposes; peptones for pharmaceutical purposes; hydrogen peroxide for medical purposes; pesticides; food for babies; leeches for medical purposes; blood plasma; vitamin and mineral bars for medical purposes; nicotine patches for use as aids to stop smoking; eyepatches for medical purposes; poultices; compresses; scapulars for surgical purposes; babies' diapers; diapers for pets; diapers for incontinence; bunion pads; breast-nursing pads; pomades for medical purposes; powder of cantharides; pyrethrum powder; anti-uric preparations; bacterial preparations for medical and veterinary use; bacteriological preparations for medical and veterinary use; balsamic preparations for medical purposes; albuminous preparations for medical purposes; biological preparations for veterinary purposes; biological preparations for medical purposes; veterinary preparations; bismuth preparations for pharmaceutical purposes; vitamin preparations, including vitamin preparations with folic acid; diagnostic preparations for veterinary purposes; diagnostic preparations for medical purposes; douching preparations for medical purposes; bath preparations for medical purposes; therapeutic preparations for the bath; haemorrhoid preparations; preparations for callouses; lice treatment preparations [pediculicides]; acne treatment preparations; preparations to facilitate teething; preparations for the treatment of burns; fumigation preparations for medical purposes; opotherapy preparations; air purifying preparations; bronchodilating preparations; preparations for reducing sexual activity; sterilizing preparations; soil-sterilizing preparations; corn remedies; pharmaceutical preparations for treating dandruff; preparations for destroying noxious animals; herbicides; preparations for destroying dry rot fungus; larvae exterminating preparations; fly destroying preparations; preparations for destroying mice; slug exterminating preparations; parasitocides; pharmaceutical preparations for skin care; contact lens cleaning preparations; preparations of microorganisms for medical or veterinary use; lime-based pharmaceutical preparations; styptic preparations; medicated eye-washes; medicinal hair growth preparations; nutritional preparations for therapeutic or medical purposes; opiates; anticryptogamic preparations; aloe vera preparations for pharmaceutical purposes; preparations of trace elements for human and animal use; sulfonamides [medicines]; pharmaceutical preparations for treating sunburn;

pharmaceutical preparations for treating dry skin caused by pregnancy; pharmaceutical preparations for preventing skin blemishes during pregnancy; pharmaceutical preparations for the prevention of stretch marks; pharmaceutical preparations for hydrating the skin during pregnancy; enzyme preparations for veterinary purposes; enzyme preparations for medical purposes; phytotherapy preparations for medical purposes; chemico-pharmaceutical preparations; chemical preparations for veterinary purposes; chemical preparations for the diagnosis of pregnancy; chemical preparations for medical purposes; chemical preparations for treating diseases affecting cereal plants; chemical preparations for treating wheat blight; chemical preparations for treating diseases affecting vine plants; chemical preparations for treating mildew; chemical preparations for treating phylloxera; chemical preparations for pharmaceutical purposes; chiblain preparations; mothproofing preparations; collyrium; lead water; chemical conductors for electrocardiograph electrodes; albuminous foodstuffs for medical purposes; dietetic foods adapted for medical purposes; by-products of the processing of cereals for dietetic or medical purposes; homogenized food adapted for medical purposes; freeze-dried food adapted for medical purposes; pharmaceuticals; sanitary towels; panty liners [sanitary]; propolis for pharmaceutical purposes; pearl powder for medical purposes; radium for medical purposes; hydrated chloral for pharmaceutical purposes; solvents for removing adhesive plasters; vaginal washes for medical purposes; solutions for contact lenses; chemical reagents for medical or veterinary purposes; gum for medical purposes; rubber for dental purposes; chewing gum for medical purposes; nicotine gum for use as an aid to stop smoking; insect repellents; insect repellent incense; repellents for dogs; tissues impregnated with pharmaceutical lotions; sarsaparilla for medical purposes; sugar for medical purposes; asthmatic tea; fumigating sticks; massage candles for therapeutic purposes; suppositories; linseed for pharmaceutical purposes; tobacco free cigarettes for medical purposes; siccatives [drying agents] for medical purposes; syrups for pharmaceutical purposes; turpentine for pharmaceutical purposes; milking grease; greases for veterinary purposes; greases for medical purposes; lacteal flour for babies; infant formula; soporifics; bicarbonate of soda for pharmaceutical purposes; bath salts for medical purposes; salts for mineral water baths; salts for medical purposes; potassium salts for medical purposes; sodium salts for medical purposes; smelling salts; mineral water salts; malt for pharmaceutical purposes; semen for artificial insemination; alcohol for pharmaceutical purposes; medicinal alcohol; alloys of precious metals for dental purposes; ergot for pharmaceutical purposes; cooling sprays for medical purposes; antibacterial handwashes; adjuvants for medical purposes; astringents for medical purposes; vermifuges; disinfectants for hygiene purposes; disinfectants for

chemical toilets; appetite suppressants for medical purposes; medical preparations for slimming purposes; mouthwashes for medical purposes; febrifuges; depuratives; animal washes [insecticides]; detergents for medical purposes; cattle washes [insecticides]; dog washes [insecticides]; insecticidal veterinary washes; vesicants; purgatives; remedies for perspiration; remedies for foot perspiration; chemical contraceptives; antiparasitic preparations; sedatives; laxatives; tonics [medicines]; medicated toiletry preparations; digestives for pharmaceutical purposes; nervines; bouillons for bacteriological cultures; steroids; strychnine; serums; tanning pills; appetite suppressant pills; slimming pills; jujube, medicated; antioxidant pills; sanitary tampons; vulnerary sponges; pregnancy testing preparations for home use; thymol for pharmaceutical purposes; biological tissue cultures for veterinary purposes; biological tissue cultures for medical purposes; smoking herbs for medical purposes; medicinal herbs; transplants [living tissues]; surgical implants comprised of living tissues; pants, absorbent, for incontinence; sanitary panties; babies' diaper-pants; charcoal for pharmaceutical purposes; fennel for medical purposes; porcelain for dental prostheses; phenol for pharmaceutical purposes; enzymes for veterinary purposes; enzymes for medical purposes; ferments for pharmaceutical purposes; formic aldehyde for pharmaceutical purposes; phosphates for pharmaceutical purposes; fungicides; quinine for medical purposes; chinoline for medical purposes; diabetic bread adapted for medical use; chloroform; flowers of sulfur for pharmaceutical purposes; cement for animal hooves; bone cement for surgical and orthopaedic purposes; dental cements; medicinal tea; herbal teas for medicinal purposes; insecticidal animal shampoos; medicated shampoos; medicated shampoos for pets; pediculicidal shampoos; medicated dry shampoos; pre-filled syringes for medical purposes; eucalyptus for pharmaceutical purposes; herbal extracts for medical purposes; plant extracts for pharmaceutical purposes; tobacco extracts [insecticides]; extracts of hops for pharmaceutical purposes; elixirs [pharmaceutical preparations]; ethers for pharmaceutical purposes; esters for pharmaceutical purposes; cellulose esters for pharmaceutical purposes; cellulose ethers for pharmaceutical purposes; jalap.

(260) AM 2023 120060 A

(800) 1691745

(151) 2022 07 25

(891) 2022 07 25

(731) Merkulova Tetiana

Prospekt Nauky, 77, Kvartyra 180, Misto
Kharkiv 61101, Ukraine

(540)

East & West

(591) Black, white

(511)
44 – Health center services; services of health facilities; alternative medicine services; health spa services; massage.

(260) AM 2023 120062 A
(800) 1691770
(151) 2022 09 22
(891) 2022 09 22
(731) Hyundai Motor Company
12, Heolleung-ro, Seocho-gu, Seoul 06797,
Republic of Korea



(591) Blue, red, black and white
(531) 24.11.25; 26.01.03; 26.01.18; 27.05.01;
27.05.02; 27.05.03; 27.05.09; 27.05.10;
29.01.14

(511)
25 – Footwear; sports shoes; sports overcoats; sportswear; athletic uniforms; sports shirts; driving gloves; clothing; outer clothing; children's clothing; overcoats (except wear for exclusive use for sports and Korean traditional dress); underwear; nighties; undergarments; ear muffs [clothing]; winter gloves; socks; sashes for wear; gloves including those made of skin, hide or fur; gloves for clothing having touch technology of electronic products; headwear; winter face masks (clothing); face coverings [clothing], not for medical or sanitary purposes; belts [clothing]; waterproof clothing.

(260) AM 2023 120063 A
(800) 1691772
(151) 2022 09 22
(891) 2022 09 22
(731) Hyundai Motor Company
12, Heolleung-ro, Seocho-gu, Seoul 06797,
Republic of Korea



(591) Blue, red, black and white
(531) 24.11.25; 26.01.03; 26.01.18; 27.05.01;
27.05.02; 27.05.03; 27.05.09; 27.05.10;
29.01.14

(511)
25 – Footwear; sports shoes; sports overcoats; sportswear; athletic uniforms; sports shirts; driving gloves; clothing; outer clothing; children's clothing; overcoats (except wear for exclusive use for sports and Korean traditional dress); underwear; nighties; undergarments; ear muffs [clothing]; winter gloves; socks; sashes for wear; gloves including those made of skin, hide or fur; gloves for clothing having touch technology

of electronic products; headwear; winter face masks (clothing); face coverings [clothing], not for medical or sanitary purposes; belts [clothing]; waterproof clothing.

(260) AM 2023 120064 A
(800) 1691773
(151) 2022 09 22
(891) 2022 09 22
(731) Hyundai Motor Company
12, Heolleung-ro, Seocho-gu, Seoul 06797,
Republic of Korea



(591) Blue, red, black and white
(531) 24.11.25; 26.01.03; 26.01.18; 27.05.01;
27.05.02; 27.05.03; 27.05.09; 27.05.10;
29.01.14

(511)
25 – Footwear; sports shoes; sports overcoats; sportswear; athletic uniforms; sports shirts; driving gloves; clothing; outer clothing; children's clothing; overcoats (except wear for exclusive use for sports and Korean traditional dress); underwear; nighties; undergarments; ear muffs [clothing]; winter gloves; socks; sashes for wear; gloves including those made of skin, hide or fur; gloves for clothing having touch technology of electronic products; headwear; winter face masks (clothing); face coverings [clothing], not for medical or sanitary purposes; belts [clothing]; waterproof clothing.

(260) AM 2023 120065 A
(800) 1691789
(151) 2022 03 25
(891) 2022 03 25
(731) Herbalife International Luxembourg Sàrl
16, Avenue de la Gare, L-1610 Luxembourg,
Luxembourg

(540)
**GREEN MAX SELECT / ГРИН
МАКС SELECT**

(591) Black, white
(531) 26.11.01; 26.11.09; 27.05.01; 28.05
(511)

5 – Dietary and nutritional supplements; food supplements.

32 – Preparations for making nutritional beverages.

(260) AM 2023 120066 A
(800) 1691802
(151) 2022 08 23
(891) 2022 08 23

(731) Uğur Aydınlatma San. Ve Tic. Ltd. Şti.
Bereketzade Mah., Semt Şair Ziya Paşa
Cad. 3 A, Beyoğlu, İstanbul, Türkiye

(540)



(591) Black, white

(531) 26.04.04; 26.04.07; 26.04.18; 26.04.24;
27.05.01; 27.05.24; 27.05.25

(526) ®

(511)

11 – Apparatus and installations for lighting, heating, cooling, steam generating, cooking, drying, ventilating, water supply and sanitary purposes.

(260) AM 2023 120067 A

(800) 1691807

(151) 2022 08 30

(891) 2022 08 30

(731) Rubella Beauty AD

Osvobođenje Str. 3, BG-4960 Rudozem,
Bulgaria

(540)

Beauty Smile

(591) Black, white

(511)

3 – Perfumery; cosmetics; cosmetic creams; hair color; hair lotions; hair dyes; shampoos; soap; ethereal oils; sunscreen preparations; sun-tanning preparations (cosmetics); non-medicated dentifrices.

(260) AM 2023 120068 A

(800) 1691831

(151) 2022 08 16

(891) 2022 08 16

(731) Shandong Kaixuan Tire Co., LTD

2021-1246 (A), First Floor, East Office
Building, No. 45, Beijing Road, Qianwan
Bonded Port Area, Qingdao Area, China
(Shandong) Pilot Free Trade, China

(540)

GREFORCE

(591) Black, white

(531) 27.05.17

(511)

12 – Automobile chassis; pneumatic tires; aircraft tires; tires for vehicle wheels; automobile tyres; solid tires for vehicle wheels; repair outfits for inner tubes; upholstery for vehicles; brake linings for vehicles; vehicle seats.

(260) AM 2023 120069 A

(800) 1691854

(151) 2021 12 27

(891) 2021 12 27

(731) Rovenma Elektronik Sanayi Ve Ticaret

Anonim Sirketi

Universiteler Mah. 1596. Cd., Hacettepe

Teknokent 6. Ar-Ge Safir Bloklar, A Blok Kat:

8-9 No: 27-28, Cankaya, Ankara, Türkiye

(540)



(591) Red and dark red

(531) 26.05.02; 26.13.25; 26.15.09; 27.05.01;
27.05.09; 27.05.10; 29.01.12

(511)

35 – Advertising, marketing and public relations; organization of exhibitions and trade fairs for commercial or advertising purposes; development of advertising concepts; provision of an online marketplace for buyers and sellers of goods and services; office functions; secretarial services; arranging newspaper subscriptions for others; compilation of statistics; rental of office machines; systemization of information into computer databases; telephone answering for unavailable subscribers; business management, business administration and business consultancy; accounting; commercial consultancy services; personnel recruitment, personnel placement, employment agencies, import-export agencies; temporary personnel placement services; auctioneering; the bringing together, for the benefit of others, of a variety of goods, namely, machines, machine tools and industrial robots for processing and shaping wood, metals, glass, plastics and minerals, 3D printers, construction machines and robotic mechanisms (machines) for use in construction, bulldozers, diggers (machines), excavators, road construction and road paving machines, drilling machines, rock drilling machines, road sweeping machines, lifting, loading and transmission machines and robotic mechanisms (machines) for lifting, loading and transmission purposes, elevators, escalators and cranes, machines and robotic mechanisms (machines) for use in agriculture and animal breeding, machines and robotic mechanisms (machines) for processing cereals, fruits, vegetables and food, machines for preparing and processing beverages, engines and motors, other than for land vehicles, parts and fittings therefor, hydraulic and pneumatic controls for engines and motors, brakes other than for vehicles, brake linings for engines, crankshafts, gearboxes, other than for land vehicles, gearboxes, cylinders for engines, pistons for engines, turbines, not for land vehicles, filters

for engines and motors, oil, air and fuel filters for land vehicle engines, exhausts for land vehicle engines, exhaust manifolds for land vehicle engines, engine cylinders for land vehicles, engine cylinder heads for land vehicles, pistons for land vehicle engines, carburetors for land vehicles, fuel conversion apparatus for land vehicle engines, injectors for land vehicle engines, fuel economisers for land vehicle engines, pumps for land vehicle engines, valves for land vehicle engines, starter motors for land vehicles, dynamos for land vehicle engines, sparking plugs for land vehicle engines, bearings (parts of machines), roller or ball bearings, machines for mounting and detaching tires, alternators, current generators, electric generators, current generators operated with solar energy, painting machines, automatic spray guns for paint, electric, hydraulic and pneumatic punching machines and guns, electric adhesive tape dispensers (machines), electric guns for compressed gas or liquid spraying machines, electric hand drills, electric hand saws, electric jigsaw machines, spiral machines, compressed air machines, compressors (machines), vehicle washing installations, robotic mechanisms (machines) with the abovementioned functions, electric and gas-operated welding apparatus, electric arc welding apparatus, electric soldering apparatus, electric arc cutting apparatus, electrodes for welding machines, industrial robots (machines) with the abovementioned functions, printing machines, packaging machines, filling, plugging and sealing machines, labellers (machines), sorting machines, industrial robots (machines) with the abovementioned functions, electric packing machines for plugging and sealing of plastics, machines for textile processing, sewing machines, industrial robots (machines) with the abovementioned functions, pumps other than parts of machines or engines, fuel dispensing pumps for service stations, self-regulating fuel pumps, electric kitchen machines for chopping, grinding, crushing, mixing and mincing foodstuff, washing machines, laundry washing machines, dishwashers, spin driers (not heated), electric cleaning machines for cleaning floors, carpets or floorings, vacuum cleaners and parts thereof, automatic vending machines, galvanizing and electroplating machines, electric door openers and closers, gaskets for engines and motors, measurement apparatus and equipment including those for scientific, nautical, topographic, meteorologic, industrial and laboratory purposes, thermometers, not for medical purposes, barometers, ammeters, voltmeters, hygrometers, testing apparatus not for medical purposes, telescopes, periscopes, directional compasses, speed indicators, laboratory apparatus, microscopes, magnifying glasses, stills, binoculars, ovens and furnaces for laboratory experiments, apparatus for recording, transmission or reproduction of sound or images, cameras, photographic cameras, television apparatus, video recorders, CD and DVD players and recorders, MP3 players, computers, desktop computers, tablet computers, wearable technological

devices (smart watches, wristbands, head-mounted devices) microphones, loudspeakers, earphones, telecommunications apparatus, apparatus for the reproduction of sound or images, computer peripheral devices, cell phones, covers for cell phones, telephone apparatus, computer printers, scanners [data processing equipment], photocopiers, magnetic and optic data carriers and computer software and programmes recorded thereto, downloadable and recordable electronic publications, encoded magnetic and optic cards, movies, tv series and video music clips recorded on magnetic, optical and electronic media, antennas, satellite antennas, amplifiers for antennas, parts of the aforementioned goods, ticket dispensers, automatic teller machines (ATM), electronic components used in the electronic parts of machines and apparatus, semi-conductors, electronic circuits, integrated circuits, chips [integrated circuits], diodes, transistors [electronic], magnetic heads for electronic apparatus, electronic locks, photocells, remote control apparatus for opening and closing doors, optical sensors, counters and quantity indicators for measuring the quantity of consumption, automatic time switches, clothing for protection against accidents, irradiation and fire, safety vests and life-saving apparatus and equipment, eyeglasses, sunglasses, optical lenses and cases, containers, parts and components thereof, apparatus and instruments for conducting, transforming, accumulating or controlling electricity, electric plugs, junction boxes [electricity], electric switches, circuit breakers, fuses, lighting ballasts, battery starter cables, electrical circuit boards, electric resistances, electric sockets, transformers [electricity], electrical adapters, battery chargers, electric door bells, electric and electronic cables, batteries, electric accumulators, solar panels for production of electricity, alarms and anti-theft alarms, other than for vehicles, electric bells, signalling apparatus and instruments, luminous or mechanical signs for traffic use, fire extinguishing apparatus, fire engines, fire hose and fire hose nozzles, radar apparatus, sonars, night vision apparatus and instruments, decorative magnets, metronomes, enabling customers to conveniently view and purchase those goods, such services may be provided by retail stores, wholesale outlets, by means of electronic media or through mail order catalogues.

39 – Land, water and air transport services; rental of land, water or air vehicles; arranging of tours; travel reservation; issuing of tickets for travel; courier services (messages or merchandise); car parking; garage rental; boat storage; transport by pipeline; electricity distribution; water supplying; rescue operations for vehicles and goods; storage, wrapping and packaging of goods; transport and storage of trash; transport and storage of waste.

(260) AM 2023 120071 A
 (800) 1691893
 (151) 2022 08 22
 (891) 2022 08 22
 (731) Private entrepreneur Mednikov Anton
 Andreevich
 Ostrovityanova ul., 31-199, RU-117279
 Moscow, Russian Federation

(540)

HOMEDETOX

(591) Black, white

(511)

3 – Abrasives; amber [perfume]; descaling preparations for household purposes; antistatic preparations for household purposes; aromatics [essential oils]; air fragrancing preparations; cake flavourings [essential oils]; flavourings for beverages [essential oils]; food flavourings [essential oils]; breath freshening sprays; canned pressurized air for cleaning and dusting purposes; balms, other than for medical purposes; basma [cosmetic dye]; lip glosses; nail glitter; body glitter; polishing stones; abrasive paper; emery paper; polishing paper; petroleum jelly for cosmetic purposes; shoe polish; cobblers' wax; cotton wool for cosmetic purposes; cotton wool impregnated with make-up removing preparations; sachets for perfuming linen; drying agents for dishwashing machines; adhesives for cosmetic purposes; scented water; Javelle water; lavender water; micellar water; toilet water; wax for parquet floors; floor wax; non-slipping wax for floors; depilatory wax; moustache wax; tailors' wax; waxes for leather; polish for furniture and flooring; shoemakers' wax; polishing wax; massage gels, other than for medical purposes; heliotropine; dental bleaching gels; geraniol; make-up; deodorants for pets; deodorants for human beings or for animals; depilatory preparations; air fragrance reed diffusers; scented wood; perfumes; non-slipping liquids for floors; windscreen cleaning liquids; greases for cosmetic purposes; volcanic ash for cleaning; perfumery; decorative transfers for cosmetic purposes; ionone [perfumery]; shaving stones [astringents]; smoothing stones; eyebrow pencils; cosmetic pencils; silicon carbide [abrasive]; carbides of metal [abrasives]; alum stones [astringents]; tripoli stone for polishing; adhesives for affixing false eyelashes; adhesives for affixing false hair; hair conditioners; quillaia bark for washing; corundum [abrasive]; beard dyes; colorants for toilet purposes; cosmetic dyes; body paint for cosmetic purposes; starch for laundry purposes; shoe cream; polishing creams; cosmetic creams; skin whitening creams; polishing rouge; incense; hair spray; nail varnish; liquid latex body paint for cosmetic purposes; hair lotions; lotions for cosmetic purposes; after-shave lotions; beauty masks; oils for perfumes and scents; oils for cosmetic purposes; oils for toilet purposes; essential oils; essential oils of cedarwood; essential oils of lemon; essential oils of citron; oils for cleaning purposes; bergamot oil; gaul-

theria oil; jasmine oil; lavender oil; almond oil; rose oil; oil of turpentine for degreasing; whitening; cleaning chalk; almond milk for cosmetic purposes; cleansing milk for toilet purposes; musk [perfumery]; deodorant soap; shaving soap; soap for brightening textile; cakes of toilet soap; antiperspirant soap; soap for foot perspiration; soap; almond soap; mint for perfumery; cosmetic kits; emery; gel eye patches for cosmetic purposes; nail art stickers; double eyelid tapes; false nails; eau de Cologne; extracts of flowers [perfumes]; joss sticks; pastes for razor strops; toothpaste; pumice stone; lipstick cases; hydrogen peroxide for cosmetic purposes; breath freshening strips; teeth whitening strips; sandcloth; glass cloth [abrasive cloth]; lipsticks; pomades for cosmetic purposes; shaving preparations; cosmetic preparations for baths; bath preparations, not for medical purposes; hair straightening preparations; hair waving preparations; laundry soaking preparations; grinding preparations; smoothing preparations [starching]; colour-removing preparations; leather bleaching preparations; polishing preparations; denture polishes; mouthwashes, not for medical purposes; cosmetic preparations for slimming purposes; laundry glaze; preparations to make the leaves of plants shiny; eye-washes, not for medical purposes; fabric softeners for laundry use; laundry preparations; dry-cleaning preparations; paint stripping preparations; lacquer-removing preparations; make-up removing preparations; floor wax removers [scouring preparations]; varnish-removing preparations; rust removing preparations; nail care preparations; cleaning preparations; preparations for cleaning dentures; wallpaper cleaning preparations; preparations for unblocking drain pipes; chemical cleaning preparations for household purposes; collagen preparations for cosmetic purposes; bleaching preparations [decolorants] for household purposes; laundry bleach; aloe vera preparations for cosmetic purposes; sunscreen preparations; colour-brightening chemicals for household purposes [laundry]; breath freshening preparations for personal hygiene; shining preparations [polish]; make-up powder; diamantine [abrasive]; stain removers; nail varnish removers; vaginal washes for personal sanitary or deodorant purposes; scouring solutions; false eyelashes; antistatic dryer sheets; baby wipes impregnated with cleaning preparations; colour run prevention laundry sheets; tissues impregnated with cosmetic lotions; tissues impregnated with make-up removing preparations; safrol; massage candles for cosmetic purposes; laundry blueing; turpentine for degreasing; potpourris [fragrances]; bleaching soda; washing soda, for cleaning; bath salts, not for medical purposes; bleaching salts; fumigation preparations [perfumes]; leather preservatives [polishes]; ammonia [volatile alkali] [detergent]; astringents for cosmetic purposes; eyebrow cosmetics; make-up preparations; sun-tanning preparations [cosmetics]; hair dyes; neutralizers for permanent waving; cosmetic preparations for eyelashes; cosmetic preparations for skin care; shoe wax;

dentifrices; cosmetics; cosmetics for children; cosmetics for animals; mascara; cleansers for intimate personal hygiene purposes, non medicated; douching preparations for personal sanitary or deodorant purposes [toiletries]; detergents, other than for use in manufacturing operations and for medical purposes; degreasers, other than for use in manufacturing processes; bleaching preparations [decolorants] for cosmetic purposes; antiperspirants [toiletries]; toiletry preparations; phytocosmetic preparations; talcum powder, for toilet use; cotton swabs for cosmetic purposes; terpenes [essential oils]; emery cloth; cloths impregnated with a detergent for cleaning; henna [cosmetic dye]; shampoos for animals [non-medicated grooming preparations]; shampoos for pets [non-medicated grooming preparations]; dry shampoos; shampoos; sandpaper; soda lye; herbal extracts for cosmetic purposes; ethereal essences; badian essence; mint essence [essential oil].

4 – Perfumed candles; nightlights [candles].

(260) AM 2023 120072 A
(800) 1691949
(151) 2022 06 06
(891) 2022 06 06
(731) Agrohimpex & Kemoimpex Doo Beograd
Resavska 66, 11169 Beograd, Serbia
(540)



(591) Blue, black and yellow
(531) 26.11.03; 26.11.06; 26.11.12; 27.05.11;
29.01.13

(511)
35 – Wholesale services in relation to vehicles; wholesale and retail trading of tires; wholesale and retail trading of automobile cosmetics; wholesale and retail trading of automotive equipment; wholesale and retail trading of batteries.

37 – Tire balancing services; tire repair services; tire installation services.

(260) AM 2023 120073 A
(800) 1691967
(151) 2022 06 30
(891) 2022 06 30
(731) Bloomage Biotechnology Corporation Limited
No. 678 Tianchen St., High-Tech Development
Zone, Jinan, 250101 Shandong, China
(540)



(591) Black, white
(531) 24.17.02; 26.01.01; 26.01.06; 26.01.24;
27.05.01

(511)
3 – Spray skin care products; beauty gels; lipsticks; mouthwashes, not for medical purposes; fragrance sachets; cosmetics for animals; cosmetics; air fragrancing preparations; cleansing milk for toilet purposes; wet tissue impregnated with a detergent for cleaning; polishing preparations; grinding preparations; essential oils; beauty masks; make-up removing preparations; sunscreen preparations; skin-care essence, not for pharmaceutical use.

(260) AM 2023 120074 A
(800) 1691974
(151) 2022 08 10
(891) 2022 08 10
(731) Aktsionernoe Obshchestvo "Nizhegorodsky
Khimiko-Farmatsevtichesky Zavod"
Salganskaya St., 7, RU-603950 Nizhny
Novgorod, Russian Federation

(540)

ПАНТОМЕКОЛЬ

(591) Black, white
(531) 28.05
(511)

5 – Pharmaceuticals, medical and veterinary preparations; sanitary preparations for medical purposes; dietetic food and substances adapted for medical or veterinary use, food for babies; dietary supplements for human beings and animals; plasters, materials for dressings; material for dental fillings and dental impressions; disinfectants; preparations for destroying noxious animals; fungicides, herbicides; acaricides; acetonitine; alkaloids for medical purposes; alginates for pharmaceutical purposes; algicides; aldehydes for pharmaceutical purposes; dental amalgams of gold; dental amalgams; amino acids for veterinary purposes; amino acids for medical purposes; analgesics; anaesthetics; antibiotics; antiseptics; medicine cases, portable, filled; first-aid boxes, filled; aluminium acetate for pharmaceutical purposes; acetates for pharmaceutical purposes; germicides; oxygen cylinders, filled, for medical purposes; balms for medical purposes; bandages for dressings; nutritional supplements; diagnostic biomarker reagents for medical purposes; biocides; bracelets impregnated with insect repellent; bromine for pharmaceutical purposes; paper for mustard plasters; fly catching paper; reagent paper for veterinary purposes; reagent paper for medical purposes; mothproofing paper; petroleum jelly for medical purposes; vaccines; oxygen baths; antiseptic cotton; aseptic cotton; absorbent cotton; wadding for medical purposes; cotton for medical purposes; dietetic substances adapted for medical use; radiological contrast substances for medical purposes; nutritive substances for microorganisms; radioactive substances for me-

dical purposes; bismuth subnitrate for pharmaceutical purposes; melissa water for pharmaceutical purposes; seawater for medicinal bathing; mineral waters for medical purposes; thermal water; dietary fibre; moulding wax for dentists; gases for medical purposes; guaiacol for pharmaceutical purposes; massage gels for medical purposes; sexual stimulant gels; haemato- gen; haemoglobin; hydrastine; hydrastinine; glycerine for medical purposes; glycerophosphates; glucose for medical purposes; gentian for pharmaceutical purpo- ses; hormones for medical purposes; mustard for pharmaceutical purposes; mustard plasters; mud for baths; medicinal mud; contraceptive sponges; gambo- ge for medical purposes; gurjun balsam for medical purposes; deodorizers for litter trays; air deodorizing preparations; deodorants, other than for human beings or for animals; deodorants for clothing and textiles; diastase for medical purposes; digitalin; vitamin sup- plement patches; mineral dietary supplements; dietary supplements; albumin dietary supplements; dietary supplements for animals; yeast dietary supplements; alginate dietary supplements; glucose dietary supple- ments; casein dietary supplements; lecithin dietary supplements; linseed oil dietary supplements; propolis dietary supplements; protein dietary supplements; protein supplements for animals; royal jelly dietary supplements; pollen dietary supplements; wheat germ dietary supplements; linseed dietary supplements; acai powder dietary supplements; dietary supplements with a cosmetic effect; enzyme dietary supplements; yeast for pharmaceutical purposes; gelatine for medi- cal purposes; cod liver oil; isotopes for medical purpo- ses; immunostimulants; insecticides; iodine for pharmaceutical purposes; iodides for pharmaceutical purposes; alkaline iodides for pharmaceutical purpo- ses; iodoform; calomel [fungicide]; cream of tartar for pharmaceutical purposes; tartar for pharmaceutical purposes; camphor for medical purposes; capsules for medicines; cachets for pharmaceutical purposes; cap- sules made of dendrimer-based polymers, for pharma- ceuticals; haemostatic pencils; wart pencils; caustic pencils; carbolineum [parasiticide]; caustics for phar- maceutical purposes; cachou for pharmaceutical purpo- ses; quassia for medical purposes; quebracho for medical purposes; oxygen for medical purposes; gallic acid for pharmaceutical purposes; acids for pharma- ceutical purposes; adhesives for dentures; surgical glues; stem cells for veterinary purposes; stem cells for medical purposes; cocaine for medical purposes; collagen for medical purposes; collodion for pharma- ceutical purposes; corn rings for the feet; cannabis for medical purposes; medicated sweets; angostura bark for medical purposes; barks for pharmaceutical purpo- ses; cedar wood for use as an insect repellent; condu- rango bark for medical purposes; croton bark; mang- rove bark for pharmaceutical purposes; myrobalan bark for pharmaceutical purposes; quinquina for medi- cal purposes; medicated animal feed; medicinal ro- ots; rhubarb roots for pharmaceutical purposes; lint

for medical purposes; starch for dietetic or pharma- ceutical purposes; creosote for pharmaceutical purpo- ses; blood for medical purposes; biological tissue cul- tures for veterinary purposes; biological tissue cultu- res for medical purposes; cultures of microorganisms for medical or veterinary use; curare; dental lacquer; liquorice for pharmaceutical purposes; milk sugar for pharmaceutical purposes; adhesive plasters; medicines for alleviating constipation; adhesive tapes for medi- cal purposes; lecithin for medical purposes; lotions for veterinary purposes; medicated hair lotions; loti- ons for pharmaceutical purposes; medicated after-sha- ve lotions; personal sexual lubricants; lupulin for pharmaceutical purposes; magnesia for pharmaceuti- cal purposes; liniments; ointments for pharmaceutical purposes; sunburn ointments; mercurial ointments; frostbite salve for pharmaceutical purposes; gauze for dressings; medicinal oils; mustard oil for medical purpo- ses; camphor oil for medical purposes; castor oil for medical purposes; oil of turpentine for pharmaceutical purposes; dill oil for medical purposes; dental mas- tics; dental abrasives; dental impression materials; te- eth filling material; dressings, medical; surgical dres- sings; drugs for medical purposes; medicines for ve- terinary purposes; serotherapeutic medicines; medici- nes for human purposes; medicines for dental purpo- ses; menthol; medicinal drinks; moleskin for medical purposes; almond milk for pharmaceutical purposes; powdered milk for babies; royal jelly for pharmaceu- tical purposes; milk ferments for pharmaceutical pur- poses; Irish moss for medical purposes; flour for phar- maceutical purposes; linseed meal for pharmaceutical purposes; fish meal for pharmaceutical purposes; fly glue; antibacterial soap; disinfectant soap; medicated soap; freeze-dried meat adapted for medical purposes; mint for pharmaceutical purposes; dietetic beverages adapted for medical purposes; malted milk beverages for medical purposes; injectable dermal fillers; bone void fillers comprised of living tissues; narcotics; me- dicinal infusions; tincture of iodine; eucalyptol for pharmaceutical purposes; tinctures for medical purpo- ses; opium; opodeldoc; decoctions for pharmaceutical purposes; antiparasitic collars for animals; cotton swabs for medical purposes; cotton wool swabs for medical purposes; stick liquorice for pharmaceutical purposes; sulfur sticks [disinfectants]; pastilles for pharmaceutical purposes; medicated toothpaste; pec- tin for pharmaceutical purposes; pepsins for pharma- ceutical purposes; peptones for pharmaceutical purpo- ses; hydrogen peroxide for medical purposes; pestici- des; leeches for medical purposes; blood plasma; ni- cotine patches for use as aids to stop smoking; eye- patches for medical purposes; poultices; compresses; scapulars for surgical purposes; babies' diapers; dia- pers for pets; swim diapers, reusable, for babies; swim diapers, disposable, for babies; diapers for incontine- nce; diaper changing mats, disposable, for babies; bu- nion pads; breast-nursing pads; pomades for medical purposes; powder of cantharides; pyrethrum powder;

anti-uric preparations; bacterial preparations for medical and veterinary use; bacteriological preparations for medical and veterinary use; balsamic preparations for medical purposes; albuminous preparations for medical purposes; biological preparations for veterinary purposes; biological preparations for medical purposes; veterinary preparations; bismuth preparations for pharmaceutical purposes; vitamin preparations; diagnostic preparations for veterinary purposes; diagnostic preparations for medical purposes; douching preparations for medical purposes; bath preparations for medical purposes; therapeutic preparations for the bath; haemorrhoid preparations; preparations for callouses; lice treatment preparations [pediculicides]; acne treatment preparations; preparations to facilitate teething; preparations for the treatment of burns; fumigation preparations for medical purposes; opotherapy preparations; air purifying preparations; bronchodilating preparations; preparations for reducing sexual activity; sterilizing preparations; soil-sterilizing preparations; corn remedies; pharmaceutical preparations for treating dandruff; vermin destroying preparations; herbicides; preparations for destroying dry rot fungus; larvae exterminating preparations; fly destroying preparations; preparations for destroying mice; slug exterminating preparations; pharmaceutical preparations for skin care; contact lens cleaning preparations; preparations of microorganisms for medical or veterinary use; lime-based pharmaceutical preparations; styptic preparations; medicated eye-washes; medicinal hair growth preparations; nutraceutical preparations for therapeutic or medical purposes; opiates; anticryptogamic preparations; aloe vera preparations for pharmaceutical purposes; preparations of trace elements for human and animal use; sulfonamides [medicines]; pharmaceutical preparations; pharmaceutical preparations for treating sunburn; enzyme preparations for veterinary purposes; enzyme preparations for medical purposes; phytotherapy preparations for medical purposes; chemico-pharmaceutical preparations; chemical preparations for veterinary purposes; chemical preparations for the diagnosis of pregnancy; chemical preparations for medical purposes; chemical preparations for treating diseases affecting cereal plants; chemical preparations for treating wheat blight; chemical preparations for treating diseases affecting vine plants; chemical preparations for treating mildew; chemical preparations for treating phylloxera; chemical preparations for pharmaceutical purposes; chilblain preparations; mothproofing preparations; collyrium; lead water; chemical conductors for electrocardiograph electrodes; albuminous foodstuffs for medical purposes; dietetic foods adapted for medical purposes; by-products of the processing of cereals for dietetic or medical purposes; homogenized food adapted for medical purposes; freeze-dried food adapted for medical purposes; pharmaceuticals; sanitary towels; panty liners [sanitary]; propolis for pharmaceutical purposes; pearl powder for medical purposes; ra-

dium for medical purposes; hydrated chloral for pharmaceutical purposes; solvents for removing adhesive plasters; vaginal washes for medical purposes; solutions for contact lenses; chemical reagents for medical or veterinary purposes; gum for medical purposes; rubber for dental purposes; chewing gum for medical purposes; nicotine gum for use as an aid to stop smoking; insect repellents; insect repellent incense; repellents for dogs; tissues impregnated with pharmaceutical lotions; sarsaparilla for medical purposes; sugar for medical purposes; crystallized rock sugar for medical purposes; asthmatic tea; fumigating sticks; massage candles for therapeutic purposes; linseed for pharmaceutical purposes; tobacco-free cigarettes for medical purposes; siccatives [drying agents] for medical purposes; syrups for pharmaceutical purposes; turpentine for pharmaceutical purposes; milking grease; greases for veterinary purposes; greases for medical purposes; lacteal flour for babies; infant formula; soporifics; bicarbonate of soda for pharmaceutical purposes; bath salts for medical purposes; salts for mineral water baths; salts for medical purposes; potassium salts for medical purposes; sodium salts for medical purposes; smelling salts; mineral water salts; malt for pharmaceutical purposes; semen for artificial insemination; alcohol for pharmaceutical purposes; medicinal alcohol; alloys of precious metals for dental purposes; ergot for pharmaceutical purposes; cooling sprays for medical purposes; antibacterial handwashes; adjuvants for medical purposes; astringents for medical purposes; vermifuges; disinfectants for hygiene purposes; disinfectants for chemical toilets; appetite suppressants for medical purposes; medical preparations for slimming purposes; parasiticides; mouthwashes for medical purposes; medicated dentifrices; febrifuges; depuratives; animal washes [insecticides]; detergents for medical purposes; cattle washes [insecticides]; dog washes [insecticides]; insecticidal veterinary washes; vesicants; purgatives; remedies for perspiration; remedies for foot perspiration; chemical contraceptives; antiparasitic preparations; sedatives; laxatives; tonics [medicines]; medicated toiletry preparations; digestives for pharmaceutical purposes; nervines; bouillons for bacteriological cultures; steroids; headache relief sticks; strychnine; suppositories; serums; tanning pills; appetite suppressant pills; slimming pills; jujube, medicated; antioxidant pills; sanitary tampons; vulnerary sponges; thymol for pharmaceutical purposes; smoking herbs for medical purposes; medicinal herbs; transplants [living tissues]; surgical implants comprised of living tissues; pants, absorbent, for incontinence; sanitary panties; babies' diaper-pants; charcoal for pharmaceutical purposes; fennel for medical purposes; porcelain for dental prostheses; phenol for pharmaceutical purposes; enzymes for veterinary purposes; enzymes for medical purposes; ferments for pharmaceutical purposes; formic aldehyde for pharmaceutical purposes; phosphates for pharmaceutical purposes; quinine for medical purpo-

ses; chinoline for medical purposes; diabetic bread adapted for medical use; chloroform; flowers of sulfur for pharmaceutical purposes; cement for animal hooves; bone cement for surgical and orthopaedic purposes; dental cements; medicinal tea; herbal teas for medicinal purposes; insecticidal animal shampoos; medicated shampoos; medicated shampoos for pets; pediculicidal shampoos; medicated dry shampoos; pre-filled syringes for medical purposes; eucalyptus for pharmaceutical purposes; herbal extracts for medical purposes; plant extracts for pharmaceutical purposes; tobacco extracts [insecticides]; extracts of hops for pharmaceutical purposes; elixirs [pharmaceutical preparations]; ethers for pharmaceutical purposes; esters for pharmaceutical purposes; cellulose esters for pharmaceutical purposes; cellulose ethers for pharmaceutical purposes; rat poison; poisons; bacterial poisons; jalap; angioprotectors; antiplatelet agents; anticoagulants; antithrombotic agents; decongestants; pharmaceutical preparations for the treatment of nervous system diseases; pharmaceutical preparations for the treatment of articular-ligamentous disorders; pharmaceutical preparations for the treatment of musculoskeletal disorders; pharmaceutical preparations for treating injuries; pharmaceuticals for the treatment of thrombophlebitis; anti-itch pharmaceutical preparations; venotonic pharmaceuticals; pharmaceutical preparations for the treatment of venous system diseases; pharmaceutical preparations for the treatment of lymphatic system diseases; pharmaceutical preparations for the treatment of rheumatic lesion; pharmaceutical preparations for the treatment and prevention of infectious diseases; anti-inflammatory preparations; bactericides; medicinal ointments; microbicides; regenerative preparations; preparations for treating dermatological conditions; burn relief preparations; preparations for treatment of damaged skin; preparations for prevention and treatment of dry skin; preparations for prevention and treatment of dermatitis; agents for improving of cellular metabolism.

(260) AM 2023 120075 A

(800) 1692015

(151) 2022 06 16

(891) 2022 06 16

(731) Euro Games Technology Ltd.

4, "Maritsa" Str., "Vranya-Lozen-Triugulnika", BG-1151 Sofia, Bulgaria

(540)



(591) Red, orange, yellow, cyan, blue, green, brown and black

(531) 03.07.17; 07.05.01; 27.05.01; 27.05.03; 27.05.04; 27.05.08; 27.05.09; 27.05.10; 29.01.15

(511)

9 – Software; computer gaming software; computer software packages; computer operating system software; computer software, recorded; software drivers; virtual reality software; games software; entertainment software for computer games; computer programs for network management; operating computer software for main frame computers; monitors (computer hardware); computer hardware; apparatus for recording images; monitors (computer programs); computer game programs; computer programs for recorded games; apparatus for recording, transmission or reproduction of sound or images; communications servers [computer hardware]; electronic components for gambling machines; computer application software featuring games and gaming; computer software for the administration of on-line games and gaming; computer hardware for games and gaming; hardware and software for gambling, gambling machines, gambling games on the Internet and via telecommunication network.

28 – Gaming machines for gambling; chips for gambling; mah-jong; arcade games; gambling machines operating with coins, notes and cards; games; electronic games; parlor games; gaming chips; gaming tables; slot machines [gaming machines]; LCD game machines; slot machines and gaming devices; coin-operated amusement machines; roulette chips; poker chips; chips and dice [gaming equipment]; gaming equipment for casinos; roulette tables; gaming roulette wheels; casino games; gambling machines and amusement machines, automatic and coin-operated; coin-operated amusement machines and/or electronic coin-operated amusement machines with or without the possibility of gain; boxes for coin-operated machines, slot machines and gaming machines; electronic or electrotechnical amusement machines and apparatus, gaming machines, coin-operated entertainment machines; housings for coin-operated machines, gaming equipment, gaming machines, machines for gambling; electropneumatic and electrical gambling machines (slot machines).

41 – Gambling; entertainment services related to gambling; gaming services for entertainment purposes; casino, gaming and gambling services; training in the development of software systems; provision of gaming equipment for gambling halls; providing casino equipment [gambling]; gaming machine entertainment services; providing casino facilities [gambling]; gaming hall services; amusement arcade services; games equipment rental; rental of gaming machines; providing amusement arcade services; rental of gaming machines with images of fruits; editing or recording of sounds and images; sound recording and video entertainment services; hire of sound reproducing apparatus; provision of gaming equipment for casinos; providing of casino facilities; online gambling services; casino, gaming and gambling services; provision

of gaming facilities, gaming hall facilities, Internet casinos and online gambling services.

(260) AM 2023 120076 A
 (800) 1692042
 (151) 2022 10 05
 (891) 2022 10 05
 (731) MMD-Monitors & Displays Nederland B.V.
 Prins Bernhardplein 200, NL-1097
 JB Amsterdam, Netherlands
 (540)

EVNIA

(591) Black, white
 (511)
 9 – Lcd monitors; computer display monitors; computer monitors; computer mice; wireless computer mice; pc mice; computer keyboards; wireless keyboards; multifunction computer keyboards; keyboards; headsets; wireless headsets; headsets for use with computers; virtual reality headsets; headsets for virtual reality games; virtual reality headsets adapted for use in playing video games; communications headsets; mousepads; computer mousepads; speakers; audio speakers; loud speakers; wireless speakers; speakers for computers; monitors; monitor speakers; tv monitors; televisions; digital signage display panels; visual display screens; led screen displays; display monitors; digital signage; digital signage monitors; virtual reality hardware; liquid crystal displays; display screens; flat panel displays.
 20 – Office chairs; chairs.

(260) AM 2023 120077 A
 (800) 1692064
 (151) 2022 05 02
 (891) 2022 05 02
 (731) Thyssenkrupp AG
 ThyssenKrupp Allee 1, 45143 Essen,
 Germany;
 Thyssenkrupp Bilstein GmbH
 August-Bilstein-Str. 4, 58256 Ennepetal,
 Germany
 (540)

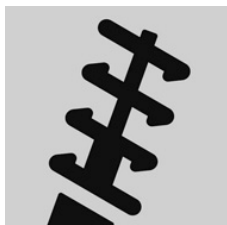

(591) Black, white
 (531) 18.01.21; 26.13.25
 (511)
 7 – Shock absorber plungers; shock absorbers for machines; gas-filled shock absorbers, in particular hydropneumatic shock absorbers for use as machine

parts; spring shock absorbers for machines; shock absorbing springs being parts of machine suspension; dashpot plungers [parts of engines or motors].

12 – Parts for motor vehicles; hydraulic units for motor vehicles in the form of shock absorbing and/or stabilising elements for chassis and chassis superstructures of motor vehicles; vibration dampers for wheel suspensions of motor vehicles, and individual parts and attachments therefor; suspension struts for land vehicles; suspension struts for vehicles; air suspension struts for land vehicles; combined spring/damper modules for vehicles; MacPherson suspension struts for land vehicles; suspension struts with steel springs or air springs for wheel suspensions of motor vehicles, and individual parts and attachments therefor; gas-filled shock absorbers; hydropneumatic shock absorbers for motor vehicles; support bearings for motor vehicle vibration dampers; springs for wheel suspensions of motor vehicles, in particular helical compression springs, air springs and single air springs; vehicle shock absorbers; shock absorbers [vehicle parts]; shock absorbers for vehicles; shock absorbers for vehicle suspension; suspension shock absorbers for vehicles; hydraulic rotary shock absorbers for vehicles; shock absorbers being parts of vehicle suspension; combined spring and shock absorber units for vehicles; torsion dampers for vehicles; hydraulic rotary dampers for vehicles; shock absorbing cylinders [parts of vehicles]; shock absorbing springs for automobiles; shock absorbing springs being parts of vehicle suspension; shock absorbers for the suspension units of vehicles.

(260) AM 2023 120078 A
 (800) 1692067
 (151) 2022 05 02
 (891) 2022 05 02
 (731) Thyssenkrupp AG
 ThyssenKrupp Allee 1, 45143 Essen,
 Germany;
 Thyssenkrupp Bilstein GmbH
 August-Bilstein-Str. 4, 58256 Ennepetal,
 Germany



(591) Black, white
 (531) 18.01.21; 26.04.16; 26.04.18; 26.04.24;
 26.13.25; 27.05.01
 (511)
 7 – Shock absorber plungers; shock absorbers for machines; gas-filled shock absorbers, in particular hydropneumatic shock absorbers for use as machine parts; spring shock absorbers for machines; shock absorbing springs being parts of machine suspension; dashpot plungers [parts of engines or motors].

12 – Parts for motor vehicles; hydraulic units for motor vehicles in the form of shock absorbing and/or stabilising elements for chassis and chassis superstructures of motor vehicles; vibration dampers for wheel suspensions of motor vehicles, and individual parts and attachments therefor; suspension struts for land vehicles; suspension struts for vehicles; air suspension struts for land vehicles; combined spring/damper modules for vehicles; MacPherson suspension struts for land vehicles; suspension struts with steel springs or air springs for wheel suspensions of motor vehicles, and individual parts and attachments therefor; gas-filled shock absorbers; hydropneumatic shock absorbers for motor vehicles; support bearings for motor vehicle vibration dampers; springs for wheel suspensions of motor vehicles, in particular helical compression springs, air springs and single air springs; vehicle shock absorbers; shock absorbers [vehicle parts]; shock absorbers for vehicles; shock absorbers for vehicle suspension; suspension shock absorbers for vehicles; hydraulic rotary shock absorbers for vehicles; shock absorbers being parts of vehicle suspension; combined spring and shock absorber units for vehicles; torsion dampers for vehicles; hydraulic rotary dampers for vehicles; shock absorbing cylinders [parts of vehicles]; shock absorbing springs for automobiles; shock absorbing springs being parts of vehicle suspension; shock absorbers for the suspension units of vehicles.

(260) AM 2023 120079 A
 (800) 1692084
 (151) 2022 08 30
 (891) 2022 08 30
 (731) Hauck GmbH & Co. KG.
 Frohnlacher Str. 8, 96242 Sonnefeld, Germany
 (540)



(591) Black, white
 (531) 04.05.05; 26.13.25; 27.05.01; 27.05.17
 (511)

10 – Feeding bottles.

12 – Children's seats for use in vehicles; prams; pushchairs; scooters [vehicles]; push scooters [vehicles]; go-carts; trolleys for hand traction; tricycles; bicycles; vehicles.

18 – Pouch baby carriers; back frames for carrying children; backpacks for carrying infants; bags; umbrellas and parasols.

20 – Travel cots; safety cots; babies' bouncing chairs; bassinets; bath seats; playpens for babies; infant walkers; high chairs for babies; seats adapted for babies; seats for children; wall-mounted baby changing platforms.

24 – Sleeping bags for babies; sleeping bags; baby blankets; bed blankets; blankets for outdoor use; children's blankets; swaddling blankets.

25 – Footmuffs, not electrically heated; baby bibs [not of paper]; cloth bibs.

28 – Infants' swings; baby rattles incorporating teething rings; toys; wheeled toys; carriages for dolls; toys for use in perambulators; toy pushchairs; dolls; pedal-propelled wheeled toys; scooters [toys]; toy vehicles; children's four-wheeled vehicles [playthings]; electronically operated toy motor vehicles.

(260) AM 2023 120080 A
 (800) 1692097
 (151) 2022 08 19
 (891) 2022 08 19
 (731) Limited Liability Company "Dr. Bakers – Baking Academy"
 Accom. 2/4, room. 9, build. 12, ext. ter.
 municipal district Khoroshevsky, st. Aircraft designer Mikoyan, RU-125252 Moscow, Russian Federation

(540)



(591) Red, blue and white
 (531) 24.03.08; 24.03.18; 25.01.15; 26.11.08; 29.01.13

(511)
 29 – Albumen for culinary purposes; seaweed extracts for food; gelatine; coconut, desiccated; vegetables, dried; jellies for food; nuts, prepared; pectin for culinary purposes; alginates for culinary purposes; almonds, ground; peanuts, prepared; sunflower seeds, prepared; seeds, prepared; lecithin for culinary purposes; milk ferments for culinary purposes; flavoured nuts; hazelnuts, prepared; vegetable-based concentrate for cooking; fruit-based concentrate for cooking; agar-agar for culinary purposes; edible flowers, dried.

30 – Cocoa; flour and preparations made from cereals; bread, pastries and confectionery; yeast, baking powder; seasonings; unleavened bread; condiments; almond paste; aniseed; star aniseed; confectionery for decorating Christmas trees; infusions, not medicinal; coffee flavourings; aromatic preparations for food; cakes; cinnamon [spice]; curry [spice]; cereal preparations; marzipan; cloves [spice]; sugar confectionery; preparations for stiffening whipped cream; essences for foodstuffs, except etheric essences and essential oils; thickening agents for cooking foodstuffs; turmeric; natural sweeteners; spices; gingerbread; allspice; flour; bean meal; corn flour; mustard meal; barley meal; soya flour; wheat flour; starch for food; ferments for pastes; fondants [confectionery]; sugar; flavourings, other than essential oils, for cakes; cake powder; cake batter; ground ginger; glucose for culi-

nary purposes; gluten prepared as foodstuff; leaven; yeast; mint for confectionery; nutmegs; flour confectionery; saffron [seasoning]; tapioca flour; vanilla flavourings for culinary purposes; vanillin [vanilla substitute]; powders for making ice cream; almond confectionery; peanut confectionery; food flavourings, other than essential oils; flavourings, other than essential oils, for beverages; oat-based food; cous-cous; malt extract for food; malt for human consumption; baking powder; baking soda [bicarbonate of soda for cooking purposes]; garden herbs, preserved [seasonings]; cake frosting [icing]; linseed for culinary purposes [seasoning]; cream of tartar for culinary purposes; gluten additives for culinary purposes; pastry dough; chocolate decorations for cakes; candy decorations for cakes; chocolate-coated nuts; rice pudding; nut flours; minced garlic [condiment]; mirror icing [mirror glaze]; processed seeds for use as a seasoning; sesame seeds [seasonings]; buckwheat flour; fruit confectionery; flavoured jelly crystals for making jelly confectionery; crystallized lemon juice [seasoning]; processed squash seeds [seasonings]; processed hemp seeds [seasonings].

(260) AM 2023 120092 A
(800) 1692371
(151) 2022 08 23
(891) 2022 08 23
(731) Alende Holdings OÜ
Kesklinna linnaosa, Rotermanni 6, EE-10111
Tallinn, Estonia
(540)

Avank

(591) Black, white
(511)
36 – Deposit-taking; deposit-holding; financial administration of deposit-taking; deposit accounts services; maintaining escrow accounts for investments; electronic banking services; electronic banking via a global computer network [internet banking]; electronic banking services; financial services provided by electronic means; private placement and venture capital investment services; arranging finance for businesses; financing services for companies; provision of finance for enterprises; corporate savings account services; fixed income investment services; financial and monetary services; financial assistance; financing and funding services; facilitating and arranging financing; arranging the provision of finance; financial services relating to the securing of funds; financial management via the internet; financing services; provision of finance for business ventures; merchant banking services; merchant banking services; online business banking services; providing funding for commercial entities; provision of current accounts; computerised financial services for retail businesses; computerised financial services; debit account services; electronic

financial trading services; financial investment; raising of financial capital; financial banking; financial services provided over the internet and telephone; financial services provided over the telephone and by means of a global computer network or the internet; provision of financial services by means of a global computer network or the internet; conducting of financial transactions; conducting of financial affairs on-line; savings and loan associations; loan and credit, and lease-finance services; brokerage; banking; computerised banking services; financial transfers and transactions, and payment services; international banking; deposit savings; exchange brokerage services; virtual currency transfer services; financial administration of savings accounts.

(260) AM 2023 120093 A
(800) 1692375
(151) 2022 08 09
(891) 2022 08 09
(731) Ferrero S.P.A.
Piazzale Pietro Ferrero 1, I-12051 Alba, Cuneo,
Italy
(540)



(591) White, brown and gold
(531) 08.01.19; 08.01.23; 19.03.03; 29.01.13
(554) მოცულობითი
(511)
30 – Pastry; confectionery; chocolate; chocolate-based products; cocoa; biscuits; stuffed wafers; chocolate-coated wafer cookies; pralines; caramels [sweets]; ice cream.

(260) AM 2023 120094 A
(800) 1692380
(151) 2022 09 23
(891) 2022 09 23
(731) Joint Stock Company "Fats And Oil
Integrated Works"
Ul. Titova 27, Ekaterinburg, RU-620085
Sverdlovskaya Oblast, Russian Federation
(540)



(591) White, black, yellow, light yellow, dark yellow, beige, light beige, dark beige, brown, green, light green, dark green, red, orange and dark orange

(531) 03.04.02; 08.07.05; 08.07.08; 25.01.18; 28.05; 29.01.15

(511)

29 – Oils and fats for food; butter; margarine; cream-vegetable oils for food; spreads, namely dairy-based spreads, spreads made from vegetable oils and fats; buttercream; fat-containing mixtures for bread slices.

(260) AM 2023 120095 A

(800) 1692381

(151) 2022 09 23

(891) 2022 09 23

(731) Joint Stock Company "Fats And Oil Integrated Works"
Ul. Titova 27, Ekaterinburg, RU-620085
Sverdlovskaya Oblast, Russian Federation

(540)



(591) Black, white, yellow, dark yellow, light yellow, beige, light beige, dark beige, brown, green, light green, dark green, red and light blue

(531) 03.04.02; 05.03.14; 08.07.05; 08.07.08; 25.01.25; 28.05; 29.01.15

(511)

29 – Oils and fats for food; butter; margarine; cream-vegetable oils for food; spreads, namely dairy-based spreads, spreads made from vegetable oils and fats; buttercream; fat-containing mixtures for bread slices.

(260) AM 2023 120096 A

(800) 1692418

(151) 2022 06 27

(891) 2022 06 27

(731) Sheng Ping

No. 3, Yangmei Road, Zhangting Town,
Yuyao City, Zhejiang Province, China

(540)

JNTRD

(591) Black, white

(531) 14.03.03; 27.03.15; 27.05.01; 27.05.17

(511)

7 – Corner buffing machine; dust exhausting installations for cleaning purposes; washing apparatus; cordless vacuum cleaner; garbage disposals; cordless

electric sweeper; electric screw driver; electric spanner; electric hand drill; hydraulic hand tool.

8 – Hobby knives [scalpels]; spark plug sleeve (hand tool); garden tools, hand-operated; wire strippers [hand tools]; hand-operated packing tools; spanners; depilation appliances, electric and non-electric; hexagon spanner; socket spanner; hand tools, hand-operated.

(260) AM 2023 120097 A

(800) 1692459

(151) 2022 05 05

(891) 2022 05 05

(731) Obshchestvo s ogranichennoy otvetstvennostyu "Alyans"

Dmitrovskoe sh., d. 71B, komn. 16,
vn. ter. g. municipalnyj okrug Zapadnoe
Degunino, RU-127238 Moscow, Russian
Federation

(540)

ARCANUM

(591) Black, white

(511)

33 – Aperitifs; arrack [arak]; brandy; wine; piquette; whisky; vodka; anisette [liqueur]; kirsch; gin; digestifs [liqueurs and spirits]; cocktails; curacao; anise [liqueur]; liqueurs; grain-based distilled alcoholic beverages; sugarcane-based alcoholic beverages; pre-mixed alcoholic beverages, other than beer-based; alcoholic beverages, except beer; alcoholic beverages containing fruit; wine-based beverages; spirits [beverages]; distilled beverages; hydromel [mead]; peppermint liqueurs; bitters; rum; sake; perry; cider; rice alcohol; alcoholic extracts; fruit extracts, alcoholic; alcoholic essences.

(260) AM 2023 120098 A

(800) 1692481

(151) 2022 10 10

(891) 2022 10 10

(731) Protos Bodega Ribera Duero De Peñafiel S.L.

Calle Bodegas Protos, 24-28, E-47300
Peñafiel (Valladolid), Spain

(540)

PROTOS

(591) Black, white

(511)

33 – Wines.

(260) AM 2023 120099 A

(800) 1692494

(151) 2022 06 16

(891) 2022 06 16

(731) Euro Games Technology Ltd.

"Maritsa" Str. 4, "Vranya-Lozen-Triugulnika",
BG-1151 Sofia, Bulgaria

(540)



(591) Yellow, orange, brown, white and black

(531) 01.15.07; 27.05.03; 27.05.17; 29.01.15

(511)

9 – Software; computer gaming software; computer software packages; computer operating system software; computer software, recorded; software drivers; virtual reality software; games software; entertainment software for computer games; computer programs for network management; operating computer software for main frame computers; monitors (computer hardware); computer hardware; apparatus for recording images; monitors (computer programs); computer game programs; computer programs for recorded games; apparatus for recording, transmission or reproduction of sound or images; communications servers [computer hardware]; electronic components for gambling machines; computer application software featuring games and gaming; computer software for the administration of on-line games and gaming; computer hardware for games and gaming; hardware and software for gambling, gambling machines, gambling games on the Internet and via telecommunication network.

28 – Gaming machines for gambling; chips for gambling; mahjong; arcade games; gambling machines operating with coins, notes and cards; gambling games; electronic gambling games; gaming chips; gaming tables; slot machines [gaming machines]; LCD game machines; slot machines and gaming devices; coin-operated amusement machines; roulette chips; poker chips; chips and dice [gaming equipment]; equipment for casinos; roulette tables; gaming roulette wheels; casino games; automats and gambling machines; coin-operated machines and/or electronic coin-operated machines with or without the possibility of gain; boxes for coin-operated machines, slot machines and gaming machines; electronic or electrotechnical gaming devices, automats and machines, coin-operated machines; housings for coin-operated machines, gaming equipment, gaming machines, machines for gambling; electropneumatic and electrical gambling machines (slot machines).

41 – Gambling; services related to gambling; gaming services for entertainment purposes; casino, gaming and gambling services; training in the development of software systems; provision of gaming equipment for gambling halls; providing casino equipment [gambling]; gaming machine entertainment services; providing casino facilities [gambling]; halls with gaming

machines; amusement arcade services; games equipment rental; rental of gaming machines; providing amusement arcade services; rental of gaming machines with images of fruits; editing or recording of sounds and images; sound recording and video entertainment services; hire of sound reproducing apparatus; provision of gaming equipment for casinos; providing of casino facilities; online gambling services; casino management services; operation of gaming establishments, gaming halls, internet casinos, online gambling sites.

(260) AM 2023 120100 A

(800) 1692495

(151) 2022 07 20

(891) 2022 07 20

(731) World Medicine İlaç San. Ve Tic. A.Ş.
15 Temmuz Mah. Cami Yolu Cad. 50,
Bağcılar, İstanbul, Türkiye

(540)

VIROMIX-ВИРОМИКС

(591) Black, white

(531) 28.05

(511)

5 – dental preparations and articles, sanitary preparations for medical use, hygienic pads, hygienic tampons, plasters, materials for dressings, diapers, including those made of paper and textiles, preparations for destroying vermin, herbicides, deodorants, other than for human beings or for animals, air deodorising preparations, disinfectants, antiseptics, detergents for medical purposes.

(260) AM 2023 120101 A

(800) 1692498

(151) 2022 09 19

(891) 2022 09 19

(731) Bearen Korea Inc.
75B-1L, 210, Namdongdong-ro, Namdong-gu,
Incheon 21644, Republic of Korea

(540)



(591) Red and black

(531) 27.05.10; 29.01.12

(511)

3 – Nail enamel removers; lipsticks; mascara; makeup; hair colorants; beauty creams; body lotion; bathing lotions; shampoos; sun-block lotions; skin lo-

tions; eye liner; liquid bath soaps; liquid perfumes; lip neutralizers; facial lotions; hand lotions; cosmetic soaps; cosmetics.

35 – Promoting the goods and services of others by means of operating an on-line shopping mall with links to the retail web sites of others; mail order services featuring cosmetics; wholesale store services featuring cosmetics; retail store services featuring cosmetics.

(260) AM 2023 120102 A
 (800) 1692514
 (151) 2022 08 10
 (891) 2022 08 10
 (731) Stori B & C S.R.L.
 Via Adige, 12, Desenzano Del Garda
 (Brescia), Italy
 (540)



(591) Black, white
 (531) 02.09.01; 27.05.01
 (511)

25 – Babies' pants [underwear]; skorts; leggings [trousers]; jumper dresses; gloves [clothing]; embroidered clothing; pinafores; jackets [clothing]; uniforms; dresses and suits; pyjamas; slippers; layettes [clothing]; skirts; leggings [leg warmers]; coats; scarves; trousers; breeches for wear; shirts; sweaters; jumpers [pullovers]; belts [clothing]; knitwear [clothing]; stockings; clothing for children; footwear for children; headgear for children; articles of clothing, footwear and headgear for babies and toddlers; bibs, not of paper; rain jackets; windcheaters; anoraks [parkas]; overcoats; cardigans; T-shirts; undershirts; chemises; camisoles; blouses; blousons; sweatshirts; jerseys [clothing]; shorts; Bermuda shorts; jeans; clothing for gymnastics; training suits; formal wear; headbands [clothing]; ready-made clothing; outer clothing; tops [clothing]; tank-tops; hosiery; clothing of leather or imitations of leather; waterproof clothing; pants; sweat pants; leotards; tunics; school uniforms; cuffs; dance clothing; smocks; bathing caps; beach cover-ups; beach clothes; swimsuits; bathing drawers; bikinis; bath robes; sundresses; pareus; socks; tights; unitards; garters; sock suspenders; stocking suspenders; shoes; sports shoes; beach shoes; sneakers; sandals; flip-flops [footwear]; heels; heelpieces for boots and shoes; inner soles; tips for footwear; soles for footwear; footwear uppers; boots; boots for sports; baby booties; overshoes; shawls; stoles; bandanas [neckerchiefs]; foulards [clothing articles]; neckties; bow-ties; ascots; neckerchiefs; pocket squares; neck warmers; muffs [clothing]; mittens; braces for clothing [suspenders];

waistbands [parts of clothing]; sashes for wear; collars [clothing]; singlets; slips [undergarments]; panties; underpants; boxer briefs; dressing gowns; nightgowns; vests; brassieres; corsets [underclothing]; bodices [lingerie]; girdles; teddies [underclothing]; sleep masks; caps being headwear; hats; cap peaks; caps with visors; berets; hoods [clothing]; ear muffs [clothing]; visors being headwear.

(260) AM 2023 120103 A
 (800) 1692529
 (151) 2022 08 08
 (891) 2022 08 08
 (731) Fengcheng Pacific Shenlong Turbocharger Co., LTD
 No. 9 North Street, D District, Modern Industrial Park, Fengshan Administrative District, Fengcheng City, 118100 Liaoning Province, China

(540)



(591) Black, white
 (531) 26.03.04
 (511)
 7 – Turbochargers.

(260) AM 2023 120107 A
 (800) 1692617
 (151) 2022 10 05
 (891) 2022 10 05
 (731) MMD-Monitors & Displays Nederland B.V.
 Prins Bernhardplein 200, NL-1097 JB
 Amsterdam, Netherlands

(540)



(591) Black, white
 (531) 26.02.05; 26.02.07; 27.05.01; 27.05.22
 (511)

9 – Lcd monitors; computer display monitors; computer monitors; computer mice; wireless computer mice; pc mice; computer keyboards; wireless keyboards; multifunction computer keyboards; keyboards; headsets; wireless headsets; headsets for use with computers; virtual reality headsets; headsets for virtual reality games; virtual reality headsets adapted for use in playing video games; communications head sets; mousepads; computer mousepads; speakers; audio speakers; loud speakers; wireless speakers; speakers

for computers; monitors; monitor speakers; tv monitors; televisions; digital signage display panels; visual display screens; led screen displays; display monitors; digital signage; digital signage monitors; vr goggles; virtual reality glasses; virtual reality hardware; virtual reality goggles; liquid crystal displays; display screens; flat panel displays.

20 – Office chairs; chairs.

(260) AM 2023 120108 A

(800) 1692640

(151) 2022 09 23

(891) 2022 09 23

(731) Joint Stock Company "Fats And Oil Integrated Works"

Ul. Titova 27, Ekaterinburg, RU-620085

Sverdlovskaya Oblast, Russian Federation

(540)



(591) White, yellow, dark yellow, red, beige, light beige, dark beige, brown, light blue and dark blue

(531) 08.01.10; 09.03.16; 11.03.09; 25.07.01; 28.05; 29.01.15

(511)

29 – Oils and fats for food; butter; margarine; cream-vegetable oils for food; spreads, namely dairy-based spreads, spreads made from vegetable oils and fats; buttercream; fat-containing mixtures for bread slices.

(260) AM 2023 120109 A

(800) 431873

(151) 1977 08 10

(891) 2022 07 21

(731) Chanel Sarl

Quai du Général-Guisan 24, CH-1204 Genève, Switzerland

(540)

CHANEL

(591) Black, white

(531) 27.05.17

(511)

3 – Perfumery products, beauty and soap products, make-up, essential oils, cosmetics, hair lotions, dentifrices.

(260) AM 2023 120110 A

(800) 906109

(151) 2006 10 24

(891) 2022 10 05

(731) IPack B.V.

Cruquiusweg 98 W, NL-1019 AJ Amsterdam, Netherlands

(540)

LIEFMANS

(591) Black, white

(511)

32 – Beers.

(260) AM 2023 120111 A

(800) 962865

(151) 2008 01 31

(891) 2022 10 05

(731) IPack B.V.

Cruquiusweg 98 W, NL-1019 AJ Amsterdam, Netherlands

(540)



(591) Black, white

(531) 02.01.07

(511)

32 – Beers.

(260) AM 2023 120112 A

(800) 1238684

(151) 2015 01 26

(891) 2022 10 05

(731) IPack B.V.

Cruquiusweg 98 W, NL-1019 AJ Amsterdam, Netherlands

(540)

VEDETT

(591) Black, white

(511)

32 – Beers.

(260) AM 2023 120113 A

(800) 1266201

(151) 2015 06 08

(891) 2022 10 05

(731) IPack B.V.

Cruquiusweg 98 W, NL-1019 AJ Amsterdam, Netherlands

(540)



(591) Black, white
 (531) 02.03.18; 02.03.23; 27.05.08; 27.05.11;
 27.05.12
 (511)
 32 – Beers.

(260) AM 2023 120115 A
 (800) 1328446
 (151) 2016 05 10
 (891) 2022 08 24
 (731) Obschestvo S Ogranitchenoy Otvetstven-
 nostyu "KDV Nizhny Tagil"
 83, Frunze str., Nizhny Tagil,
 RU-622022 Sverdlovskaya Oblast, Russian
 Federation

(540)

НИЛЬС
NILS

(591) Black, white
 (531) 28.05
 (511)
 30 – Sweetmeats [candy]; cereal bars; high-protein
 cereal bars; buns; waffles; malt biscuits; rice-based
 snack food; cereal-based snack food; cereal prepara-
 tions; fruit jellies [confectionery]; candy decorations
 for cakes; confectionery for decorating Christmas tre-
 es; cakes; pastries; peanut confectionery; almond con-
 fectionery; caramels [candy]; liquorice [confectione-
 ry]; peppermint sweets; crackers; custard; candy;
 marzipan; dessert mousses [confectionery]; chocolate
 mousses; muesli; chocolate-coated nuts; pastilles [co-
 nfectionery]; cookies; petit-beurre biscuits; fondants
 [confectionery]; pralines; oat-based food; gingerbre-
 ad; petits fours [cakes]; confectionery; rusks; tarts;
 pastry dough; cake dough; almond paste; tortillas;
 chocolate.

(260) AM 2023 120116 A
 (800) 1339784
 (151) 2017 01 24
 (891) 2022 09 21
 (731) Joint-Stock Company "Akkond"
 Skladskey proezd, d. 16, RU-428022
 Cheboksary, Chuvash republic, Russian
 Federation

(540)



(591) Brown, dark brown, reddish-brown, beige,
 light beige, yellow, light yellow, white, black
 color combination
 (531) 06.19.16; 08.01.09; 08.01.11; 11.03.14;
 28.05; 29.01.13
 (511)
 30 – Waffles.

(260) AM 2023 120118 A
 (800) 1383006
 (151) 2017 11 03
 (891) 2022 10 13
 (731) KRKA Tovarna Zdravil D.D. Novo Mesto
 Šmarješka Cesta 6, SI-8000 Novo Mesto,
 Slovenia

(540)

GLYPVILO

(591) Black, white
 (511)
 5 – Pharmaceutical preparations.

(260) AM 2023 120119 A
 (800) 1388273
 (151) 2017 06 21
 (891) 2022 10 05
 (731) Luce Bianca S.R.L.
 Via Nuova Poggioreale T7, Centro
 Polifunzionale Inail, I-80143 Napoli, Italy

(540)

leBebé

(591) Black, white
 (531) 27.05.01
 (511)
 14 – Precious metals and their alloys and goods in
 precious metals or coated therewith, not included in
 other classes; jewellery; jewellery made from and
 containing gold; precious stones; horological and
 chronometric instruments; bracelets (jewellery);
 watch bands; watch cases (parts of watches); chains
 (jewelry); jewellery charms; necklaces (jewellery);
 gold thread (jewellery); alloys of precious metal.

(260) AM 2023 120120 A
 (800) 1499709
 (151) 2019 08 05
 (891) 2022 09 05

(731) KORCHEVSKYI Dmytro
Rupniecibas St. 44, apt. 17, Riga, Latvia
(540)



(591) Black, white
(531) 02.01.16; 02.01.23; 07.03.15; 26.04.09;
26.04.18; 26.04.24; 27.05.17; 27.05.24

(511)
9 – Animated cartoons for educational purposes; audio- and video-receivers; audiovisual teaching apparatus; compact discs (audio-video); compact discs (read-only memory); computer game software, downloadable, for educational purposes; computer game software, recorded, for educational purposes; computer hardware; computer operating programs, recorded, for educational purposes; computer programs, downloadable, for educational purposes; computer programs, recorded, for educational purposes; computer software applications, downloadable, for educational purposes; computer software platforms, recorded or downloadable, for educational purposes; computer software, recorded, for educational purposes; computers; data processing apparatus for educational purposes; downloadable image files in the fields of computer science, computer and information technologies; downloadable music files in the fields of computer science, computer and information technologies; electronic book readers; electronic publications, downloadable, in the fields of computer science, computer and information technologies; humanoid robots with artificial intelligence; interfaces for computers; remote control apparatus; teaching apparatus, teaching robots.

35 – Administration of consumer loyalty programs; administrative processing of purchase orders; advertising; advisory services for business management; business information; business inquiries; business management assistance; business management consultancy; business organization consultancy; business research; commercial administration of the licensing of the goods and services of others; commercial information and advice for consumers in the choice of products and services; commercial intermediation services; compilation of information into computer databases; compilation of statistics; computerized file management; demonstration of goods; design of advertising materials; dissemination of advertising matter; market studies; marketing research; marketing; negotiation of business contracts for others; office machines and equipment rental; online advertising on a computer network; opinion polling; organization of exhibitions for commercial or advertising purposes;

outsourced administrative management for companies; outsourcing services (business assistance); production of advertising films; providing business information via a web site; provision of an online marketplace for buyers and sellers of goods and services; provision of commercial and business contact information; publication of publicity texts; publicity material rental; rental of advertising space; rental of advertising time on communication media; sales promotion for others; search engine optimization for sales promotion; sponsorship search; systemization of information into computer databases; updating and maintenance of data in computer databases; updating of advertising material; web indexing for commercial or advertising purposes; web site traffic optimization; writing of publicity texts.

41 – Academies (education), namely, providing courses in the fields of computer programming, software development, computer graphics and design, network technologies, robotics and system administration; arranging and conducting of conferences in the fields of computer programming, software development, computer graphics and design, network technologies, robotics and system administration; arranging and conducting of congresses in the fields of computer programming, software development, computer graphics and design, network technologies, robotics, system administration and information technologies; arranging and conducting of in-person educational forums in the fields of computer programming, software development, computer graphics and design, network technologies, robotics, system administration and information technologies; arranging and conducting of workshops (training) in the fields of computer programming, software development, computer graphics and design, network technologies, robotics, system administration and information technologies; corporate training in the fields of computer science, computer and information technologies; correspondence courses in the fields of computer programming, software development, computer graphics and design, network technologies, robotics, system administration and information technologies; education information relating to computer science, computer and information technologies; educational examination in the fields of computer science, computer and information technologies; educational services, namely, conducting of classes and lessons for children in the fields of computer programming, software development, computer graphics and design, network technologies, robotics and system administration; games equipment rental for educational purposes; online publication of electronic books and journals in the fields of computer science, computer and information technologies; organization of competitions in the fields of computer science, computer and information technologies; organization of exhibitions for educational purposes in the fields of computer science, computer and information technologies; practical training (demonstration) in the

fields of computer programming, software development, computer graphics and design, network technologies, robotics, system administration and information technologies; providing films, not downloadable, via video-on-demand services, in the fields of computer science, computer and information technologies; providing online electronic publications, not downloadable, in the fields of computer science, computer and information technologies; providing online videos, not downloadable, in the fields of computer science, computer and information technologies; publication of books, except advertising, in the fields of computer science, computer and information technologies; publication of texts, other than publicity texts, in the fields of computer science, computer and information technologies; rental of recorded data carriers for educational purposes in the fields of computer science, computer and information technologies; services of children's summer educational camps in the fields of computer science, computer and information technologies; services of children's summer entertainment camps; tutoring in the fields of computer programming, software development, computer graphics and design, network technologies, robotics, system administration and information technologies; vocational guidance (education or training advice) in the fields of computer science, computer and information technologies; vocational retraining in the fields of computer science, computer and information technologies.

42 – Cloud computing; computer programming; computer rental; computer security consultancy; computer software consultancy; computer software design for educational purposes; software development in the framework of software publishing; computer system analysis; computer system design; computer technology consultancy; computer virus protection services; consultancy in the design and development of computer hardware; creating and maintaining web sites for others; database development services for educational purposes; design of interior decor in the fields of computer graphics and design; dress designing in the fields of computer graphics and design; electronic data storage for educational purposes; engineering in the fields of computer programming, software development, computer graphics and design, network technologies, system administration, cybersecurity, robotics, software testing and web development; graphic arts design in the fields of computer graphics and design; hosting computer sites (web sites); information technology (IT) consultancy; installation of educational computer software; interior design in the fields of computer graphics and design; Internet security consultancy; maintenance of educational computer software; off-site data backup; outsource service providers in the field of information technology; packaging design in the fields of computer graphics and design; providing information on computer technology and programming via a web site; rental of educa-

tional computer software; rental of web servers for educational purposes; scientific research in the fields of computer programming, software development, computer graphics and design, network technologies, system administration, cybersecurity, robotics, software testing and web development; research and development of new products for others in the fields of computer programming, software development, computer graphics and design, network technologies, system administration, cybersecurity, robotics, software testing and web development; server hosting for educational purposes; software as a service (SaaS) for educational purposes; industrial design in the fields of computer graphics and design; technological consultancy in the fields of computer programming, software development, computer graphics and design, network technologies, system administration, cybersecurity, robotics, software testing and web development; technological research in the fields of computer programming, software development, computer graphics and design, network technologies, system administration, cybersecurity, robotics, software testing and web development; troubleshooting of computer software problems for educational purposes; updating of educational computer software; web site design consultancy.

(260) AM 2023 120121 A

(800) 1516309

(151) 2020 01 17

(891) 2022 10 13

(731) KRKA Tovarna Zdravil D.D.,

Novo Mesto Šmarješka cesta 6, SI-8000 Novo Mesto, Slovenia

(540)

ASIGLIA

(591) Black, white

(511)

5 – Pharmaceutical preparations.

(260) AM 2023 120122 A

(800) 1581926

(151) 2020 10 08

(891) 2022 07 04

(731) Solvay SA

Rue de Ransbeek 310, B-1120 Bruxelles, Belgium

(540)



(591) Blue
(531) 25.07.07; 26.01.18; 26.11.13; 27.05.21;
29.01.04

(511)
1 – Chemicals used in industry, for scientific purposes, as well as in agriculture, horticulture and forestry, in particular solvents, barium, strontium, calcium chloride, caustic soda, chlorinated products, peroxides, polyglycerol, precipitated calcium carbonate, baking soda and bicarbonate, cellulose acetate, amines, sulfuric acid, surfactants, diphenols and derivatives, fluorochemicals, adipic acid, polyamide intermediates, phosphorus derivatives, silica, rare earths, fine chemicals, aliphatic isocyanurate, mixed oxides and alumina; biological products for use in industry and science; unprocessed artificial resins, unprocessed plastics and plastic components, in particular vinyl polymers, specialty monomers and polyamide resins; fire-extinguishing compositions; fertilizers for soils; tempering and soldering preparations; chemical substances for preserving foodstuffs; chemicals for use as food additives; tanning materials; agents for leather treatment (not included in other classes); chemicals for the treatment of water, air and soil; adhesives for industrial use; luminescent chemicals for industrial use; chemicals used in industry for the manufacture of phosphors; chemicals for flame-retardant treatments; polyamide; catalysts; surfactants for industrial purposes; flocculants; adhesives for assembling [industrial] materials; adhesives for industrial use.

(260) AM 2023 120123 A
(800) 1583746
(151) 2020 12 23
(891) 2022 09 21
(731) Giorgio Armani S.P.A.
Via Borgonuovo, 11, I-20121 Milano
(Milano), Italy
(540)

ARMANI

(591) Black, white
(511)
4 – Candles; perfumed candles.

8 – Cheese slicers, non-electric; oyster openers; can openers, non-electric; silver plate [knives, forks and spoons]; side arms, other than firearms; manicure sets; pedicure sets; razor cases; manicure implements; pedicure implements; cutlery; ceramic knives; table cutlery [knives, forks and spoons]; scissors; nail files; money scoops; razors, electric or non-electric; vegetable choppers.

9 – Spectacles, sunglasses, lenses and frames therefor, contact lenses, cases for glasses and spectacles, chains and cords for glasses and spectacles, parts and fittings for all the aforesaid goods; covers for portable multimedia players; covers for mobile phones; covers for

DVDs; covers for CDs; sheaths for electric cables; covers for audio reproduction devices; covers for palmtops; covers for electronic agendas; covers for photographic cameras and covers for film cameras; cellular phones; smartphones; wireless communication devices featuring telecommunication functionality to allow the transmission of text, data, audio, image and video files; electronic monitoring devices comprised of microprocessors and accelerometers, for identifying, storing, reporting, monitoring, uploading and downloading data and information for personal physical fitness and training purposes; downloadable applications and software for smart watches and mobile devices, for processing, reviewing and editing data, to enable users to control the presentation and information available from the devices; wearable sensors for personal physical fitness and training purposes to gather biometric data and also including monitors and displays sold as a unit; smartwatches; wearable activity trackers; pedometers; smartwatches featuring software for sending and receiving data or to be used to monitor personal fitness activity; smart bracelets, rings or necklaces featuring software for sending and receiving data or to be used to monitor personal fitness activity.

11 – Lighting apparatus and installations; light diffusers; light-emitting diodes [LED] lighting apparatus; chandeliers; electric lamps; lamps; ceiling lights; luminous tubes for lighting; coffee percolators, electric; air deodorising apparatus; sanitary apparatus and installations.

21 – Napkin rings; bottle openers, electric and non-electric; cutting boards; drinking glasses; tankards; bottles; coffeepots, non-electric; shoe horns; decanters; window-boxes; flasks; graters for kitchen use; table plates; powder compacts; knife rests for the table; soap holders; napkin holders; salt cellars; coffee services [tableware]; coolers [ice pails]; liqueur sets; tea services [tableware]; spice sets; cruet sets for oil and vinegar; cups; kitchen utensils; utensils for household purposes; toilet utensils; tableware, other than knives, forks and spoons; cabarets [trays]; sugar bowls; pepper mills, hand-operated; corkscrews, electric and non-electric; non-electric juicers; cooking pot sets; chopsticks; nutcrackers.

24 – Towels of textile; bath linen, except clothing; bed linen; table linen of textile; diapered linen; brocades; tablemats, not of paper; bed blankets; travelling rugs [lap robes]; labels of cloth; handkerchiefs of textile; pillowcases; mattress covers; covers for cushions; pillow shams; linings (textile); wall hangings of textile; eiderdowns [down coverlets]; coasters [table linen]; textile material; table runners; tablecloths, not of paper; hemp cloth; curtains of textile or plastic; fabric; table napkins of textile; bed covers.

27 – Wallpaper; textile wallpaper; floor coverings; carpets; bath mats; decorative wall hangings, not of

textile; mats; linoleum for use on floors; area rugs; non-slip mats.

34 – Lighters for smokers; pocket machines for rolling cigarettes; smokers' articles; cigar cases, not of precious metal; tobacco pouches; matches; tobacco pipes; ashtrays for smokers.

(260) AM 2023 120124 A
 (800) 1636206
 (151) 2021 11 16
 (891) 2022 06 28
 (731) Aigle International
 57 boulevard de Montmorency, F-75016 Paris,
 France
 (540)



(591) Black, white
 (531) 03.07.01; 03.07.16; 03.07.24
 (511)
 18 – Purses (coin purses); wallets; wallets with card compartments; backpacks; handbags; fanny packs; school bags; bags for campers; beach bags; sports bags; traveling bags; suitcases; leather; imitation leather.

25 – Boots; belts (clothing); headwear; long scarves; gloves (clothing); underwear; clothing; footwear.

(260) AM 2023 120125 A
 (800) 1650848
 (151) 2021 12 01
 (891) 2022 09 23
 (731) Obschestvo s Ogranichenoy Otvetstven-
 Nostyu "Realt-Aktiv"
 Proezd Kalinovskogo, d.2, 225710 g. Pinsk,
 Brestskaya obl., Belarus

(540)



(591) Orange, white and black
 (531) 26.04.05; 26.04.18; 26.04.24; 27.05.01;
 27.05.09; 27.05.10; 27.05.24; 29.01.13

(511)
 9 – Accumulators, electric; batteries, electric, for vehicles; battery jars; battery boxes; grids for batteries; chargers for electric accumulators.

(260) AM 2023 120184 A
 (800) 1693109
 (151) 2022 07 20
 (891) 2022 07 20
 (731) Mastelli S.R.L.
 Via Bussana Vecchia, 32, I-18038 Sanremo
 (IM), Italy

(540)

PHILART

(591) Black, white
 (511)
 3 – Soaps for personal use; perfumery; essential oils; cosmetics; hair lotions; dentifrices.

5 – Medicated preparations for treatment of skin areas with a high fibrous content such as striae, scars, wrinkles; antibacterial soap; skin balms (creams) for medical purposes; chemical preparations for the skin for medical purposes; skin lotions for medical purposes; massage gels for medical purposes; medicinal oils for the skin; pharmaceutical preparations for medical skin care; medicated preparations for treating sunburns; dietary supplements for pharmaceutical purposes; food supplements; injectable dermal fillers; pre-filled syringes for medical purposes; serums for medical skin care; medicated oral or topical preparations for skin treatment and fungal diseases and mycosis treatment.

(260) AM 2023 120185 A
 (800) 1693111
 (151) 2022 06 02
 (891) 2022 06 02
 (731) Predo Sağlık Ürünleri Sanayi Ve Ticaret
 Anonim Sirketi
 5. Organize Sanayi Bolgesi, Nolu Cadde No: 30
 Baspinar/, TR-83561 Sehitkamil Gaziantep,
 Türkiye

(540)



(591) Blue, yellow, light blue, orange, red, green,
 white

(531) 01.15.15; 27.05.02; 27.05.08; 29.01.15
 (511)

3 – Bleaching and cleaning preparations, detergents other than for use in manufacturing operations and for medical purposes, laundry bleach, fabric softeners for laundry use, stain removers, dishwasher detergents, perfumery; non-medicated cosmetics; fragrances; deodorants for personal use and animals soaps, dental care preparations: dentifrices, denture polishes, tooth whitening preparations, mouth washes, not for medical purposes; abrasive preparations; emery cloth; san-

dpaper; pumice stone; abrasive pastes, polishing preparations for leather, vinyl, metal and wood, polishes and creams for leather, vinyl, metal and wood, wax for polishing.

5 – Pharmaceutical and veterinary preparations for medical purposes; chemical preparations for medical and veterinary purposes, chemical reagents for pharmaceutical and veterinary purposes; medicated cosmetics, dietary supplements for pharmaceutical and veterinary purposes; dietary supplements; nutritional supplements; medical preparations for slimming purposes; food for babies; herbs and herbal beverages adapted for medicinal purposes, dental preparations and articles: teeth filling material, dental impression material, dental adhesives and material for repairing teeth; sanitary preparations for medical use; hygienic pads; hygienic tampons; plasters; materials for dressings; diapers made of paper and textiles for babies, adults and pets, preparations for destroying vermin; herbicides, fungicides, preparations for destroying rodents, deodorants, other than for human beings or for animals; air purifying preparations; air deodorising preparations, disinfectants; antiseptics; detergents for medical purposes; medicated soaps; disinfectant soaps; antibacterial hand lotions.

16 – Paper and cardboard; paper and cardboard for packaging and wrapping purposes, cardboard boxes; paper towels; toilet paper; paper napkins, plastic materials for packaging and wrapping purposes, printing blocks and types; bookbinding material, printed publications; printed matter; books, magazines, newspapers, bill books, printed dispatch notes, printed vouchers, calendars; posters; photographs [printed]; paintings; stickers [stationery]; postage stamps, stationery, office stationery, instructional and teaching material [except furniture and apparatus]; writing and drawing implements; artists' materials; paper products for stationery purposes; adhesives for stationery purposes, pens, pencils, erasers, adhesive tapes for stationery purposes, cardboard cartons [artists' materials], writing paper, copying paper, paper rolls for cash registers, drawing materials, chalkboards, painting pencils, watercolors [paintings], office requisites, paint rollers and paintbrushes for painting.

(260) AM 2023 120186 A
 (800) 1693157
 (151) 2022 07 14
 (891) 2022 07 14
 (731) Limited Liability Company "Gexa – Nonwoven Materials"
 Tsentralnaya street, dom 3, litera A, A1,
 A2, a, pomeshchenie 304, d. Golievo,
 RU-143405 g. Krasnogorsk, Moskovskaya
 oblast, Russian Federation

(540)



(591) Black, white
 (531) 03.07.13; 26.01.03; 26.01.15
 (511)

5 – Bandages for dressings; bracelets impregnated with insect repellent; paper for mustard plasters; fly catching paper; reagent paper for veterinary purposes; reagent paper for medical purposes; mothproofing paper; antiseptic cotton; aseptic cotton; absorbent cotton; wadding for medical purposes; cotton for medical purposes; contraceptive sponges; corn rings for the feet; adhesive plasters; gauze for dressings; dressings, medical; surgical dressings; moleskin for medical purposes; fly glue; antiparasitic collars for animals; cotton sticks for medical purposes; nicotine patches for use as aids to stop smoking; eyepatches for medical purposes; poultices; compresses; scapulars for surgical purposes; babies' diapers; diapers for pets; swim diapers, reusable, for babies; swim diapers, disposable, for babies; diapers for incontinence; disposable absorbent mats for lining pet crates; diaper changing mats, disposable, for babies; disposable housebreaking pads for pets; bunion pads; breast-nursing pads; diagnostic strips for testing breast milk for medical purposes; collyrium; lead water; sanitary towels; panty liners [sanitary]; tissues impregnated with pharmaceutical lotions; cotton swabs for medical purposes; sanitary tampons; vulnerary sponges; pants, absorbent, for incontinence; sanitary panties; babies' diaper-pants.

10 – Physical exercise apparatus for medical purposes; body rehabilitation apparatus for medical purposes; dental apparatus and instruments; surgical apparatus and instruments; physiotherapy apparatus; nasal aspirators; trusses; maternity belts; support bandages; bandages, elastic; cupping glasses; ear plugs [hearing protection devices]; acupressure bands; bracelets for medical purposes; anti-nausea wristbands; anti-rheumatism bracelets; air cushions for medical purposes; vibromassage apparatus; surgical sponges; pill cutters; containers especially made for medical waste; clips, surgical; mirrors for dentists; mirrors for surgeons; probes for medical purposes; urethral probes; orthopedic articles; pill crushers; biodegradable bone fixation implants; contraceptive implants; surgical implants comprised of artificial materials; inhalers; hydrogen inhalers; injectors for medical purposes; incubators for medical purposes; incubators for babies; obstetric apparatus; surgical cutlery; chambers for inhalers; cannulae; droppers for medical purposes; dropper bottles for medical purposes; catheters; draw-sheets for sick beds; enema apparatus for medical purposes;

clips for dummies; menstrual cups; biomagnetic rings for therapeutic or medical purposes; teething rings; anti-rheumatism rings; abdominal corsets; corsets for medical purposes; crutches; haptic suits for medical purposes; waterbeds for medical purposes; air beds for medical purposes; beds specially made for medical purposes; lancets; kinesiology tapes; spoons for administering medicine; spoons for patients with tremor; sanitary masks; reusable sanitary masks made of gauze; masks for use by medical personnel; respiratory masks for artificial respiration; protective masks for medical purposes; anaesthetic masks; disposable steam-heated masks for therapeutic purposes; LED masks for therapeutic purposes; therapeutic facial masks; gum massagers for babies; suture materials; childbirth mattresses; air mattresses for medical purposes; furniture especially made for medical purposes; water bags for medical purposes; douche bags; breast pumps; urinals being vessels; portable hand-held urinals; teeth protectors for dental purposes; temperature indicator labels for medical purposes; knee bandages, orthopaedic; tips for crutches; fingerstalls for medical purposes; medical guidewires; thread, surgical; knives for surgical purposes; scissors for surgery; ambulance stretchers; stretchers, wheeled; boots for medical purposes; orthopaedic footwear; clothing especially for operating rooms; compression garments; blankets, electric, for medical purposes; supports for flat feet; cooling pads for first aid purposes; portable earpicks with endoscopy function; disposable steam-heated patches for therapeutic purposes; slings [support bandages]; gloves for massage; gloves for medical purposes; pessaries; ear picks; electric massage guns; cooling patches for medical purposes; spittoons for medical purposes; plaster bandages for orthopaedic purposes; orthopaedic bandages for joints; abdominal pads; cushions for medical purposes; pads for preventing pressure sores on patient bodies; air pillows for medical purposes; soporific pillows for insomnia; heating cushions, electric, for medical purposes; abdominal belts; galvanic belts for medical purposes; hypogastric belts; belts for medical purposes; orthopaedic belts; umbilical belts; belts, electric, for medical purposes; condoms; aerosol dispensers for medical purposes; esthetic massage apparatus; massage apparatus; veterinary apparatus and instruments; medical apparatus and instruments; urological apparatus and instruments; incontinence sheets; sterile sheets, surgical; surgical drapes; ice bags for medical purposes; toe separators for orthopaedic purposes; surgical bougies; orthodontic rubber bands; ear trumpets; strait jackets; scalpels; tongue scrapers; dummies for babies; vaginal syringes; hearing protectors; contraceptives, non-chemical; orthopaedic soles; medical examination tables; commode chairs; basins for medical purposes; bed pans; instrument cases for use by doctors; arch supports for footwear; suspensory bandages; thermal packs for first aid purposes; walking sticks for medical purposes; quad canes for medical purposes; drain-

nage tubes for medical purposes; capillary tubes for medical use; X-ray tubes for medical purposes; radium tubes for medical purposes; intrauterine devices; balling guns; patient examination gowns; wheeled walkers to aid mobility; walking frames for disabled persons; cases fitted for medical instruments; elastic stockings for surgical purposes; stockings for varices; splints, surgical; tongue depressors for medical purposes; syringes for injections; syringes for medical purposes; hypodermic syringes; uterine syringes; urethral syringes; forceps.

24 – Banners of textile or plastic; household linen; diapered linen; bath linen, except clothing; bed linen; table linen, not of paper; sew-on tags of textile for clothing; adhesive tags of textile for bags; buckram; fustian; sleeping bag liners; bunting of textile or plastic; table runners, not of paper; drugget; shower curtains of textile or plastic; curtains of textile or plastic; canvas for tapestry or embroidery; mats of textile for beer glasses; baby buntings; furniture coverings of textile; fabrics for textile use; filtering materials of textile; wall hangings of textile; non-woven textile fabrics; plastic material [substitute for fabrics]; textile material; tablemats of textile; bivouac sacks being covers for sleeping bags; sleeping bags; sleeping bags for babies; pillowcases; mattress covers; bed blankets; blankets for household pets; diaper changing cloths for babies; handkerchiefs of textile; picnic blankets; travelling rugs [lap robes]; coasters of textile; bed covers of paper; furniture coverings of plastic; face towels of textile; dish towels; towels of textile; tea towels; hemp cloth; gummed cloth, other than for stationery purposes; printers' blankets of textile; cloth; bed-sheets; bath mitts; glass cloths [towels]; cloths for removing make-up; place mats of textile; table napkins of textile; mosquito nets; tablecloths, not of paper; billiard cloth; lingerie fabric; fabric, impervious to gases, for aeronautical balloons; jute fabric; fabric for footwear; fibreglass fabrics for textile use; adhesive fabric for application by heat; linen cloth; upholstery fabrics; hemp fabric; lining fabric for footwear; reusable wax coated fabrics for wrapping food; elastic woven fabrics; fabric; flags of textile or plastic; trellis [cloth]; covers for cushions; fitted toilet lid covers of fabric; covers [loose] for furniture; pillow shams; labels of textile.

25 – Underwear; sweat-absorbent underwear; trousers; brassieres; adhesive bras; collars [clothing]; detachable collars; shirt yokes; waistcoats; sports jerseys; hosiery; pockets for clothing; scarves; cap peaks; visors being headwear; tights; combinations [clothing]; suits; headscarves; jackets [clothing]; leggings [trousers]; camisoles; sports singlets; cuffs; face coverings [clothing], not for medical or sanitary purposes; sleep masks; bibs, not of paper; bibs, sleeved, not of paper; hairdressing capes; heel protectors for shoes; ear muffs [clothing]; sweat-absorbent socks; footwear; paper clothing; outerclothing; ready-made clot-

hing; latex clothing; waterproof clothing; clothing incorporating LEDs; sportswear incorporating digital sensors; uniforms; clothing; clothing containing slimming substances; overcoats; knickers; parkas; pelerines; gloves [clothing]; warm gloves for touchscreen devices; pyjamas; headscarfs; scarfs; dresses; headbands [clothing]; garters; ready-made linings [parts of clothing]; dress shields; soles for footwear; girdles; belts [clothing]; sashes for wear; money belts [clothing]; layettes [clothing]; non-slipping devices for footwear; shirts; wooden shoes; sandals; bath sandals; boots; inner soles; bath slippers; knitwear [clothing]; underpants; slippers; shoes; headwear; aprons [clothing]; tee-shirts; rash guards; dressing gowns; tips for footwear; stockings; sweat-absorbent stockings; paper hats [clothing]; shower caps; bathing caps.

(260) AM 2023 120187 A
 (800) 1693179
 (151) 2022 10 05
 (891) 2022 10 05
 (731) Soremartec S.A.
 Route de Trèves 16, L-2633 Senningerberg,
 Luxembourg
 (540)

FULFIL

(591) Black, white
 (511)
 5 – Dietary supplements for humans; food supplements; health food supplements; mineral food supplements; health food supplements made principally of vitamins; health food supplements made principally of minerals; vitamin preparations in the nature of food supplements; vitamins and vitamin preparations.
 30 – Flour and preparations made from cereals; high-protein cereal bars; cereal bars, including energy bars; cereal-based protein snacks; rice snacks; cereal snacks; sesame snacks; rice cake snacks; fruit cake snacks; granola-based snack bars; snack foods prepared from muesli; snack foods prepared from maize; snack foods prepared from wheat; snack foods prepared from whole wheat; snack foods consisting principally of confectionery; snack foods prepared from potato flour; snack foods consisting principally of grains; snack bars containing a mixture of grains, nuts and dried fruit [confectionery].

(260) AM 2023 120196 A
 (800) 1693271
 (151) 2022 01 16
 (891) 2022 01 16
 (731) Hub Kozmetik Sanayi Ve Ticaret Anonim
 Şirketi
 Beylikdüzü Osb Mah., Mustafa Kurtoğlu
 Cad. 9/3, Beylikdüzü, İstanbul, Türkiye

(540)



(591) Purple
 (531) 26.04.05; 26.04.22; 27.05.10; 27.05.17;
 29.01.12

(511)
 3 – Bleaching and cleaning preparations, detergents other than for use in manufacturing operations and for medical purposes, laundry bleach, fabric softeners for laundry use, stain removers, dishwasher detergents; perfumery; non-medicated cosmetics; fragrances; deodorants for personal use and animals; soaps; dental care preparations; dentifrices, denture polishes, tooth whitening preparations, mouth washes, not for medical purposes; abrasive preparations; emery cloth; sandpaper; pumice stone; abrasive pastes; polishing preparations for leather, vinyl, metal and wood, polishes and creams for leather, vinyl, metal and wood, wax for polishing.

35 – The bringing together, for the benefit of others, of a variety of goods, namely, bleaching and cleaning preparations, detergents other than for use in manufacturing operations and for medical purposes, laundry bleach, fabric softeners for laundry use; stain removers, dishwasher detergents; perfumery; non-medicated cosmetics; fragrances; deodorants for personal use and animals, soaps, dental care preparations; dentifrices, denture polishes, tooth whitening preparations, mouth washes, not for medical purposes, abrasive preparations; emery cloth; sandpaper; pumice stone; abrasive pastes, polishing preparations for leather, vinyl, metal and wood, polishes and creams for leather, vinyl, metal and wood, wax for polishing; pharmaceutical and veterinary preparations for medical purposes; chemical preparations for medical and veterinary purposes, chemical reagents for pharmaceutical and veterinary purposes; medicated cosmetics, dietary supplements for pharmaceutical and veterinary purposes; dietary supplements; nutritional supplements; medical preparations for slimming purposes; food for babies; herbs and herbal beverages adapted for medicinal purposes, dental preparations and articles; teeth filling material, dental impression material, dental adhesives and material for repairing teeth; sanitary preparations for medical use; hygienic pads; hygienic tampons; plasters; materials for dressings; diapers made of paper and textiles for babies, adults and pets, preparations for destroying vermin; herbicides, fungicides, preparations for destroying rodents; deodorants, other than for human beings or for animals; air purifying preparations; air deodorising preparations, disinfectants; antiseptics; detergents for medical purposes; medicated soaps; disinfectant soaps; antibacterial hand lotions; forks, spoons, knives and non-electric cutters, slicers; peelers for kitchen use; including those made of precious metals; side arms and blades (we-

apons), tools and apparatus included in this class for personal beauty care use; tools and apparatus included in this class for shaving, epilation, manicure and pedicure, electric hand implements for straightening and curling hair, scissors, hand-operated [non-electric] hand tools included in this class for the repair of machines, apparatus and vehicles and for use in construction, agriculture, horticulture and forestry, none of them being power tools, electric or non-electric irons; steam irons, handles for hand-operated hand tools, pasteurizers and sterilizers, furniture, made of any kind of material; mattresses; pillows; air mattresses and cushions, not for medical purposes, water beds; mirrors; beehives, artificial honeycombs and sections of wood for honeycombs; bouncing chairs for babies, playpens for babies, cradles, infant walkers; display boards, frames for pictures and paintings, identification plates, identification tags, nameplates, identification labels made of wood or synthetic materials, packaging containers of wood or plastics, casks for use in transportation or storage, barrels, storage drums, tanks, boxes, storage containers, transportation containers, chests, loading pallets and closures for the aforementioned goods, of wood or plastics; small hardware goods of wood or synthetic materials included in this class, furniture fittings, of wood or synthetic materials, opening and closing mechanisms of wood or synthetic materials; ornaments and decorative goods of wood, cork, reed, cane, wicker, horn, bone, ivory, whalebone, shell, amber, mother-of-pearl, meerschaum, beeswax, plastic or plaster namely figurines, holiday ornaments for walls, sculptures, trophies; baskets, fishing baskets; kennels, nesting boxes and beds for household pets; portable ladders and mobile boarding stairs of wood or synthetic materials, bamboo curtains, roller indoor blinds [for interiors], slatted indoor blinds, strip curtains, bead curtains for decoration, curtain hooks, curtain rings, curtain tic-backs, curtain rods; non-metal wheel chocks; hand-operated non-electric cleaning instruments and appliances, brushes, other than paintbrushes, steel chips for cleaning, sponges for cleaning, steel wool for cleaning, cloths of textile for cleaning, gloves for dishwashing, non-electric polishing machines for household purposes, brooms for carpets, mops; toothbrushes, electric toothbrushes, dental floss, shaving brushes, hair brushes, combs, non-electric household or kitchen utensils, included in this class, [other than forks, knives, spoons], services [dishes], pots and pans, bottle openers, flower pots, drinking straws, non-electric cooking utensils; ironing boards and shaped covers therefor, drying racks for washing, clothes drying hangers, cages for household pets, indoor aquariums, vivariums and indoor terrariums for animals and plant cultivation; ornaments and decorative goods of glass, porcelain, earthenware or clay namely statues, figurines, vases and trophies; mouse traps, insect traps, electric devices for attracting and killing flies and insects, fly catchers, fly swatters; perfume burners, perfume sprayers, perfume va-

porizers, electric or non-electric make-up removing appliances, powder puffs, toilet cases; nozzles for sprinkler hose, nozzles for watering cans, watering devices, garden watering cans, unworked or semi-worked glass, except building glass, mosaics of glass and powdered glass for decoration, except for building, glass wool other than for insulation or textile use, enabling customers to conveniently view and purchase those goods, such services may be provided by retail stores, wholesale outlets, by means of electronic media or through mail order catalogues (term considered too vague by the International Bureau – Rule 13 (2) (b) of the Regulations).

(260) AM 2023 120198 A
 (800) 1693299
 (151) 2022 09 08
 (891) 2022 09 08
 (731) Unicosmetic Company Limited
 Piskarevskiy prospect, 63, k. 6, liter A,
 pom. 5-N, office 11, RU-195273
 Saint-Petersburg, Russian Federation

(540)



(591) Black, white
 (531) 27.05.01; 27.05.10
 (511)

3 – Balms, other than for medical purposes; lip glosses; cotton wool for cosmetic purposes; toilet water; perfumes; perfumery; cosmetic pencils; creams for leather; cosmetic creams; hair spray; nail varnish; hair lotions; lotions for cosmetic purposes; beauty masks; oils for cosmetic purposes; almond milk for cosmetic purposes; cleansing milk for toilet purposes; soap; deodorant soap; cosmetic kits; nail art stickers; cotton sticks for cosmetic purposes; toothpaste; dentifrices; lipsticks; pomades for cosmetic purposes; hair waving preparations; lacquer-removing preparations; make-up removing preparations; nail care preparations; aloe vera preparations for cosmetic purposes; sunscreen preparations; make-up powder; false eyelashes; tissues impregnated with cosmetic lotions; eyebrow cosmetics; make-up preparations; sun-tanning preparations [cosmetics]; hair dyes; neutralizers for permanent waving; cosmetic preparations for eyelashes; depilatory and exfoliating preparations; depilatory preparations; cosmetic preparations for skin care; cosmetic hair dressing preparations; cosmetics; mascara; detergents, other than for use in manufacturing operations and for medical purposes; bleaching preparations [decolorants] for cosmetic purposes; antiperspirants [toilettries]; serums for cosmetic purposes; talcum powder, for toilet use; shampoos; dry shampoos; extracts of flowers [perfumes]; ethereal essences.

(260) AM 2023 120199 A
 (800) 1693305
 (151) 2022 09 26
 (891) 2022 09 26
 (731) Claris International Inc.
 One Apple Park Way, Cupertino CA 95014,
 USA

(540)
CLARIS WEBDIRECT

(591) Black, white
 (511)
 42 – Design and development of computer hardware and software; providing temporary use of on-line non-downloadable software for viewing, annotating, storing, downloading and distributing electronic files, images, audio, video, data, and documents; providing temporary use of on-line non-downloadable software for audio and video conferencing; providing temporary use of on-line non-downloadable software for personal information management, database management, and database synchronization; providing temporary use of on-line non-downloadable software for accessing, browsing and searching online databases; providing temporary use of on-line non-downloadable software for communication and collaboration via computer networks; providing temporary use of on-line non-downloadable software development tools and templates for data management; providing temporary use of on-line non-downloadable software for use in managing, organizing and sharing data on a global computer network and on local computer networks; computer services, namely, providing online facilities for viewing, annotating, storing, downloading and distributing electronic files, images, audio, video, data, and documents, and for audio and video conferencing, and for personal information management, database management, and database synchronization, and for accessing, browsing and searching online databases, and for communication and collaboration via computer networks, and for software development, and for managing, organizing and sharing data on a global computer network and on local computer networks; data hosting services; technical support services, namely, trouble shooting computer database problems by telephone and via a global computer information network; application service provider (ASP) featuring software in the field of database management; electronic storage of files, images, audio, video, data, and documents.

(260) AM 2023 120200 A
 (800) 1693383
 (151) 2022 03 22
 (891) 2022 03 22
 (731) Koppert B.V.
 Veilingweg 14, NL-2651 BE Berkel en
 Rodenrijs, Netherlands

(540)
KOPPERT

(591) Black, white
 (511)
 1 – Fertilizers; biostimulants for plants; soil conditioners; products for stimulating the growth and development and improvement of crops; substances for promoting plant growth; plant growth nutrients; growth regulating preparations for crops; seed preserving substances; adjuvants for agriculture, horticulture and forestry.
 5 – Preparations and products for the protection of crops against pests, vermin, diseases and insects included in this class, including preparations and products for the protection of crops against pests, vermin, diseases and insects based on micro-organisms or natural substances included in this class; biocides; pesticides; insecticides; fungicides; acaricides; parasiticides; preparations and products for controlling pests and vermin, including insects; herbicides; adhesive strips for catching insects; insect repellents; insect attractants; repellents for animals; veterinary preparations; parasite-killing agents; nutritional supplements for animals.
 9 – Software for use in agriculture, horticulture, forestry and livestock healthcare and farming; hardware for use in agriculture, horticulture, forestry and livestock healthcare and farming; application software for use in agriculture, horticulture, forestry and livestock healthcare and farming; downloadable software applications for use in agriculture, horticulture, forestry and livestock healthcare and farming; mobile apps for use in agriculture, horticulture, forestry and livestock healthcare and farming; computer software platforms for use in agriculture, horticulture, forestry and livestock healthcare and farming; environmental monitoring software for use in agriculture, horticulture, forestry and livestock healthcare and farming; measuring, detecting and monitoring instruments, indicators and controllers for use in agriculture, horticulture, forestry and livestock healthcare and farming; monitoring instruments for use in agriculture, horticulture, forestry and livestock healthcare and farming; observation instruments for use in agriculture, horticulture, forestry and livestock healthcare and farmings.
 20 – Beehives; nest boxes for bumblebees.
 21 – Devices for pest and vermin control; diffusers for controlling pests and vermin, including insects; insect traps; fly traps.
 31 – Agricultural, horticultural, forestry and livestock products and grains not included in other classes; live animals, including live animals for pest control and for pollination; animal feed; dried insects (animal foodstuffs); insects (dried) for use in animal nutrition.
 44 – Agriculture, horticulture, forestry and livestock

healthcare and farming services; advisory and consultancy services relating to agriculture, horticulture, forestry and livestock healthcare and farming; services relating to the control and extermination of insects, micro-organisms, pests and vermin for agriculture, horticulture, forestry and livestock and pollination; consultancy in the field of biological pest and disease control and in the field of natural pollination; cultivation of insects, mites, nematodes, fungi, bacteria and bumblebees; consultancy in relation to agricultural services for the analysis of samples taken from crops for determining possible diseases and pests; on-site checking (including by hand) to determine possible diseases and pests; pest control services for agriculture, horticulture and forestry by placing traps (possibly in combination with bait) for detecting insects whereby diseases and pests, caused by those insects, can be determined and controlled; verbal and written reporting in response to samples taken and checking (including by hand) for possible diseases and pests; the aforementioned services also provided through the use of drones, agricultural, horticultural, forestry and livestock machines, equipment, apparatus and vehicles.

(260) AM 2023 120201 A
 (800) 1693445
 (151) 2022 07 11
 (891) 2022 07 11
 (731) Euro Games Technology Ltd.
 4, "Maritsa" Str., "Vranya-Lozen-
 Triugulnika", BG-1151 Sofia, Bulgaria
 (540)

Gems' Realm

(591) Black, white
 (511)
 9 – Software; computer gaming software; computer software packages; computer operating system software; computer software, recorded; software drivers; virtual reality software; games software; entertainment software for computer games; computer programs for network management; operating computer software for main frame computers; monitors (computer hardware); computer hardware; apparatus for recording images; monitors (computer programs); computer game programs; computer programs for recorded games; apparatus for recording, transmission or reproduction of sound or images; communications servers [computer hardware]; electronic components for gambling machines; computer application software featuring games and gaming; computer software for the administration of on-line games and gaming; computer hardware for games and gaming; hardware and software for gambling, gambling machines, gambling games on the Internet and via telecommunication network.
 28 – Gaming machines for gambling; chips for gam-

bling; mah-jong; arcade games; gambling machines operating with coins, notes and cards; games; electronic games; parlor games; gaming chips; gaming tables; slot machines [gaming machines]; LCD game machines; slot machines and gaming devices; coin-operated amusement machines; roulette chips; poker chips; chips and dice [gaming equipment]; gaming equipment for casinos; roulette tables; gaming roulette wheels; casino games; gambling machines and amusement machines, automatic and coin-operated; coin-operated amusement machines and/or electronic coin-operated amusement machines with or without the possibility of gain; boxes for coin-operated machines, slot machines and gaming machines; electronic or electrotechnical amusement machines and apparatus, gaming machines, coin-operated entertainment machines; housings for coin-operated machines, gaming equipment, gaming machines, machines for gambling; electropneumatic and electrical gambling machines (slot machines).

41 – Gambling; entertainment services related to gambling; gaming services for entertainment purposes; casino, gaming and gambling services; training in the development of software systems; provision of gaming equipment for gambling halls; providing casino equipment [gambling]; gaming machine entertainment services; providing casino facilities [gambling]; gaming hall services; amusement arcade services; games equipment rental; rental of gaming machines; providing amusement arcade services; rental of gaming machines with images of fruits; editing or recording of sounds and images; sound recording and video entertainment services; hire of sound reproducing apparatus; provision of gaming equipment for casinos; providing of casino facilities; online gambling services; casino, gaming and gambling services; provision of gaming facilities, gaming hall facilities, Internet casinos and online gambling services.

(260) AM 2023 120202 A
 (800) 1693516
 (151) 2022 09 15
 (891) 2022 09 15
 (731) Beijing Niu Technology Co., LTD.
 No. 1 Building, No. 195 Huilongguan
 East Road, Changping District, 102208
 Beijing, China
 (540)

NIUAERO

(591) Black, white
 (511)
 9 – Rechargeable batteries; battery charging equipment; remote controls for drones; digital controls for robot machines; digital controls for drones; computer software and hardware for the control of robots; computer software and hardware for the control of drones; intelligent sensors; remotely controlled robotic sys-

tems comprised of computer hardware, computer software, monitors, sensors and/or cameras to gather information and transmit or display audio and video communications and other electronic data; downloadable electronic publications; downloadable computer software applications for use in controlling robots and drones; downloadable smartphone application software for use in controlling robots and drones; gesture recognition software; apparatus for the recording, transmission and reproduction of sound and images; operating systems for robots; computer hardware and software; downloadable mobile applications for starting and stopping, scheduling, customizing and monitoring robots and drones; infrared remote control apparatus; software and sensors that allow a robotic device to sense and respond to environmental inputs; communication devices and software for use with robots; cameras; camera mounts; cameras [photography]; video cameras; cases especially made for photographic apparatus and instruments.

12 – Unmanned aerial vehicles; drones; camera drones; electric vehicles; remote control vehicles, other than toys; propellers for air vehicles; propeller blade protectors for aircraft; parts and fittings for the aforesaid goods.

28 – Toys, games and playthings; toy robots; smart robot toys; motorized toy robots; remote controlled toy robots; toy vehicles; remote controlled flying toys, particularly remote controlled helicopters and quadcopters; drones [toys].

38 – Communication by electronic means; providing access to databases; transmission of data via satellite and cloud; transmission of electronic mail; message sending; transmission of information; providing access to information on the Internet; transmission of information signals; interactive communication services; communication services for the remote control of electronic devices; electronic transmission of data and documents via computer terminals and electronic devices; signal transmission for electronic commerce via telecommunications systems and data communication systems; providing access to electronic communications networks and electronic databases; provision of communication facilities for the interchange of digital data; communication of data by means of telecommunications; transmission of data, including by audiovisual apparatus; transmission of sound, picture, video and data signals; data bank interconnection services.

(260) AM 2023 120203 A

(800) 1693585

(151) 2022 07 28

(891) 2022 07 28

(731) Sinochem Corporation

28 Fuxingmennei Street, Xicheng District,
Beijing, China

(540)

sinochem

(591) Black, white

(531) 27.05.01

(511)

1 – Adhesives for industrial purposes; auxiliary fluids for use with abrasives; acetates (chemicals); acetone; acids; chemical additives to drilling muds; chemical additives to motor fuel; detergent additives to petrol; activated carbon; propellant gases for aerosols; agricultural chemicals, except fungicides, herbicides, insecticides and parasiticides; alkalies; alkaline-earth metals; alcohol; ethyl alcohol; aldehydes; seaweeds (fertilizers); chemical substances for preserving foodstuffs; chemical preparations for facilitating the alloying of metals; soil conditioning preparations; animal charcoal; antifreeze; anti-incrustants; size for use in the textile industry; engine-decarbonising chemicals; nitrogenous fertilizers; galvanizing baths; baryta; chemicals, except pigments, for the manufacture of enamel; benzene derivatives; benzoic acid; saccharin; concrete-aeration chemicals; biochemical catalysts; drilling muds; plasticizers; rubber preservatives; catalysts; cellulose; paper pulp; ketones; animal carbon preparations; industrial chemicals; chemical preparations for scientific purposes, other than for medical or veterinary use; chemical reagents, other than for medical or veterinary purposes; chemical substances for analyses in laboratories, other than for medical or veterinary purposes; cement-waterproofing chemicals, except paints; citric acid for industrial purposes; preservatives for use in the pharmaceutical industry; chemical preparations for use in photography; leather-dressing chemicals; separating and unsticking [ungluing] preparations; oil-separating chemicals; gum solvents; distilled water; purification preparations; fertilizers; enzymes for industrial purposes; gas purifying preparations; esters; ethers; ethyl ether; stain-preventing chemicals for use on fabrics; fire extinguishing compositions; fireproofing preparations; fluorspar compounds; graphite for industrial purposes; foundry moulding preparations; chemical additives to insecticides; chemical additives to fungicides; fulling preparations; brake fluid; protective gases for welding; solidified gases for industrial purposes; horticultural chemicals, except fungicides, herbicides, insecticides and parasiticides; oil-purifying chemicals; textile-waterproofing chemicals; isotopes for industrial purposes; metal annealing preparations; chemical preparations to prevent mildew; hydrogen peroxide for industrial purposes; phenol for industrial purposes; plastics, unprocessed; protein (raw material); synthetic resins, unprocessed; refrigerants; salts (chemical preparations); seed preserving substances; sulfides; soldering chemicals; sulfuric acid; chemicals for use in forestry, except fungicides, herbicides, insecticides and parasiticides; calcium salts; surface-active chemical agents; preparations for preventing the tarnishing of glass; toluol; peat (fertilizer); alkaloids; alu-

minium acetate; colour-brightening chemicals for industrial purposes; chemicals for the manufacture of paints; biological preparations, other than for medical or veterinary purposes; sensitized films, unexposed; carbon black for industrial purposes; dispersions of plastics; artificial sweeteners (chemical preparations); water-purifying chemicals; filtering materials of chemical substances; plant growth regulating preparations; preparations of trace elements for plants; chemical intensifiers for rubber; chemical additives for oils; oil cement (putty); glucose for the food industry; lecithin for the food industry; lactose for the food industry; tea extracts for use in the manufacture of pharmaceuticals; antioxidants for use in the manufacture of pharmaceuticals; proteins for the food industry.

2 – Dyestuffs; pigments; food dyes; printing ink; paints; anti-corrosive preparations; mastic (natural resin); dyes; coatings (paints); mordants; protective preparations for metals; food dyes.

4 – Coal; fuel; wax (raw material); wax for lighting; industrial wax; coke; mineral fuel; dust removing preparations; gas for lighting; lubricating oil; petrol; diesel oil; fuel gas; oil-gas; kerosene; lubricants; naphtha; paraffin; petroleum, raw or refined; fuel oil; industrial oil; solidified gases (fuel); motor oil; electrical energy.

5 – Air purifying preparations; albuminous preparations for medical purposes; preparations for destroying noxious animals; mothproofing preparations; bacterial preparations for medical and veterinary use; biocides; capsules for medicines; pharmaceutical preparations; wadding for medical purposes; chemico-pharmaceutical preparations; compresses; vitamin preparations; chemical conductors for electrocardiograph electrodes; solutions for contact lenses; cotton for medical purposes; vaccines; teeth filling material; dental lacquer; dressings, medical; depuratives; drugs for medical purposes; fungicides; germicides; medicinal herbs; semen for artificial insemination; liquorice for pharmaceutical purposes; herbicides; nutritive substances for microorganisms; chemical preparations for treating wheat blight; sanitary towels; phenol for pharmaceutical purposes; parasiticides; herbal teas for medicinal purposes; soil-sterilizing preparations; veterinary preparations; vermin destroying preparations; acetates for pharmaceutical purposes; food for babies; biological preparations for medical purposes; gases for medical purposes; chemical preparations for pharmaceutical purposes; medicines for human purposes; medicines for veterinary purposes; isotopes for medical purposes; dietetic substances adapted for medical use; biological preparations for veterinary purposes; chemical preparations for medical purposes; chemical preparations for veterinary purposes; chemical reagents for medical or veterinary purposes; amino acids for medical purposes; amino acids for veterinary purposes; nutritional supplements; acaricides; antibiotics;

dietary supplements for animals; protein dietary supplements; protein supplements for animals; pesticides; diapers for pets; disinfectants; surgical glues; medicated animal feed; diagnostic preparations for veterinary purposes; powdered milk for babies; plant extracts for pharmaceutical purposes; phytotherapy preparations for medical purposes; herbal extracts for medical purposes.

17 – Rubber, raw or semi-worked; flexible hoses, not of metal; insulating materials; junctions, not of metal, for pipes; adhesive bands, other than stationery and not for medical or household purposes; plastic substances, semi-processed; packing (cushioning, stuffing) materials of rubber or plastics; floating anti-pollution barriers; plastic sheeting for agricultural purposes; insulating refractory materials.

35 – Advertising; providing business information; providing commercial information and advice for consumers in the choice of products and services; commercial administration of the licensing of the goods and services of others; sales promotion for others; import-export agency services; provision of an online marketplace for buyers and sellers of goods and services; personnel management consultancy; systemization of information into computer databases; accounting; rental of vending machines; sponsorship search; rental of sales stands; retail services for pharmaceutical, veterinary and sanitary preparations and medical supplies.

36 – Insurance underwriting; providing financial information; art appraisal; real estate management; financial customs brokerage services; surety services; charitable fund raising; trusteeship; lending against security; financial research.

42 – Chemistry services; technological research; industrial design; material testing; meteorological information; geological prospecting; authenticating works of art; computer software design; dress designing; graphic arts design; quality control; biological research; cloud seeding; handwriting analysis (graphology); cartography services; business card design; graphic design of promotional materials; rental of meters for the recording of energy consumption.

(260) AM 2023 120206 A
 (800) 1693695
 (151) 2022 08 29
 (891) 2022 08 29
 (731) Mayeri Industries AS
 Voldi tee 9, Tabivere, EE-49127 Tartu
 county, Estonia

(540)

Mayeri

(591) Black, white
 (531) 27.05.01

(511)

3 – Bleaching preparations and other substances for laundry use; cleaning, polishing, scouring and abrasive preparations; non-medicated soaps; perfumery products, essential oils, non-medicated cosmetics, non-medicated hair lotions; non-medicated dentifrices.

(260) AM 2023 120207 A

(800) 1693760

(151) 2022 08 17

(891) 2022 08 17

(731) KUCHEVSKYI Serhii Vasylovych
prov. Druhyi Stetsenka, 4, m. Vinnytsia 21009,
Ukraine

(540)



(591) Red, shades of red, gray and black

(531) 04.03.03; 24.01.05; 24.01.09; 25.12.03; 28.05;
29.01.12

(511)

32 – Aloe vera drinks, non-alcoholic; aperitifs, non-alcoholic; barley wine (beer); beer; beer wort; beer-based cocktails; aerated water; preparations for making aerated water; cider, non-alcoholic; cocktails, non-alcoholic; energy drinks; extracts of hops for making beer; fruit juices; fruit nectars, non-alcoholic; ginger beer; grape must, unfermented; isotonic beverages; kvass; lemonades; lithia water; malt beer; malt wort; mineral water (beverages); must; non-alcoholic beverages; non-alcoholic beverages flavoured with coffee; non-alcoholic beverages flavoured with tea; non-alcoholic dried fruit beverages; non-alcoholic essences for making beverages; non-alcoholic fruit extracts; non-alcoholic fruit juice beverages; non-alcoholic honey-based beverages; preparations for making non-alcoholic beverages; orgeat; pastilles for effervescing beverages; powders for effervescing beverages; protein-enriched sports beverages; rice-based beverages, other than milk substitutes; sarsaparilla (non-alcoholic beverage); seltzer water; shandy; sherbets (beverages); smoothies; soda water; soft drinks; soya-based beverages, other than milk substitutes; starch-based dry mixes for beverage preparation; syrups for beverages; syrups for lemonade; table waters; tomato juice (beverage); vegetable juices (beverages); waters (beverages); whey beverages.

33 – Anise (liqueur); anisette (liqueur); aperitifs; arack (arak); alcoholic beverages containing fruit; alcoholic beverages, except beer; bitters; brandy; cider;

cocktails; curacao; digestifs (liqueurs and spirits); distilled beverages; alcoholic essences; alcoholic extracts; fruit extracts, alcoholic; gin; grain-based distilled alcoholic beverages; hydromel (mead); kirsch; liqueurs; peppermint liqueurs; perry; piquette; pre-mixed alcoholic beverages, other than beer-based; rice alcohol; rum; sake; spirits (beverages); sugarcane-based alcoholic beverages; vodka; whisky; wine; wine-based beverages.

(260) AM 2023 120208 A

(800) 1693812

(151) 2022 08 19

(891) 2022 08 19

(731) Subsidiary Company "Confectionery
Corporation "Roshen"
1 Nauky Avenue, building 1, Kyiv 03039,
Ukraine

(540)

RAINBOW BELTS

(591) Black, white

(511)

30 – Chewing gum; caramels [sweets]; confectionery; confectionery for decorating Christmas trees; nougat; stick liquorice [confectionery]; lozenges [confectionery]; fruit jellies [confectionery]; fruit confectionery; sweets; chewing candy.

(260) AM 2023 120209 A

(800) 1693855

(151) 2022 06 07

(891) 2022 06 07

(731) SmithKline Beecham Limited
980 Great West Road, Brentford, Middlesex
TW8 9GS, United Kingdom

(540)



(591) Orange

(531) 27.05.01; 29.01.01

(511)

5 – Pharmaceutical and medicinal preparations and substances; chemical, biochemical and biological preparations and agents for medical purposes; therapeutic agents (medical); adhesive patches for medical purposes; adhesive patches for surgical purposes; adhesive patches incorporating a pharmaceutical preparation; medicated patches, plasters and dressings for the treatment of skin diseases, conditions and disorders; vaccines; adjuvants for medical purposes; vitamins, minerals and food supplements; dietary preparations; dietary supplements and dietetic preparations; diagnostic preparations; disinfectants and antiseptics; medical dressings and medical plasters; pharmaceuticals and natural remedies; medicated and sanitising soaps and detergents; sanitary preparations and artic-

les; drug delivery agents that facilitate the delivery of pharmaceutical preparations.

10 – Surgical and medical apparatus and instruments; inhalers; injectors for medical purposes; medical apparatus and instruments for use in the diagnosis and treatment of skin diseases, conditions and disorders; artificial skin for surgical purposes; artificial skin replacing membranes; suture materials; skin biopsy punches; surgical punches; apparatus for carrying out diagnostic tests of the skin for medical purposes; medical and diagnostic apparatus for allergy testing; transcutaneous electrical nerve stimulation devices to treat body pain; bioelectronic treatment devices for medical purposes; implantable electrodes for medical purposes; adaptive open and or closed-loop bioelectronic medical devices that deliver stimulation and/or blocking to a nerve and optionally can record incoming action potentials and physiological parameters, analyse data in real time and modulate neural signalling; drug delivery devices for the deferred, controlled or immediate release of pharmaceutical preparations into the human body; sleep monitoring devices for medical purposes; electromagnetic therapy devices and electromagnetic apparatus for medical purposes; infrared therapy devices and infrared apparatus for medical purposes; ultrasound therapy devices and ultrasound apparatus for medical purposes; laser therapy devices and laser apparatus for medical purposes; diagnostic apparatus for medical purposes; electronic instruments for medical use; thermometers for medical use; cooling patches for medical use; parts and fittings for all aforesaid goods; artificial organs and implants; contraceptive devices; diagnostic, examination, and monitoring equipment; suture and wound closing materials and products; surgical and wound treating equipment; prosthetics and artificial implants; medical imaging apparatus; diagnostic apparatus for medical purposes; electronic monitoring instruments for medical use; medical instruments for recording, collecting and storing physiological data; applicators for pharmaceutical preparations; receptacles for applying medicines.

42 – Scientific research for medical and healthcare purposes; research and development services in the fields of bioelectronics, drug discovery, drug discovery products, pharmaceuticals, medicinal diagnostics, biochemicals, biotechnology, biological products, medical apparatus, devices and instruments; conducting clinical trials; genetic testing and genetic fingerprinting for research purposes; scientific consulting; supply of information in the area of laboratory technology; medical laboratory services; provision of scientific information; design of computational models and systems of artificial intelligence; medical and pharmacological research services; scientific and technological services; testing, authentication and quality control; software development, programming and implementation; scientific research in the field of gene and cell

therapy; provision of information, consultancy and advisory services relating to any of the aforesaid services.

(260) AM 2023 120210 A

(800) 1693856

(151) 2022 06 07

(891) 2022 06 07

(731) SmithKline Beecham Limited

980 Great West Road, Brentford, Middlesex
TW8 9GS, United Kingdom

(540)



(591) Black, white

(531) 26.04.04; 26.04.22; 26.04.24; 27.05.24

(511)

5 – Pharmaceutical and medicinal preparations and substances; chemical, biochemical and biological preparations and agents for medical purposes; therapeutic agents (medical); adhesive patches for medical purposes; adhesive patches for surgical purposes; adhesive patches incorporating a pharmaceutical preparation; medicated patches, plasters and dressings for the treatment of skin diseases, conditions and disorders; vaccines; adjuvants for medical purposes; vitamins, minerals and food supplements; dietary preparations; dietary supplements and dietetic preparations; diagnostic preparations; disinfectants and antiseptics; medical dressings and medical plasters; pharmaceuticals and natural remedies; medicated and sanitising soaps and detergents; sanitary preparations and articles; drug delivery agents that facilitate the delivery of pharmaceutical preparations.

10 – Surgical and medical apparatus and instruments; inhalers; injectors for medical purposes; medical apparatus and instruments for use in the diagnosis and treatment of skin diseases, conditions and disorders; artificial skin for surgical purposes; artificial skin replacing membranes; suture materials; skin biopsy punches; surgical punches; apparatus for carrying out diagnostic tests of the skin for medical purposes; medical and diagnostic apparatus for allergy testing; transcutaneous electrical nerve stimulation devices to treat body pain; bioelectronic treatment devices for medical purposes; implantable electrodes for medical purposes; adaptive open and or closed-loop bioelectronic medical devices that deliver stimulation and/or blocking to a nerve and optionally can record incoming action potentials and physiological parameters, analyse data in real time and modulate neural signalling;

drug delivery devices for the deferred, controlled or immediate release of pharmaceutical preparations into the human body; sleep monitoring devices for medical purposes; electromagnetic therapy devices and electromagnetic apparatus for medical purposes; infrared therapy devices and infrared apparatus for medical purposes; ultrasound therapy devices and ultrasound apparatus for medical purposes; laser therapy devices and laser apparatus for medical purposes; diagnostic apparatus for medical purposes; electronic instruments for medical use; thermometers for medical use; cooling patches for medical use; parts and fittings for all aforesaid goods; artificial organs and implants; contraceptive devices; diagnostic, examination, and monitoring equipment; suture and wound closing materials and products; surgical and wound treating equipment; prosthetics and artificial implants; medical imaging apparatus; diagnostic apparatus for medical purposes; electronic monitoring instruments for medical use; medical instruments for recording, collecting and storing physiological data; applicators for pharmaceutical preparations; receptacles for applying medicines.

42 – Scientific research for medical and healthcare purposes; research and development services in the fields of bioelectronics, drug discovery, drug discovery products, pharmaceuticals, medicinal diagnostics, biochemicals, biotechnology, biological products, medical apparatus, devices and instruments; conducting clinical trials; genetic testing and genetic fingerprinting for research purposes; scientific consulting; supply of information in the area of laboratory technology; medical laboratory services; provision of scientific information; design of computational models and systems of artificial intelligence; medical and pharmacological research services; scientific and technological services; testing, authentication and quality control; software development, programming and implementation; scientific research in the field of gene and cell therapy; provision of information, consultancy and advisory services relating to any of the aforesaid services.

(260) AM 2023 120212 A

(800) 1693889

(151) 2022 07 21

(891) 2022 07 21

(731) Mekvabishvili Merabi Dzhemalovich
ul. Potapovskaya roshcha, d. 2, korp. 4,
kv. 33, p. Kommunarka, poselenie Sosenskoe,
RU-108801 Moscow, Russian Federation

(540)



(591) White, grey and purple

(531) 20.05.13; 26.05.01; 26.15.25; 27.05.24;
29.01.13

(511)

6 – Buckles of common metal [hardware]; doors of metal; armoured doors of metal; doors and windows of metal; doors of metal for indoor use; folding doors of metal; swing doors of metal; accordion doors of metal; door closers of metal, non-electric; door bolts of metal; bolts, flat; latches of metal; locks of metal, other than electric; door bells of metal, non-electric; door frames of metal; door hinges of metal; door panels of metal; building panels of metal; partitions of metal; lintels of metal; sills of metal; door fittings of metal; buildings of metal; buildings, transportable, of metal; door stops of metal; stops of metal; ironwork for doors; runners of metal for sliding doors; door handles of metal; knobs of metal; door fasteners of metal; door openers of metal, non-electric; fittings of metal for furniture; latch bars of metal; lock bolts.

19 – Building materials, not of metal; door frames, not of metal; armoured doors, not of metal; swing doors, not of metal; accordion doors, not of metal; folding doors, not of metal; doors, not of metal; wood for making household utensils; veneer wood; mouldable wood; жалюзи, not of metal; wood pulp board for building; paperboard for building; buildings, not of metal; buildings, transportable, not of metal; partitions, not of metal; planks of wood for building; wood panelling; wall linings, not of metal, for building; wainscotting, not of metal; lintels, not of metal; sills, not of metal; props, not of metal; furrings of wood; plywood; door panels, not of metal; wood veneers; outdoor blinds, not of metal and not of textile.

20 – Furniture; mirrors [looking glasses]; doors for furniture; chests of drawers; shelves; furniture shelves; metal cabinets [furniture]; covers for clothing [wardrobe]; dowels, not of metal; plugs [dowels], not of metal; furniture casters, not of metal; furniture of metal; office furniture; pulls, not of metal; knobs, not of metal; furniture partitions of wood; freestanding partitions [furniture]; furniture fittings, not of metal; hinges, not of metal; lockers [furniture].

35 – Advertising; business management services; business administration services; office functions; import-export agency services; commercial information agency services; advertising agency services; rental of advertising space; business auditing; demonstration of goods; opinion polling; market studies; providing business information; commercial information and advice for consumers; business investigations; business research; marketing research; layout services for advertising purposes; marketing; business management of performing artists; updating and maintenance of data in computer databases; updating of advertising material; organization of exhibitions for commercial or advertising purposes; organization of exhibitions and trade fairs for commercial or advertising purposes; shop window dressing; provision of an online

marketplace for buyers and sellers of goods and services; presentation of goods on communication media, for retail purposes; auctioneering; sales promotion for others; production of advertising films; rental of sales stands; publication of publicity texts; radio advertising; bill-posting; distribution of samples; dissemination of advertising matter; editing of publicity texts; online advertising on a computer network; advertising by mail order; television advertising; telemarketing services; administration of consumer loyalty programs; administrative processing of purchase orders; modelling for advertising or sales promotion; search engine optimization for sales promotion; price comparison services; procurement services for others [purchasing goods and services for other businesses].

40 – Treatment of materials; metal treating; metal plating; burnishing by abrasion; dyeing services; providing information relating to material treatment.

(260) AM 2023 120213 A

(800) 1693929

(151) 2022 06 20

(891) 2022 06 20

(731) Montblanc-Simplo GmbH

Hellgrundweg 100, 22525 Hamburg,
Germany

(540)

MONTBLANC

(591) Black, white

(531) 27.05.17

(511)

3 – Soaps; perfumery; essential oils; cosmetics.

9 – Optical apparatus and instruments; eyeglasses; sunglasses; eyeglass frames, eyeglass cases; cases and holders adapted for computer and tablets; protective covers and cases for smartphones; accessories for smartphones; laptops and smart tablets; smart phones; 3d spectacles; smart watches; smart headset; smart glasses; digital electronic devices in the form of smart wristbands, bracelets, glasses or rings; headphones and earphones; digital audio players; electronic communication devices and instruments; data processing hardware; computer; computer game software (downloadable); non- fungible tokens using blockchain-based software technology for use online and in virtual environments; downloadable files featuring digital models of watches and watch parts (such as watch bands, watch dials), jewelry, handbags, backpacks, trolleys, purses, wallets, accessories of leather, key-rings, belts, cuff links, spectacles, sunglasses, writing instruments, writing accessories, stationery, perfume bottles, smart electronic devices, in particular for use in product development, product life cycle management, in production and manufacturing (in particular 3D printing), in product data management, in visual effects and visual simulations of all types, in computer games and downloadable applications, in particu-

lar on mobile phones and/or tablets; software for video games.

14 – Jewellery; cuff links; tie clips; rings (jewellery); bracelets (jewellery); earrings; necklaces (jewellery); brooches (jewellery); key rings of precious metal; watches; chronometers; clocks; watch movements; watch straps; watch bracelets; boxes of precious metal for watches and jewellery.

16 – Paper, cardboard; printed matter; stationery; articles of paper or cardboard, namely, boxes, bags, envelopes and pouches for packaging; wrapping paper; writing instruments; pouches for writing instruments; cases for writing instruments; inks; refills for fountain pens and ballpoint pens; pencils; pencil replacement refills; desk sets; pen stands; desk pads; writing books; calendars, colouring books; note books; sketch books; indexes; covers [stationery]; files [office requisites]; announcement cards [stationery]; writing paper; envelopes for office purposes; index cards [stationery]; business cards; writing pads; pens [stationery]; pen nibs; pen holders; writing instrument holders; paperweights; diaries; appointment books; covers for diaries; covers for appointment books; replacement papers for diaries and notebooks and appointment books; inkwells; cheque book holders and covers; passport holders; document file trays; document holders and document portfolios [stationery]; albums; bookends; money clips; writing cases (sets); letter trays; pen trays; letter openers; personal organisers.

18 – Articles made wholly or principally of leather or imitation leather, namely, document cases, briefcase type portfolios, suitcases, briefcases, tie cases, key cases, trolley bags, shoulder straps, backpacks, bags, messenger bags, totes, clutches, wallets, card holders, luggage tags, coin purses, wash bags for carrying toiletries, garment bags for travel made of leather, duffle bags, toiletry bags (sold empty), vanity cases (sold empty).

25 – Clothing; footwear; headgear; articles of clothing namely, belts and gloves.

34 – Cigar cutters; ashtrays for smokers, not of precious metal; lighters for smokers; smokers' articles; cigarette cases and cigarette holders; cigar cases and cigar holders; smoking pipe cleaners; tobacco pouches, tobacco jars not of precious metal.

35 – Online retail store services featuring virtual goods, namely jewelry, cuff links, key rings, watches, leather goods (bags, document cases, suitcases, briefcases, backpacks, trolleys, card holders, tie cases, key cases, wallets, card holders, coin purses), clothing, belts, eyewear, writing instruments, writing accessories, stationery, smartphones, smartwatches, smart headphones, smart tablets, headphones, perfumes, cosmetics; promotion and advertising of virtual goods, digital collectibles and non- fungible tokens; retail store services in the field of luxury goods, namely, jewellery, watches, smartwatches, eyewear, perfumes,

writing instruments, stationery, leather goods, smartphones, smartwatches, smart headphones, smart tablets.

(260) AM 2023 120214 A

(800) 1693953

(151) 2022 09 19

(891) 2022 09 19

(731) Kia Corporation

12, Heolleung-ro, Seocho-gu, Seoul 06797,
Republic of Korea

(540)

Kia

(591) Black, white

(511)

35 – Advertising services; organisation of exhibitions for commercial/promotional and publicity purposes; organization of exhibitions and events for commercial or advertising purposes; marketing; demonstration of goods; sales promotion for others; advertising automobiles for sale by means of the Internet; providing business and marketing information; business management of car parking facilities; providing information via the Internet relating to the sale of automobiles; price comparison services; commercial information agency services; commercial intermediation services; business assistance, management and administrative services; assistance, advisory services and consultancy with regard to business organization; providing commercial information and advice for consumers in the choice of products and services; providing recommendations of goods to consumers for commercial purposes; providing consumer information relating to goods and services; compilation of information into computer databases; import and export agencies; office functions; on-line ordering services; auctioneering; secretarial services; arranging subscriptions to information media; wholesale services featuring automobiles; retail services featuring automobiles; wholesale services featuring parts and accessories of automobiles; retail services featuring parts and accessories of automobiles; wholesale services featuring used automobiles; retail services featuring used automobiles; wholesale store services featuring batteries for vehicles; retail store services featuring batteries for vehicles; online wholesale services featuring downloadable image file; retail services featuring downloadable image file; online retail store services for downloadable image files featuring authenticated by non-fungible tokens [NFTs]; on-line retail store services for downloadable image files featuring character images for metaverse; on-line retail store services for recorded data files; on-line retail store services for recorded data files featuring meta data containing information on digital assets; on-line retail store services for downloadable digital images; online retail store services featuring downloadable digital photos; on-line retail store services for downloadable computer graphics

for mobile phones; on-line retail store services for computer operating system software; on-line retail store services for computer operating software; on-line retail store services for virtual reality software; sales promotion; sales promotion through the provision of avatar-related software; sales promotion through the provision of software for receiving and providing non-fungible tokens [NFTs]; sales promotion through the provision of downloadable image files; sales promotion through the provision of downloadable image files authenticated by non-fungible tokens (NFTs); sales promotion through the provision of downloadable image files featuring virtual reality goods such as virtual reality clothing, virtual reality shoes, virtual reality bags, virtual reality headgear, virtual reality eyewear, virtual reality sporting articles, virtual reality works of art, virtual reality paintings, toys and etc. for metaverse; sales promotion through the provision of downloadable images of automobiles for use in metaverse; sales promotion through the provision of downloadable virtual reality software, namely computer programs for virtual reality; providing an online marketplace for buyers and sellers of goods and services for the metaverse; retail services relating to software for metaverse content; online wholesale services relating to software for metaverse content; online wholesale services relating to interface software for metaverse; online retail services relating to interface software for metaverse.

(260) AM 2023 120215 A

(800) 1693959

(151) 2022 04 03

(891) 2022 04 03

(731) Ivanova Anna Vladislavovna

Komendantsky prospekt, 53, 1, 162,
RU-197350 Saint-Petersburg, Russian
Federation

(540)



BONAFASHION

(591) Pink

(531) 02.09.01; 21.01.16; 29.01.01

(511)

25 – Wimples; bandanas [neckerchiefs]; underwear; sweat-absorbent underwear; berets; overalls; boas [necklets]; teddies [underclothing]; boxer shorts; ankle boots; ski boots; boots for sports; breeches for wear; trousers; football shoes; brassieres; valenki [felted boots]; mittens; collars [clothing]; detachable collars; shirt yokes; veils [clothing]; gabardines [clothing]; galoshes; neckties; ascots; gaiters; spats; leg-gings [leg warmers]; boot uppers; corselets; jerseys [clothing]; waistcoats; sports jerseys; hosiery; heels; heelpieces for footwear; hoods [clothing]; hat frames [skeletons]; pockets for clothing; scarves; caps being headwear; kimonos; cap peaks; visors being headwe-

ar; tights; slippers [underclothing]; combinations [clothing]; wet suits for water-skiing; bodices [lingerie]; corsets [underclothing]; suits; bathing suits; masquerade costumes; beach clothes; headscarves; leotards; jackets [clothing]; stuff jackets [clothing]; fishing vests; leggings [trousers]; liveries; camisoles; sports singlets; cuffs; short-sleeve shirts; mantillas; coats; furs [clothing]; fingerless gloves; mitres [hats]; muffs [clothing]; footmuffs, not electrically heated; bibs, not of paper; bibs, sleeved, not of paper; fur stoles; hairdressing capes; heel protectors for shoes; ear muffs [clothing]; socks; sweat-absorbent socks; footwear; gymnastic shoes; beach shoes; sports shoes; clothing; paper clothing; outerclothing; embroidered clothing; ready-made clothing; motorists' clothing; cyclists' clothing; clothing for gymnastics; clothing of imitations of leather; latex clothing; clothing of leather; waterproof clothing; clothing incorporating LEDs; uniforms; clothing containing slimming substances; fittings of metal for footwear; maniples; overcoats; knickers; parkas; pelerines; gloves [clothing]; ski gloves; pyjamas; bathing trunks; shirt fronts; pocket squares; dresses; headbands [clothing]; garters; sock suspenders; stocking suspenders; ready-made linings [parts of clothing]; dress shields; soles for footwear; braces [suspenders] for clothing; half-boots; lace boots; ponchos; girdles; belts [clothing]; sashes for wear; money belts [clothing]; layettes [clothing]; non-slipping devices for footwear; sweaters; heelpieces for stockings; welts for footwear; chasubles; shirts; wooden shoes; sandals; bath sandals; boots; jumper dresses; saris; sarongs; footwear uppers; inner soles; albs; bath slippers; togas; knitwear [clothing]; underpants; shoes; slippers; skull caps; turbans; headwear; aprons [clothing]; judo uniforms; karate uniforms; tee-shirts; rash guards; dressing gowns; bath robes; top hats; tips for footwear; stockings; sweat-absorbent stockings; shawls; paper hats [clothing]; shower caps; bathing caps; neck tube scarves; studs for football shoes; hats; babies' pants [underwear]; gaiter straps; pelisses; esparto shoes or sandals; skirts; petticoats; skorts.

(260) AM 2023 120217 A
 (800) 1694047
 (151) 2022 08 25
 (891) 2022 08 25
 (731) Swiss Nutrition and Health Foundation (SNHf)
 Route de la Corniche 1, CH-1066 Epalinges,
 Switzerland
 (540)



(591) Black, white
 (531) 06.01.02; 24.03.07; 24.03.15; 24.13.01;
 24.13.25; 27.05.24

(511)
 41 – Teaching and training services in the field of nutrients, micronutrients, phytonutrients and biologically active molecules; education services, namely, providing certification and training in the field of nutrients, micronutrients, phytonutrients and biologically active molecules; electronic publishing services; multimedia publishing activities for electronic publications; publication of printed matter; publication of journals (magazines); publication of newspapers; online publication services for electronic journals; providing electronic publications (not downloadable).

42 – Scientific and technological services; research, analysis and development services with respect to nutrients, micronutrients, phytonutrients and biologically active molecules in the fields of nutrition, cosmetics and health; certification [quality control] services in the fields of nutrition, cosmetics and health; certification [quality control] services concerning the composition of nutrients, micronutrients, phytonutrients and biologically active molecules in the fields of nutrition, cosmetics and health; certification [quality control] services concerning the functionality, bioavailability and bioperformance of nutrients, micronutrients, phytonutrients and biologically active molecules in the fields of nutrition, cosmetics and health; advisory services with respect to quality control in the field of nutrients, micronutrients, phytonutrients and biologically active molecules in the fields of nutrition, cosmetics and health.

(260) AM 2023 120218 A
 (800) 1694053
 (151) 2022 04 04
 (891) 2022 04 04
 (731) Alpen Pharma AG
 Finkenhubelweg 16, CH-3012 Bern,
 Switzerland
 (540)

DANNOSA

(591) Black, white
 (511)
 5 – Pharmaceutical products, medical and veterinary preparations; sanitary products for medical purposes; dietetic food and substances for medical or veterinary use, food for babies; dietary supplements for humans and animals; plasters, materials for dressings; materials for dental fillings and dental impressions; disinfectants; products for destroying vermin; fungicides, herbicides.

(260) AM 2023 120219 A
 (800) 857432
 (151) 2005 04 15
 (891) 2022 10 18
 (731) Z.One Concept SRL
 Via Brodolini 30, I-21046 Malnate (VA), Italy
 (540)

milk_shake

(591) Black, white
 (511)
 3 – Soaps; perfumery, essential oils, cosmetics, hair lotions; dentifrices.

8 – Hand tools and implements (hand-operated); cutlery; side arms; razors.

21 – Household or kitchen utensils and containers (not of precious metal or coated therewith); combs and sponges; brushes (except paint brushes); brush-making materials; articles for cleaning purposes; steelwool; unworked or semi-worked glass (except glass used in building); glassware, porcelain and earthenware not included in other classes.

(260) AM 2023 120220 A
 (800) 1147674
 (151) 2012 10 08
 (891) 2022 10 09
 (731) NDW Draht und Stahl GmbH
 Friedrichstrasse 16, 69412 Eberbach,
 Germany
 (540)



(591) Black, white
 (531) 14.01.24; 26.04.09; 27.05.01
 (511)
 6 – Wire nails, chain-link fences, flooring grid, grids for heating systems, special grids, wire, PE-coated chain-link fence, PE wire, galvanised chain-link fence, steel wire, gabions and other wire products for construction purposes.

35 – Acting as agents in the conclusion of agreements on behalf of third parties for the sale and purchase of wire nails, chain-link fences, flooring grids, grids for heating systems, special grids, wire, PE-coated chain-link fence, PE-wire, galvanised chain-link fence, steel wire, gabions and other products that are used especially in the construction industry; development and implementation of marketing concepts in the form of the negotiation of contracts for others concerning the sale and purchase of third-party products, wholesale and retail services in connection with wire nails, chain-link fences, flooring grids, grids for heating systems, special grids, wire, PE-coated chain-link fence, PE wire, galvanised chain-link fence, steel wire and construction materials made of metal and non-metal

construction materials; advertising and public relations.

(260) AM 2023 120221 A
 (800) 1389366
 (151) 2017 10 31
 (891) 2022 09 30
 (731) Aktsionernoe Obschestvo "Nizhegorodsky Khimiko-Farmatsevtichesky Zavod"
 Salganskaya St., 7, RU-603950 Nizhny Novgorod, Russian Federation
 (540)

АндроДоз

(591) Black, white
 (531) 28.05
 (511)
 5 – Albumin dietary supplements; herbal teas for medicinal purposes; mineral food supplements; nutritional supplements.

(260) AM 2023 120226 A
 (800) 1648186
 (151) 2021 07 09
 (891) 2022 08 03
 (731) The Body Shop International Limited
 Watersmead, Littlehampton, West Sussex
 BN17 6LS, United Kingdom
 (540)

THE BODY SHOP

(591) Black, white
 (511)
 36 – Charitable fundraising services; financial trust management for charitable or philanthropic purposes; provision of foreign aid funding for charitable or philanthropic purposes; provision of foreign aid finance for charitable or philanthropic purposes; charitable or philanthropic funding of scholarships for education, entertainment, sporting or cultural activities; charitable or philanthropic funding of scholarships for economic development, socio-political causes, human rights or legal causes; charitable or philanthropic funding of scholarships for scientific or environmental causes; charitable or philanthropic monetary grants for programs related to education, entertainment, sporting or cultural activities; charitable or philanthropic monetary grants for programs related to economic development, socio-political causes, human rights or legal causes; charitable or philanthropic monetary grants for programs related to scientific or environmental causes; investment trust services for charitable or philanthropic purposes; trust management for charitable or philanthropic purposes; allocation of funds and grants for charitable or philanthropic purposes; funding of scholarships; financial grant services for charitable or philanthropic purposes; provision of grants for charitable or philanthropic purposes; provi-

sion of donations for charitable or philanthropic purposes.

(260) AM 2023 120266 A

(800) 1694125

(151) 2022 08 12

(891) 2022 08 12

(731) Immersive Health Solutions LLC

1209 Orange Street, Wilmington DE 19801,

USA

(540)

REALITY PROCESSOR

(591) Black, white

(511)

9 – Apparatus for recording, transmission or reproduction of sound or images; data processing equipment; data communication apparatus that transmit data and information to databases; smartglasses; optical apparatus and instruments; computer chips; integrated circuits; telecommunication apparatus for mobile networks for the sending, receiving and storing of digital data; computers; computer hardware; computer peripherals; virtual and augmented reality headsets; goggles; glasses; wearable computer hardware; computer peripheral devices; wearable computer peripheral devices, interfaces, controllers, and remote controls for use with computers, computer hardware, telecommunications apparatus and instruments, smartphones, smartwatches, headphones, headsets, media streaming devices, portable media players, cameras, virtual and augmented reality headsets, goggles, glasses, and smartglasses; computer software; software for accessing, browsing and searching downloadable audio and video files, information and commentary available online from databases or the Internet; virtual and augmented reality software.

(260) AM 2023 120267 A

(800) 1694127

(151) 2022 07 01

(891) 2022 07 01

(731) Mutlu Akü Ve Malzemeleri Sanayii Anonim

Şirketi

Tepeören Mah. Eski Ankara, Asfaltı Cad. 210,

Tuzla, İstanbul, Türkiye

(540)



The logo features the word "MUTLU" in a bold, red, sans-serif font. To its right, the word "Classic" is written in a smaller, black, cursive script font.

(591) Black, red, white

(531) 27.05.01; 27.05.02; 27.05.03; 27.05.09;

27.05.10; 27.05.19; 29.01.13

(526) ®

(511)

1 – Chemicals for use in industry, science and photography, as well as in agriculture, horticulture and fo-

restry; unprocessed artificial resins, unprocessed plastics; fire extinguishing and fire prevention compositions; tempering and soldering preparations; substances for tanning animal skins and hides; adhesives for use in industry; putties and other paste fillers; compost, manures, fertilizers; biological preparations for use in industry and science.

2 – Paints, varnishes, lacquers; preservatives against rust and against deterioration of wood; thinners for paints; colorants, dyes; inks for printing, marking and engraving; raw natural resins; metals in foil and powder form for use in painting, decorating, printing and art.

9 – Scientific, research, navigation, surveying, photographic, cinematographic, audiovisual, optical, weighing, measuring, signalling, detecting, testing, inspecting, life-saving and teaching apparatus and instruments; apparatus and instruments for conducting, switching, transforming, accumulating, regulating or controlling the distribution or use of electricity; electric plugs; junction boxes [electricity]; electric switches; circuit breakers; fuses; lighting ballasts; battery starter cables; electrical circuit boards; electric resistances; electric sockets; transformers [electricity]; electrical adapters; battery chargers; electric door bells; electric cables; electronic cables; batteries; accumulators, electric; accumulators, electric, for vehicles; accumulator boxes; accumulator jars; battery leads; solar panels for production of electricity; apparatus and instruments for recording, transmitting, reproducing or processing sound, images or data; recorded and downloadable media, computer software, blank digital or analogue recording and storage media; mechanisms for coin-operated apparatus; cash registers; calculating devices; computers and computer peripheral devices; diving suits, divers' masks, ear plugs for divers, nose clips for divers and swimmers, gloves for divers, breathing apparatus for underwater swimming; fire-extinguishing apparatus; eyeglasses; sunglasses; optical lenses; eyeglass cases; containers for contact lenses; radar apparatus; sonars; decorative magnets; metronomes.

35 – Advertising, marketing and publicity services; organization of exhibitions and trade fairs for commercial or advertising purposes; development of advertising concepts; provision of an online marketplace for buyers and sellers of goods and services; office functions; secretarial services; arranging newspaper subscriptions for others; compilation of statistics; rental of office machines; systemization of information into computer databases; telephone answering for unavailable subscribers; business management; business management and organization consultancy; accounting; commercial consultancy services; personnel recruitment; personnel placement; employment agencies; import-export agencies; temporary personnel placement services; auctioneering; the bringing together, for the benefit of others, of a variety of goods, name-

ly, chemicals for use in industry, science and photography, as well as in agriculture, horticulture and forestry, unprocessed artificial resins, unprocessed plastics, fire extinguishing and fire prevention compositions, tempering and soldering preparations, substances for tanning animal skins and hides, adhesives for use in industry, putties and other paste fillers, compost, manures, fertilizers, biological preparations for use in industry and science, paints, varnishes, lacquers, preservatives against rust and against deterioration of wood, thinners for paints, colorants, dyes, inks for printing, marking and engraving, raw natural resins, metals in foil and powder form for use in painting, decorating, printing and art, common metals and their alloys, ores, metal materials for building and construction, transportable buildings of metal, non-electric cables and wires of common metal, small items of metal hardware, metal containers for storage or transport, safes, scientific, research, navigation, surveying, photographic, cinematographic, audiovisual, optical, weighing, measuring, signalling, detecting, testing, inspecting, life-saving and teaching apparatus and instruments, apparatus and instruments for conducting, switching, transforming, accumulating, regulating or controlling the distribution or use of electricity, electric plugs, junction boxes [electricity], electric switches, circuit breakers, fuses, lighting ballasts, battery starter cables, electrical circuit boards, electric resistances, electric sockets, transformers [electricity], electrical adapters, battery chargers, electric door bells, electric cables, electronic cables, batteries, accumulators, electric, accumulators, electric, for vehicles, accumulator boxes, accumulator jars, battery leads, solar panels for production of electricity, apparatus and instruments for recording, transmitting, reproducing or processing sound, images or data, recorded and downloadable media, computer software, blank digital or analogue recording and storage media, mechanisms for coin-operated apparatus, cash registers, calculating devices, computers and computer peripheral devices, diving suits, divers' masks, ear plugs for divers, nose clips for divers and swimmers, gloves for divers, breathing apparatus for underwater swimming, fire-extinguishing apparatus, eyeglasses, sunglasses, optical lenses, eyeglass cases, containers for contact lenses, radar apparatus, sonars, decorative magnets, metronomes, vehicles, apparatus for locomotion by land, air or water, paper and cardboard, printed matter, bookbinding material, photographs, stationery and office requisites, except furniture, adhesives for stationery or household purposes, drawing materials and materials for artists, paintbrushes, instructional and teaching materials, plastic sheets, films and bags for wrapping and packaging, printers' type, printing blocks, unprocessed and semi-processed rubber, gutta-percha, gum, asbestos, mica and substitutes for all these materials, plastics and resins in extruded form for use in manufacture, packing, stopping and insulating materials, flexible pipes, tubes and hoses, not of metal, enabling

customers to conveniently view and purchase those goods, such services may be provided by retail stores, wholesale outlets, by means of electronic media or through mail order catalogues.

(260) AM 2023 120273 A

(800) 1694235

(151) 2022 06 20

(891) 2022 06 20

(731) Condor Flugdienst GmbH

An der Gehespitz 50, 63263 Neu-Isenburg,
Germany

(540)

condor

(591) Black, white

(531) 27.05.01; 27.05.17

(511)

9 – Information technology and audio-visual, multimedia and photographic devices; ticket printers; ticket dispensers; ticket canceling machines; electronic ticket examination machines.

16 – Paper and cardboard; bags and articles for packaging, wrapping and storage of paper, cardboard or plastics; printed tickets; travel magazines; tickets.

35 – Advertising, marketing and promotional services; business assistance, management and administrative services; assessment analysis relating to business management; organization, operation and supervision of sales and promotional incentive schemes; administration of frequent flyer programs; price comparing services; organisation, operation and supervision of loyalty schemes and incentive schemes.

38 – Telecommunication services; internet based telecommunication services; aeronautical telecommunication services; electronic transmission of news; providing access to databases in computer networks.

39 – Transport; transport information, advice and reservation services; rental services related to transportation and storage; vehicle parking and storage; airplane rental; aircraft parking; airline services; travel and passenger transportation; travel information; arranging airline tickets, cruise tickets and train tickets; airport check-in services; transportation check-in services; provision of transportation tariff information; providing flight arrival and departure information.

43 – Temporary accommodation; provision of food and drink; temporary accommodation information, advice and reservation services; information, advice and reservation services for the provision of food and drink; providing travel lodging information services and travel lodging booking agency services for travelers.

(260) AM 2023 120274 A
 (800) 1694236
 (151) 2022 06 20
 (891) 2022 06 20
 (731) Condor Flugdienst GmbH
 An der Gehespitz 50, 63263 Neu-Isenburg,
 Germany
 (540)



(591) Black, white
 (531) 03.07.16; 03.07.24; 26.01.03; 26.01.16;
 26.13.25

(511)
 9 – Recorded content; information technology and audio-visual, multimedia and photographic devices; downloadable electronic brochures; ticket printers; ticket dispensers; ticket canceling machines; electronic ticket examination machines; electronic magazines; downloadable electronic publications in the nature of magazines.

16 – Printed matter; paper and cardboard; bags and articles for packaging, wrapping and storage of paper, cardboard or plastics; printed tickets; tickets; pamphlets; travel magazines; magazines [periodicals]; flyers; banners of paper; posters.

35 – Advertising, marketing and promotional services; business assistance, management and administrative services; assessment analysis relating to business management; organization, operation and supervision of sales and promotional incentive schemes; administration of frequent flyer programs; price comparing services; organisation, operation and supervision of loyalty schemes and incentive schemes.

38 – Telecommunication services; internet based telecommunication services; aeronautical telecommunication services; electronic transmission of news; providing access to databases in computer networks.

39 – Transport; transport information, advice and reservation services; rental services related to transportation and storage; vehicle parking and storage; airplane rental; aircraft parking; airline services; travel and passenger transportation; travel information; arranging airline tickets, cruise tickets and train tickets; airport check-in services; transportation check-in services; provision of transportation tariff information; providing flight arrival and departure information.

43 – Temporary accommodation; provision of food and drink; temporary accommodation information, advice and reservation services; information, advice and reservation services for the provision of food and drink; providing travel lodging information services

and travel lodging booking agency services for travelers.

(260) AM 2023 120275 A
 (800) 1694302
 (151) 2022 09 05
 (891) 2022 09 05
 (731) Saint-Gobain Cultilene, BV
 Ericssonstraat 2, NL-5121 ML Rijen,
 Netherlands
 (540)

CULTILENE

(591) Black, white
 (511)

1 – Growing media, fertilizers and chemicals for use in agriculture, horticulture and forestry; substrates for soil-free growing [agriculture]; yield promoters for produce from soil-free growing agriculture; substrates, in particular substrates in the form of boards, cubes, slabs, felts, mats, plugs, wool in bulk, pads, all for use in the culture of plants, the production of vegetables, fruits, flowers and the germination of seeds; growing media consisting of mineral fibres in the form of boards, cubes, slabs, felts, mats, plugs, wool in bulk, pads, all for use in the culture of plants, the production of vegetables, fruits, flowers and the germination of seeds; growing media consisting of mineral wool, rock wool and mineral fibres in the form of boards, cubes, slabs, felts, mats, plugs, wool in bulk, pads, all for use in the culture of plants, the production of vegetables, fruits, flowers and the germination of seeds.

(260) AM 2023 120277 A
 (800) 1694363
 (151) 2022 07 11
 (891) 2022 07 11
 (731) Euro Games Technology Ltd.
 4, "Maritsa" Str., "Vranya-Lozen-Triugulnika",
 BG-1151 Sofia, Bulgaria

(540)



(591) Blue, red, yellow, white, green, black, orange and cyan

(531) 01.01.05; 01.15.09; 27.05.01; 27.05.02;
 27.05.03; 27.05.09; 27.05.10; 27.07.01;
 27.07.02; 27.07.03; 29.01.15

(511)
 9 – Software; computer gaming software; computer software packages; computer operating system software; computer software, recorded; software drivers; virtual reality software; games software; entertainment software for computer games; computer programs for network management; operating computer software for main frame computers; monitors (computer hardware); computer hardware; apparatus for re-

ording images; monitors (computer programs); computer game programs; computer programs for recorded games; apparatus for recording, transmission or reproduction of sound or images; communications servers [computer hardware]; electronic components for gambling machines; computer application software featuring games and gaming; computer software for the administration of on-line games and gaming; computer hardware for games and gaming; hardware and software for gambling, gambling machines, gambling games on the Internet and via telecommunication network.

28 – Gaming machines for gambling; chips for gambling; mah-jong; arcade games; gambling machines operating with coins, notes and cards; games; electronic games; parlor games; gaming chips; gaming tables; slot machines [gaming machines]; LCD game machines; slot machines and gaming devices; coin-operated amusement machines; roulette chips; poker chips; chips and dice [gaming equipment]; gaming equipment for casinos; roulette tables; gaming roulette wheels; casino games; gambling machines and amusement machines, automatic and coin-operated; coin-operated amusement machines and/or electronic coin-operated amusement machines with or without the possibility of gain; boxes for coin-operated machines, slot machines and gaming machines; electronic or electrotechnical amusement machines and apparatus, gaming machines, coin-operated entertainment machines; housings for coin-operated machines, gaming equipment, gaming machines, machines for gambling; electropneumatic and electrical gambling machines (slot machines).

41 – Gambling; entertainment services related to gambling; gaming services for entertainment purposes; casino, gaming and gambling services; training in the development of software systems; provision of gaming equipment for gambling halls; providing casino equipment [gambling]; gaming machine entertainment services; providing casino facilities [gambling]; gaming hall services; amusement arcade services; games equipment rental; rental of gaming machines; providing amusement arcade services; rental of gaming machines with images of fruits; editing or recording of sounds and images; sound recording and video entertainment services; hire of sound reproducing apparatus; provision of gaming equipment for casinos; providing of casino facilities; online gambling services; casino, gaming and gambling services; provision of gaming facilities, gaming hall facilities, Internet casinos and online gambling services.

(260) AM 2023 120279 A
 (800) 1694469
 (151) 2022 10 05
 (891) 2022 10 05
 (731) Wolt Enterprises Oy
 Arkadiankatu 6, FI-00100 Helsinki, Finland

(540)



(591) Blue, white
 (531) 26.01.03; 26.01.20; 26.01.24; 27.05.01;
 27.05.24; 29.01.12

(511)
 9 – Sunglasses; computer peripheral devices; mouse pads; chargers; power banks; loudspeakers; headphones; sleeves for laptops; cell phone covers; decorative magnets; mobile phone holders; helmets for bicycles; helmets for motorcyclists.

16 – Planners [printed matter]; albums; photographic albums; albums for stickers; almanacs; bookmarks; comic books; covers [stationery]; drawing materials; composition books; drawing pens; drawing rulers; drawing sets; folders [stationery]; paper folders; money holders; bond paper; writing tablets; envelopes [stationery]; writing stationery; loose-leaf binders; data books; address books; trading cards; posters; post-cards; printed calendars; occasion cards; colouring books; stickers [stationery]; pens; pencils; rubber erasers; pencil boxes; pencil sets; pencil sharpeners; pencil holders; school supplies [stationery]; table napkins of paper; table linen of paper; tablecloths of paper; writing sets; writing materials.

18 – Trunks and suitcases; umbrellas and parasols; rucksacks; school bags; weekend bags; duffel bags; bags for campers; beach bags; briefcases [leather goods]; pocket wallets; key cases; credit card cases [wallets]; attaché cases; bags; courier bags.

21 – Tableware, cookware and containers; mugs; dishes; thermal insulated bags for food or beverages; insulating flasks.

25 – Clothing; footwear; headgear; gloves [clothing]; coats; outerclothing.

35 – Wholesale and retail services relating to the following goods: sunglasses, computer peripheral devices, mouse pads, chargers, power banks, loudspeakers, headphones, sleeves for laptops, cell phone covers, decorative magnets, mobile phone holders, helmets for bicycles, helmets for motorcyclists; wholesale and retail services relating to the following goods: planners [printed matter], albums, photographic albums, albums for stickers, almanacs, bookmarks, comic books, covers [stationery], drawing materials, composition books, drawing pens, drawing rulers, drawing sets, folders [stationery], paper folders, money holders, bond paper, writing tablets, envelopes [stationery], writing stationery, loose-leaf binders, data books, address books; wholesale and retail ser-

vices relating to the following goods: trading cards, posters, postcards, printed calendars, occasion cards, colouring books, stickers [stationery], pens, pencils, rubber erasers, pencil boxes, pencil sets, pencil sharpeners, pencil holders, school supplies [stationery], table napkins of paper, table linen of paper, tablecloths of paper, writing sets, writing materials, albums for stickers; wholesale and retail services relating to the following goods: trunks and suitcases, umbrellas and parasols, rucksacks, school bags, weekend bags, duffel bags, bags for campers, beach bags, briefcases [leather goods], pocket wallets, key cases, credit card cases [wallets], attaché cases, bags, courier bags; wholesale and retail services relating to the following goods: tableware, cookware and containers, mugs, dishes, thermal insulated bags for food or beverages, insulating flasks; wholesale and retail services relating to the following goods: clothing, footwear, headgear, gloves [clothing], coats, outerclothing.

(260) AM 2023 120280 A
 (800) 1694473
 (151) 2022 10 10
 (891) 2022 10 10
 (731) Dream Marriage Group Inc.
 9701 Wilshire Boulevard, 10th Floor,
 Beverly Hills CA 90212, USA

(540)
DREAM SINGLES

(591) Black, white
 (526) SINGLES
 (511)
 45 – Dating services; matchmaking services; Internet-based dating services.

(260) AM 2023 120281 A
 (800) 1694523
 (151) 2022 10 07
 (891) 2022 10 07
 (731) Renault S.A.S.
 122-122 bis avenue du Général Leclerc,
 F-92100 Boulogne-Billancourt, France

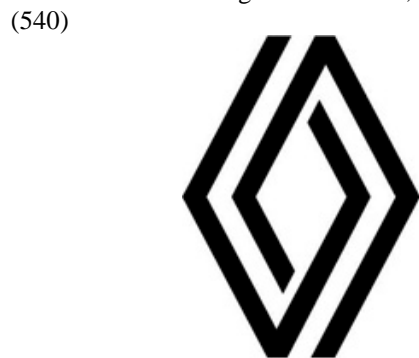

(591) Black, white
 (531) 24.11.18; 26.05.01

(511)
 12 – Vehicles, apparatus for locomotion by land, automobiles, their components, namely suspension shock absorbers for vehicles; shock absorbers for automobiles; headrests for vehicle seats; transmission shafts for land vehicles; gear boxes for land vehicles; hoods for vehicles; automobile hoods; hoods for vehicle engines; automobile bodies; safety belts for vehicle seats; automobile chassis; hydraulic circuits for vehicles; air bags [safety devices for automobiles]; brake disks for vehicles; clutches for land vehicles; hub caps; windshield wipers; vehicle brakes; vehicle wheel rims; vehicle running boards; motors and engines for land vehicles; windshields; bumpers for automobiles; tires; luggage carriers for vehicles; doors for vehicles; vehicle wheels; rearview mirrors; vehicle seats; windows for vehicles; steering wheels for vehicles; fitted vehicle covers.

(260) AM 2023 120285 A
 (800) 1694638
 (151) 2022 06 14
 (891) 2022 06 14
 (731) Egis Gyógyszergyár Zrt.
 Keresztúri út 30-38., H-1106 Budapest,
 Hungary

(540)
ЭРИСОЛЮТ

(591) Black, white
 (531) 28.05
 (511)
 3 – Cosmetics and cosmetic preparations.

5 – Pharmaceutical preparations for human use in the field of dermatology; dietary supplements; medicinal ointments; medicated skin creams.

(260) AM 2023 120286 A
 (800) 1694643
 (151) 2022 10 12
 (891) 2022 10 12
 (731) China Railway Siyuan Survey And Design Group Co., LTD.
 No. 745, Heping Avenue, Wuchang District,
 Wuhan City, 437300 Hubei Province, China

(540)
crfsdi

(591) Black, white
 (531) 27.05.01
 (511)
 6 – Telegraph posts of metal; posts of metal for power lines; galvanized steel sheets; cable thimbles of metal; anchorage devices of metal; roofing of metal, incorporating photovoltaic cells; railway material of metal; railway points.

9 – Computer software applications, downloadable; surveying apparatus and instruments; cables, electric; distribution boxes [electricity]; alarms; charging stations for electric vehicles; downloadable smart phone application [software]; teaching robots.

35 – Import-export agency services; sales promotion for others; procurement services for others [purchasing goods and services for other businesses]; marketing; invoicing; advertising; price quotations for goods or services; business management consultancy; systemization of information into computer databases; personnel management consultancy.

37 – Construction consultancy; construction; electric appliance installation and repair; machinery installation, maintenance and repair; building construction supervision; providing construction information; installation and maintenance of illuminating apparatus; vehicle breakdown repair services; drilling of wells; upholstery.

42 – Technological research; conducting technical project studies; research and development of new products for others; engineering drawing; quality testing; rental of computer software; information technology [IT] consultancy; scientific research; software as a service [SaaS]; electronic data storage.

(260) AM 2023 120287 A
 (800) 1694646
 (151) 2022 08 11
 (891) 2022 08 11
 (731) Aktsionernoe Obshchestvo "Nizhegorodsky Khimiko-Farmatsevtichesky Zavod"
 Salganskaya St., 7, RU-603950 Nizhny Novgorod, Russian Federation

(540)
УРИНАЛГИН

(591) Black, white
 (531) 28.05
 (511)

5 – Disinfectants; preparations for destroying noxious animals; herbicides; acaricides; aconitine; algicides; bracelets impregnated with insect repellent; fly catching paper; mothproofing paper; nutritive substances for microorganisms; deodorizers for litter trays; air deodorizing preparations; deodorants, other than for human beings or for animals; deodorants for clothing and textiles; insecticides; carbolineum [parasiticide]; cedar wood for use as an insect repellent; powdered milk for babies; fly glue; pesticides; food for babies; vermin destroying preparations; herbicides; preparations for destroying dry rot fungus; larvae exterminating preparations; fly destroying preparations; preparations for destroying mice; slug exterminating preparations; chemical preparations for treating diseases affecting vine plants; chemical preparations for treating mildew; chemical preparations for treating phylloxera;

mothproofing preparations; insect repellents; insect repellent incense; repellents for dogs; fumigating sticks; infant formula; semen for artificial insemination; rat poison; poisons; bacterial poisons.

(260) AM 2023 120288 A
 (800) 1694683
 (151) 2022 04 28
 (891) 2022 04 28
 (731) TikTok Information Technologies UK Limited
 6th Floor, One London Wall, London EC2Y 5EB, United Kingdom

(540)
TikTok

(591) Black, white
 (511)
 2 – Dye, printing ink; pigments; tattooing ink; paints; anti-rust preparations for preservation; raw natural resins; varnishes; colorants for foodstuffs and beverages; colorants; tattoo colorants; colorants for textiles and leather; gum resins; preservatives; powder paints; paint blocks; paint thinner; paint primers; watercolor paints; artists' paints; fabric paints; spray paint; car paints.

4 – Candles; dust removing preparations; perfumed candles; tallow candles; floating candles; church candles; scented candles; nightlights [candles]; wicks for candles; aromatherapy fragrance candles; christmas tree candles; candles in tins; dust suppressants; dust absorbing compositions; dust binding compositions; light oils; textile oils; engine oils; motor oils; industrial oils; lubricating oils.

5 – Medical nutrition food; sterilising preparations; depuratives; diapers for pets; contact lens solutions; sanitary preparations for personal hygiene; diapers for babies; incontinence diapers; diaper liners; disposable diapers; paper diapers; babies' swim diapers; adult diapers; disposable training pants [diapers]; deodorants, other than for human beings or for animals; medicated shampoos, soaps, lotions and dentifrices; dietary supplements; meal replacements and dietetic food and beverages adapted for medical or veterinary use; nutritional supplements; liquid nutritional supplements; dietetic and nutritional preparations; nutritional supplement energy bars; nutritional supplements for livestock feed; nutritional supplements for veterinary use; nutritional drink mix for use as a meal replacement; medicated diaper rash ointment; diaper changing mats, disposable, for babies; sanitary wear; sanitary towels; sanitary tampons; sanitary preparations and articles; sanitary preparations for medical use; sanitary preparations for veterinary use; multivitamin preparations; herbal supplements; probiotic supplements; disinfectants for sanitary use; antiseptic preparations; medicated shampoos for pets; antibacterial soap; medicated and sanitising soaps and detergents;

hand lotion (medicated); medicated hair lotions; skin care lotions (medicated); lotions for veterinary purposes; antibacterial gels; hand-sanitising preparations; sexual stimulant gels; lubricant gels for personal use; massage gels for medical purposes; air deodoriser gels; diet capsules; food for medically restricted diets.

7 – Industrial printing machines, industrial washing machines and industrial cleaning machines; hand-held tools, other than hand-operated; distribution machines, automatic; automatic vending machines; shoe polishers, electric; washing machines [laundry]; knitting machines; painting machines; sewing machines; photocomposing machines; gumball machines; labellers [machines]; gardening tools (electric); tools for machines; car washing machines; floor washing machines; domestic washing machines; refrigerated vending machines; dispensing machines [other than vending machines]; 3D printers; industrial robots; robotic lawnmowers; robotic cleaning machines.

12 – Cars; carts; bicycles; air pumps [vehicle accessories]; wheelchairs; repair outfits for inner tubes; autonomous cars; racing cars; robotic cars; car sun blinds; car seat covers; car seat harnesses; children's car seats; vehicle booster seats for children; car seat tidies; car seat canopies; car theft alarms; car-top luggage carriers; head-rests for car seats; motorbikes; bicycle seats; tricycles; prams; harnesses for prams; aprons for prams; fitted footmuffs for prams; vehicle safety restraints for use with pram bodies; pushchairs; strollers; pushchair covers; fitted footmuffs for pushchairs; bags adapted for pushchairs; pushchairs for pets; fitted pushchair mosquito nets.

15 – Brass instruments; musical instruments; keyboard instruments; string instruments; woodwind instruments; percussion instruments; wind instruments; musical boxes; musical instrument cases; musical instrument stands; drums; electrical musical instruments; music synthesizers; musical instrument straps.

34 – Tobacco and cigarettes; matches; lighters for smokers; cigarette filters; electronic cigarettes; cigarette holders; cigarette cutters; cigarette papers; cigarette cases, boxes and pouches; cigarette tips; menthol cigarettes; liquids for electronic cigarettes; personal vaporisers and electronic cigarettes, and flavourings and solutions therefor; cigars; cigarillos; cigarette lighters; lighter flints; wicks for lighters; matches; match boxes and holders of precious metal.

40 – Food processing services; custom assembling of materials for others; pottery firing; custom tailoring; processing of cinematographic films; framing of works of art; paper finishing; metal treating; printing, and photographic and cinematographic development; cloth treating; treating of textiles; paper treating; photo finishing; print finishing services; film developing.

44 – Medical clinic services; nutrition consultation; animal grooming; gardening; opticians' services; rental of sanitation facilities; beauty salon services; den-

tal clinic services; homeopathic clinical services; cosmetic and plastic surgery clinic services; medical treatment services; medical clinic day care services for sick children; nutrition counselling; veterinary services; landscape gardening services; garden maintenance; advisory services relating to the design of gardens; beauty treatment; beauty consultancy; beauty spa services; hygienic and beauty care; facial beauty treatment services; pet beauty salon services; hairdressing services; nail salon services; health counselling; beauty counselling; dietetic counselling services [medical]; lifestyle counselling and consultancy for medical purposes; psychological counselling; herbalism; massage services.

(260) AM 2023 120289 A

(800) 1694732

(151) 2022 10 04

(891) 2022 10 04

(731) Systeme Electric Joint Stock Company

ul. Dvintsev, d.12, k.1, etazh 6, pom I kom

15, RU-127018 Moscow, Russian Federation

(540)

Uniprom

(591) Black, white

(511)

9 – Batteries, electric; accumulators, electric; uninterruptible electrical power supplies and reserve electrical power supply apparatus other than generators; uninterruptible AC/DC power supplies for electrical and electronic apparatus and machines, for alarm systems, for control and observation instruments, for communication systems; voltage stabilizers; voltage surge protectors; electrical charge controllers; electronic power controllers; voltage and power regulators; induction voltage regulators; light dimmers [regulators], electric; electrical signal attenuators; electric current converters; voltage regulators, automatic; inverters [electricity]; voltage surge suppressors; electrical power supplies, namely accumulators, electric, including electrical power supplies with automatic transfer switch.

(260) AM 2023 120291 A

(800) 1694832

(151) 2022 09 29

(891) 2022 09 29

(731) Joint Stock Company "Fats And Oil

Integrated Works"

Ul. Titova 27, Ekaterinburg, RU-620085

Sverdlovskaya Oblast, Russian Federation

(540)



(591) White, red, blue, light-blue, dark-blue, yellow, dark-yellow, green, lightgreen, dark-green, beige, pink, brown, dark-brown

(531) 01.15.21; 02.03.11; 05.09.15; 05.09.22; 08.07.07; 08.07.11; 25.01.25; 28.05; 29.01.15

(511)

30 – Mayonnaise; mayonnaise sauce.

(260) AM 2023 120292 A

(800) 1694929

(151) 2022 05 16

(891) 2022 05 16

(731) Osorio Consultores SSW SAS
Calle 75 72 B 55 AP 405, 0000 Medellin,
Antioquia, Colombia

(540)



(591) Pantone 2715 C and Pantone 2765 C

(531) 26.05.01; 26.05.16; 26.11.13; 27.05.01; 29.01.13

(511)

36 – Leasing of skin care equipment; leasing of livestock; leasing of computer installations; leasing of computers; leasing of user-programmable robots; leasing of land; leasing of land vehicles; financial advice; financial advice regarding franchising; income tax financial advice; financial advice relating to tax planning; advice regarding financial risk management; acquisition of financial capital; trading of financial instruments, securities, shares, options and other derivative products; clearing and execution of financial securities trading; consultancy relating to financial risk management; consultancy regarding financial loans; financial consultancy and analysis; financial consultancy and advice; brokerage of financial derivatives; online brokerage of trading and transactions relating to foreign currencies and other financial products; finance brokerage; preparation of financial reports; preparation of financial reports relating to the financing of construction projects; preparation of financial reports relating to construction projects; pre-

paration of financial and insurance reports; preparation and analysis of financial reports; financial risk assessment; trusteeship of financial futures contracts; financial guarantee services for high net worth individuals and private investors; financial guarantee services for ultra high net worth individuals and private investors; financial asset management; management of financial assets, investments and real estate; financial trust management; financial fund management; financial business management; financial risk management; financial management of financial assets; financial information, management and analysis; financial exchange; monetary and financial affairs; operations involving financial derivatives; trading of financial instruments; trading of financial instruments and commodities; financial sponsorship; financial sponsorship of recreational activities; financial sponsorship of recreational, sporting and cultural activities; financial sponsorship of equestrian competitions; financial sponsorship of dance performances; financial sponsorship of theatrical performances; financial sponsorship of cultural events; financial sponsorship of visual arts events; financial sponsorship of social, charitable and religious organizations; financial sponsorship and funding of films; financial sponsorship and funding of radio programs; financial sponsorship and funding of television programs; financial sponsorship and patronage; providing financial advisory services; providing financial loan services for third parties; provision and financial advisory services; banking and financial services; banking, financial and insurance services; stock exchange services regarding financial securities; financial analysis and information services; financial advisory services; financial advisory services relating to insurance contracts; financial advisory services relating to insolvency; financial advisory services relating to business acquisitions and mergers; financial advisory services relating to taxation; financial advisory services relating to joint ventures; strategic financial advisory services; strategic financial advisory services to companies; financial advisory services relating to securities, derivatives and other financial products; financial advisory services regarding credit; advisory services relating to financial asset management; consultancy services regarding financial retirement plans; consultancy and financial advisory services; consultancy and financial advisory services relating to microcredit; consultancy and financial advisory services regarding microfinance; brokerage services regarding financial derivatives; financial brokerage services; financial brokerage services relating to customs clearance services; financial credit services for exporters; services for holding financial securities in escrow; customs clearance services being financial brokerage services; financial trust management services; financial management and brokerage services relating to securities, futures, shares, bonds and other securities; financial management, analysis and information services; financial informati-

on services relating to financial securities markets; financial information and advisory services; financial reports and credit ratings services; financial exchange services; financial investment and advisory services; financial research and analysis services; financial trust planning services; financial loan services; financial credit scoring services; discount card services [financial services]; financial asset verification services; online trading services for financial instruments, shares, options and other derivative products; financial services; customs agency financial services; customs agency financial services relating to customs clearance; financial customs brokerage services; financial customs brokerage services relating to customs clearance; financial clearing house services; financial fund guarantee services; financial management and investment services relating to shares; financial management and investment services relating to net corporate assets; financial management and investment services relating to securities; financial management and investment services related to securities; financial services in the field of monetary loans; financial services relating to pre-payment for goods and services; financial services relating to tax planning; computerized financial services; financial services for the purchase of electronic savings bonds; financial services provided via the Internet; financial services provided via the Internet and by telephone; financial services provided by electronic means; financial services provided by telephone; financial services relating to trading, advice, management and dealing in financial derivatives; financial services relating to the guarantee of funds; financial services relating to wealth management; financial services relating to debt settlement; financial services relating to pensions; financial services related to credit cards; financial services relating to payment cards; financial services relating to pension plans; financial services relating to loans; financial services relating to investment securities; financial services relating to the provision and structuring of capital; financial services and related consultancy; financial and insurance services; financial, investment and insurance services; financial, monetary and banking services; providing information online regarding financial, banking, insurance and investment services; providing financial information relating to the financial sector involved in investments focused on the environment; providing financial information relating to the financial sector associated with environmental-oriented investment; providing information via electronic means in the financial and investment fields; providing information regarding trusteeship of financial futures contracts; providing information regarding trust administration of financial futures contracts; financial evaluation and analysis.

(260) AM 2023 120293 A
 (800) 1694992
 (151) 2022 07 25
 (891) 2022 07 25
 (731) Türkiye Turizm Tanitim Ve Gelistirme Ajansi
 Esentepe Mahallesi, Büyükdere Caddesi,
 Astoria 127 B/71, Şişli, İstanbul, Türkiye

(540)

 where business is pleasure

(591) Red, grey and black
 (531) 27.05.09; 29.01.13
 (511)
 35 – Advertising, marketing and public relations; organization of exhibitions and trade fairs for commercial or advertising purposes; development of advertising concepts; provision of an online marketplace for buyers and sellers of goods and services.

41 – Arranging and conducting of conferences, congresses and seminars; sporting and cultural activities; entertainment; ticket reservation and booking services for entertainment, sporting and cultural events, including ticket reservation and booking services for theatres, cinemas, museums and concerts; publication and editing of printed matter, including magazines, books, newspapers, other than publicity texts; electronic publication services.

(260) AM 2023 120294 A
 (800) 1695000
 (151) 2022 09 29
 (891) 2022 09 29
 (731) Fertiberia, S.A.
 Calle Agustín de Foxá, 27, Plantas 8-11,
 E-28036 Madrid, Spain

(540)
IMPACT ZERO BY FERTIBERIA

(591) Black, white
 (511)
 1 – Chemicals for use in industry, science and photography, as well as in agriculture, horticulture and forestry; unprocessed artificial resins, unprocessed plastics; fire extinguishing and fire prevention compositions; tempering and soldering preparations; substances for tanning animal skins and hides; adhesives for use in industry; putties and other paste fillers; compost, manures, fertilizers; biological preparations for use in industry and science.

5 – Pharmaceuticals, medical and veterinary preparations; sanitary preparations for medical purposes; dietetic food and substances adapted for medical or veterinary use, food for babies; dietary supplements for human beings and animals; plasters, materials for dressings; material for stopping teeth, dental wax;

disinfectants; preparations for destroying vermin; fungicides, herbicides.

(260) AM 2023 120310 A

(800) 1695294

(151) 2022 07 08

(891) 2022 07 08

(731) Stropus Ltd.

7-9 Riga Fereou, Lizantia Court, office 310,
Agioi Omologites, CY-1087 Nicosia, Cyprus

(540)



(591) White and blue

(531) 21.03.01; 27.05.01; 29.01.04

(511)

41 – Videotaping for tournaments, competitions, game shows, events in the field of gambling, betting, wagering, lotteries, casinos, card games, educational games, games, where the result depends on mastery, skill of the player and other games of chance; booking of seats for shows; sound engineering services for tournaments, competitions, game shows, events in the field of gambling, betting, wagering, lotteries, casinos, card games, educational games, games, where the result depends on mastery, skill of the player and other games of chance; organization of tournaments, competitions, game shows, events in the field of gambling, betting, wagering, lotteries, casinos, card games, educational games, games, where the result depends on mastery, skill of the player and other games of chance; party planning as entertainment; video editing services for tournaments, competitions, game shows, events in the field of gambling, betting, wagering, lotteries, casinos, card games, educational games, games, where the result depends on mastery, skill of the player and other games of chance; lighting technician services for tournaments, competitions, game shows, events in the field of gambling, betting, wagering, lotteries, casinos, card games, educational games, games, where the result depends on mastery, skill of the player and other games of chance; music composition services for tournaments, competitions, game shows, events in the field of gambling, betting, wagering, lotteries, casinos, card games, educational games, games, where the result depends on mastery, skill of the player and other games of chance; film directing, other than advertising films, in the field of gambling, betting, wagering, lotteries, casinos, card games, educational games, games, where the result depends on mastery, skill of the player and other games of chance, including for providing access to the related content; production of tournaments, competitions, game shows, events in the field of gambling, betting, wagering, lotteries, casinos, card games, educational games, games, where the result depends on mastery, skill of the player and other games of chance;

ce; film production, other than advertising films, in the field of gambling, betting, wagering, lotteries, casinos, card games, educational games, games, where the result depends on mastery, skill of the player and other games of chance, including for providing access to the related content; scriptwriting, other than for advertising purposes, for arranging tournaments, competitions, game shows, events in the field of gambling, betting, wagering, lotteries, casinos, card games, educational games, games, where the result depends on mastery, skill of the player and other games of chance; presentation of live performances for tournaments, competitions, game shows, events in the field of gambling, betting, wagering, lotteries, casinos, card games, educational games, games, where the result depends on mastery, skill of the player and other games of chance; rental of audio equipment for tournaments, competitions, game shows, events in the field of gambling, betting, wagering, lotteries, casinos, card games, educational games, games, where the result depends on mastery, skill of the player and other games of chance; rental of show scenery for tournaments, competitions, game shows, events in the field of gambling, betting, wagering, lotteries, casinos, card games, educational games, games, where the result depends on mastery, skill of the player and other games of chance; rental of sports equipment, except vehicles, for tournaments, competitions, game shows, events in the field of gambling, betting, wagering, lotteries, casinos, card games, educational games, games, where the result depends on mastery, skill of the player and other games of chance; online publication of electronic books and journals, in the field of gambling, betting, wagering, lotteries, casinos, card games, educational games, games, where the result depends on mastery, skill of the player and other games of chance, including for providing access to the related content; publication of texts, other than publicity texts, in the field of gambling, betting, wagering, lotteries, casinos, card games, educational games, games, where the result depends on mastery, skill of the player and other games of chance, including for providing access to the related content; electronic desktop publishing; providing user reviews for entertainment or cultural purposes; providing information in the field of entertainment; providing online videos in the field of gambling, betting, wagering, lotteries, casinos, card games, educational games, games, where the result depends on mastery, skill of the player and other games of chance, non-downloadable; providing sports facilities; practical training as demonstration in the field of gambling, betting, wagering, lotteries, casinos, card games, educational games, games, where the result depends on mastery, skill of the player and other games of chance; training services in the field of gambling, betting, wagering, lotteries, casinos, card games, educational games, games, where the result depends on mastery, skill of the player and other games of chance, provided via simulators; games equip-

ment rental; rental of sports training simulators; providing casino facilities for the services of gambling, betting, wagering, lotteries, card games, educational games, games, where the result depends on mastery, skill of the player and other games of chance; gambling services; electronic game services provided online from a computer network; providing amusement arcade services; providing information in the field of gambling, betting, wagering, lotteries, casinos, card games, educational games, games, where the result depends on mastery, skill of the player and other games of chance, including for providing access to the related content; organization of competitions in the field of gambling, betting, wagering, lotteries, casinos, card games, educational games, games, where the result depends on mastery, skill of the player and other games of chance, including for providing access to the related content live or via television, or online via computer databases, or via the Internet, or via portable, mobile, handheld or tablet devices; organization of lotteries, including live or via television, or online via computer databases, or via the Internet, or via portable, mobile, handheld or tablet devices; organization of sports competitions, including live or via television, or online via computer databases, or via the Internet, or via portable, mobile, handheld or tablet devices; layout services, other than for advertising purposes; online gambling services provided via a computer network; virtual reality gaming services provided online from a computer network; providing online and offline gaming services for accepting bets; providing online and offline poker game services; providing online and offline game services, where the result depends on the mastery, skill of the player; providing online and offline game services for the control of entertainment games, in the field of gambling, betting, wagering, lotteries, casinos, card games, educational games, games, where the result depends on mastery, skill of the player and other games of chance, including for tournaments, competitions, game shows, events and for providing access to the related content; multiplayer card game services provided live or via television, or online via computer databases, or via the Internet, or via portable, mobile, handheld or tablet devices; organization and conducting entertainment presentations; arranging, conducting and presenting, other than for commercial or advertising purposes, of tournaments, competitions, game shows, and other entertainment events in the field of gambling, betting, wagering, lotteries, casinos, card games, educational games, games, where the result depends on mastery, skill of the player and other games of chance, live or via television, or online via computer databases, or via the Internet, or via portable, mobile, handheld or tablet devices; providing the aforesaid services online via computer databases, or via the Internet, or via portable, mobile, handheld or tablet devices; providing online game services for electronic games provided via

the Internet; providing online and offline card game services for several participants; game services provided via simulators; providing online gaming services for accepting bets via simulators; information in relation to game services provided via simulators; information in relation to game services for accepting bets provided via simulators; game betting services; sports betting services; providing online information in relation to computer entertainment games, in the field of gambling, betting, wagering, lotteries, casinos, card games, educational games, games, where the result depends on mastery, skill of the player and other games of chance, including for tournaments, competitions, game shows, events and for providing access to the related content; entertainment services for electronic online games provided via the Internet, non-downloadable.

- (260) AM 2023 120311 A
- (800) 1695295
- (151) 2022 06 28
- (891) 2022 06 28
- (731) Limited Liability Company "Sladkij Oreshek" d. Melechkino, Stroenie 123, g. Solnechnogorsk, RU-141554 Moskovskaya Oblast, Russian Federation

(540)

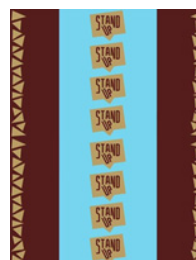

- (591) Blue, brown and beige
- (531) 19.03.24; 26.03.04; 26.03.24; 26.04.07; 26.04.11; 26.04.24; 27.05.01; 27.05.10; 29.01.13

- (511) 30 – Vanilla flavourings for culinary purposes; flavourings, other than essential oils, for cakes; flavourings, other than essential oils, for beverages; coffee flavourings; food flavourings, other than essential oils; star aniseed; baozi; cereal bars; high-protein cereal bars; pancakes; savoury pancakes; freeze-dried dishes with the main ingredient being pasta; freeze-dried dishes with the main ingredient being rice; noodle-based prepared meals; buns; bulgur; bread rolls; pains au chocolat; edible paper wafers; edible rice paper; edible paper; burritos; vanillin [vanilla substitute]; waffles; vermicelli; natural sweeteners; sausage binding materials; binding agents for ice cream; orange blossom water for culinary purposes; seawater for cooking; seaweed [condiment]; malt biscuits; cloves [spice]; mirror icing [mirror glaze]; cake frosting [icing]; glucose for culinary purposes; mustard; croûtons; buckwheat, processed; gluten additives for culi-

nary purposes; yeast; thickening agents for cooking foodstuffs; leaven; rice-based snack food; cereal-based snack food; coffee substitutes; vegetal preparations for use as coffee substitutes; dressings for salad; fruit jellies [confectionery]; candy decorations for cakes; confectionery for decorating christmas trees; cakes; pastries; peanut confectionery; almond confectionery; fruit confectionery; pasta; ground ginger; frozen yogurt [confectionery ices]; cocoa; cream of tartar for culinary purposes; capers; coffee capsules, filled; caramels [sweets]; curry [spice]; ketchup [sauce]; quinoa, processed; quiches; gluten prepared as foodstuff; flour-based dumplings; sweets; liquorice [confectionery]; peppermint sweets; mints for breath freshening; dulce de leche; cinnamon [spice]; coffee; unroasted coffee; starch for food; crackers; rice crackers; crème brûlée; custard; croissants; hominy grits; semolina; oatmeal; crushed barley; groats for human food; ice cubes; corn, milled; corn, roasted; meat pies; turmeric; couscous; laksa; noodles; soba noodles; udon noodles; ice for refreshment; ice, natural or artificial; edible ices; ice pops; potato-based flatbreads; rice cakes; mayonnaise; macarons [pastries]; macaroni; maltose; hominy; piccalilli; marinades; marzipan; honey; miso; royal jelly; ice cream; bean meal; buckwheat flour; tapioca flour; potato flour; corn flour; nut flours; flour; wheat flour; soya flour; barley meal; confectionery in the form of mousses; chocolate mousses; muesli; mint for confectionery; cocoa beverages with milk; coffee beverages with milk; coffee-based beverages; cocoa-based beverages; chamomile-based beverages; tea-based beverages; chocolate beverages with milk; chocolate-based beverages; infusions, not medicinal; nougat; crushed oats; husked oats; kimchi pancakes; onigiri; chocolate-coated nuts; nutmegs; stick liquorice [confectionery]; ginger paste [seasoning]; lozenges [confectionery]; molasses for food; pâtés en croûte; pelmeni; pepper; allspice; peppers [seasonings]; pesto; biscuits; coconut macarons; petit-beurre biscuits; bibimbap [rice mixed with vegetables and beef]; pies; pizzas; meat gravies; fondants [confectionery]; popcorn; powders for making ice cream; baking powder; mustard meal; pralines; condiments; meat tenderizers for household purposes; cereal preparations; oat-based food; propolis; profiteroles; gingerbread; spices; petits fours; puddings; rice pudding; cake powder; ravioli; ramen; chewing gum; chewing gum for breath freshening; relish [condiment]; rice; prepared rice rolled in seaweed; instant rice; wheat germ for human consumption; spring rolls; sago; sugar; crystallized rock sugar; palm sugar; sesame seeds [seasonings]; linseed for culinary purposes [seasoning]; processed seeds for use as a seasoning; aniseed; agave syrup [natural sweetener]; golden syrup; candy bars; savoury pancake mixes; batter mixes; baking soda [bicarbonate of soda for cooking purposes]; malt for human consumption; salt for preserving foodstuffs; cooking salt; celery salt; sorbets [ices]; ham glaze; cranberry sauce [condiment]; soya sauce; tomato sauce; pasta sauce; sauces

[condiments]; apple sauce [condiment]; spaghetti; seasonings; chocolate-based spreads; chocolate spreads containing nuts; preparations for stiffening whipped cream; shaved ice with sweetened red beans; rusks; breadcrumbs; sushi; sandwiches; tabbouleh; tacos; tamarind [condiment]; tapioca; tarts; dough; pastry dough; almond paste; rice pulp for culinary purposes; cake batter; garden herbs, preserved [seasonings]; chocolate decorations for cakes; vinegar; beer vinegar; ferments for pastes; halvah; harissa [condiment]; bread; gluten-free bread; unleavened bread; corn flakes; oat flakes; chips [cereal products]; hot dog sandwiches; flowers or leaves for use as tea substitutes; jiaozi; chicory [coffee substitute]; tea; kelp tea; iced tea; chutneys [condiments]; minced garlic [condiment]; cheeseburgers [sandwiches]; chow-chow [condiment]; saffron [seasoning]; chocolate; malt extract for food; essences for foodstuffs, except etheric essences and essential oils; husked barley.

(260) AM 2023 120313 A

(800) 1695336

(151) 2021 08 11

(891) 2021 08 11

(731) Tarko İtiryat Sanayi Ve İthalat Limited Şirketi
Merkez Mah. İyinyet Sok. No:4, Taksim
Beyoğlu, İSTANBUL, Türkiye

(540)

LIONESSE

(591) Black, blue, red, grey, white

(531) 27.05.01; 27.05.08; 27.05.09; 29.01.15

(511)

8 – Forks, spoons, knives and non-electric cutting utensils for cutting, chopping, peeling, including those of precious metals; blades being weapons; appliances included in this class used for beauty and personal care: shaving, epilation, manicure, pedicure tools, hair straightening and curling hand tools, scissors; manual (non-electric and non-motorized) tools for machine, appliance and vehicle repair, construction, agriculture, horticulture and forestry; non-electric flat irons, electric steam irons; tool handles made of all kinds of materials.

21 – Non-electric cleaning tools and equipment: brushes, excluding paint brushes, steel shavings, sponges, steel wool, rags, textile cleaning and wiping cloths, dish gloves, non-electric polishing machines, carpet brooms; toothbrushes, electric toothbrushes, dental floss, shaving brushes, hairbrushes, combs; non-electrical household and kitchen utensils (excluding forks, knives, spoons) included in this class, including those of precious metal: dinnerware, utensils, bottle openers, pots, straws, non-electric cooking utensils; ironing boards and covers; cages, aquariums, vivariums, terrariums for pets; ornamental and decorative articles of glass, porcelain, ceramics, clay: statues, vases and

trophies awarded in competitions made of these materials; mouse traps, insect traps, fly and insect repellent or exterminator electrical devices, fly catchers, fly rackets; perfume burners, perfume sprayers and perfume vaporizers, appliances for removing make-up, electric and non-electric, powder puffs, wash bags for carrying toiletries; plastic spray nozzles; unprocessed glass, semi-worked glass, glass mosaics for decoration and glass powders (other than for construction), glass wool (not for insulation and textile purposes).

(260) AM 2023 120314 A
 (800) 1695402
 (151) 2022 08 02
 (891) 2022 08 02
 (731) Voestalpine Tubulars GmbH & Co KG
 Alpinestraße 17, A-8652 Kindberg-Aumühl,
 Austria
 (540)

PexTec

(591) Black, white
 (511)
 6 – Penstock pipes of metal for transporting oil and/or natural gases; junctions of metal for oil pipelines or natural gas pipelines; screw-thread connectors of metal for gas-tight pipe connections for pipes for oil pipelines or natural gas pipelines; pipe muffers of metal for oil pipelines or natural gas pipelines; pipes of metal provided with screw-threads for oil pipelines or natural gas pipelines; manifolds of metal for pipelines; pipe strings of metal for the extraction of oil or natural gas; oilfield pipes and drill pipes of metal for searching for/exploitation of oil or gas.

37 – Pipeline construction and maintenance; fitting (laying) of pipes provided with screw-threads and/or screw-thread connectors of metal for gas-tight pipe connections; repair of pipes provided with screw-threads and/or screw-thread connectors of metal for gas-tight pipe connections; all the aforesaid limited to pipes for oil pipelines and natural gas pipelines and to oilfield pipes and drill pipes.

(260) AM 2023 120315 A
 (800) 1695408
 (151) 2022 08 19
 (891) 2022 08 19
 (731) Immersive Health Solutions LLC
 1209 Orange Street, Wilmington DE 19801,
 USA
 (540)

REALITY PRO

(591) Black, white
 (511)

9 – Photographic and optical apparatus and instruments; apparatus for recording, transmission or reproduction of sound or images; data processing equipment; data communication apparatus that transmit data and information to databases; measuring apparatus for values concerning fitness and exercise; cameras; optical lenses; contact lenses; smartglasses; eyewear; eyeglasses; optical goods; optical apparatus and instruments; computer chips; integrated circuits; telecommunication apparatus for mobile networks for the sending, receiving and storing of digital data; computers; computer hardware; computer peripherals; interactive touchscreens; interfaces for computers; smartphones; smartwatches; headphones; headsets; virtual and augmented reality headsets, goggles, and glasses; wearable computer hardware; peripheral devices; wearable peripherals, interfaces, controllers, and remote controls for use with computers, computer hardware, telecommunications apparatus and instruments, smartphones, smartwatches, headphones, headsets, media streaming devices, portable media players, cameras, virtual and augmented reality headsets, goggles, glasses, and smartglasses; computer software; software for accessing, browsing and searching downloadable audio and video files, information and commentary available online from databases or the Internet; virtual and augmented reality software; digital recording media; downloadable audio files, image files, video files, music files and multimedia content.

10 – Surgical and therapeutic imaging, diagnostic, and monitoring apparatus and devices using virtual and augmented reality; health, fitness, exercise, and wellness sensors, monitors, measuring apparatus, and displays.

42 – Design and development services relating to computer hardware and computer peripherals; design, development, maintenance and updating of computer software; computer programming; creating and maintaining web sites; design and maintenance of computer databases; electronic data storage; cloud computing services; providing non-downloadable software; consultation services for developing computer systems, databases and applications; computer security and data security consultancy; data encryption services; providing computer hardware or software information online; maintenance, repair and updating of computer software and applications; technical advisory and support services relating to computer hardware and software problems; providing search engines for obtaining data via the internet and other electronic communications networks; creating indexes of online information, sites and other resources available on the Internet and other electronic communications networks; providing an Internet portal allowing users to preview and download electronic books, publications, and other documents; information, advisory and consultancy services relating to all the aforesaid.

44 – Medical, health, fitness, exercise, and wellness testing, imaging, diagnostic, screening, assessment, evaluation, monitoring, and counseling services using virtual and augmented reality; providing information in the fields of health, fitness, exercise, and wellness.

(260) AM 2023 120316 A

(800) 1695445

(151) 2022 08 25

(891) 2022 08 25

(731) Kawasaki Motors LTD.

1-1, Kawasaki-cho, Akashi-shi, Hyogo
673-8666, Japan

(540)

Let the good times roll

(591) Black, white

(511)

12 – Vessels and their parts and fittings; automobiles and their parts and fittings; two-wheeled motor vehicles, bicycles and their parts and fittings; motorcycles; electric vehicles; hydroplanes; personal watercraft; vehicles; vehicles for locomotion by land, air or water.

35 – Retail services or wholesale services for vessels and their parts and fittings; retail services or wholesale services for automobiles and their parts and fittings; retail services or wholesale services for two-wheeled motor vehicles, bicycles and their parts and fittings; retail services or wholesale services for motorcycles; retail services or wholesale services for electric vehicles; retail services or wholesale services for hydroplanes; retail services or wholesale services for personal watercraft; retail services or wholesale services for vehicles; retail services or wholesale services for vehicles for locomotion by land, air or water.

37 – Repair or maintenance of vessels and their parts and fittings; repair or maintenance of automobiles and their parts and fittings; repair or maintenance of two-wheeled motor vehicles, bicycles and their parts and fittings; repair or maintenance of motorcycles; repair or maintenance of electric vehicles; repair or maintenance of hydroplanes; repair or maintenance of personal watercraft; repair or maintenance of vehicles; repair or maintenance of vehicles for locomotion by land, air or water.

(260) AM 2023 120317 A

(800) 1695466

(151) 2022 08 04

(891) 2022 08 04

(731) UAB "Narbutas International"

Odminių g. 3-23, LT-01122 Vilnius,
Lithuania

(540)

WOBBY

(591) Black, white

(511)

20 – Furniture; furniture fittings, not of metal.

(260) AM 2023 120323 A

(800) 1695526

(151) 2022 09 07

(891) 2022 09 07

(731) VP Holdings

Visbijas prospekts 7, LV-1014 Rīga, Latvia

(540)



(591) Black, blue and white

(531) 26.11.01; 26.11.09; 27.05.01; 29.01.12

(511)

5 – Dietetic substances adapted for medical use; nutritive substances for microorganisms; mineral waters for medical purposes; dietary fibre; haematogen; glycerophosphates; glucose for medical purposes; hormones for medical purposes; vitamin supplement patches; mineral dietary supplements; nutritional supplements; albumin dietary supplements; yeast dietary supplements; alginate dietary supplements; glucose dietary supplements; casein dietary supplements; lecithin dietary supplements; linseed oil dietary supplements; propolis dietary supplements; protein dietary supplements; royal jelly dietary supplements; pollen dietary supplements; wheat germ dietary supplements; linseed dietary supplements; acai powder dietetic supplements; dietary supplements with a cosmetic effect; enzyme dietary supplements; yeast for pharmaceutical purposes; gelatine for medical purposes; cod liver oil; immunostimulants; capsules for medicines; cachets for pharmaceutical purposes; acids for pharmaceutical purposes; collagen for medical purposes; medicated sweets; barks for pharmaceutical purposes; starch for dietetic or pharmaceutical purposes; cultures of microorganisms for medical or veterinary use; liquorice for pharmaceutical purposes; milk sugar for pharmaceutical purposes; lecithin for medical purposes; ointments for pharmaceutical purposes; almond milk for pharmaceutical purposes; powdered milk for babies; royal jelly for pharmaceutical purposes; milk ferments for pharmaceutical purposes; flour for pharmaceutical purposes; linseed meal for pharmaceutical purposes; fish meal for pharmaceutical purposes; freeze-dried meat adapted for medical purposes; dietetic beverages adapted for medical purposes; malted milk beverages for medical purposes; pastilles for pharmaceutical purposes; pectin for pharmaceutical purposes; pepsins for pharmaceutical purposes; peptones for pharmaceutical purposes; food for babies; albuminous preparations for medical purposes; biological preparations for medical purposes; vitamin preparations; preparations

of microorganisms for medical or veterinary use; preparations of trace elements for human and animal use; enzyme preparations for veterinary purposes; phytotherapy preparations for medical purposes; albuminous foodstuffs for medical purposes; dietetic foods adapted for medical purposes; by-products of the processing of cereals for dietetic or medical purposes; homogenized food adapted for medical purposes; freeze-dried food adapted for medical purposes; syrups for pharmaceutical purposes; lacteal flour for babies; infant formula; malt for pharmaceutical purposes; appetite suppressants for medical purposes; medical preparations for slimming purposes; purgatives; sedatives; digestives for pharmaceutical purposes; nervines; steroids; suppositories; serums; appetite suppressant pills; slimming pills; jujube, medicated; antioxidant pills; enzymes for medical purposes; medicinal tea; herbal teas for medicinal purposes; herbal extracts for medical purposes; elixirs [pharmaceutical preparations].

(260) AM 2023 120324 A

(800) 1695593

(151) 2022 08 11

(891) 2022 08 11

(731) Havea Group

Parc d'activité Sud Loire, Boufféré, F-85612

Montaigu Cedex, France

(540)

VITAVEA

(591) Black, white

(511)

3 – Hygiene, beauty, toiletry and care products, all for cosmetic use; soaps; perfumery products; perfumery; essential oils; hair lotions; hair lotions; hair-styling gels and waters; hair sprays; hair dyes; hair coloring and hair bleaching products; dentifrices; cosmetics; cosmetic gel; cosmetic milk; cosmetic lotion; beauty mask; cosmetic foams; cosmetic balms; cosmetic creams; cosmetic powders; cosmetic oils; depilatory waxes; cosmetic serums; facial cleansing milk; cosmetic kits; deodorants; make-up products; make-up removing products; washing preparations for personal hygiene; cosmetic products for the face; cosmetic products for skin care; cosmetic products for the body; cosmetic products for nail care; cosmetic products for foot care; cosmetic products for the care of hands; cosmetic products for bathing; cosmetic products for the shower; bath and shower gel; bath lotion; preparation for hair care; aloe vera preparation for cosmetic use; cleansing gel for the body and hair; almond oil; eaux de toilette; talcum powder for toilet use; cleansing milk for toilet purposes; cleansing water; lotions for cosmetic use; massage oils and gels other than for medical use, protecting cream for baby changing; cotton pads and wipes impregnated with cosmetic lotions or preimpregnated with toilet milks; shampoos; dry shampoos; hair conditioners; cotton sticks for cos-

metic use; cosmetic products in the form of liquid, powder, capsules, pills, tablets, dragées, gelatin capsules, sachets; cosmetic skin-tanning preparations; cosmetic sunscreen products; cosmetic after-sun products; suntanning and after-sun gels and oils (cosmetics); cosmetic preparations for slimming; non-medicated mouthwashes and gargles; mouthwashes, not for medical use; stain removers, bleaching preparations and other substances for laundry use; cleaning, polishing, degreasing and abrasive preparations; laundry detergents; washing-up liquids; fabric softeners for laundry use; creams for preventing stretch marks not for medical use; non-medicinal creams for babies.

5 – Pharmaceutical products; pharmaceutical products for medical use; sanitary products for medical purposes; dietetic foods for medical use; dietetic substances for medical use; food for babies; dietetic products for medical use; food supplements for human beings; dietetic beverages for medical use; nutritional supplements for medical use; vitamin preparations; medicinal herbal teas; medicinal tea; medicinal infusions; trace element preparations for human consumption; food supplements prepared for human consumption for medical use; nutritional supplements; nutritional beverages for medical use in the form of liquid, powder, capsules, pills, tablets, dragées, gelatin capsules, sachets; medicinal herbal infusions; dietetic infusions for medical use; medicinal herbal tea; slimming tea for medical use; herbal teas [beverages for medical use]; medicinal herbs; extracts of medicinal herbs; decoctions of medicinal herbs; herb-based supplements; medicinal herbs in dried or preserved form; herb-based composition for medical use; beverages for medicinal use; food supplements in the form of beverages; herb-based beverages for medicinal use; vitamin-containing beverages for medical use; beverage mixtures used as food supplements; infusions for medical use and tea preparations for medical use with fruits and/or plant extracts for medical use, and/or flavored and/or enriched with vitamins and/or in instant form and/or enriched with minerals; medicinal tea and medicinal herbs for making infusions; food supplements and dietetic preparations in liquid, powder, capsule, pill, tablet, dragée, hard capsule or sachet form; tonics, restoratives, stimulants, snacks in the form of dietetic food preparations rich in protein for medical use; powdered milk for infants; formula milk; milk for children; lacteal flour for babies; antiseptics, serums, eosin (disinfectant), liniments; pharmaceutical preparations for the prevention of stretch marks; medical preparation for nasal spray; arnica-based gel; pharmaceutical products for skin care; prebiotic supplements; food supplements based on chicory for flora preservation; probiotic preparations for medical use to help maintain natural skin-flora balance; creams for babies [for medical use]; food supplements with cosmetic effects; food supplements for infants, babies and children; diapers for babies.

(260) AM 2023 120325 A
 (800) 801592
 (151) 2003 03 26
 (891) 2022 10 20
 (731) Casall Aktiebolag
 P O Box 6007, SE-600 06 Norrköping, Sweden
 (540)

CASALL

(591) Black, white
 (511)
 18 – Leather and imitations of leather, and goods made of these materials and not included in other classes; bags, rucksacks, trunks, suitcases, travelling bags; pocket wallets; umbrellas and parasols.
 25 – Clothing, footwear and headgear.
 28 – Games and playthings; gymnastic and sporting articles, including equipment and apparatus for exercise and strength training; golf articles, included in this class; fishing tackle.

(260) AM 2023 120326 A
 (800) 1373528
 (151) 2017 08 15
 (891) 2022 09 30
 (731) Aktsionernoe Obshchestvo "Nizhegorodsky khimiko-farmatsevtichesky zavod"
 Salganskaya St., 7, RU-603950 Nizhny Novgorod, Russian Federation
 (540)

AndroDoz

(591) Black, white
 (511)
 5 – Albumin dietary supplements; herbal teas for medical purposes; mineral food supplements; nutritional supplements.

(260) AM 2023 120327 A
 (800) 1414350
 (151) 2018 04 18
 (891) 2022 10 25
 (731) The Kyoto Distillery K.K
 15, Mazume-cho, Shimano, Kisshoin,
 Minami-ku, Kyoto-shi, Kyoto 601-8363,
 Japan
 (540)

KI NO BI

(591) Black, white
 (511)
 33 – Gin.

(260) AM 2023 120328 A
 (800) 1431024
 (151) 2018 05 03
 (891) 2022 10 18
 (731) ASC Regenity Limited
 Unit 2.02, 411-413 Oxford Street, Londres
 WC1 2PE, United Kingdom
 (540)

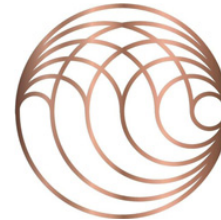

(591) Gold, brown, beige and light brown
 (531) 26.01.05; 26.01.06; 26.11.12; 29.01.12
 (511)
 3 – Bleaching preparations and other substances for laundry use; cleaning, polishing, degreasing and abrasive preparations; soaps not for medical use; perfumery; essential oils; non-medicinal cosmetics; cosmetics for skin rejuvenation and skin health; cosmetics for skin protection and care; hair lotions; shampoos; dentifrices other than for medical use; deodorants for personal use; incense.

5 – Pharmaceutical products; pharmaceutical products for activating endogenous stem cells and repair of their microenvironment; medical and veterinary products; vitamin preparations; sanitary products for medical purposes; dietetic food and substances for medical or veterinary use, food for babies; food supplements for humans and animals; food supplements and products for recovery of patients; plasters, materials for dressings; material for dental fillings and dental impressions; disinfectants; products for destroying vermin; fungicides; herbicides; beverages and food enriched with vitamins for medical use; energy beverages and foodstuffs for medical use.

10 – Surgical, medical, dental and veterinary apparatus and instruments; therapeutic instruments for the treatment of blood, bone marrow or adipose tissue for use in the framework of personalization procedures; artificial limbs, eyes and teeth; orthopedic articles; suture material; therapeutic and assistance apparatus for handicapped persons; massage apparatus.

44 – Medical services; medical and therapy services in the field of precision, individualized and personalized medicine; preparation of medicines and pharmaceutical products for personalized medical approaches; therapeutic process services in the context of point of intervention operations; veterinary services; hygienic and beauty care for human beings or animals; balneotherapy and hydrotherapy treatments; provision of Turkish bath facilities; Turkish baths; rest homes; information services in the field of hygienic and beauty care.

(260) AM 2023 120329 A
 (800) 1465968
 (151) 2019 03 04
 (891) 2022 10 24
 (731) KRKA, tovarna zdravil, d.d., Novo mesto
 Šmarješka cesta 6, SI-8000 Novo mesto,
 Slovenia
 (540)

MAYSIGLU

(591) Black, white
 (511)
 5 – Pharmaceutical preparations.

(260) AM 2023 120330 A
 (800) 1512179
 (151) 2019 07 19
 (891) 2022 09 21
 (731) Joint Stock Company "Akkond"
 Sklads koy proezd, d. 16, Cheboksar,
 RU-428022 Chuvash republic, Russian
 Federation
 (540)



(591) Black, white, beige, light beige, brown, light brown, dark brown and golden brown
 (531) 05.07.06; 08.01.19; 25.12.03; 28.05; 29.01.13
 (526) Graphic elements of the confectionery product
 (511)
 30 – Confectionery namely candy; pastries.

(260) AM 2023 120331 A
 (800) 1583961
 (151) 2020 11 13
 (891) 2022 10 24
 (731) Carlos Santiago Capitan Bialowas
 Bridge House, Lea Road, Lea Town, Preston
 PR4 0RA, United Kingdom
 (540)



(591) Black, white
 (531) 27.05.01; 27.05.10
 (511)
 34 – Electronic cigarettes; electric cigarettes [electronic cigarettes]; liquids for electronic cigarettes; liquid

for electronic cigarettes; cartridges for electronic cigarettes; refill cartridges for electronic cigarettes; smoking sets for electronic cigarettes; liquid nicotine solutions for electronic cigarettes; electronic cigarettes for use as an alternative to traditional cigarettes; liquid solutions for use in electronic cigarettes; liquid nicotine solutions for use in electronic cigarettes; personal oral vaporizers for smokers and electronic cigarettes, and chemical flavourings in liquid form for electronic cigarettes and solutions therefor; electronic cigarette liquid [e-liquid] comprised of flavourings in liquid form used to refill electronic cigarette cartridges; cartridges sold filled with chemical flavourings in liquid form for electronic cigarettes; chemical flavourings in liquid form used to refill electronic cigarette cartridges; tobacco substitutes.

(260) AM 2023 120332 A
 (800) 1605086
 (151) 2020 12 09
 (891) 2022 10 12
 (731) Lojimax Radyatör Isıtma Soğutma Sistemleri
 Sanayi Ticaret Anonim Şirketi
 29 Ekim Mah. 10004 Sok. C Apt. No:6,
 Menemen, İzmir, Türkiye
 (540)



(591) Black, white
 (531) 27.05.01; 27.05.10
 (511)
 11 – Heating installations using solid, liquid or gas fuels or electricity, central heating boilers, boilers for heating installations, radiators [heating], heat exchangers, not parts of machines, stoves, kitchen stoves, solar thermal collectors [heating]; installations for air-conditioning and ventilating; sanitary installations, taps [faucets], shower installations, toilets [water-closets], shower and bathing cubicles, bath tubs, toilet seats, sinks, wash-hand basins [parts of sanitary installations], washers for water taps; water softening apparatus; water purification apparatus; water purification installations; waste water purification installations.

35 – The bringing together, for the benefit of others, of a variety of goods, namely, heating installations using solid, liquid or gas fuels or electricity, central heating boilers, boilers for heating installations, radiators [heating], heat exchangers, not parts of machines, stoves, kitchen stoves, solar thermal collectors [heating], installations for air-conditioning and ventilating, sanitary installations, taps [faucets], shower installations, toilets [water-closets], shower and bathing cubicles, bath tubs, toilet seats, sinks, wash-hand basins [parts of sanitary installations], washers for water taps, stuffings (tap valves), water softening apparatus, water purification apparatus, water purifica-

tion installations, waste water purification installations, enabling customers to conveniently view and purchase those goods, such services may be provided by retail stores, wholesale outlets, by means of electronic media or through mail order catalogues.

(260) AM 2023 120333 A
 (800) 1613357
 (151) 2021 07 19
 (891) 2022 10 10
 (731) Shenzhen Mevol Technology Co., Ltd.
 2138, Oriental Technology Building, No.16,
 Keyuan Road, Science Park Community,
 Yuehai Street, Nanshan District, Shenzhen,
 518064 Guangdong, China

(540)

(591) Black, white
 (531) 27.05.01
 (511)
 34 – Cigarettes containing tobacco substitutes, not for medical purposes; cigarette tips; pocket machines for rolling cigarettes; oral vaporizers for smokers; gas containers for cigar lighters; firestones; electronic cigarettes; liquid solutions for use in electronic cigarettes; flavourings, other than essential oils, for use in electronic cigarettes; cigarette filters.

(260) AM 2023 120334 A
 (800) 1614008
 (151) 2021 07 30
 (891) 2022 10 20
 (731) Minterest Association
 Dammstrasse 16, CH-6300 Zug, Switzerland

(540)

(591) Black, white
 (511)
 36 – Virtual currency services; financial exchange of virtual currency; financial transactions via blockchain; cryptocurrency management services; financial services in relation to digital currencies; financial services, namely, providing a virtual currency for use by members of an on-line community via a global computer network; financial brokerage services; issue of tokens of value.
 42 – Digital asset management; software as a service (SaaS) services featuring software for managing, tracking, accessing, storing, and transferring cryptocurrency; design, development and implementation of software in the field of blockchains; software development, infrastructure development and product development in the field of blockchains; platform as a service [PaaS]; blockchain-as-a-service (BaaS); data

storage via blockchain; certification of data via blockchain; data authentication via blockchain; development of decentralized finance (DeFi) applications and software.

(260) AM 2023 120373 A
 (800) 1695615
 (151) 2022 09 03
 (891) 2022 09 03
 (731) Irfan Cokovic
 Goddardstr. 62, 53125 Bonn, Germany

(540)

(591) Red, white and black
 (531) 25.01.25; 26.13.25; 27.05.01; 29.01.13
 (511)
 43 – Temporary accommodation; rental of furniture, linens and table settings; provision of food and drink; restaurant services; food and drink catering; rental of objects in connection with the provision of the aforesaid services, included in this class; consultancy and information in relation to the aforesaid services, included in this class.

(260) AM 2023 120374 A
 (800) 1695628
 (151) 2022 10 14
 (891) 2022 10 14
 (731) ITechArt Group Inc.
 697 Mill Creek Road, Suite 13, Manahawkin
 NJ 08050, USA

(540)

(591) Black, white
 (511)
 42 – Developing customized software for others; design, maintenance, development and updating of computer software; development, updating and maintenance of software and database systems; planning, design, development and maintenance of online websites for third parties; design and development of software in the field of mobile applications; information technology consulting services.

(260) AM 2023 120375 A
 (800) 1695642
 (151) 2022 08 08
 (891) 2022 08 08
 (731) Maxima SPA
 Via Matteotti 6, I-42028 Poviglio (RE), Italy

(540)

(591) Red and bordeaux
 (531) 02.01.08; 27.05.10; 29.01.12
 (511)
 7 – Diamond discs (parts of machines); diamond tools (parts of machines); blades [parts of machines]; stone working machines; road making machines; coring machines; body saws; cutters for use in construction; floor cutters; grooving machines; honing machines; soil cutters; compacting machinery; connecting rods for machines, motors and engines; reduction gears being parts of machines; milling cutters; vacuum cleaners and aspirators for dry and wet materials; machine-tools; surface cutting apparatus and machines; surface drilling apparatus and machines; surface abrading apparatus and machines; surface sharpening apparatus and machines; surface treating apparatus and machines.
 8 – Diamond discs (parts of hand tools); diamond hand tools.
 19 – Building materials (non metallic); non metallic rigid pipes for building; non-metallic transportable buildings; monuments, not of metal.

(260) AM 2023 120376 A
 (800) 1695658
 (151) 2022 06 09
 (891) 2022 06 09
 (731) Ceadesign Srl
 Via Brenta, 8, I-36020 Pove Del Grappa (VI), Italy
 (540)

CEADESIGN

(591) Black, white
 (511)
 11 – Spouts for washbasin, bidets and bathtubs; flow restrictors for bathroom and shower spouts; shower spouts; hand showers and brackets therefor being parts of sanitary installations; shower sprayers; water intakes and hand-showers brackets; mixers for washbasins, bidets, showers and bathtubs water supply; thermostatic mixing valves for faucets; electronic mixing valves for faucets; mixers for kitchens water supply; faucet sprayers for sanitary ware; waste drains; taps; plumbing fittings, namely traps; recessed toilet cisterns; plumbing fittings for domestic tubs and bathrooms; spouts for outdoor showers; ceiling fans for home interior; electric towel warmers; washbasins; water closets; toilet bowls; showers; showerheads; all the aforementioned goods being intended for domestic use, swimming pool showers, not for use in industrial plants, nor for purification, nor sanitation, nor treatment of water or food products, nor for refrigeration, compression or drying, nor for agricultural use or for animal breeding.

(260) AM 2023 120377 A
 (800) 1695663
 (151) 2022 06 20
 (891) 2022 06 20
 (731) Euro Games Technology LTD.
 4, "Maritsa" Str., "Vranya-Lozen-Triugulnika", BG-1151 Sofia, Bulgaria
 (540)

BURNING HEART

(591) Black, white
 (511)
 9 – Software; computer gaming software; computer software packages; computer operating system software; computer software, recorded; software drivers; virtual reality software; games software; entertainment software for computer games; computer programs for network management; operating computer software for main frame computers; monitors (computer hardware); computer hardware; apparatus for recording images; monitors (computer programs); computer game programs; computer programs for recorded games; apparatus for recording, transmission or reproduction of sound or images; communications servers [computer hardware]; electronic components for gambling machines; computer application software featuring games and gaming; computer software for the administration of on-line games and gaming; computer hardware for games and gaming; hardware and software for gambling, gambling machines, gambling games on the Internet and via telecommunication network.
 28 – Gaming machines for gambling; chips for gambling; mah-jong; arcade games; gambling machines operating with coins, notes and cards; games; electronic games; parlor games; gaming chips; gaming tables; slot machines [gaming machines]; LCD game machines; slot machines and gaming devices; coin-operated amusement machines; roulette chips; poker chips; chips and dice [gaming equipment]; gaming equipment for casinos; roulette tables; gaming roulette wheels; casino games; gambling machines and amusement machines, automatic and coin-operated; coin-operated amusement machines and/or electronic coin-operated amusement machines with or without the possibility of gain; boxes for coin-operated machines, slot machines and gaming machines; electronic or electrotechnical amusement machines and apparatus, gaming machines, coin-operated entertainment machines; housings for coin-operated machines, gaming equipment, gaming machines, machines for gambling; electropneumatic and electrical gambling machines (slot machines).
 41 – Gambling; entertainment services related to gambling; gaming services for entertainment purposes; casino, gaming and gambling services; training in the development of software systems; provision of gaming equipment for gambling halls; providing casino

equipment [gambling]; gaming machine entertainment services; providing casino facilities [gambling]; gaming hall services; amusement arcade services; games equipment rental; rental of gaming machines; providing amusement arcade services; rental of gaming machines with images of fruits; editing or recording of sounds and images; sound recording and video entertainment services; hire of sound reproducing apparatus; provision of gaming equipment for casinos; providing of casino facilities; online gambling services; casino, gaming and gambling services; provision of gaming facilities, gaming hall facilities, Internet casinos and online gambling services.

(260) AM 2023 120389 A
 (800) 1696057
 (151) 2022 06 13
 (891) 2022 06 13
 (731) MTM Industries SP. Z O.O.
 ul. Metalowców 6, PL-62-800 Kalisz, Poland
 (540)



(591) Black, white
 (531) 24.17.25; 27.05.01; 27.05.17; 27.05.19
 (511)
 3 – Fragrance preparations; scented oils; scented wood; scented sachets; air fragrance reed diffusers; room scenting sprays (terms considered too vague in the opinion of the International Bureau - Rule 13 (2) (b) of the Common Regulations); scented ceramic stones; potpourris [fragrances]; scented pine cones; air fragranting preparations; sachets for perfuming linen; perfumery and fragrances; fragrances for automobiles; household fragrances; fragrances for personal use; scented oils used to produce aromas when heated.

(260) AM 2023 120390 A
 (800) 1696091
 (151) 2021 10 28
 (891) 2021 10 28
 (731) Türk Demir Döküm Fabrikalari Anonim Şirketi
 Atatürk Mahallesi Meriç Caddesi No: 1/ 4,
 TR-34758 Ataşehir İstanbul, Türkiye
 (540)



(591) Dark red and white
 (531) 26.01.03; 26.01.18; 26.04.03; 27.05.01;
 29.01.12
 (511)
 7 – Dust removal equipment for industrial purposes, dust collecting equipment; vending machines; gas pumps for service stations (automatic); electrical or electronic door opening-closing device; apparatuses for galvanization.
 8 – Irons; electric and steam irons, press irons; electric hair curlers, curlers.
 9 – Instruments and devices used for measurement and evaluation in the fields of science, laboratory, nautical, topography, meteorology, electricity, photography, cinema, industry and optics; materials testing instruments and devices, namely, barometers, ammeters (electric current meters), gas testing devices, hygrometers, thermometers (air temperature meters), voltmeters, microscopes, magnifiers, telescopes, periscopes; laboratory apparatus, namely, test tubes, special scaled containers, laboratory test furnaces; illuminated advertising signs, electronic score display apparatus, slide projection apparatus; apparatus for recording, transmission or reproduction of sound or images, excluding communication devices, namely, radios, television apparatus, video recorders, cameras, audio equipment and parts thereof, entertainment devices as supplementary devices for television receivers, namely, video projectors, cinematographic devices, remote control instruments, headphones, loudspeakers, megaphones, entry phone, intercoms, picture and projection apparatus; all kinds of photographic cameras, parts and accessories for photographic cameras, photographic enlargers (aggrandizer); films, exposed, namely, cinematographic films ready for shooting, photographic films, x-ray films, antennas, satellite antennas, amplifiers for antennas, parts of the aforementioned goods; money, token or card-operated devices and mechanisms for them, namely, automatic picture taking machines, ticket dispensers, weighing machines, automatic teller machines (ATM); electronic components used in the electronic parts of machines and apparatus, semi-conductors, electronic circuits, integrated circuits, chips [integrated circuits], diodes, photocells, transistors [electronic], circuit boards, crystal oscillators, capacitors, interface circuits, delay lines, liquid crystal displays, hybrid circuits, thermistors (heat sensor), converters, magnetic heads for electronic apparatus, magnetic deflectors; counters, namely, electric meters, water meters, gas meters, parking meters, timers, egg cooking timers (timer, hourglass); weighing apparatus and devices, namely, scales, balances [steelyards], weighing machine; detectors, imaging radiological equipment (x-ray); lifesaving and protective equipment, namely, life jackets, life buoys, swimming sleeves being life saving apparatus for use at swimming pools, breathing apparatus for divers, diving

suits, diving goggles; safety restraints, other than for vehicle seats and sports equipment, safety nets; protective clothing, namely, gloves, goggles and headgear (helmets); signal whistles and luminous beacons, marker buoys; eyeglasses, sunglasses, optical lenses and cases, containers, parts and components thereof; electrical materials, namely, plugs, sockets, junction boxes, electric switches, circuit breakers and disconnectors, fuses, lighting ballasts, battery starter cables, electrical panels, elevator control panels, terminals (connectors), electricity conduits, cable channels, push buttons for bells, resistances, connectors and sockets used in electricity and electronics; apparatus and instruments for conducting, transforming, loading, adjusting, dispatching and controlling electricity, electrical adapters, battery chargers; electric bells, alarms except vehicle alarms, sirens; cables and wires used in electricity, electronics and telephone lines, optical fiber, fiber optic cables; power sources, namely, batteries, solar cells, batteries, uninterruptible power supplies; gauges for vehicles, namely, speed, oil, fuel and temperature gauges, tachometers, taximeters; wheel balancing devices; failure warning triangles (reflector triangles) for vehicles, illuminated and mechanical road signs, electrical-electronic or mechanically operated traffic signaling equipment, intersection control devices, flashers; fire trucks, fire extinguishers and devices; welding transformers; radars, submarine radars (sonars), night vision providing or enhancing devices and equipment; lightning rods, surge arresters (grounding plates); dosage dispensers; scientific satellites; electrolysis apparatus for laboratory use and galvanization; anodes, cathodes; screen filters for computers and televisions; remote control apparatus for opening and closing vehicle doors; magnets, decorative magnets; earplugs.

11 – Lighting installations; lights for vehicles and interior-exterior spaces, namely, lamps, lighting bulbs, searchlights, lanterns, chandeliers, lamp glasses, lampholders, lighting and signal lamps for vehicles (bulbs), headlights, taillights, light bulbs for directional signals for vehicles, vehicle reflectors, reflector lamps; devices for heating and steam generation installations, namely, stoves (heating apparatus), heating boilers, natural gas boilers, steam boilers, other than parts of machines, heat exchangers, burners, floor heating devices, water heaters that can also be used as floor heaters, water heaters, radiators, heat pumps, electric water boilers, solar thermal collectors [heating]; solid, liquid, gas-fired and electric stoves, ranges; air conditioning and ventilation devices, namely, air conditioners including for vehicles, fans (air blower), ventilators; air disinfecting and cleaning tools, devices and their parts and accessories; coolers, namely, refrigerators, deep freezers, ice boxes, ice machines and apparatus; electric and gas-powered devices, installations and apparatus for cooking and boiling, namely, toast machines, toasters, fryers, fire bars, grills, ovens, cookers, popcorn machines or electric popcorn ma-

kers, autoclave, coffee and tea making machines, kettles and parts thereof; bathtubs, bidets, shower and bathing cubicles, urinals, toilet bowls, sinks, wash-hand basins [parts of sanitary installations], their partitions and structural elements; taps for water and gas installations, thermostatic valves as part of heating installations, level control valves for tanks, heat regulators [valves] being parts of heating installations; fountains for automatic watering installations, handsets and spirals for showers, water-pipes for sanitary installations; watering machines for agricultural purposes; water softening devices, water purification devices, water purification system, waste treatment system; electric hair dryers, blow dryers, hand dryers, facial saunas, solarium devices; electric bed warmers and electric blankets, not for medical use; electric pillow warmers; electric or non-electric footwarmers; hot water bottles; lighters used in the kitchen, lighters that parts of heating and cooking apparatus; filters for aquariums and aquarium filtration apparatus; industrial furnaces; industrial type installations for drying and cooling purposes, namely, cooling towers, cold storages; nuclear reactors; incandescent burners, acetylene burners and generators; pasteurizers and sterilizers; tumble driers for laundry use; iron melting furnaces; air filters of household apparatus included in this class, air filters that are parts of industrial equipment; heating apparatus for defrosting vehicle windows.

21 – Insect and insect repellent or exterminator electrical devices.

(260) AM 2023 120391 A

(800) 1696103

(151) 2022 03 28

(891) 2022 03 28

(731) Hilal Day. Tük.Mam. Tic.Ve San.LTD.Şti
Beylerbeyi Mah. Havuzbaşı Sk. 26 1,
Üsküdar, İstanbul, Türkiye

(540)



(591) Black, yellow, orange, lilac, purple and pink

(531) 03.07.17; 26.11.03; 26.11.12; 26.13.25;

27.05.01; 29.01.15

(511)

35 – The bringing together, for the benefit of others, of a variety of goods, namely, chemicals used in industry, science, photography, agriculture, horticulture and forestry, manures and soils, unprocessed artificial resins and unprocessed plastics, fire extinguishing compositions, adhesives not for medical, household and stationery purposes, paints, varnishes, lacquers, preservatives against rust, preservatives against deterioration of wood, thinners and binders for paints, pig-

ments, preservatives for metals, shoe dyes, printing dyes and ink, toners (including filled toner cartridges), colorants for food, pharmaceuticals and beverages, raw natural resins, metals in foil and powder form for painters, decorators, printers and artists, bleaching and cleaning preparations, detergents other than for use in manufacturing operations and for medical purposes, laundry bleach, fabric softeners for laundry use, stain removers, dishwasher detergents, perfumery, non-medicated cosmetics, fragrances, deodorants for personal use and animals, soaps, dental care preparations, dentifrices, denture polishes, tooth whitening preparations, mouth washes, not for medical purposes, abrasive preparations, emery cloth, sandpaper, pumice stone, abrasive pastes, polishing preparations for leather, vinyl, metal and wood, polishes and creams for leather, vinyl, metal and wood, wax for polishing, industrial oils and greases, cutting fluids, dust absorbing, wetting and binding compositions, solid fuels, coal, firewood, liquid and gas fuels, petrol, diesel oil, liquified petroleum gas, natural gas, fuel oil and their non-chemical additives, candles, wicks, semi-finished wax, wax and paraffin for lighting purposes, electrical energy, pharmaceutical and veterinary preparations for medical purposes, chemical preparations for medical and veterinary purposes, chemical reagents for pharmaceutical and veterinary purposes, medicated cosmetics, dietary supplements for pharmaceutical and veterinary purposes, dietary supplements, nutritional supplements, medical preparations for slimming purposes, food for babies, herbs and herbal beverages adapted for medicinal purposes, dental preparations and articles, teeth filling material, dental impression material, dental adhesives and material for repairing teeth, sanitary preparations for medical use, hygienic pads, hygienic tampons, plasters, materials for dressings, diapers made of paper and textiles for babies, adults and pets, preparations for destroying vermin, herbicides, fungicides, preparations for destroying rodents, deodorants, other than for human beings or for animals, air purifying preparations, air deodorising preparations, disinfectants, antiseptics, detergents for medical purposes, medicated soaps, disinfectant soaps, antibacterial hand lotions, ores of non-precious metal, common metals and their alloys and semi-finished products made of these materials, irons for construction, mats and stirrups of common metals for buildings, common metals in the form of plate, billet, stick, profile, sheet and sheeting, goods and materials of common metal used for storage, wrapping, packaging and sheltering purposes, containers of metal (storage, transport), buildings of metal, frames of metal for building, poles of metal for building, metal boxes, packaging containers of metal, aluminium foil, fences made of metal, guard barriers of metal, metal tubes, storage containers of metal, metal containers for the transportation of goods, ladders of metal, goods of common metal for filtering and sifting purposes, doors, windows, shutters, jalousies and their cases

and fittings of metal, non-electric cables and wires of metal, ironmongery, small hardware of metal, screws of metal, nails, bolts of metal, nuts of metal, pegs of metal, flakes of metal, pitons of metal, metal chains, furniture casters of metal, fittings of metal for furniture, industrial metal wheels, door handles of metal, window handles of metal, hinges of metal, metal latches, metal locks, metal keys for locks, metal rings, metal pulleys, ventilation ducts, vents, vent covers, pipes, chimney caps, manhole covers, grilles of metal for ventilation, heating, sewage, telephone, underground electricity and air conditioning installations, metal panels or boards (non-luminous and non-mechanical) used for signalling, route showing, publicity purposes, signboards of metal, advertisement columns of metal, signaling panels of metal, non-luminous and non-mechanical traffic signs of metal, pipes of metal for transportation of liquids and gas, drilling pipes of metal and their metal fittings, valves of metal, couplings of metal for pipes, elbows of metal for pipes, clips of metal for pipes, connectors of metal for pipes, safes (strong boxes) of metal, metal railway materials, metal rails, metal railway ties, railway switches, bollards of metal, floating docks of metal, mooring buoys of metal, anchors, metal moulds for casting, other than machine parts, works of art made of common metals or their alloys, trophies of common metal, metal closures, bottle caps of metal, metal poles, metal pillars, scaffolding of metal, metal stakes, metal towers, metal pallets and metal ropes for lifting, loading and transportation purposes, metal hangers, ties, straps, tapes and bands used for load-lifting and load-carrying, wheel chocks made primarily of metal, metal profile laths for vehicles for the purposes of decoration, machines, machine tools and industrial robots for processing and shaping wood, metals, glass, plastics and minerals, 3D printers, construction machines and robotic mechanisms (machines) for use in construction, bulldozers, diggers (machines), excavators, road construction and road paving machines, drilling machines, rock drilling machines, road sweeping machines, lifting, loading and transmission machines and robotic mechanisms (machines) for lifting, loading and transmission purposes, elevators, escalators and cranes, machines and robotic mechanisms (machines) for use in agriculture and animal breeding, machines and robotic mechanisms (machines) for processing cereals, fruits, vegetables and food, machines for preparing and processing beverages, engines and motors, other than for land vehicles, parts and fittings therefor, hydraulic and pneumatic controls for engines and motors, brakes other than for vehicles, brake linings for engines, crankshafts, gearboxes, other than for land vehicles, gearboxes, cylinders for engines, pistons for engines, turbines, not for land vehicles, filters for engines and motors, oil, air and fuel filters for land vehicle engines, exhausts for land vehicle engines, exhaust manifolds for land vehicle engines, engine cylinders for land vehicles, engine cylinder

heads for land vehicles, pistons for land vehicle engines, carburetors for land vehicles, fuel conversion apparatus for land vehicle engines, injectors for land vehicle engines, fuel economisers for land vehicle engines, pumps for land vehicle engines, valves for land vehicle engines, starter motors for land vehicles, dynamos for land vehicle engines, sparking plugs for land vehicle engines, bearings (parts of machines), roller or ball bearings, machines for mounting and detaching tires, alternators, current generators, electric generators, current generators operated with solar energy, painting machines, automatic spray guns for paint, electric, hydraulic and pneumatic punching machines and guns, electric adhesive tape dispensers (machines), electric guns for compressed gas or liquid spraying machines, electric hand drills, electric hand saws, electric jigsaw machines, spiral machines, compressed air machines, compressors (machines), vehicle washing installations, robotic mechanisms (machines) with the abovementioned functions, electric and gas-operated welding apparatus, electric arc welding apparatus, electric soldering apparatus, electric arc cutting apparatus, electrodes for welding machines, industrial robots (machines) with the abovementioned functions, printing machines, packaging machines, filling, plugging and sealing machines, labellers (machines), sorting machines, industrial robots (machines) with the abovementioned functions, electric packing machines for plugging and sealing of plastics, machines for textile processing, sewing machines, industrial robots (machines) with the abovementioned functions, pumps other than parts of machines or engines, fuel dispensing pumps for service stations, self-regulating fuel pumps, electric kitchen machines for chopping, grinding, crushing, mixing and mincing foodstuff, washing machines, laundry washing machines, dishwashers, spin driers (not heated), electric cleaning machines for cleaning floors, carpets or floorings, vacuum cleaners and parts thereof, automatic vending machines, galvanizing and electroplating machines, electric door openers and closers, gaskets for engines and motors, forks, spoons, knives and non-electric cutters, slicers, peelers for kitchen use, including those made of precious metals, side arms and blades (weapons), tools and apparatus for personal beauty care use, tools and apparatus for shaving, epilation, manicure and pedicure, electric hand implements for straightening and curling hair, scissors, hand-operated [non-electric] hand tools for the repair of machines, apparatus and vehicles and for use in construction, agriculture, horticulture and forestry, none of them being power tools, electric or non-electric irons, steam irons, handles for hand-operated hand tools, measurement apparatus and equipment including those for scientific, nautical, topographic, meteorologic, industrial and laboratory purposes, thermometers, not for medical purposes, barometers, ammeters, voltmeters, hygrometers, testing apparatus not for medical

purposes, telescopes, periscopes, directional compasses, speed indicators, laboratory apparatus, microscopes, magnifying glasses, stills, binoculars, ovens and furnaces for laboratory experiments, apparatus for recording, transmission or reproduction of sound or images, cameras, photographic cameras, television apparatus, video recorders, CD and DVD players and recorders, MP3 players, computers, desktop computers, tablet computers, wearable technological devices (smart watches, wristbands, head-mounted devices) microphones, loudspeakers, earphones, telecommunications apparatus, apparatus for the reproduction of sound or images, computer peripheral devices, cell phones, covers for cell phones, telephone apparatus, computer printers, scanners [data processing equipment], photocopiers, magnetic and optic data carriers and computer software and programmes recorded thereto, downloadable and recordable electronic publications, encoded magnetic and optic cards, movies, TV series and video music clips recorded on magnetic, optical and electronic media, antennas, satellite antennas, amplifiers for antennas, parts of the aforementioned goods, ticket dispensers, automatic teller machines (ATM), electronic components used in the electronic parts of machines and apparatus, semi-conductors, electronic circuits, integrated circuits, chips [integrated circuits], diodes, transistors [electronic], magnetic heads for electronic apparatus, electronic locks, photocells, remote control apparatus for opening and closing doors, optical sensors, counters and quantity indicators for measuring the quantity of consumption, automatic time switches, clothing for protection against accidents, irradiation and fire, safety vests and life-saving apparatus and equipment, eyeglasses, sunglasses, optical lenses and cases, containers, parts and components thereof, apparatus and instruments for conducting, transforming, accumulating or controlling electricity, electric plugs, junction boxes [electricity], electric switches, circuit breakers, fuses, lighting ballasts, battery starter cables, electrical circuit boards, electric resistances, electric sockets, transformers [electricity], electrical adapters, battery chargers, electric door bells, electric and electronic cables, batteries, electric accumulators, solar panels for production of electricity, alarms and anti-theft alarms, other than for vehicles, electric bells, signalling apparatus and instruments, luminous or mechanical signs for traffic use, fire extinguishing apparatus, fire engines, fire hose and fire hose nozzles, radar apparatus, sonars, night vision apparatus and instruments, decorative magnets, metronomes, surgical, medical, dental and veterinary apparatus and instruments, furniture especially made for medical purposes, artificial limbs and prostheses, medical orthopaedic articles, corsets for medical purposes, orthopaedic shoes, elastic bandages and supportive bandages, surgical gowns and surgical sterile sheets, adult sexual aids, condoms, babies' bottles, babies' pacifiers, teats, teethers for babies, bracelets and rings for medical purposes, anti-rheumatism bracelets,

anti-rheumatism rings, lighting installations, lights for vehicles and interior-exterior spaces, heating installations using solid, liquid or gas fuels or electricity, central heating boilers, boilers for heating installations, radiators [heating], heat exchangers, not parts of machines, stoves, kitchen stoves, solar thermal collectors [heating], steam, gas and fog generators, steam boilers, other than parts of machines, acetylene generators, oxygen generators, nitrogen generators, installations for air-conditioning and ventilating, cooling installations and freezers, electric and gas-powered devices, installations and apparatus for cooking, drying and boiling, cookers, electric cooking pots, electric water heaters, barbecues, electric laundry driers, hair driers, hand drying apparatus, sanitary installations, taps [faucets], shower installations, toilets [water-closets], shower and bathing cubicles, bath tubs, toilet seats, sinks, wash-hand basins [parts of sanitary installations], washers for water taps, stuffings (tap valves), water softening apparatus, water purification apparatus, water purification installations, waste water purification installations, electric bed warmers and electric blankets, not for medical use, electric pillow warmers, electric or non-electric footwarmers, hot water bottles, electrically heated socks, filters for aquariums and aquarium filtration apparatus, industrial type installations for cooking, drying and cooling purposes, pasteurizers and sterilizers, motor land vehicles, motorcycles, mopeds, engines and motors for land vehicles, clutches for land vehicles, transmissions, transmission belts and transmission chains for land vehicles, gearing for land vehicles, brakes, brake discs and brake linings for land vehicles, vehicle chassis, automobile bonnets, vehicle suspension springs, shock absorbers for automobiles, gearboxes for land vehicles, steering wheels for vehicles, rims for vehicle wheels, bicycles and their bodies, handlebars and mudguards for bicycles, vehicle bodies, tipping bodies for trucks, trailers for tractors, frigorific bodies for land vehicles, trailer hitches for vehicles, vehicle seats, head-rests for vehicle seats, safety seats for children, for vehicles, seat covers for vehicles, vehicle covers (shaped), sun-blinds adapted for vehicles, direction signals and arms for direction signals for vehicles, windscreen wipers and wiper arms for vehicles, inner and outer tires for vehicle wheels, tubeless tires, tire-fixing sets comprised of tire patches and tire valves for vehicles, windows for vehicles, safety windows for vehicles, rear-view mirrors and wing mirrors for vehicles, anti-skid chains for vehicles, luggage carriers for vehicles, bicycle and ski carriers for cars, saddles for bicycles or motorcycles, air pumps for vehicles, for inflating tires, anti-theft alarms for vehicles, horns for vehicles, safety belts for vehicle seats, air bags (safety devices for automobiles), baby carriages, wheelchairs, pushchairs, wheelbarrows, shopping carts, single or multi-wheeled wheelbarrows, shopping trolleys, grocery carts, handling carts, rail vehicles, locomotives, trains, trams, waggons, cable cars, chairlifts, vehicles for lo-

comotion by water and their parts, other than their motors and engines, vehicles for locomotion by air and their parts, other than their motors and engines, firearms, air pistols (weapons), spring-loaded firearms, adapted cases and shoulder straps therefor, heavy weapons, mortars and rockets, fireworks, sprays for personal defence purposes, jewellery, imitation jewellery, gold, precious stones and jewellery made thereof, cufflinks, tie pins, statuettes and figurines of precious metal, clocks, watches and chronometrical instruments, chronometers and their parts, watch straps, trophies made of precious metal, rosaries, musical instruments and cases for musical instruments, paper and cardboard, paper and cardboard for packaging and wrapping purposes, cardboard boxes, paper towels, toilet paper, paper napkins, plastic materials for packaging and wrapping purposes, printing blocks and types, bookbinding material, printed publications, printed matter, books, magazines, newspapers, bill books, printed dispatch notes, printed vouchers, calendars, posters, photographs [printed], paintings, stickers [stationery], postage stamps, stationery, office stationery, instructional and teaching material [except furniture and apparatus], writing and drawing implements, artists' materials, paper products for stationery purposes, adhesives for stationery purposes, pens, pencils, erasers, adhesive tapes for stationery purposes, cardboard cartons [artists' materials], writing paper, copying paper, paper rolls for cash registers, drawing materials, chalkboards, painting pencils, water-colors [paintings], office requisites, paint rollers and paintbrushes for painting, rubber, gutta-percha, gum, asbestos, mica and semi-finished synthetic goods made from these materials in the form of powder, bars, panels and foils, insulation, stopping and sealing materials, insulation paints, insulation fabrics, insulating tape and band, insulation covers for industrial machinery, joint sealant compounds for joints, gaskets, O-rings for sealing purposes (other than gaskets for motors, cylinders and washer for water taps), flexible pipes made from rubber and plastic, hoses made of plastic and rubber, including those used for vehicles, junctions for pipes of plastic and rubber, pipe jackets of plastic and rubber, hoses of textile material, junctions for pipes, not of metal, pipe jackets, not of metal, connecting hose for vehicle radiators, profile laths made of synthetic materials for vehicles for the purposes of decoration, unworked or semi-worked leather and animal skins, imitations of leather, stout leather, leather used for linings, goods made of leather, imitations of leather or other materials, designed for carrying items, bags, wallets, boxes and trunks made of leather or stout leather, keycases, trunks [luggage], suitcases, umbrellas, parasols, sun umbrellas, walking sticks, whips, harness, saddlery, stirrups, straps of leather (saddlery), sand, gravel, crushed stone, asphalt, bitumen, cement, gypsum, plaster, concrete, marble blocks for construction, building materials (as finished products) made of concrete, gypsum, clay, po-

tters' clay, stone, marble, wood, plastics and synthetic materials for building, construction, road construction purposes, non-metallic buildings, non-metallic building materials, poles not of metal for power lines, barriers not of metal, natural and synthetic coatings in the form of panels and sheets, being building materials, bitumen cardboard coatings for roofing, bitumen coating for roofing, doors and windows of wood and synthetic materials, traffic signs not of metal, non-luminous and non-mechanical, for roads, monuments and statuettes of stone, concrete and marble, building glass, prefabricated swimming pools not of metal (structures), aquarium sand, furniture, made of any kind of material, mattresses, pillows, air mattresses and cushions, not for medical purposes, water beds, mirrors, beehives, artificial honeycombs and sections of wood for honeycombs, bouncing chairs for babies, playpens for babies, cradles, infant walkers, display boards, frames for pictures and paintings, identification plates, identification tags, nameplates, identification labels made of wood or synthetic materials, packaging containers of wood or plastics, casks for use in transportation or storage, barrels, storage drums, tanks, boxes, storage containers, transportation containers, chests, loading pallets and closures for the aforementioned goods, of wood or plastics, small hardware goods of wood or synthetic materials, furniture fittings, of wood or synthetic materials, opening and closing mechanisms of wood or synthetic materials, ornaments and decorative goods of wood, cork, reed, cane, wicker, horn, bone, ivory, whalebone, shell, amber, mother-of-pearl, meerschaum, beeswax, plastic or plaster namely figurines, holiday ornaments for walls, sculptures, trophies, baskets, fishing baskets, kennels, nesting boxes and beds for household pets, portable ladders and mobile boarding stairs of wood or synthetic materials, bamboo curtains, roller indoor blinds [for interiors], slatted indoor blinds, strip curtains, bead curtains for decoration, curtain hooks, curtain rings, curtain tie-backs, curtain rods, non-metal wheel chocks, hand-operated non-electric cleaning instruments and appliances, brushes, other than paintbrushes, steel chips for cleaning, sponges for cleaning, steel wool for cleaning, cloths of textile for cleaning, gloves for dishwashing, non-electric polishing machines for household purposes, brooms for carpets, mops, toothbrushes, electric toothbrushes, dental floss, shaving brushes, hair brushes, combs, non-electric household or kitchen utensils, [other than forks, knives, spoons], services [dishes], pots and pans, bottle openers, flower pots, drinking straws, non-electric cooking utensils, ironing boards and shaped covers therefor, drying racks for washing, clothes drying hangers, cages for household pets, indoor aquariums, vivariums and indoor terrariums for animals and plant cultivation, ornaments and decorative goods of glass, porcelain, earthenware or clay namely statues, figurines, vases and trophies, mouse traps, insect traps, electric devices for attracting and killing flies and in-

sects, fly catchers, fly swatters, perfume burners, perfume sprayers, perfume vaporizers, electric or non-electric make-up removing appliances, powder puffs, toilet cases, nozzles for sprinkler hose, nozzles for watering cans, watering devices, garden watering cans, unworked or semi-worked glass, except building glass, mosaics of glass and powdered glass for decoration, except for building, glass wool other than for insulation or textile use, ropes, strings, rope ladders, hammocks, fishing nets, tents, awnings, tarpaulins, sails, vehicle covers, not fitted, bags of textile, for packaging, padding and stuffing materials, except of rubber and plastics, including those of wool and cotton, textile fibers, raw spun fiber, glass fibers for textile use, yarns and threads for textile use, threads and yarns for sewing, embroidery and knitting, thread, elastic yarns and threads for textile use, woven or non-woven textile fabrics, textile goods for household use, curtains, bed covers, sheets (textile), pillowcases, blankets, quilts, towels, flags, pennants, labels of textile, swaddling blankets, sleeping bags for camping, clothing, including underwear and outerclothing, other than special purpose protective clothing, socks, mufflers [clothing], shawls, bandanas, scarves, belts [clothing], footwear, shoes, slippers, sandals, headgear, hats, caps with visors, berets, caps [headwear], skull caps, laces and embroidery, guipures, festoons, ribbons (haberdashery), ribbons and braid, fastening tapes for clothing, cords for clothing, letters and numerals for marking linen, embroidered emblems, badges for wear, not of precious metal, shoulder pads for clothing, buttons for clothing, fasteners for clothing, eyelets for clothing, zippers, buckles for shoes and belts, fasteners, shoe and belt buckles, pins, other than jewellery, adhesive patches for decoration of textile articles, laces, needles, sewing needles, needles for sewing machines, needles for knitting and embroidery, boxes for needles, needle cushions, artificial flowers, artificial fruits, hair pins, hair buckles, hair bands, decorative articles for the hair, not made of precious metal, wigs, hair extensions, electric or non-electric hair curlers, other than hand implements, carpets, rugs, mats, prayer rugs, linoleum, artificial turf, linoleum for covering floors, gymnasium mats, wallpaper, wall hangings not of textile, games and toys, arcade video game machines, game apparatus and machines for use with an external display screen and monitor, including those coin-operated, toys for animals, toys for outdoor playgrounds, parks and game parks, gymnastic and sporting articles, fishing tackle, artificial fishing bait, decoys for hunting and fishing, Christmas trees of artificial material, ornaments for Christmas trees, artificial snow for Christmas trees, rattles (playthings), novelties for parties, dances (party favors), paper party hats, meat, fish, poultry and game, processed meat products, dried pulses, soups, bouillon, processed olives, olive paste, milks of animal origin, milks of herbal origin, milk products, butter, edible oils, dried, preserved, frozen, cooked, smoked

or salted fruits and vegetables, tomato paste, prepared nuts and dried fruits as snacks, hazelnut spreads and peanut butter, tahini (sesame seed paste), eggs and powdered eggs, potato chips, coffee, cocoa, coffee or cocoa based beverages, chocolate based beverages, pasta, stuffed dumplings, noodles, pastries and bakery products based on flour, desserts based on flour and chocolate, bread, simit [Turkish ring-shaped bagel covered with sesame seeds], poğaç [Turkish bagel], pita, sandwiches, katmer [Turkish pastry], pies, cakes, baklava [Turkish dessert based on dough coated with syrup], kadayif [Turkish dessert based on dough], desserts based on dough coated with syrup, puddings, custard, kazandibi [Turkish pudding], rice pudding, keşkül [Turkish pudding], honey, bee glue for human consumption, propolis for food purposes, condiments for foodstuff, vanilla (flavoring), spices, sauces (condiments), tomato sauce, yeast, baking powder, flour, semolina, starch for food, sugar, cube sugar, powdered sugar, tea, ice tea, confectionery, chocolate, biscuits, crackers, wafers, chewing gums, ice-cream, edible ices, salt, cereal-based snack food, popcorn, crushed oats, corn chips, breakfast cereals, processed wheat for human consumption, crushed barley for human consumption, processed oats for human consumption, processed rye for human consumption, rice, molasses for food, agricultural and horticultural products, seeds, forestry products, live animals, fertilized eggs for hatching, plants, dried plants for decoration, fresh garden herbs, dried garden herbs for decoration, animal foodstuffs, malt not for human consumption, underlays for pets, cat litters, beers, preparations for making beer, mineral water, spring water, table water, soda water, fruit and vegetable juices, fruit and vegetable concentrates and extracts for making beverages, non-alcoholic soft drinks, energy drinks, protein-enriched sports beverages alcoholic beverages (except beers), wines, raki [traditional Turkish alcoholic drink], whiskey, liqueurs, alcoholic cocktails, tobacco, chewing tobacco, cigarettes, cigars, smokers' articles including those made of precious metals, pipes, mouthpieces for cigars and cigarettes, ashtrays, tobacco boxes, pocket apparatus for rolling cigarettes, cigarette paper, tobacco pipes, firestones, lighters for smokers, electronic cigarettes and their cartridges, matches, enabling customers to conveniently view and purchase those goods, such services may be provided by retail stores, wholesale outlets, by means of electronic media or through mail order catalogues.

(260) AM 2023 120398 A

(800) 1696206

(151) 2022 07 11

(891) 2022 07 11

(731) Euro Games Technology LTD.

4, "Maritsa" Str., "Vranya-Lozen-Triugulnika",
BG-1151 Sofia, Bulgaria

(540)



(591) Yellow, orange, brown, gold, blue, cyan and black

(531) 27.05.01; 27.05.03; 27.05.04; 27.05.17;
29.01.15

(511)

9 – Software; computer gaming software; computer software packages; computer operating system software; computer software, recorded; software drivers; virtual reality software; games software; entertainment software for computer games; computer programs for network management; operating computer software for main frame computers; monitors (computer hardware); computer hardware; apparatus for recording images; monitors (computer programs); computer game programs; computer programs for recorded games; apparatus for recording, transmission or reproduction of sound or images; communications servers [computer hardware]; electronic components for gambling machines; computer application software featuring games and gaming; computer software for the administration of on-line games and gaming; computer hardware for games and gaming; hardware and software for gambling, gambling machines, gambling games on the Internet and via telecommunication network.

28 – Gaming machines for gambling; chips for gambling; mah-jong; arcade games; gambling machines operating with coins, notes and cards; games; electronic games; parlor games; gaming chips; gaming tables; slot machines [gaming machines]; LCD game machines; slot machines and gaming devices; coin-operated amusement machines; roulette chips; poker chips; chips and dice [gaming equipment]; gaming equipment for casinos; roulette tables; gaming roulette wheels; casino games; gambling machines and amusement machines, automatic and coin-operated; coin-operated amusement machines and/or electronic coin-operated amusement machines with or without the possibility of gain; boxes for coin-operated machines, slot machines and gaming machines; electronic or electrotechnical amusement machines and apparatus, gaming machines, coin-operated entertainment machines; housings for coin-operated machines, gaming equipment, gaming machines, machines for gambling; electropneumatic and electrical gambling machines (slot machines).

41 – Gambling; entertainment services related to gambling; gaming services for entertainment purposes; casino, gaming and gambling services; training in the development of software systems; provision of gaming equipment for gambling halls; providing casino equipment [gambling]; gaming machine entertainment

services; providing casino facilities [gambling]; gaming hall services; amusement arcade services; games equipment rental; rental of gaming machines; providing amusement arcade services; rental of gaming machines with images of fruits; editing or recording of sounds and images; sound recording and video entertainment services; hire of sound reproducing apparatus; provision of gaming equipment for casinos; providing of casino facilities; online gambling services; casino, gaming and gambling services; provision of gaming facilities, gaming hall facilities, Internet casinos and online gambling services.

(260) AM 2023 120399 A
 (800) 1696219
 (151) 2022 10 04
 (891) 2022 10 04
 (731) Ficosota OOD
 bul. Madara 48, BG-9700 Shumen, Bulgaria
 (540)



(591) Black, white
 (531) 05.03.13; 05.03.14; 27.05.01; 27.05.04;
 27.05.19
 (511)
 3 – Bleaching preparations and other substances for laundry use; laundry glaze; laundry soaking preparations; fabric softeners for laundry use; colour-brightening chemicals for household purposes [laundry]; laundry balls filled with laundry detergents; laundry additives for water softening; rinsing agents for laundry; stain removing preparations for use on household goods; cleaning, polishing, scouring and abrasive preparations; colour-removing preparations; bleaching preparations [decolorants] for household purposes; dry-cleaning preparations; chemical cleaning preparations for household purposes; cleaning preparations for use on tiles; abrasives; polish for furniture and flooring; non-slipping liquids for floors; moist wipes for sanitary and cosmetic purposes; washing preparations; dishwashing detergents; bath soap; soaps in liquid form; cosmetics and cosmetic preparations; cleansing milk for toilet purposes.

5 – Baby diapers and napkins of paper and cellulose [disposable]; babies' diapers of cellulose or paper; babies' disposable diaper pants of paper; babies' diaper-pants; swim diapers, disposable, for babies; moist wipes impregnated with a pharmaceutical lotion; sanitizing wipes; tissues impregnated with insect repellants.

16 – Toilet paper; hygienic paper; household paper; paper napkins, paper face towels; paper bibs, paper handkerchiefs; tissues of paper for removing make-up.

(260) AM 2023 120400 A
 (800) 1696225
 (151) 2022 09 13
 (891) 2022 09 13
 (731) Biofarma
 50 rue Carnot, F-92284 Suresnes CEDEX,
 France
 (540)



(591) Dark blue PMS 287C, light blue PMS 2173C
 (531) 25.07.07; 26.05.01; 26.05.19; 27.05.01;
 29.01.04
 (511)
 5 – Pharmaceutical products; medical preparations; veterinary preparations; sanitary products for medicine; dietetic substances and foodstuffs for medical or veterinary use, food for babies; food supplements for humans and animals; plasters, materials for dressings; materials for dental fillings and dental impressions; disinfectants; products for destroying vermin; fungicides, herbicides.

(260) AM 2023 120402 A
 (800) 1696241
 (151) 2022 09 01
 (891) 2022 09 01
 (731) Noblewood Limited
 Arch. Makariou III, 206, CHRYSALIA
 COURT, 5TH Floor, CY-3030 Limassol,
 Cyprus
 (540)

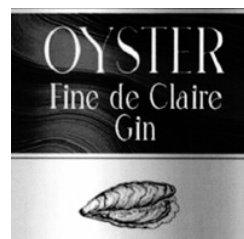

(591) Black, white
 (531) 03.09.18; 25.01.15; 25.05.02; 25.12.03;
 27.05.24
 (511)
 33 – Gin.

(260) AM 2023 120419 A
 (800) 1697028
 (151) 2022 09 23
 (891) 2022 09 23
 (731) OY Karl Fazer AB
 Fazerintie 6, FI-01230 Vantaa, Finland

(540)



(591) Gold

(531) 27.05.01; 29.01.02

(511)

30 – Coffee, tea, cocoa and their substitutes; rice, pasta and noodles; tapioca and sago; flour and cereal products; muesli, cereal and energy bars; chips [cereal products]; bread, pastry and confectionery; cakes; biscuits; waffles; pudding; pastilles, liquorice [confectionery]; nut confectionery; chocolate-covered nuts and almonds; chewing gum; chocolate; vegetable, cereal, oat and rice-based chocolate; chocolate substitutes; ice cream, sorbets and other edible ices; binding agents for ice cream; powders for making ice cream; sugar, honey, syrup; yeast, baking powder; salt, spices, preserved herbs; vinegar, sauces and other seasonings; ice (frozen water); baking preparations; flavouring substances, other than essential oils; aromatic preparations for cooking; chocolate and cocoa-based beverages.

(260) AM 2023 120420 A

(800) 1697031

(151) 2022 09 29

(891) 2022 09 29

(731) Emek Doğal Sağlık Ürünleri İklimlendirme Gıda İnşaat Sanayi Ve Ticaret Limited Şirketi
Fevziçakmak Mahallesi, Ayyıldız Caddesi,
G 46 B, Karatay, Konya, Türkiye

(540)



(591) Dark green, light green and white

(531) 26.01.19; 27.05.24; 29.01.12

(511)

29 – Meat, fish, poultry and game; processed meat products; prepared nuts and dried fruits as snacks; jams, tahini (sesame seed paste).

30 – Condiments for foodstuff, vanilla (flavoring), spices, sauces (condiments), tomato sauce; yeast, baking powder; molasses for food; halvah.

(260) AM 2023 120421 A

(800) 1018130

(151) 2009 08 12

(891) 2022 10 31

(731) Merz Pharma GmbH & Co. KGAA

Eckenheimer Landstrasse 100, 60318 Frankfurt, Germany

(540)

Bocouture

(591) Black, white

(511)

3 – Cosmetics.

5 – Pharmaceutical products and sanitary preparations; medical products for utilization in aesthetical dermatology, namely gel-preparations to be injected under the skin.

(260) AM 2023 120423 A

(800) 1151886

(151) 2013 02 19

(891) 2022 10 27

(731) OY Karl Fazer AB

Fazerintie 6, FI-01230 Vantaa, Finland

(540)

FAZERMINT

(591) Black, white

(511)

30 – Coffee, tea, cocoa, sugar, rice, tapioca, sago, artificial coffee; flour and preparations made from cereals, bread, pastry and confectionery, ices; honey, treacle; yeast, baking-powder; salt, mustard; vinegar, sauces (condiments); spices; ice; chewing gum; chocolate.

(260) AM 2023 120424 A

(800) 1223763

(151) 2014 06 09

(891) 2022 10 17

(731) The Little Greene Paint Company Limited
The Coachworks, 420 Ashton Old Road,
Openshaw, Manchester M11 2DT, United Kingdom

(540)

LITTLE GREENE

(591) Black, white

(511)

2 – Paints, coatings, colorants, varnishes, lacquers; thinners, colouring matters, all being additives for paints, varnishes or lacquers; preservatives against rust and against deterioration of wood; priming preparations (in the nature of paints); wood stains; mastic; repositionable patches of paint, varnishes or lacquers.

(260) AM 2023 120426 A

(800) 1282764

(151) 2015 09 09

(891) 2022 10 20

(731) Roland Mouret (HK) Limited

Room 1005, 10/F., New Treasure Centre,
10 Ng Fong Street, San Po Kong, Kowloon,
Hong Kong, China

(540)

ROLAND MOURET

(591) Black, white

(511)

18 – Leather and imitations of leather, and goods made of these materials and not included in other classes; bags, briefcases, card cases, suitcases, handbags, wallets, purses, suitcases, credit cards holders, diary cases, hat boxes, key cases, straps, luggage labels, sport bags, all made of leather or imitations of leather; animal skins, hides; trunks and travelling bags; umbrellas, parasols and walking sticks; whips, harness and saddlery.

25 – Clothing, footwear, headgear; boots; shoes; slippers; neckwear; underclothing; sleeping garments; stockings, tights, socks; aprons, smocks; baby pants; bibs of textile; swimwear; gloves; mittens; layettes; scarves, sashes and shawls; bathing caps; belts; braces; suspenders; collars, cuffs; ear muffs; fittings for boots and shoes; gaiters; garters.

35 – Retail services connected with beauty products, perfumes, toiletries, candles and ancillary goods, deodorising and scenting air freshener preparations other than for personal use, hand tools and hand instruments, cutlery, optical goods, spectacles, spectacle frames, lenses, spectacle boxes and sunglasses, electric and non-electric kitchen and bathroom appliances, household utensils, jewellery, horological and chronometric goods, printed matter, books, printed matter and periodical publications all relating to fashion design and home decoration, leather and imitations of leather, and goods made of these materials, home furnishings, clothing, footwear, headgear, haberdashery, carpets, rugs, straw mats, mats and matting, linoleum material for covering existing floors, wallpaper and non-textile wall hangings, ceiling paper, borders for decorating walls.

(260) AM 2023 120427 A

(800) 1425697

(151) 2018 06 22

(891) 2022 10 31

(731) Shenzhen Chuang Xin Wei Bicycle Co., LTD
Floor 1, 2 and 3, Building B, No. 10, Xingye
Second Road, Fenghuang Community,
Fuyong Street, Baoan District, Shenzhen,
Guangdong, China

(540)



(591) Black, white

(531) 26.13.25

(511)

12 – Motorcycles; bicycle frames; bicycles; electric bicycles; bicycle handlebars; rims for bicycle wheels; tricycles; mopeds; saddle covers for bicycles; electric mopeds.

(260) AM 2023 120428 A

(800) 1431951

(151) 2018 05 31

(891) 2022 11 02

(731) AG S.A.S. di Accossato Giovanni
Via Don Eugenio Bruno, 6, I-10029
Villastellone (TO), Italy

(540)

ACCOSSATO

(591) Black, white

(531) 27.05.17

(511)

6 – Duckboards of metal; ferrules of metal for handles.

7 – Pumps [machines]; driving devices for machines; pneumatic controls for motors; radiator caps for cooling radiators of engines; power transmission chains; radiators [cooling] for motors and engines; oil filters; oil pumps for use in motors and engines; air filters for mechanical purposes; air filters for motorcycle engines; forging moulds; valves; exhausts for motors and engines; toothed wheels for driving chains; gear wheels for machines; disc brakes for machines; anti-swinging brakes for grippers; oil tank plugs and caps [vehicle engine parts]; radiators [cooling] for motors and engines; radiator caps for cooling radiators of engines; oil tanks [vehicle engine parts]; oil coolers [vehicle engine parts]; expansion tanks [parts of cooling radiators for vehicle motors and engines]; pinions [other than for land vehicles]; gear levers other than for land vehicles; clutch levers, other than for land vehicles; cylinders for machines; pistons for cylinders; cylinders for motors and engines; cylinders being parts of machines; shock absorbing cylinders [parts of machines]; cylinder head gaskets; cylinder blocks [parts of machines]; engine cylinders for vehicles; cylinders being parts of machines; belts for machines; belts for motors and engines; power transmission belting for machines; driving belts, other than for land vehicles.

12 – Chainguards for vehicles; radiator grills of non-metallic materials for vehicles; speed gear levers for land vehicles; speed gear levers for land vehicles; clutch levers for land vehicles; main brake cylinders; main brake cylinders; brake cylinders for vehicles; wheel cylinders for vehicles; shock absorbing cylinders [parts of vehicles]; clutch cylinders for land vehicles; brake cylinders for land vehicles; belt pulleys for land vehicles; drive belts for driving land vehicles; transmission belts for land vehicles; brake calipers for vehicles; clutches for land vehicles; brake levers for vehicles; front spacers [parts of motorcycles]; head-

light mounts [parts of motorcycles]; handle bar grips [parts of motorcycles]; handle bar dampers [parts of motorcycles]; shift levers [parts of motorcycles]; handle bar control levers [parts of motorcycles]; handle-bar controls for mopeds; gear shift covers; motorcycle handlebars; twist grips for motorcycles; kickstands for motorcycles; brake discs for motorcycles; rearview mirrors; disc brake pads for land vehicles; brake pads for land vehicles; fork crown covers [bicycle parts]; wheel sprockets; sprockets for motorcycle drives; pinions for land vehicles; chains for bicycles, cycles; motorcycle chains; motorcycle chains; roller chains for motorcycles; chains for driving motorcycles; wheel trims; wheel rims for motorcycles; bicycles; direction signals for vehicles; direction indicators for bicycles; wheels; clutch mechanisms for motor cars; friction clutch driven plates for land vehicles; disc brake friction pads for vehicle braking systems; hub caps; vehicle brake discs; handlebars; tank waggons; parts and fittings for land vehicles; vehicles for use on land; brakes for land vehicles; differentials for land vehicles; gas caps for land vehicles; chainwheels for land vehicles; pedals for cycles; pedals for motorcycles; pedal driven land vehicles; vehicles for locomotion by land, air, water or rail; brake levers for cycles; parts and fittings for vehicles; parts and fittings for water vehicles.

(260) AM 2023 120430 A
 (800) 1620978
 (151) 2021 06 15
 (891) 2022 10 20
 (731) Novartis AG
 CH-4002 Basel, Switzerland
 (540)



(591) Yellow, dark pink and light pink
 (531) 26.13.25; 29.01.13
 (511)
 5 – Pharmaceutical preparations.

(260) AM 2023 120431 A
 (800) 1663279
 (151) 2022 05 03
 (891) 2022 11 03
 (731) Janssen Pharmaceutica NV
 Turnhoutseweg 30, B-2340 Beerse, Belgium
 (540)

RESVELDEN

(591) Black, white
 (511)
 5 – Vaccines.

(260) AM 2023 120538 A
 (800) 1698017
 (151) 2022 09 20
 (891) 2022 09 20
 (731) Limited Liability Company "Gexa-Nonwoven Materials"
 Tsentralnaya street, dom 3, litera A, A1, A2,
 a pomeschenie 304, d. Golievo, RU-143405
 g. Krasnogorsk, Moskovskaya oblast, Russian Federation

(540)

GEXA

(591) Black, white
 (531) 27.05.01
 (511)

5 – Bandages for dressings; bracelets impregnated with insect repellent; paper for mustard plasters; fly catching paper; reagent paper for veterinary purposes; reagent paper for medical purposes; mothproofing paper; antiseptic cotton; aseptic cotton; absorbent cotton; wadding for medical purposes; cotton for medical purposes; contraceptive sponges; corn rings for the feet; adhesive plasters; gauze for dressings; dressings, medical; surgical dressings; moleskin for medical purposes; fly glue; antiparasitic collars for animals; cotton sticks for medical purposes; nicotine patches for use as aids to stop smoking; eyepatches for medical purposes; poultices; compresses; scapulars for surgical purposes; babies' diapers; diapers for pets; swim diapers, reusable, for babies; swim diapers, disposable, for babies; diapers for incontinence; disposable absorbent mats for lining pet crates; diaper changing mats, disposable, for babies; disposable housebreaking pads for pets; bunion pads; breast-nursing pads; diagnostic strips for testing breast milk for medical purposes; collyrium; lead water; sanitary towels; panty liners [sanitary]; tissues impregnated with pharmaceutical lotions; cotton swabs for medical purposes; sanitary tampons; vulnerary sponges; pants, absorbent, for incontinence; sanitary panties; babies' diaper-pants.

10 – Physical exercise apparatus for medical purposes; body rehabilitation apparatus for medical purposes; dental apparatus and instruments; surgical apparatus and instruments; physiotherapy apparatus; nasal aspirators; trusses; maternity belts; support bandages; bandages, elastic; cupping glasses; ear plugs [hearing protection devices]; acupressure bands; bracelets for medical purposes; anti-nausea wristbands; anti-rheumatism bracelets; air cushions for medical purposes; vibromassage apparatus; surgical sponges; pill cutters; containers especially made for medical waste; clips, surgical; mirrors for dentists; mirrors for surgeons;

probes for medical purposes; urethral probes; orthopedic articles; pill crushers; biodegradable bone fixation implants; contraceptive implants; surgical implants comprised of artificial materials; inhalers; hydrogen inhalers; injectors for medical purposes; incubators for medical purposes; incubators for babies; obstetric apparatus; surgical cutlery; chambers for inhalers; cannulae; droppers for medical purposes; dropper bottles for medical purposes; catheters; draw-sheets for sick beds; enema apparatus for medical purposes; clips for dummies; menstrual cups; biomagnetic rings for therapeutic or medical purposes; teething rings; anti-rheumatism rings; abdominal corsets; corsets for medical purposes; crutches; haptic suits for medical purposes; waterbeds for medical purposes; air beds for medical purposes; beds specially made for medical purposes; lancets; kinesiology tapes; spoons for administering medicine; spoons for patients with tremor; sanitary masks; reusable sanitary masks made of gauze; masks for use by medical personnel; respiratory masks for artificial respiration; protective masks for medical purposes; anaesthetic masks; disposable steam-heated masks for therapeutic purposes; LED masks for therapeutic purposes; therapeutic facial masks; gum massagers for babies; suture materials; childbirth mattresses; air mattresses for medical purposes; furniture especially made for medical purposes; water bags for medical purposes; douche bags; breast pumps; urinals being vessels; portable hand-held urinals; teeth protectors for dental purposes; temperature indicator labels for medical purposes; knee bandages, orthopaedic; tips for crutches; fingerstalls for medical purposes; medical guidewires; thread, surgical; knives for surgical purposes; scissors for surgery; ambulance stretchers; stretchers, wheeled; boots for medical purposes; orthopaedic footwear; clothing especially for operating rooms; compression garments; blankets, electric, for medical purposes; supports for flat feet; cooling pads for first aid purposes; portable earpicks with endoscopy function; disposable steam-heated patches for therapeutic purposes; slings [support bandages]; gloves for massage; gloves for medical purposes; pessaries; ear picks; electric massage guns; cooling patches for medical purposes; spittoons for medical purposes; plaster bandages for orthopaedic purposes; orthopaedic bandages for joints; abdominal pads; cushions for medical purposes; pads for preventing pressure sores on patient bodies; air pillows for medical purposes; soporific pillows for insomnia; heating cushions, electric, for medical purposes; abdominal belts; galvanic belts for medical purposes; hypogastric belts; belts for medical purposes; orthopaedic belts; umbilical belts; belts, electric, for medical purposes; condoms; aerosol dispensers for medical purposes; esthetic massage apparatus; massage apparatus; veterinary apparatus and instruments; medical apparatus and instruments; urological apparatus and instruments; incontinence sheets; sterile sheets, surgical; surgical drapes; ice bags for medical purposes; toe se-

parators for orthopaedic purposes; surgical bougies; orthodontic rubber bands; ear trumpets; strait jackets; scalpels; tongue scrapers; dummies for babies; vaginal syringes; hearing protectors; contraceptives, non-chemical; orthopaedic soles; medical examination tables; commode chairs; basins for medical purposes; bed pans; instrument cases for use by doctors; arch supports for footwear; suspensory bandages; thermal packs for first aid purposes; walking sticks for medical purposes; quad canes for medical purposes; drainage tubes for medical purposes; capillary tubes for medical use; X-ray tubes for medical purposes; radium tubes for medical purposes; intrauterine devices; balling guns; patient examination gowns; wheeled walkers to aid mobility; walking frames for disabled persons; cases fitted for medical instruments; elastic stockings for surgical purposes; stockings for varices; splints, surgical; tongue depressors for medical purposes; syringes for injections; syringes for medical purposes; hypodermic syringes; uterine syringes; urethral syringes; forceps.

17 – Shock-absorbing buffers of rubber; fittings, not of metal, for compressed air lines; asbestos; cellulose acetate, semi-processed; balata; floating anti-pollution barriers; asbestos paper; paper for electrical capacitors; insulating paper; cotton wool for packing [caulking]; mineral wool [insulator]; asbestos felt; insulating felt; asbestos fibres; plastic fibres, other than for textile use; carbon fibres, other than for textile use; vulcanized fibre; gutta-percha; foam supports for flower arrangements [semi-finished products]; dielectrics [insulators]; lute; insulators; insulators for railway tracks; insulators for electric mains; insulators for cables; asbestos millboards; liquid rubber; synthetic rubber; rubber, raw or semi-worked; valves of india-rubber or vulcanized fibre; clack valves of rubber; rings of rubber; water-tight rings; insulating paints; insulating varnish; latex [rubber]; duct tapes; insulating bands; adhesive tapes, other than stationery and not for medical or household purposes; self-adhesive tapes, other than stationery and not for medical or household purposes; asbestos sheets; viscose sheets, other than for wrapping; foil of regenerated cellulose, other than for wrapping; insulating oils; insulating oil for transformers; reinforcing materials, not of metal, for pipes; weatherstripping compositions; caulking materials; brake lining materials, partly processed; sound-proofing materials; insulating materials; insulating refractory materials; padding materials of rubber or plastics; rubber material for recapping tyres; non-conducting materials for retaining heat; boiler composition to prevent the radiation of heat; packing [cushioning, stuffing] materials of rubber or plastics; sealant compounds for joints; filtering materials of semi-processed foams of plastic; filtering materials of semi-processed films of plastic; compositions to prevent the radiation of heat; bags [envelopes, pouches] of rubber, for packaging; pipe muffs, not of metal; rubber sleeves for protecting parts of machines; asbestos pac-

king; clutch linings; threads of plastic for soldering; plastic filaments for 3D printing; threads of plastic materials, other than for textile use; threads of rubber, other than for textile use; elastic yarns, other than for textile use; door stops of rubber; window stops of rubber; stops of rubber; dock bumpers of rubber; insulating gloves; plastic substances, semi-processed; plastic sheeting for agricultural purposes; plastic film, other than for wrapping; anti-glare films for windows [tinted films]; asbestos coverings; bark coverings for sound insulation; asbestos cloth; rubber stoppers; expansion joint fillers; cylinder jointings; washers of rubber or vulcanized fibre; pipe gaskets; draught excluder strips; gaskets; rubber solutions; gum, raw or semi-worked; mica, raw or partly processed; acrylic resins, semi-processed; synthetic resins, semi-processed; junctions, not of metal, for pipes; substances for insulating buildings against moisture; chemical compositions for repairing leaks; acrylic glass, semi-processed; organic glass, semi-processed; glass wool for insulation; fibreglass for insulation; asbestos fabrics; fibreglass fabrics for insulation; insulating fabrics; flexible hoses, not of metal; hoses of textile material; connecting hose for vehicle radiators; waterproof packings; rubber seals for jars; fittings, not of metal, for flexible pipes; fittings, not of metal, for rigid pipes; foils of metal for insulating; ebonite moulds; insulating inks; asbestos slate; slag wool [insulator]; watering hose; canvas hose pipes; cords of rubber; asbestos safety curtains; insulating plaster; ebonite.

19 – Aquaria [structures]; alabaster; door frames, not of metal; asbestos cement; asphalt; beams, not of metal; balustrades, not of metal; huts; swimming pools [structures], not of metal; silos, not of metal; harbours [structures], not of metal; concrete; bitumen; plastic landscape edgings; joists, not of metal; telephone booths, not of metal; beacons, not of metal, non-luminous; building paper; busts of stone, concrete or marble; bird baths [structures], not of metal; binding agents for making briquettes; binding material for road repair; stained-glass windows; felt for building; aviaries [structures], not of metal; gates, not of metal; diving boards, not of metal; geotextiles; gypsum [building material]; plaster; potters' clay; earth for bricks; clay; roofing shingles; gravel; aquarium gravel; granite; tar; armoured doors, not of metal; doors, not of metal; swing doors, not of metal; accordion doors, not of metal; folding doors, not of metal; coal tar; chimney pots, not of metal; prefabricated houses [kits], not of metal; parquet floor boards; floating floor boards, not of metal; memorial plaques, not of metal; wood for making household utensils; veneer wood; mouldable wood; chimney shafts, not of metal; jalousies, not of metal; roof gutters, not of metal; street gutters, not of metal; agglomerated bagasses of cane [building material]; road signs, non-luminous and non-mechanical, not of metal; non-luminous and non-mechanical signs, not of metal; limestone; lime; fences, not of metal; works of stonemasonry; works of art of stone,

concrete or marble; cabanas, not of metal; soundproof booths, transportable, not of metal; stone; rubble; artificial stone; building stone; paint spraying booths, not of metal; gravestones; reeds for building; horticultural frames, not of metal; framework, not of metal, for building; greenhouse frames, not of metal; cornices, not of metal; bitumen paper for building; wood pulp board for building; paperboard for building; skating rinks [structures], not of metal; quartz; caissons for construction work under water; bricks; firebricks; water-pipe valves, not of metal or plastic; drain traps [valves], not of metal or plastic; cask wood; mooring bollards, not of metal; cement posts; pillars, not of metal, for building; chimney cowls, not of metal; brackets, not of metal, for building; buildings, not of metal; buildings, transportable, not of metal; stringers [parts of staircases], not of metal; silica [quartz]; roofing, not of metal; roofing, not of metal, incorporating photovoltaic cells; manhole covers, not of metal; xylolith; chicken-houses, not of metal; manufactured timber; sawn timber; building timber; wood, semi-worked; staircases, not of metal; road marking sheets and strips of synthetic material; reinforcing materials, not of metal, for building; bituminous products for building; road coating materials; materials for making and coating roads; fireclay; pitch; building materials, not of metal; refractory construction materials, not of metal; masts [poles], not of metal; raw chalk; calcareous marl; mosaics for building; mouldings, not of metal, for building; marble; slate powder; porches [structures], not of metal; tombs, not of metal; flashing, not of metal, for building; roof flashing, not of metal; perches; duckboards, not of metal; wall claddings, not of metal, for building; mouldings, not of metal, for cornices; coatings [building materials]; tomb or grave enclosures, not of metal; grave or tomb enclosures, not of metal; laths, not of metal; wood panelling; wall linings, not of metal, for building; palings, not of metal; crash barriers, not of metal, for roads; latticework, not of metal; windows, not of metal; olivine for building; shuttering, not of metal, for concrete; posts, not of metal, for power lines; props, not of metal; rubber bearings for seismic isolation of buildings; branching pipes, not of metal; fair huts; tombs [monuments], not of metal; monuments, not of metal; acoustic panels, not of metal; wainscotting, not of metal; signalling panels, non-luminous and non-mechanical, not of metal; building panels, not of metal; parquet flooring; partitions, not of metal; lintels, not of metal; casement windows, not of metal; aquarium sand; play sand; silver sand; sand, except foundry sand; sandstone for building; tarred strips for building; planks of wood for building; rocket launching platforms, not of metal; platforms, prefabricated, not of metal; wall tiles, not of metal; floor tiles, not of metal; tiles, not of metal, for building; paving slabs, not of metal; cement slabs; grave slabs, not of metal; tile floorings, not of metal; slabs, not of metal, for building; scaffolding, not of metal; armour-plating, not of metal; asphalt pa-

ving; wood paving; paving blocks, not of metal; luminous paving blocks; macadam; fireproof cement coatings; bituminous coatings for roofing; roof coverings, not of metal; wooden floor boards; cladding, not of metal, for building; linings, not of metal, for building; fireplace mantles, not of metal; door panels, not of metal; floors, not of metal; sills, not of metal; porphyry [stone]; ceilings, not of metal; floating docks, not of metal, for mooring boats; agglomerated cork for building; window frames, not of metal; mortar for building; asbestos mortar; tanks of masonry; scantlings [carpentry]; furrings of wood; vinyl siding; pilings, not of metal; pigsties, not of metal; insect screens, not of metal; burial vaults, not of metal; schists; outdoor blinds, not of metal and not of textile; shutters, not of metal; statues of stone, concrete or marble; statuettes of stone, concrete or marble; alabaster glass; safety glass; glass granules for road marking; window glass for building; window glass, other than vehicle window glass; building glass; plate glass [windows] for building; insulating glass for building; enamelled glass, for building; tombstone stelae, not of metal; stables, not of metal; advertisement columns, not of metal; posts, not of metal; telegraph posts, not of metal; hips for roofing; stair-treads [steps], not of metal; tombstone plaques, not of metal; greenhouses, transportable, not of metal; terra-cotta [building material]; penstock pipes, not of metal; water-pipes, not of metal; gutter pipes, not of metal; ducts, not of metal, for ventilating and air-conditioning installations; drain pipes, not of metal; chimneys, not of metal; rigid pipes, not of metal, for building; sandstone pipes; turnstiles, not of metal; tufa; angle irons, not of metal; lengthening pieces, not of metal, for chimneys; bicycle parking installations, not of metal; plywood; figurines of stone, concrete or marble; flagpoles [structures], not of metal; foundry moulds, not of metal; rock crystal; cement for blast furnaces; cement for furnaces; magnesia cement; cement; pantiles, not of metal; roofing tiles, not of metal; slate; roofing slates; slag [building material]; slag stone; railway sleepers, not of metal; wood veneers; clinker ballast; concrete building elements; letter boxes of masonry.

20 – Picture frame brackets; recycling bins, not of metal; reels, not of metal, non-mechanical, for flexible hoses; sew-on tags of plastic or rubber for clothing; identification bracelets, not of metal; bolsters; screws, not of metal; removable covers for sinks; collars, not of metal, for fastening pipes; signboards of wood or plastics; nuts, not of metal; curtain holders, not of textile material; dowels, not of metal; kennels for household pets; birdhouses; keyboards for hanging keys; plugs [dowels], not of metal; display boards; packaging containers of plastic; clips, not of metal, for cables and pipes; binding screws, not of metal, for cables; clips of plastic for sealing bags; rivets, not of metal; locks, not of metal, for vehicles; padlocks, other than electronic, not of metal; locks, other than electric, not of metal; door bolts, not of metal; closures, not of me-

tal, for containers; latches, not of metal; numberplates, not of metal; wickerwork; hampers [baskets] for the transport of items; works of art of wood, wax, plaster or plastic; cabinet work; drain traps [valves] of plastic; water-pipe valves of plastic; valves, not of metal, other than parts of machines; plastic keys; mats for infant playpens; reusable baby changing mats; sleeping pads; mats, removable, for sinks; tent pegs, not of metal; waste dumpsters, not of metal, other than for medical use; containers, not of metal [storage, transport]; floating containers, not of metal; tool boxes, not of metal, empty; taps, not of metal, for casks; brackets, not of metal, for furniture; sash fasteners, not of metal, for windows; beds for household pets; nesting boxes for household pets; ladders of wood or plastics; furniture; runners, not of metal, for sliding doors; house numbers, not of metal, non-luminous; door stops, not of metal or rubber; window stops, not of metal or rubber; stakes, not of metal, for plants or trees; pet cushions; cushions for lining pet crates; bedding, except linen; sealing caps, not of metal; drawer organizers; reservoirs, not of metal nor of masonry; fodder racks; curtain rollers; door handles, not of metal; knobs, not of metal; vats, not of metal; honeycombs; plugs, not of metal; steps [ladders], not of metal; step stools, not of metal; placards of wood or plastics; nameplates, not of metal; door fasteners, not of metal; window fasteners, not of metal; window closers, not of metal, non-electric; door openers, not of metal, non-electric; window openers, not of metal, non-electric; winding spools, not of metal, non-mechanical, for flexible hoses; furniture fittings, not of metal; window fittings, not of metal; garment covers [storage]; hinges, not of metal; poles, not of metal; sneeze guards; labels of plastic; boxes of wood or plastic.

21 – Bird baths; pails; flower pots; sponges for household purposes; holders for flowers and plants [flower arranging]; containers for household or kitchen use; heat-insulated containers; ceramics for household purposes; cleaning instruments, hand-operated; flower-pot covers, not of paper; cages for household pets; birdcages; cages for collecting insects; disposable aluminium foil containers for household purposes; feeding troughs; watering cans; insect traps; material for brush-making; tablemats, not of paper or textile; brooms; isothermic bags; nozzles for watering cans; pouring spouts; nozzles for watering hose; fibreglass thread, other than for textile use; sprinklers; syringes for watering flowers and plants; oven mitts; animal grooming gloves; gloves for household purposes; polishing gloves; gardening gloves; barbecue mitts; dripping pans; drinking troughs; potholders; clothes-pegs; combs; sifters [household utensils]; broom handles; blenders, non-electric, for household purposes; scoops for household purposes; fused silica [semi-worked product], other than for building; plate glass [raw material]; glass, unworked or semi-worked, except building glass; glass wool, other than for insulation; vitreous silica fibres, other than for textile use; fire-

lass, other than for insulation or textile use; indoor terrariums [plant cultivation]; indoor terrariums [vivariums]; electric devices for attracting and killing insects; watering devices; ultrasonic pest repellents; utensils for household purposes; kitchen utensils; mops; animal bristles [brushware]; brushes; barbecue tongs; decanter tags; nest eggs, artificial; window-boxes.

22 – String; tarpaulins; wadding for padding and stuffing upholstery; wadding for filtering; ropes; hemp fibres; carbon fibres for textile use; coconut fibre; plastic fibres for textile use; jute; ropes, not of metal; strips for tying-up vines; ladder tapes for Venetian blinds; wrapping or binding bands, not of metal; padding materials, not of rubber, plastics, paper or cardboard; packing [cushioning, stuffing] materials, not of rubber, plastics, paper or cardboard; bags [envelopes, pouches] of textile, for packaging; binding thread, not of metal, for agricultural purposes; thread, not of metal, for wrapping or binding; braces, not of metal, for handling loads; bindings, not of metal; tents; purse seines; straps, not of metal, for handling loads; hemp bands; nets; sisal; sheaf-binding yarns; outdoor blinds of textile; vitreous silica fibres for textile use; glass fibres for textile use; slings, not of metal, for handling loads; cables ties, not of metal; raw fibrous textile; awnings of synthetic materials; awnings of textile; network; cables, not of metal; dust sheets; cords for hanging pictures; sash cords; pig bristles.

24 – Frieze [cloth]; banners of textile or plastic; velvet; household linen; diapered linen; bath linen, except clothing; bed linen; table linen, not of paper; sew-on tags of textile for clothing; adhesive tags of textile for bags; cot bumpers [bed linen]; buckram; fustian; sleeping bag liners; felt; bunting of textile or plastic; gauze [cloth]; damask; jersey [fabric]; table runners, not of paper; drugget; shower curtains of textile or plastic; curtains of textile or plastic; net curtains; zephyr [cloth]; canvas for tapestry or embroidery; dimity; bolting cloth; mats of textile for beer glasses; baby buntings; crepe [fabric]; crepon; marabouts [cloth]; furniture coverings of textile; fabrics for textile use; filtering materials of textile; wall hangings of textile; non-woven textile fabrics; plastic material [substitute for fabrics]; textile material; tablemats of textile; bivouac sacks being covers for sleeping bags; sleeping bags; sleeping bags for babies; moleskin [fabric]; muslin fabric; pillowcases; mattress covers; bed blankets; blankets for household pets; brocades; diaper changing cloths for babies; handkerchiefs of textile; picnic blankets; travelling rugs [lap robes]; coasters of textile; bed valances; linings [textile]; hat linings, of textile, in the piece; curtain holders of textile material; bed covers; bed covers of paper; furniture coverings of plastic; face towels of textile; dish towels; towels of textile; tea towels; hemp cloth; gummed cloth, other than for stationery purposes; printers' blankets of textile; cloth; door curtains; bedsheets; eiderdowns [down coverlets]; bath mitts; shrouds; glass

cloths [towels]; cloths for removing make-up; place mats of textile; table napkins of textile; mosquito nets; calico; oilcloth for use as tablecloths; tablecloths, not of paper; billiard cloth; taffeta [cloth]; ticks [mattress covers]; tick [linen]; lingerie fabric; fabric, impervious to gases, for aeronautical balloons; jute fabric; fabric for footwear; ramie fabric; esparto fabric; rayon fabric; fibreglass fabrics for textile use; adhesive fabric for application by heat; linen cloth; upholstery fabrics; hemp fabric; lining fabric for footwear; reusable wax coated fabrics for wrapping food; traced cloths for embroidery; chenille fabric; printed calico cloth; knitted fabric; cotton fabrics; silk fabrics for printing patterns; woollen cloth; elastic woven fabrics; fabric; fabric imitating animal skins; haircloth [sackcloth]; cheese cloth; tulle; flags of textile or plastic; flannel [fabric]; trellis [cloth]; covers for cushions; fitted toilet lid covers of fabric; covers [loose] for furniture; pillow shams; cheviots [cloth]; silk [cloth]; labels of textile.

25 – Underwear; sweat-absorbent underwear; trousers; brassieres; adhesive bras; collars [clothing]; detachable collars; shirt yokes; waistcoats; sports jerseys; hosiery; pockets for clothing; scarves; cap peaks; visors being headwear; tights; combinations [clothing]; suits; headscarves; jackets [clothing]; leggings [trousers]; camisoles; sports singlets; cuffs; face coverings [clothing], not for medical or sanitary purposes; sleep masks; bibs, not of paper; bibs, sleeved, not of paper; hairdressing capes; heel protectors for shoes; ear muffs [clothing]; sweat-absorbent socks; footwear; paper clothing; outerclothing; ready-made clothing; latex clothing; waterproof clothing; clothing incorporating LEDs; sportswear incorporating digital sensors; uniforms; clothing; clothing containing slimming substances; overcoats; knickers; parkas; pelerines; gloves [clothing]; warm gloves for touchscreen devices; pyjamas; headscarfs; scarfs; dresses; headbands [clothing]; garters; ready-made linings [parts of clothing]; dress shields; soles for footwear; girdles; belts [clothing]; sashes for wear; money belts [clothing]; layettes [clothing]; non-slipping devices for footwear; shirts; wooden shoes; sandals; bath sandals; boots; inner soles; bath slippers; knitwear [clothing]; underpants; slippers; shoes; headwear; aprons [clothing]; tee-shirts; rash guards; dressing gowns; tips for footwear; stockings; sweat-absorbent stockings; paper hats [clothing]; shower caps; bathing caps.

35 – Arranging subscriptions to telecommunication services for others; import-export agency services; commercial information agency services; advertising agency services; cost price analysis; rental of cash registers; rental of office equipment in co-working facilities; rental of advertising space; business auditing; financial auditing; business intermediary services relating to the matching of potential private investors with entrepreneurs needing funding; employment ag-

ency services; computerized file management; book-keeping; invoicing; demonstration of goods; transcription of communications [office functions]; opinion polling; market studies; business investigations; business research; marketing research; personnel recruitment; business management and organization consultancy; business organization consultancy; business management consultancy; personnel management consultancy; professional business consultancy; consultancy regarding advertising communication strategies; consultancy regarding public relations communication strategies; layout services for advertising purposes; marketing; marketing in the framework of software publishing; influencer marketing; targeted marketing; business management of performing artists; business management of sports people; writing of curriculum vitae for others; writing of publicity texts; scriptwriting for advertising purposes; news clipping services; updating and maintenance of information in registries; updating and maintenance of data in computer databases; updating of advertising material; word processing; online retail services for downloadable and pre-recorded music and movies; online retail services for downloadable ring tones; online retail services for downloadable digital music; organization of exhibitions for commercial or advertising purposes; arranging newspaper subscriptions for others; arranging subscriptions to electronic toll collection [ETC] services for others; organization of fashion shows for promotional purposes; organization of trade fairs; shop window dressing; business appraisals; preparation of business profitability studies; payroll preparation; data search in computer files for others; sponsorship search; administrative assistance in responding to calls for tenders; business management assistance; commercial or industrial management assistance; commercial intermediation services; providing business information; providing business information via a website; providing commercial and business contact information; providing telephone directory information; providing commercial information and advice for consumers in the choice of products and services; provision of an online marketplace for buyers and sellers of goods and services; providing user reviews for commercial or advertising purposes; web indexing for commercial or advertising purposes; providing user rankings for commercial or advertising purposes; presentation of goods on communication media, for retail purposes; media relations services; auctioneering; conducting of commercial events; economic forecasting; sales promotion for others; promotion of goods and services through sponsorship of sports events; promotion of goods through influencers; production of telemarketing programmes; production of advertising films; office machines and equipment rental; rental of advertising time on communication media; publicity material rental; rental of billboards [advertising boards]; rental of vending machines; rental of sales stands; rental of photocopying machines; consumer

profiling for commercial or marketing purposes; publication of publicity texts; radio advertising; development of advertising concepts; bill-posting; distribution of samples; dissemination of advertising matter; direct mail advertising; registration of written communications and data; advertising; online advertising on a computer network; outdoor advertising; advertising by mail order; television advertising; compilation of statistics; compilation of information into computer databases; business inquiries; systemization of information into computer databases; administrative services for medical referrals; corporate communications services; negotiation of business contracts for others; negotiation and conclusion of commercial transactions for third parties; compiling indexes of information for commercial or advertising purposes; tax preparation; drawing up of statements of accounts; telemarketing services; psychological testing for the selection of personnel; interim business management; outsourced administrative management for companies; business management of hotels; business management for freelance service providers; business project management services for construction projects; commercial administration of the licensing of the goods and services of others; business management of reimbursement programmes for others; computerized management of medical records and files; administration of consumer loyalty programs; administration of frequent flyer programs; administrative processing of purchase orders; administrative services for the relocation of businesses; public relations; commercial lobbying services; competitive intelligence services; business consulting services for digital transformation; advisory services for business management; lead generation services; modelling for advertising or sales promotion; typing; online ordering services in the field of restaurant take-out and delivery; market intelligence services; appointment reminder services [office functions]; data processing services [office functions]; website traffic optimization; wholesale services for pharmaceutical, veterinary and sanitary preparations and medical supplies; appointment scheduling services [office functions]; tax filing services; search engine optimization for sales promotion; retail services for works of art provided by art galleries; retail services for pharmaceutical, veterinary and sanitary preparations and medical supplies; retail services relating to bakery products; gift registry services; price comparison services; business intermediary services relating to the matching of various professionals with clients; reception services for visitors [office functions]; pay per click advertising; advertising services to create brand identity for others; secretarial services; procurement services for others [purchasing goods and services for other businesses]; shorthand; outsourcing services [business assistance]; telephone answering for unavailable subscribers; telephone switchboard services; photocopying services; business efficiency expert services.

39 – Air transport; motor coach rental; boat rental; garage rental; rental of vehicle roof racks; aircraft rental; parking place rental; rental of warehouses; rental of tractors; rental of electric wine cellars; booking of seats for travel; travel reservation; transport reservation; towing; vehicle breakdown towing services; bottling services; water distribution; water supplying; delivery of newspapers; message delivery; parcel delivery; delivery of goods; delivery of goods by mail order; flower delivery; replenishment of vending machines; launching of satellites for others; transportation logistics; cloakroom services; rescue operations [transport]; locating and tracking of people and cargo for transportation purposes; arranging of cruises; arranging of passenger transportation services for others via an online application; arranging of transportation for travel tours; arranging for travel visas and travel documents for persons travelling abroad; armoured-car transport; hauling; carting; transport and storage of waste; transporting furniture; lighterage services; ferry-boat transport; removal services; transport of travellers; guarded transport of valuables; bus transport; car transport; barge transport; boat transport; railway transport; marine transport; passenger transport; river transport; ambulance transport; tram transport; portorage; piloting of civilian drones; refloating of ships; cash replenishment of automated teller machines; shipbrokerage; transport brokerage; freight brokerage; providing driving directions for travel purposes; providing traffic information; providing information relating to storage services; providing transportation information; car rental; railway truck rental; rental of diving bells; rental of diving suits; rental of motor racing cars; rental of aircraft engines; rental of safety seats for children, for vehicles; rental of photography drones; rental of surveillance drones; railway coach rental; rental of storage containers; rental of wheelchairs; rental of horses for transportation purposes; rental of freezers; rental of navigational systems; rental of security drones; refrigerator rental; vehicle rental; rental of storage lockers; stevedoring; unloading cargo; electricity distribution; distribution of energy; packaging of goods; collection of domestic and industrial waste and trash; collection of recyclable goods [transport]; carpooling services; ice-breaking; piloting; escorting of travellers; cable car transport; transport by pipeline; wrapping of goods; operating canal locks; car parking; parking lot services; chauffeur services; pleasure boat transport; car sharing services; courier services [messages or merchandise]; salvaging; salvage of ships; services for transporting legal documents; gift wrapping; underwater salvage; taxi transport; transport; transport services for sightseeing tours; luggage storage; franking of mail; freight [shipping of goods]; freighting; physical storage of electronically stored data or documents; temporary storage of keys; boat storage; storage of goods; storage; freight forwarding.

41 – Academies [education]; rental of indoor aquaria; rental of artwork; rental of movie props; rental of sports grounds; rental of tennis courts; mobile library services; lending library services; booking of seats for shows; videotaping; physical education; production of music; discotheque services; animal training; dubbing; publication of books; research in the field of education; escape room [entertainment]; film distribution; movie studio services; health club services [health and fitness training]; nightclub services [entertainment]; layout services, other than for advertising purposes; microfilming; videotape editing; production of radio and television programmes; screenplay writing; music education; religious education; aikido instruction; gymnastic instruction; judo instruction; correspondence courses; practical training [demonstration]; training services provided via simulators; organization of balls; organization of exhibitions for cultural or educational purposes; providing recreation facilities; arranging and conducting of colloquiums; arranging and conducting of congresses; arranging and conducting of conferences; arranging and conducting of concerts; arranging and conducting of workshops [training]; arranging and conducting of in-person educational forums; arranging and conducting of seminars; arranging and conducting of symposiums; arranging and conducting of sports events; organization of competitions [education or entertainment]; arranging of beauty contests; organization of cosplay entertainment events; organization of lotteries; organization of fashion shows for entertainment purposes; organization of entertainment events; organization of electronic sports competitions; organization of shows [impresario services]; organization of sports competitions; vocational guidance [education or training advice]; amusement park services; sign language interpretation; language interpretation; transfer of business knowledge and know-how [training]; know-how transfer [training]; television entertainment; vocational retraining; directing of shows; providing online videos, not downloadable; providing information in the field of education; providing information relating to recreational activities; providing information in the field of entertainment; providing museum facilities; providing online music, not downloadable; providing television programmes, not downloadable, via video-on-demand services; providing films, not downloadable, via video-on-demand services; providing user reviews for entertainment or cultural purposes; providing golf facilities; providing user rankings for entertainment or cultural purposes; providing sports facilities; providing amusement arcade services; cinema presentations; providing online electronic publications, not downloadable; presentation of circus performances; presentation of variety shows; presentation of live performances; theatre productions; presenting museum exhibitions; conducting of entertainment events; conducting guided climbing tours; conducting fitness classes; educational examination; production of pod-

casts; film production, other than advertising films; rental of audio equipment; rental of video cameras; rental of video cassette recorders; rental of videotapes; rental of show scenery; rental of sound recordings; toy rental; rental of cinematographic apparatus; rental of motion pictures; games equipment rental; rental of stadium facilities; rental of lighting apparatus for theatrical sets or television studios; rental of radio and television sets; rental of skin diving equipment; rental of sports equipment, except vehicles; rental of stage scenery; rental of training simulators; rental of electronic book readers; electronic desktop publishing; online publication of electronic books and journals; publication of texts, other than publicity texts; radio entertainment; entertainment services; writing of texts; sado instruction [tea ceremony instruction]; zoological garden services; educational certification services, namely, providing training and educational examination; news reporters services; film directing, other than advertising films; party planning [entertainment]; music composition services; captioning; subtitling; tutoring; entertainer services; holiday camp services [entertainment]; gambling services; e-sports services; video editing services for events; video imaging services by drone; conducting guided tours; disc jockey services; sound engineering services for events; game services provided online from a computer network; games library services; personal trainer services [fitness training]; providing casino facilities [gambling]; calligraphy services; karaoke services; songwriting; cultural, educational or entertainment services provided by art galleries; multimedia library services; modelling for artists; teaching; educational services provided by special needs assistants; educational services provided by schools; orchestra services; translation; scriptwriting, other than for advertising purposes; physical fitness assessment services for training purposes; face painting; ticket agency services [entertainment]; educational examination for users to qualify to pilot drones; coaching [training]; lighting technician services for events; sport camp services; recording studio services; photographic imaging services by drone; nursery schools; photography; photographic reporting; timing of sports events; boarding school education; production of shows.

42 – Water analysis; computer system analysis; handwriting analysis [graphology]; chemical analysis; rental of data centre facilities; rental of meters for the recording of energy consumption; energy auditing; geological test drilling; recovery of computer data; quantum computing; business card design; graphic design of promotional materials; interior design; industrial design; graphic arts design; computer virus protection services; oil-field surveys; geological surveys; geotechnical investigations; engineering; installation of computer software; meteorological information; clinical trials; material testing; textile testing; bacteriological research; biological research; geological research; research in the field of environmental protection; cos-

metic research; mechanical research; research in the field of welding; research in the field of building construction; research in the field of telecommunications technology; research in the field of artificial intelligence technology; research in the field of physics; chemical research; research and development of new products for others; medical research; scientific and technological research relating to patent mapping; scientific and technological research in the field of natural disasters; scientific research; analysis for oil-field exploitation; underwater exploration; research in the field of excavation; technological research; calibration [measuring]; website design consultancy; computer security consultancy; information technology [IT] consultancy; artificial intelligence consultancy; computer technology consultancy; consultancy in the design and development of computer hardware; architectural consultancy; internet security consultancy; computer software consultancy; telecommunication network security consultancy; data security consultancy; technological consultancy; oil-well testing; quality control; vehicle roadworthiness testing; culturing of cells for scientific research purposes; cryptomining; land surveying; dress designing; updating of computer software; monitoring of computer systems to detect breakdowns; monitoring of computer systems for detecting unauthorized access or data breach; monitoring of computer systems by remote access; electronic monitoring of credit card activity to detect fraud via the internet; electronic monitoring of personally identifying information to detect identity theft via the internet; writing of computer code; software as a service [SaaS]; maintenance of computer software; authenticating works of art; design of show scenery; design of interior decor; quality evaluation of standing timber; quality evaluation of wool; digitization of documents [scanning]; conversion of data or documents from physical to electronic media; urban planning; platform as a service [PaaS]; providing virtual computer systems through cloud computing; providing online geographic maps, not downloadable; providing geographic information; providing information relating to computer technology and programming via a website; providing scientific information, advice and consultancy relating to carbon offsetting; providing search engines for the internet; conversion of computer programs and data, other than physical conversion; conducting technical project studies; computer system design; golf course design; rental of web servers; computer rental; rental of computer software; design of prototypes; unlocking of mobile phones; geological prospecting; oil prospecting; hosting computer websites; server hosting; development of video and computer games; development of computer platforms; construction drafting; computer software design; software development in the framework of software publishing; cloud seeding; digital forensic investigations in the field of computer crimes; user authentication services using blockchain

technology; consultancy in the field of energy-saving; creating and designing website-based indexes of information for others [information technology services]; creating and maintaining websites for others; computer graphic design for video projection mapping; design of computer-simulated models; design of costumes; computer programming; technical writing; duplication of computer programs; architectural services; information technology services provided on an outsourcing basis; chemistry services; packaging design; off-site data backup; computer programming services for data processing; telecommunications technology consultancy; scientific laboratory services; user authentication services using single sign-on technology for online software applications; user authentication services using technology for e-commerce transactions; cartographic or thermographic measurement services by drone; weather forecasting; logo design services; styling [industrial design]; cartography services; software engineering services for data processing; exploration services in the field of the oil, gas and mining industries; technological consulting services for digital transformation; data encryption services; electronic data storage; surveying.

(260) AM 2023 120551 A
 (800) 1698453
 (151) 2022 10 21
 (891) 2022 10 21
 (731) Honor Device Co., Ltd.
 Suite 3401, Unit A, Building 6, Shum Yip
 Sky Park, No. 8089, Hongli West Road,
 Xiangmihu Street, Futian District, Shenzhen,
 518040 Guangdong, China

(540)

HONOR C1

(591) Black, white
 (511)
 9 – Data processing apparatus; computer peripheral devices; downloadable software applications for mobile phones; computer software, recorded; microprocessors; processors [central processing units]; integrated circuit cards [smart cards]; notebook computers; tablet computers; smart glasses; smart watches; smart rings; chip cards; microchip cards; chip card readers; facial recognition apparatus; bathroom scales; smartphones; network communication apparatus; navigational instruments; global positioning system [GPS] apparatus; network routers; wearable activity trackers; cabinets for loudspeakers; television apparatus; headphones; car video recorders; cameras [photography]; sensors; DNA chips; integrated chip (IC) voice recorders; surveying apparatus and instruments; connected bracelets [measuring instruments]; semiconductor chips; computer chips; computer chipsets; microchips; multiprocessor chips; microchips [computer hardware]; HD integrated graphics chip; biochip sensors; el-

ectronic chips for the manufacture of integrated circuits; chips [integrated circuits]; electronic chips; digital door locks; biometric fingerprint door locks; 3D spectacles; portable power supplies (rechargeable batteries); smart cards [integrated circuit cards].

(260) AM 2023 120552 A
 (800) 1698479
 (151) 2022 10 28
 (891) 2022 10 28
 (731) Kunshan Hongjie Electronics Co., LTD
 1050 Fu Chun Jiang Road, Economic
 Development Zone, Kunshan City, 215333
 Jiangsu Province, China

(540)



(591) Black, white
 (531) 26.01.03; 26.01.18; 27.05.10; 27.05.17;
 27.05.22

(511)
 9 – Stands adapted for tablet computers; stands adapted for laptops; carriers adapted for computers; cabinets adapted for computers; computer peripheral devices; carriers adapted for computer monitors; mounting stands adapted for computer hardware; carriers adapted for slides.

(260) AM 2023 120553 A
 (800) 1698480
 (151) 2022 10 28
 (891) 2022 10 28
 (731) Opple Lighting Co., LTD.
 Rm. 411, Building 1, No. 6111, Longdong
 Avenue, Pudong New District, Shanghai,
 China

(540)

OPPLE

(591) Black, white
 (531) 27.05.01
 (511)
 35 – Outdoor advertising; television advertising; advertising; business organization consultancy; business and management consultancy; organization of exhibitions for commercial or advertising purposes; import-export agency services; sales promotion for others; intermediary services for others [purchasing goods and services for other businesses]; auctioneering; sponsorship search; presentation of goods on communication media, for retail purposes; business management consultancy; market studies; organization of trade fairs for commercial or advertising purposes; com-

mercial information and advice for consumers [consumer advice shop]; commercial administration of the licensing of the goods and services of others; procurement services for others [purchasing goods and services for other businesses]; marketing; employment agencies; administrative services for the relocation of businesses; secretarial services; accounting; rental of vending machines.

(260) AM 2023 120554 A

(800) 1698513

(151) 2022 09 19

(891) 2022 09 19

(731) E100 LV, SIA

Bauskas iela 58A – 13, Riga, LV-1004, Latvia

(540)



(591) Black, white

(531) 26.01.01; 26.01.03; 26.01.18; 27.05.24; 27.07.01; 27.07.11

(511)

9 – Magnetic data media; data processing apparatus; scanners [data processing equipment]; readers [data processing equipment]; holograms; disks, magnetic; magnetic encoders; identity cards, magnetic; encoded magnetic cards; computer operating programs, recorded; computer software, recorded; interfaces for computers; computer software platforms, recorded or downloadable; computer hardware; integrated circuit cards [smart cards]; optical character readers; downloadable graphics for mobile phones; downloadable image files; chips [integrated circuits].

35 – Advertising; commercial or industrial management assistance; computerized file management; commercial administration of the licensing of the goods and services of others; demonstration of goods; market studies; market intelligence services; provision of an online marketplace for buyers and sellers of goods and services; personnel management consultancy; business management consultancy; business organization consultancy; professional business consultancy; marketing; marketing in the framework of software publishing; updating and maintenance of data in computer databases; organization of exhibitions for commercial or advertising purposes; business appraisals; providing business information; providing business information via a website; negotiation and conclusion of commercial transactions for third parties; dissemination of advertising matter; pay per click advertising; compilation of information into computer databases; systemization of information into computer databases; procurement services for others [purchasing goods and services for other businesses]; tele-marketing services.

36 – Financing services; financial consultancy; debt advisory services.

37 – Vehicle service stations [refuelling and maintenance]; vehicle cleaning; vehicle washing.

39 – Providing traffic information; transportation logistics; transport brokerage; car parking; transport.

42 – Development of computer platforms; computer programming services for data processing; installation of computer software; information technology [IT] consultancy; data security consultancy; computer software consultancy; software as a service [SaaS]; maintenance of computer software; providing information on computer technology and programming via a website; software engineering services for data processing; creating and maintaining websites for others; electronic data storage.

(260) AM 2023 120555 A

(800) 1698582

(151) 2022 10 11

(891) 2022 09 05

(731) Chanel Sarl

Quai du Général-Guisan 24, CH-1204

Genève, Switzerland

(540)

COCO MADEMOISELLE

(591) Black, white

(511)

3 – Preparations for cosmetic use for skin, scalp, hair or nail care; preparations for cosmetic use for application on the skin, scalp, hair or nails; soaps; perfumery products; perfumes; perfumed sprays for indoor use; essential oils; cosmetics; artificial nails for cosmetic use; nail art stickers; adhesives for affixing artificial nails; toiletries for non-medical use; temporary tattoos for cosmetic use; air fragrances; talcum powder; deodorants / antiperspirants; potpourris [fragrances].

(260) AM 2023 120556 A

(800) 1698598

(151) 2022 05 04

(891) 2022 05 04

(731) Closed Joint Stock Company "Starodvorskie Kolbasy"

ul. Poliny Osipenko, d. 41, of. 210,

RU-600009 g. Vladimir, Russian Federation

(540)

Баварушка

(591) Black, white

(531) 28.05

(511)

29 – Preserved peppers; aloe vera prepared for human consumption; alginates for culinary purposes; anchovy, not live; peanuts, prepared; artichokes, preserved; albumen for culinary purposes; white of eggs; beans, preserved; soya beans, preserved, for food; broth; ginger jam; ham; fatty substances for the manufacture of edible fats; toasted laver; edible birds' nests; sea-cucumbers, not live; peas, preserved; mushrooms, preserved; guacamole; game, not live; gelatine; meat jellies; jellies for food; fruit jellies; yolk of eggs; coconut fat; bone oil for food; lard; suet for food; edible fats; curd; fruit-based snack food; milk substitutes; charcuterie; raisins; caviar; eggplant paste; vegetable marrow paste; fish roe, prepared; yogurt; galbi [grilled meat dish]; sauerkraut; kefir; kimchi; isinglass for food; clams, not live; potato-based dumplings; milk shakes; black pudding; onion rings; arrangements of processed fruit; compotes; meat, canned; vegetables, canned; fish, canned; fruits, canned; broth concentrates; corn dogs; gherkins; cutlets; frozen cutlets; shrimps, not live; prawns, not live; buttercream; croquettes; silkworm chrysalis for human consumption; sweet corn, processed; kumys; chicken wings; spiny lobsters, not live; lecithin for culinary purposes; salmon, not live; onions, preserved; margarine; marmalade; oils for food; peanut butter; cocoa butter for food; coconut oil for food; coconut butter; corn oil for food; sesame oil for food; linseed oil for food; extra virgin olive oil for food; olive oil for food; palm oil for food; palm kernel oil for food; sunflower oil for food; rape oil for food; butter; soya bean oil for food; mussels, not live; almonds, ground; animal marrow for food; mollusks, not live; milk; peanut milk; peanut milk for culinary purposes; coconut milk; coconut milk for culinary purposes; almond milk; almond milk for culinary purposes; oat milk; rice milk; rice milk for culinary purposes; protein milk; condensed milk; soya milk; powdered milk; fish meal for human consumption; vegetable mousses; fish mousses; fruit pulp; meat; meat, preserved; freeze-dried meat; chicken nuggets; milk beverages, milk predominating; peanut milk-based beverages; coconut milk-based beverages; almond milk-based beverages; edible insects, not live; sausage casings, natural or artificial; vegetables, preserved; freeze-dried vegetables; vegetables, dried; vegetables, cooked; potato fritters; olives, preserved; lobsters, not live; flavored nuts; candied nuts; coconut, desiccated; nuts, prepared; tomato paste; liver pâté; pectin for culinary purposes; liver; pickles; jams; powdered eggs; milk products; fish-based foodstuffs; soured milk; poultry, not live; breaded chicken pieces; bulgogi; pollen prepared as foodstuff; cranberry compote; tomato purée; apple purée; crayfish, not live; crustaceans, not live; fish, preserved; fish, not live; salted fish; fermented baked milk; vegetable salads; fruit salads; bacon; sardelki [sausages]; sardines, not live; pork; herrings, not live; seeds, prepared; sunflower seeds, prepared; cream [dairy products]; whipped

cream; vegetable-based cream; fat-containing mixtures for bread slices; smetana; lemon juice for culinary purposes; tomato juice for cooking; vegetable juices for cooking; salted meats; sausages; sausages in batter; hot dog sausages; preparations for making bouillon; preparations for making soup; nut-based spreads; tripe; soups; vegetable soup preparations; whey; cheese; tahini; tofu; truffles, preserved; tuna, not live; oysters, not live; falafel; milk ferments for culinary purposes; rennet; fish fillets; dates; frosted fruits; frozen fruits; fruit, preserved; fruit preserved in alcohol; fruit, stewed; hazelnuts, prepared; potato flakes; hummus; fruit peel; preserved garlic; lentils, preserved; potato chips; low-fat potato chips; fruit chips; shpikachki [sausages]; non-alcoholic eggnog; seaweed extracts for food; meat extracts; edible ant larvae, prepared; berries, preserved; snail eggs for consumption; eggs; yakitori.

(260) AM 2023 120557 A

(800) 1698626

(151) 2022 09 02

(891) 2022 09 02

(731) Guangdong Hua En Audio-video Technology Co., LTD.

Room 3, 5F Plant 2, V1 District 2, Enping Park, Jiangmen Industrial Transfer Park, Enping City, Jiangmen City, Guangdong Province, China

(540)

FBW

(591) Black, white

(511)

9 – Cabinets for loudspeakers; loudspeakers; audio and video-receivers; microphones; sound transmitting apparatus; horns for loudspeakers; headphones; equalizers [audio apparatus]; audio mixers.

(260) AM 2023 120639 A

(800) 1699718

(151) 2022 10 18

(891) 2022 10 18

(731) Qingzhou Tanboer Garment Co., Ltd.

No. 3588 Zhaode South Road, Qingzhou City, Weifang City, Shandong Province, China

(540)



(591) Black, white

(531) 24.01.03; 24.01.15; 27.05.21; 27.05.24

(511)
25 – Down garments; waterproof clothing; footwear; hats; hosiery; scarves.

(260) AM 2023 120640 A

(800) 1699724

(151) 2022 07 25

(891) 2022 07 25

(731) Euro Games Technology LTD.

4, "Maritsa" Str., "Vranya-Lozen-Triugulnika",
BG-1151 Sofia, Bulgaria

(540)



(591) Red, brown, yellow, orange, blue, white, black, pink and purple

(531) 01.15.09; 24.17.09; 24.17.25; 27.05.10;
29.01.15

(511)

9 – Software; computer gaming software; computer software packages; computer operating system software; computer software, recorded; software drivers; virtual reality software; games software; entertainment software for computer games; computer programs for network management; operating computer software for main frame computers; monitors (computer hardware); computer hardware; apparatus for recording images; monitors (computer programs); computer game programs; computer programs for recorded games; apparatus for recording, transmission or reproduction of sound or images; communications servers [computer hardware]; electronic components for gambling machines; computer application software featuring games and gaming; computer software for the administration of on-line games and gaming; computer hardware for games and gaming; computer hardware for games and gambling on the Internet and via computer telecommunication network; downloadable computer game software for gambling machines on the Internet and via telecommunication network.

28 – Gaming machines for gambling; chips for gambling; mah-jong; arcade games; gambling machines operating with coins, notes and cards; games; electronic games; parlor games; gaming chips; gaming tables; slot machines [gaming machines]; LCD game machines; slot machines and gaming devices; coin-operated amusement machines; roulette chips; poker chips; chips and dice [gaming equipment]; equipment for casinos; roulette tables; gaming roulette wheels; casino games; automats and gambling machines; coin-operated machines and/or electronic coin-operated machines with or without the possibility of gain; bo-

xes for coin-operated machines, slot machines and gaming machines; electronic or electrotechnical gaming devices, automats and machines, coin-operated machines; housings for coin-operated machines, gaming equipment, gaming machines, machines for gambling; electropneumatic and electrical gambling machines (slot machines).

41 – Gambling; services related to gambling; gaming services for entertainment purposes; casino, gaming and gambling services; training in the development of software systems; provision of gaming equipment for gambling halls; providing casino equipment [gambling]; gaming machine entertainment services; providing casino facilities [gambling]; providing halls with gaming machines; amusement arcade services; games equipment rental; rental of gaming machines; providing amusement arcade services; rental of gaming machines with images of fruits; editing or recording of sounds and images; sound recording and video entertainment services; hire of sound reproducing apparatus; provision of gaming equipment for casinos; providing of casino facilities; online gambling services; casino management services; operation of gaming establishments, gaming halls, internet casinos, online gambling sites.

(260) AM 2023 120641 A

(800) 1699756

(151) 2022 09 30

(891) 2022 09 30

(731) Asse Kozmetik Sanayi Ve Diş Ticaret Limited Şirketi
Muratbey Merkez Mah., Erikli Sk. 3 1, Çatalca,
İstanbul, Türkiye

(540)



(591) Black, white

(531) 01.15.21; 26.01.03; 26.01.24; 27.05.01;
27.05.09; 27.05.10

(511)

3 – Bleaching and cleaning preparations, detergents other than for use in manufacturing operations and for medical purposes, laundry bleach, fabric softeners for laundry use, stain removers, dishwasher detergents; perfumery; non-medicated cosmetics; fragrances; deodorants for personal use and animals; soaps; dental care preparations: dentifrices, denture polishes, tooth whitening preparations, mouth washes, not for medical purposes; abrasive preparations; emery cloth; sandpaper; pumice stone; abrasive pastes; polishing pre-

parations for leather, vinyl, metal and wood, polishes and creams for leather, vinyl, metal and wood, wax for polishing.

(260) AM 2023 120642 A
 (800) 1699777
 (151) 2022 09 23
 (891) 2022 09 23
 (731) Dongguan Hanhui Jingbo
 Technology Co., LTD
 Room 201, Building 2, No. 12, Huafu Road,
 Chang'an Town, Dongguan City, 523000
 Guangdong Province, China

(540)

(591) Black, white
 (531) 01.15.11; 26.11.02; 26.11.13; 27.05.01;
 27.05.08
 (511)
 34 – Cigarette tips; ashtrays for smokers; cigarette fil-
 ters; matches; electronic cigarettes; cigar cases; tobac-
 co pipes; lighters for smokers; snuff boxes; cigar hol-
 ders.

(260) AM 2023 120643 A
 (800) 1699783
 (151) 2022 09 21
 (891) 2022 09 21
 (731) Holcim AG
 Grafenauweg 10, CH-6300 Zug, Switzerland

(540)

(591) Black, white
 (511)
 3 – Cleaning and washing preparations and substan-
 ces for use on roofs; cleaning, polishing and scouring
 preparations for use in roofing.
 6 – Threaded fasteners of metal for use on roofs; me-
 tal fasteners, namely, screws, bars and plates used for
 fixing roof membranes and insulation products to roof
 supports.
 9 – Downloadable software for tracking and locating
 shipments and loads.
 20 – Threaded fasteners not of metal.
 21 – Waterproof plastic and rubber trays for plants on
 roofs.
 27 – Floor coverings; insulating floor coverings.
 35 – Preparation and concluding of commercial tran-
 sactions for third parties; import-export agency ser-
 vices.

36 – Extended warranty insurance services for roofing
 equipment and devices.
 39 – Transport and storage services for roofing mate-
 rials and building materials.

(260) AM 2023 120644 A
 (800) 1699816
 (151) 2022 09 20
 (891) 2022 09 20
 (731) Marie Claire Album
 10 boulevard des Frères Voisin, F-92130
 Issy-les-Moulineaux, France

(540)

(591) Black, white
 (531) 27.05.01
 (511)
 9 – Optical apparatus and instruments; eyewear;
 eyeglasses, sunglasses; spectacle cases, containers for
 contact lenses, spectacle frames.

(260) AM 2023 120645 A
 (800) 1699878
 (151) 2022 07 29
 (891) 2022 07 29
 (731) Euro Games Technology LTD.
 4, "Maritsa" Str., "Vranya-Lozen-Triugulnika",
 BG-1151 Sofia, Bulgaria

(540)

(591) Yellow, orange, red, blue and black
 (531) 27.05.02; 27.05.03; 27.07.02; 27.07.03;
 29.01.15
 (511)
 9 – Operating computer software for main frame co-
 mputers; monitors (computer hardware); computer
 hardware; apparatus for recording images; monitors
 (computer programs); computer game programs; re-
 corded computer game programs; apparatus for recor-
 ding, transmission or reproduction of sound or ima-
 ges; communications servers (computer hardware); el-
 ectronic components for gambling machines; compu-
 ter application software featuring games and gaming;
 computer software for the administration of on-line
 games and gaming; computer hardware for games and
 gaming; computer hardware for games and gambling
 on the Internet and via telecommunication network;
 downloadable computer game software for gambling
 machines on the Internet and via telecommunication
 network; computer systems; computer operating sys-
 tem software; computer terminals; interactive termi-
 nals; multimedia terminals; electronic terminals for
 generating lottery tickets; interactive touch screen ter-
 minals; computer touchscreens; electronic display
 panels; liquid crystal display screens; digital signage

display panels; multimedia software; multimedia apparatus and instruments; interactive multimedia software for playing games; computer screens; led large-screen displays; liquid crystal displays [leds] for home theatres; media streaming software; computer application software for streaming audio-visual media content via the Internet; software; computer gaming software; computer software packages; computer operating system software; computer software, recorded; software drivers; virtual reality software; games software; entertainment software for computer games; computer programs for network management; electronic lottery tickets; computer software platforms; operating systems; interactive computer systems; operating system programs; computer game software for use with on-line interactive games.

28 – Gaming machines for gambling; chips for gambling; mah-jong; arcade games; gambling machines operating with coins, notes and cards; games; electronic games; parlor games; gaming chips; gaming tables; slot machines [gaming machines]; LCD game machines; slot machines and gaming devices; coin-operated amusement machines: roulette chips; poker chips; chips and dice [gaming equipment]; gaming equipment for casinos; roulette tables; gaming roulette wheels; casino games; automats and gambling machines; coin-operated amusement machines and/or electronic coin-operated amusement machines with or without the possibility of gain; boxes for coin-operated amusement machines, slot machines and gaming machines; electronic or electrotechnical amusement machines and apparatus, gaming machines, coin-operated entertainment machines; housings for coin-operated amusement machines, gaming equipment, gaming machines, machines for gambling; electropneumatic and electrical gambling machines (slot machines); lottery games; electronic targets for games and sports.

41 – Gambling; entertainment services related to gambling; gaming services for entertainment purposes; casino, gaming and gambling services; training in the development of software systems; provision of gaming equipment for gambling halls; providing casino equipment [gambling]; gaming machine entertainment services; providing casino facilities [gambling]; gaming hall services; games equipment rental; rental of gaming machines; providing amusement arcade services; rental of gaming machines with images of fruits; editing or recording of sounds and images; sound recording and video entertainment services; hire of sound reproducing apparatus; provision of gaming equipment for casinos; providing of casino facilities; online gambling services: casino services; provision of gaming facilities and gaming hall facilities, Internet casinos and online gambling services; lottery services; organization of lotteries; provision of games by means of a computer based system; online interactive entertainment; on-line casino services; online

game services through mobile devices; providing on-line entertainment in the nature of game tournaments; providing on-line information in the field of computer gaming entertainment; sports betting services: online sports betting services; providing online games and games of chance, in particular using non-downloadable gaming software.

(260) AM 2023 120684 A

(800) 1700673

(151) 2022 08 18

(891) 2022 08 18

(731) Aeroports De Paris

1 rue de France, F-93290 TREMBLAY-EN-FRANCE, France

(540)



(591) Green

(531) 25.05.02; 26.04.02; 26.04.03; 26.04.08; 26.04.12; 29.01.03

(511)

9 – Software; application software; data processing software; software for creating, managing, updating and using databases; software and applications in the field of transport and indication of routes, parking, booking of services for people, booking of catering services; automatic dispensers for tickets, cards, passenger tickets; equipment for data processing and computers; multimedia terminals; magnetic or optical data media; recording media for sound, images and data, in particular, sound recording disks, compact disks (audio, video, multimedia); memory or microprocessor or magnetic or chip cards, bank cards; automatic access control apparatus; magnetic and electronic access cards, magnetic and electronic traffic cards for transport networks.

35 – Administrative management of airports; organizational management of airports; assistance with the management of business activities; commercial management of shops at airports; recruitment of ground crew for airports; airport personnel management services; advertising services in airports; providing commercial information about products and services to customers; advertising; commercial intermediation services; dissemination of advertisements and advertising material; promoting the products and services of others through loyalty reward card programs; administration of customer loyalty programs; retail, particularly in duty-free shops, of soap, perfumes, cosmetics, lotions for the hair, dentifrices, make-up removing products, razors, shaving products, herbal teas,

pharmaceutical products, sanitary towels, cameras, video cameras, compact discs, DVDs, Blu-ray discs, integrated circuit cards [smart cards], computers, computer peripheral devices, tablet computers, e-readers, telephones, smartphones, headphones, software [recorded programs], spectacles, eyewear, diving masks, bags adapted for laptops, smartwatches, electric batteries, ventilation apparatus, flashlights, fine jewelry, jewelry, horological and chronometric instruments, watches, watch cases, novelty key rings, musical instruments, printed matter, photographs, stationery, cards, books, newspapers, brochures, calendars, handkerchiefs of paper, face towels of paper, toilet paper, bags [envelopes, pouches] of paper or plastic for packaging, trunks and suitcases, umbrellas and parasols, walking sticks, wallets, coin purses, credit card holders [wallets], bags, vanity cases, not fitted, collars for animals, clothing for animals, mirrors, cushions, boxes of wood or plastic, household utensils, kitchen utensils, combs, brushes [except paintbrushes], bottles, toiletry utensils, toilet cases, glasses [receptacles], crockery, bags [envelopes, pouches] of textile, for packaging, household linen, table linen not of paper, bath linen except clothes, clothing, shoes, headwear, artificial plants, games, toys, video game consoles, controllers for video game consoles, decorations and party ornaments and artificial Christmas trees, balls for games, card games, board games, scooters [toys], sporting articles and equipment, models [toys], figurines [toys], meat, preserved fruits, dried fruits, cooked fruits, preserved vegetables, dried vegetables, cooked vegetables, jellies, jams, compotes, dairy products, edible oils and fats, charcuterie, crustaceans [not live], canned meat, canned fish, cheese, milk beverages with milk predominating, coffee, tea, cocoa, sugar, rice, preparations made from cereals, bread, pastry, confectionery, edible ices, honey, salt, mustard, sauces [condiments], spices, sandwiches, pasta, pizzas, pancakes, cookies [biscuits], cakes, sugar confectionery, chocolate, cocoa-based beverages, coffee-based beverages, tea-based beverages, fresh fruits, fresh vegetables, plants, beers, mineral waters [beverages], carbonated waters, fruit-based beverages, preparations for making beverages, lemonades, soda waters, alcohol-free aperitifs, alcoholic beverages, wines, tobacco, articles for smokers, electronic cigarettes; information and consulting services concerning the aforesaid services.

39 – Airport services; providing airport installations for aviation; transport services; airport transfer services; airport check-in services; booking and organizing access to airport lounges; ground traffic control services for aircraft; loading and unloading of airplanes; airport baggage handling; ground assistance services provided at airports in the framework of handling freight; airport parking services; information and consulting services concerning the aforesaid services; travel organization services; travel guide and traveler escort services; escorting of travelers; providing travel

information; providing flight arrival and departure information.

43 – Services for providing food and beverages; temporary accommodation; accommodation agencies (hotels, boarding houses); bar services; coffee shops; cafeterias; day-nurseries [crèches]; hotel services; hotel reservation; self-service restaurants; rental of temporary accommodation; rental of meeting rooms; temporary accommodation reservation; fast-food restaurants, snack bars; providing food and beverages (meals).

(260) AM 2023 120685 A

(800) 1700690

(151) 2022 07 13

(891) 2022 07 13

(731) Compagnie Gervais Danone

17 boulevard Haussmann, F-75009 PARIS, France

(540)

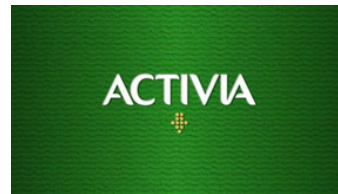

(591) Green, yellow, white

(531) 24.15.01; 24.15.11; 25.07.01; 26.13.25; 27.05.01; 29.01.13

(511)

29 – Milk and milk products; yogurt; milk substitutes; plant-based milk and milk products, namely milks derived from plants, vegetables, grains, nuts, seeds, beans and fruits; cottage cheese; milk beverages with milk predominating; powdered milk; compotes; fruit-based snack food; nut-based food bars; seed-based food bars; snack bars based on probiotic milk; yogurt-based snack food; fruit purees.

30 – Cereals and preparations made from cereals; Breakfast cereals; cereal bars; muesli; cereal-based snack food; rice-based snack food; biscuits and cookies; high-protein cereal bars; energy bars, other than for dietetic or medical use; cakes; pastries; sugar confectionery; dessert mousses [confectionery]; pancakes [foodstuffs]; waffles; chocolate; cocoa-based beverages; chocolate-based beverages; coffee-based beverages; tea-based beverages; custard; ice cream; sherbets [ices]; edible ices; fruit coulis [sauces]; chocolate-based spreads; chocolate spreads containing nuts.

32 – Mineral waters [beverages]; Still or sparkling waters (mineral or not); flavored waters (mineral or not); flavored non-alcoholic beverages; beverages based on fruit and fruit juices; fruit and vegetable-based beverages; beverages based on vegetables and vegetable juices; non-alcoholic beverages; protein-based beverages; protein-enriched sports beverages; nutrient-enriched water, not for medical use; bevera-

ges enriched with additional minerals, not for medical use; beverages enriched with additional vitamins, not for medical use; non-alcoholic beverages enriched with minerals, not for medical use; smoothies [mixed fruit or vegetable beverages]; lemonades; soda water; tonics [non-medicinal beverages]; energy drinks; isotonic beverages; pastilles for effervescing beverages; powders for effervescing beverages; syrups and other preparations for making non-alcoholic beverages; non-alcoholic plant-based beverages.

(260) AM 2023 120687 A

(800) 1700761

(151) 2022 07 28

(891) 2022 07 28

(731) Limited Liability Company "Trading House "Askona"

Komsomolskaya street 116-g, building 25, apart.1, 4th floor, office 26, RU-601914

Kovrov, Vladimir region, Russian Federation

(540)



(591) Turquoise

(531) 24.17.02; 26.01.03; 26.01.06; 27.05.01; 29.01.04

(511)

1 – Agar-agar for industrial purposes; nitrogen; actinium; alkaloids; alginates for the food industry; alginates for industrial purposes; crotonic aldehyde; ammonium aldehyde; aldehydes; americium; amyl acetate; ammonia; ammonia [volatile alkali] for industrial purposes; anhydrous ammonia; acetic anhydride; anhydrides; anti-knock substances for internal combustion engines; disincrustants; antioxidants for use in the manufacture of cosmetics; antioxidants for use in the manufacture of food supplements; antioxidants for use in the manufacture of pharmaceuticals; antioxidants for use in manufacture; antistatic preparations, other than for household purposes; antifreeze; size for use in the textile industry; argon; lead arsenate; astatine; aluminium acetate; lime acetate; lead acetate; acetate of cellulose, unprocessed; acetates [chemicals]; acetylene; acetone; oenological bactericides [chemical preparations for use in wine making]; barium; barytes; albumin [animal or vegetable, raw material]; animal albumen [raw material]; iodised albumen; malt albumen; benzene; benzol; bentonite; berkelium; bicarbonate of soda for chemical purposes; potassium dioxalate; biostimulants for plants; bichromate of potassium; bichromate of soda; bauxite; bromine for chemical purposes; albumenized paper; baryta paper; diazo paper; blueprint paper; test paper, chemical; litmus paper; reagent paper, other than for medical or veterinary purposes; self-toning paper [photography]; nitrate paper; sensitized paper; photometric paper; borax; agglutinants for concrete; gas purifying preparations;

polish removing substances; preparations for the separation of greases; substances for preventing runs in stockings; water-softening preparations; limestone hardening substances; tanning substances; adhesives for industrial purposes; tensio-active agents; artificial sweeteners [chemical preparations]; fissionable material for nuclear energy; foundry binding substances; concrete-aeration chemicals; leather-dressing chemicals; chemicals for the manufacture of paints; chemicals for the manufacture of pigments; starch-liquifying chemicals [ungluing agents]; flower preservatives; seed preserving substances; viscose; bismuth; bismuth subnitrate for chemical purposes; vitamins for the food industry; vitamins for use in the manufacture of cosmetics; vitamins for use in the manufacture of food supplements; vitamins for use in the manufacture of pharmaceuticals; witherite; distilled water; seawater for industrial purposes; acidulated water for recharging batteries; heavy water; hydrogen; seaweeds [fertilizers]; grafting wax for trees; gadolinium; getters [chemically active substances]; protective gases for welding; solidified gases for industrial purposes; propellant gases for aerosols; basic gallate of bismuth; gallium; gambier; helium; electrophoresis gels; genes of seeds for agricultural production; hydrazine; aluminium hydrate; hydrates; hyposulfites; hypochlorite of soda; gypsum for use as a fertilizer; ceramic glazings; glycol; expanded clay for hydroponic plant growing [substrate]; kaolin; alumina; glycerides; glycerine for industrial purposes; glucose for the food industry; glucose for industrial purposes; glucosides; gluten for the food industry; gluten for industrial purposes; holmium; hormones for hastening the ripening of fruit; peat pots for horticulture; graphene; graphite for industrial purposes; guano; humus; gurjun balsam for use in the manufacture of varnish; dextrin [size]; dendrimer-based polymers for use in the manufacture of capsules for pharmaceuticals; detergents for use in manufacturing processes; defoliants; diastase for industrial purposes; kieselgur; manganese dioxide; titanium dioxide for industrial purposes; zirconia; oil dispersants; petroleum dispersants; dispersions of plastics; dysprosium; bichloride of tin; detergent additives to petrol; ceramic compositions for sintering [granules and powders]; additives, chemical, to drilling muds; additives, chemical, to insecticides; chemical additives for oils; additives, chemical, to motor fuel; additives, chemical, to fungicides; dolomite for industrial purposes; tan-wood; europium; gelatine for photographic purposes; gelatine for industrial purposes; auxiliary fluids for use with abrasives; fluids for hydraulic circuits; liquids for removing sulfates from batteries; power steering fluid; brake fluid; magnetic fluid for industrial purposes; transmission fluid; tree cavity fillers [forestry]; glaziers' putty; moderating materials for nuclear reactors; diatomaceous earth; fuller's earth for use in the textile industry; lime chloride; isotopes for industrial purposes; ion exchangers [chemicals]; ytterbium; yttrium; iodine for industrial

purposes; iodine for chemical purposes; aluminium iodide; alkaline iodides for industrial purposes; casein for the food industry; casein for industrial purposes; kainite; potassium; sorrel salt; californium; calomel [mercurous chloride]; gum arabic for industrial purposes; tartar, other than for pharmaceutical purposes; camphor, for industrial purposes; calcium carbide; silicon carbide [raw material]; carbide; lime carbonate; magnesium carbonate; carbonates; cement [metallurgy]; cassiopium [lutetium]; catalysts; biochemical catalysts; catechu; caustics for industrial purposes; alum; ammonia alum; aluminium alum; chrome alum; quebracho for industrial purposes; ketones; cinematographic film, sensitized but not exposed; oxygen for industrial purposes; nitric acid; anthranilic acid; benzoic acid; boric acid for industrial purposes; tartaric acid; tungstic acid; gallic acid for the manufacture of ink; gallotannic acid; glutamic acid for industrial purposes; tannic acid; iodic acid; phenol for industrial purposes; citric acid for industrial purposes; lactic acid; formic acid; persulfuric acid; oleic acid; picric acid; pyrogallic acid; salicylic acid; sebacic acid; sulfuric acid; sulfurous acid; spirits of salt; stearic acid; carbonic acid; spirits of vinegar [dilute acetic acid]; phosphoric acid; hydrofluoric acid; hydrochloric acid; cholic acid; chromic acid; oxalic acid; acids; benzene-based acids; fatty acids; mineral acids; arsenious acid; adhesives for billposting; leather glues; adhesives for wall tiles; adhesives for paperhanging; glue for industrial purposes; cement for mending broken articles; gums [adhesives] for industrial purposes; birdlime; isinglass, other than for stationery, household or alimentary purposes; gluten [glue], other than for stationery or household purposes; starch paste [adhesive], other than for stationery or household purposes; stem cells, other than for medical or veterinary purposes; collagen for industrial purposes; collodion; compost; beer preserving agents; preservatives for use in the pharmaceutical industry; mangrove bark for industrial purposes; tan; starch for industrial purposes; silicon; creosote for chemical purposes; krypton; xenon; xylene; xylol; biological tissue cultures, other than for medical or veterinary purposes; cultures of microorganisms, other than for medical and veterinary use; blue vitriol; curium; lactose [raw material]; lactose for the food industry; lactose for industrial purposes; lanthanum; dry ice [carbon dioxide]; lecithin [raw material]; lecithin for the food industry; lecithin for industrial purposes; lithium; magnesite; manganate; oils for tanning leather; oils for currying leather; oils for preparing leather in the course of manufacture; oils for the preservation of food; transmission oil; carbolineum for the protection of plants; paper pulp; wood pulp; grafting mastic for trees; mastic for leather; mastic for tyres; oil cement [putty]; synthetic materials for absorbing oil; brazing preparations; ceramic materials in particulate form, for use as filtering media; filtering materials of unprocessed plastics; filtering materials of mineral substances; filtering materi-

als of vegetable substances; filtering materials of chemical substances; metalloids; alkaline-earth metals; alkaline metals; methane; methyl benzene; methyl benzol; flour for industrial purposes; tapioca flour for industrial purposes; potato flour for industrial purposes; soap [metallic] for industrial purposes; arsenic; dressing, except oils, for skins; emollients for industrial purposes; animal manure; nanopowders for industrial purposes; sodium; naphthalene; sal ammoniac; toxic gas neutralizers; neodymium; neon; neptunium; ammonium nitrate; uranium nitrate; nitrates; combusting preparations [chemical additives to motor fuel]; nitrous oxide; baryta; uranium oxide; oxalates; lithia [lithium oxide]; lead oxide; antimony oxide; chromium oxide; cobalt oxide for industrial purposes; mercuric oxide; olivine [silicate mineral]; gallnuts; clarification preparations; wine finings; textile-brightening chemicals; beer-clarifying and preserving agents; must-finishing preparations; reducing agents for use in photography; bases [chemical preparations]; wax-bleaching chemicals; fat-bleaching chemicals; organic digestate [fertilizer]; paste fillers for automobile body repair; pectin for the food industry; pectin for industrial purposes; pectin [photography]; perborate of soda; humus top dressing; percarbonates; hydrogen peroxide for industrial purposes; persulfates; perchlorates; foundry sand; plastisols; sensitized plates for offset printing; ferrotype plates [photography]; plasticizers; plastics, unprocessed; X-ray films, sensitized but not exposed; plutonium; chemical coatings for optical lenses; polonium; potash; potash water; soil for growing; praseodymium; rubber preservatives; masonry preservatives, except paints and oils; brickwork preservatives, except paints and oils; cement preservatives, except paints and oils; preservatives for tiles, except paints and oils; bacterial preparations other than for medical and veterinary use; bacteriological preparations for acetification; bacteriological preparations other than for medical and veterinary use; biological preparations, other than for medical or veterinary purposes; vulcanizing preparations; diagnostic preparations, other than for medical or veterinary purposes; renovating preparations for phonograph records; currying preparations for leather; currying preparations for skins; galvanizing preparations; metal hardening preparations; fixing baths [photography]; opacifiers for glass; opacifiers for enamel; separating and unsticking [ungluing] preparations; metal annealing preparations; metal tempering preparations; preparations for preventing the tarnishing of lenses; preparations for preventing the tarnishing of glass; cement-waterproofing chemicals, except paints; plant growth regulating preparations; wallpaper removing preparations; anti-boil preparations for engine coolants; fulling preparations for use in the textile industry; descaling preparations, other than for household purposes; fertilizing preparations; flashlight preparations; finishing preparations for use in the manufacture of steel; sizing preparations; animal carbon preparati-

ons; preparations of microorganisms, other than for medical and veterinary use; corrosive preparations; cryogenic preparations; dehydrating preparations for industrial purposes; degreasing preparations for use in manufacturing processes; gum solvents; oil-bleaching chemicals; decolorants for industrial purposes; meat tenderizers for industrial purposes; preparations for stimulating cooking for industrial purposes; anti-incrustants; preparations of trace elements for plants; moistening [wetting] preparations for use in the textile industry; moistening [wetting] preparations for use in dyeing; moistening [wetting] preparations for use in bleaching; enzyme preparations for the food industry; enzyme preparations for industrial purposes; filtering preparations for the beverages industry; chemical preparations to prevent mildew; chemical preparations to prevent wheat blight; chemical condensation preparations; chemical preparations for smoking meat; chemical substances for analyses in laboratories, other than for medical or veterinary purposes; chemical preparations for scientific purposes, other than for medical or veterinary use; chemical preparations for facilitating the alloying of metals; chemical preparations to prevent diseases affecting vine plants; chemical preparations to prevent diseases affecting cereal plants; engine-decarbonising chemicals; fulling preparations; fuel-saving preparations; coal saving preparations; damp-proofing chemicals, except paints, for masonry; anti-sprouting preparations for vegetables; preparations of the distillation of wood alcohol; by-products of the processing of cereals for industrial purposes; chemical substances for preserving foodstuffs; benzene derivatives; cellulose derivatives [chemicals]; promethium; protactinium; protein [raw material]; proteins for the food industry; proteins for use in the manufacture of food supplements; proteins for use in manufacture; mordants for metals; radium for scientific purposes; radon; solvents for varnishes; anti-frothing solutions for batteries; drilling muds; galvanizing baths; solutions for cyanotyping; silver salt solutions for silvering; toning baths [photography]; chemical reagents, other than for medical or veterinary purposes; rhenium; mercury; rubidium; carbon black for industrial purposes; soot for industrial or agricultural purposes; lamp black for industrial purposes; samarium; saccharin; selenium; saltpeter; sulfur; silver nitrate; carbon disulfide; silicates; aluminium silicate; silicones; scandium; topsoil; foundry moulding preparations; potting soil; acrylic resins, unprocessed; unprocessed artificial resins; polymer resins, unprocessed; synthetic resins, unprocessed; epoxy resins, unprocessed; soda ash; calcined soda; caustic soda for industrial purposes; barium compounds; fluorspar compounds; salts [fertilizers]; salts [chemical preparations]; ammoniacal salts; ammonium salts; salts of precious metals for industrial purposes; salts for galvanic cells; salt for preserving, other than for foodstuffs; salts for colouring metal; salts for industrial purposes;

iron salts; gold salts; iodised salts; calcium salts; sodium salts [chemical compounds]; salt, raw; salts from rare earth metals; mercury salts; toning salts [photography]; chrome salts; chromic salts; salts of alkaline metals; rock salt; mold-release compounds; fire extinguishing compositions; compositions for the manufacture of phonograph records; compositions for the manufacture of technical ceramics; compositions for repairing inner tubes of tyres; compositions for repairing tyres; acid proof chemical compositions; glutinous tree-grafting preparations; adhesive preparations for surgical bandages; fireproofing preparations; compositions for threading; sauce for preparing tobacco; amyl alcohol; vinic alcohol; wood alcohol; sal ammoniac spirits; ethyl alcohol; alcohol; adjuvants, other than for medical or veterinary purposes; cement for footwear; concrete preservatives, except paints and oils; water glass [soluble glass]; strontium; substrates for soil-free growing [agriculture]; barium sulfate; copper sulphate [vitriol]; sulfates; antimony sulfide; sulfides; benzoic sulfimide; sulfonic acids; sumac for use in tanning; superphosphates [fertilizers]; antimony; thallium; talc [magnesium silicate]; tannin; cream of tartar for the food industry; cream of tartar for industrial purposes; cream of tartar for chemical purposes; tellurium; terbium; tetrachlorides; carbon tetrachloride; acetylene tetrachloride; technetium; thymol for industrial purposes; thiocarbonyl; titanite; sensitized cloth for photography; blueprint cloth; toluol; fuel for nuclear reactors; thorium; peat [fertilizer]; gum tragacanth for industrial purposes; thulium; carbonic hydrides; carbon; activated carbon; carbon for filters; animal charcoal; animal carbon; bone charcoal; blood charcoal; fertilizers; nitrogenous fertilizers; fish meal fertilizers; wood vinegar [pyrolygneous acid]; uranium; chemical intensifiers for paper; chemical intensifiers for rubber; vulcanization accelerators; enzymes for the food industry; enzymes for industrial purposes; ferments for chemical purposes; milk ferments for the food industry; milk ferments for industrial purposes; milk ferments for chemical purposes; fermium; ferrocyanides; fixing solutions [photography]; flavonoids [phenolic compounds] for industrial purposes; flocculants; soldering fluxes; brazing fluxes; formic aldehyde for chemical purposes; phosphatides; phosphates [fertilizers]; phosphorus; photographic paper; photosensitive plates; sensitized photographic plates; sensitized films, unexposed; photographic developers; photographic sensitizers; chemical preparations for use in photography; photographic emulsions; francium; fluorine; chemicals for use in forestry, except fungicides, herbicides, insecticides and parasiticides; glass-frosting chemicals; leather-renovating chemicals; glass-staining chemicals; enamel-staining chemicals; oil-separating chemicals; water-purifying chemicals; oil-purifying chemicals; soldering chemicals; condensation-preventing chemicals; stain-preventing chemicals for use on fabrics; anti-tarnishing chemicals for windows; leather-waterproofing chemicals; textile-water-

proofing chemicals; chemicals, except pigments, for the manufacture of enamel; radiator flushing chemicals; leather-impregnating chemicals; textile-impregnating chemicals; horticultural chemicals, except fungicides, herbicides, insecticides and parasiticides; agricultural chemicals, except fungicides, herbicides, insecticides and parasiticides; soil conditioning preparations; chimney cleaners, chemical; industrial chemicals; colour-brightening chemicals for industrial purposes; refrigerants; coolants for vehicle engines; chlorine; chlorates; hydrochlorates; aluminium chloride; magnesium chloride; chlorides; palladium chloride; chromates; flowers of sulfur for chemical purposes; caesium; cellulose; cerium; cyanides [prussiates]; calcium cyanamide [fertilizer]; cymene; loam; slag [fertilizers]; size for finishing and priming; spinel [oxide mineral]; alkalies; caustic alkali; tea extracts for the food industry; tea extracts for use in the manufacture of cosmetics; tea extracts for use in the manufacture of pharmaceuticals; radioactive elements for scientific purposes; rare earths; fissionable chemical elements; emulsifiers; erbium; ethane; methyl ether; sulfuric ether; ethyl ether; glycol ether; ethers; esters; cellulose ethers for industrial purposes; cellulose esters for industrial purposes.

2 – Annotto [dyestuff]; auramine; Canada balsam; white lead; paper for dyeing Easter eggs; dyes; binding preparations for paints; glazes [paints, lacquers]; orange lead; primers; gamboge for painting; gum-lac; titanium dioxide [pigment]; repositionable paint patches; indigo [colorant]; gum resins; colophony; caramel [food colorant]; carbonyl [wood preservative]; cochineal carmine; toner cartridges, filled, for printers and photocopiers; ink cartridges, filled, for printers and photocopiers; edible ink cartridges, filled, for printers; copal; colorants; alizarine dyes; aniline dyes; colorants for the restoration of furniture in the form of markers; ink for leather; colorants for liqueurs; colorants for beverages; shoe dyes; colorants for beer; colorants for butter; dyewood; malt colorants; food dyes; paints; watercolour paints for use in art; aluminium paints; asbestos paints; bactericidal paints; ceramic paints; marking ink for animals; distempers; oil paints for use in art; anti-urine paints; fireproof paints; printing ink; enamels for painting; creosote for wood preservation; turmeric [colorant]; black japan; lacquers; bitumen varnish; bronzing lacquers; wood floor finishes; copal varnish; anti-corrosive bands; anti-rust oils; oils for the preservation of wood; mastic [natural resin]; lime wash; wood stains; cobalt oxide [colorant]; zinc oxide [pigment]; silver paste; printers' pastes [ink]; pigments; coatings [paints]; coatings for roofing felt [paints]; wood coatings [paints]; anti-graffiti coatings [paints]; undercoating for vehicle chassis; anti-fouling paints; varnishes; aluminium powder for painting; bronze powder for painting; silvering powders; metals in powder form for use in painting, decorating, printing and art; anti-corrosive preparations; protective preparations for metals; mor-

dants; wood mordants; stains for leather; thinners for paints; thinners for lacquers; whitewash; soot [colorant]; carbon black [pigment]; lamp black [pigment]; sandarac; thickeners for paints; sienna earth; siccatives [drying agents] for paints; anti-rust greases; natural resins, raw; malt caramel [food colorant]; badi-geon; anti-tarnishing preparations for metals; anti-rust preparations; wood preservatives; sumac for varnishes; red lead; turpentine [thinner for paints]; toner for printers and photocopiers; fixatives [varnishes]; fixatives for watercolours; metal foil for painters, decorators, printers and artists; yellowwood [colorant]; engraving ink; ink for printers and photocopiers; edible inks; saffron [colorant]; dyewood extracts; enamels [varnishes]; silver emulsions [pigments].

3 – Abrasives; amber [perfume]; descaling preparations for household purposes; antistatic preparations for household purposes; aromatics [essential oils]; air fragrancing preparations; cake flavourings [essential oils]; flavourings for beverages [essential oils]; food flavourings [essential oils]; breath freshening sprays; canned pressurized air for cleaning and dusting purposes; balms, other than for medical purposes; basma [cosmetic dye]; lip glosses; nail glitter; body glitter; polishing stones; abrasive paper; emery paper; polishing paper; petroleum jelly for cosmetic purposes; shoe polish; cobblers' wax; cotton wool for cosmetic purposes; cotton wool impregnated with make-up removing preparations; sachets for perfuming linen; drying agents for dishwashing machines; adhesives for cosmetic purposes; scented water; Javelle water; lavender water; micellar water; toilet water; wax for parquet floors; floor wax; non-slipping wax for floors; depilatory wax; moustache wax; tailors' wax; creams for leather; polish for furniture and flooring; shoemakers' wax; polishing wax; massage gels, other than for medical purposes; heliotropine; dental bleaching gels; geraniol; make-up; deodorants for pets; deodorants for human beings or for animals; depilatory preparations; air fragrance reed diffusers; scented wood; perfumes; non-slipping liquids for floors; windscreen cleaning liquids; greases for cosmetic purposes; volcanic ash for cleaning; perfumery; decorative transfers for cosmetic purposes; ionone [perfumery]; shaving stones [astringents]; smoothing stones; eyebrow pencils; cosmetic pencils; silicon carbide [abrasive]; carbides of metal [abrasives]; alum stones [astringents]; tripoli stone for polishing; adhesives for affixing false eyelashes; adhesives for affixing false hair; hair conditioners; quillaia bark for washing; corundum [abrasive]; beard dyes; colorants for toilet purposes; cosmetic dyes; body paint for cosmetic purposes; laundry starch; starch glaze for laundry purposes; shoe cream; polishing creams; cosmetic creams; skin whitening creams; polishing rouge; incense; hair spray; nail varnish; liquid latex body paint for cosmetic purposes; hair lotions; lotions for cosmetic purposes; after-shave lotions; beauty masks; oils for perfumes and scents; oils for cosmetic purposes; oils for toilet purposes; essen-

tial oils; essential oils of cedarwood; essential oils of lemon; essential oils of citron; oils for cleaning purposes; bergamot oil; gaultheria oil; jasmine oil; lavender oil; almond oil; rose oil; oil of turpentine for degreasing; whitening; cleaning chalk; almond milk for cosmetic purposes; cleansing milk for toilet purposes; musk [perfumery]; soap; deodorant soap; shaving soap; soap for brightening textile; cakes of toilet soap; antiperspirant soap; soap for foot perspiration; almond soap; mint for perfumery; cosmetic kits; emery; gel eye patches for cosmetic purposes; nail art stickers; double eyelid tapes; false nails; eau de Cologne; extracts of flowers [perfumes]; joss sticks; pastes for razor strops; toothpaste; pumice stone; lipstick cases; hydrogen peroxide for cosmetic purposes; breath freshening strips; teeth whitening strips; sandcloth; glass cloth [abrasive cloth]; lipsticks; pomades for cosmetic purposes; shaving preparations; cosmetic preparations for baths; bath preparations, not for medical purposes; hair straightening preparations; hair waving preparations; laundry soaking preparations; grinding preparations; smoothing preparations [starching]; colour-removing preparations; leather bleaching preparations; polishing preparations; denture polishes; mouthwashes, not for medical purposes; cosmetic preparations for slimming purposes; laundry glaze; preparations to make the leaves of plants shiny; eye-washes, not for medical purposes; fabric softeners for laundry use; preparations for washing; dry-cleaning preparations; paint stripping preparations; lacquer-removing preparations; make-up removing preparations; floor wax removers [scouring preparations]; varnish-removing preparations; rust removing preparations; nail care preparations; cleaning preparations; preparations for cleaning dentures; wallpaper cleaning preparations; preparations for unblocking drain pipes; chemical cleaning preparations for household purposes; collagen preparations for cosmetic purposes; bleaching preparations [decolorants] for household purposes; laundry bleach; aloe vera preparations for cosmetic purposes; sunscreen preparations; colour-brightening chemicals for household purposes [laundry]; breath freshening preparations for personal hygiene; shining preparations [polish]; make-up powder; diamantine [abrasive]; stain removers; nail varnish removers; vaginal washes for personal sanitary or deodorant purposes; scouring solutions; false eyelashes; antistatic dryer sheets; baby wipes impregnated with cleaning preparations; colour run prevention laundry sheets; tissues impregnated with cosmetic lotions; tissues impregnated with make-up removing preparations; saffrol; massage candles for cosmetic purposes; laundry blueing; turpentine for degreasing; potpourris [fragrances]; bleaching soda; washing soda, for cleaning; bath salts, not for medical purposes; bleaching salts; fumigation preparations [perfumes]; leather preservatives [polishes]; ammonia [volatile alkali] [detergent]; astringents for cosmetic purposes; eyebrow cosmetics; make-up preparations; sun-tanning preparati-

ons [cosmetics]; hair dyes; neutralizers for permanent waving; cosmetic preparations for eyelashes; cosmetic preparations for skin care; dentifrices; cosmetics; cosmetics for children; cosmetics for animals; mascara; cleansers for intimate personal hygiene purposes, non medicated; douching preparations for personal sanitary or deodorant purposes [toiletries]; detergents, other than for use in manufacturing operations and for medical purposes; degreasers, other than for use in manufacturing processes; bleaching preparations [decolorants] for cosmetic purposes; toiletry preparations; antiperspirants [toiletries]; phytocosmetic preparations; talcum powder, for toilet use; cotton swabs for cosmetic purposes; terpenes [essential oils]; emery cloth; cloths impregnated with a detergent for cleaning; henna [cosmetic dye]; shampoos; shampoos for animals [non-medicated grooming preparations]; shampoos for pets [non-medicated grooming preparations]; dry shampoos; sandpaper; soda lye; herbal extracts for cosmetic purposes; ethereal essences; badian essence; mint essence [essential oil].

4 – Anthracite; benzine; biomass fuel; wood briquettes; combustible briquettes; petroleum jelly for industrial purposes; wax [raw material]; ozokerite; wax for lighting; industrial wax; belting wax; carnauba wax; beeswax; beeswax for use in the manufacture of cosmetics; gas for lighting; oil-gas; fuel gas; petrol; producer gas; solidified gases [fuel]; fuel; lubricating graphite; additives, non-chemical, to motor fuel; firewood; paper spills for lighting fires; cutting fluids; fish oil, not edible; wool grease; greases for the preservation of leather; grease for leather; grease for footwear; tallow; industrial grease; kerosene; coke; lanolin for use in the manufacture of cosmetics; ligroin; wood spills for lighting fires; wax for skis; mazut; fuel oil; oils for the preservation of leather; oils for paints; oils for releasing form work [building]; oils for lighting; oils for the preservation of masonry; textile oil; lubricating oil; industrial oil; moistening oil; coal tar oil; coal naphtha; castor oil for industrial purposes; bone oil for industrial purposes; motor oil; sunflower oil for industrial purposes; rape oil for industrial purposes; lubricants; naphtha; petroleum, raw or refined; nightlights [candles]; oleine; paraffin; dust removing preparations; soya bean oil preparations for non-stick treatment of cooking utensils; non-slipping preparations for belts; coal dust [fuel]; firelighters; perfumed candles; Christmas tree candles; candles; grease for arms [weapons]; lubricating grease; grease for belts; vaporized fuel mixtures; dust absorbing compositions; dust binding compositions for sweeping; dust laying compositions; alcohol [fuel]; methylated spirit; stearine; benzene fuel; diesel oil; lighting fuel; xylene fuel; mineral fuel; carburants; fuel with an alcohol base; peat [fuel]; peat briquettes [fuel]; tinder; lignite; hoo-kah charcoal; charcoal [fuel]; coal; coal briquettes; lamp wicks; wicks for candles; ceresine; electrical energy; ethanol [fuel]; petroleum ether.

6 – Aluminium; fittings of metal for compressed air lines; fittings of metal for building; white metal; beacons of metal, non-luminous; vats of metal; beams of metal; joists of metal; bottles [containers] of metal for compressed gas or liquid air; balustrades of metal; preserve tins; winding spools of metal, non-mechanical, for flexible hoses; swimming pools [structures] of metal; beryllium [glucinium]; arbours [structures] of metal; blooms [metallurgy]; ingots of common metal; anchors; bolts of metal; eye bolts; casks of metal; mooring buoys of metal; barrels of metal; identification bracelets of metal; bronze; bells; bells for animals; letters and numerals of common metal, except type; silos of metal; busts of common metal; vanadium; bird baths [structures] of metal; valves of metal, other than parts of machines; screws of metal; aviaries [structures] of metal; tungsten; hoppers of metal, non-mechanical; gates of metal; sleeves [metal hardware]; ferrules of metal; ferrules of metal for handles; signboards of metal; diving boards of metal; loading gauge rods of metal for railway wagons; nuts of metal; galena [ore]; celtium [hafnium]; nails; tacks [nails]; horseshoe nails; shoe pegs of metal; germanium; vice claws of metal; armoured doors of metal; doors of metal; folding doors of metal; swing doors of metal; accordion doors of metal; chimney pots of metal; towel dispensers, fixed, of metal; door closers of metal, non-electric; prefabricated houses [kits] of metal; memorial plates of metal; chimney shafts of metal; wall plugs of metal; troughs of metal for mixing mortar; packaging containers of metal; containers of metal for storing acids; jalousies of metal; outdoor blinds of metal; iron, unwrought or semi-wrought; iron strip; roof gutters of metal; street gutters of metal; tinplate; plugs of metal; iron slabs; door bolts of metal; window fasteners of metal; bolts, flat; clips of metal for sealing bags; binding screws of metal for cables; cramps of metal [crampons]; wheel clamps [boots]; rivets of metal; box fasteners of metal; locks of metal for bags; locks of metal for vehicles; locks of metal, other than electric; padlocks of metal, other than electronic; spring locks; closures of metal for containers; latches of metal; tension links; couplings of metal for chains; road signs, non-luminous and non-mechanical, of metal; registration plates of metal; signs, non-luminous and non-mechanical, of metal; fences of metal; buckles of common metal [hardware]; bronzes [works of art]; works of art of common metal; ironmongery; indium; cabanas of metal; soundproof booths of metal, transportable; telephone booths of metal; cadmium; paint spraying booths of metal; telpher cables; ropes of metal; jerrycans of metal; horticultural frames of metal; greenhouse frames of metal; framework of metal for building; cornices of metal; skating rinks [structures] of metal; cermets; water-pipe valves of metal; drain traps [valves] of metal; metal cages for wild animals; keys of metal; mooring bollards of metal; cobalt, raw; chill-moulds [foundry]; elbows of metal for pipes; bed casters of metal; fur-

niture casters of metal; manifolds of metal for pipelines; door bells of metal, non-electric; casings of metal for oilwells; pillars of metal for building; chimney cowls of metal; bottle caps of metal; sealing caps of metal; tent pegs of metal; pegs of metal; copper rings; split rings of common metal for keys; rings of metal; door fittings of metal; fittings of metal for windows; brackets of metal for building; buildings of metal; buildings, transportable, of metal; steel buildings; oil drainage containers of metal; containers of metal [storage, transport]; check rails of metal for railways; baskets of metal; door frames of metal; tool boxes of metal, empty; stringers [parts of staircases] of metal; crampons [climbing irons]; taps of metal for casks; tubing of metal; brackets of metal for furniture; roofing of metal; roofing of metal, incorporating photovoltaic cells; turntables [railways]; screw tops of metal for bottles; manhole covers of metal; hooks [metal hardware]; pitons of metal; pot hooks of metal; hooks of metal for roofing slates; sash fasteners of metal for windows; hooks of metal for clothes rails; bag hangers of metal; clothes hooks of metal; chicken-houses of metal; chests of metal; brass, unwrought or semi-wrought; bands of metal for tying-up purposes; scaffolding of metal; staircases of metal; ladders of metal; limonite; steel sheets; cast steel; traps for wild animals; magnesium; manganese; reinforcing materials, of metal, for concrete; reinforcing materials of metal for machine belts; reinforcing materials of metal for pipes; reinforcing materials of metal for building; railway material of metal; materials of metal for funicular railway permanent ways; building materials of metal; refractory construction materials of metal; masts of metal; steel masts; copper, unwrought or semi-wrought; sheets and plates of metal; common metals, unwrought or semi-wrought; pyrophoric metals; metals in powder form; mouldings of metal for building; molybdenum; door knockers of metal; pipe muffs of metal; shoe dowels of metal; porches [structures] of metal; bronzes for tombstones; tombs of metal; flashing of metal for building; roof flashing of metal; fish plates [rails]; anvils; anvils [portable]; beak-irons; rope thimbles of metal; ferrules of metal for walking sticks; handcuffs; jets of metal; duckboards of metal; belt stretchers of metal; stretchers for metal bands [tension links]; wire stretchers [tension links]; stretchers for iron bands [tension links]; nickel silver; nickel; niobium; grease nipples; binding thread of metal for agricultural purposes; thread of metal for tying-up purposes; house numbers of metal, non-luminous; braces of metal for handling loads; wall claddings of metal for building; mouldings of metal for cornices; enclosures of metal for tombs; laths of metal; barrel hoops of metal; wall linings of metal for building; palings of metal; crash barriers of metal for roads; furnace fireguards of metal; tree protectors of metal; latticework of metal; door stops of metal; stops of metal; window stops of metal; windows of metal; ironwork for doors; ironwork for windows; tin; shut-

tering of metal for concrete; filings of metal; posts of metal for power lines; props of metal; branching pipes of metal; monuments of metal; monuments of metal for tombs; metal ramps for use with vehicles; acoustic panels of metal; door panels of metal; wainscoting of metal; signalling panels, non-luminous and non-mechanical, of metal; building panels of metal; partitions of metal; lintels of metal; casement windows of metal; strap-hinges of metal; shims; rocket launching platforms of metal; platforms, prefabricated, of metal; wall tiles of metal; floor tiles of metal; tiles of metal for building; anchor plates; paving slabs of metal; grave slabs of metal; tile floorings of metal; slabs of metal for building; lead seals; loading pallets of metal; handling pallets of metal; transport pallets of metal; trays of metal; stakes of metal for plants or trees; fire-dogs [andirons]; armour-plating of metal; paving blocks of metal; roof coverings of metal; cladding of metal for building; linings of metal for building; fireplace mantles of metal; steel strip; floors of metal; sills of metal; bathtub grab bars of metal; ceilings of metal; brazing alloys; gold solder; silver solder; collars of metal for fastening pipes; floating docks of metal, for mooring boats; stoppers of metal; aluminium wire; iron wire; wire of common metal; wire of common metal alloys, except fuse wire; barbed wire; copper wire, not insulated; soldering wire of metal; steel wire; springs [metal hardware]; rods of metal for welding; rods of metal for brazing and welding; rods of metal for brazing; peeled metal bars; drawn and polished metal bars; bright steel bars; hot-rolled steel bars; dispensers for dog waste bags, fixed, of metal; window frames of metal; frames of metal for building; crucifixes of common metal, other than jewellery; containers of metal for liquid fuel; containers of metal for compressed gas or liquid air; tanks of metal; floating containers of metal; rails of metal; straps of metal for handling loads; fireplace grates of metal; gratings of metal; runners of metal for sliding doors; iron ores; ores of metal; chrome ores; door handles of metal; knobs of metal; sheet piles of metal; pigsties of metal; lead, unwrought or semi-wrought; safes [metal or non-metal]; safes, electronic; insect screens of metal; burial vaults of metal; door scrapers; cable joints of metal, non-electric; junctions of metal for pipes; nozzles of metal; anti-friction metal; silver-plated tin alloys; alloys of common metal; sheaf binders of metal; bindings of metal; bottle closures of metal; shutters of metal; steel alloys; steel, unwrought or semi-wrought; tinfoil; statues of common metal; figurines of common metal; cask stands of metal; tombstone stelae of metal; bars for metal railings; stables of metal; advertisement columns of metal; posts of metal; telegraph posts of metal; railway points; steps [ladders] of metal; slings of metal for handling loads; stair treads [steps] of metal; machine belt fasteners of metal; tombstone plaques of metal; nameplates of metal; step stools of metal; tantalum [metal]; greenhouses of metal, transportable; titanium; wire cloth; tombac; mobi-

le boarding stairs of metal for passengers; cables of metal, non-electric; wire rope; pipework of metal; penstock pipes of metal; water-pipes of metal; gutter pipes of metal; ducts of metal for ventilating and air-conditioning installations; drain pipes of metal; chimneys of metal; pipes of metal; ducts of metal, for central heating installations; steel pipes; turnstiles of metal; angle irons of metal; tinplate packings; door fasteners of metal; bicycle parking installations of metal; window closers of metal, non-electric; door openers of metal, non-electric; window openers of metal, non-electric; wind-driven bird-repelling devices made of metal; tungsten iron; molybdenum iron; silicon iron; titanium iron; chrome iron; flagpoles [structures] of metal; hand-held flagpoles of metal; flanges of metal [collars]; weather- or wind-vanes of metal; aluminium foil; metals in foil or powder form for 3D printers; foils of metal for wrapping and packaging; ice moulds of metal; foundry moulds of metal; fittings of metal for coffins; fittings of metal for beds; fittings of metal for furniture; clips of metal for cables and pipes; chromium; cattle chains; chains of metal; safety chains of metal; zinc; zirconium; pantiles of metal; roofing tiles of metal; cast iron, unwrought or semi-wrought; washers of metal; balls of steel; hinges of metal; poles of metal; safety cashboxes; pulleys of metal, other than for machines; window pulleys of metal; railway sleepers of metal; window casement bolts; cotter pins of metal; spurs; pins [hardware]; roller blinds of steel; latch bars of metal; badges of metal for vehicles; labels of metal; lock bolts; cashboxes [metal or non-metal]; tool chests of metal, empty; boxes of common metal; letter boxes of metal.

8 – Glaziers' diamonds [parts of hand tools]; apparatus for tattooing; laser hair removal apparatus, other than for medical purposes; razors, electric or non-electric; sharpening steels; scythe stones; gimlets [hand tools]; borers; augers [hand tools]; carpenters' augers; pickhammers; carving forks; table forks; agricultural forks [hand tools]; lawn clippers [hand instruments]; harpoons; harpoons for fishing; nail extractors, hand-operated; rakes [hand tools]; sand trap rakes; cutter bars [hand tools]; whetstone holders; priming irons [hand tools]; sculptors' chisels; lifting jacks, hand-operated; hand drills, hand-operated; truncheons; clamps for carpenters or coopers; spades [hand tools]; rabbeting planes; chisels; engraving needles; tattoo needles; cutlery; edge tools [hand tools]; garden tools, hand-operated; abrading instruments [hand instruments]; numbering punches; goffering irons; implements for decanting liquids [hand tools]; depilation appliances, electric and non-electric; sharpening instruments; blade sharpening instruments; livestock marking tools; nail clippers, electric or non-electric; oyster openers; polishing irons [glazing tools]; ear-piercing apparatus; tube cutting instruments; wire strippers [hand tools]; riveters [hand tools]; expanders [hand tools]; cutters; cutting tools [hand tools]; ski edge sharpening tools, hand-operated; hand tools, hand-

operated; sterile body piercing instruments; stamping-out tools [hand tools]; picks [hand tools]; sharpening stones; punch rings [knuckle dusters]; trowels; centre punches [hand tools]; daggers; pickaxes; mallets [hand instruments]; pliers; punch pliers [hand tools]; blades [weapons]; annular screw plates; spanners [hand tools]; tap wrenches; ladles [hand tools]; foundry ladles [hand tools]; meat claws; breast drills; lasts [shoemakers' hand tools]; scythe rings; instruments for punching tickets; diggers [hand tools]; rams [hand tools]; scythes; hainault scythes; fire irons; emery grinding wheels; grindstones [hand tools]; sledgehammers; thistle extractors [hand tools]; nail nippers; tree pruners; nail drawers [hand tools]; ice picks; blades [hand tools]; razor blades; blades for planes; plane irons; jig-saws; spoons; table knives, forks and spoons for babies; table knives, forks and spoons of plastic; crow bars; trowels [gardening]; shovels [hand tools]; palette knives; machetes; beard clippers; hair clippers for personal use, electric and non-electric; hair clippers for animals [hand instruments]; taps [hand tools]; fireplace bellows [hand tools]; swords; hammers [hand tools]; emergency hammers; fullers [hand tools]; stone hammers; masons' hammers; riveting hammers [hand tools]; mattocks; ditchers [hand tools]; mincing knives; manicure sets; manicure sets, electric; pedicure sets; needle files; bits [hand tools]; files [tools]; emery files; air pumps, hand-operated; hand pumps; shaving cases; knives; cheese slicers, non-electric; fruit segmenters; egg slicers, non-electric; vegetable knives; pizza cutters, non-electric; scaling knives; hobby knives [scalpels]; fruit corers; moulding irons; ceramic knives; tin openers, non-electric; farriers' knives; budding knives; hunting knives; penknives; grafting tools [hand tools]; carving knives; braiders [hand tools]; box cutters; bill-hooks; paring knives; cleavers; scissors; wick trimmers [scissors]; shears; cattle shearers; border shears; pruning shears; shearers [hand instruments]; sword scabbards; kitchen mandolines; vegetable slicers, hand-operated; vegetable spiralizers, hand-operated; vegetable peelers, hand-operated; agricultural implements, hand-operated; side arms, other than firearms; stropping instruments; screwdrivers, non-electric; sabres; stirring sticks for mixing paint; reamer sockets; drill holders [hand tools]; perforating tools [hand tools]; rammers [hand tools]; emery boards; nail files; nail files, electric; saws [hand tools]; bow saws; tweezers; hair-removing tweezers; guns [hand tools]; non-electric caulking guns; guns, hand-operated, for the extrusion of mastics; dies [hand tools]; fruit pickers [hand tools]; saw blades [parts of hand tools]; shear blades; tool belts [holders]; hair braiders, electric; table cutlery [knives, forks and spoons]; crimping irons; hand implements for hair curling; vegetable choppers; money scoops; instruments and tools for skinning animals; nail buffers, electric or non-electric; hackles [hand tools]; pin punches; nail punches; fish tapes [hand tools]; punches [hand tools]; insecticide vaporizers

[hand tools]; syringes for spraying insecticides; reamers; frames for handsaws; saw holders; rasps [hand tools]; paring irons [hand tools]; graving tools [hand tools]; milling cutters [hand tools]; razor strops; leather strops; planes; scythe handles; knife handles; handles for hand-operated hand tools; levers; marline spikes; bits [parts of hand tools]; hollowing bits [parts of hand tools]; pruning scissors; silver plate [knives, forks and spoons]; pruning knives; sickles; drawing knives; scrapers [hand tools]; scrapers for skins; mortise chisels; caulking irons; gouges [hand tools]; mortars for pounding [hand tools]; mitre boxes [hand tools]; branding irons; hatchets; adzes [tools]; vices; bench vices [hand implements]; hoop cutters [hand tools]; axes; holing axes; fulling tools [hand tools]; earth rammers [hand tools]; tube cutters [hand tools]; hoes [hand tools]; squares [hand tools]; extension pieces for braces for screw taps; embossers [hand tools]; apparatus for destroying plant parasites, hand-operated; metal wire stretchers [hand tools]; metal band stretchers [hand tools]; flat irons; irons [non-electric hand tools]; razor cases; ratchets [hand tools]; scraping tools [hand tools]; awls; choppers being knives; spatulas [hand tools]; spatulas for use by artists; wine bottle foil cutters, hand-operated; bayonets; pincers; curling tongs; cuticle tweezers; eyelash curlers.

9 – Ticket dispensers; 3D spectacles; DVD players; juke boxes, musical; fire engines; answering machines; electrical adapters; batteries for electronic cigarettes; accumulators, electric; batteries, electric, for vehicles; accelerometers; actinometers; alidades; altimeters; ear pads for headphones; ammeters; nanoparticle size analysers; anemometers; anodes; aerials; anticathodes; apertometers [optics]; high-frequency apparatus; testing apparatus not for medical purposes; remote control apparatus; electro-dynamic apparatus for the remote control of railway points; electro-dynamic apparatus for the remote control of signals; monitoring apparatus, other than for medical purposes; sound recording apparatus; Global Positioning System [GPS] apparatus; distillation apparatus for scientific purposes; diffraction apparatus [microscopy]; air analysis apparatus; apparatus to check franking; sound transmitting apparatus; fermentation apparatus for laboratory use; breathing apparatus for underwater swimming; breathing apparatus, except for artificial respiration; apparatus and installations for the production of X-rays, not for medical purposes; cash registers; electric apparatus for commutation; magnetic resonance imaging [MRI] apparatus, not for medical purposes; intercommunication apparatus; stills for laboratory experiments; projection apparatus; fire extinguishing apparatus; radiological apparatus for industrial purposes; X-ray apparatus not for medical purposes; blueprint apparatus; flashing lights [luminous signals]; stereoscopic apparatus; telephone apparatus; facsimile machines; phototelegraphy apparatus; igniting apparatus, electric, for igniting at a distance; acid hydrometers; salinometers; acidimeters for batteries; aerome-

ters; beacons, luminous; battery jars; automated teller machines [ATM]; barometers; anode batteries; galvanic batteries; ignition batteries; solar batteries; solar panels for the production of electricity; batteries, electric; balances [steelyards]; betatrons; binoculars; biochips; electronic tags for goods; lens hoods; magnetic tape units for computers; computer memory devices; fire hose nozzles; encoded identification bracelets, magnetic; connected bracelets [measuring instruments]; safety tarpaulins; electronic key fobs being remote control apparatus; bullet-proof clothing; signalling buoys; life buoys; marking buoys; directional compasses; vacuum gauges; electrolysis apparatus for laboratory use; variometers; verniers; scales; baby scales; bathroom scales; letter scales; weighbridges; precision balances; scales with body mass analysers; levelling staffs [surveying instruments]; camcorders; video baby monitors; video cassettes; video projectors; video telephones; video screens; viewfinders, photographic; electric plugs; micrometer screws for optical instruments; viscosimeters; circuit closers; wavemeters; voltmeters; mechanical signs; illuminated signs; switchboxes [electricity]; current rectifiers; gas testing instruments; gasometers [measuring instruments]; galvanometers; hands-free kits for telephones; heliographic apparatus; hygrometers; hydrometers; weights; peepholes [magnifying lenses] for doors; hairdressing training heads [teaching apparatus]; holograms; plotters; loudspeakers; sounding leads; plumb bobs; range finders; parking sensors for vehicles; piezoelectric sensors; densimeters; densitometers; detectors; smoke detectors; infrared detectors; counterfeit coin detectors; joysticks for use with computers, other than for video games; transparencies [photography]; slide projectors; diaphragms [photography]; dictating machines; dynamometers; light-emitting diodes [LED]; quantum dot light-emitting diodes [QLED]; organic light-emitting diodes [OLED]; floppy disks; phonograph records; disks, magnetic; optical discs; circular slide rules; disk drives for computers; juke boxes for computers; wearable video display monitors; electronic numeric displays; DNA chips; electronic interactive whiteboards; electronic notice boards; electric wire harnesses for automobiles; bullet-proof vests; life jackets; reflective safety vests; identification threads for electric wires; nose clips for divers and swimmers; padlocks, electronic; locks, electric; bells [warning devices]; alarm bells, electric; electric door bells; signal bells; acoustic conduits; mirrors for inspecting work; road signs, luminous or mechanical; signs, luminous; downloadable emoticons for mobile phones; marine depth finders; probes for scientific purposes; buzzers; needles for surveying compasses; needles for record players; eyewear; reflective articles for wear, for the prevention of accidents; measures; pressure measuring apparatus; simulators for the steering and control of vehicles; inverters [electricity]; pressure indicators; automatic indicators of low pressure in vehicle tyres; temperature

indicators; incubators for bacteria culture; measuring instruments; cosmographic instruments; mathematical instruments; levelling instruments; instruments containing eyepieces; surveying instruments; azimuth instruments; interfaces for computers; audio interfaces; ionization apparatus not for the treatment of air or water; satellite finder meters; spark-guards; coaxial cables; fibre optic cables; cables, electric; calipers; slide calipers; screw-tapping gauges; calorimeters; calculating machines; pocket calculators; decompression chambers; rearview cameras for vehicles; cinematographic cameras; thermal imaging cameras; mouth guards for sports; life-saving capsules for natural disasters; electronic pens [visual display units]; holders for electric coils; biometric identity cards; identity cards, magnetic; video game cartridges; toner cartridges, unfilled, for printers and photocopiers; ink cartridges, unfilled, for printers and photocopiers; memory cards for video game machines; encoded magnetic cards; riding helmets; protective helmets; carriers for dark plates [photography]; cathodes; spools [photography]; choking coils [impedance]; coils, electric; electromagnetic coils; cinematographic film, exposed; computer keyboards; solenoid valves [electromagnetic switches]; wire connectors [electricity]; thin client computers; downloadable cryptographic keys for receiving and spending crypto assets; encoded key cards; electronic book readers; electronic agendas; push buttons for bells; mouse pads; magnetic encoders; visors for helmets; collectors, electric; calibrating rings; smart rings; ring sizers; protective suits for aviators; commutators; compact discs [audio-video]; compact discs [read-only memory]; comparators; marine compasses; computers; laptop computers; tablet computers; notebook computers; wearable computers; condensers [capacitors]; contacts, electric; wind socks for indicating wind direction; traffic cones; branch boxes [electricity]; distribution boxes [electricity]; junction boxes [electricity]; battery boxes; cabinets for loudspeakers; diving suits; downloadable e-wallets; galena crystals [detectors]; covers for electric outlets; logs [measuring instruments]; lasers, not for medical purposes; lactodensimeters; lactometers; vacuum tubes [radio]; darkroom lamps [photography]; thermionic valves; amplifying tubes; flashlights [photography]; head cleaning tapes [recording]; magnetic tapes; videotapes; surveying chains; fire escapes; rulers [measuring instruments]; square rulers for measuring; slide-rules; contact lenses; correcting lenses [optics]; optical lenses; optical condensers; sounding lines; electricity conduits; measuring spoons; magnifying glasses [optics]; thread counters; magnets; decorative magnets; close-up lenses; crash test dummies; resuscitation mannequins [teaching apparatus]; mouse [computer peripheral]; trackballs [computer peripherals]; pressure gauges; security tokens [encryption devices]; divers' masks; solderers' helmets; protective masks, not for medical purposes; respiratory masks, other than for artificial respiration; materials for elec-

tricity mains [wires, cables]; voting machines; money counting and sorting machines; material testing instruments and machines; furniture especially made for laboratories; megaphones; portable media players; diaphragms [acoustics]; diaphragms for scientific apparatus; metal detectors for industrial or military purposes; digital weather stations; metronomes; rules [measuring instruments]; carpenters' rules; dressmakers' measures; mechanisms for coin-operated apparatus; mechanisms for counter-operated apparatus; coin-operated mechanisms for television sets; shutter releases [photography]; micrometers; microprocessors; microscopes; microtomes; microphones; audio mixers; modems; lightning conductors; monitors [computer hardware]; monitors [computer programs]; selfie sticks [hand-held monopods]; terminals [electricity]; junction sleeves for electric cables; teeth protectors; temperature indicator labels, not for medical purposes; knee-pads for workers; headphones; earpieces for remote communication; surveyors' levels; sound recording carriers; magnetic data media; optical data media; electronic sheet music, downloadable; computer game software, recorded; computer software, recorded; sheaths for electric cables; identification sheaths for electric wires; weighing machines; computer hardware; punched card machines for offices; life saving equipment; shoes for protection against accidents, irradiation and fire; objectives [lenses] [optics]; lenses for astrophotography; selfie lenses; egg-candlers; fire extinguishers; rescue laser signalling flares; electrified fences; limiters [electricity]; clothing for protection against accidents, irradiation and fire; clothing for protection against fire; asbestos clothing for protection against fire; clothing especially made for laboratories; survival blankets; ozonisers [ozonators]; octants; eyepieces; ohmmeters; wrist rests for use with computers; spectacle frames; oscillographs; plumb lines; mirrors [optics]; spectacles; sunglasses; goggles for sports; electronic collars to train animals; finger sizers; signalling panels, luminous or mechanical; biometric passports; wah-wah pedals; radio pagers; pince-nez; electronic pocket translators; transmitters [telecommunication]; telephone transmitters; transmitters of electronic signals; switches, electric; periscopes; data gloves; gloves for divers; gloves for protection against accidents; gloves for protection against X-rays for industrial purposes; asbestos gloves for protection against accidents; furnaces for laboratory use; droppers for measuring, other than for medical or household purposes; laboratory pipettes; pyrometers; planimeters; plane tables [surveying instruments]; plates for batteries; computer software platforms, recorded or downloadable; wafers for integrated circuits; printed circuit boards; compact disc players; cassette players; protective films adapted for computer screens; protective films adapted for smartphone screens; sound recording strips; X-ray films, exposed; films, exposed; life-saving rafts; animal signalling rattles for directing livestock; labora-

tory trays; digital signs; stands adapted for laptops; semi-conductors; polarimeters; personal digital assistants [PDAs]; fire pumps; measuring glassware; weight belts for divers; life belts; fuses; circuit breakers; converters, electric; telerupters; food analysis apparatus; diagnostic apparatus, not for medical purposes; distance recording apparatus; distance measuring apparatus; speed measuring apparatus [photography]; appliances for measuring the thickness of leather; apparatus for measuring the thickness of skins; speed checking apparatus for vehicles; teaching apparatus; time recording apparatus; apparatus and instruments for astronomy; surveying apparatus and instruments; weighing apparatus and instruments; nautical apparatus and instruments; navigational instruments; optical apparatus and instruments; apparatus and instruments for physics; chemistry apparatus and instruments; measuring apparatus; measuring devices, electric; boiler control instruments; meteorological instruments; naval signalling apparatus; observation instruments; navigation apparatus for vehicles [on-board computers]; satellite navigational apparatus; regulating apparatus, electric; telecommunication apparatus in the form of jewellery; precision measuring apparatus; audio- and video-receivers; prisms [optics]; computer software applications, downloadable; ticket printers; printers for use with computers; hemline markers; retorts' stands; apparatus for changing record player needles; drainers for use in photography; cleaning apparatus for phonograph records; fire beaters; sighting telescopes for firearms; telescopic sights for artillery; test tubes; pressure indicator plugs for valves; magnetic wires; telegraph wires; telephone wires; wires, electric; conductors, electric; copper wire, insulated; fuse wire; computer programs, recorded; computer game software, downloadable; computer programs, downloadable; computer operating programs, recorded; computer screen saver software, recorded or downloadable; record players; processors [central processing units]; rods for water diviners; electronic publications, downloadable; distribution consoles [electricity]; control panels [electricity]; radar apparatus; baby monitors; masts for wireless aerials; transmitting sets [telecommunication]; radios; vehicle radios; sprinkler systems for fire protection; frames for photographic transparencies; screens for photoengraving; flowmeters; walkie-talkies; voltage surge protectors; voltage regulators for vehicles; stage lighting regulators; light dimmers [regulators], electric; speed regulators for record players; cell switches [electricity]; washing trays [photography]; marking gauges [joinery]; T-squares for measuring; time switches, automatic; relays, electric; safety restraints, other than for vehicle seats and sports equipment; body harnesses for support when lifting loads; X-ray photographs, other than for medical purposes; rheostats; respirators for filtering air; retorts; refractometers; refractors; grids for batteries; security surveillance robots; laboratory robots; teaching robots; telepresence robots;

humanoid robots with artificial intelligence for use in scientific research; electric sockets; height measuring instruments; speaking tubes; horns for loudspeakers; subwoofers; saccharometers; optical fibres [light conducting filaments]; traffic-light apparatus [signalling devices]; dog whistles; signalling whistles; sports whistles; sextants; inductors [electricity]; safety nets; nets for protection against accidents; fire alarms; signals, luminous or mechanical; rescue flares, non-explosive and non-pyrotechnic; sirens; electronic access control systems for interlocking doors; scanners [data processing equipment]; hand-held electronic dictionaries; integrated circuit cards [smart cards]; smartglasses; smartphones; smartwatches; connections for electric lines; couplings, electric; sonars; sound locating instruments; lighting ballasts; resistances, electric; spectrograph apparatus; spectroscopes; speed indicators; alcoholmeters; satellites for scientific purposes; protection devices for personal use against accidents; audiovisual teaching apparatus; charging stations for electric vehicles; radiotelegraphy sets; radiotelephony sets; spectacle lenses; anti-glare glasses; optical glass; personal stereos; stereoscopes; stands for photographic apparatus; stroboscopes; fire boats; sulfimeters; bags adapted for laptops; drying racks [photography]; spherometers; integrated circuits; printed circuits; counters; parking meters; mileage recorders for vehicles; revolution counters; abacuses; egg timers [sandglasses]; taximeters; ear plugs for divers; tachometers; television apparatus; telegraphs [apparatus]; telescopes; teleprompters; teleprinters; cordless telephones; mobile telephones; theodolites; credit card terminals; interactive touch screen terminals; thermo-hygrometers; thermometers, not for medical purposes; thermostats; thermostats for vehicles; climate control digital thermostats; crucibles [laboratory]; tone arms for record players; totalizers; transistors [electronic]; transponders; protractors [measuring instruments]; transformers [electricity]; step-up transformers; resuscitation training simulators; vehicle breakdown warning triangles; triodes; starter cables for motors; discharge tubes, electric, other than for lighting; capillary tubes for laboratory use; neon signs; Pitot tubes; X-ray tubes not for medical purposes; telephone receivers; headgear being protective helmets; squares for measuring; gauges; quantity indicators; petrol gauges; water level indicators; electric loss indicators; light-emitting electronic pointers; slope indicators; levels [instruments for determining the horizontal]; mercury levels; spirit levels; urinometers; amplifiers; particle accelerators; electric installations for the remote control of industrial operations; steering apparatus, automatic, for vehicles; balancing apparatus; video recorders; sound reproduction apparatus; invoicing machines; tape recorders; protection devices against X-rays, not for medical purposes; railway traffic safety appliances; data processing apparatus; oxygen transensing apparatus; theft prevention installations, electric; devices for the projection of virtual keyboards; film cu-

ting apparatus; drying apparatus for photographic prints; optical character readers; centering apparatus for photographic transparencies; dosage dispensers; battery chargers; chargers for electric accumulators; chargers for electronic cigarettes; acoustic alarms; sounding apparatus and machines; apparatus for editing cinematographic film; cathodic anti-corrosion apparatus; wearable activity trackers with sleep monitoring function; couplers [data processing equipment]; wearable activity trackers; anti-theft warning apparatus; computer peripheral devices; anti-interference devices [electricity]; demagnetizing apparatus for magnetic tapes; acoustic couplers; alarms; fog signals, non-explosive; whistle alarms; adding machines; readers [data processing equipment]; heat regulating apparatus; photocopiers [photographic, electrostatic, thermic]; electric and electronic effects units for musical instruments; bar code readers; downloadable ring tones for mobile phones; downloadable image files; downloadable music files; animated cartoons; filters for respiratory masks; filters for ultraviolet rays, for photography; filters for use in photography; USB flash drives; magic lanterns; optical lanterns; signal lanterns; cameras [photography]; glazing apparatus for photographic prints; shutters [photography]; dark-rooms [photography]; photometers; flash-bulbs [photography]; digital photo frames; enlarging apparatus [photography]; photovoltaic cells; containers for contact lenses; spectacle cases; containers for microscope slides; cases for smartphones; cases especially made for photographic apparatus and instruments; chromatography apparatus for laboratory use; chronographs [time recording apparatus]; laboratory centrifuges; spectacle chains; cyclotrons; compasses for measuring; frequency meters; time clocks [time recording devices]; Petri dishes; sleeves for laptops; covers for personal digital assistants [PDAs]; covers for tablet computers; fire blankets; chips [integrated circuits]; jigs [measuring instruments]; pedometers; meteorological balloons; electrified rails for mounting spot lights; asbestos screens for firemen; fire hose; virtual reality headsets; protective helmets for sports; head guards for sports; lifeboats; snorkels; cell phone straps; spectacle cords; tripods for cameras; switchboards; distribution boards [electricity]; equalizers [audio apparatus]; screens [photography]; workmen's protective face-shields; projection screens; radiology screens for industrial purposes; fluorescent screens; exposure meters [light meters]; ducts [electricity]; galvanic cells; downloadable graphics for mobile phones; epidiascopes; ergometers; armatures [electricity]; black boxes [data recorders].

10 – Analysers for bacterial identification for medical purposes; cholesterol meters; blood testing apparatus; testing apparatus for medical purposes; anaesthetic apparatus; galvanic therapeutic appliances; apparatus for artificial respiration; apparatus for the treatment of deafness; physical exercise apparatus for medical purposes; body rehabilitation apparatus for medical pur-

poses; dental apparatus and instruments; surgical apparatus and instruments; resuscitation apparatus; dental apparatus, electric; physiotherapy apparatus; bed vibrators; hot air therapeutic apparatus; diagnostic apparatus for medical purposes; traction apparatus for medical purposes; radiotherapy apparatus; microdermabrasion apparatus; fumigation apparatus for medical purposes; apparatus for the regeneration of stem cells for medical purposes; apparatus for DNA and RNA testing for medical purposes; apparatus and installations for the production of X-rays, for medical purposes; magnetic resonance imaging [MRI] apparatus for medical purposes; orthodontic appliances; medical cooling apparatus for treating heatstroke; medical cooling apparatus for use in therapeutic hypothermia; radiological apparatus for medical purposes; X-ray apparatus for medical purposes; hearing aids; nasal aspirators; trusses; maternity belts; support bandages; bandages, elastic; cupping glasses; dental burs; acupressure bands; bracelets for medical purposes; anti-nausea wristbands; anti-rheumatism bracelets; feeding bottles; air cushions for medical purposes; vaporizers for medical purposes; hot air vibrators for medical purposes; vibromassage apparatus; gastroscopes; haemocytometers; glucometers; lice combs; surgical sponges; pill cutters; defibrillators; dialyzers; containers especially made for medical waste; clips, surgical; mirrors for dentists; mirrors for surgeons; probes for medical purposes; urethral probes; artificial teeth; acupuncture needles; suture needles; needles for medical purposes; orthopedic articles; pill crushers; biodegradable bone fixation implants; surgical implants comprised of artificial materials; inhalers; hydrogen inhalers; injectors for medical purposes; incubators for medical purposes; incubators for babies; obstetric apparatus; obstetric apparatus for cattle; electric acupuncture instruments; surgical cutlery; insufflators; chambers for inhalers; endoscopy cameras for medical purposes; cannulae; droppers for medical purposes; dropper bottles for medical purposes; heart rate monitoring apparatus; heart pacemakers; catheters; catgut; draw-sheets for sick beds; enema apparatus for medical purposes; clips for dummies; artificial skin for surgical purposes; menstrual cups; biomagnetic rings for therapeutic or medical purposes; teething rings; anti-rheumatism rings; compressors [surgical]; thermo-electric compresses [surgery]; oxygen concentrators for medical purposes; abdominal corsets; corsets for medical purposes; crutches; dentists' armchairs; armchairs for medical or dental purposes; waterbeds for medical purposes; air beds for medical purposes; beds specially made for medical purposes; feeding bottle valves; love dolls [sex dolls]; lasers for medical purposes; lamps for medical purposes; curing lamps for medical purposes; quartz lamps for medical purposes; ultraviolet ray lamps for medical purposes; lancets; kinesiology tapes; lenses [intraocular prostheses] for surgical implantation; spoons for administering medicine; protective masks for medical purposes;

res; masks for use by medical personnel; respiratory masks for artificial respiration; anaesthetic masks; LED masks for therapeutic purposes; therapeutic facial masks; gum massagers for babies; suture materials; childbirth mattresses; air mattresses for medical purposes; furniture especially made for medical purposes; water bags for medical purposes; douche bags; breast pumps; body fat monitors; body composition monitors; urinals being vessels; portable hand-held urinals; teeth protectors for dental purposes; temperature indicator labels for medical purposes; knee bandages, orthopaedic; tips for crutches; nanorobots for medical purposes; fingerstalls for medical purposes; bone void fillers comprised of artificial materials; medical guidewires; pumps for medical purposes; thread, surgical; knives for surgical purposes; scissors for surgery; ambulance stretchers; stretchers, wheeled; boots for medical purposes; orthopaedic footwear; clothing especially for operating rooms; compression garments; blankets, electric, for medical purposes; supports for flat feet; keratometers; ophthalmoscopes; cooling pads for first aid purposes; slings [support bandages]; gloves for massage; gloves for medical purposes; pessaries; saws for surgical purposes; ear picks; cooling patches for medical purposes; spittoons for medical purposes; plaster bandages for orthopaedic purposes; orthopaedic bandages for joints; abdominal pads; cushions for medical purposes; pads for preventing pressure sores on patient bodies; air pillows for medical purposes; soporific pillows for insomnia; heating cushions, electric, for medical purposes; patient hoists; abdominal belts; galvanic belts for medical purposes; hypogastric belts; belts for medical purposes; orthopaedic belts; umbilical belts; belts, electric, for medical purposes; condoms; aerosol dispensers for medical purposes; sphygmotensimeters; pulse meters; esthetic massage apparatus; massage apparatus; veterinary apparatus and instruments; medical apparatus and instruments; urological apparatus and instruments; brushes for cleaning body cavities; appliances for washing body cavities; corn knives; incontinence sheets; sterile sheets, surgical; surgical drapes; hair prostheses; artificial eyes; artificial breasts; dentures; artificial limbs; artificial jaws; ice bags for medical purposes; toe separators for orthopaedic purposes; surgical bougies; orthodontic rubber bands; X-ray photographs for medical purposes; respirators for artificial respiration; surgical robots; ear trumpets; strait jackets; sex toys; scalpels; tongue scrapers; dummies for babies; feeding bottle teats; baby feeding dummies; receptacles for applying medicines; spirometers [medical apparatus]; vaginal syringes; implantable subcutaneous drug delivery devices; hearing protectors; contraceptives, non-chemical; orthopaedic soles; stents; stethoscopes; medical examination tables; operating tables; commode chairs; basins for medical purposes; bed pans; instrument cases for use by doctors; arch supports for footwear; suspensory bandages; ear plugs [hearing protection devices]; ther-

mal packs for first aid purposes; thermometers for medical purposes; tomographs for medical purposes; trocars; walking sticks for medical purposes; quad canes for medical purposes; drainage tubes for medical purposes; X-ray tubes for medical purposes; radium tubes for medical purposes; balling guns; therapeutic devices for the prevention of snoring; cosmetic devices for photon light therapy; sleep aid devices inducing sleep by emitting aroma; sleep aid devices inducing sleep by emitting sound; sleep aid devices inducing sleep by emitting light; protection devices against X-rays, for medical purposes; apparatus for acne treatment; filters for ultraviolet rays, for medical purposes; patient examination gowns; walking aids for medical purposes; wheeled walkers to aid mobility; walking frames for disabled persons; cases fitted for medical instruments; elastic stockings for surgical purposes; stockings for varices; splints, surgical; laser therapy helmets for treating alopecia; tongue depressors for medical purposes; syringes for injections; syringes for medical purposes; hypodermic syringes; uterine syringes; urethral syringes; pins for artificial teeth; castrating pincers; forceps; robotic exoskeleton suits for medical purposes; radiology screens for medical purposes; electrodes for medical use; electrocardiographs; brain pacemakers.

11 – Lampshades; defrosters for vehicles; disinfectant apparatus for medical purposes; distillation apparatus; desiccating apparatus; disinfectant apparatus; tanning beds; coffee roasters; beverage cooling apparatus; fruit roasters; refrigerating apparatus and machines; freezers; heating and cooling apparatus for dispensing hot and cold beverages; coolers for furnaces; refining towers for distillation; waffle irons, electric; fans [air-conditioning]; fans [parts of air-conditioning installations]; electric fans for personal use; roasting spits; refrigerating display cabinets; heated display cabinets; extractor hoods for kitchens; gas condensers, other than parts of machines; acetylene generators; hydrants; fairy lights for festive decoration; burners; acetylene burners; gas burners; burners for lamps; germicidal burners; incandescent burners; oxyhydrogen burners; laboratory burners; oil burners; alcohol burners; hot water bottles; footwarmers, electric or non-electric; bed warmers; USB-powered hand warmers; pocket warmers; warming pans; roasting apparatus; food dehydrators, electric; lampshade holders; stills; fog machines; refrigerating containers; candle lighters; grill lighters; gas lighters; friction lighters for igniting gas; chimney blowers; coils [parts of distilling, heating or cooling installations]; furnace ash boxes; electric appliances for making yogurt; heating apparatus; cool boxes, electric; refrigerating chambers; fireplaces, domestic; chimney flues; coffee capsules, empty, for electric coffee machines; structural framework for ovens; air valves for steam heating installations; electrically heated carpets; light bulbs; light bulbs, electric; solar thermal collectors [heating]; distillation columns; furnace grates; ventilation hoods; ventilation

hoods for laboratories; lamp globes; air-conditioning apparatus; air conditioners for vehicles; gas boilers; coffee machines, electric; forges, portable; lava rocks for use in barbecue grills; couscous cookers, electric; lights, electric, for Christmas trees; acetylene flares; safety lamps; gas lamps; curling lamps; nail lamps; curing lamps, not for medical purposes; light bulbs for directional signals for vehicles; arc lamps; laboratory lamps; oil lamps; ultraviolet ray lamps, not for medical purposes; miners' lamps; electric lamps; chandeliers; barbecues; bread baking machines; watering machines for agricultural purposes; ice-cream making machines; soya milk making machines, electric; pounded rice cake making machines, electric, for household purposes; multicookers; footmuffs, electrically heated; heaters for heating irons; immersion heaters; brackets for gas burners; anti-splash tap nozzles; heat pumps; filaments for electric lamps; magnesium filaments for lighting; heating filaments, electric; luminous house numbers; socks, electrically heated; heating apparatus for defrosting vehicle windows; loading apparatus for furnaces; kiln furniture [supports]; refrigerating appliances and installations; directional lights for bicycles; electrically heated clothing; blankets, electric, not for medical purposes; fabric steamers; lamp reflectors; vehicle reflectors; hearths; electric cooktops; food steamers, electric; steam boilers, other than parts of machines; pasteurisers; lamp mantles; sockets for electric lights; coffee percolators, electric; stoves [heating apparatus]; bakers' ovens; hot air ovens; kitchen ranges [ovens]; microwave ovens [cooking apparatus]; microwave ovens for industrial purposes; incinerators; kilns; solar furnaces; dental ovens; furnaces, other than for laboratory use; feeding apparatus for heating boilers; heating plates; cooking stoves; hot plates; wine cellars, electric; heaters, electric, for feeding bottles; aquarium heaters; USB-powered cup heaters; aquarium lights; heating cushions, electric, not for medical purposes; tortilla presses, electric; apparatus for dehydrating food waste; fumigation apparatus, not for medical purposes; gas scrubbing apparatus; oil-scrubbing apparatus; glue-heating appliances; drying apparatus for fodder and forage; ice machines and apparatus; cooling appliances and installations; cooking apparatus and installations; lighting apparatus and installations; cooking rings; lighting apparatus for vehicles; light-emitting diodes [LED] lighting apparatus; regulating and safety accessories for gas pipes; roasting jacks; plate warmers; anti-glare devices for vehicles [lamp fittings]; rotisseries; radiator caps; searchlights; diving lights; light projectors; heat guns; radiators [heating]; central heating radiators; radiators, electric; light diffusers; nuclear reactors; heat regenerators; roasters; beverage urns, electric; lamps; interior lamps with the function of selectable lighting modes; ceiling lights; hydroponic growing systems; lighting installations for air vehicles; pressure cookers [autoclaves], electric; gas scrubbers [parts of gas installations]; lamp glasses; water sterilizers; malt roas-

ters; tobacco roasters; tajines, electric; heat exchangers, other than parts of machines; thermo-pots, electric; standard lamps; bread toasters; discharge tubes, electric, for lighting; lamp chimneys; luminous tubes for lighting; pipes [parts of sanitary installations]; flues for heating boilers; boiler pipes [tubes] for heating installations; humidifiers; humidifiers for central heating radiators; air-conditioning installations; desalination plants; installations for processing nuclear fuel and nuclear moderating material; watering installations, automatic; cooling installations for liquids; milk cooling installations; cooling installations for tobacco; purification installations for sewage; ventilation [air-conditioning] installations and apparatus; ventilation [air-conditioning] installations for vehicles; cooling installations and machines; heating installations; heaters for vehicles; heating installations [water]; polymerisation installations; flare stacks for use in the oil industry; ash conveyor installations, automatic; air cooling apparatus; sous-vide cookers, electric; aquarium filtration apparatus; cooking utensils, electric; flaming torches; headlights for automobiles; vehicle headlights; filters for air conditioning; filters for drinking water; wicks adapted for oil stoves; lights for automobiles; bicycle lights; motorcycle lights; lights for vehicles; electric torches; head torches; lanterns for lighting; candle lanterns; street lamps; Chinese lanterns; fountains; ornamental fountains; chocolate fountains, electric; air fryers; deep fryers, electric; fittings, shaped, for furnaces; oven fittings made of fireclay; bread-making machines; refrigerators; refrigerators, cooling apparatus and freezers for medical storage purposes; chromatography apparatus for industrial purposes; kettles, electric; dampers [heating]; bok sterilization apparatus; refrigerating cabinets; carbon for arc lamps.

13 – Acetyl-nitrocellulose; ammunition; ammunition for firearms; explosives; ammonium nitrate explosives; pyrophoric substances; primings [fuses]; fuses for explosives, for use in mines; cartridge cases; noise-suppressors for guns; hand grenades; detonators; dynamite; lead shot for hunting; sighting mirrors for guns and rifles; breeches of firearms; detonating caps, other than toys; rifles; hammers for guns and rifles; gun carriages [artillery]; automatic firearm ammunition belts; gunstocks; mortars [firearms]; mines [explosives]; Bengal lights; firing platforms; artillery guns [cannons]; motorized weapons; firearms; hunting firearms; side arms [firearms]; tear-gas weapons; cartridge pouches; cartridges; explosive cartridges; firecrackers; guncotton; pistols [arms]; air pistols [weapons]; flare pistols; explosive powders; gunpowder; powder horns; shoulder straps for weapons; sights, other than telescopic sights, for artillery; sights, other than telescopic sights, for firearms; machine guns; cannons; rocket launchers; signal rocket flares; revolvers; belts adapted for ammunition; guns [weapons]; harpoon guns [weapons]; detonating plugs; fog signals, explosive; rescue flares, explosive or pyrotechnic; trigger

guards for guns and rifles; projectiles [weapons]; shells [projectiles]; ballistic weapons; rockets [projectiles]; sprays for personal defence purposes; pyrotechnic products; rifle barrels; tanks [weapons]; torpedoes; cartridge loading apparatus; apparatus for filling cartridge belts; fireworks; fuses for explosives; rifle cases; trunnions for heavy weapons; detonating fuses for explosives; cleaning brushes for firearms.

14 – Agates; diamonds; amulets [jewellery]; anchors [clock- and watchmaking]; barrels [clock- and watchmaking]; bracelets [jewellery]; bracelets made of embroidered textile [jewellery]; watch bands; charms for key rings; jewellery charms; brooches [jewellery]; alarm clocks; pins [jewellery]; ornamental pins; tie pins; jewellery hat pins; beads for making jewellery; pearls made of ambroid [pressed amber]; busts of precious metal; jewellery rolls; jet, unwrought or semi-wrought; jewellery findings; key rings [split rings with trinket or decorative fob]; retractable key rings; pearls [jewellery]; copper tokens; tie clips; cuff links; clasps for jewellery; badges of precious metal; gold, unwrought or beaten; cloisonné jewellery [jewelry (am.)]; works of art of precious metal; jewellery; ivory jewellery; jewellery of yellow amber; iridium; cabochons; precious stones; semi-precious stones; spun silver [silver wire]; necklaces [jewellery]; split rings of precious metal for keys; rings [jewellery, jewelry (am.)]; boxes of precious metal; presentation boxes for jewellery; watch cases [parts of watches]; clock cases; pendulums [clock- and watchmaking]; medals; lockets [jewellery]; precious metals, unwrought or semi-wrought; movements for clocks and watches; clockworks; misbaha [prayer beads]; coins; gold thread [jewellery]; threads of precious metal [jewellery]; silver thread [jewellery]; olivine [gems]; osmium; palladium; platinum [metal]; chronometric instruments; watch springs; crucifixes of precious metal, other than jewellery; crucifixes as jewellery; rhodium; ruthenium; stopwatches; silver, unwrought or beaten; earrings; ingots of precious metals; alloys of precious metal; statues of precious metal; watch glasses; paste jewellery; watch hands; clock hands; ornaments of jet; shoe jewellery; hat jewellery; figurines of precious metal; presentation boxes for watches; chronographs [watches]; chronometers; chronoscopes; chains [jewellery]; watch chains; dials [clock- and watchmaking]; atomic clocks; watches; sundials; clocks and watches, electric; control clocks [master clocks]; clocks; wrist-watches; rosaries; jewellery boxes; spinel [precious stones].

15 – Accordions; harps; balalaikas [stringed musical instruments]; banjos; bandonions; drums [musical instruments]; basses [musical instruments]; buccins [trumpets]; hats with bells [musical instruments]; Jews' harps [musical instruments]; violas; horsehair for bows for musical instruments; bagpipes; harmonic; melodicas; guitars; oboes; gongs; clarions; robotic drums; musical instruments; stringed musical instru-

ments; electronic musical instruments; reeds; tuning forks; colophony for stringed musical instruments; carillons [musical instruments]; castanets; catgut for musical instruments; keyboards for musical instruments; piano keyboards; keys for musical instruments; piano keys; valves for musical instruments; clarionets; tuning hammers; drumheads; pegs for musical instruments; bow nuts for musical instruments; handbells [musical instruments]; double basses; concertinas; cornets [musical instruments]; xylophones; music rolls [piano]; perforated music rolls; lyres; kettledrums; mandolins; plectrums; bellows for musical instruments; mallets for musical instruments; mouthpieces for musical instruments; ocarinas; organs; drumsticks; conductors' batons; sticks for bows for musical instruments; pedals for musical instruments; bridges for musical instruments; pipa [Chinese guitars]; chin rests for violins; kettledrum frames; stands for musical instruments; turning apparatus for sheet music; music stands; intensity regulators for mechanical pianos; straps for musical instruments; horns [musical instruments]; saxophones; music synthesizers; violins; bows for musical instruments; harp strings; strings for musical instruments; piano strings; suona [Chinese trumpets]; mutes for musical instruments; tambourines; tom-toms; cymbals; triangles [musical instruments]; trombones; trumpets; wind pipes for organs; harmoniums; flutes; bamboo flutes; pianos; cases for musical instruments; huqin [Chinese violins]; zithers; barrel organs; musical boxes; sheng [Chinese musical wind instruments].

16 – Fountain pens; aquarelles; albums; almanacs; document laminators for office use; mimeograph apparatus and machines; atlases; posters; banknotes; banners of paper; paper bows, other than haberdashery or hair decorations; name badges [office requisites]; table linen of paper; tickets; baggage claim check tags of paper; forms, printed; announcement cards [stationery]; glitter for stationery purposes; note books; pads [stationery]; drawing pads; wristbands for the retention of writing instruments; pamphlets; booklets; paper; paper sheets [stationery]; waxed paper; paper for medical examination tables; paper for recording machines; paper for radiograms; papers for painting and calligraphy; electrocardiograph paper; drawer liners of paper, perfumed or not; wood pulp paper; carbon paper; copying paper [stationery]; parchment paper; writing paper; rice paper; luminous paper; toilet paper; wrapping paper; filter paper; washi; blotters; newsletters; rollers for typewriters; house painters' rollers; composing sticks; modelling wax, not for dental purposes; signboards of paper or cardboard; sewing patterns; bunting of paper; newspapers; electrotypes; hectographs; modelling clay; polymer modelling clay; terrestrial globes; drawing sets; engravings; slate pencils; pencil leads; document holders [stationery]; pencil holders; chalk holders; holders for cheque books; holders for stamps [seals]; page holders; name badge holders [office requisites]; diagrams; table runners of

paper; engraving plates; writing slates; blackboards; galley racks [printing]; drawing boards; advertisement boards of paper or cardboard; duplicators; punches [office requisites]; cream containers of paper; magazines [periodicals]; money clips; clips for name badge holders [office requisites]; tags for index cards; pen clips; bookmarks; etching needles; tracing needles for drawing purposes; periodicals; printed publications; paper shredders for office use; graphic representations; credit card imprinters, non-electric; paper creators [office requisites]; graining combs; drawing instruments; calendars; tracing paper; tracing cloth; tracing patterns; gums [adhesives] for stationery or household purposes; lithographic stones; ink stones [ink reservoirs]; pencils; pencil lead holders; charcoal pencils; pictures; transfers [decalcomanias]; paintings [pictures], framed or unframed; cardboard; wood pulp board [stationery]; hat boxes of cardboard; cards; index cards [stationery]; geographical maps; paper tapes and cards for the recordal of computer programmes; trading cards, other than for games; perforated cards for Jacquard looms; catalogues; spools for inking ribbons; flower-pot covers of paper; paintbrushes; painters' brushes; writing brushes; typewriter keys; glue for stationery or household purposes; isinglass for stationery or household purposes; gluten [glue] for stationery or household purposes; starch paste [adhesive] for stationery or household purposes; printing blocks; books; colouring books; manifolds [stationery]; comic books; drawing pins; cigar bands; envelopes [stationery]; boxes of paper or cardboard; cases for stamps [seals]; paint boxes for use in schools; correcting fluids [office requisites]; printed coupons; stencils [stationery]; French curves; paper ribbons, other than haberdashery or hair decorations; gummed tape [stationery]; typewriter ribbons; barcode ribbons; adhesive tapes for stationery or household purposes; correcting tapes [office requisites]; inking ribbons; self-adhesive tapes for stationery or household purposes; square rulers for drawing; drawing rulers; flyers; absorbent sheets of paper or plastic for foodstuff packaging; humidity control sheets of paper or plastic for foodstuff packaging; viscose sheets for wrapping; sheets of reclaimed cellulose for wrapping; plastic bubble packs for wrapping or packaging; steel letters; type [numerals and letters]; lithographs; letter trays; paint trays; architects' models; postage stamps; plastics for modelling; graphic prints; modelling materials; teaching materials [except apparatus]; sealing compounds for stationery purposes; adhesives [glues] for stationery or household purposes; padding materials of paper or cardboard; bookbinding material; packing [cushioning, stuffing] materials of paper or cardboard; packaging material made of starches; filtering materials of paper; dish mats of paper; addressing machines; pencil sharpening machines, electric or non-electric; bookbinding apparatus and machines [office equipment]; typewriters, electric or non-electric; franking machines for office use; chalk for lit-

hography; writing chalk; tailors' chalk; marking chalk; spray chalk; bags [envelopes, pouches] of paper or plastics, for packaging; garbage bags of paper or of plastics; plastic bags for pet waste disposal; painters' easels; hand-rests for painters; printing sets, portable [office requisites]; bibs of paper; bibs, sleeved, of paper; stickers [stationery]; fingerstalls for office use; writing cases [stationery]; cords for bookbinding; paper knives [letter openers]; enveloped sheet music; numbering apparatus; bottle envelopes of paper or cardboard; sealing wafers; covers [stationery]; passport holders; protective covers for books; plastic cling film, extensible, for palletization; embroidery designs [patterns]; handwriting specimens for copying; oleographs; musical greeting cards; greeting cards; postcards; etchings; conical paper bags; paper bags for use in the sterilization of medical instruments; bags for microwave cooking; palettes for painters; ink sticks; pantographs [drawing instruments]; loose-leaf binders; files [office requisites]; folders for papers; papier mâché; pastels [crayons]; modelling paste; pen cases; pen wipers; office perforators; pens [office requisites]; nibs of gold; nibs; steel pens; drawing pens; song books; seals [stamps]; sealing stamps; clipboards; address plates for addressing machines; handkerchiefs of paper; plastic film for wrapping; transparencies [stationery]; desk mats; trays for sorting and counting money; coasters of paper; bookends; stamp stands; mats of paper for beer glasses; stands for pens and pencils; photograph stands; obliterating stamps; inking pads; stamp pads; binding strips [bookbinding]; face towels of paper; towels of paper; inking sheets for document reproducing machines; inking sheets for duplicators; cloth for bookbinding; gummed cloth for stationery purposes; printers' blankets, not of textile; portraits; paperweights; writing cases [sets]; inkstands; office requisites, except furniture; writing materials; writing instruments; drawing materials; school supplies [stationery]; adhesive tape dispensers [office requisites]; hand labelling appliances; printed matter; lithographic works of art; prospectuses; printed timetables; ledgers [books]; printers' galleys; indexes; paper cutters [office requisites]; rubber erasers; elastic bands for offices; T-squares for drawing; graphic reproductions; retractable reels for name badge holders [office requisites]; penholders; marking pens [stationery]; tissues of paper for removing make-up; paper wipes for cleaning; dental tray covers of paper; place mats of paper; tablemats of paper; tablecloths of paper; paper clasps; document files [stationery]; scrapers [erasers] for offices; paper-clips; clips for offices; erasing products; biological samples for use in microscopy [teaching materials]; histological sections for teaching purposes; steatite [tailor's chalk]; writing board erasers; composing frames [printing]; sealing wax; arithmetical tables; placards of paper or cardboard; writing or drawing books; fabrics for bookbinding; stationery; pencil sharpeners, electric or non-electric; stencil plates; stencils for decorating food and beve-

rages; cardboard tubes; Indian inks; moisteners [office requisites]; moisteners for gummed surfaces [office requisites]; squares for drawing; chart pointers, non-electronic; bottle wrappers of paper or cardboard; envelope sealing machines for offices; sealing machines for offices; vignetting apparatus; apparatus for mounting photographs; stapling presses [office requisites]; manuals [handbooks]; figurines of papier mâché; paper coffee filters; flags of paper; silver paper; moulds for modelling clays [artists' materials]; photo-engravings; photographs [printed]; stencil cases; canvas for painting; chromolithographs [chromos]; animation cels; compasses for drawing; numbers [type]; artists' watercolour saucers; ink; correcting ink [heliography]; inkwells; blueprints; stencils; erasing shields; balls for ball-point pens; desktop cabinets for stationery [office requisites]; printing type; address stamps; stamps [seals]; shields [paper seals]; prints [engravings]; labels of paper or cardboard.

17 – Shock-absorbing buffers of rubber; fittings, not of metal, for compressed air lines; asbestos; cellulose acetate, semi-processed; balata; floating anti-pollution barriers; asbestos paper; paper for electrical capacitors; insulating paper; cotton wool for packing [caulking]; mineral wool [insulator]; asbestos felt; insulating felt; asbestos fibres; plastic fibres, other than for textile use; carbon fibres, other than for textile use; vulcanized fibre; gutta-percha; foam supports for flower arrangements [semi-finished products]; dielectrics [insulators]; lute; insulators; insulators for railway tracks; insulators for electric mains; insulators for cables; asbestos millboards; liquid rubber; synthetic rubber; rubber, raw or semi-worked; valves of india-rubber or vulcanized fibre; clack valves of rubber; rings of rubber; water-tight rings; insulating paints; insulating varnish; latex [rubber]; duct tapes; insulating bands; adhesive tapes, other than stationery and not for medical or household purposes; self-adhesive tapes, other than stationery and not for medical or household purposes; asbestos sheets; viscose sheets, other than for wrapping; foil of regenerated cellulose, other than for wrapping; insulating oils; insulating oil for transformers; reinforcing materials, not of metal, for pipes; weatherstripping compositions; caulking materials; brake lining materials, partly processed; soundproofing materials; insulating materials; insulating refractory materials; padding materials of rubber or plastics; rubber material for recapping tyres; non-conducting materials for retaining heat; boiler composition to prevent the radiation of heat; packing [cushioning, stuffing] materials of rubber or plastics; sealant compounds for joints; filtering materials of semi-processed foams of plastic; filtering materials of semi-processed films of plastic; compositions to prevent the radiation of heat; bags [envelopes, pouches] of rubber, for packaging; pipe muffs, not of metal; rubber sleeves for protecting parts of machines; asbestos packing; clutch linings; threads of plastic for soldering; plastic filaments for 3D printing; threads of

plastic materials, not for textile use; threads of rubber, other than for textile use; elastic yarns, other than for textile use; door stops of rubber; window stops of rubber; stops of rubber; dock bumpers of rubber; insulating gloves; plastic substances, semi-processed; plastic sheeting for agricultural purposes; plastic film, other than for wrapping; anti-glare films for windows [tinted films]; asbestos coverings; bark coverings for sound insulation; asbestos cloth; rubber stoppers; gaskets; expansion joint fillers; cylinder jointings; washers of rubber or vulcanized fibre; pipe gaskets; draught excluder strips; rubber solutions; gum, raw or semi-worked; mica, raw or partly processed; acrylic resins, semi-processed; synthetic resins, semi-processed; junctions, not of metal, for pipes; substances for insulating buildings against moisture; chemical compositions for repairing leaks; glass wool for insulation; fibreglass for insulation; asbestos fabrics; fibreglass fabrics for insulation; insulating fabrics; flexible hoses, not of metal; hoses of textile material; connecting hose for vehicle radiators; waterproof packings; rubber seals for jars; fittings, not of metal, for flexible pipes; fittings, not of metal, for rigid pipes; foils of metal for insulating; ebonite moulds; asbestos slate; slag wool [insulator]; watering hose; canvas hose pipes; cords of rubber; asbestos safety curtains; insulating plaster; ebonite.

18 – Mountaineering sticks; slings for carrying infants; luggage tags; pocket wallets; saddlecloths for horses; business card cases; reins; reins for guiding children; sling bags for carrying infants; harness fittings; credit card cases [wallets]; parts of rubber for stirrups; chamois leather, other than for cleaning purposes; umbrellas; parasols; saddlery; frames for umbrellas or parasols; frames for bags [structural parts of bags]; card cases [notecases]; cases of leather or leatherboard; valves of leather; whips; imitation leather; leather, unworked or semi-worked; leatherboard; casings, of leather, for springs; umbrella rings; hat boxes of leather; boxes of leather or leatherboard; boxes of vulcanized fibre; purses; chain mesh purses; fastenings for saddles; butts [parts of hides]; saddle trees; bags [envelopes, pouches] of leather, for packaging; moleskin [imitation of leather]; travelling sets [leatherware]; knee-pads for horses; muzzles; halters; vanity cases, not fitted; furniture coverings of leather; clothing for pets; covers for animals; trimmings of leather for furniture; collars for animals; hiking sticks; conference folders; music cases; goldbeaters' skin; cat o' nine tails; leather leashes; pads for horse saddles; horseshoes; girths of leather; leathercloth; horse blankets; garment bags for travel; shoulder belts [straps] of leather; briefcases; traces [harness]; fur; randsels [Japanese school satchels]; haversacks; leather straps; straps for soldiers' equipment; harness straps; straps for skates; straps of leather [saddlery]; chin straps, of leather; stirrup leathers; umbrella handles; walking stick handles; suitcase handles; grips for holding shopping bags; rucksacks; backpacks for carrying

infants; travelling bags; riding saddles; net bags for shopping; umbrella or parasol ribs; stirrups; bags; bags for climbers; tool bags, empty; handbags; beach bags; saddlebags; compression cubes adapted for luggage; bags for sports; bags for campers; reusable shopping bags; wheeled shopping bags; school bags; pouch baby carriers; travelling trunks; trunks [luggage]; nose bags [feed bags]; bridoons; walking sticks; umbrella sticks; walking stick seats; tefillin [phylacteries]; bits for animals [harness]; bridles [harness]; harness for animals; key cases; horse collars; suitcases; motorized suitcases; suitcases with wheels; valises; attaché cases; covers for horse saddles; umbrella covers; kid; curried skins; animal skins; cattle skins; leather cord; blinkers [harness]; labels of leather; game bags [hunting accessories].

19 – Aquaria [structures]; alabaster; door frames, not of metal; asbestos cement; asphalt; beams, not of metal; balustrades, not of metal; huts; swimming pools [structures], not of metal; silos, not of metal; arbours [structures], not of metal; concrete; bitumen; plastic landscape edgings; joists, not of metal; telephone booths, not of metal; beacons, not of metal, non-luminous; building paper; busts of stone, concrete or marble; bird baths [structures], not of metal; binding agents for making briquettes; binding material for road repair; stained-glass windows; felt for building; aviaries [structures], not of metal; gates, not of metal; diving boards, not of metal; geotextiles; gypsum [building material]; plaster; clay; potters' clay; earth for bricks; roofing shingles; gravel; aquarium gravel; granite; armoured doors, not of metal; doors, not of metal; swing doors, not of metal; accordion doors, not of metal; folding doors, not of metal; coal tar; chimney pots, not of metal; prefabricated houses [kits], not of metal; parquet floor boards; memorial plaques, not of metal; wood for making household utensils; veneer wood; mouldable wood; chimney shafts, not of metal; outdoor blinds, not of metal and not of textile; jalousies, not of metal; roof gutters, not of metal; street gutters, not of metal; agglomerated bagasses of cane [building material]; signs, non-luminous and non-mechanical, not of metal, for roads; non-luminous and non-mechanical signs, not of metal; limestone; lime; fences, not of metal; works of stonemasonry; works of art of stone, concrete or marble; cabanas, not of metal; soundproof booths, transportable, not of metal; stone; rubble; artificial stone; building stone; paint spraying booths, not of metal; gravestones; reeds for building; horticultural frames, not of metal; framework, not of metal, for building; greenhouse frames, not of metal; cornices, not of metal; bitumen paper for building; wood pulp board for building; paperboard for building; skating rinks [structures], not of metal; quartz; caissons for construction work under water; bricks; firebricks; water-pipe valves, not of metal or plastic; drain traps [valves], not of metal or plastic; cask wood; mooring bollards, not of metal; cement posts; pillars, not of

metal, for building; chimney cowls, not of metal; brackets, not of metal, for building; buildings, not of metal; buildings, transportable, not of metal; stringers [parts of staircases], not of metal; silica [quartz]; roofing, not of metal; roofing, not of metal, incorporating photovoltaic cells; manhole covers, not of metal; xylolith; chicken-houses, not of metal; manufactured timber; sawn timber; building timber; wood, semi-worked; staircases, not of metal; road marking sheets and strips of synthetic material; reinforcing materials, not of metal, for building; bituminous products for building; tar; road coating materials; materials for making and coating roads; fireclay; pitch; building materials, not of metal; refractory construction materials, not of metal; masts [poles], not of metal; raw chalk; calcareous marl; mosaics for building; mouldings, not of metal, for building; marble; slate powder; porches [structures], not of metal; tombs, not of metal; flashing, not of metal, for building; roof flashing, not of metal; perches; duckboards, not of metal; wall claddings, not of metal, for building; mouldings, not of metal, for cornices; moldings, not of metal, for building; coatings [building materials]; tomb or grave enclosures, not of metal; laths, not of metal; wood panelling; wall linings, not of metal, for building; pallings, not of metal; crash barriers, not of metal, for roads; latticework, not of metal; windows, not of metal; olivine for building; shuttering, not of metal, for concrete; posts, not of metal, for power lines; props, not of metal; rubber bearings for seismic isolation of buildings; branching pipes, not of metal; fair huts; tombs [monuments], not of metal; monuments, not of metal; acoustic panels, not of metal; wainscotting, not of metal; signalling panels, non-luminous and non-mechanical, not of metal; building panels, not of metal; parquet flooring; partitions, not of metal; lintels, not of metal; casement windows, not of metal; aquarium sand; silver sand; sand, except foundry sand; sandstone for building; tarred strips for building; planks of wood for building; rocket launching platforms, not of metal; platforms, prefabricated, not of metal; wall tiles, not of metal; floor tiles, not of metal; tiles, not of metal, for building; paving slabs, not of metal; cement slabs; grave slabs, not of metal; tile floorings, not of metal; slabs, not of metal, for building; scaffolding, not of metal; armour-plating, not of metal; asphalt paving; wood paving; paving blocks, not of metal; luminous paving blocks; macadam; fireproof cement coatings; bituminous coatings for roofing; roof coverings, not of metal; wooden floor boards; cladding, not of metal, for building; linings, not of metal, for building; fireplace mantles, not of metal; door panels, not of metal; floors, not of metal; sills, not of metal; porphyry [stone]; ceilings, not of metal; floating docks, not of metal, for mooring boats; agglomerated cork for building; window frames, not of metal; mortar for building; asbestos mortar; tanks of masonry; scantlings [carpentry]; furrings of wood; vinyl siding; pilings, not of metal; pigsties, not of me-

tal; insect screens, not of metal; burial vaults, not of metal; schists; shutters, not of metal; statues of stone, concrete or marble; alabaster glass; safety glass; glass granules for road marking; window glass for building; window glass, other than vehicle window glass; building glass; plate glass [windows] for building; insulating glass for building; enamelled glass, for building; tombstone stelae, not of metal; stables, not of metal; advertisement columns, not of metal; posts, not of metal; telegraph posts, not of metal; hips for roofing; stair-treads [steps], not of metal; tombstone plaques, not of metal; greenhouses, transportable, not of metal; terra-cotta [building material]; penstock pipes, not of metal; water-pipes, not of metal; gutter pipes, not of metal; ducts, not of metal, for ventilating and air-conditioning installations; drain pipes, not of metal; chimneys, not of metal; rigid pipes, not of metal, for building; sandstone pipes; turnstiles, not of metal; tufa; angle irons, not of metal; lengthening pieces, not of metal, for chimneys; bicycle parking installations, not of metal; plywood; figurines of stone, concrete or marble; flagpoles [structures], not of metal; foundry moulds, not of metal; rock crystal; cement for blast furnaces; cement for furnaces; magnesia cement; cement; pantiles, not of metal; roofing tiles, not of metal; slate; roofing slates; slag [building material]; slag stone; railway sleepers, not of metal; wood veneers; clinker ballast; concrete building elements; letter boxes of masonry.

20 – Picture frame brackets; bumper guards for cots, other than bed linen; reels, not of metal, non-mechanical, for flexible hoses; pulleys of plastics for blinds; bolts, not of metal; casks of wood for decanting wine; mooring buoys, not of metal; casks, not of metal; barrels, not of metal; identification bracelets, not of metal; sideboards; busts of wood, wax, plaster or plastic; costume stands; bolsters; fans for personal use, non-electric; work benches; vice benches [furniture]; valet stands; coatstands; coat hangers; shoulder poles [yokes]; screws, not of metal; display stands; showcases [furniture]; newspaper display stands; jewellery organizer displays; collars, not of metal, for fastening pipes; comb foundations for beehives; signboards of wood or plastics; loading gauge rods, not of metal, for railway wagons; nuts, not of metal; covers for clothing [wardrobe]; shoe pegs, not of metal; nesting boxes; coffins; doors for furniture; curtain holders, not of textile material; dowels, not of metal; divans; towel dispensers, fixed, not of metal; door closers, not of metal, non-electric; kennels for household pets; bird-houses; keyboards for hanging keys; display boards; plugs [dowels], not of metal; containers, not of metal, for liquid fuel; troughs, not of metal, for mixing mortar; oil drainage containers, not of metal; packaging containers of plastic; indoor window blinds [furniture]; indoor window blinds of paper; indoor window blinds of woven wood; indoor window blinds of textile; flower-stands [furniture]; curtain tie-backs; clips, not of metal, for cables and pipes; binding

screws, not of metal, for cables; clips of plastic for sealing bags; rivets, not of metal; imitation tortoiseshell; locks, not of metal, for vehicles; padlocks, other than electronic, not of metal; locks, other than electric, not of metal; bead curtains for decoration; door bolts, not of metal; bottle closures, not of metal; closures, not of metal, for containers; latches, not of metal; mirrors [looking glasses]; hand-held mirrors [toilet mirrors]; numberplates, not of metal; bamboo, unworked or semi-worked; scratching posts for cats; animal claws; animal hooves; coral; meerschaum; whalebone, unworked or semi-worked; stag antlers; tortoiseshell; horn, unworked or semi-worked; animal horns; rattan; corozo; plaited straw, except matting; wickerwork; hampers [baskets] for the transport of items; works of art of wood, wax, plaster or plastic; cabinet work; reeds [plaiting materials]; settees; jerry-cans, not of metal; curtain rods; index cabinets [furniture]; reels of wood for yarn, silk, cord; drain traps [valves] of plastic; water-pipe valves of plastic; valves, not of metal, other than parts of machines; staves of wood; plastic keys; plastic key cards, not encoded and not magnetic; mats for infant playpens; sleeping pads [mats or cushions]; saw horses; bed casters, not of metal; furniture casters, not of metal; brush mountings; chopping blocks [tables]; wind chimes [decoration]; door bells, not of metal, non-electric; bottle caps, not of metal; bassinets; tent pegs, not of metal; curtain rings; split rings, not of metal, for keys; chests of drawers; console tables; containers, not of metal [storage, transport]; floating containers, not of metal; lecterns; dog kennels; bakers' bread baskets; baskets, not of metal; Moses baskets; bottle casings of wood; tool boxes, not of metal, empty; taps, not of metal, for casks; armchairs; hairdressers' chairs; deck chairs; beds; hospital beds; waterbeds, not for medical purposes; bedsteads of wood; air beds, not for medical purposes; cots for babies; edgings of plastic for furniture; brackets, not of metal, for furniture; screw tops, not of metal, for bottles; table tops; sash fasteners, not of metal, for windows; coathooks, not of metal; curtain hooks; clothes hooks, not of metal; bag hangers, not of metal; beds for household pets; nesting boxes for household pets; ladders of wood or plastics; playpens for babies; tailors' dummies; mattresses; air mattresses, not for medical purposes; camping mattresses; furniture; furniture of metal; inflatable furniture; office furniture; school furniture; mobiles [decoration]; door knockers, not of metal; shoe dowels, not of metal; curtain rails; runners, not of metal, for sliding doors; legs for furniture; feet for furniture; house numbers, not of metal, non-luminous; cask hoops, not of metal; door stops, not of metal or rubber; window stops, not of metal or rubber; mouldings for picture frames; bed bases; plastic ramps for use with vehicles; furniture partitions of wood; freestanding partitions [furniture]; mother-of-pearl, unworked or semi-worked; ambroid plates; loading pallets, not of metal; handling pallets, not of metal;

metal; mirror tiles; head-rests [furniture]; trays, not of metal; stakes, not of metal, for plants or trees; trestles [furniture]; magazine racks; book rests [furniture]; stands for calculating machines; reusable baby changing mats; pet cushions; pillows; cushions; head support cushions for babies; anti-roll cushions for babies; air cushions, not for medical purposes; air pillows, not for medical purposes; head positioning pillows for babies; removable covers for sinks; racks [furniture]; library shelves; shelves for file cabinets; furniture shelves; shelves for storage; wood ribbon; straw edgings; towel stands [furniture]; hat stands; bathtub grab bars, not of metal; cask stands, not of metal; inflatable publicity objects; counters [tables]; bedding, except linen; corks for bottles; corks; stoppers, not of glass, metal or rubber; sealing caps, not of metal; stair rods; flower-pot pedestals; standing desks; embroidery frames; dispensers for dog waste bags, fixed, not of metal; shells; picture frames; sections of wood for beehives; crucifixes of wood, wax, plaster or plastic, other than jewellery; reservoirs, not of metal nor of masonry; fodder racks; curtain rollers; door handles, not of metal; knobs, not of metal; fishing baskets; writing desks; bath seats for babies; seats of metal; benches [furniture]; vats, not of metal; honeycombs; sofas; plugs, not of metal; statues of wood, wax, plaster or plastic; oyster shells; silvered glass [mirrors]; shelving units; ambroid bars; umbrella stands; gun racks; trolleys for computers [furniture]; lap desks; dressing tables; washstands [furniture]; tables; typing desks; drafting tables; massage tables; tables of metal; wall-mounted baby changing platforms; saw benches [furniture]; desks; portable desks; tea trolleys; dinner wagons [furniture]; steps [ladders], not of metal; chairs [seats]; high chairs for babies; shower chairs; chests, not of metal; placards of wood or plastics; nameplates, not of metal; stools; footstools; crates; trolleys [furniture]; straw plaits; mobile boarding stairs, not of metal, for passengers; straw mattresses; decorations of plastic for foodstuffs; beehives; bathroom vanities [furniture]; door fasteners, not of metal; window fasteners, not of metal; funerary urns; window closers, not of metal, non-electric; door openers, not of metal, non-electric; window openers, not of metal, non-electric; winding spools, not of metal, non-mechanical, for flexible hoses; figurines of wood, wax, plaster or plastic; hand-held flagpoles, not of metal; door fittings, not of metal; coffin fittings, not of metal; bed fittings, not of metal; furniture fittings, not of metal; window fittings, not of metal; infant walkers; garment covers [storage]; stuffed animals; stuffed birds; hinges, not of metal; chaise longues; poles, not of metal; screens [furniture]; luggage lockers; filing cabinets; medicine cabinets; plate racks [furniture]; meat safes; bookcases; wardrobes; cupboards; window pulleys, not of metal; bamboo curtains; slatted indoor blinds; screens for fireplaces [furniture]; labels of plastic; yellow amber; lockers [furniture]; drawers for furniture; chests for toys; tool chests, not of metal, empty; boxes of

wood or plastic; letter boxes, not of metal or masonry; bottle racks.

21 – Autoclaves, non-electric, for cooking; indoor aquaria; wine aerators; buckets; cookie jars; candle jars [holders]; china ornaments; dishes; vegetable dishes; saucers; goblets; boxes for sweets; bottles; demijohns; busts of porcelain, ceramic, earthenware or glass; vases; epergnes; fruit bowls; inflatable bath tubs for babies; bird baths; baby baths, portable; plungers for clearing blocked drains; waffle irons, non-electric; diaper disposal pails; ice buckets; mop wringer buckets; buckets made of woven fabrics; whisks, non-electric, for household purposes; cooking skewers of metal; towel rails and rings; clothing stretchers; hair for brushes; horsehair for brush-making; funnels; candle warmers, electric and non-electric; carpet beaters [hand instruments]; signboards of porcelain or glass; candle extinguishers; heads for electric toothbrushes; flower pots; chamber pots; glue-pots; cruets; decanters; large-toothed combs for the hair; combs for animals; tea cosies; abrasive sponges for scrubbing the skin; make-up sponges; sponges for household purposes; bath sponges; sponge holders; stands for portable baby baths; toothpick holders; soap holders; table napkin holders; holders for flowers and plants [flower arranging]; tea bag rests; shaving brush stands; toilet paper holders; toilet paper dispensers; soap dispensers; plug-in diffusers for mosquito repellents; aromatic oil diffusers, other than reed diffusers, electric and non-electric; ironing boards; cutting boards for the kitchen; bread boards; washing boards; crushers for kitchen use, non-electric; strainers for household purposes; smoke absorbers for household purposes; containers for household or kitchen use; kitchen containers; glass jars [carboys]; heat-insulated containers; heat-insulated containers for beverages; thermally insulated containers for food; glass flasks [containers]; closures for pot lids; chamois leather for cleaning; toothpicks; ceramics for household purposes; majolica; works of art of porcelain, ceramic, earthenware, terra-cotta or glass; kitchen grinders, non-electric; cleaning instruments, hand-operated; cabarets [trays]; stew-pans; couscous cooking pots, non-electric; flower-pot covers, not of paper; shaving brushes; make-up brushes; basting brushes; cages for household pets; birdcages; baking mats; ladles for serving wine; polishing leather; hot pots, not electrically heated; glass bulbs [receptacles]; shoe trees; napkin rings; poultry rings; rings for birds; disposable aluminium foil containers for household purposes; coin banks; piggy banks; bread baskets for household purposes; baskets for household purposes; waste paper baskets; feeding troughs; pet feeding bowls, automatic; mangers for animals; lunch boxes; tea caddies; washtubs; earthenware saucepans; mess-tins; cauldrons; coffee percolators, non-electric; coffeepots, non-electric; coffee grinders, hand-operated; beer mugs; tankards; rat traps; pot lids; aquarium hoods; butter-dish covers; dish covers; cheese-dish covers; reusable silicone fo-

od covers; buttonhooks; reusable ice cubes; jugs; perfume burners; watering cans; fly traps; insect traps; ice cream scoops; mixing spoons [kitchen utensils]; basting spoons [cooking utensils]; pie servers; cosmetic spatulas; spatulas for kitchen use; litter boxes for pets; butter dishes; material for brush-making; polishing materials for making shiny, except preparations, paper and stone; tablemats, not of paper or textile; noodle machines, hand-operated; lint removers, electric or non-electric; pasta makers, hand-operated; polishing apparatus and machines, for household purposes, non-electric; pepper mills, hand-operated; mills for household purposes, hand-operated; feather-dusters; brooms; isothermic bags; decorating bags for confectioners; bowls [basins]; pet feeding bowls; mosaics of glass, not for building; dishcloths; saucepan scourers of metal; soap boxes; mouse traps; cooking pot sets; nozzles for watering cans; pouring spouts; wine pourers; cake decorating tips and tubes; nozzles for watering hose; fitted picnic baskets, including dishes; toilet cases; floss for dental purposes; fibreglass thread, other than for textile use; cookie [biscuit] cutters; pastry cutters; sprinklers; syringes for watering flowers and plants; egg yolk separators; cotton waste for cleaning; wool waste for cleaning; cleaning tow; cold packs for chilling food and beverages; chopsticks; cocktail stirrers; food steamers, non-electric; pepper pots; abrasive mitts for scrubbing the skin; oven mitts; animal grooming gloves; gloves for household purposes; car washing mitts; polishing gloves; gardening gloves; pestles for kitchen use; droppers for household purposes; wine-tasting pipettes; droppers for cosmetic purposes; plates for diffusing aromatic oil; plates to prevent milk boiling over; dripping pans; trays for household purposes; trays of paper, for household purposes; lazy susans; heaters for feeding bottles, non-electric; candelabra [candlesticks]; trivets [table utensils]; coasters, not of paper or textile; grill supports; menu card holders; knife rests for the table; flat-iron stands; egg cups; abrasive pads for kitchen purposes; scouring pads; drinking troughs; serving ladles; powdered glass for decoration; pottery; pots; cooking pots, non-electric; painted glassware; tableware, other than knives, forks and spoons; porcelain ware; earthenware; crystal [glassware]; cosmetic utensils; cleaning utensils for toilets; trouser presses; toothpaste tube squeezers; tortilla presses, non-electric [kitchen utensils]; deodorizing apparatus for personal use; cruet sets for oil and vinegar; make-up removing appliances; spice sets; apparatus for wax-polishing, non-electric; bottle openers, electric and non-electric; glove stretchers; boot jacks; crumb trays; tie presses; potholders; clothes-pegs; glass stoppers; powder compacts, empty; perfume vaporizers; powder puffs; dusting apparatus, non-electric; foam toe separators for use in pedicures; combs; electric combs; grills [cooking utensils]; sifters [household utensils]; drinking horns; shoe horns; candle drip rings; broom handles; salad bowls; place mats, not of paper or textile; beve-

rage urns, non-electric; sugar bowls; beaters, non-electric; egg separators, non-electric, for household purposes; services [dishes]; coffee services [tableware]; liqueur sets; tea services [tableware]; cooking mesh bags, other than for microwaves; sieves [household utensils]; cinder sifters [household utensils]; tea strainers; siphon bottles for carbonated water; rolling pins, domestic; frying pans; squeegees [cleaning instruments]; steel wool for cleaning; currycombs; blenders, non-electric, for household purposes; scoops for household purposes; fruit presses, non-electric, for household purposes; straws for drinking; salt cellars; drinking vessels; vessels for making ices and ice cream, non electric; refrigerating bottles; bulb basters; cups of paper or plastic; glasses [receptacles]; drinking glasses; statues of porcelain, ceramic, earthenware, terra-cotta or glass; figurines of porcelain, ceramic, earthenware, terra-cotta or glass; glass for vehicle windows [semi-finished product]; fused silica [semi-worked product], other than for building; plate glass [raw material]; opal glass; glass, unworked or semi-worked, except building glass; opaline glass; glass incorporating fine electrical conductors; enamelled glass, not for building; glass wool, other than for insulation; vitreous silica fibres, other than for textile use; fibreglass, other than for insulation or textile use; mortars for kitchen use; portable cool boxes, non-electric; soup tureens; drying racks for laundry; rotary washing lines; tajines, non-electric; basins [receptacles]; table plates; paper plates; disposable table plates; graters for kitchen use; insulating flasks; indoor terrariums [plant cultivation]; indoor terrariums [vivariums]; roller tubes for peeling garlic; cloth for washing floors; polishing cloths; cloths for cleaning; dusting cloths [rags]; furniture dusters; atomizers for household purposes; wax-polishing appliances, non-electric, for shoes; water apparatus for cleaning teeth and gums; electric devices for attracting and killing insects; watering devices; utensils for household purposes; kitchen utensils; cooking utensils, non-electric; coffee filters, non-electric; flasks; hip flasks; drinking bottles for sports; boot trees; moulds [kitchen utensils]; egg poachers; cake moulds; ice cube moulds; cookery moulds; deep fryers, non-electric; comb cases; bread bins; fly swatters; teapots; kettles, non-electric; cups; garlic presses [kitchen utensils]; ironing board covers, shaped; tea infusers; decorative glass spheres; mops; mop wringers; cocktail shakers; corkscrews, electric and non-electric; animal bristles [brushware]; pig bristles for brush-making; brushes; dishwashing brushes; ski wax brushes; brushes for cleaning tanks and containers; lamp-glass brushes; horse brushes; scrubbing brushes; toothbrushes; toothbrushes, electric; carpet sweepers; shoe brushes; tarbrushes, long handled; toilet brushes; electric brushes, except parts of machines; eyebrow brushes; nail brushes; eyelash brushes; nutcrackers; ice tongs; salad tongs; sugar tongs; decanter tags; nest eggs, artificial;

boxes for dispensing paper towels; dustbins; window-boxes; boxes of glass.

22 – String; twine made of paper; packing string; tarpaulins; wadding for padding and stuffing upholstery; wadding for filtering; ropes; whipcord; packing rope; seaweed for stuffing; hemp fibres; carbon fibres for textile use; esparto grass; coconut fibre; plastic fibres for textile use; ramie fibre; textile fibres; horsehair; hammocks; jute; wax ends; ropes, not of metal; kapok; cocoons; raw linen [flax]; strips for tying-up vines; ladder tapes for venetian blinds; wrapping or binding bands, not of metal; rope ladders; linters; liber; padding materials, not of rubber, plastics, paper or cardboard; packing [cushioning, stuffing] materials, not of rubber, plastics, paper or cardboard; bags [envelopes, pouches] of textile, for packaging; bivouac sacks being shelters; laundry bags; sacks for the transport and storage of materials in bulk; body bags; mail bags; mesh bags for washing laundry; cloth bags specially adapted for the storage of diapers; twine for nets; binding thread, not of metal, for agricultural purposes; thread, not of metal, for wrapping or binding; braces, not of metal, for handling loads; bindings, not of metal; sawdust; straw wrappers for bottles; tow; cotton tow; silk flock; tents; sails; sails for ski sailing; canvas for sails; brattice cloth; feathers for stuffing upholstery; feathers for bedding; purse seines; animal hair; fibrous gaskets for ships; down [feathers]; eiderdown; raffia; straps, not of metal, for handling loads; hemp bands; fleece wool; net pens for fish farming; nets; snares [nets]; nets for camouflage; fishing nets; animal feeding nets; sisal; straw for stuffing upholstery; sheaf-binding yarns; outdoor blinds of textile; vitreous silica fibres for textile use; glass fibres for textile use; slings, not of metal, for handling loads; wood shavings; raw fibrous textile; awnings of synthetic materials; awnings of textile; network; grasses for upholstering; car towing ropes; cables, not of metal; cotton waste [flock] for padding and stuffing; schappe [raw silk waste]; wool flock; raw cotton; vehicle covers, not fitted; dust sheets; covers for camouflage; raw silk; carded wool; camel hair; flock [stuffing]; upholstery wool [stuffing]; wood wool; combed wool; raw or treated wool; shorn wool; cords for hanging pictures; sash cords; pig bristles.

23 – Thread of metal for embroidery; yarn; embroidery thread and yarn; jute thread and yarn; coir thread and yarn; rayon thread and yarn; threads of plastic materials for textile use; fibreglass thread for textile use; linen thread and yarn; hemp thread and yarn; rubber thread for textile use; cotton thread and yarn; sewing thread and yarn; silk thread and yarn; woollen thread and yarn; darning thread and yarn; elastic thread and yarn for textile use; spun thread and yarn; spun cotton; spun silk; spun wool; chenille yarn.

24 – Frieze [cloth]; banners of textile or plastic; velvet; household linen; diapered linen; bath linen, except clothing; bed linen; table linen, not of paper; cot

bumpers [bed linen]; buckram; fustian; sleeping bag liners; felt; bunting of textile or plastic; gauze [cloth]; damask; jersey [fabric]; table runners, not of paper; drugget; shower curtains of textile or plastic; curtains of textile or plastic; net curtains; zephyr [cloth]; canvas for tapestry or embroidery; bolting cloth; baby buntings; crepe [fabric]; crepon; marabouts [cloth]; furniture coverings of textile; fabrics for textile use; filtering materials of textile; wall hangings of textile; non-woven textile fabrics; plastic material [substitute for fabrics]; textile material; tablemats of textile; bivouac sacks being covers for sleeping bags; sleeping bags; sleeping bags for babies; moleskin [fabric]; muslin fabric; pillowcases; mattress covers; bed blankets; blankets for household pets; brocades; diaper changing cloths for babies; handkerchiefs of textile; picnic blankets; travelling rugs [lap robes]; coasters of textile; bed valances; linings [textile]; hat linings, of textile, in the piece; curtain holders of textile material; bed covers; bed covers of paper; furniture coverings of plastic; face towels of textile; towels of textile; cloth; hemp cloth; gummed cloth, other than for stationery purposes; printers' blankets of textile; door curtains; bedsheets; eiderdowns [down coverlets]; bath mitts; shrouds; glass cloths [towels]; cloths for removing make-up; place mats of textile; table napkins of textile; mosquito nets; calico; oilcloth for use as tablecloths; tablecloths, not of paper; billiard cloth; taffeta [cloth]; ticks [mattress covers]; tick [linen]; fabric; lingerie fabric; fabric, impervious to gases, for aeronautical balloons; jute fabric; fabric for footwear; ramie fabric; esparto fabric; rayon fabric; fibreglass fabrics for textile use; adhesive fabric for application by heat; linen cloth; upholstery fabrics; hemp fabric; lining fabric for footwear; traced cloths for embroidery; chenille fabric; printed calico cloth; knitted fabric; cotton fabrics; silk fabrics for printing patterns; woollen cloth; elastic woven fabrics; fabric imitating animal skins; haircloth [sackcloth]; cheese cloth; tulle; flags of textile or plastic; flannel [fabric]; trellis [cloth]; covers for cushions; fitted toilet lid covers of fabric; covers [loose] for furniture; pillow shams; cheviots [cloth]; silk [cloth]; labels of textile.

25 – Wimples; bandanas [neckerchiefs]; underwear; sweat-absorbent underwear; berets; overalls; boas [necklets]; teddies [underclothing]; boxer shorts; ankle boots; ski boots; boots for sports; breeches for wear; trousers; football shoes; brassieres; adhesive bras; valenki [felted boots]; mittens; collars [clothing]; detachable collars; shirt yokes; veils [clothing]; gabardines [clothing]; galoshes; neckties; ascots; gaiters; spats; leggings [leg warmers]; boot uppers; corselets; jerseys [clothing]; waistcoats; sports jerseys; hosiery; heels; heelpieces for footwear; hoods [clothing]; hat frames [skeletons]; pockets for clothing; scarves; caps being headwear; kimonos; cap peaks; visors being headwear; tights; slips [underclothing]; combinations [clothing]; wet suits for water-skiing; bodices [lingerie]; corsets [underclothing]; suits; bathing suits; mas-

querade costumes; beach clothes; headscarves; leotards; jackets [clothing]; stuff jackets [clothing]; fishing vests; leggings [trousers]; liveries; camisoles; sports singlets; cuffs; short-sleeve shirts; mantillas; coats; sleep masks; furs [clothing]; fingerless gloves; mitres [hats]; muffs [clothing]; footmuffs, not electrically heated; bibs, not of paper; bibs, sleeved, not of paper; fur stoles; hairdressing capes; heel protectors for shoes; ear muffs [clothing]; socks; sweat-absorbent socks; footwear; gymnastic shoes; beach shoes; sports shoes; clothing; paper clothing; outerclothing; embroidered clothing; ready-made clothing; motorists' clothing; cyclists' clothing; clothing for gymnastics; clothing of imitations of leather; latex clothing; clothing of leather; waterproof clothing; clothing incorporating LEDs; uniforms; clothing containing slimming substances; fittings of metal for footwear; maniples; overcoats; knickers; parkas; pelerines; gloves [clothing]; ski gloves; pyjamas; bathing trunks; shirt fronts; pocket squares; dresses; headbands [clothing]; garters; sock suspenders; stocking suspenders; ready-made linings [parts of clothing]; dress shields; soles for footwear; braces [suspenders] for clothing; half-boots; lace boots; ponchos; girdles; belts [clothing]; sashes for wear; money belts [clothing]; layettes [clothing]; non-slipping devices for footwear; heelpieces for stockings; welts for footwear; chasubles; shirts; wooden shoes; sandals; bath sandals; boots; jumper dresses; saris; sarongs; sweaters; footwear uppers; inner soles; albs; bath slippers; togas; knitwear [clothing]; underpants; shoes; slippers; skull caps; turbans; headwear; aprons [clothing]; judo uniforms; karate uniforms; tee-shirts; rash guards; dressing gowns; bath robes; top hats; tips for footwear; stockings; sweat-absorbent stockings; shawls; paper hats [clothing]; shower caps; bathing caps; neck tube scarves; studs for football shoes; hats; babies' pants [underwear]; gaiter straps; pelisses; esparto shoes or sandals; skirts; petticoats; skorts.

26 – Appliqués [haberdashery]; haberdashery bows; fringes; mica spangles; shoe eyelets; false beards; charms, other than for jewellery, key rings or key chains; brooches [clothing accessories]; hat pins, other than jewellery; entomological pins; pins, other than jewellery; beads, other than for making jewellery; wreaths of artificial flowers; artificial Christmas wreaths; artificial Christmas wreaths incorporating lights; false hair; human hair; lace for edgings; artificial garlands; artificial Christmas garlands; artificial Christmas garlands incorporating lights; darning lasts; expanding bands for holding sleeves; frills [lace-work]; trouser clips for cyclists; hair grips; hair barrettes; heat adhesive patches for repairing textile articles; blouse fasteners; shoe fasteners; fastenings for clothing; fastenings for suspenders; belt clasps; hook and pile fastening tapes; zip fasteners; zippers for bags; badges for wear, not of precious metal; competitors' numbers; needles; embroidery needles; needles for wool combing machines; binding needles; sadd-

lers' needles; shoemakers' needles; sewing needles; darning needles; boxes for needles; lace trimmings; embroidery; haberdashery [dressmakers' articles], except thread; decorative articles for the hair; heat adhesive patches for decoration of textile articles [haberdashery]; edgings for clothing; braids; gold embroidery; silver embroidery; bobbins for retaining embroidery floss or wool [not parts of machines]; tassels [haberdashery]; snap fasteners; sewing boxes; plaited hair; false hems; hooks [haberdashery]; crochet hooks; rug hooks; hooks for corsets; shoe hooks; haberdashery ribbons; ribbons for the hair; ribbons and bows, not of paper, for gift wrapping; lingerie tapes; breast lift tapes; prize ribbons; hatbands; elastic ribbons; letters for marking linen; numerals for marking linen; monogram tabs for marking linen; sewing kits; toupees; sewing thimbles; needle-threaders; skirt flounces; bows for the hair; spangles for clothing; hair curling papers; wigs; feathers [clothing accessories]; birds' feathers [clothing accessories]; ostrich feathers [clothing accessories]; eyelets for clothing; picot [lace]; corset busks; hair bands; brassards; tapes for curtain headings; shoulder pads for clothing; pin cushions; needle cushions; top-knots [pompoms]; hair curlers, electric and non-electric, other than hand implements; buckles [clothing accessories]; shoe buckles; buttons; ornamental novelty badges [buttons]; artificial plants, other than Christmas trees; rosettes [haberdashery]; frills for clothing; hair nets; chenille [passementerie]; knitting needles; cords for trimming; shoe trimmings; trimmings for clothing; hat trimmings; false moustaches; festoons [embroidery]; artificial fruit; needle cases; artificial flowers; shuttles for making fishing nets; hair colouring caps; bodkins; hair extensions; shoe laces; cords for clothing; woollen laces; hair pins; hair curling pins; collar supports.

27 – Artificial turf; yoga mats; floor mats, fire-resistant, for fireplaces and barbecues; carpets; carpets for automobiles; bath mats; non-slip mats; linoleum; wall hangings, not of textile; mats of woven rope for ski slopes; wallpaper; textile wallpaper; carpet underlay; gymnastic mats; vinyl floor coverings; floor coverings; textile wallcoverings; door mats; tatami mats; mats; reed mats.

28 – Arcade video game machines; video game machines; gaming machines for gambling; amusement machines, automatic and coin-operated; toy vehicles; swimming pools [play articles]; trampolines; novelty toys for parties; scratch cards for playing lottery games; golf bag tags; starting blocks for sports; bodyboards; boomerangs; dolls' feeding bottles; tricycles for infants [toys]; stationary exercise bicycles; creels [fishing traps]; shuttlecocks; spinning tops [toys]; dumb-bells; gyroscopes and flight stabilizers for model aircraft; jigsaw puzzles; clay pigeons [targets]; punching bags; bite sensors [fishing tackle]; hang gliders; joysticks for video games; flying discs [toys]; discs for sports; dolls' houses; playhouses for chil-

dren; dominoes; swimming kickboards; paddleboards; surfboards; spring boards [sports articles]; skateboards; sailboards; chessboards; draughtboards; drones [toys]; darts; Christmas trees of synthetic material; cups for dice; swimming jackets; ascenders [mountaineering equipment]; kites; needles for pumps for inflating sports balls; toys; toys for pets; stuffed toys; inflatable games for swimming pools; plush toys; toy mobiles; novelty toys for playing jokes; fidget toys; games; portable games and toys incorporating telecommunication functions; board games; table-top games; portable games with liquid crystal displays; ring games; building games; toy imitation cosmetics; swimming pool air floats; kaleidoscopes; bladders of balls for games; rosin used by athletes; edges of skis; trading cards for games; bingo cards; playing cards; fairground ride apparatus; reels for fishing; rocking horses; swings; yoga swings; skittles; skittles [games]; billiard cues; golf clubs; hockey sticks; baby gyms; seal skins [coverings for skis]; bells for Christmas trees; dolls' rooms; controllers for game consoles; controllers for toys; confetti; ice skates; roller skates; in-line roller skates; dice; paintball guns [sports apparatus]; ski bindings; dolls' beds; roulette wheels; fish hooks; building blocks [toys]; dolls; flippers for diving; flippers for swimming; swimming webs; rhythmic gymnastics ribbons; fishing lines; gut for fishing; bows for archery; skis; waterskis; roller skis; mah-jong; toy models; hunting game calls; puppets; masks [playthings]; carnival masks; theatrical masks; fencing masks; toy dough; toy putty; matryoshka dolls; masts for sailboards; ball pitching machines; teddy bears; chalk for billiard cues; targets; electronic targets; scale model kits [toys]; scale model vehicles; kite reels; balls for games; artificial fishing bait; billiard table cushions; knee guards [sports articles]; billiard cue tips; elbow guards [sports articles]; backgammon games; pumps for inflating sports balls; climbers' harness; dolls' clothes; fencing weapons; play tents; ski sticks for roller skis; ski sticks; twirling batons; paragliders; pachinkos; baseball gloves; boxing gloves; golf gloves; gloves for games; batting gloves [accessories for games]; fencing gauntlets; piñatas; toy pistols; toy air pistols; percussion caps [toys]; caps for pistols [toys]; protective films adapted for screens for portable games; rattles [playthings]; horseshoe games; candle holders for Christmas trees; Christmas tree stands; sole coverings for skis; water wings; floats for fishing; swimming belts; waist trimmer exercise belts; decoys for hunting or fishing; scent lures for hunting or fishing; archery implements; soap bubbles [toys]; divot repair tools [golf accessories]; billiard markers; video game consoles; handheld consoles for playing video games; protective paddings [parts of sports suits]; rackets; protective cups for sports; surfboard leashes; harness for sailboards; weight lifting belts [sports articles]; toy robots; sling shots [sports articles]; rollers for stationary exercise bicycles; harpoon guns [sports articles]; plush toys

with attached comfort blanket; scooters [toys]; sleds [sports articles]; bob-sleighs; skeleton sleds; butterfly nets; landing nets for anglers; nets for sports; tennis nets; bite indicators [fishing tackle]; slot machines [gaming machines]; appliances for gymnastics; quoits; bar-bells; fishing tackle; artificial snow for Christmas trees; snowshoes; snowboards; remote-controlled toy vehicles; clay pigeon traps; billiard tables; coin-operated billiard tables; tables for table tennis; strings for rackets; gut for rackets; golf bags, with or without wheels; cricket bags; golf bag trolleys; slides [playthings]; body-building apparatus; machines for physical exercises; men's athletic supporters [sports articles]; rods for fishing; ornaments for Christmas trees, except lights, candles and confectionery; tennis ball throwing apparatus; conjuring apparatus; apparatus for games; bowling apparatus and machinery; toy figures; counters [discs] for games; chips for gambling; foosball tables; party poppers [party novelties]; Christmas crackers [party novelties]; bags especially designed for surfboards; bags especially designed for skis; marbles for games; billiard balls; party balloons; balls for playing bowls; paintballs [ammunition for paintball guns] [sports apparatus]; snow globes; chess games; draughts [games]; poles for pole vaulting; paper party hats; shin guards [sports articles]; camouflage screens [sports articles]; chest expanders [exercisers].

29 – Agar-agar for culinary purposes; aloe vera prepared for human consumption; alginates for culinary purposes; andouillettes; anchovy, not live; peanuts, prepared; artichokes, preserved; albumen for culinary purposes; white of eggs; beans, preserved; soya beans, preserved, for food; broth; ginger jam; citrus jam; ham; fatty substances for the manufacture of edible fats; laver, preserved; edible birds' nests; cabbage rolls stuffed with meat; peas, preserved; mushrooms, preserved; guacamole; game, not live; gelatine; meat jellies; jellies for food; fruit jelly spreads; yolk of eggs; coconut fat; bone oil for food; lard; suet for food; edible fats; fruit-based snack food; milk substitutes; soya patties; tofu patties; charcuterie; raisins; caviar; aubergine paste; vegetable marrow paste; fish roe, prepared; ginger, preserved; crystallized ginger; pickled ginger; yogurt; sauerkraut; cassoulet; quark; kephir; kimchi; isinglass for food; clams, not live; potato-based dumplings; klipfish [salted and dried cod]; milk shakes; black pudding; onion rings; arrangements of processed fruit; compotes; meat, tinned; vegetables, tinned; fish, tinned; fruits, tinned; duck confits; broth concentrates; vegetable-based concentrate for cooking; fruit-based concentrate for cooking; corn dogs; gherkins; shrimps, not live; prawns, not live; buttercream; croquettes; silkworm chrysalis for human consumption; sweet corn, processed; koumiss; spiny lobsters, not live; lecithin for culinary purposes; edible ant larvae, prepared; salmon, not live; onions, preserved; margarine; oils for food; peanut butter; cocoa butter for food; coconut oil for food; coconut bu-

tter; maize oil for food; sesame oil for food; linseed oil for food; extra virgin olive oil for food; olive oil for food; palm oil for food; palm kernel oil for food; sunflower oil for food; rape oil for food; butter; soya bean oil for food; mussels, not live; almonds, ground; animal marrow for food; shellfish, not live; molluscs, not live; milk; peanut milk; peanut milk for culinary purposes; coconut milk; coconut milk for culinary purposes; almond milk; almond milk for culinary purposes; oat milk; rice milk; rice milk for culinary purposes; albumin milk; condensed milk; soured milk; soya milk; powdered milk; fermented baked milk; fish meal for human consumption; vegetable mousses; fish mousses; fruit pulp; meat; meat, preserved; freeze-dried meat; lactic acid drinks; milk beverages, milk predominating; peanut milk-based beverages; coconut milk-based beverages; almond milk-based beverages; edible insects, not live; sausage casings, natural or artificial; vegetables, preserved; freeze-dried vegetables; vegetables, processed; vegetables, dried; vegetables, cooked; hash browns; potato fritters; olives, preserved; lobsters, not live; omelettes; flavoured nuts; candied nuts; coconut, desiccated; nuts, prepared; tomato paste; pressed fruit paste; liver pâté; pectin for culinary purposes; preserved peppers; liver; pickles; jams; powdered eggs; milk products; fish-based foodstuffs; poultry, not live; white pudding; bulgogi; pollen prepared as foodstuff; cranberry compote; tomato purée; apple purée; crayfish, not live; crustaceans, not live; ratatouille; fish, preserved; fish, not live; salted fish; vegetable salads; fruit salads; bacon; sardines, not live; satay; pork; herrings, not live; seeds, prepared; sunflower seeds, prepared; cream [dairy products]; whipped cream; vegetable-based cream; fat-containing mixtures for bread slices; smetana; lemon juice for culinary purposes; tomato juice for cooking; vegetable juices for cooking; salted meats; sausages; sausages in batter; hot dog sausages; preparations for making bouillon; preparations for making soup; tofu skin; vegetable-based spreads; nut-based spreads; tripe; soups; vegetable soup preparations; whey; cottage cheese fritters; cheese; tajine [prepared meat, fish or vegetable dish]; tahini; cottage cheese; tofu; tempeh; sea-cucumbers, not live; truffles, preserved; tuna, not live; oysters, not live; falafel; milk ferments for culinary purposes; rennet; fish fillets; dates; crystallized fruits; frozen fruits; fruit, preserved; fruit, processed; fruit preserved in alcohol; fruit, stewed; hazelnuts, prepared; potato flakes; hummus; edible flowers, dried; fruit peel; preserved garlic; lentils, preserved; potato crisps; low-fat potato crisps; fruit chips; choucroute garnie; non-alcoholic eggnog; seaweed extracts for food; meat extracts; berries, preserved; eggs; snail eggs for consumption; yakitori.

30 – Vanilla flavourings for culinary purposes; flavourings, other than essential oils, for cakes; flavourings, other than essential oils, for beverages; coffee flavourings; food flavourings, other than essential

oils; star aniseed; baozi; cereal bars; high-protein cereal bars; pancakes; savoury pancakes; freeze-dried dishes with the main ingredient being pasta; freeze-dried dishes with the main ingredient being rice; noodle-based prepared meals; buns; bulgur; bread rolls; pains au chocolat; edible paper wafers; edible rice paper; edible paper; burritos; vanillin [vanilla substitute]; waffles; vermicelli; natural sweeteners; sausage binding materials; binding agents for ice cream; orange blossom water for culinary purposes; seawater for cooking; seaweed [condiment]; malt biscuits; cloves [spice]; mirror icing [mirror glaze]; cake frosting [icing]; glucose for culinary purposes; mustard; croûtons; buckwheat, processed; gluten additives for culinary purposes; yeast; thickening agents for cooking foodstuffs; leaven; rice-based snack food; cereal-based snack food; coffee substitutes; vegetal preparations for use as coffee substitutes; dressings for salad; fruit jellies [confectionery]; candy decorations for cakes; confectionery for decorating Christmas trees; cakes; pastries; peanut confectionery; almond confectionery; confectionery; fruit confectionery; pasta; ground ginger; frozen yogurt [confectionery ices]; cocoa; cream of tartar for culinary purposes; capers; coffee capsules, filled; caramels [sweets]; curry [spice]; ketchup [sauce]; quinoa, processed; quiches; gluten prepared as foodstuff; flour-based dumplings; sweets; liquorice [confectionery]; peppermint sweets; mints for breath freshening; dulce de leche; cinnamon [spice]; coffee; unroasted coffee; starch for food; crackers; rice crackers; custard; crème brûlée; croissants; hominy grits; semolina; oatmeal; crushed barley; groats for human food; ice cubes; corn, milled; corn, roasted; meat pies; turmeric; couscous; laksa; noodles; soba noodles; udon noodles; ice for refreshment; ice, natural or artificial; edible ices; ice pops; potato-based flatbreads; rice cakes; mayonnaise; macaroons [pastries]; macaroni; maltose; hominy; piccalilli; marinades; marzipan; honey; miso; royal jelly; ice cream; bean meal; buckwheat flour; tapioca flour; potato flour; corn flour; nut flours; flour; wheat flour; soya flour; barley meal; confectionery in the form of mousses; chocolate mousses; muesli; mint for confectionery; cocoa beverages with milk; coffee beverages with milk; coffee-based beverages; cocoa-based beverages; chamomile-based beverages; tea-based beverages; tea beverages with milk; chocolate beverages with milk; chocolate-based beverages; infusions, not medicinal; nougat; crushed oats; husked oats; kimchi pancakes; onigiri; nutmegs; chocolate-coated nuts; stick liquorice [confectionery]; ginger paste [seasoning]; lozenges [confectionery]; molasses for food; pâtés en croûte; pelmeni; pepper; allspice; peppers [seasonings]; pesto; biscuits; coconut macaroons; petit-beurre biscuits; bibimbap [rice mixed with vegetables and beef]; pies; pizzas; meat gravies; fondants [confectionery]; popcorn; powders for making ice cream; baking powder; mustard meal; pralines; aromatic preparations for food; condiments; meat tenderizers for household pur-

poses; cereal preparations; oat-based food; propolis; profiteroles; gingerbread; spices; petits fours; rice pudding; puddings; cake powder; fruit coulis [sauces]; ravioli; ramen; chewing gum; chewing gum for breath freshening; relish [condiment]; rice; prepared rice rolled in seaweed; instant rice; wheat germ for human consumption; spring rolls; sago; sugar; crystallized rock sugar; palm sugar; sesame seeds [seasonings]; linseed for culinary purposes [seasoning]; processed seeds for use as a seasoning; aniseed; agave syrup [natural sweetener]; golden syrup; savoury pancake mixes; batter mixes; baking soda [bicarbonate of soda for cooking purposes]; malt for human consumption; salt for preserving foodstuffs; cooking salt; celery salt; sorbets [ices]; ham glaze; cranberry sauce [condiment]; soya sauce; tomato sauce; apple sauce [condiment]; sauces [condiments]; pasta sauce; spaghetti; seasonings; chocolate-based spreads; chocolate spreads containing nuts; preparations for stiffening whipped cream; shaved ice with sweetened red beans; rusks; breadcrumbs; sushi; sandwiches; tabbouleh; tacos; tamarind [condiment]; tapioca; tarts; dough; pastry dough; almond paste; rice pulp for culinary purposes; cake batter; tortillas; garden herbs, preserved [seasonings]; chocolate decorations for cakes; vinegar; beer vinegar; ferments for pastes; halvah; harissa [condiment]; bread; gluten-free bread; unleavened bread; chips [cereal products]; corn flakes; oat flakes; hot dog sandwiches; flowers or leaves for use as tea substitutes; jiaozi; chicory [coffee substitute]; tea; kelp tea; iced tea; chutneys [condiments]; minced garlic [condiment]; cheeseburgers [sandwiches]; chowchow [condiment]; saffron [seasoning]; chocolate; malt extract for food; essences for foodstuffs, except etheric essences and essential oils; husked barley.

31 – Algarovilla for animal consumption; anchovy, live; oranges, fresh; peanuts, fresh; artichokes, fresh; draff; beans, fresh; locust beans, raw; soya beans, fresh; wreaths of natural flowers; grapes, fresh; algae, unprocessed, for human or animal consumption; fruit residue [marc]; dog biscuits; sea-cucumbers, live; peas, fresh; buckwheat, unprocessed; mushroom spawn for propagation; mushrooms, fresh; trees; palm trees; turf, natural; unsawn timber; undressed timber; yeast for animal consumption; Christmas trees; edible chews for animals; live animals; menagerie animals; peanut cake for animals; oil cake; maize cake for cattle; rape cake for cattle; bagasses of cane [raw material]; cereal seeds, unprocessed; grains [cereals]; grains for animal consumption; lime for animal forage; fish spawn; ginger, fresh; vegetable marrows, fresh; cocoa beans, raw; koi carp, live; potatoes, fresh; chestnuts, fresh; quinoa, unprocessed; arrangements of fresh fruit; cannabis, unprocessed; copra; raw barks; rough cork; animal foodstuffs; pet food; stall food for animals; bird food; strengthening animal forage; chicory roots; roots for animal consumption; nettles; groats for poultry; maize; edible sesame, unprocessed; shrubs; rose bushes; spiny lobsters, live; lemons,

fresh; vine plants; salmon, live; onions, fresh; flower bulbs; leeks, fresh; olives, fresh; bran mash for animal consumption; mussels, live; almonds [fruits]; shellfish, live; molluscs, live; peanut meal for animals; linseed meal for animal consumption; meal for animals; flax meal [fodder]; rice meal for forage; fish meal for animal consumption; straw mulch; beverages for pets; edible insects, live; oats; vegetables, fresh; cucumbers, fresh; lobsters, live; coconuts; kola nuts; nuts, unprocessed; bran; distillery waste for animal consumption; residue in a still after distillation; palms [leaves of the palm tree]; cuttle bone for birds; peppers [plants]; aromatic sand [litter] for pets; citrus fruit, fresh; litter for animals; mash for fattening livestock; unprocessed sweet corn ears [husked or unhusked]; preparations for egg laying poultry; fishing bait, live; freeze-dried fishing bait; animal fattening preparations; by-products of the processing of cereals, for animal consumption; seed germ for botanical purposes; poultry, live; wheat; pollen [raw material]; crayfish, live; crustaceans, live; seedlings; plants; aloe vera plants; plants, dried, for decoration; cannabis plants; rhubarb, fresh; rice, unprocessed; rye; wheat germ for animal consumption; fish, live; lettuce, fresh; sardines, live; beet, fresh; herrings, live; seeds for planting; linseed for animal consumption; edible linseed, unprocessed; hay; coconut shell; bred stock; sanded paper [litter] for pets; malt for brewing and distilling; straw [forage]; straw litter; salt for cattle; trunks of trees; wood chips for the manufacture of wood pulp; litter peat; garden herbs, fresh; sugarcane; truffles, fresh; tuna, live; squashes, fresh; oysters, live; fruit, fresh; hazelnuts, fresh; fodder; hops; flowers, natural; flowers, dried, for decoration; edible flowers, fresh; chicory, fresh; silkworms; garlic, fresh; lentils, fresh; pine cones; hop cones; spinach, fresh; juniper berries; berries, fresh; eggs for hatching, fertilized; silkworm eggs; barley.

32 – Aperitifs, non-alcoholic; barley wine [beer]; carbonated water; lithia water; seltzer water; soda water; waters [beverages]; mineral water [beverages]; table waters; kvass; cocktails, non-alcoholic; beer-based cocktails; lemonades; non-alcoholic beverages; non-alcoholic dried fruit beverages; isotonic beverages; non-alcoholic honey-based beverages; rice-based beverages, other than milk substitutes; soya-based beverages, other than milk substitutes; aloe vera drinks, non-alcoholic; whey beverages; protein-enriched sports beverages; soft drinks; non-alcoholic beverages flavoured with coffee; non-alcoholic beverages flavoured with tea; non-alcoholic fruit juice beverages; energy drinks; fruit nectars, non-alcoholic; orgeat; beer; ginger beer; malt beer; powders for effervescing beverages; sarsaparilla [non-alcoholic beverage]; syrups for lemonade; syrups for beverages; smoothies; tomato juice [beverage]; cider, non-alcoholic; vegetable juices [beverages]; fruit juices; preparations for making non-alcoholic beverages; preparations for making carbonated water; must; grape must, unfermen-

ted; beer wort; malt wort; pastilles for effervescing beverages; shandy; sherbets [beverages]; non-alcoholic fruit extracts; extracts of hops for making beer; non-alcoholic essences for making beverages.

33 – Aperitifs; arrack [arak]; brandy; wine; piquette; whisky; vodka; anisette [liqueur]; kirsch; gin; digestifs [liqueurs and spirits]; cocktails; curacao; anise [liqueur]; liqueurs; grain-based distilled alcoholic beverages; sugarcane-based alcoholic beverages; pre-mixed alcoholic beverages, other than beer-based; alcoholic beverages, except beer; alcoholic beverages containing fruit; spirits [beverages]; distilled beverages; hydromel [mead]; peppermint liqueurs; bitters; rum; sake; perry; cider; rice alcohol; alcoholic extracts; fruit extracts, alcoholic; alcoholic essences.

34 – Flavourings, other than essential oils, for tobacco; flavourings, other than essential oils, for use in electronic cigarettes; gas containers for cigar lighters; absorbent paper for tobacco pipes; cigarette paper; lighters for smokers; hookahs; tobacco pouches; books of cigarette papers; humidors; matchboxes; firestones; cigar cutters; cigar holders; cigarette holders; mouthpieces for cigarette holders; tips of yellow amber for cigar and cigarette holders; ashtrays for smokers; spittoons for tobacco users; pipe racks for tobacco pipes; pipe cleaners for tobacco pipes; liquid solutions for use in electronic cigarettes; electronic cigarettes; cigarettes; cigarettes containing tobacco substitutes, not for medical purposes; cigarillos; cigars; tobacco jars; match holders; matches; oral vaporizers for smokers; tobacco; chewing tobacco; snuff; snuff boxes; herbs for smoking; tobacco pipes; pocket machines for rolling cigarettes; cigarette filters; wicks adapted for cigarette lighters; cigarette tips; cigar cases; cigarette cases.

35 – Arranging subscriptions to telecommunication services for others; import-export agency services; commercial information agency services; advertising agency services; cost price analysis; rental of office equipment in co-working facilities; rental of advertising space; business auditing; financial auditing; business intermediary services relating to the matching of potential private investors with entrepreneurs needing funding; employment agency services; computerized file management; book-keeping; invoicing; demonstration of goods; transcription of communications [office functions]; opinion polling; market studies; business investigations; business research; marketing research; personnel recruitment; business management and organization consultancy; business organization consultancy; business management consultancy; personnel management consultancy; professional business consultancy; consultancy regarding advertising communication strategies; consultancy regarding public relations communication strategies; layout services for advertising purposes; marketing; marketing in the framework of software publishing; targeted marketing; business management of perfor-

ming artists; business management of sports people; writing of curriculum vitae for others; scriptwriting for advertising purposes; news clipping services; updating and maintenance of information in registries; updating and maintenance of data in computer databases; updating of advertising material; word processing; online retail services for downloadable and pre-recorded music and movies; online retail services for downloadable ring tones; online retail services for downloadable digital music; organization of exhibitions for commercial or advertising purposes; arranging newspaper subscriptions for others; organization of fashion shows for promotional purposes; organization of trade fairs; shop window dressing; business appraisals; payroll preparation; data search in computer files for others; sponsorship search; administrative assistance in responding to calls for tenders; business management assistance; commercial or industrial management assistance; commercial intermediation services; providing business information; providing business information via a website; providing commercial and business contact information; providing commercial information and advice for consumers in the choice of products and services; provision of an online marketplace for buyers and sellers of goods and services; providing user reviews for commercial or advertising purposes; web indexing for commercial or advertising purposes; providing user rankings for commercial or advertising purposes; presentation of goods on communication media, for retail purposes; media relations services; economic forecasting; auctioneering; wholesale services for pharmaceutical, veterinary and sanitary preparations and medical supplies; retail services for works of art provided by art galleries; retail services for pharmaceutical, veterinary and sanitary preparations and medical supplies; sales promotion for others; promotion of goods and services through sponsorship of sports events; production of teleshopping programmes; production of advertising films; office machines and equipment rental; rental of advertising time on communication media; publicity material rental; rental of billboards [advertising boards]; rental of vending machines; rental of sales stands; rental of photocopying machines; consumer profiling for commercial or marketing purposes; publication of publicity texts; radio advertising; development of advertising concepts; bill-posting; distribution of samples; dissemination of advertising matter; direct mail advertising; registration of written communications and data; editing of publicity texts; advertising; online advertising on a computer network; outdoor advertising; advertising by mail order; television advertising; compilation of statistics; compilation of information into computer databases; business inquiries; systemization of information into computer databases; administrative services for medical referrals; advisory services for business management; corporate communications services; negotiation of business contracts for others; negotiation and conclusion of commercial

transactions for third parties; compiling indexes of information for commercial or advertising purposes; tax preparation; drawing up of statements of accounts; telemarketing services; psychological testing for the selection of personnel; interim business management; outsourced administrative management for companies; business management of hotels; business management for freelance service providers; business project management services for construction projects; commercial administration of the licensing of the goods and services of others; business management of reimbursement programmes for others; administration of consumer loyalty programs; administration of frequent flyer programs; administrative processing of purchase orders; administrative services for the relocation of businesses; public relations; commercial lobbying services; competitive intelligence services; modelling for advertising or sales promotion; typing; market intelligence services; appointment reminder services [office functions]; website traffic optimization; appointment scheduling services [office functions]; tax filing services; search engine optimization for sales promotion; retail services relating to bakery products; gift registry services; price comparison services; pay per click advertising; secretarial services; procurement services for others [purchasing goods and services for other businesses]; wholesale or retail store services; publicity and sales promotion relating to non-food goods namely publicity and sales promotion relating to household goods; on-line ordering services; shorthand; outsourcing services [business assistance]; telephone answering for unavailable subscribers; telephone switchboard services; photocopying services; business efficiency expert services.

36 – Credit bureau services; debt collection agency services; financial analysis; rental of apartments; rental of offices for co-working; rental of real estate; rental of offices [real estate]; rental of farms; hire-purchase financing; savings bank services; accommodation bureau services [apartments]; rent collection; issuance of travellers' cheques; issuance of credit cards; issuance of tokens of value; capital investment; financial research; clearing, financial; insurance consultancy; financial consultancy; debt advisory services; stock exchange quotations; crowdfunding; lending against security; business liquidation services, financial; brokerage; financial management; exchanging money; online banking; processing of debit card payments; processing of credit card payments; financial exchange of crypto assets; real estate affairs; factoring; organization of monetary collections; arranging finance for construction projects; antique appraisal; jewellery appraisal; financial evaluation of standing timber; stamp appraisal; real estate appraisal; numismatic appraisal; art appraisal; financial evaluation of development costs relating to the oil, gas and mining industries; financial valuation of intellectual property assets; financial evaluation of wool; financial evaluation [insurance, banking, real estate]; financial appraisals

in responding to calls for tenders; repair costs evaluation [financial appraisal]; electronic funds transfer; surety services; securities brokerage; real estate brokerage; brokerage of carbon credits; insurance brokerage; providing insurance information; providing rebates at participating establishments of others through use of a membership card; loans [financing]; pawn-brokerage; providing financial information; providing financial information via a website; cheque verification; investment of funds; charitable fund raising; stocks and bonds brokerage; financial sponsorship; mortgage banking; instalment loans; insurance underwriting; life insurance underwriting; health insurance underwriting; accident insurance underwriting; marine insurance underwriting; fire insurance underwriting; apartment house management; real estate management; financial management of reimbursement payments for others; real estate agency services; actuarial services; banking; stock brokerage services; e-wallet payment services; retirement payment services; bail-bonding; preparation of quotes for cost estimation purposes; electronic transfer of crypto assets; trusteeship; provident fund services; financial customs brokerage services; mutual funds; financing services; safe deposit services; deposits of valuables; fiscal valuation.

37 – Asphaltting; drilling of deep oil or gas wells; drilling of wells; rebuilding engines that have been worn or partially destroyed; rebuilding machines that have been worn or partially destroyed; renovation of clothing; retreading of tyres; vulcanization of tyres [repair]; building sealing; linen ironing; pressing of clothing; disinfecting; mining extraction; vehicle battery charging; charging of electric vehicles; knife sharpening; building insulating; bricklaying; riveting; construction consultancy; varnishing; re-tinning; installation of utilities in construction sites; scaffolding; road paving; window cleaning; vehicle washing; building construction supervision; tuning of musical instruments; upholstering; rustproofing; anti-rust treatment for vehicles; sanding; pumicing; strong-room maintenance and repair; vehicle maintenance; paper hanging; painting or repair of signs; cleaning of buildings [exterior surface]; vehicle polishing; vehicle breakdown repair services; providing information relating to repairs; providing construction information; rental of bulldozers; rental of drainage pumps; rental of dish drying machines; rental of road sweeping machines; rental of cleaning machines; rental of cranes [construction equipment]; rental of dishwashing machines; rental of laundry washing machines; rental of construction equipment; rental of excavators; laying of cable; plumbing; masonry; roofing services; painting, interior and exterior; carpentry services; underwater repair; plastering; quarrying services; repair of security locks; umbrella repair; parasol repair; motor vehicle maintenance and repair; burner maintenance and repair; film projector repair and maintenance; airplane maintenance and repair; safe maintenance and repair;

clock and watch repair; repair of power lines; pump repair; upholstery repair; shoe repair; clothing repair; photographic apparatus repair; furniture restoration; restoration of musical instruments; restoration of works of art; vehicle greasing; demolition of buildings; warehouse construction and repair; vehicle service stations [refuelling and maintenance]; sterilization of medical instruments; washing; washing of linen; construction; pier breakwater building; pipeline construction and maintenance; underwater construction; harbour construction; factory construction; building of fair stalls and shops; shipbuilding; cleaning of buildings [interior]; snow removal; street cleaning; vermin exterminating, other than for agriculture, aquaculture, horticulture and forestry; housekeeping services [cleaning services]; tyre balancing; pest control services, other than for agriculture, aquaculture, horticulture and forestry; hydraulic fracturing services; refilling of toner cartridges; refilling of ink cartridges; cell phone battery charging services; artificial snow-making services; laundering; services of electricians; installation of doors and windows; irrigation devices installation and repair; elevator installation and repair; installation and repair of flood protection equipment; heating equipment installation and repair; burglar alarm installation and repair; furnace installation and repair; telephone installation and repair; installation and repair of air-conditioning apparatus; fire alarm installation and repair; freezing equipment installation and repair; electric appliance installation and repair; kitchen equipment installation; installation, maintenance and repair of computer hardware; machinery installation, maintenance and repair; office machines and equipment installation, maintenance and repair; interference suppression in electrical apparatus; swimming-pool maintenance; furniture maintenance; chimney sweeping; boiler cleaning and repair; cleaning of clothing; dry cleaning; vehicle cleaning; diaper cleaning; leather care, cleaning and repair; fur care, cleaning and repair.

38 – News agencies; wireless broadcasting; television broadcasting; cable television broadcasting; electronic bulletin board services [telecommunications services]; providing user access to global computer networks; providing access to databases; providing internet chat-rooms; providing telecommunications connections to a global computer network; providing telecommunication channels for teleshopping services; video-on-demand transmission; transmission of podcasts; transmission of greeting cards online; message sending; computer aided transmission of messages and images; transmission of telegrams; transmission of digital files; providing information in the field of telecommunications; providing online forums; videoconferencing services; rental of message sending apparatus; rental of access time to global computer networks; rental of modems; rental of telecommunication equipment; rental of smartphones; rental of telephones; rental of facsimile apparatus; radio broadcasting; radio communi-

cations; transmission of electronic mail; communications by fibre optic networks; communications by cellular phones; communications by computer terminals; satellite transmission; communications by telegrams; communications by telephone; facsimile transmission; paging services [radio, telephone or other means of electronic communication]; teleconferencing services; telex services; voice mail services; telecommunications routing and junction services; streaming of data; telegraph services; telephone services.

39 – Air transport; motor coach rental; boat rental; garage rental; rental of vehicle roof racks; aircraft rental; parking place rental; rental of electric wine cellars; rental of warehouses; rental of tractors; booking of seats for travel; travel reservation; transport reservation; towing; vehicle breakdown towing services; bottling services; water distribution; water supplying; delivery of newspapers; message delivery; parcel delivery; delivery of goods; delivery of goods by mail order; flower delivery; replenishment of vending machines; launching of satellites for others; transportation logistics; rescue operations [transport]; arranging of cruises; arranging of passenger transportation services for others via an online application; arranging of transportation for travel tours; arranging for travel visas and travel documents for persons travelling abroad; armoured-car transport; hauling; carting; transport and storage of waste; transporting furniture; lighterage services; ferry-boat transport; removal services; transport of travellers; guarded transport of valuables; bus transport; car transport; barge transport; boat transport; railway transport; marine transport; passenger transport; river transport; ambulance transport; tram transport; portage; piloting of civilian drones; refloating of ships; cash replenishment of automated teller machines; shipbrokerage; transport brokerage; freight brokerage [forwarding (Am.)]; providing driving directions for travel purposes; providing traffic information; providing information relating to storage services; providing transportation information; car rental; railway truck rental; rental of diving bells; rental of diving suits; rental of motor racing cars; rental of aircraft engines; railway coach rental; rental of storage containers; rental of wheelchairs; rental of horses for transportation purposes; rental of freezers; rental of navigational systems; refrigerator rental; vehicle rental; stevedoring; unloading cargo; electricity distribution; distribution of energy; packaging of goods; collection of recyclable goods [transport]; carpooling services; ice-breaking; piloting; escorting of travellers; transport by pipeline; wrapping of goods; operating canal locks; car parking; chauffeur services; pleasure boat transport; car sharing services; courier services [messages or merchandise]; salvaging; salvage of ships; gift wrapping; underwater salvage; taxi transport; transport; transport services for sightseeing tours; luggage storage; franking of mail; freight [shipping of goods]; freighting; physical storage of electro-

nically stored data or documents; boat storage; storage of goods; storage; freight forwarding.

40 – Paper finishing; applying finishes to textiles; beer brewing for others; upcycling [waste recycling]; vulcanization [material treatment]; skin dressing; fruit crushing; embroidering; galvanization; electroplating; engraving; decontamination of hazardous materials; air deodorizing; stripping finishes; tanning; metal tempering; freezing of foods; gilding; gold plating; cadmium plating; permanent-press treatment of fabrics; food and drink preservation; consultancy in the field of wine making; food smoking; leather staining; fur dyeing; shoe staining; textile dyeing; cloth dyeing; laminating; lithographic printing; metal casting; fur glossing; tin plating; boilermaking; taxidermy; magnetization; nickel plating; abrasion; paper treating; water treating; woodworking; processing of cinematographic films; leather working; cloth edging; metal treating; fur conditioning; fur mothproofing; waste treatment [transformation]; textile mothproofing; cloth waterproofing; crease-resistant treatment for clothing; cloth fireproofing; textile treating; wool treating; framing of works of art; air freshening; fabric bleaching; air purification; soldering; pasteurizing of food and beverages; clothing alteration; recycling of waste and trash; processing of oil; pattern printing; photographic printing; offset printing; metal plating; printing; burnishing by abrasion; flour milling; dressmaking; providing information relating to material treatment; wine making for others; custom manufacturing of bread; rental of boilers; knitting machine rental; rental of electricity generators; rental of air-conditioning apparatus; rental of space heating apparatus; photographic film development; pottery firing; blacksmithing; custom assembling of materials for others; bookbinding; welding services; glass-blowing; saddlery working; grinding; cloth cutting; sawing of materials; refining services; timber felling and processing; fur satining; silver plating; incineration of waste and trash; laser scribing; warping [looms]; sorting of waste and recyclable material [transformation]; photo-composing services; quilting; planing of materials; fulling of cloth; tinting of car windows; window tinting treatment being surface coating; slaughtering of animals; destruction of waste and trash; cloth pre-shrinking; custom 3D printing for others; services of a dental technician; cryopreservation services; key cutting; dyeing services; sandblasting services; production of energy; custom tailoring; custom fashioning of fur; photogravure; millworking; chromium plating; colour separation services; silkscreen printing; optical glass grinding.

41 – Modelling for artists; academies [education]; rental of indoor aquaria; rental of artwork; rental of sports grounds; rental of tennis courts; mobile library services; lending library services; booking of seats for shows; videotaping; physical education; production of music; discotheque services; animal training; dub-

bing; publication of books; film distribution; movie studio services; health club services [health and fitness training]; nightclub services [entertainment]; layout services, other than for advertising purposes; microfilming; videotape editing; production of radio and television programmes; screenplay writing; religious education; aikido instruction; gymnastic instruction; judo instruction; correspondence courses; practical training [demonstration]; training services provided via simulators; organization of balls; organization of exhibitions for cultural and educational purposes; providing recreation facilities; arranging and conducting of colloquiums; arranging and conducting of congresses; arranging and conducting of conferences; arranging and conducting of concerts; arranging and conducting of workshops [training]; arranging and conducting of in-person educational forums; arranging and conducting of seminars; arranging and conducting of symposiums; organization of competitions [education or entertainment]; arranging of beauty contests; organization of cosplay entertainment events; organization of lotteries; organization of fashion shows for entertainment purposes; organization of shows [impresario services]; organization of sports competitions; vocational guidance [education or training advice]; amusement park services; sign language interpretation; language interpretation; know-how transfer [training]; television entertainment; vocational retraining; providing online videos, not downloadable; providing information in the field of education; providing information relating to recreational activities; providing information in the field of entertainment; providing online music, not downloadable; providing television programmes, not downloadable, via video-on-demand services; providing films, not downloadable, via video-on-demand services; providing user reviews for entertainment or cultural purposes; providing golf facilities; providing user rankings for entertainment or cultural purposes; providing sports facilities; providing amusement arcade services; cinema presentations; providing online electronic publications, not downloadable; presentation of circus performances; presentation of variety shows; presentation of live performances; theatre productions; conducting guided climbing tours; conducting fitness classes; educational examination; film production, other than advertising films; rental of audio equipment; rental of video cameras; rental of video cassette recorders; rental of videotapes; rental of show scenery; rental of sound recordings; toy rental; rental of cinematographic apparatus; rental of motion pictures; games equipment rental; rental of stadium facilities; rental of lighting apparatus for theatrical sets or television studios; rental of radio and television sets; rental of skin diving equipment; rental of sports equipment, except vehicles; rental of stage scenery; rental of training simulators; electronic desktop publishing; online publication of electronic books and journals; publication of texts, other than publicity texts; radio entertainment;

entertainment services; writing of texts; sado instruction [tea ceremony instruction]; zoological garden services; news reporters services; film directing, other than advertising films; party planning [entertainment]; music composition services; subtitling; tutoring; entertainer services; holiday camp services [entertainment]; gambling services; video editing services for events; conducting guided tours; disc jockey services; sound engineering services for events; game services provided online from a computer network; personal trainer services [fitness training]; providing casino facilities [gambling]; calligraphy services; karaoke services; club services; songwriting; cultural, educational or entertainment services provided by art galleries; providing museum facilities; teaching; educational services provided by special needs assistants; educational services provided by schools; orchestra services; translation; scriptwriting, other than for advertising purposes; physical fitness assessment services for training purposes; face painting; ticket agency services [entertainment]; educational examination for users to qualify to pilot drones; coaching [training]; lighting technician services for events; sport camp services; recording studio services; nursery schools; photography; photographic reporting; timing of sports events; boarding school education; production of shows.

42 – Water analysis; computer system analysis; handwriting analysis [graphology]; chemical analysis; rental of meters for the recording of energy consumption; energy auditing; recovery of computer data; business card design; graphic design of promotional materials; interior design; industrial design; graphic arts design; computer virus protection services; oil-field surveys; geological surveys; engineering; installation of computer software; meteorological information; clinical trials; material testing; textile testing; bacteriological research; biological research; geological research; research in the field of environmental protection; cosmetic research; mechanical research; research in the field of welding; research in the field of building construction; research in the field of telecommunications technology; research in the field of physics; chemical research; research and development of new products for others; medical research; scientific and technological research relating to patent mapping; scientific and technological research in the field of natural disasters; scientific research; analysis for oil-field exploitation; underwater exploration; technological research; calibration [measuring]; website design consultancy; computer security consultancy; information technology [IT] consultancy; computer technology consultancy; consultancy in the design and development of computer hardware; architectural consultancy; internet security consultancy; computer software consultancy; data security consultancy; technological consultancy; oil-well testing; quality control; vehicle roadworthiness testing; land surveying; dress designing; updating of computer software; monitoring of computer systems to detect breakdowns; monitoring

of computer systems for detecting unauthorized access or data breach; monitoring of computer systems by remote access; electronic monitoring of credit card activity to detect fraud via the internet; electronic monitoring of personally identifying information to detect identity theft via the internet; software as a service [SaaS]; maintenance of computer software; authenticating works of art; design of interior decor; quality evaluation of standing timber; quality evaluation of wool; digitization of documents [scanning]; conversion of data or documents from physical to electronic media; urban planning; providing information relating to computer technology and programming via a website; providing scientific information, advice and consultancy relating to carbon offsetting; providing search engines for the internet; platform as a service [PaaS]; conversion of computer programs and data, other than physical conversion; conducting technical project studies; computer system design; rental of web servers; computer rental; rental of computer software; unlocking of mobile phones; geological prospecting; oil prospecting; hosting computer websites; server hosting; development of computer platforms; construction drafting; computer software design; software development in the framework of software publishing; cloud seeding; consultancy in the field of energy-saving; creating and designing website-based indexes of information for others [information technology services]; creating and maintaining websites for others; computer programming; technical writing; duplication of computer programs; providing virtual computer systems through cloud computing; architectural services; information technology services provided on an outsourcing basis; chemistry services; packaging design; off-site data backup; telecommunications technology consultancy; scientific laboratory services; user authentication services using single sign-on technology for online software applications; user authentication services using technology for e-commerce transactions; weather forecasting; styling [industrial design]; cartography services; exploration services in the field of the oil, gas and mining industries; data encryption services; electronic data storage; surveying.

43 – Accommodation bureau services [hotels, boarding houses]; rental of temporary accommodation; rental of drinking water dispensers; rental of meeting rooms; tourist home services; hotel reservations; boarding house bookings; temporary accommodation reservations; hotel accommodation services; retirement home services; snack-bar services; information and advice in relation to the preparation of meals; café services; cafeteria services; motel services; boarding house services; boarding for animals; rental of cooking apparatus; rental of chairs, tables, table linen, glassware; rental of lighting apparatus; rental of tents; rental of transportable buildings; restaurant services; self-service restaurant services; reception services for temporary accommodation [management of arrivals

and departures]; food sculpting; decorating of food; cake decorating; holiday camp services [lodging]; bar services; day-nursery [crèche] services; hookah lounge services; providing campground facilities; personal chef services; food and drink catering; washoku restaurant services; udon and soba restaurant services; canteen services.

44 – Rental of animals for gardening purposes; rental of beehives; dietary and nutritional advice; public bath services for hygiene purposes; Turkish bath services; hospital services; reforestation services; cultivation of plants; rehabilitation for substance abuse patients; depilatory waxing; landscape design; health centre services; nursing home services; wreath making; hair implantation; medical advice for individuals with disabilities; consultancy in the field of viticulture; pharmacy advice; aromatherapy services; animal-assisted therapy; manicuring; massage; medical testing; horticulture; orthodontic services; artificial insemination services; hairdressing; body piercing; midwife services; veterinary assistance; dentistry services; medical assistance; palliative care; tree planting for carbon offsetting purposes; preparation of prescriptions by pharmacists; medical equipment rental; rental of hair styling apparatus; rental of sanitary installations; farming equipment rental; aerial and surface spreading of fertilizers and other agricultural chemicals; animal breeding; gardening; landscape gardening; beauty salon services; sanatorium services; medical screening; blood bank services; health care; health counselling; rental of surgical robots; flower arranging; tattooing; chiropractic; vermin exterminating for agriculture, aquaculture, horticulture and forestry; weed killing; health spa services; human tissue bank services; aquaculture services; viticulture services; beautician services; convalescent home services; rest home services; medical clinic services; medical analysis services for diagnostic and treatment purposes provided by medical laboratories; home-visit nursing care; alternative medicine services; opticians' services; plant nursery services; pest control services for agriculture, aquaculture, horticulture and forestry; speech therapy; in vitro fertilization services; services of a psychologist; sauna services; solarium services; telemedicine services; therapy services; nursing, medical; lawn care; animal grooming; pet grooming; physiotherapy; plastic surgery; tree surgery; hospice services.

45 – Marriage agency services; detective agency services; night guard services; adoption agency services; arbitration services; leasing of internet domain names; rental of safes; legal compliance auditing; regulatory compliance auditing; embalming services; funerary undertaking; lost property return; releasing doves for special occasions; security screening of baggage; genealogical research; legal research; intellectual property consultancy; physical security consultancy; legal consultancy relating to patent mapping; legal advice in responding to calls for tenders; bereavement co-

unselling; monitoring intellectual property rights for legal advisory purposes; monitoring of burglar and security alarms; crematorium services; licensing [legal services] in the framework of software publishing; licensing of intellectual property; licensing of computer software [legal services]; organization of political meetings; organization of religious meetings; opening of security locks; planning and arranging of wedding ceremonies; missing person investigations; kimono dressing assistance; litigation services; babysitting; pet sitting; conducting religious ceremonies; conducting funeral ceremonies; inspection of factories for safety purposes; evening dress rental; rental of fire extinguishers; clothing rental; rental of fire alarms; registration of domain names [legal services]; personal letter writing; personal background investigations; fire-fighting; astrology consultancy; spiritual consultancy; personal wardrobe styling consultancy; chaperoning; horoscope casting; copyright management; legal services relating to licences; legal advocacy services; tarot card reading services for others; cartomancy services; dating services; concierge services; guard services; alternative dispute resolution services; dog walking services; tracking of stolen property; legal document preparation services; house sitting; mediation; burial services; online social networking services; lifeguard services; personal bodyguarding; legal services in the field of immigration; legal services in relation to the negotiation of contracts for others; legal watching services.

(260) AM 2023 120695 A

(800) 1654180

(151) 2022 03 01

(891) 2022 11 17

(731) Dare Bioscience Inc.

3655 Nobel Drive, Suite 260, San Diego
CA 92122, USA

(540)

XACIATO

(591) Black, white

(511)

5 – Pharmaceutical preparations for the treatment and prevention of bacterial infections; antibiotic topical preparations; pharmaceutical preparations for treating bacterial vaginosis.

(260) AM 2023 120879 A

(800) 1702769

(151) 2022 08 22

(891) 2022 08 22

(731) ABC Deterjan Sanayi Ve Ticaret Anonim

Şirketi
Rüzgarlıbahçe Mahallesi, Çam Pınarı Sokak,
Smart Plaza 4 4, Beykoz – İstanbul, Türkiye

(540)



(591) Dark blue and grey

(531) 26.11.01; 26.11.12; 27.05.10; 29.01.12

(511)

3 – Hair care preparations; shampoos; hair conditioners; hair lotions; hair dye; hair gels; hair spray; hair mousse.

საერთაშორისო სასაქონლო ნიშნები, რომლებსაც მიენიჭა
დაცვა საქართველოში

(260) AM 2023 113086 A
(800) 1592700
(151) 2021 04 09
(181) 2031 04 09
(891) 2021 04 09
(511) 10

(260) AM 2023 117962 A
(800) 1663480
(151) 2022 03 22
(181) 2032 03 22
(891) 2022 03 22
(511) 09, 36, 42

(260) AM 2023 114834 A
(800) 1616766
(151) 2021 05 03
(181) 2031 05 03
(891) 2021 05 03
(511) 14, 14

(260) AM 2023 118041 A
(800) 1664247
(151) 2022 02 18
(181) 2032 02 18
(891) 2022 02 18
(511) 35

(260) AM 2023 114870 A
(800) 1617939
(151) 2021 03 31
(181) 2031 03 31
(891) 2021 03 31
(511) 41, 42

(260) AM 2023 118042 A
(800) 1664267
(151) 2022 01 27
(181) 2032 01 27
(891) 2022 01 27
(511) 35

(260) AM 2023 115270 A
(800) 1624046
(151) 2021 05 20
(181) 2031 05 20
(891) 2021 05 20
(511) 09, 35, 36, 38, 39, 42, 43

(260) AM 2023 118257 A
(800) 1667885
(151) 2022 04 21
(181) 2032 04 21
(891) 2022 04 21
(511) 09, 39

(260) AM 2023 116797 A
(800) 1646686
(151) 2022 01 25
(181) 2032 01 25
(891) 2022 01 25
(511) 03, 05

(260) AM 2023 118272 A
(800) 1668358
(151) 2021 11 22
(181) 2031 11 22
(891) 2021 11 22
(511) 09, 16, 35, 36, 37, 38, 39, 41, 42, 44

(260) AM 2023 117636 A
(800) 1658268
(151) 2021 12 01
(181) 2031 12 01
(891) 2021 12 01
(511) 01, 02, 03, 04, 05, 06, 07, 08, 09, 10, 11, 12, 13,
14, 15, 16, 17, 18, 19, 20, 21, 22, 23, 24, 25, 26,
27, 28, 29, 30, 31, 32, 33, 34, 35, 36, 37, 38, 39,
40, 41, 42, 43, 44, 45
(551) Collective

(260) AM 2023 118445 A
(800) 1670851
(151) 2022 05 12
(181) 2032 05 12
(891) 2022 05 12
(511) 05

(260) AM 2023 118446 A
(800) 1670874
(151) 2022 01 12
(181) 2032 01 12
(891) 2022 01 12
(511) 19

(260) AM 2023 118447 A
 (800) 1670875
 (151) 2022 01 12
 (181) 2032 01 12
 (891) 2022 01 12
 (511) 19

(260) AM 2023 118455 A
 (800) 1171079
 (151) 2013 04 03
 (181) 2023 04 03
 (891) 2022 04 25
 (511) 03

(260) AM 2023 118448 A
 (800) 1670924
 (151) 2022 06 09
 (181) 2032 06 09
 (891) 2022 06 09
 (511) 09

(260) AM 2023 118456 A
 (800) 1195792
 (151) 2014 02 13
 (181) 2024 02 13
 (891) 2022 06 17
 (511) 03

(260) AM 2023 118449 A
 (800) 1670964
 (151) 2022 01 19
 (181) 2032 01 19
 (891) 2022 01 19
 (511) 09

(260) AM 2023 118457 A
 (800) 1223972
 (151) 2014 07 04
 (181) 2024 07 04
 (891) 2022 06 07
 (511) 10

(260) AM 2023 118450 A
 (800) 1671057
 (151) 2021 09 17
 (181) 2031 09 17
 (891) 2021 09 17
 (511) 09, 14, 16, 18, 21, 24, 25, 28, 30, 32, 35, 41,
 42, 45

(260) AM 2023 118458 A
 (800) 1269210
 (151) 2015 05 21
 (181) 2025 05 21
 (891) 2022 06 07
 (511) 03, 21, 24, 25, 27

(260) AM 2023 118451 A
 (800) 1671125
 (151) 2022 05 06
 (181) 2032 05 06
 (891) 2022 05 06
 (511) 11

(260) AM 2023 118460 A
 (800) 1357774
 (151) 2017 03 17
 (181) 2027 03 17
 (891) 2022 01 13
 (511) 24, 25

(260) AM 2023 118452 A
 (800) 1671145
 (151) 2022 04 20
 (181) 2032 04 20
 (891) 2022 04 20
 (511) 03

(260) AM 2023 118463 A
 (800) 1527051
 (151) 2020 03 10
 (181) 2030 03 10
 (891) 2022 05 13
 (511) 05

(260) AM 2023 118453 A
 (800) 1671174
 (151) 2022 04 27
 (181) 2032 04 27
 (891) 2022 04 27
 (511) 01

(260) AM 2023 118464 A
 (800) 1541159
 (151) 2020 05 25
 (181) 2030 05 25
 (891) 2022 06 07
 (511) 10

(260) AM 2023 118567 A
(800) 1671233
(151) 2022 02 15
(181) 2032 02 15
(891) 2022 02 15
(511) 35

(260) AM 2023 118572 A
(800) 1671333
(151) 2021 12 17
(181) 2031 12 17
(891) 2021 12 17
(511) 35, 36

(260) AM 2023 118573 A
(800) 1671468
(151) 2022 05 19
(181) 2032 05 19
(891) 2022 05 19
(511) 32

(260) AM 2023 118575 A
(800) 1671500
(151) 2022 04 06
(181) 2032 04 06
(891) 2022 04 06
(511) 33

(260) AM 2023 118576 A
(800) 1671508
(151) 2022 05 17
(181) 2032 05 17
(891) 2022 05 17
(511) 05

(260) AM 2023 118577 A
(800) 1671672
(151) 2022 04 15
(181) 2032 04 15
(891) 2022 04 15
(511) 09

(260) AM 2023 118578 A
(800) 1671701
(151) 2022 05 31
(181) 2032 05 31
(891) 2022 05 31
(511) 07, 11

(260) AM 2023 118579 A
(800) 1671702
(151) 2022 05 31
(181) 2032 05 31
(891) 2022 05 31
(511) 08, 10, 21, 24, 25, 28

(260) AM 2023 118580 A
(800) 1671798
(151) 2022 05 11
(181) 2032 05 11
(891) 2022 05 11
(511) 21

(260) AM 2023 118581 A
(800) 1671820
(151) 2021 11 16
(181) 2031 11 16
(891) 2021 11 16
(511) 03

(260) AM 2023 118582 A
(800) 1671825
(151) 2022 04 15
(181) 2032 04 15
(891) 2022 04 15
(511) 34

(260) AM 2023 118583 A
(800) 1671848
(151) 2022 04 18
(181) 2032 04 18
(891) 2022 04 18
(511) 12

(260) AM 2023 118585 A
(800) 1671913
(151) 2022 03 24
(181) 2032 03 24
(891) 2022 03 24
(511) 12, 27

(260) AM 2023 118586 A
(800) 1671916
(151) 2022 04 29
(181) 2032 04 29
(891) 2022 04 29
(511) 12

(260) AM 2023 118587 A
 (800) 1671984
 (151) 2022 05 13
 (181) 2032 05 13
 (891) 2022 05 13
 (511) 32, 43

(260) AM 2023 118626 A
 (800) 1650645
 (151) 2022 01 20
 (181) 2032 01 20
 (891) 2022 06 21
 (511) 05

(260) AM 2023 118593 A
 (800) 1672244
 (151) 2022 03 25
 (181) 2032 03 25
 (891) 2022 03 25
 (511) 19, 35

(260) AM 2023 118627 A
 (800) 1650646
 (151) 2022 01 20
 (181) 2032 01 20
 (891) 2022 06 21
 (511) 05

(260) AM 2023 118594 A
 (800) 1672290
 (151) 2022 05 11
 (181) 2032 05 11
 (891) 2022 05 11
 (511) 10

(260) AM 2023 118628 A
 (800) 1663275
 (151) 2022 05 03
 (181) 2032 05 03
 (891) 2022 06 13
 (511) 05

(260) AM 2023 118622 A
 (800) 1522236
 (151) 2020 02 13
 (181) 2030 02 13
 (891) 2022 05 13
 (511) 05

(260) AM 2023 118666 A
 (800) 1672819
 (151) 2022 04 28
 (181) 2032 04 28
 (891) 2022 04 28
 (511) 01, 02, 17, 19, 37

(260) AM 2023 118623 A
 (800) 1571745
 (151) 2020 11 24
 (181) 2030 11 24
 (891) 2022 06 20
 (511) 24

(260) AM 2023 118667 A
 (800) 1672896
 (151) 2022 04 06
 (181) 2032 04 06
 (891) 2022 04 06
 (511) 41, 42

(260) AM 2023 118624 A
 (800) 1632054
 (151) 2021 09 28
 (181) 2031 09 28
 (891) 2022 06 29
 (511) 03, 04, 08, 18, 21

(260) AM 2023 118668 A
 (800) 1672955
 (151) 2022 06 21
 (181) 2032 06 21
 (891) 2022 06 21
 (511) 03

(260) AM 2023 118625 A
 (800) 1636172
 (151) 2021 12 08
 (181) 2031 12 08
 (891) 2022 06 13
 (511) 02, 37

(260) AM 2023 118675 A
 (800) 1673092
 (151) 2022 05 05
 (181) 2032 05 05
 (891) 2022 05 05
 (511) 30

(260) AM 2023 118676 A
(800) 1673108
(151) 2022 03 10
(181) 2032 03 10
(891) 2022 03 10
(511) 44

(260) AM 2023 118677 A
(800) 1673113
(151) 2022 05 02
(181) 2032 05 02
(891) 2022 05 02
(511) 35, 41, 42

(260) AM 2023 118678 A
(800) 1673114
(151) 2022 05 02
(181) 2032 05 02
(891) 2022 05 02
(511) 35, 41, 42

(260) AM 2023 118699 A
(800) 1673723
(151) 2022 05 11
(181) 2032 05 11
(891) 2022 05 11
(511) 32, 33

(260) AM 2023 118700 A
(800) 1673745
(151) 2022 04 13
(181) 2032 04 13
(891) 2022 04 13
(511) 05

(260) AM 2023 118701 A
(800) 1673756
(151) 2022 06 20
(181) 2032 06 20
(891) 2022 06 20
(511) 05

(260) AM 2023 118703 A
(800) 1673836
(151) 2022 05 19
(181) 2032 05 19
(891) 2022 05 19
(511) 09, 28, 41

(260) AM 2023 118704 A
(800) 1673851
(151) 2022 05 13
(181) 2032 05 13
(891) 2022 05 13
(511) 06

(260) AM 2023 118705 A
(800) 1673893
(151) 2022 02 06
(181) 2032 02 06
(891) 2022 02 06
(511) 25, 35

(260) AM 2023 118711 A
(800) 1138512
(151) 2011 11 24
(181) 2031 11 24
(891) 2022 06 17
(511) 35

(260) AM 2023 118714 A
(800) 1397153
(151) 2017 12 15
(181) 2027 12 15
(891) 2022 06 06
(511) 35, 37

(260) AM 2023 118717 A
(800) 1584186
(151) 2020 12 09
(181) 2030 12 09
(891) 2022 04 06
(511) 10

(260) AM 2023 118768 A
(800) 1674227
(151) 2022 02 18
(181) 2032 02 18
(891) 2022 02 18
(511) 03

(260) AM 2023 118770 A
(800) 1674284
(151) 2022 06 27
(181) 2032 06 27
(891) 2022 06 27
(511) 32

(260) AM 2023 118771 A
 (800) 1674318
 (151) 2022 05 30
 (181) 2032 05 30
 (891) 2022 05 30
 (511) 07, 08, 11

(260) AM 2023 118780 A
 (800) 1674546
 (151) 2022 06 15
 (181) 2032 06 15
 (891) 2022 06 15
 (511) 12

(260) AM 2023 118774 A
 (800) 1674358
 (151) 2022 04 07
 (181) 2032 04 07
 (891) 2022 04 07
 (511) 42

(260) AM 2023 118782 A
 (800) 1674568
 (151) 2021 08 19
 (181) 2031 08 19
 (891) 2021 08 19
 (511) 03, 05, 35

(260) AM 2023 118775 A
 (800) 1674377
 (151) 2022 06 01
 (181) 2032 06 01
 (891) 2022 06 01
 (511) 34

(260) AM 2023 118783 A
 (800) 1674569
 (151) 2021 08 19
 (181) 2031 08 19
 (891) 2021 08 19
 (511) 03, 05, 21, 35

(260) AM 2023 118776 A
 (800) 1674439
 (151) 2022 02 02
 (181) 2032 02 02
 (891) 2022 02 02
 (511) 09, 11, 38, 42, 45

(260) AM 2023 118784 A
 (800) 1674572
 (151) 2021 11 29
 (181) 2031 11 29
 (891) 2021 11 29
 (511) 03, 05, 09, 10, 21, 29, 30, 32, 35, 36, 41, 42, 44

(260) AM 2023 118777 A
 (800) 1674443
 (151) 2022 05 17
 (181) 2032 05 17
 (891) 2022 05 17
 (511) 03

(260) AM 2023 118785 A
 (800) 1674628
 (151) 2022 05 23
 (181) 2032 05 23
 (891) 2022 05 23
 (511) 01, 05, 09, 42, 44

(260) AM 2023 118778 A
 (800) 1674456
 (151) 2022 03 24
 (181) 2032 03 24
 (891) 2022 03 24
 (511) 29, 30

(260) AM 2023 118786 A
 (800) 1674641
 (151) 2022 06 01
 (181) 2032 06 01
 (891) 2022 06 01
 (511) 35, 39

(260) AM 2023 118779 A
 (800) 1674480
 (151) 2022 04 26
 (181) 2032 04 26
 (891) 2022 04 26
 (511) 04

(260) AM 2023 118804 A
 (800) 1675117
 (151) 2022 06 01
 (181) 2032 06 01
 (891) 2022 06 01
 (511) 09, 16, 42

(260) AM 2023 118818 A
(800) 610018
(151) 1993 10 20
(181) 2023 10 20
(891) 2022 07 08
(511) 03

(260) AM 2023 118865 A
(800) 1675497
(151) 2022 07 04
(181) 2032 07 04
(891) 2022 07 04
(511) 30

(260) AM 2023 118819 A
(800) 800742
(151) 2003 03 07
(181) 2023 03 07
(891) 2022 07 07
(511) 16

(260) AM 2023 118881 A
(800) 1675911
(151) 2022 01 27
(181) 2032 01 27
(891) 2022 01 27
(511) 25, 35

(260) AM 2023 118820 A
(800) 1106582
(151) 2011 11 29
(181) 2031 11 29
(891) 2022 07 14
(511) 32, 33

(260) AM 2023 118882 A
(800) 1675932
(151) 2022 04 26
(181) 2032 04 26
(891) 2022 04 26
(511) 12

(260) AM 2023 118821 A
(800) 1338415
(151) 2016 09 29
(181) 2026 09 29
(891) 2022 07 12
(511) 09

(260) AM 2023 118894 A
(800) 1676284
(151) 2022 05 23
(181) 2032 05 23
(891) 2022 05 23
(511) 09, 28, 41

(260) AM 2023 118823 A
(800) 1543670
(151) 2020 03 17
(181) 2030 03 17
(891) 2022 06 27
(511) 03, 05, 35

(260) AM 2023 118895 A
(800) 1676288
(151) 2022 05 30
(181) 2032 05 30
(891) 2022 05 30
(511) 35, 39, 43

(260) AM 2023 118825 A
(800) 1640097
(151) 2021 12 08
(181) 2031 12 08
(891) 2022 06 13
(511) 02, 37

(260) AM 2023 118896 A
(800) 1676289
(151) 2022 05 30
(181) 2032 05 30
(891) 2022 05 30
(511) 35, 39, 43

(260) AM 2023 118826 A
(800) 1640165
(151) 2021 12 08
(181) 2031 12 08
(891) 2022 06 13
(511) 02, 37

(260) AM 2023 118897 A
(800) 1676290
(151) 2022 06 14
(181) 2032 06 14
(891) 2022 06 14
(511) 07

(260) AM 2023 118898 A
 (800) 1676333
 (151) 2022 06 15
 (181) 2032 06 15
 (891) 2022 06 15
 (511) 07, 11

(260) AM 2023 118913 A
 (800) 1535986
 (151) 2020 05 07
 (181) 2030 05 07
 (891) 2022 07 08
 (511) 03

(260) AM 2023 118899 A
 (800) 1676339
 (151) 2022 06 30
 (181) 2032 06 30
 (891) 2022 06 30
 (511) 29

(260) AM 2023 118914 A
 (800) 1634726
 (151) 2021 10 25
 (181) 2031 10 25
 (891) 2022 07 08
 (511) 05

(260) AM 2023 118900 A
 (800) 1676371
 (151) 2022 04 02
 (181) 2032 04 02
 (891) 2022 04 02
 (511) 09

(260) AM 2023 118915 A
 (800) 1664153
 (151) 2022 02 17
 (181) 2032 02 17
 (891) 2022 06 20
 (511) 05, 29, 30, 31, 32, 40, 41

(260) AM 2023 118909 A
 (800) 1309672
 (151) 2016 05 19
 (181) 2026 05 19
 (891) 2022 07 19
 (511) 29

(260) AM 2023 118943 A
 (800) 1676509
 (151) 2022 02 24
 (181) 2032 02 24
 (891) 2022 02 24
 (511) 16, 18, 25, 35

(260) AM 2023 118910 A
 (800) 1450852
 (151) 2018 12 17
 (181) 2028 12 17
 (891) 2022 06 16
 (511) 32

(260) AM 2023 119035 A
 (800) 1678069
 (151) 2022 06 08
 (181) 2032 06 08
 (891) 2022 06 08
 (511) 33

(260) AM 2023 118911 A
 (800) 1460564
 (151) 2019 02 18
 (181) 2029 02 18
 (891) 2022 07 08
 (511) 05

(260) AM 2023 119037 A
 (800) 1678194
 (151) 2022 07 13
 (181) 2032 07 13
 (891) 2022 07 13
 (511) 05

(260) AM 2023 118912 A
 (800) 1479026
 (151) 2019 05 23
 (181) 2029 05 23
 (891) 2022 07 21
 (511) 03

(260) AM 2023 119038 A
 (800) 1678199
 (151) 2022 04 13
 (181) 2032 04 13
 (891) 2022 04 13
 (511) 07

(260) AM 2023 119039 A
(800) 1678229
(151) 2022 01 07
(181) 2032 01 07
(891) 2022 01 07
(511) 20, 21, 30

(260) AM 2023 119040 A
(800) 1678248
(151) 2021 12 30
(181) 2031 12 30
(891) 2021 12 30
(511) 07, 08, 09, 10, 11, 21, 34, 35

(260) AM 2023 119041 A
(800) 1678276
(151) 2022 04 06
(181) 2032 04 06
(891) 2022 04 06
(511) 06

(260) AM 2023 119042 A
(800) 1678357
(151) 2022 05 25
(181) 2032 05 25
(891) 2022 05 25
(511) 05

(260) AM 2023 119060 A
(800) 1678873
(151) 2022 07 26
(181) 2032 07 26
(891) 2022 07 26
(511) 30

ოფიციალური შეტყობინებები

ბამობონებები

პატენტების მოქმედების აღდგენა

(21) AP 2015 14392

(11) P 2019 7034 B

(73) მაკროჯენიკს ინკ.

(54) PD-1 და LAG-3-თან იმუნორეაქტიულობის მქონე კოვალენტურად შეკავშირებული დიასხეულები და მათი გამოყენება

პატენტის გაუქმების თარიღი: 2023 06 19

პატენტის მოქმედების აღდგენის თარიღი: 2023 07 25

(21) AP 2017 14452

(11) P 2018 6914 B

(73) რაულ თურმანიძე;

გიორგი ფოფხაძე;

ვასილ ბაჩანაძე

(54) მოწყობილობა სალესი ჩარხისათვის ცვალებადი ღახრის კუთხის სპირალური ან ხრახნული ღარების დასამუშავებლად

პატენტის გაუქმების თარიღი: 2023 03 16

პატენტის მოქმედების აღდგენის თარიღი: 2023 07 25

პატენტების გაუქმება აღდგენის უფლებით

(21) AP 2012 12766

(11) P 2013 5987 B

(73) სარქის მარქარიანი

(54) წყლის კომპლექსური გაუსნეობის ხერხი და მოღული მის განსახორციელებლად

პატენტის გაუქმების თარიღი: 2023 06 27

პატენტის მოქმედების აღდგენის ზღვრული თარიღი: 2024 06 27

(21) AP 2011 12937

(11) P 2015 6256 B

(73) ნოდარ ჩიგოგიძე;

ალექსანდრე კახაბერი

(54) დიაგნოზური ალკოჰოლიანი სასმელი და მისი მიღების ხერხი

პატენტის გაუქმების თარიღი: 2023 06 28

პატენტის მოქმედების აღდგენის ზღვრული თარიღი: 2024 06 28

(21) AP 2012 13362

(11) P 2017 6667 B

(73) ბერლინ - ხემი აგ

(54) ანტისხეულები ადფ-რიბოზილ ციკლაზა 2-ის მიმართ
პატენტის გაუქმების თარიღი: 2023 06 28
პატენტის მოქმედების აღდგენის ზღვრული თარიღი: 2024 06 28

(21) AP 2017 14954
(11) P 2020 7167 B
(73) ვანდერბილთ უნივერსიტი
(54) მუსკარინული აცეტილქოლინური რეცეპტორის M4 დადებითი ალოსტიმული მოღულატორები
პატენტის გაუქმების თარიღი: 2023 06 22
პატენტის მოქმედების აღდგენის ზღვრული თარიღი: 2024 06 22

(21) AP 2017 14989
(11) P 2020 7204 B
(73) სანტენ ფარმასეუტიკალ კო., ლტდ. ;
დიურექტ კორპორეიშენ
(54) ღეოს ფორმულაციები
პატენტის გაუქმების თარიღი: 2023 06 29
პატენტის მოქმედების აღდგენის ზღვრული თარიღი: 2024 06 29

(21) AP 2005 8873
(11) P 2007 4273 B
(73) სსიპ „თბილისის სახელმწიფო სამედიცინო უნივერსიტეტი“
(54) ხეჭრელის ქმრძიან ანტრაქინონების მიღების ხერხი
პატენტის გაუქმების თარიღი: 2023 06 30
პატენტის მოქმედების აღდგენის ზღვრული თარიღი: 2024 06 30

(21) AP 2005 8874
(11) P 2008 4287 B
(73) სსიპ „თბილისის სახელმწიფო სამედიცინო უნივერსიტეტი“
(54) კუჭ-ნაწლავის ტრაქტის მოქმედების მომწესრიგებელი საშუალების მიღების ხერხი
პატენტის გაუქმების თარიღი: 2023 06 30
პატენტის მოქმედების აღდგენის ზღვრული თარიღი: 2024 06 30

პატენტების მოქმედების აღდგენის ვადის ამოწურვა

(21) AP 2010 12558
(11) P 2014 6156 B
(73) აზიენდე ქიმიჩე რიუნიტე ანჯელინი ფრანჩესკო ა.ც.რ.ა.ფ. ს.პ.ა.
(54) ბენზილამინის გამოყენება P40-ზე დამოკიდებულ დაავადებათა სამკურნალოდ
პატენტის გაუქმების თარიღი: 2022 06 23
პატენტის მოქმედების აღდგენის ვადის ამოწურვის თარიღი: 2023 06 23

(21) AP 2011 13219

(11) P 2016 6450 B

(73) რ-ფარმ ოვერსიზ ინკ.

(54) ციკლური N, N' - დიარილთიოჰარლოვანები და N, N' - დიარილჰარლოვანები, როგორც ანღროპინის რეცეპტორის ანტაგონისტები, კიბოს საწინააღმდეგო აბენტი, მათი მიღების ხერხი და გამოყენება

პატენტის გაუქმების თარიღი: 2022 07 01

პატენტის მოქმედების აღდგენის ვადის ამოწურვის თარიღი: 2023 07 01

(21) AP 2013 13679

(11) P 2017 6689 B

(73) სინტეტიკა ს.ა.

(54) აცეტამინოფენის საინიექციო ზენაჯერი ხსნარი საინალურად შესაყვანად

პატენტის გაუქმების თარიღი: 2022 06 27

პატენტის მოქმედების აღდგენის ვადის ამოწურვის თარიღი: 2023 06 27

(21) AP 2013 13715

(11) P 2017 6672 B

(73) არვენ აილაკ სანაი ვე ტიკარეტ ა.ს.

(54) ხანგრძლივი მოქმედების მქონე მუსკარინული ანტაგონისტების შემცველი კომპოზიციები მშრალი ფხვნილის ინჰალატორისთვის

პატენტის გაუქმების თარიღი: 2022 06 24

პატენტის მოქმედების აღდგენის ვადის ამოწურვის თარიღი: 2023 06 24

(21) AP 2015 14393

(11) P 2019 6979 B

(73) რუსო ინკ.

(54) ცეცხლსაჭრობი შიბა შმრევისა და აირის კარტრიჯით

პატენტის გაუქმების თარიღი: 2022 06 22

პატენტის მოქმედების აღდგენის ვადის ამოწურვის თარიღი: 2023 06 22

(21) AP 2015 14411

(11) P 2020 7096 B

(73) რ-ფარმ ოვერსიზ ინკ.

(54) ჩანაცვლებული 2-თიოქსო-იმიდაზოლიდინ-4-ონები და მათი სპიროანალოგები, კიბოს საწინააღმდეგო აქტიური აბენტები, ფარმაცევტული კომპოზიციები და სამკურნალო პრეპარატი, პროსტატის კიბოს სამკურნალოდ გამოყენებულად

პატენტის გაუქმების თარიღი: 2022 06 26

პატენტის მოქმედების აღდგენის ვადის ამოწურვის თარიღი: 2023 06 26

(21) AP 2017 14537

(11) P 2019 7045 B

(73) ნინო მუხიგულაშვილი;

ვახტანგ კუპრაძე;

გიორგი კეშელავა;

მერაბ ჩალაძე

(54) მაიზოლირებელი პირაკირის ღაზიანების წინა მღვრეობის მონიტორინგის ხერხი
პატენტის გაუქმების თარიღი: 2022 06 30
პატენტის მოქმედების აღდგენის ვადის ამოწურვის თარიღი: 2023 06 30

(21) AP 2017 14538

(11) P 2019 7012 B

(73) ნინო მუხიგულაშვილი;

გიორგი კეშელავა;

მერაბ ჩალაძე;

მურთაზ პაპასკირი;

ვახტანგ კუპრაძე

(54) მაიზოლირებელი პირაკირის წესივრულობის კონტროლის ხერხი

პატენტის გაუქმების თარიღი: 2022 06 30

პატენტის მოქმედების აღდგენის ვადის ამოწურვის თარიღი: 2023 06 30

(21) AP 2016 14678

(11) P 2020 7074 B

(73) ვერნალის (რ&დ) ლტდ;

ლე ლაბორატუარ სერვიე

(54) ახალი ჰიდროქსიმეთირის წარმოებულები, მათი მიღების ხერხი და მათი შემცველი
ფარმაცევტული კომპოზიციები

პატენტის გაუქმების თარიღი: 2022 06 22

პატენტის მოქმედების აღდგენის ვადის ამოწურვის თარიღი: 2023 06 22

(21) AP 2016 14681

(11) P 2020 7056 B

(73) ლე ლაბორატუარ სერვიე;

ვერნალის (რ&დ) ლტდ

(54) ახალი ბიციკლური წარმოებულები, მათი მიღების ხერხი და მათი შემცველი
ფარმაცევტული კომპოზიციები

პატენტის გაუქმების თარიღი: 2022 06 22

პატენტის მოქმედების აღდგენის ვადის ამოწურვის თარიღი: 2023 06 22

(21) AP 2016 14683

(11) P 2020 7169 B

(73) მერკ შარპ & დოუმ კორპ.

(54) 3-ტიტრაზოლილ-გენსოლ-1,2-დისულფონამიდის წარმოებულები როგორც მუცლო-
ბეჭა-ლაქტამაზას ინჰიბიტორები

პატენტის გაუქმების თარიღი: 2022 06 24

პატენტის მოქმედების აღდგენის ვადის ამოწურვის თარიღი: 2023 06 24

(21) AP 2016 14690

(11) P 2020 7117 B

(73) იანსენ საიენს აირლენდ იუსი

(54) ციკლირებელი სულფამოცილინილის წარმოებულები და მათი გამოყენება
მედიკამენტების სახით ჰეპატიტ B-ს სამკურნალოდ

პატენტის გაუქმების თარიღი: 2022 07 01
პატენტის მოქმედების აღდგენის ვადის ამოწურვის თარიღი: 2023 07 01

(21) AP 2020 15380
(11) P 2022 7363 B
(73) ომარ ახმეტელაშვილი;
გიორგი გაგუა;
რამაზ პეტრემღვდლისშვილი
(54) აკვარიუმის თევზების კომპლექსური გამლიზიანებელი ხელსაწყო
პატენტის გაუქმების თარიღი: 2022 06 25
პატენტის მოქმედების აღდგენის ვადის ამოწურვის თარიღი: 2023 06 25

სასარბებლო მოდელები პატენტების მოქმედების აღდგენა

(21) AU 2020 15359
(11) U 2022 2111 Y
(73) ლევან წირღვავა
(54) ლაბალაკოკოლური მატონიზირებელი სასმელი
პატენტის გაუქმების თარიღი: 2023 06 07
პატენტის მოქმედების აღდგენის თარიღი: 2023 07 25

(21) AU 2021 15658
(11) U 2022 2127 Y
(73) რამაზ გახოვიძე;
სოფიო ბურჯანაძე;
გიორგი ბურჯანაძე;
ჯანო ბურჯანაძე;
ნიკოლოზ მექვაბიშვილი
(54) მოწობილობა ღებინვამცვიისათვის ვირუსის Covid 19-ის წინააღმდეგ
პატენტის გაუქმების თარიღი: 2023 06 10
პატენტის მოქმედების აღდგენის თარიღი: 2023 07 25

უფლების გადაცემა

(21) AU 2015 13910

(11) U 2017 1927 Y

(54) ცხიმ და წყალგაუმტარი მშენებლის კონტაინერი კვების პროდუქტისათვის

ახალი პატენტფლობელი და მისამართი: ნორა რობიტაშვილი (GE)

ფანასკერტელის ქ. 20ა, ბ. 26, 0194, თბილისი,

საქართველო (GE)

ყოფილი პატენტფლობელი და მისამართი: ნუგზარ რობიტაშვილი

ფანასკერტელის ქ. 20ა, ბ. 26, 0194, თბილისი,

საქართველო (GE)

რეესტრში შეტანის თარიღი: 2023 07 04

დიზაინები

დიზაინების რეგისტრაციის მოქმედების ვადის გაგრძელება

(11) D 2013 541 S

(73) სააქციო „საზოგადოება ლომისი“ (GE)

სოფ. ნატახტარი, 3308, მცხეთა, ნატახტარი (GE)

(54) ბ(ო)ლი

(28) 1

(24) 2013 03 05

(18) 2028 03 05

(58) 2023 07 12

(11) D 2013 542 S

(73) სააქციო „საზოგადოება ლომისი“ (GE)

სოფ. ნატახტარი, 3308, მცხეთა, ნატახტარი (GE)

(54) ბ(ო)ლი

(28) 1

(24) 2013 03 05

(18) 2028 03 05

(58) 2023 07 12

(11) D 2013 543 S

(73) სააქციო „საზოგადოება ლომისი“ (GE)

სოფ. ნატახტარი, 3308, მცხეთა, ნატახტარი (GE)

(54) ბ(ო)ლი

(28) 1

(24) 2013 03 05

(18) 2028 03 05

(58) 2023 07 12

საერთაშორისო დიზაინების რეგისტრაციის მოქმედების გაუქმება

(11) DM/69323

(73) Swatch AG (Swatch SA) (Swatch LTD)

Jakob-Stämpfli-Strasse 94, CH-2502 Biel/Bienne (CH)

რეგისტრაციის მოქმედების გაუქმების თარიღი: 2022 10 15

(58) 2023 07 12

(11) DM/69332

(73) Swatch AG (Swatch SA) (Swatch LTD.)

Jakob-Stämpfli-Strasse 94, CH-2502 Biel/Bienne (CH)

რეგისტრაციის მოქმედების გაუქმების თარიღი: 2022 10 08

(58) 2023 07 12

(11) DM/69344

(73) TCH AG (Swatch SA) (Swatch LTD.)

TCH AG (Swatch SA) (Swatch LTD.) Jakob-Stämpfli-Strasse 94, CH-2502 Biel/Bienne (CH)

რეგისტრაციის მოქმედების გაუქმების თარიღი: 2022 10 08

(58) 2023 07 12

(11) DM/69481

(73) Société Des Produits Nestlé S.A.

CH-1800 Vevey (CH)

რეგისტრაციის მოქმედების გაუქმების თარიღი: 2022 11 23

(58) 2023 07 12

(11) DM/69482

(73) Union Uhrenfabrik GMBH

Altenberger Strasse 1, 01768 GLASHÜTTE/SA (DE)

რეგისტრაციის მოქმედების გაუქმების თარიღი: 2022 11 21

(58) 2023 07 12

(11) DM/78666

(73) Alfred Kärcher GmbH & Co. KG

Alfred-Kärcher-Straße 28-40, 71364 Winnenden (DE)

რეგისტრაციის მოქმედების გაუქმების თარიღი: 2022 06 28

(58) 2023 07 12

(11) DM/78698

(73) Ivana Lukovic

11 M. Botsari, GR-166 75 Athens (GR)

რეგისტრაციის მოქმედების გაუქმების თარიღი: 2022 07 06

(58) 2023 07 12

(11) DM/78724

(73) Alfred Kärcher Gmbh & Co. KG

Alfred-Kärcher-Straße 28-40, 71364 Winnenden (DE)

რეგისტრაციის მოქმედების გაუქმების თარიღი: 2022 07 16

(58) 2023 07 12

(11) DM/78725

(73) Alfred Kärcher Gmbh & Co. KG

Alfred-Kärcher-Straße 28-40, 71364 Winnenden (DE)

რეგისტრაციის მოქმედების გაუქმების თარიღი: 2022 07 17

(58) 2023 07 12

სასაქონლო ნიშნები

რეგისტრაციის მოქმედების ვადის გაგრძელება

(111) M 2003 15218 R2 (151) 2003 07 17 (186) 2033 07 17 (732) ზე პროექტერ & გემბლ კომპანი უან პროექტერ & გემბლ პლაზა, ცინცინატი, ოჰაიო, აშშ	1030 დელტა ბულვარდ, ატლანტა, ჯორჯია, აშშ
(111) M 2003 15360 R2 (151) 2003 12 15 (186) 2033 12 15 (732) ზე პროექტერ & გემბლ კომპანი უან პროექტერ & გემბლ პლაზა, ცინცინატი, ოჰაიო, აშშ	(111) M 2013 23892 R1 (151) 2013 08 14 (186) 2033 08 14 (732) ზე პროექტერ & გემბლ კომპანი უან პროექტერ & გემბლ პლაზა, ცინცინატი, ოჰაიო 45202, აშშ
(111) M 2012 23096 R1 (151) 2012 11 29 (186) 2032 11 29 (732) ქვჯ თურქი გიდა სანაიი ანონიმ შირქეთი ნისპეთიე ჯადდესი, აქმერქეუ ალიშვერიშ მერქეზი, B ბლოკ, ქათ: 5, ეთილერ, ბეშიქთაშ-სტამბოლი, თურქეთი	(111) M 2013 24027 R1 (151) 2013 09 17 (186) 2033 09 17 (732) ოლდ ნევი (იტმ) ინკ. 2 ფოლსომ სტრიტი, სან-ფრანცისკო, კალიფორნია 94105, აშშ
(111) M 2013 23623 R1 (151) 2013 04 26 (186) 2033 04 26 (732) დპ ბევერიჯიზ ანლიმიტიდ კომპანი საუთგეთ, დუბლინ როუდ, დროგჰკედა, ქაუნთი მით, A92 YK7W, ირლანდია	(111) M 2013 24028 R1 (151) 2013 09 17 (186) 2033 09 17 (732) ოლდ ნევი (იტმ) ინკ. 2 ფოლსომ სტრიტი, სან-ფრანცისკო, კალიფორნია 94105, აშშ
(111) M 2013 23588 R1 (151) 2013 04 12 (186) 2033 04 12 (732) ირაკლი ლლონტი ივ. ჯავახიშვილის ქ. 27, 0102, თბილისი, საქართველო	(111) M 2013 23925 R1 (151) 2013 08 14 (186) 2033 08 14 (732) ჰონდა მოტორ კო., ლტდ 1-1, მინამი-აოიამა 2-ჩომე, მინატო-კუ, 107-8556 ტოკიო, იაპონია
(111) M 2013 23755 R1 (151) 2013 06 07 (186) 2033 06 07 (732) დელტა ეარ ლაინზ, ინკ. (შტატ დელავერის კორპორაცია)	(111) M 2013 24261 R1 (151) 2013 11 18 (186) 2033 11 18 (732) შპს „თელედა“ გლდანი, III მკრ., კორპ. 5, ბ. 13, 0167, თბილისი, საქართველო

(111) M 2013 24088 R1
(151) 2013 09 30
(186) 2033 09 30
(732) ლჯ ჰ&ჰ კო., ლტდ
58, საემუნან-რო, ჯონგნო-გუ, სეული,
კორეის რესპუბლიკა

(111) M 2013 24091 R1
(151) 2013 09 30
(186) 2033 09 30
(732) ზე პროქტერ & გემბლ კომპანი
უან პროქტერ & გემბლ პლაზა, ცინცინატი,
ოჰაიო 45202, აშშ

(111) M 2013 24114 R1
(151) 2013 09 30
(186) 2033 09 30
(732) ზე პროქტერ & გემბლ კომპანი
უან პროქტერ & გემბლ პლაზა, ცინცინატი,
ოჰაიო 45202, აშშ

(111) M 2013 24007 R1
(151) 2013 09 02
(186) 2033 09 02
(732) ზე პროქტერ & გემბლ კომპანი
უან პროქტერ & გემბლ პლაზა, ცინცინატი,
ოჰაიო 45202, აშშ

(111) M 2013 24245 R1
(151) 2013 11 04
(186) 2033 11 04
(732) შპს „ჰს ფარმა“
იაკობ ცურტაველის ქ. 54, 1700, დმანისი,
საქართველო

(111) M 2013 23657 R1
(151) 2013 05 14
(186) 2033 05 14
(732) აქციონერნოე ობსჩესტვო „პეტერბურგსკი
მელნიჩნი კომბინატ“
4 პრედპორტოვი პროეზდ, 5, 196240
ანჟტ პეტერბურგი, რუსეთის ფედერაცია

უფლებების სრული ბაღაცემა

(111) M 2019 30977 R

(732) შპს „მარანი კაპისტონი“
 ნინო რამიშვილის ქ. 2, ბ. 29, ვაკე-
 საბურთალოს რაიონი, თბილისი,
 საქართველო

(770) ი/მ ევგენია გროგორიევა
 მ. ჩახავას ქ. 4, ბ. 1, თბილისი,
 საქართველო

(580) 2023 07 04

(111) M 2013 24026 R

(732) მედიკავერ ჰოლდინგ (საიპრეს) ლიმიტიდ
 აეირინის 119, 3041 ლიმასოლი,
 საბერძნეთი

(770) უიმზიკალ ჰოლდინგ ლიმიტიდ
 აეირინის 119, 3041 ლიმასოლი, კვიპროსი

(580) 2023 05 14

(111) M 2020 33313 R

(732) სჯ 4დპლექს კო., ლტდ
 აი-პარკ მოლ 8თ ფლ., 55, ჰანგანგ-დაერო
 23-გილი, იონგსან-გუ, სეული, კორეის
 რესპუბლიკა

(770) სჯ სგვ კო., ლტდ
 აი-პარკ მოლი მე-6 ფლორი, 55,
 ჰანგანგ-დაერო 23-გილი, იონგსან-გუ,
 სეული, კორეის რესპუბლიკა

(580) 2023 05 18

(111) M 2018 30125 R

(732) ზე უილიამ კარტერ კომპანი
 3438 პიტრი როუდ NE, სუიტ 1800,
 ატლანტა, ჯორჯია 30326, აშშ

(770) თამარ ამაშუკელი
 ილია ჭავჭავაძის გამზ. 11ა, 0179,
 თბილისი, საქართველო

(580) 2023 07 04

(111) M 2022 36166 R

(732) ობშჩესტვო ს ოგრანიჩენიოი
 ოტვეტსტვენოსტიუ „რიტიელ
 ლოგისტიკ“
 ულ. ტრუდოვია, დ. 10, სკლ. 3, ლიტერა
 1ბ, პომ. II, დ.პ. როდნიკი, რამენსკი
 რ-ნ., მოსკოვსკაია ობლ., 140143,
 რუსეთის ფედერაცია

(770) დავით აბაიაძე
 გამსახურდიას ქ., III კვარტ., კორპ. 6ბ,
 ბ. 18, თბილისი, საქართველო

(580) 2023 06 12

(111) M 2005 16318 R

(732) შპს „დი და ჯი“
 აღმაშენებლის გამზ. 158, დიდუბის
 რაიონი, თბილისი, საქართველო

(770) დავითი ოტიაშვილი
 ბუდაპეშტის ქ., II შესახ. 7, 0160,
 თბილისი, საქართველო

(580) 2023 06 16

ფლოპელის სახელის და/ან მისამართის ცვლილებები

(111) M 2023 37004 R

(732) შპს „როიალ გემბლინგ“
დემეტრე თავდადებულის ქ. 50, ბ. 91,
6000, ბათუმი, საქართველო

(770) შპს „ეს ფი ბარ ისთ“
დემეტრე თავდადებულის ქ. 50, ბ. 91,
6000, ბათუმი, საქართველო

(580) 2023 06 28

პო ბოქს 309GT, უგლანდ ჰაუზი, საუთ
ჩერჩ სტრიტი, ჯორჯ ტაუნი, დიდი
კაიმანი, კაიმანის კუნძულები
(580) 2023 06 08

(111) M 2023 37000 R

(732) შპს „როიალ გემბლინგ“
დემეტრე თავდადებულის ქ. 50, ბ. 91,
6000, ბათუმი, საქართველო

(770) შპს „ეს ფი ბარ ისთ“
დემეტრე თავდადებულის ქ. 50, ბ. 91,
6000, ბათუმი, საქართველო

(580) 2023 06 28

(111) M 2023 37024 R

(732) შპს „როიალ გემბლინგ“
დემეტრე თავდადებულის ქ. 50, ბ. 91,
6000, ბათუმი, საქართველო

(770) შპს „ეს ფი ბარ ისთ“
დემეტრე თავდადებულის ქ. 50, ბ. 91,
6000, ბათუმი, საქართველო

(580) 2023 06 28

(111) M 2013 23968 R

(732) სკეჩერს იუ.ეს.ეი, ინკ, II, ვირჯინიის
კორპორაცია
228 მანჰეტენ ბიჩ ბლვდ., მანჰეტენ ბიჩი,
კალიფორნია 90266, აშშ

(770) სკეჩერს იუ.ეს.ეი, ინკ, II, დელავარის
კორპორაცია
228 მანჰეტენ ბიჩ ბლვდ., მანჰეტენ ბიჩი,
კალიფორნია 90266, აშშ

(580) 2023 07 03

(111) M 2013 23916 R

(732) დბ ბევერიჯიზ ანლიმიტიდ კომპანი
საუთგეით, დუბლინ როუდ, დროგჰედა,
ქაუნთი მით, A92 YK7W, ირლანდია

(770) დბ ბევერიჯიზ ანლიმიტიდ კომპანი

სასაქონლო ნიშნების რეგისტრაციის გაუქმება

(111) M 2012 23209 R

(151) 2012 12 24

(732) ჩონგეინგ სოკონ ინდასტრი გრუპ სტოკ

კო., ლტდ

61-1, ჯინქიაო როუდი, შაპინგბა

დისტრიქტი, ჩონგეინგი, ჩინეთის

სახალხო რესპუბლიკა

(141) 2023 07 06

(141) 2023 07 07

(111) M 2012 23218 R

(151) 2012 12 24

(732) ოო „აკვა ლაიფ“

ქ. ჩერნოგოლოვკა, 23 კმ., მოსკოვის ოლქი,

142432, რუსეთის ფედერაცია

(141) 2023 07 07

(111) M 2012 23210 R

(151) 2012 12 24

(732) ჩონგეინგ სოკონ ინდასტრი გრუპ სტოკ

კო., ლტდ

61-1, ჯინქიაო როუდი, შაპინგბა

დისტრიქტი, ჩონგეინგი, ჩინეთის

სახალხო რესპუბლიკა

(141) 2023 07 07

(111) M 2012 23219 R

(151) 2012 12 24

(732) ოო „აკვა ლაიფ“

ქ. ჩერნოგოლოვკა, 23 კმ., მოსკოვის ოლქი,

142432, რუსეთის ფედერაცია

(141) 2023 07 07

(111) M 2012 23211 R

(151) 2012 12 24

(732) ბესტ ვესტერნ ინტერნეშენელ ინკ.

6201 ნორტ 24 პარკვეი, ფენიქსი, არიზონა

85016, აშშ

(141) 2023 07 07

(111) M 2012 23220 R

(151) 2012 12 24

(732) ოო „აკვა ლაიფ“

ქ. ჩერნოგოლოვკა, 23 კმ., მოსკოვის ოლქი,

142432, რუსეთის ფედერაცია

(141) 2023 07 07

(111) M 2012 23212 R

(151) 2012 12 24

(732) ბესტ ვესტერნ ინტერნეშენელ ინკ.

6201 ნორტ 24 პარკვეი, ფენიქსი, არიზონა

85016, აშშ

(141) 2023 07 07

(111) M 2012 23221 R

(151) 2012 12 24

(732) ოო „აკვა ლაიფ“

ქ. ჩერნოგოლოვკა, 23 კმ., მოსკოვის ოლქი,

142432, რუსეთის ფედერაცია

(141) 2023 07 07

(111) M 2012 23213 R

(151) 2012 12 24

(732) ბესტ ვესტერნ ინტერნეშენელ ინკ.

6201 ნორტ 24 პარკვეი, ფენიქსი, არიზონა

85016, აშშ

(141) 2023 07 07

(111) M 2012 23222 R

(151) 2012 12 24

(732) ოო „აკვა ლაიფ“

ქ. ჩერნოგოლოვკა, 23 კმ., მოსკოვის ოლქი,

142432, რუსეთის ფედერაცია

(141) 2023 07 07

(111) M 2012 23215 R

(151) 2012 12 24

(732) ბესტ ვესტერნ ინტერნეშენელ ინკ.

6201 ნორტ 24 პარკვეი, ფენიქსი, არიზონა

85016, აშშ

(111) M 2012 23223 R

(151) 2012 12 24

(732) ოო „აკვა ლაიფ“

ქ. ჩერნოგოლოვკა, 23 კმ., მოსკოვის ოლქი,

142432, რუსეთის ფედერაცია

(141) 2023 07 07

(111) M 2012 23224 R

(151) 2012 12 24

(732) ოოო „აკვა ლაიფ“

ქ. ჩერნოგოლოვკა, 23 კმ., მოსკოვის ოლქი,

142432, რუსეთის ფედერაცია

(141) 2023 07 07

სისტემური საკიბელები გამოგონებები

საერთაშორისო კლასიფიკაციის ინდექსის და ბანაცხაღის
გამოქვეყნების ნომრის შესაბამისობის ცხრილი

საერთაშორისო კლასიფიკაციის ინდექსი (51)	ბანაცხაღის გამოქვეყნების ნომერი (10)
A 01 J 5/14; A 01 J 5/007	AP 2023 16003 A
A 61 P 35/00; C 07 K 16/28	AP 2023 15366 A
C 07 D 401/14; C 07 D 413/12; C 07 D 413/14; C 07 D 417/14; C 07 D 471/04; C 07 D 401/12	AP 2023 15648 A
F 01 K 21/04	AP 2023 15921 A

ბანაცხაღის გამოქვეყნების ნომრის და საერთაშორისო
კლასიფიკაციის ინდექსის შესაბამისობის ცხრილი

ბანაცხაღის გამოქვეყნების ნომერი (10)	საერთაშორისო კლასიფიკაციის ინდექსი (51)
AP 2023 15366 A	A 61 P 35/00; C 07 K 16/28
AP 2023 15648 A	C 07 D 401/14; C 07 D 413/12; C 07 D 413/14; C 07 D 417/14; C 07 D 471/04; C 07 D 401/12
AP 2023 15921 A	F 01 K 21/04
AP 2023 16003 A	A 01 J 5/14; A 01 J 5/007

საერთაშორისო კლასიფიკაციის ინდექსის, პატენტის ნომრისა
და გამოქვეყნების ნომრის შესაბამისობის ცხრილი

საერთაშორისო კლასიფიკაციის ინდექსი (51)	პატენტის ნომერი (11)	ბანაცხაღის გამოქვეყნების ნომერი (10)
A 61 K 9/00; A 61 K 47/26; A 61 K 47/18; A 61 K 39/00; C 07 K 16/24	P 2023 7521 B	AP 2023 15302 A
E 02 B 9/00; F 03 B 13/00	P 2023 7520 B	AP 2023 15484 A

პატენტის ნომრის, ბანაცხაღის გამოქვეყნების ნომრისა
და საქრთაშორისო კლასიფიკაციის ინდექსის შესაბამისობის ცხრილი

პატენტის ნომერი (11)	ბანაცხაღის გამოქვეყნების ნომერი (10)	საქრთაშორისო კლასიფიკაციის ინდექსი (51)
P 2023 7520 B	AP 2023 15484 A	E 02 B 9/00; F 03 B 13/00
P 2023 7521 B	AP 2023 15302 A	A 61 K 9/00; A 61 K 47/26; A 61 K 47/18; A 61 K 39/00; C 07 K 16/24

ბანაცხაღის ნომრის, ბანაცხაღის გამოქვეყნების ნომრისა
და პატენტის ნომრის შესაბამისობის ცხრილი

ბანაცხაღის ნომერი (21)	ბანაცხაღის გამოქვეყნების ნომერი (10)	პატენტის ნომერი (11)
AP 2018 15302	AP 2023 15302 A	P 2023 7521 B
AP 2020 15484	AP 2023 15484 A	P 2023 7520 B

სასარბებლო მოდელები

საქრთაშორისო კლასიფიკაციის ინდექსის და ბანაცხაღის
გამოქვეყნების ნომრის შესაბამისობის ცხრილი

საქრთაშორისო კლასიფიკაციის ინდექსი (51)	ბანაცხაღის გამოქვეყნების ნომერი (10)
H 01 B 7/295	AU 2023 16090 U

ბანაცხაღის გამოქვეყნების ნომრის და საქრთაშორისო
კლასიფიკაციის ინდექსის შესაბამისობის ცხრილი

ბანაცხაღის გამოქვეყნების ნომერი (10)	საქრთაშორისო კლასიფიკაციის ინდექსი (51)
AU 2023 16090 U	H 01 B 7/295

საერთაშორისო კლასიფიკაციის ინდექსის, პატენტის ნომრისა
და გამოქვეყნების ნომრის შესაბამისობის ცხრილი

საერთაშორისო კლასიფიკაციის ინდექსი (51)	პატენტის ნომერი (11)	ბანაცხაღის გამოქვეყნების ნომერი (10)
A 61 G 10/00	U 2023 2154 Y	AU 2023 16056 U
G 10 D 1/00	U 2023 2153 Y	AU 2023 15837 U

პატენტის ნომრის, ბანაცხაღის გამოქვეყნების ნომრისა
და საერთაშორისო კლასიფიკაციის ინდექსის შესაბამისობის ცხრილი

პატენტის ნომერი (11)	ბანაცხაღის გამოქვეყნების ნომერი (10)	საერთაშორისო კლასიფიკაციის ინდექსი (51)
U 2023 2153 Y	AU 2023 15837 U	G 10 D 1/00
U 2023 2154 Y	AU 2023 16056 U	A 61 G 10/00

ბანაცხაღის ნომრის, ბანაცხაღის გამოქვეყნების ნომრისა
და პატენტის ნომრის შესაბამისობის ცხრილი

ბანაცხაღის ნომერი (21)	ბანაცხაღის გამოქვეყნების ნომერი (10)	პატენტის ნომერი (11)
AU 2021 15837	AU 2023 15837 U	U 2023 2153 Y
AU 2022 16056	AU 2023 16056 U	U 2023 2154 Y

ღიზინები

საერთაშორისო კლასიფიკაციის ინდექსის, რეგისტრაციის ნომრისა
და გამომქვეყნების ნომრის შესაბამისობის ცხრილი

საერთაშორისო კლასიფიკაციის ინდექსი (51)	რეგისტრაციის ნომერი (11)	ბანაცხაღის გამომქვეყნების ნომერი (10)
11-01	D 2023 974 S	AD 2023 1284 S

რეგისტრაციის ნომრის, ბანაცხაღის გამომქვეყნების ნომრისა
და საერთაშორისო კლასიფიკაციის ინდექსის შესაბამისობის ცხრილი

რეგისტრაციის ნომერი (11)	ბანაცხაღის გამომქვეყნების ნომერი (10)	საერთაშორისო კლასიფიკაციის ინდექსი (51)
D 2023 974 S	AD 2023 1284 S	11-01

ბანაცხაღის ნომრის, ბანაცხაღის გამომქვეყნების ნომრისა
და რეგისტრაციის ნომრის შესაბამისობის ცხრილი

ბანაცხაღის ნომერი (21)	ბანაცხაღის გამომქვეყნების ნომერი (10)	რეგისტრაციის ნომერი (11)
AD 2022 1284	AD 2023 1284 S	D 2023 974 S

სასაქონლო ნიშნები

რეგისტრაციის ნომრის, ბანაცხაღის ნომრის, ბანაცხაღის გამოქვეყნების
ნომრისა და ბიულეტენის ნომრის შესაბამისობის ცხრილი

რეგისტრაციის ნომერი (111)	ბანაცხაღის ნომერი (210)	ბანაცხაღის გამოქვეყნების ნომერი (260)	ბიულეტენის ნომერი
1	2	3	4
M 2023 37032 R	AM 123104	-	14(617)2023
M 2023 37033 R	AM 123165	-	14(617)2023
M 2023 37034 R	AM 123171	-	14(617)2023
M 2023 37035 R	AM 123172	-	14(617)2023
M 2023 37036 R	AM 123173	-	14(617)2023
M 2023 37037 R	AM 123174	-	14(617)2023
M 2023 37038 R	AM 123175	-	14(617)2023
M 2023 37039 R	AM 123176	-	14(617)2023
M 2023 37040 R	AM 123218	-	14(617)2023
M 2023 37041 R	AM 123582	-	14(617)2023
M 2023 37042 R	AM 123497	-	14(617)2023
M 2023 37043 R	AM 123412	-	14(617)2023
M 2023 37044 R	AM 123415	-	14(617)2023
M 2023 37045 R	AM 123505	-	14(617)2023
M 2023 37046 R	AM 123506	-	14(617)2023
M 2023 37047 R	AM 118862	AM 2023 118862 A	4(607)2023
M 2023 37048 R	AM 109440	AM 2023 109440 A	1(604)2023
M 2023 37049 R	AM 119099	AM 2023 119099 A	6(609)2023
M 2023 37050 R	AM 119092	AM 2023 119092 A	6(609)2023
M 2023 37051 R	AM 118927	AM 2023 118927 A	6(609)2023
M 2023 37052 R	AM 119194	AM 2023 119194 A	6(609)2023
M 2023 37053 R	AM 118079	AM 2022 118079 A	24(603)2022
M 2023 37054 R	AM 118845	AM 2023 118845 A	5(608)2023
M 2023 37055 R	AM 119084	AM 2023 119084 A	6(609)2023
M 2023 37056 R	AM 119111	AM 2023 119111 A	6(609)2023
M 2023 37057 R	AM 118854	AM 2023 118854 A	5(608)2023
M 2023 37058 R	AM 118393	AM 2023 118393 A	5(608)2023
M 2023 37059 R	AM 118830	AM 2023 118830 A	4(607)2023
M 2023 37060 R	AM 118747	AM 2023 118747 A	4(607)2023
M 2023 37061 R	AM 118748	AM 2023 118748 A	4(607)2023
M 2023 37062 R	AM 118749	AM 2023 118749 A	4(607)2023
M 2023 37063 R	AM 118767	AM 2023 118767 A	4(607)2023
M 2023 37064 R	AM 119091	AM 2023 119091 A	5(608)2023
M 2023 37065 R	AM 119090	AM 2023 119090 A	5(608)2023
M 2023 37066 R	AM 118745	AM 2023 118745 A	4(607)2023
M 2023 37067 R	AM 118744	AM 2023 118744 A	4(607)2023
M 2023 37068 R	AM 118743	AM 2023 118743 A	4(607)2023
M 2023 37069 R	AM 118379	AM 2023 118379 A	2(605)2023
M 2023 37070 R	AM 118739	AM 2023 118739 A	4(607)2023
M 2023 37071 R	AM 118742	AM 2023 118742 A	4(607)2023

1	2	3	4
M 2023 37072 R	AM 118740	AM 2023 118740 A	4(607)2023
M 2023 37073 R	AM 118741	AM 2023 118741 A	4(607)2023
M 2023 37074 R	AM 118738	AM 2023 118738 A	4(607)2023
M 2023 37075 R	AM 118638	AM 2023 118638 A	2(605)2023
M 2023 37076 R	AM 118380	AM 2023 118380 A	2(605)2023
M 2023 37077 R	AM 118381	AM 2023 118381 A	2(605)2023
M 2023 37078 R	AM 118637	AM 2023 118637 A	2(605)2023
M 2023 37079 R	AM 118382	AM 2023 118382 A	2(605)2023
M 2023 37080 R	AM 118636	AM 2023 118636 A	2(605)2023
M 2023 37081 R	AM 118383	AM 2023 118383 A	2(605)2023
M 2023 37082 R	AM 118635	AM 2023 118635 A	2(605)2023
M 2023 37083 R	AM 118634	AM 2023 118634 A	2(605)2023
M 2023 37084 R	AM 118746	AM 2023 118746 A	4(607)2023

ბანაცხადის გამომწვევების ნომრისა და ბანაცხადის ნომრის
შესაბამისობის ცხრილი

ბანაცხადის გამომწვევების ნომერი (260)	ბანაცხადის ნომერი (210)	1	2
1	2	AM 2023 120512 A	AM 120512
AM 2023 119177 A	AM 119177	AM 2023 120515 A	AM 120515
AM 2023 119195 A	AM 119195	AM 2023 120517 A	AM 120517
AM 2023 119790 A	AM 119790	AM 2023 120520 A	AM 120520
AM 2023 119792 A	AM 119792	AM 2023 120524 A	AM 120524
AM 2023 119892 A	AM 119892	AM 2023 120527 A	AM 120527
AM 2023 119893 A	AM 119893	AM 2023 120530 A	AM 120530
AM 2023 120046 A	AM 120046	AM 2023 120531 A	AM 120531
AM 2023 120048 A	AM 120048	AM 2023 120598 A	AM 120598
AM 2023 120240 A	AM 120240	AM 2023 120604 A	AM 120604
AM 2023 120252 A	AM 120252	AM 2023 120606 A	AM 120606
AM 2023 120257 A	AM 120257	AM 2023 120607 A	AM 120607
AM 2023 120259 A	AM 120259	AM 2023 120608 A	AM 120608
AM 2023 120339 A	AM 120339	AM 2023 120610 A	AM 120610
AM 2023 120358 A	AM 120358	AM 2023 120612 A	AM 120612
AM 2023 120359 A	AM 120359	AM 2023 120613 A	AM 120613
AM 2023 120435 A	AM 120435	AM 2023 120618 A	AM 120618
AM 2023 120440 A	AM 120440	AM 2023 120628 A	AM 120628
AM 2023 120448 A	AM 120448	AM 2023 120629 A	AM 120629
AM 2023 120497 A	AM 120497	AM 2023 120735 A	AM 120735
AM 2023 120498 A	AM 120498	AM 2023 120827 A	AM 120827
AM 2023 120499 A	AM 120499	AM 2023 120833 A	AM 120833
AM 2023 120504 A	AM 120504	AM 2023 120834 A	AM 120834
AM 2023 120510 A	AM 120510	AM 2023 120837 A	AM 120837
AM 2023 120511 A	AM 120511	AM 2023 120838 A	AM 120838
		AM 2023 120839 A	AM 120839
		AM 2023 120841 A	AM 120841
		AM 2023 120847 A	AM 120847
		AM 2023 120859 A	AM 120859

1	2
AM 2023 120862 A	AM 120862
AM 2023 120937 A	AM 120937
AM 2023 120939 A	AM 120939
AM 2023 120957 A	AM 120957
AM 2023 120958 A	AM 120958
AM 2023 120959 A	AM 120959
AM 2023 120975 A	AM 120975

1	2
AM 2023 120976 A	AM 120976
AM 2023 121041 A	AM 121041
AM 2023 121042 A	AM 121042
AM 2023 121043 A	AM 121043
AM 2023 121050 A	AM 121050
AM 2023 121126 A	AM 121126

ბანაცხაღის გამომწვევების ნომრის საბიუჯეტო საქონლისა
და/ან მომსახურების კლასის მიხედვით

საქონლისა და/ან მომსახურების კლასი (511)	ბანაცხაღის გამომწვევების ნომერი (260)
1	2
3	AM 2023 120257 A
3	AM 2023 120339 A
3	AM 2023 120511 A
3	AM 2023 120612 A
3	AM 2023 120862 A
4	AM 2023 120975 A
4	AM 2023 120976 A
5	AM 2023 119195 A
5	AM 2023 120257 A
5	AM 2023 120520 A
5	AM 2023 121041 A
5	AM 2023 121042 A
5	AM 2023 121043 A
6	AM 2023 120841 A
7	AM 2023 120847 A
9	AM 2023 120435 A
9	AM 2023 120957 A
9	AM 2023 120958 A
9	AM 2023 120959 A
11	AM 2023 120511 A
12	AM 2023 120259 A
12	AM 2023 120440 A
16	AM 2023 120530 A
16	AM 2023 120610 A
16	AM 2023 120613 A
19	AM 2023 120841 A
21	AM 2023 120847 A
25	AM 2023 119790 A
25	AM 2023 120046 A

1	2
25	AM 2023 120612 A
25	AM 2023 120937 A
29	AM 2023 119177 A
29	AM 2023 119195 A
29	AM 2023 120252 A
29	AM 2023 120833 A
30	AM 2023 120048 A
30	AM 2023 120252 A
30	AM 2023 120339 A
30	AM 2023 120527 A
30	AM 2023 120833 A
30	AM 2023 120834 A
30	AM 2023 120837 A
30	AM 2023 120838 A
30	AM 2023 120839 A
30	AM 2023 121041 A
30	AM 2023 121042 A
30	AM 2023 121043 A
30	AM 2023 121050 A
30	AM 2023 121126 A
31	AM 2023 120339 A
31	AM 2023 120833 A
32	AM 2023 119195 A
32	AM 2023 119792 A
32	AM 2023 119892 A
32	AM 2023 119893 A
32	AM 2023 120339 A
32	AM 2023 120517 A
32	AM 2023 120524 A
32	AM 2023 120735 A
32	AM 2023 120827 A
32	AM 2023 120939 A
33	AM 2023 120240 A
33	AM 2023 120339 A
33	AM 2023 120504 A

1	2
33	AM 2023 120515 A
33	AM 2023 120524 A
33	AM 2023 120530 A
33	AM 2023 120735 A
33	AM 2023 120859 A
33	AM 2023 120939 A
33	AM 2023 120608 A
33	AM 2023 120628 A
33	AM 2023 120629 A
34	AM 2023 120531 A
34	AM 2023 120618 A
35	AM 2023 119892 A
35	AM 2023 119893 A
35	AM 2023 120240 A
35	AM 2023 120252 A
35	AM 2023 120512 A
35	AM 2023 120517 A
35	AM 2023 120530 A
35	AM 2023 120613 A
35	AM 2023 120833 A
35	AM 2023 120937 A
35	AM 2023 120957 A
35	AM 2023 120958 A
35	AM 2023 120959 A
36	AM 2023 120497 A
36	AM 2023 120498 A
36	AM 2023 120499 A
36	AM 2023 120610 A

1	2
36	AM 2023 120613 A
36	AM 2023 120957 A
36	AM 2023 120958 A
36	AM 2023 120959 A
37	AM 2023 120448 A
37	AM 2023 120497 A
37	AM 2023 120498 A
37	AM 2023 120499 A
39	AM 2023 120339 A
41	AM 2023 120510 A
41	AM 2023 120957 A
41	AM 2023 120958 A
41	AM 2023 120959 A
42	AM 2023 120607 A
42	AM 2023 120957 A
42	AM 2023 120958 A
42	AM 2023 120959 A
43	AM 2023 120252 A
43	AM 2023 120339 A
43	AM 2023 120358 A
43	AM 2023 120511 A
43	AM 2023 120604 A
43	AM 2023 120606 A
44	AM 2023 120257 A
44	AM 2023 120511 A
45	AM 2023 120359 A
45	AM 2023 120598 A

დაჩქარებული პროცედურით რეგისტრირებული სასაქონლო ნიშნის ნომრის
საბიუჯეტო საქონლისა და/ან მომსახურების კლასის მიხედვით

საქონლისა და/ან მომსახურების კლასი (511)	დაჩქარებული პროცედურით რეგისტრირებული სასაქონლო ნიშნის ნომერი (111)
7	M 2023 37045 R
7	M 2023 37046 R
11	M 2023 37045 R
11	M 2023 37046 R
24	M 2023 37045 R
34	M 2023 37032 R
34	M 2023 37033 R
34	M 2023 37034 R
34	M 2023 37035 R
34	M 2023 37036 R
34	M 2023 37037 R
34	M 2023 37038 R
34	M 2023 37039 R
34	M 2023 37044 R
35	M 2023 37040 R
35	M 2023 37041 R
35	M 2023 37043 R
37	M 2023 37043 R
42	M 2023 37043 R
43	M 2023 37042 R
44	M 2023 37043 R

სამრეწველო საკუთრების
ოფიციალური ბიულეტენი

14(617)

გამოგონებები
სასარგებლო მოდელები
დიზაინები
სასაქონლო ნიშნები

მთავარი რედაქტორი:	ნ. ბებრიშვილი
კორექტორი:	ლ. ჭანტურია
დამკაზადონებლები:	მ. ორდენიძე ქ. სვანიძე
პოლიგრაფიული ჯგუფი:	მ. მეჩტიშვილი ი. გოგოლაშვილი ლ. დოლიძე

ISSN 2720-8478

ხელმოწერილია გამოსაცემად 2023 07 22

ტირაჟი 10
შეკვეთა №14

ბიულეტენის ელექტრონული ვერსიის გაცნობა შესაძლებელია საქპატენტის ვებგვერდზე