

სამრეწველო საკუთრების ოფიციალური ბიულეტენი

გამოგონებები

დიზაინები

სასაქონლო ნიშნები

საქონლის ადგილწარმოშობის დასახელებები



საქართველოს ინტელექტუალური
საკუთრების ეროვნული ცენტრი
საკპატიენტი
SAKPATENTI
NATIONAL INTELLECTUAL PROPERTY
CENTER OF GEORGIA
www.sakpatenti.gov.ge

გამოქვეყნების თარიღი – 2023 08 10

15(618)

საერთაშორისო კოდები გიზლიომბრაფიული მონაცემების იდენტიფიკაციისათვის

გამომონებები, სასარგებლო მოდელები

- (10) - ექსპერტიზაგაეული განაცხადის გამოქვეყნების ნომერი/ განაცხადის გამოქვეყნების ნომერი***
- (11) - პატენტის ნომერი/ პატენტის ნომერი*** რეგისტრირებული სასარგებლო მოდელების ნომერი***
- (21) - განაცხადის ნომერი
- (22) - განაცხადის შეტანის თარიღი
- (23) - საგამოფენო პრიორიტეტის თარიღი
- (24) - თარიღი, რომლიდანაც იწყება პატენტის მოქმედება
- (31) - საპრიორიტეტო განაცხადის ნომერი
- (32) - საპრიორიტეტო განაცხადის შეტანის თარიღი
- (33) - კოდი ქვეყნისა ან რეგიონული ორგანიზაციისა, რომლის უწყებამაც მიანიჭა ნომერი საპრიორიტეტო განაცხადს
- (43) - განაცხადის გამოქვეყნების თარიღი, ბიულეტენის ნომერი***
- (44) - დამცავი საბუთის ჯერ არმქონე, მაგრამ ექსპერტიზაგაეული განაცხადის გამოქვეყნების თარიღი და ბიულეტენის ნომერი
- (45) - პატენტის გამოქვეყნების თარიღი/ პატენტის გამოქვეყნების თარიღი*** რეგისტრირებული სასარგებლო მოდელების გამოქვეყნების თარიღი***
- (51) - საერთაშორისო საპატენტო კლასიფიკაციის ინდექსი
- (54) - გამოგონების დასახელება/ სასარგებლო მოდელების დასახელება
- (57) - რეზიუმე ტექსტი
- (60) - სრულ ექსპერტიზაგაეულ გამოგონებაზე უცხოური საპატენტო უწყების მიერ გაცემული დამცავი საბუთის ნომერი, თარიღი, რომლიდანაც იწყება ამ დამცავი საბუთის მოქმედება, და კოდი ქვეყნისა ან რეგიონული ორგანიზაციისა, რომლის უწყებამაც გასცა ეს დამცავი საბუთი
- (62) - ადრინდელი განაცხადის ნომერი და ნარდგენის თარიღი გამოყოფილი განაცხადის შემთხვევაში
- (71) - განმცხადებლის სახელი, გვარი ან დასახელება (ქვეყნის კოდი, მისამართი)
- (72) - გამომგონებლის სახელი, გვარი (ქვეყნის კოდი)
- (73) - პატენტმფლობელის/ პატენტმფლობელის***/ რეგისტრირებული სასარგებლო მოდელების მფლობელის*** სახელი, გვარი ან დასახელება (ქვეყნის კოდი, მისამართი)
- (74) - ნარმომადგენლის ან პატენტრწმუნებულის სახელი, გვარი
- (85) - საერთაშორისო (PCT) განაცხადის ეროვნული ფაზის დაწყების თარიღი
- (86) - საერთაშორისო (PCT) განაცხადის ნომერი და შეტანის თარიღი
- (87) - საერთაშორისო (PCT) განაცხადის გამოქვეყნების ნომერი და თარიღი
- (94) - დაცვის დამატებითი მოწმობით გაგრძელებული პატენტის მოქმედების ვადის ამონაწერის თარიღი

ლიზინები

- (10) - განაცხადის გამოქვეყნების ნომერი
- (11) - პატენტის ნომერი და სახეობის კოდი ან რეგისტრაციის ნომერი
- (15) - რეგისტრაციის თარიღი/პატენტის გაგრძელების თარიღი
- (18) - პატენტის ან რეგისტრაციის მოქმედების ვადის გასვლის საგარეულო თარიღი
- (21) - განაცხადის ნომერი
- (22) - განაცხადის შეტანის თარიღი
- (23) - საგამოფენო პრიორიტეტის თარიღი ან ადრინდელი პრიორიტეტის მქონე განაცხადის შეტანის თარიღი და, თუ შესაძლებელია, განაცხადის ნომერი
- (24) - თარიღი, რომლიდანაც იწყება პატენტის მოქმედება
- (28) - დიზაინების რაოდენობა განაცხადში
- (30) - საპრიორიტეტო მონაცემები (განაცხადის ნომერი, განაცხადის შეტანის თარიღი და ორსაიანი კოდი იმ ორგანიზაციის იდენტიფიკაციისათვის, სადაც იყო ნარდგენილი საპრიორიტეტო განაცხადი)
- (31) - საპრიორიტეტო განაცხადის ნომერი
- (32) - საპრიორიტეტო განაცხადის შეტანის თარიღი
- (33) - კოდი ქვეყნისა ან რეგიონული ორგანიზაციისა, რომლის უწყებამაც მიანიჭა ნომერი საპრიორიტეტო განაცხადს
- (34) - ისმო-ს სტანდარტის (მთ.3) შესაბამისი ორსაიანი კოდი იმ ორგანიზაციის იდენტიფიკაციისათვის, სადაც იყო ნარდგენილი საპრიორიტეტო განაცხადი
- (44) - დიზაინის გამოქვეყნების თარიღი და ბიულეტენის ნომერი (პირველი პუბლიკაცია)
- (45) - საერთაშორისო ბიუროს მიერ დარეგისტრირებული დიზაინის გამოქვეყნების თარიღი და ბიულეტენის ნომერი
- (51) - დიზაინების საერთაშორისო კლასიფიკაცია (ლოკარნოს კლასიფიკაციის კლასი და ქვეკლასი)
- (54) - დიზაინის დასახელება
- (55) - დიზაინის გამოსახულება
- (57) - დიზაინის არსებითი ნიშნების აღწერა, ფერის ჩათვლით
- (58) - ყველა სახის ცვლილების შესახებ რეესტრში ჩანაწერის შეტანის თარიღი
- (62) - ადრინდელი განაცხადის, რეგისტრაციის ან საბუთის ნომერი და, თუ შესაძლებელია, ნარდგენის თარიღი, გამოცალკევებული განაცხადის შემთხვევაში
- (71) - განმცხადებლის სახელი, გვარი (ქვეყნის კოდი), მისამართი
- (72) - ავტორის სახელი, გვარი ან დასახელება (ქვეყნის კოდი)
- (73) - პატენტმფლობელის სახელი, გვარი (ქვეყნის კოდი), მისამართი
- (74) - ნარმომადგენლის სახელი, გვარი ან მისამართი
- (81) - შესაბამისი მონაწილე მხარეები:
 - II. მონაწილე მხარეები, აღნიშნული 1960 წლის აქტის თანახმად
 - III. მონაწილე მხარეები, აღნიშნული 1999 წლის აქტის თანახმად
- (85) - მფლობელის მუდმივი საცხოვრებელი ადგილი
- (86) - მფლობელის მოქალაქეობა
- (87) - მფლობელის საცხოვრებელი ადგილი
- (88) - ქვეყანა, სადაც მფლობელს აქვს ნამდვილი და მოქმედი სამრეწველო ან საეჭრო სანარმო

სასაქონლო ნიშნები

- (111) - რეგისტრაციის ნომერი
- (151) - რეგისტრაციის თარიღი
- (156) - რეგისტრაციის ვადის გაგრძელების თარიღი
- (181) - რეგისტრაციის ვადის გასვლის საგარეულო თარიღი
- (186) - ვადის გაგრძელების ვადის გასვლის საგარეულო თარიღი
- (141) - რეგისტრაციის მოქმედების ვადის გაუქმების თარიღი
- (210) - განაცხადის ნომერი
- (220) - განაცხადის შეტანის თარიღი
- (230) - საგამოფენო მონაცემები
- (260) - ნომერი განაცხადისა, რომელზედაც გამოტანილია ექსპერტიზის დადებითი გადაწყვეტილება რეგისტრაციის შესახებ (გამოქვეყნების ნომერი)
- (310) - პირველი განაცხადის ნომერი
- (320) - პირველი განაცხადის შეტანის თარიღი
- (330) - პირველი განაცხადის მიმღები ეროვნული ან რეგიონული უწყების ან ორგანიზაციის საიდენტიფიკაციო კოდი
- (511) - საქონლისა და მომსახურების საერთაშორისო კლასიფიკაცია სასაქონლო ნიშნის რეგისტრაციისათვის და/ან კლასიფიკირებული საქონლისა და/ან მომსახურების ჩამონათვალი
- (526) - დისკლამაცია
- (531) - სასაქონლო ნიშნის გამოსახულებითი ელემენტების აღწერა სასაქონლო ნიშნების გამოსახულებითი ელემენტების საერთაშორისო კლასიფიკაციის (ვენის კლასიფიკაცია) მიხედვით
- (540) - ნიშნის გამოსახულება
- (550) - სასაქონლო ნიშნის ტიპი ან სახეობა
- (551) - მითითება, რომ ნიშანი არის კოლექტიური, სასერტიფიკაციო ან საგარანტო
- (554) - სამგანზომილებიანი (მოცულობითი) ნიშანი
- (580) - განაცხადსა და ნიშნის რეგისტრაციისთან დაკავშირებული ყველა სახის ცვლილებაზე ჩანაწერის შეტანის თარიღი
- (591) - ინფორმაცია განაცხადებულ ფერებზე
- (731) - განმცხადებლის სახელი და მისამართი
- (732) - მფლობელის სახელი და მისამართი
- (740) - ნარმომადგენლის სახელი და მისამართი
- (750) - მიმონერის მისამართი
- (770) - ცვლილებამდე განმცხადებლის ან მფლობელის სახელი და მისამართი უფლების გადაცემის შემთხვევაში
- (771) - ცვლილებამდე განმცხადებლის ან მფლობელის სახელი და მისამართი უფლების გადაცემის გარეშე
- (791) - ლიცენზიატის სახელი და მისამართი
- (793) - ლიცენზიის პირობები და/ან შეზღუდვაზე მინიშნება (ლიცენზიის სახე, სალიცენზიო ხელშეკრულების ნომერი, სალიცენზიო ხელშეკრულების თარიღი, სალიცენზიო ხელშეკრულების მოქმედების ვადა)
- (800) - სასაქონლო ნიშნის რეგისტრაციის მონაცემები ნიშნების საერთაშორისო რეგისტრაციის მადრიდის ხელშეკრულებასთან დაკავშირებული პროტოკოლის მიხედვით (საერთაშორისო რეგისტრაციის ნომერი)
- (852) - ნაწილობრივ გაუქმებული საქონლის/მომსახურების ჩამონათვალი
- (891) - შემდგომი გაერცელების თარიღი

- (21) AP 0000 000000 - გამოგონების განაცხადის ნომერი
- (10) AP 0000 0000 A - გამოგონების განაცხადის გამოქვეყნების ნომერი
- (11) P 0000 0000 B - გამოგონების პატენტის ნომერი/ პატენტის ნომერი***
- (21) API 0000 000000 - შემოტანილი პატენტზე განაცხადის ნომერი
- (11) PI 0000 0000 A - შემოტანილი პატენტის ნომერი
- (21) AU 0000 000000 - სასარგებლო მოდელების განაცხადის ნომერი
- (10) AU 0000 000 U - სასარგებლო მოდელების განაცხადის გამოქვეყნების ნომერი
- (11) U 0000 000 Y - სასარგებლო მოდელების პატენტის ნომერი/ რეგისტრირებული სასარგებლო მოდელების ნომერი***
- (21) AD 0000 000000 - დიზაინზე განაცხადის ნომერი
- (10) AD 0000 000 S - დიზაინზე განაცხადის გამოქვეყნების ნომერი (პირველი პუბლიკაცია)
- (11) D 0000 000 S - რეგისტრირებული დიზაინი
- (21) AP 0000 000000 - გამოგონების განაცხადის ნომერი
- (10) AP 0000 0000 A - გამოგონების განაცხადის გამოქვეყნების ნომერი
- (11) P 0000 0000 B - გამოგონების პატენტის ნომერი/ პატენტის ნომერი***
- (21) API 0000 000000 - შემოტანილი პატენტზე განაცხადის ნომერი
- (11) PI 0000 0000 A - შემოტანილი პატენტის ნომერი
- (21) AU 0000 000000 - სასარგებლო მოდელების განაცხადის ნომერი
- (10) AU 0000 000 U - სასარგებლო მოდელების განაცხადის გამოქვეყნების ნომერი
- (11) U 0000 000 Y - სასარგებლო მოდელების პატენტის ნომერი/ რეგისტრირებული სასარგებლო მოდელების ნომერი***
- (21) AD 0000 000000 - დიზაინზე განაცხადის ნომერი
- (10) AD 0000 000 S - დიზაინზე განაცხადის გამოქვეყნების ნომერი (პირველი პუბლიკაცია)
- (11) D 0000 000 S - რეგისტრირებული დიზაინი

გამომონებებისა და სასარგებლო მოდელების საერთაშორისო კლასიფიკაციის ინდექსები

- განყოფილება A - ადამიანის პირველადი მოთხოვნების საგნები
- განყოფილება B - ტექნოლოგიური პროცესები; ტრანსპორტირება
- განყოფილება C - ქიმიკა; მეტალურგია
- განყოფილება D - საფიქრო ნაწარმი; ქალაქი
- განყოფილება E - მშენებლობა; სამთო საქმე; სტაციონარული ნაგებობები
- განყოფილება F - მექანიკა; განათება; გათბობა; იარაღი; ასაფეთქებელი საშუალებები
- განყოფილება G - ფიზიკა
- განყოფილება H - ელექტრობა

* საქპატენტის სააპელაციო პალატის გადაწყვეტილების შემდეგ გამოქვეყნებული განაცხადის ნომერი

** სასამართლოს გადაწყვეტილების შემდეგ გამოქვეყნებული განაცხადის ნომერი

*** საქართველოს საპატენტო კანონი 2023 წლის 16 მაისი (№2883-XIმს-XXმ) შეტანილი ცვლილების შესაბამისად გამოქვეყნებული მასალები

- M - სასაქონლო ნიშანი
- (210) AM 0000 000000 - განაცხადის ნომერი
- (260) AAM 0000 000000 A - განაცხადის გამოქვეყნების ნომერი
- (111) M 0000 00000 R - რეგისტრაციის ნომერი
- MMM0000 00000 Rn - მომდევნო ვადით რეგისტრაციის ნომერი, სადაც n = 1, 2, 3...
- M 0000 00000 R(P) - რეგისტრაციის ნომერი ნიშანზე უფლების ნაწილობრივი გადაცემისას

სამრეწველო საკუთრების ოფიციალური ბიულეტენი

გამოგონებები

დიზაინები

სასაქონლო ნიშნები

საქონლის ადგილწარმოშობის დასახელებები

შ ი ნ ა ა რ ს ი

| | |
|---|-----|
| გამოქვეყნებული ობიექტები | 3 |
| გამოგონებები | |
| • განაცხადები, რომლებზეც გამოტანილია გადაწყვეტილება პატენტის გაცემის შესახებ | 4 |
| • გამოგონების პატენტები | 8 |
| • განაცხადი *** | 11 |
| დიზაინები | |
| • განაცხადი, რომელზეც გამოტანილია გადაწყვეტილება რეგისტრაციის შესახებ | 12 |
| • დაჩქარებული პროცედურით რეგისტრირებული დიზაინი | 14 |
| • დიზაინები, რომლებიც რეგისტრირებულია საერთაშორისო ბიუროში საქართველოს ტერიტორიაზე უფლებათა გავრცელების მოთხოვნით | 15 |
| სასაქონლო ნიშნები | |
| • ეროვნული პროცედურით შემოტანილი განაცხადები, რომლებზეც გამოტანილია გადაწყვეტილება რეგისტრაციის შესახებ | 26 |
| • რეგისტრირებული სასაქონლო ნიშნები | 61 |
| • დაჩქარებული პროცედურით რეგისტრირებული სასაქონლო ნიშნები | 68 |
| • საერთაშორისო სასაქონლო ნიშნები, რომლებზეც გამოტანილია გადაწყვეტილება დაცვის მინიჭების შესახებ | 78 |
| • საერთაშორისო სასაქონლო ნიშნები, რომლებსაც მიენიჭა დაცვა საქართველოში | 213 |
| საქონლის ადგილწარმოშობის დასახელების დასახელების წარმოების სპეციფიკაციების ცვლილება | 222 |
| ოფიციალური შეტყობინებები | |
| გამოგონებები | |
| პატენტის მოქმედების ვადის ამოწურვა | 224 |
| დიზაინები | |
| • დიზაინის რეგისტრაციის მოქმედების ვადის გაგრძელება | 224 |
| • დიზაინების რეგისტრაციის მოქმედების გაუქმება | 224 |
| • საერთაშორისო დიზაინების რეგისტრაციის მოქმედების ვადის გაგრძელება | 225 |
| სასაქონლო ნიშნები | |
| • რეგისტრაციის მოქმედების ვადის გაგრძელება | 229 |
| • უფლებების სრული გადაცემა | 230 |
| • მფლობელების სახელის და/ან მისამართის ცვლილებები | 231 |
| • სასაქონლო ნიშნების რეგისტრაციის გაუქმება | 236 |
| სისტემური საპიუბლიკო | |
| გამოგონებები | 240 |
| დიზაინები | 243 |
| სასაქონლო ნიშნები | 244 |

ბამოქვეყნებული ობიექტები

ბამობონებები

- ბანაცხადები, რომლებზეც ბამოტანილია გადაწყვეტილება პატენტის ბაცემის შესახებ:
16005; 15908; 16164; 15512; 15392; 15618; 15988; 15894
- პატენტები:
7522-7528
- ბანაცხადი:***
16262

ღიზინები

- ბანაცხადი, რომელზეც ბამოტანილია გადაწყვეტილება რეგისტრაციის შესახებ:
1304
- დაჩქარებული პროცედურით რეგისტრირებული ღიზინი:
975
- ღიზინები, რომლებიც რეგისტრირებულია საერთაშორისო ბიუროში საქართველოს ტერიტორიაზე უფლებათა ბაზრებზე მითხოვნით:
224972; 222984; 227519; 225201; 225802; 229665; 226125

სასაქონლო ნიშნები

- ეროვნული პროცედურით შემოტანილი ბანაცხადები, რომლებზეც ბამოტანილია გადაწყვეტილება რეგისტრაციის შესახებ:
110203*, 110204*; 114671*; 119787; 119991; 119994; 120514; 120699; 120701; 120707; 120711; 120815; 120816; 120824; 120840; 120844; 120849-120852; 120854; 120856; 120938; 120948; 120955; 120956; 121051; 121123; 121127; 121132-121139; 121212; 121216; 121245-121247; 121301; 121303-121305; 121324-121335; 121352
- რეგისტრირებული სასაქონლო ნიშნები:
37085-37090; 37104-37154; 371156-37163
- დაჩქარებული პროცედურით რეგისტრირებული სასაქონლო ნიშნები:
37091-37103; 37155; 37164-37178
- საერთაშორისო სასაქონლო ნიშნები, რომლებზეც ბამოტანილია გადაწყვეტილება დაცვის მინიჭების შესახებ:
106415*; 112330*; 118977; 119839-119843; 119932-119935; 120087, 120088; 120126; 120192-120195; 120262; 120269-120272; 120276; 120282; 120284; 120301-120303; 120305-120309; 120312; 120319-120322; 120392-120396; 120403-120406; 120408-120417; 120422; 120425; 120463, 120464; 120475-120479; 120483, 120484; 120536, 120537; 120540; 120543; 120545, 120546; 120549, 120550; 120565-120567; 120569, 120570; 120583-120588; 120590; 120653-120664; 120680; 120682, 120683; 120688; 120693, 120694; 120738; 120740-120742; 120779-120782; 120784-120789; 120791-120800; 120802; 120885; 120891-120897; 120977, 120978; 120983-120990; 121014; 121063-121067
- საერთაშორისო სასაქონლო ნიშნები, რომლებსაც მიენიჭა დაცვა საქართველოში:
116472; 117236; 117689; 118459; 118461, 118462; 118689-118698; 118706-118708; 118772; 118787-118789; 118791-118795; 118800; 118802, 118803; 118805, 118806; 118815; 118817; 118822; 118824; 118866-118872; 118885-118890; 118901-118903; 118905-118907; 118944-118950; 118952, 118953; 118958-118965; 118968-118970; 118972; 118976; 118979-118981; 118983; 118986; 118991; 119027-119029; 119059; 119061-119073; 119216-119219; 119223-119225; 119232; 119234; 119257-119263

საქონლის ადგილწარმოშობის დასახელებები

მუკუზანი, წინანდალი, ახაშენი, თელიანი

გამომგონებები

ბანაცხადები, რომლებზეც გამოტანილია გადაწყვეტილება პატენტის გაცემის შესახებ

გადაწყვეტილების გასაჩივრება შესაძლებელია საქპატენტის სააპელაციო პალატაში გამოქვეყნებიდან 3 თვის ვადაში ან მცხეთის რაიონული სასამართლოს ადმინისტრაციულ საქმეთა კოლეგიაში 1 თვის ვადაში (მის.: ქ. მცხეთა, სამხედროს ქ. №17).

ბანყოფილება A

A 61

- (10) AP 2023 16005 A (51) Int. Cl. (2006)
A 61 K 31/4164
A 61 P 19/02
A 61 P 17/06
A 61 P 11/06
A 61 P 3/10
C 07 D 491/048

(21) AP 2020 16005 (22) 2020 12 14

(31) 19217856.4

(32) 2019 12 19

(33) EP

(71) ბაიერ აკციენგეზელშაფთ (DE)

კაიზერ-ვილჰელმ-ალეე 1, ლევერკუზენი,
51373, გერმანია (DE)

(72) ჰანა ცერნეკა (DE);

ფრანკ ზახერი (DE);

ანტონიუს ტერ ლააკი (DE);

ჰოლგერ ზიბენაიხერი (DE);

ოლაფ პანკინი (DE);

ჰიდეკი მიატაკე, ონდოზაბალი (DE);

ანტჟე როტმანი (DE);

საბინე პილარი (DE);

რაინჰარდ ნუბემეიერი (DE);

კატრინ ნოვაკ-რეპელი (DE);

გერნოტ ლანგერი (DE);

ნიკოლ შმიდტი (DE)

(74) თამარ კოჭლამაზაშვილი

(85) 2022 07 15

(86) PCT/EP2020/085905, 2020 12 14

(54) ფუროინდაზოლის წარმოებულები

(57) ფუროინდაზოლის ნაერთები, ზოგადი ფორ-
მულით (I),

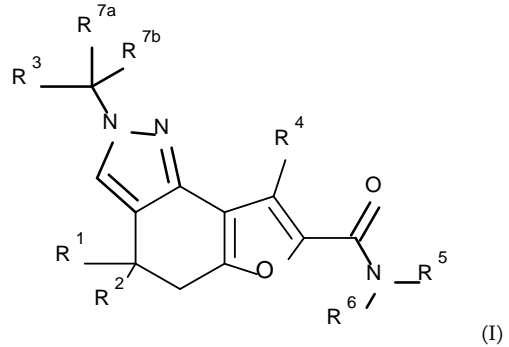

მათი მიღების ხერხები და ხერხში გამოსადეგი
შუალედური ნაერთები, ფარმაცევტული კომპო-
ზიციები მათ საფუძველზე და მათი გამოყენება
აუტოიმუნური დაავადებების სამკურნალოდ.

მუხლები: 4 დამოუკიდებელი

4 დამოკიდებული

(10) AP 2023 15908 A (51) Int. Cl. (2006)

A 61 K 31/4196

A 61 P 35/00

C 07 D 455/02

C 07 D 451/02

C 07 D 471/04

C 07 D 487/04

C 07 D 491/107

C 07 D 403/14

C 07 D 401/14

C 07 D 405/14

C 07 D 413/14

C 07 D 498/04

C 07 D 417/14

C 07 D 498/08

(21) AP 2020 15908 (22) 2020 09 22

(31) 62/905,532; 63/021,216; 63/069,831

(32) 2019 09 25; 2020 05 07; 2020 08 25

(33) US; US; US

(71) პფაიზერ ინკ. (US)

66, ჰადსონ ბულვარ ისტ, ნიუ-იორკი, N.Y.
10001-2192, აშშ (US)

(72) ენდრიუ ფენსომე (US);

ეთან ლოურენს ფიშერ (US);

კეტან ს. გაჯივალა (US);
ჩან ვუ ჰუპ (US);
მეჰრან ჯალაი (US);
ინდრავან ჯეიმს მაკალპინ (US);
რაიან პატმან (US);
იუჯინ იუანჟინ რუი (US);
ტუან ფონგ ტრან (US);
მარტინ ჯეიმს უაიტეს (US);
ლეი ჟანგ (US);
დაჰუი ჟოუ (US)

- (74) შალვა გვარამაძე
(85) 2022 03 21
(86) PCT/IB2020/058854, 2020 09 22
(54) STING-ის (ინტერფერონის გენების სტიმულატორის) კოლიკვინტინის მონო-მულტიმერები
(57) ნაერთები, ზოგადი ფორმულით (I),

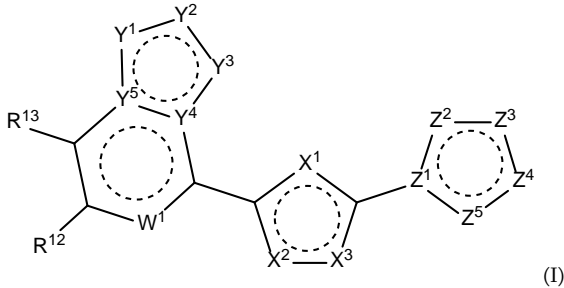

ფარმაცევტული კომპოზიციები მათ საფუძველზე და მათი გამოყენება მუშემწოვარში ანთალური უჯრედის ზრდის სამკურნალოდ.
მუხლები: 8 დამოუკიდებელი
20 დამოკიდებული

(10) AP 2023 16164 A (51) Int. Cl. (2006)
A 61 K 36/00

- (21) AP 2023 16164 (22) 2023 02 09
(71) ბაბრი ორენი (US)
15050 შერმან ვეი, #201, ვან ნუის, CA, USA, 91356, აშშ (US)
(72) ბაბრი ორენი (US)
(74) დავით ძამუკაშვილი
(54) მცენარეულ ნედლეულზე დამზადებული კიბოს სამკურნალო-საპროფილაქტიკო ფარმაცევტული კომპოზიციები

(57) ფარმაცევტული კომპოზიციები შეიცავს ფიჭვის (Pinus) წიწვებისა და ყურძნის მშრალი ჭაჭის ექსტრაქტისა და ფარმაცევტულად მისაღები დანამატის მშრალ ფხვნილს, კოჭას (Zingiber officinale), კურკუმას (Curcuma longa), თეთრი იორდასალამის (Paeonia), ვარდისფერი როდიოლას (Rhodiola Rosea), გარგარის (Prunus) თესლის, კალმახა სოკოს (Pleurotus ostreatus), მწვანე ჩაის (Camellia sinensis), გინგო ბილობას (Ginkgo

biloba), თეთრი პილპილის, ბროწეულის (Punica granatum) რბილობის, ზღმარტლის (Mespilus germanica) მშრალ ექსტრაქტებს, ბროწეულის (Punica granatum) წვენი მშრალ ფხვნილსა და ფოლიუმის მჟავას.
მუხლები: 2 დამოუკიდებელი
4 დამოკიდებული

(10) AP 2023 15512 A (51) Int. Cl. (2006)
A 61 K 39/00
A 61 K 39/395
A 61 P 7/02
A 61 P 37/02
C 07 K 16/40

- (21) AP 2016 15512 (22) 2016 11 09
(62) AP 2016 14803 2016 11 09
(31) 62/252,814; 62/406,726
(32) 2015 11 09; 2016 10 11
(33) US; US
(71) იუნივერსიტი ოფ ლესტერ (GB)
იუნივერსიტი როუდ, ლესტერშირი, LE1 7RH, გაერთიანებული სამეფო (GB);
ომეროს კორპორეიშენ (US)
201 ელიოტ ავენიუ უესტ, სიეტლი ვაშინგტონი, 98119, აშშ (US)
(72) ტომას დადლერი (US);
გრეგორი ა. დემოპულოსი (US);
ჰანს-ვილჰელმ შვებლე (GB)
(74) თამარ კოჭლამაზაშვილი
(85) 2020 12 09
(86) PCT/US2016/061113, 2016 11 09

(54) MASP-2 მაინვიბიტორები ანტი-სეპსისის გამომწვევას MASP-2 დამოკიდებული კომპლემენტის აქტივაციის ანტი-სეპსისის მკურნალო-მედიკამენტების მკურნალობისათვის
(57) გამოგონება უზრუნველყოფს კომპოზიციის, რომელიც შეიცავს MASP-2 მაინვიბიტორულ მონოკლონურ ანტი-სეპსისს, გამოყენებას კომპლემენტის MASP2 დამოკიდებული აქტივაციის ეფექტების ინჰიბირებისათვის ადამიანი-სუბიექტისათვის, რომელსაც აღენიშნება პლაზმათერაპიისადმი რეზისტენტული ატიპიური ჰემოლიზურ-ურემიული სინდრომი (aHUS).
მუხლები: 1 დამოუკიდებელი
6 დამოკიდებული
ფიგურა: 70

- (10) AP 2023 15392 A (51) Int. Cl. (2006)
A 61 K 39/29
A 61 K 39/295
A 61 P 31/20
- (21) AP 2018 15392 (22) 2018 12 18
(31) 62/607,426; PCT/IB2017/058142
(32) 2017 12 19; 2017 12 19
(33) US; IB
- (71) იანსენ საიენსის აირლენდ ანლიმიტედ კომპანი (IE)
ბარმახელი, რინგასკიდი, კო. კორკ, ირლანდია (IE)
- (72) დორინ დე პოტერ (BE);
სოუმიტრა როი (NL);
ჰელენ ჰორტონ (BE);
ჯან-მარკ ედმონ ფერნან მარი ნეფს (BE);
დანიელ ბოდან (BE)
- (74) თამარ კოჭლამაზაშვილი
(85) 2020 07 17
(86) PCT/IB2018/060259, 2018 12 18
(54) B ჰეპატიტის ვირუსის (HBV) ვაქცინები და მათი ბამოქინება
- (57) გამოგონება ეხება B ჰეპატიტის ვირუსის (HBV) მოდიფიცირებული ანტიგენების მაკოდირებული პოლინუკლეოტიდების გამოყენებას ვაქცინების მისაღებად ქრონიკული HBV ინფექციის სამკურნალოდ.
მუხლები: 5 დამოუკიდებელი
19 დამოკიდებული
ფიგურა: 9

- (10) AP 2023 15618 A (51) Int. Cl. (2006)
A 61 K 47/40
A 61 K 47/69
A 61 K 31/5377
A 61 P 35/02
- (21) AP 2019 15618 (22) 2019 10 30
(31) 62/753,164
(32) 2018 10 31
(33) US
- (71) ნოვარტის ავ (CH)
ლიჰსშტრასე 35, 4056 ბაზელი, შვეიცარია (CH);
ლე ლაბორატუარ სერვიე (FR)
35, რიუ დე ვერდიუ, 92284 სურანს სედექსი, საფრანგეთი (FR)
- (72) კაროლინ შემინი (FR);
თი ტრან თუ (FR);
ჟან-მანუელ პინი (FR);
მაია შანრიონი (FR)
- (74) თამაზ შილაკაძე

- (85) 2021 04 29
(86) PCT/EP2019/079644, 2019 10 30
(54) BCL-2 ინჰიბიტორების ციკლოქსტრინის ფუნქციონირების ფორმულაციები
- (57) ფარმაცევტული კომპოზიცია შეიცავს 5-(5-ქლორ-2-[[[(3S)-3-(მორფოლინ-4-ილმეთილ)-3,4-დიჰიდროიზოქინოლინ-2(1H)-ილ]კარბონილ]ფენილ)-N-(5-ციანო-1,2-დიმეთილ-1H-პიროლ-3-ილ)-N-(4-ჰიდროქსიფენილ)-1,2-დიმეთილ-1H-პიროლ-3-კარბოქსამიდს და ჰიდროქსიპროპილ-β-ციკლოდექსტრინს.
მუხლები: 7 დამოუკიდებელი
30 დამოკიდებული
ფიგურა: 2

ბანყოფილება C

C 10

- (10) AP 2023 15988 A (51) Int. Cl. (2006)
C 10 L 1/18
C 10 L 1/00
G 01 N 33/28
- (21) AP 2020 15988 (22) 2020 11 26
(31) 19213176.1
(32) 2019 12 03
(33) EP
- (71) სიკვა ჰოლდინგ სს (CH)
ავ. დე ფლორისა 41, 1008 პრილი, შვეიცარია (CH)
- (72) მარტინ ციულკე (DE);
დანიელ რიბე (DE);
ტორალფ ბაიცი (DE);
თომას თაილერი (CH);
ჰუან ლოპეზ გეიო (CH);
იუნიგი ლასკი (CH)
- (74) ლილიანა დარახველიძე
(85) 2022 06 24
(86) PCT/EP2020/083471, 2020 11 26
(54) ნაპოობის ნახშირწყალბადის მარკირების მეთოდი
- (57) ნავთობის ნახშირწყალბადის კომპოზიცია, რომელიც შეიცავს: ნავთობის ნახშირწყალბადს და, სულ მცირე, ერთ ქიმიურ მარკერს ზოგადი ფორმულით (I),

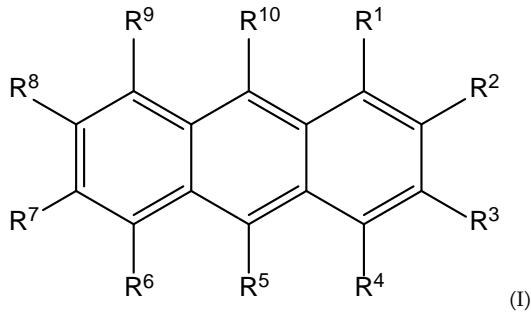

სიმრავლისაგან, სადაც თითოეული ფირფიტა შესრულებულია სპირალური ფორმის ლენტის ხვიის სეგმენტის სახით.
 მუხლები: 1 დამოუკიდებელი
 2 დამოკიდებული
 ფიგურა: 4

რომლის R¹, R², R³, R⁴, R⁵, R⁶, R⁷, R⁸, R⁹ ჩამონაცვლებლების მნიშვნელობები მოყვანილია გამოგონების ფორმულაში, ერთგვაროვნად შერეულს ნავთობის ნახშირწყალბადთან და ნავთობის ნახშირწყალბადის მარკირების ხერხი.
 მუხლები: 2 დამოუკიდებელი
 12 დამოკიდებული
 ფიგურა: 7

ბანყოფილება H

H 04

(10) AP 2023 15894 A (51) Int. Cl. (2006)
 H 04 R 9/06

(21) AP 2022 15894 (22) 2022 03 04

(71) ვასილ პეტრიაშვილი (GE)
 ნუცუბიძის ფერდობი, III მ/რ, III კვარტ.,
 კორპ. 8, ბ. 1, 0183, თბილისი,
 საქართველო (GE);
 ვაჟა ეზუგბაია (GE)
 გლდანის V მ/რ, კორპ. 18, ბ. 87, 0107,
 თბილისი, საქართველო (GE);
 ირაკლი პეტრიაშვილი (GE)
 ნუცუბიძის ფერდობი, III მ/რ, III კვარტ.,
 კორპ. 8, ბ. 1, 0183, თბილისი,
 საქართველო (GE)

(72) ვასილ პეტრიაშვილი (GE);
 ვაჟა ეზუგბაია (GE);
 ირაკლი პეტრიაშვილი (GE)

(74) ნიკოლოზ გოგილიძე

(54) ელექტროაკუსტიკური ბარღამქმნელი

(57) გამოგონებით შემოთავაზებულია ელექტროაკუსტიკური გარდამქმნელი, რომელიც შეიცავს ერთმანეთისაგან დაცილებული დისკების წყვილს, რომელთა კიდებთან დაკავშირებულია ცილინდრული, ან კონუსური ზედაპირის მქონე ღრუ კონსტრუქცია, რომელიც შედგება ერთმანეთის მიმდებარედ განლაგებული ფირფიტების

ბამოგონების კატეგორია

ბანყოფილება A

A 21

- (11) P 2023 7523 B (51) Int. Cl. (2006)
A 21 D 13/11
A 21 D 13/41
A 21 D 13/13
- (10) AP 2023 15661 A (44) 7(610)/2023
(21) AP 2019 15661
(22) 2019 11 27
(24) 2019 11 27
(31) 62/773,843
(32) 2018 11 30
(33) US
(86) PCT/IB2019/001274, 2019 11 27
- (73) იაე ლლს (US)
2 ალჰამბრა პლაზა პენტჰაუსი 1ბ, კორალ
გეიბელს, ფლორიდა 33134, აშშ (US)
- (72) ფერნანდო, ბენჟამინ ფიშმან (US)
- (74) შალვა გვარამაძე
- (54) პიციის პროდუქტის და პიციის პროდუქტის მომზადების ხერხი და დისტრიბუცია

A 61

- (11) P 2023 7522 B (51) Int. Cl. (2006)
A 61 K 31/4439
A 61 K 31/538
A 61 K 31/506
A 61 K 31/498
A 61 P 31/04
C 07 D 401/04
C 07 D 401/14
C 07 D 403/14
C 07 D 413/14
- (10) AP 2023 15801 A (44) 6(609)/2023
(21) AP 2018 15801
(22) 2018 11 02
(24) 2018 11 02
(62) AP 2018 15681 2018 11 02
(31) 1718285.8
(32) 2017 11 03
(33) GB
(86) PCT/GB2018/053183, 2018 11 02

- (73) დისკუვა ელ ტე დე (GB)
136A ისტერნ ავენიუ მილტონ პარკი,
აბინგდონი ოქსფორდშირი, OX14 4SB,
დიდი ბრიტანეთი (GB)
- (72) პოლ მეო (GB);
მოხამედ ნავაზ კხან (GB);
სედრიკ შარიე (GB)
- (74) თამარ კოჭლამაზაშვილი
(54) ანტიბაქტერიული ნამრთი

- (11) P 2023 7528 B (51) Int. Cl. (2006)
A 61 K 39/395
A 61 P 37/06
A 61 P 29/00
A 61 P 35/00
- (10) AP 2023 15361 A (44) 8(611)/2023
(21) AP 2017 15361
(22) 2017 09 20
(24) 2017 09 20
(62) AP 2017 15050 2017 09 20
(31) 62/515,480; 62/397,752
(32) 2017 06 05; 2016 09 21
(33) US; US
(86) PCT/US2017/052592, 2017 09 20
- (73) ეილექს ონკოლოჯი ინკ. (US)
323 ალერტონ ავენიუ, საუთ სან-
ფრანცისკო, კალიფორნია, 94080, აშშ (US)
- (72) სტივენ ელიოტ კუდერ (US);
ტრეისი ჩია-ჩიენ კო (US);
შელი ისკიერდო (US);
ჰუნ ვან (US);
უილიამ დონ ჰარიმენ (US);
ბანგ ჯანეტ სიმ (US);
ჰაუმე პონზ (US)
- (74) თამარ კოჭლამაზაშვილი
(54) სიბნალ-რეპლატორული ცილა ალფას
საწინააღმდეგო ანტიბიოტიკები და მათი
ბამოყენება

- (11) P 2023 7524 B (51) Int. Cl. (2006)
A 61 K 45/06
A 61 K 31/496
A 61 K 31/195
A 61 P 25/04
A 61 P 25/02
- (10) AP 2023 15820 A (44) 5(608)/2023
(21) AP 2020 15820

- (22) 2020 05 06
- (24) 2020 05 06
- (31) 102019000006602
- (32) 2019 05 07
- (33) IT
- (86) PCT/IB2020/054275, 2020 05 06
- (73) აზიენდე ქიმიჩე რიუნიტე ანჯელინი
ფრანჩესკო ა.ც.რ.ა.ფ. ს.პ.ა (IT)
ვიალე ამელია 70, I-00181 რომი, იტალია (IT)
- (72) ლორენცო პოლენზანი (IT);
ფაბრიციო კალისტი (IT);
პოლა ლიპონე (IT);
სერენა ტონჯანი (IT)
- (74) ლილიანა დარახველიძე
- (54) ტრასოლონის შემცველი ფარმაცევ-
ტული კომპოზიცია ნეიროპათიური
ტკივილის სამკურნალოდ

-
- (11) P 2023 7527 B (51) Int. Cl. (2006)
A 61 K 31/472
A 61 P 25/08
 - (10) AP 2023 15508 A (44) 8(611)/2023
 - (21) AP 2019 15508
 - (22) 2019 05 10
 - (24) 2019 05 10
 - (31) 62/670,253
 - (32) 2018 05 11
 - (33) US
 - (86) PCT/US2019/031872, 2019 05 10
 - (73) ქსენონ ფარმასიუტიკალს ინკ. (CA)
200-3650 გილმორ ვეი, ბარნები,
ბრიტანული კოლუმბია, V5G 4W8,
კანადა (CA)
 - (72) გრეგორი ნ. ბეტჩი (CA)
 - (74) თამარ კოჭლამაზაშვილი
 - (54) კალიუმის არხის კოტენციალდამო-
კიდებული გამსხნელის ბიომისა-
წვდომობის და ჯემოქმედების
ბაზრდის მქოლოდი
-

ბანყოფილება B

B 22

- (11) P 2023 7525 B (51) Int. Cl. (2006)
B 22 F 3/23
C 22 B 5/04
C 22 C 33/00
- (10) AP 2023 15606 A (44) 6(609)/2023
- (21) AP 2021 15606
- (22) 2021 04 15
- (24) 2021 04 15
- (73) გარეგინ ზახაროვი (GE)
ერწოს ქ. 11, ბ. 9, 0192, თბილისი,
საქართველო (GE);
ზურაბი ასლამაზაშვილი (GE)
დ. თავხელიძის ქ. 1, ბ. 58, 0186, თბილისი,
საქართველო (GE);
დავით კვასხვაძე (GE)
II შესახვევი ნა, სოფელი ციხისძირი,
ქობულეთი, საქართველო (GE);
გიორგი მიქაბერიძე (GE)
გამსახურდიას გამზ. 14, ბ. 34, 0171,
თბილისი, საქართველო (GE);
მიხეილ ჩიხრაძე (GE)
ალ. ყაზბეგის გამზ. 24გ, ბ. 130, 0186,
თბილისი, საქართველო (GE);
თამაზ ბაციკაძე (GE)
ნუცუბიძის ქ. 179, კორპ. 2, ბ. 16, 0186,
თბილისი, საქართველო (GE);
ლევან ანთაშვილი (GE)
ტაშკენტის ქ. 7, 5, 3700, რუსთავი,
საქართველო (GE);
დავითი შონია (GE)
ბათუმის ქ. 14, ბ. 19, რუსთავი, საქარ-
თველო (GE);
ირაკლი მაისურაძე (GE)
თამარ მეფის გამზ. 17, თბილისი, საქარ-
თველო (GE);
აკაკი ფეიქრიშვილი (GE)
ქიული შარტავას ქ. 16, ბ. 32, 0160,
თბილისი, საქართველო (GE);
გულნარა ურუშაძე (GE)
პეტრე ქავთარაძის ქ. 43, ბ. 18, 0186,
თბილისი, საქართველო (GE);
რამინ აბესაძე (GE)
სოფ. ღვითორი, 5518, ჭიათურა,
საქართველო (GE)
- (72) გარეგინ ზახაროვი (GE);
ზურაბი ასლამაზაშვილი (GE);
დავით კვასხვაძე (GE);

გიორგი მიქაბერიძე (GE);
მიხეილ ჩიხრაძე (GE);
თამაზ ბაციკაძე (GE);
ლევან ანთაშვილი (GE);
დავითი შონია (GE);
ირაკლი მაისურაძე (GE);
აკაკი ფეიქრიშვილი (GE);
გულნარა ურუშაძე (GE);
რამინ აბესაძე (GE)
(54) ფერობროის მიღების ხერხი

ბანყოფილება G

G 01

(11) P 2023 7526 B (51) Int. Cl. (2006)
G 01 N 21/00
(10) AP 2023 15740 A (44) 4(607)/2023
(21) AP 2021 15740
(22) 2021 09 23
(24) 2021 09 23
(73) სსიპ „შოთა რუსთაველის ეროვნული
სამეცნიერო ფონდი“ (GE)
მერაბ ალექსიძის II შესახვევი 2, 0193,
თბილისი, საქართველო (GE);
ალექსანდრე რჩელიშვილი (GE)
ნუცუბიძის II მ/რ, III კვარტ., კორპ. 3, ბ. 21,
0183, თბილისი, საქართველო (GE);
სსიპ „ივანე ჯავახიშვილის სახ. თბილისის
სახელმწიფო უნივერსიტეტი“ (GE)
ილია ჭავჭავაძის გამზ. 1, 0179, თბილისი,
საქართველო (GE)
(72) ალექსანდრე რჩელიშვილი (GE)
(54) ატომიზაციის ხარისხის მართვის
მეთოდი და მოწყობილობა მის
ბანსახორციელებლად

დიზაინები

ბანაცხადი, რომელზეც გამოტანილია გადაწყვეტილება რეგისტრაციის შესახებ

გადაწყვეტილების გასაჩივრება შესაძლებელია საქპატენტის სააპელაციო პალატაში გამოქვეყნებიდან 3 თვის ვადაში ან მცხეთის რაიონული სასამართლოს ადმინისტრაციულ საქმეთა კოლეგიაში 1 თვის ვადაში (მის.: ქ. მცხეთა, სამხედროს ქ. №17).

(10) AD 2023 1304 S (51) 14-06

(21) AD 2023 1304

(22) 2023 04 11

(28) 4

(71) დავით ხამაშურიძე (GE)

გივი კარტოზიას ქ. 8, კორპ. 1, ბ. 1, 0177, თბილისი, საქართველო (GE)

(72) დავით ხამაშურიძე (GE)

(74) შალვა გვარამაძე (GE)

(54) 1.-3. ბასაშელი საღბაში მობილური ტელეფონი;

4. ბასაშელი საღბაში მობილური ტელეფონისათვის

(55)

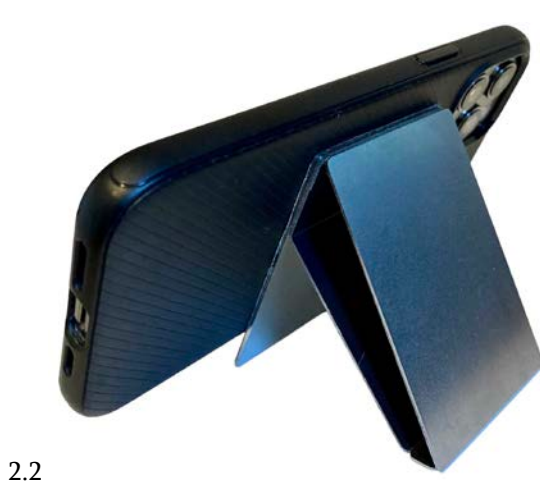

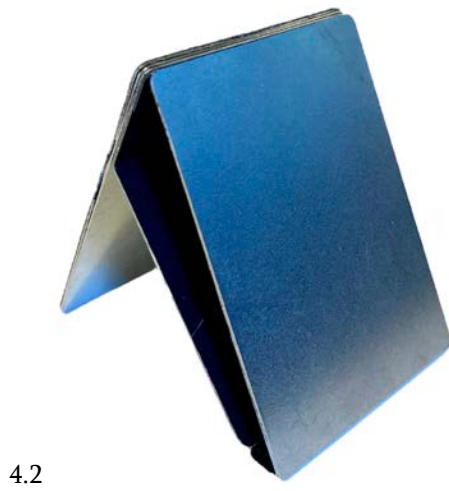

დაჩქარებული პროცედურით რეგისტრირებული ღიზაინი

რეგისტრაციის გაუქმების მოთხოვნით საჩივრის შეტანა შესაძლებელია საქპატენტის სააპელაციო პალატაში გამოქვეყნებიდან 3 თვის ვადაში.

(11) D 2023 975 S (51) 26-05

(21) AD 2023 1314 (22) 2023 06 14

(24) 2023 06 14

(28) 1

(18) 2028 06 14

(73) ნია მგალობლიშვილი (GE)

ილია ჭავჭავაძის გამზ. 51, 0179, თბილისი, საქართველო (GE);

შპს „დიზაინბიურო“ (GE)

დანიელ ჭონქაძის ქ. 12, 0180, თბილისი, საქართველო (GE)

(72) ნია მგალობლიშვილი (GE)

(54) წრიული სანათი

(55)



1.1

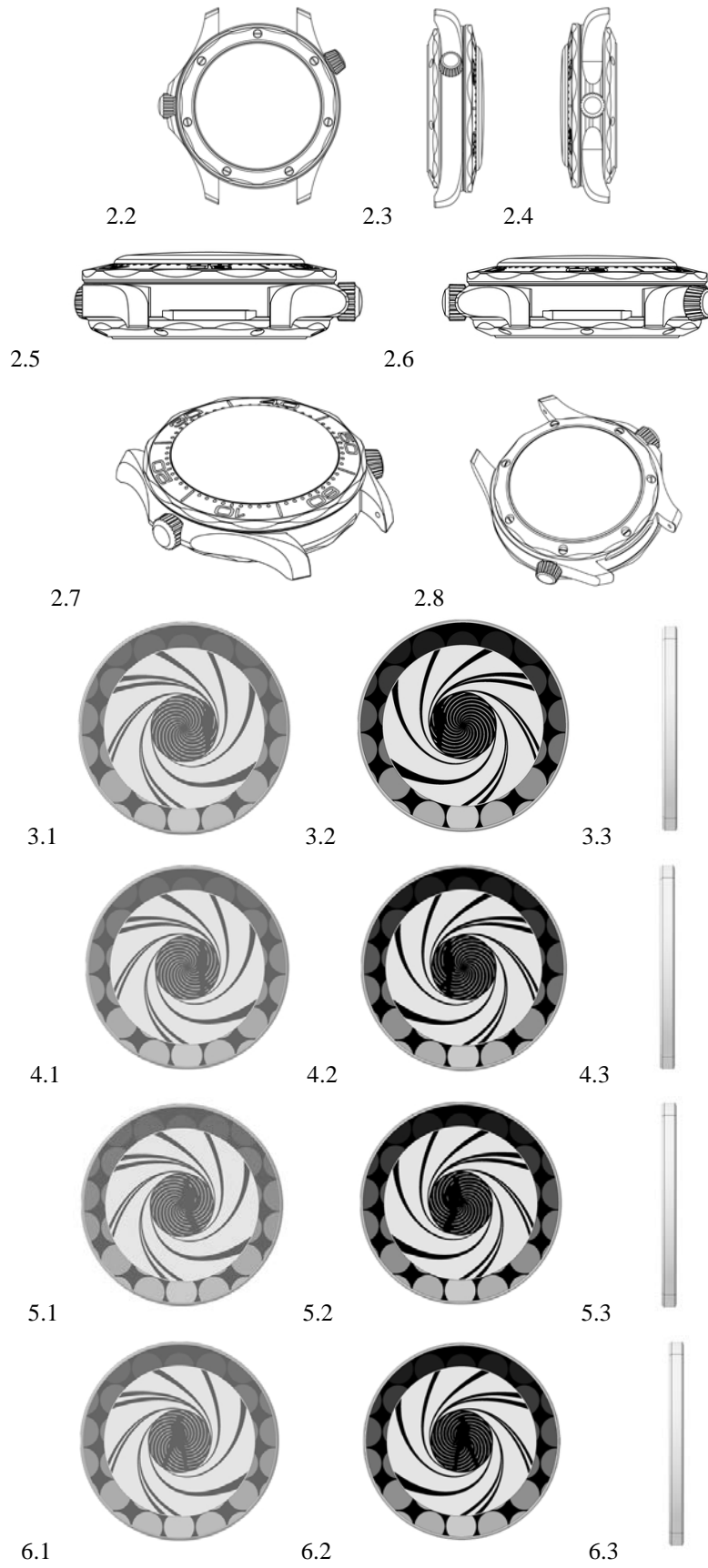

- (11) DM/222 984 (51) 10-07
- (15) 2022 08 16 (44) 20/2023 (2023 05 19)
- (22) 2022 08 16
- (28) 4
- (73) Compagnie des Montres Longines, Francillon S.A. (Longines Watch Co. Francillon Ltd.)
Les Longines 8, 2610 St-Imier (CH)
- (85) CH
- (86) CH
- (87) CH
- (88) CH
- (89) CH
- (81) III. KG, LI, GE, MK, TR, CA, OM, BA, MN, NO, CH, EM, AL, UA, AM, SG, MA, MC, MD, BZ, ME,
AZ, TN, GB
- (72) Gaïane DEMUR
c/o Compagnie des Montres Longines, Francillon S.A., Les Longines 8, 2610, Saint-Imier (CH)
- (74) The Swatch Group AG (The Swatch Group SA) (The Swatch Group Ltd.)
Faubourg du Lac 6, 2501 Biel/Bienne (CH)
- (46) 2023 05 19
- (54) 1.-4. WATCH DIAL
- (55)

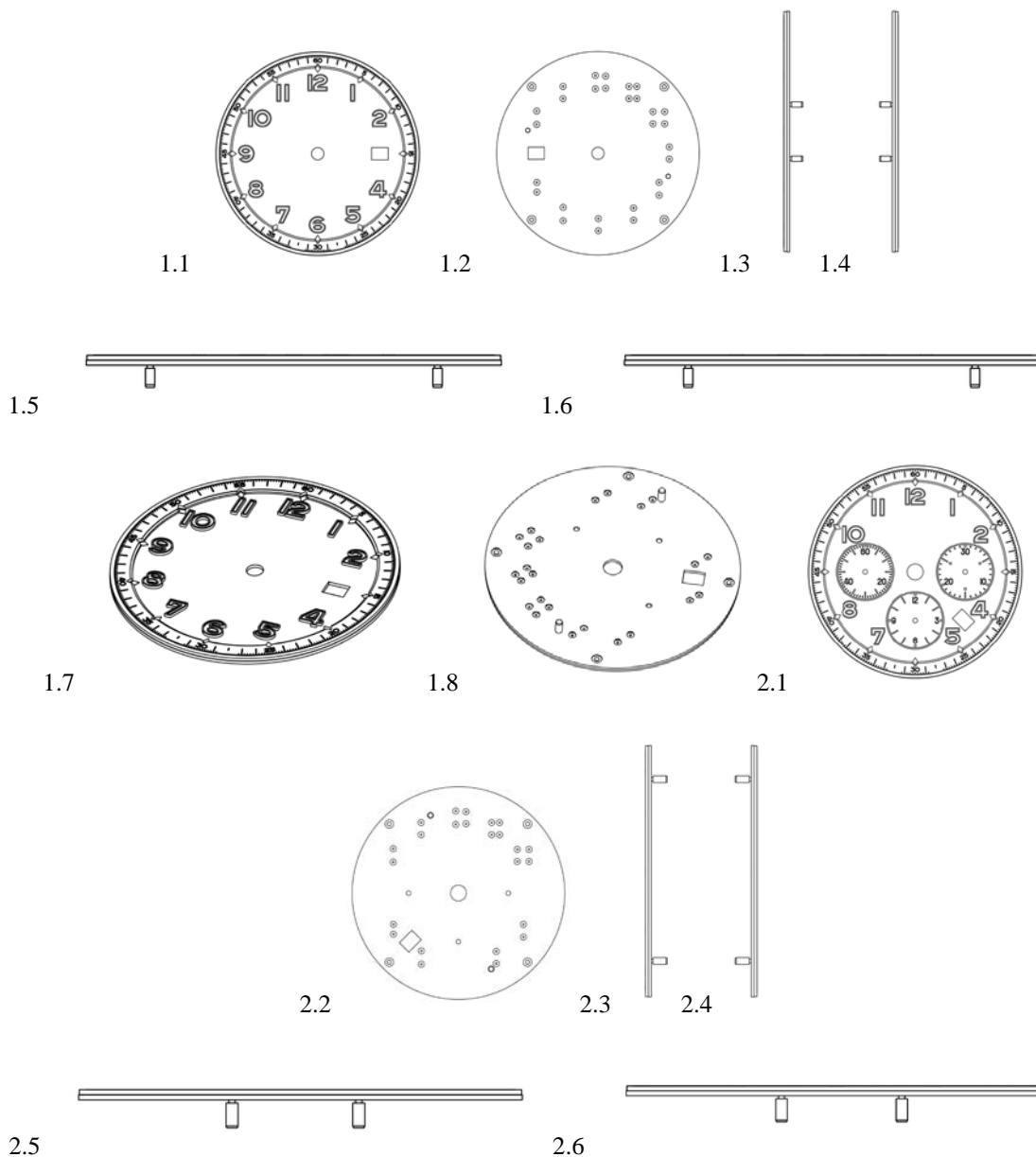



2.7

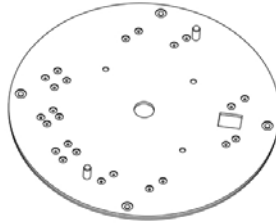

2.8

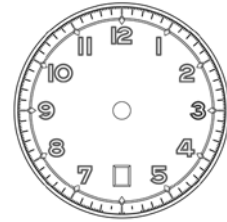

3.1

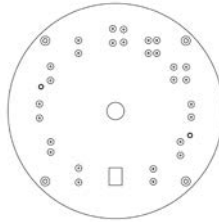

3.2

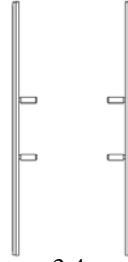

3.3

3.4



3.5



3.6

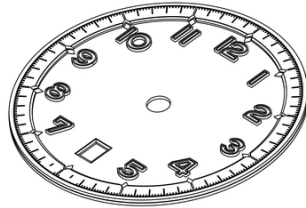

3.7

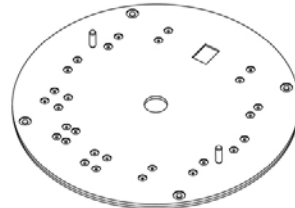

3.8



4.1

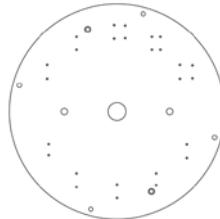

4.2

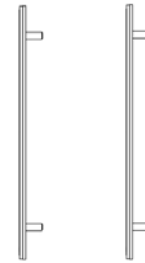

4.3

4.4



4.5



4.6



4.7

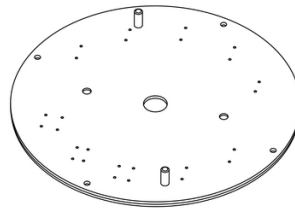

4.8

- (11) DM/227 519 (51) 02-07
 (15) 2022 11 21 (44) 21/2023 (2023 05 26)
 (22) 2022 11 21
 (28) 1
 (73) Omega SA (Omega AG) (Omega LTD.)
 Jakob-Stämpfli-Strasse 96, 2502 Biel/Bienne (CH)
 (85) CH
 (86) CH
 (87) CH
 (88) CH
 (89) CH
 (81) III. KG, LI, MK, TR, OM, GE, BA, MN, NO, RU, CH, EM, AL, AM, UA, MA, SG, MC, MD, BZ, ME,
 AZ, TN, GB
 (72) Gregory Kissling
 c/o Omega SA (Omega AG) (Omega LTD.) Jakob-Stämpfli-Strasse 96, 2502, Biel/Bienne (CH)
 (74) The Swatch Group AG (The Swatch Group SA) (The Swatch Group Ltd.)
 6, Faubourg du Lac, 2501 BIEL/BIENNE (CH)
 (46) 2023 05 26
 (54) 1. CUFFLINK
 (55)

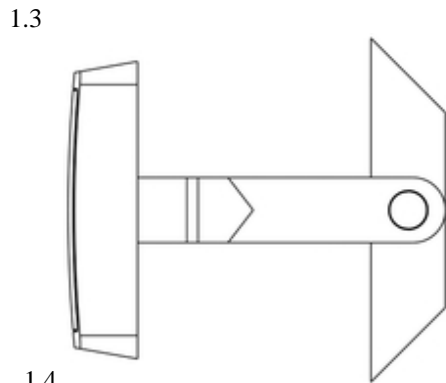
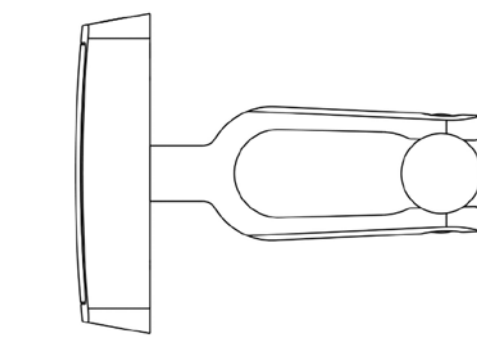
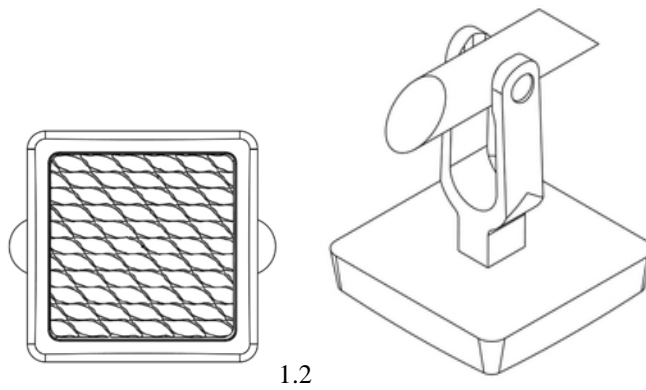

- (11) DM/225 201
- (15) 2022 11 21
- (22) 2022 11 21
- (28) 3
- (73) Harry Winston SA
Chemin Du Tourbillon 8, 1228 Plan-les-Ouates (CH)
- (85) CH
- (86) CH
- (87) CH
- (88) CH
- (89) CH
- (81) III. KG, LI, CA, TR, MK, GE, OM, BA, NO, MN, CH, EM, AL, UA, AM, MA, SG, MC, MD, ME, BZ, AZ, TN, GB
- (72) Tobias WUEST
C/o Harry Winston Inc., 718 Fifth Avenue, 10019, New York (US)
- (74) The Swatch Group AG (The Swatch Group SA) (The Swatch Group Ltd.)
Faubourg Du Lac 6, 2501 Biel/Bienne (CH)
- (46) 2023 05 26
- (54) 1. FINGER RING, 2. NECKLACE, 3. PAIR OF EARRINGS
- (55)



1.1



1.2



1.3



1.4



1.5



1.6



1.7



1.8

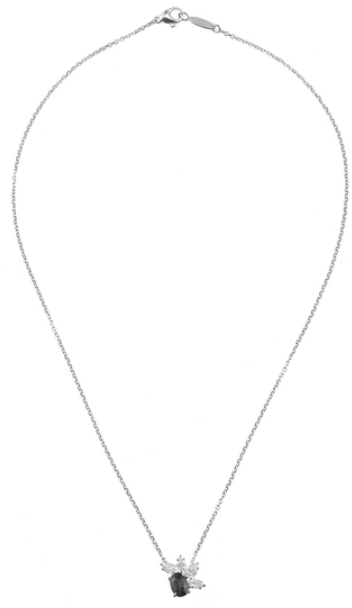

2.1

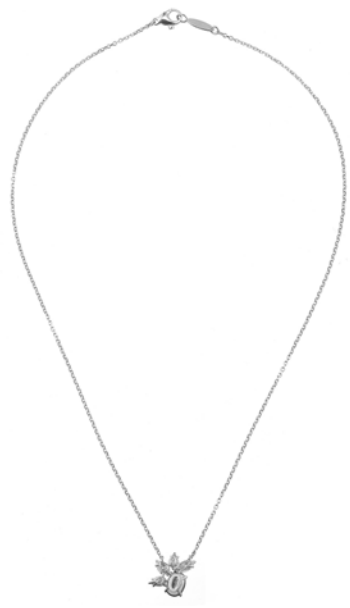

2.2



2.3



2.4



2.5



2.6



2.7



2.8



2.9



3.1



3.2



3.3





- (11) DM/225 802 (51) 11-01
 (15) 2022 12 08 (44) 23/2023 (2023 06 09)
 (22) 2022 12 08
 (28) 1
 (73) Harry Winston SA
 Chemin Du Tourbillon 8, 1228 Plan-les-Ouates (CH)
 (85) CH
 (86) CH
 (87) CH
 (88) CH
 (89) CH
 (81) III. KG, LI, GE, MK, CA, OM, BA, NO, RU, EM, AM, MD, TN, GB, TR, MN, CH, AL, UA, MA, SG,
 MC, ME, BZ, AZ
 (72) Delphine ABDOURAHIM
 C/o Harry Winston Inc. 718 Fifth Avenue, 10019, New York (US)
 (74) The Swatch Group AG (The Swatch Group SA) (The Swatch Group Ltd.)
 Faubourg Du Lac 6, 2501 Biel/Bienne (CH)
 (46) 2023 06 09
 (54) 1. FINGER RING
 (55)



- (11) DM/229 665 (51) 06-02
- (15) 2023 04 10 (44) 25/2023 (2023 06 23)
- (22) 2023 04 10
- (28) 1
- (30) №1: 17.01.2023; 2023500132; RU
- (73) Boris Fedorovich Arabadzhi
Ul. Nagornayz 8, Kv. 285, 108843 Troitsk, Moscow Region (RU)
- (85) –
- (86) RU
- (87) RU
- (88) –
- (89) RU
- (81) III. LI, RO, MK, US, GE, BA, EE, NO, DE, RS, EG, FI, BG, SY, DK, IS, AM, HU, ES, TJ, BY, VN, TN, GB, PL, KH, TR, CH, LT, LV, HR, CN, MX, BN, FR, MA, SG, MC, BX, SI, ME, AZ, SM
- (72) Boris Fedorovich Arabadzhi
Ul. Nagornayz 8, Kv. 285, 108843 Troitsk, Moscow Region (RU)
- (74) Galina Gavrilova
P/o Box 9004, 249039 Obninsk, Kaluga Region (RU)
- (46) 2023 06 23
- (54) 1. BABY CRIB
- (55)



1.1



1.2



1.3



1.4

- (11) DM/226 125
- (15) 2022 12 23
- (22) 2022 12 23
- (28) 1
- (73) Omega SA (Omega AG) (Omega LTD.)
Jakob-Stämpfli-Strasse 96, 2502 Biel/Bienne (CH)
- (85) CH
- (86) CH
- (87) CH
- (88) CH
- (89) CH
- (81) III. KG, LI, TR, MK, OM, GE, BA, MN, NO, RU, CH, EM, AL, AM, UA, MA, SG, MC, MD, BZ, ME, AZ, TN, GB
- (72) Gregory Kissling
c/o Omega SA (Omega AG) (Omega LTD.), Jakob-Stämpfli-Strasse 96, 2502, BIEL/BIENNE (CH)
- (74) The Swatch Group AG (The Swatch Group SA) (The Swatch Group Ltd.)
6, Faubourg Du Lac, 2501 Biel/Bienne (CH)
- (46) 2023 06 23
- (54) 1. WATCH
- (55)



1.1

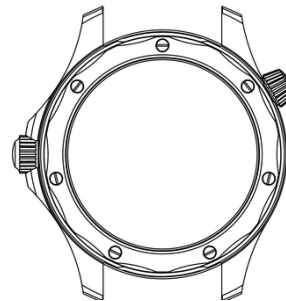

1.2

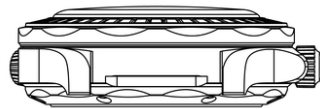

1.3

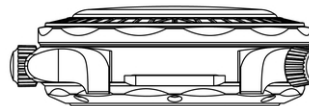

1.4

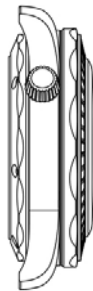

1.5

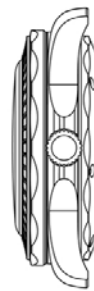

1.6



1.7

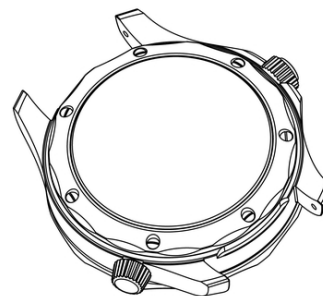

1.8

სასაქონლო ნიშნები

ეროვნული პროცედურით შემოტანილი ბანაცხავები, რომლებზეც ბამოტანილია გადაწყვეტილება რეგისტრაციის შესახებ

გადაწყვეტილების გასაჩივრება შესაძლებელია საქპატენტის სააპელაციო პალატაში გამოქვეყნებიდან 3 თვის ვადაში ან მცხეთის რაიონული სასამართლოს ადმინისტრაციულ საქმეთა კოლეგიაში 1 თვის ვადაში (მის.: ქ. მცხეთა, სამხედროს ქ. №17).

(260) AM 2023 110203 A*

(210) AM 110203

(220) 2020 10 19

(731) ინერ მონგოლია ილი ინდუსტრიალ

გრუპ კო., ლტდ

N1 ჯინშან როუდ, ჯინშან დეველოპმენტ

ზოუნ, ჰოპოტ, ჩინეთის სახალხო

რესპუბლიკა

(740) გიორგი ბათლიძე

(540)



(591) შავ-თეთრი

(531) 26.01.22; 26.02.08; 26.11.12

(511)

30 – ყავის სასმელები; შოკოლადის სასმელები რძით; ყავა. კაკაო (გამომცხვარი, დაფხვნილი, გრანულირებული თუ სასმელად გამოყენებული); შოკოლადის სასმელები; ჩაი; ჩაის შემცველი სასმელები; შაქარი; კანფეტი; რძის ფილები (კანფეტი); თაფლი; ყვითელი სიროფი; ნამცხვრები. პური; საკონდიტრო ნაწარმი; შვრიის ფანტელები; მომენტალურად მოსამზადებელი ბრინჯი; მარცვლეული; სოიოს ფქვილი; ბრინჯი; საგო; ხორბლის ფქვილი; მომენტალურად მოსამზადებელი ატრია; ბრინჯის ატრია; მარცვლეულის შემცველი წასახემსები; ბრინჯის შემცველი წასახემსები; საკვები მარცვლეული; ნაყინი; საჭმელი ყინული; ყინულის შაქარი; მარილი; ძმარი; სოიოს სოუსი; სუნელები; მდოგვი; თევზის სოუსი; საფუარი; ფერმენტები. არომატული სურსათის პროდუქტები; სურსათის ესენციები გარდა ეთერული ესენციების და ეთერზეთებისა; ათქვეფილი კრების გამამლიერებელი დანამატები; ხორცის დამარბილებელი საყოფაცხოვრებო მიზნებისათვის; გლუტენის შემცველი საკვები პროდუქტები; ბრინჯის ატრია (ფხვნილი); ნაყინის ფხვნილი;

32 – ბრინჯის შემცველი სასმელები, გარდა რძის ჩამნაცვლებლებისა; სპორტული სასმელები; ენერგეტიკული სასმელები; უალკოჰოლო გაზიანი სასმელები; უალკოჰოლო ხილის წვენი; შვრიის სასმელი; წყალი (სასმელი); ლითიას წყალი; მინერალური წყალი (სასმელები); გაზიანი წყალი; მაგიდის წყალი; ლიმონათი; სოდა წყალი; უალკოჰოლო სასმელები; გაზიანი წყალი; იზოტონური სასმელები; ბურახი (უალკოჰოლო სასმელები); ნარევი; სოიოს შემცველი სასმელები, გარდა რძის შემცველი ნივთიერებებისა; ცილით მდიდარი სპორტული სასმელები; უალკოჰოლო სასმელები ყავის არომატით; უალკოჰოლო სასმელები ჩაის არომატით; მსუბუქი სასმელები; კოლა; ლაქტო-მჟავის შემცველი სასმელები (ხილის პროდუქტები, რძის გარეშე); რძის ჩაი (რძის შემცველობის გარეშე); გამოხდილი წყალი (სასმელი); სასმელი გამოხდილი წყალი; სუფთა წყალი (სასმელი); ბოსტნეულის სასმელი; ლედვის სასმელი; ფერმენტირებული სასმელი დამზადებული ლობიოსგან; სასმელების მომზადების საშუალებები; შერბეტი (ხილის ყინულითა და შაქრით დამზადებული სასმელები).

(260) AM 2023 110204 A*

(210) AM 110204

(220) 2020 10 19

(731) ინერ მონგოლია ილი ინდუსტრიალ გრუპ

კო. ელ თი დი

N1 ჯინშან როუდ, ჯინშან დეველოპმენტ

ზოუნ, ჰოპოტ, ჩინეთის სახალხო

რესპუბლიკა

(740) გიორგი ბათლიძე

(540)



(591) შავ-თეთრი

(531) 27.05.01; 27.05.17

(511)

30 – ყავის სასმელები; შოკოლადის სასმელები რძით; ყავა, კაკაო (გამომცხვარი, დაფხვნილი, გრანულირებული თუ სასმელად გამოყენებული); შოკოლადის სასმელები; ჩაი; ჩაის შემცველი სასმელები; შაქარი; კანფეტი; რძის ფილები (კანფეტი); თაფლი; ყვითელი სიროფი; ნამცხვრები პური; საკონდიტრო ნაწარმი; შვრიის ფანტელები; მომენტალურად მოსამზადებელი ბრინჯი; მარცვლეული; სოიოს ფქვილი; ბრინჯი; საგო; ხორბლის ფქვილი; მომენტალურად მოსამზადებელი ატრია; ბრინჯის ატრია; მარცვლეულის შემცველი წასახემსები; ბრინჯის შემცველი წასახემსები; საკვები მარცვლეული; ნაყინი; საჭმელი ყინული; ყინულის შაქარი; მარილი; ძმარი; სოიოს სოუსი; სუნელები; მდოგვი; თევზის სოუსი; საფუარი; ფერმენტები არომატული სურსათის პროდუქტები; სურსათის ესენციები გარდა ეთერული ესენციების და ეთერზეთებისა; ათქვეფილი კრების გამამლიერებელი დანამატები; ხორცის დამარბილებელი საყოფაცხოვრებო მიზნებისათვის; გლუტენის შემცველი საკვები პროდუქტები; ბრინჯის ატრია (ფხვნილი); ნაყინის ფხვნილი.

32 – ბრინჯის შემცველი სასმელები, გარდა რძის ჩამნაცვლებლებისა; სპორტული სასმელები; ენერგეტიკული სასმელები; უალკოჰოლო გაზიანი სასმელები; უალკოჰოლო ხილის წვენები; შვრიის სასმელი; წყალი (სასმელი); ლითიას წყალი; მინერალური წყალი (სასმელები); გაზიანი წყალი; მაგიდის წყალი; ლიმონათი; სოდა წყალი; უალკოჰოლო სასმელები; გაზიანი წყალი; იზოტონური სასმელები; ბურახი (უალკოჰოლო სასმელები); ნარევი; სოიოს შემცველი სასმელები, გარდა რძის შემცველი ნივთიერებებისა; ცილით მდიდარი სპორტული სასმელები; უალკოჰოლო სასმელები ყავის არომატით; უალკოჰოლო სასმელები ჩაის არომატით; მსუბუქი სასმელები; კოლა; ლაქტო-მჟავის შემცველი სასმელები (ხილის პროდუქტები, რძის გარეშე); რძის ჩაი (რძის შემცველობის გარეშე); გამოხდილი წყალი (სასმელები); სასმელი გამოხდილი წყალი; სუფთა წყალი (სასმელები); ბოსტნეულის სასმელი; ლედვის სასმელი; ფერმენტირებული სასმელი დამზადებული ლობიოსგან; სასმელების მომზადების საშუალებები; შერბეტი (ხილის ყინულითა და შაქრით დამზადებული სასმელები).

(260) AM 2023 114671 A*

(210) AM 114671

(220) 2021 09 17

(731) შპს „აქსიმპორტი“

პაოლო იაშვილის ქ. 10, ფ. 4, თბილისი, საქართველო

(740) გიორგი თაქთაქიშვილი

(540)



(591) იასამნისფერი, ოქროსფერი, თეთრი

(531) 26.04.02; 26.04.18; 27.05.01; 27.05.22;
27.05.24; 28.19; 29.01.13

(511)

14 – საიუველირო ნაწარმი; ბიჟუტერია; ყელსაბამები; საყურეები; სამაჯურები; ბეჭდები; ბროშები; საათები, მაჯის საათები, საათის ძეწკვები; ბრელოკები [ძვირფასეულობა]; ბროშები; ძეწკვები [ძვირფასეულობა]; ჰალსტუხის სამაგრები; მედალიონები (საიუველირო); დეკორატიული ქინძისთავები; ავგაროზები, თილისმები (საიუველირო); სტატუეტები კეთილშობილი ლითონებისაგან; კოლოფები კეთილშობილი ლითონებისაგან; მორთულობა კეთილშობილი ლითონებისაგან; მანჟეტის საკინძეები; ქინძისთავები [ძვირფასეულობა]; ნიშნები კეთილშობილი ლითონებისაგან; ძეწკვიანი ბრელოკები (სამშვენისები ან გასაღებზე დასამაგრებლები); ბრელოკები გასაღებებისათვის; ტიხრული მიწანაქარი; შესაკრავი/ზალთა საიუველირო ნაწარმისთვის; საიუველირო სამაგრები; საიუველირო ყუთები; სასაჩუქრე ყუთები საიუველირო ნაწარმისთვის.

35 – საცალო და საბითუმო ვაჭრობა საიუველირო ნაწარმით; საიუველირო საქონლის მაღაზიების მიერ გაწეული მომსახურება; საიუველირო საქონლით ონლაინ ვაჭრობა და ონლაინ მაღაზიის მიერ გაწეული მომსახურება.

(260) AM 2023 119787 A

(210) AM 119787

(220) 2022 10 11

(731) შპს „ლისი სპორტს“

სოფ. ქვემო ლისი, 0177, ვაკე-საბურთალოს რაიონი, თბილისი, საქართველო

(540)



(591) მწვანე, თეთრი, შავი

(531) 27.05.01; 27.05.21; 29.01.12

(511)

41 – განათლება; სასწავლო პროცესის უზრუნველყოფა; გართობა; სპორტული და კულტურული ღონისძიებები.

(260) AM 2023 119991 A

(210) AM 119991

(220) 2022 10 21

(731) სს „ზადაგონი“

სოფ. ზემო ხოდაშენი, 0910, ახმეტის რაიონი, საქართველო

(740) თამარ მაჭავარიანი

(540)



ALAVEIDI
RESORT

(591) შავი, ოქროსფერი, თეთრი

(531) 07.05.10; 26.11.12; 27.05.01; 27.05.10; 29.01.12

(526) ALAVERDI

(511)

43 – საკვებით და სასმელით უზრუნველყოფა; დროებითი საცხოვრებელი უზრუნველყოფა.

(260) AM 2023 119994 A

(210) AM 119994

(220) 2022 10 21

(731) შპს „კახური ტრადიციული მეღვინეობა“

სულხან ცინცაძის ქ. 12, მე-3 სართ. არასაცხოვრებელი ფართი 3-6, 0160, თბილისი, საქართველო

(540)

იმერეთი ვაინმეიქინგ

(591) შავ-თეთრი

(526) იმერეთი

(511)

35 – რეკლამა, ბიზნეს მენეჯმენტი, ბიზნესის ადმინისტრირება, საოფისე მომსახურება.

(260) AM 2023 120514 A

(210) AM 120514

(220) 2022 11 28

(731) ნათელა შეყლაშვილი

პაოლო იაშვილის ჩიხი 3, საჩხერე, საქართველო

(740) ვახტანგ ტოროტაძე

(540)

საქართველოს ბალები

(591) 000000 შავი, თეთრი

(526) საქართველო

(511)

21 – მინის, ბროლის, თიხის, კერამიკის, ფაიფურის, ლითონის, ქალაღდის, პლასტმასის ჭიქები, ბოთლები, ფლაკონები, ქილები და კაფსულები.

(260) AM 2023 120699 A

(210) AM 120699

(220) 2022 12 09

(731) რკ რჩეული მარანი

სოფ. ქვემო ხოდაშენი, თელავის რაიონი, საქართველო

(540)



(591) ნაცრისფერი, შავი

(531) 19.09.02; 27.05.01

(511)

33 – ალკოჰოლური სასმელები, ლუდის გარდა; ალკოჰოლური შედგენილობები სასმელების დასამზადებლად.

(260) AM 2023 120701 A

(210) AM 120701

(220) 2022 12 09

(731) შპს „ჯი თი სი ჯგუფი“

ექვთიმე ხელაძის ქ. 33, 0131, თბილისი, საქართველო

(740) ვახტანგ ტოროტაძე

(540)



(591) D0AD68 ოქროსფერი, 063A53 მუქი ლურჯი, 000000 შავი
(531) 27.05.01; 27.05.10; 27.05.21; 29.01.13
(511)

36 – სამშენებლო ბიზნესთან დაკავშირებული დაზღვევა, ფინანსური საქმიანობა და ფულად-საკრედიტო ოპერაციები; უძრავ ქონებასთან დაკავშირებული ოპერაციები.

37 – მშენებლობა; რემონტი; დანადგარების დაყენება.

(260) AM 2023 120707 A

(210) AM 120707

(220) 2022 12 12

(731) შპს „ალფა ფუდ“

აგლამის ქ. 32, 0119, თბილისი, საქართველო

(540)

miad
მიად
миад

(591) შავ-თეთრი

(511)

30 – ყავა, ჩაი, კაკაო და ყავის შემცველები; ბრინჯი, მაკარონი და ატრია; ტაპიოკა და საგო; ფქვილი და მარცვლეულის პროდუქტი; პურ-ფუნთუშეული, მაკარონი და საკონდიტრო ნაწარმი; შოკოლადი; ნაყინი, შარბათი და სხვა საკვები ყინული; შაქარი, თაფლი, ბადაგი; საფუარი, საცხობი ფხვნილები; მარილი, სანელებლები, საკმაზები, დაკონსერვებული მწვანილი; ძმარი, საწებლები და სხვა საკმაზი; ყინული (გაყინული წყალი).

(260) AM 2023 120711 A

(210) AM 120711

(220) 2022 12 12

(731) თამარ აბულაძე

ლ. ალექსიძის ქ. 4, ბ. 79გ, 0186, თბილისი, საქართველო

(540)



#გაქაყნაემოცია

(591) თეთრი, შავი, ნარინჯისფერი

(531) 01.01.12; 01.01.13; 01.03.13; 27.05.01; 28.19; 29.01.12

(511)

14 – კეთილშობილი ლითონები და მათი შენადნობები; საიუველირო ნაწარმი, ძვირფასი და ნახევრადძვირფასი ქვები; საათები და ქრონომეტრული ინსტრუმენტები.

35 – რეკლამა; ბიზნესის მართვა; ბიზნესის ადმინისტრირება; საოფისე მომსახურება.

43 – საკვებით და სასმელით უზრუნველყოფა; დროებითი საცხოვრებელი უზრუნველყოფა.

(260) AM 2023 120815 A

(210) AM 120815

(220) 2022 12 16

(731) ბკაირატ ჯენერალ ტრეიდინგ (ლ.ლ.კ.)

ოფისი 2802, ვესტბერი ოფისისტაუერი – მარასი დრაივი – ბიზნეს ბეი, დუბაი, არაბთა გაერთიანებული საამიროები

(740) თამაზ შილაკაძე

(540)

DON MAN

(591) შავ-თეთრი

(511)

34 – სიგარეტები, სიგარები, თამბაქო და თამბაქოს შემცველები, ნედლი და დამუშავებული თამბაქო, სიგარის ყუთები, პორტსიგარები, სალექი თამბაქო, სიგარილოები, არომატიზებული და მელასის თამბაქო, მწვევლთა საკუთონო, სანთებლები, სიგარეტის ფილტრები, ასანთი

და ასანთის კოლოფები, ელექტრო სიგარეტები და პირიდან გამოსაორთქლებლები.

(260) AM 2023 120816 A

(210) AM 120816

(220) 2022 12 16

(731) შეზღუდული პასუხისმგებლობის

საზოგადოება „სპრიბი“

კესკლინას რაიონი, ტარტუს გზა 83-701,

ტალინი, 10115, ესტონეთი

(740) ნიკოლოზ ჩომახიძე;

მარიამ ლუბიანური

(540)

SPRIBE

(591) შავ-თეთრი

(511)

9 – კომპიუტერული პროგრამები, კომპიუტერული პროგრამები ჩაწერილი, პროგრამული უზრუნველყოფა, კომპიუტერული თამაშები, პროგრამები, კომპიუტერის პროგრამული უზრუნველყოფა, ჩაწერილი; კომპიუტერული სისტემის პროგრამული უზრუნველყოფის აპლიკაცია, ჩასატვირთი; კომპიუტერული პროგრამები, მათ შორის, ჩასატვირთი პროგრამული უზრუნველყოფა; კომპიუტერული თამაშების პროგრამული უზრუნველყოფა.

35 – რეკლამა, ბიზნესის მართვა, ბიზნესის ადმინისტრირება, საოფისე მომსახურება.

41 – ახარტული თამაშები, კაზინოთი მომსახურების უზრუნველყოფა, ონლაინ კაზინოთი მომსახურების უზრუნველყოფა, თამაშების ინტერაქტიული უზრუნველყოფა კომპიუტერულ ქსელში.

42 – კომპიუტერული პროგრამების შექმნა და განვითარება, კომპიუტერის პროგრამული უზრუნველყოფის დამუშავება, კომპიუტერის პროგრამულ უზრუნველყოფასთან დაკავშირებული კონსულტაციები, კომპიუტერის პროგრამული უზრუნველყოფის გაქირავება, ინსტალაცია, მოდერნიზაცია, ტექნიკური მომსახურება კომპიუტერული პროგრამების შედგენა, კომპიუტერული პროგრამების გამრავლება, კომპიუტერული საიტების განთავსება [ვებ-საიტები], კომპიუტერული სისტემების ანალიზი, კომპიუტერული სისტემების პროექტირება.

(260) AM 2023 120824 A

(210) AM 120824

(220) 2022 12 19

(731) შპს „მეზონ 49“

ილია ჭავჭავაძის გამზ. 49ე, თბილისი, საქართველო

(740) გიორგი თაქთაქიშვილი

(540)

Maison by Benoit Castel

(591) შავ-თეთრი

(511)

29 – ხორცი; თევზი; ფრინველი; ნანადირევი; საქონლის სტეიკი; თევზის სტეიკი; ღორის სტეიკები ხორცის ექსტრაქტები; დაკონსერვებული, გაყინული, გამხმარი და მოხარშული ან შემწვარი ხილი და ბოსტნეული; ყელეები, ხილფაფები, კომპოტები; კვერცხი; რძე, ყველი, კარაქი, იოგურტი და რძის სხვა ნაწარმი; საკვები ზეთები და ცხიმები; წყალმცენარეების ექსტრაქტები საკვებისთვის; ჟელატინი; ქაფშია, ქამსა, არაცოცხალი; არაქისის კარაქი; კარაქი; კაკაოს კარაქი საკვებისთვის; ქოქოსის კარაქი; ნაღების კრემი; კვერცხის ცილა; ერთგვარი ძეხვეული, ბევრი სისხლის შემცველი; ბულიონები; ბულიონი; ბულიონის მოსამზადებელი შედგენილობები; ხიზილალა; ხილის ჩირი; ძეხვეული; კარტოფილის ჩიფსები; კომბოსტოს მწნილი; ქოქოსის კაკალი, გამომშრალი; რაფსის ზეთი საკვებისთვის; ბულიონის კონცენტრატები; მურაბები; გაყინული ხილი; წვნიანები; ქიშმიში; კორნიშონი, დამმარული ნეკა კიტრი; ბოსტნეული, დაკონსერვებული; ბოსტნეული, თბურად დამუშავებული; ბოსტნეული, გამომშრალი; საკვები ზეთები; ნაღები [რძის ნაწარმი]; ყველი; მინანქრებული ხილი; გუფთა; კიბოსნაირები, არაცოცხალი; ფინიკი; რძე; კიბორჩხალა, არაცოცხალი; თევზის ფილე; დვრიტა [კვეთი]; ხილი, მოშუშული; ხილის ჟელეს სპრედები; ხილის რბილობი; ხორცი; თევზი, არაცოცხალი; ჟელე საკვებისთვის; ხორცის ჟელე; ნანადირევი; ჯანჯაფილის მურაბა; სოიას მარცვლები საკვებისთვის, დაკონსერვებული; ცხიმის შემცველი ნივთიერებები საკვები ცხიმის დასამზადებლად; ცხიმების ნარევი ბუტერბროდებისათვის; ქაშაყი, არაცოცხალი; ომარები, არაცოცხალი; სიმინდის ზეთი საკვებისთვის; ხამანწკები, არაცოცხალი; თევზის ჟელე, საკვები; ღორი; იოგურტი; ბოსტნეულის სუპები; ბოსტნეულის წვენი კულინარიისათვის; ხორცის ექსტრაქტები; კეფირი; კუმისი; სასმელები რძის დომინანტური შემცველობით; შრატი; რძის ნაწარმი; ლანგუსტები, არაცოცხალი; ბეკონი, შებოლილი ღორის ხორცი; ოსპი, დაკონსერვებული; მარგა-

რინი; ჯემი, კონფიტიური; ცხოველური ძვლის ტვინი, საკვები; მოლუსკები, არაცოცხალი; მიდიები, არაცოცხალი; პალმის ზეთი საკვებისთვის; კაკალი, გარჩეული; კვერცხი; კვერცხის ფხვნილი; ღვიძლის პაშტეტი; ხახვი, დაკონსერვებული; ზეთისხილი, დაკონსერვებული; ზეთითუნის ზეთი; ძვლის ცხიმი, საკვები; პექტინები კულინარიისთვის; პიკული; მუხუდო, დაკონსერვებული; სოსისი; დამარილებული ხორცი; წვნიანის მოსამზადებელი შედგენილობები; პომიდვრის პიურე; ბოსტნეულის სალათები; ღორის ქონი; ხილის სალათები; სარდინები, არაცოცხალი; ორაგული, არაცოცხალი; ცხოველური ცხიმები, საკვები; თინუსი, არაცოცხალი; პომიდვრის წვენი კულინარიისათვის; მზესუმზირის ზეთი; საქონლის შიგნეული, საკვები; ტრიუფელი [თირკმელა სოკო], დაკონსერვებული; შინაური ფრინველი, არაცოცხალი; ხილის ცედრა; ალგინატები კულინარიული მიზნებისთვის; ნუში, დანაყილი; არაქისი, დამუშავებული; სოკო, დაკონსერვებული; ქოქოსის ცხიმი; ქოქოსის ზეთი საკვებისთვის; პარკოსნები, დაკონსერვებული; ღვიძლი; თევზით დამზადებული საკვები პროდუქტები; ხილის ჩიფსები; მოლუსკები, არაცოცხალი; სპირტში შენახული ხილი; ყვავილის მტვერი, მომზადებული, როგორც საკვები; წვრილი კრევეტები, არაცოცხალი; თევზი, დაკონსერვებული; ხორცი, დაკონსერვებული; კრევეტები, არაცოცხალი; ლოკოკინის კვერცხები, საკვები; ტოფუ, სოიას ხაჭო; ათქეფილი ნაღები; ღორის ხორცი; ფრინველის ბუდეები, საკვები; თევზის კონსერვები; თევზის ფქვილი საკვებში გამოსაყენებლად; ხილის კონსერვები; ხილი, დაკონსერვებული; ხორცი, დაკონსერვებული; კარტოფილის მაჭკატები; დამარილებული თევზი; ტრეპანგები, არაცოცხალი; ბოსტნეულის კონსერვები; ბოსტნეული, დაკონსერვებული; სოსისი საფანელში; კარტოფილის ფანტელები; ვამლის პიურე; ჰუმუსი; საკვებად ვარგისი ზღვის წყალმცენარეები, დაკონსერვებული; ხილზე დამზადებული მსუბუქი საუმეულო; შედედებული რძე; კიძი; სოიას რძე; რძის კოქტეილები; დაკონსერვებული წიწაკა; მზესუმზირის მარცვალი, დამუშავებული; თევზის მუსი; ბოსტნეულის მუსი; თევზის ქვირითი, დამუშავებული; თესლეული, დამუშავებული; ალოე, მომზადებული ადამიანის მიერ მოსახმარად; დაკონსერვებული ნიორი; ცილოვანი რძე; რძის ფერმენტები კულინარიისთვის; კომპოტები; შესქელებული რძე; არაჟანი; ფერმენტირებული შედედებული რძე; პროსტოკვაშა [შემკვავებული რძე]; პომიდვრის პასტა; ყაბაყის

ხიზილალა; ბადრიჯნის ხიზილალა; არაქისის რძე კულინარიისთვის; ნუშის რძე კულინარიისთვის; არტიშოკი, დაკონსერვებული; დამუშავებული ხილის შედგენილობები; რძის ფხვნილი; იაკიტორი [ქათმის მწვადი შამფურზე]; დაშაქრული თხილი; არომატიზირებული თხილი; თხილი, დამუშავებული; კენკრა, დაკონსერვებული; გუაკამოლე [ავოკადოს პიურე პამიდვრითა და სანელებლებით]; ხახვის რგოლები; ფალაფელი; ლიმონის წვენი კულინარიული მიზნებისთვის; შვრიის რძე; ბოსტნეულზე დამზადებული კრემი; გაყინული-გამხმარი ბოსტნეული; ლიოფილიზებული ბოსტნეული; ტკბილი სიმინდი, დამუშავებული; თხილზე დამზადებული კრემები ბუტერბროდებისთვის; კარტოფილით დამზადებული გუნდები; სოსისი ჰოთ-დოგებისთვის; სიმინდის ზეთზე შემწვარი ჰოთ-დოგი; სოიას ზეთები საკვებისთვის; რძის შემცვლელი; ნუშის რძე; არაქისის რძე; ქოქოსის რძე; ქოქოსის რძე კულინარიული მიზნებისთვის; ქოქოსის რძეზე დამზადებული სასმელები; ბრინჯის რძე კულინარიული მიზნებისთვის; ნუშის რძეზე დამზადებული სასმელები; არაქისის რძეზე დამზადებული სასმელები; ძეხვის გარსები, ბუნებრივი ან ხელოვნური; თევზი [დამარილებული და გამომშრალი]; ხაჭოს ღვეხელები; დაპრესილი ხილის პასტა; სოიას კატლეტები; სოიას ხაჭოს ღვეხელები; შამფურზე შემწვარი მწვადი; დამუშავებული ბოსტნეული; დამუშავებული ხილი; ბოსტნეულის რაგუ, ზეთითუნის ზეთზე მომზადებული; იხვისგან დამზადებული კერძი, სხვადასხვა ინგრედიენტებით; ღორის ხორცის ძეხვეული; ერთგვარი ძეხვეული, უსისხლო; კასოლეტი [ფრინველის ხორცზე დამზადებული ერთგვარი კერძი]; კარტოფილის ბლინები; ერბოკვერცხი; ტოლმა; ხილზე დამზადებული კონცენტრატები მოსამზადებლად; ბოსტნეულზე დამზადებული კონცენტრატები მოსამზადებლად; ბოსტნეულზე დამზადებული პასტა; აგარ-აგარი კულინარიული მიზნებისთვის; მოლუსკები, არაცოცხალი; ხაჭო; რძეზე დამზადებული სასმელები; საჭმელად ვარგისი ყვავილები, დაკონსერვებული ჯანჯაფილი; ჯანჯაფილის მარინადი; კენკროვანი სუპი; კენკრაზე დამზადებული დესერტი.

30 – ყავა; ჩაი; კაკაო; ყავის შემცვლელი; ბრინჯი; მაკარონი; ატრია; ტაპიოკა და საგო; ფქვილი და მარცვლეულის პროდუქტი; პურ-ფუნთუშეული, მაკარონი და საკონდიტრო ნაწარმი; შოკოლადი; ნაყინი, მარბათი, და სხვა საკვები

ყინული; შაქარი, თაფლი, ბადაგი; საფუარი, საცხობი ფხვნილები; მარილი, სანელებლები, საკმაზები, დაკონსერვებული მწვანელი; ძმარი, საწებლები და სხვა საკმაზი; ყინული (გაყინული წყალი); ზღვის წყალმცენარეები [საკმაზი]; მაკარონი; ნუშის ცომი; ანისულის თესლი; ვარსკვლავისებური ანისულის თესლი [ბადიანი]; საშობაო ნაძვისხის მოსართავი საკონდიტრო ნაწარმი; ხაჭაპური; ლობიანი; ნაყენები, არამედიკამენტური; ყავის არომატიზატორები; არომატიზატორები საკვებისთვის; საკმაზები; პური საფუარის გარეშე [ხმიადი]; მარილი; საკვების დასაკონსერვებლად; ორცხობილები; ბისკვიტები; ალაოს ნამცხვარი; პიტნის კანფეტები; საკონდიტრო ნაწარმი, კანფეტები; კანფეტები; ვაფლი; ბრიოშები; კაკაო; ყავა; მოუხალავი ყავა; ყავის შემცვლელი, მცენარეული; ნამცხვრები; დარიჩინი [სანელებელი]; კაპარის სანელებელი; კარამელი [კანფეტი]; კარი [ცხარე საკმაზი]; მარცვლეულის ნაწარმი; საღებავი რეზინი; ვარდ-კაჭაჭა [ყავის შემცვლელი]; ჩაი; შოკოლადი; მარცპანი; მიხაკი [სანელებელი]; სანელებლები; ტკბილეული; შაქრის ტკბილეული; სიმინდის ფანტელები; სიმინდის ბურბუშელა; ბატიბუტი; ათქვეფილი ნაღების გასამყარებელი ნივთიერებები; ნაყინი; ბლინები; ესენციები საკვებისთვის, ეთერის ესენციებისა და ეთერზეთების გარდა; საჭმლის მოსამზადებელი მარილი; საკვების შემასქელებლები; ქურქუმა; ბუნებრივი დამატკობლები; სანელებლები; თაფლაკვრები; ზაჰარი; ფქვილი; მუხუდოს ფქვილი; სიმინდის ფქვილი; მდოგვის ფქვილი; ქერის ფქვილი; სოიას ფქვილი; ხორბლის ფქვილი; სახამებელი საკვებისთვის; ფერმენტები ცომისათვის; პომადა [საკონდიტრო ნაწარმი]; მცირე ულუფებად დაჭრილი სადესერტო ნამცხვარი; შაქარი; ნამცხვრის არომატიზატორები, ეთერზეთების გარდა; არომატიზატორები, ეთერზეთებისგან განსხვავებული, ტორტებისთვის; ნამცხვრის პუდრა; ნამცხვრის ცომი; დაფხვნილი ჯანჯაფილი; ნაყინის შემკვრელი ნივთიერებები; ყინული, ბუნებრივი ან ხელოვნური; ყინული გასაგრილებლად; გლუკოზა კულინარიისთვის; კვების პროდუქტის სახით დამზადებული წებოვანა; საკვები ბურღულეული; ძმარი; კეტჩუპი [საწებელა]; კაკაოს რძიანი სასმელები; ყავის რძიანი სასმელები; შოკოლადზე დამზადებული რძიანი სასმელები; საფუარი, ცომის ხაში; საფუარი; შემკვრელი ნივთიერებები ძებვულისთვის; მაკარონი; მაკარონის ნაწარმი; სიმინდი, დაფქული; სიმინდი, მოხალული; პური; მალტოზა (ალაოს შაქარი); შავი ბადაგი საკ-

ვებისთვის; ოქროსფერი ბადაგი; პიტნა საკონდიტრო ნაწარმისთვის; თაფლი; დაცხვილი ქერი; მდოგვი; ჯავზი; ატრია; ღვეხელები; დაღერდილი ქერი; სენდვიჩები; დრაჟები [საკონდიტრო ნაწარმი]; ცომეული საკონდიტრო ნაწარმი; მშრალი ნამცხვარი; ფუნთუშები; წიწაკა [საკმაზი]; პიცა; წიწაკა; კარტოფილის ფქვილი; პუდინგები; შაქარში მოხალული ნიგოზი ან ნუში, პრალინე; რავიოლი [პელმენის სახეობა]; ძირტკბილას კანფეტები; ბრინჯი; ზაფრანა [სუნელი]; საგო; საწებლები [საკმაზები]; ნიახურის მარილი; მანანის ბურღული; ხილის ნაყინი; სპაგეტი; ტაპიოკა; ტაპიოკას ფქვილი; ღვეხელები ხილ-კენკრის შიგთავსით; ვანილი, კულინარიული დანიშნულების; ვანილინი [ვანილის შემცვლელი]; ვერმიშელი; ხორციანი ღვეხელები; პანტეტის ღვეხელი; ხორცის დასარბილებელი შედგენილობები საოჯახო მიზნებისათვის; საკვები ყინული; ნაყინის გასაკეთებელი ფხვნილი; ნუშის საკონდიტრო ნაწარმი; არაქისის საკონდიტრო ნაწარმი; საკვების არომატიზატორები, ეთერზეთების გარდა; სასმელის არომატიზატორები, ეთერზეთების გარდა; დაღერდილი შვრია; დაცხვილი შვრია; შვრიაზე დამზადებული საკვები; შვრიის ფანტელები; შვრიის ფქვილი; ძირტკბილას ჩხირები [კანფეტი]; ლუდის ძმარი; ყავაზე დამზადებული სასმელები; კაკაოზე დამზადებული სასმელები; შოკოლადზე დამზადებული სასმელები; ყავის შემცვლელი; შაქარყინული; ჩიპსები [მარცვლეულის ნაწარმი]; ჩაუ-ჩაუ [საკმაზი]; კუსკუსი; ალაოს ექსტრაქტი; საკვები ალაო; დინდგელა; ცხარე ცივი საწებლები [საკმაზები]; ფუტკრის რძე; ზღვის წყალი კულინარიისთვის; სუში; პომიდვრის საწებელა; მაიონეზი; კრეკერები; მოხარშული კრემი; ხილის ქვლეებზე დამზადებული საკონდიტრო ნაწარმი; მუსლი; ბრინჯის კვერები; სოიას საწებელა; გაყინული იოგურტი [გაყინული საკონდიტრო ნაწარმი]; ტაქოსი [მექსიკური ღვეხელი, სიმინდის, ხორცისა და ბოსტნეულის შიგთავსით]; ტორტილია [სიმინდის კვერი]; ჩაი ყინულით; ჩაიზე დამზადებული სასმელები; სანელებლები სალათებისთვის; საფანელი; ტაბულე [ბოსტნეულის სალათა ხორბლის ბურღულით]; ჰალვა; კიში [ტარტალების ფორმის ერთგვარი ღვეხელი]; ხორცის საწებლები; მისო, სოიასგან დამზადებული პასტა; მარცვლეულზე დამზადებული მსუბუქი საუზმეული; ბრინჯის საუზმეული; ღომი; სიმინდის ბურღული; საცხობი ფხვნილები; საჭმელი სოდა; მწვანელი, დაკონსერვებული [საკმაზები]; ატრიაზე დამზადებული კერძები; ტკბი-

ლი მინანქარი ნამცხვრებისთვის; შოკოლადის მუსი; საკონდიტრო ნაწარმი მუსის სახით; ხილის პიურეები [სოუსები]; მარინადები; ჩიზ-ბურგერები [სენდვიჩი]; პესტო [საწებელი]; შედგენილობები ლორის მომინანქრებისთვის; სელის თესლი კულინარიაში გამოსაყენებლად [სანელებლები]; სელის თესლი კულინარიაში გამოსაყენებლად [სუნელი]; ხორბლის დივი საკვებში გამოსაყენებლად; მარცვლეული ცილის მაღალი შემცველობით; ღვინის ქვა კულინარიაში გამოსაყენებლად; წებოვანი დანამატები კულინარიაში გამოსაყენებლად; მაკარონის სოუსი; მარცვლეულის ბრიკეტები; პალმის შაქარი; ცომი; ყვავილები და ფოთლები, როგორც ჩაის შემცველები; ცომი საკონდიტრო ნაწარმისთვის; პელმენები; შოკოლადის მორთულობა ნამცხვრებისთვის; ნამცხვრების მოსართავი კანფეტები; შოკოლადში ამოვლებული თხილი; ბრინჯის პუდინგი; თხილეულის ფქვილი; წვრილად დაკეპილი ნიორი [საკმაზი]; ბაოზი [მოხარული ცომეული სხვადასხვა შიგთავსით]; ბრინჯის ფაფა კულინარიაში გამოსაყენებლად; ჯიაოზი [ცომის გუფთები შიგთავსით]; რამენი [ატრის იაპონური კერძი]; ბლინები ქონდრის სანელებლით; ბლინები სხვადასხვა სანელებლით; ბურიტოები; მომზადებული ბრინჯი, წყალმცენარეებში გახვეული მზა ბრინჯი; საკვებად ვარგისი ქაღალდი; ბრინჯის ქაღალდი, საკვებად ვარგისი; შოკოლადის სპრედი [პასტისებრი საკვები პროდუქტი]; შოკოლადის კრემი თხილის შემცველობით; ცომზე დამზადებული გუფთები; აგავის სიროფი [ბუნებრივი დამატკბობელი]; სარკისებრი მინანქარი [გლაზური]; გაყინულ-გამხმარი საკვები, რომლის ძირითადი ინგრედიენტი არის ბრინჯი; დულსე დე ლეჟე [რძის ტკბილი დესერტი]; ბიმიზაპი [ბრინჯის, ბოსტნეულის და ხორცის ნარევი]; ონიგირი [ბრინჯის გუნდები]; დაფქული ბრინჯი სწრაფი მომზადებისთვის; ჰოთ-დოგის სენდვიჩები; ყინულის კუბიკები; დამუშავებული თესლი სუნელებად გამოსაყენებლად; სეზამის თესლი [სუნელი]; დაკეპილი ბოსტნეულის მწნილი ცხარე სანელებლებით; ქვინოა, დამუშავებული; ბურღულეული; წიწიბურა, დამუშავებული; წიწიბურას ფქვილი; მოცვის საწებელი; ვაშლის საწებელი; კრუტონები [გამხმარი პურის კვადრატული პატარა ნაჭრები - ნაპიცხარი]; კარტოფილზე დამზადებული ბლინები, საფუარის გარეშე; ხილის საკონდიტრო ნაწარმი; ბრინჯის კრეკერები; კიმჩის ბლინები; ნაყინის ბურბუმელა წითელი ლობიოს დამტკბარი მარცვლებით; პიტნა ამონასუნთქის არომატი-

ზირებისთვის; საღებავი რეზინები ამონასუნთქის არომატიზირებისთვის; ატრია უდონი [მაკარონის სახეობა]; ატრია სოზა [მაკარონის სახეობა]; პური, გლუტენის გარეშე; ტამარინდი, ინდური ფინიკი [სანელებლები]; პროფიტროლი [შოკოლადმოსხმული კრემიანი ნამცხვარი]; კრუსანები; შოკოლადიანი ქაღაღები; კელპის ჩაი [ზღვის მცენარის ჩაი]; კრემ-ბრიულე; კარაქის ნარევი; საკვები ქაღალდის ვაფლი; ქოქოსის მაკარონი; ყავის კაფსულები, შევსებული; ფორთოხლის ყვავილის წყალი კულინარიაში გამოსაყენებლად; ნაყინი ჯოხებზე; ნუგა; ჰარისა [საწებელი]; ჯანჯაფილის პასტა [სანელებელი]; ჩაის სასმელები რძით; შოკოლადით დაფარული კარტოფილის ჩიფსები; მცენარეული ჩაი; ჩაის შემცველები; შოკოლადის ლიქიორი; კაკაოს შემცველები; ლუდის სახარში საფუარი; კომბუჩა [ჩაის სოკო]; დანიური საკონდიტრო ნაწარმი; გნოჩი; კრისტალიზებული ლიმონის წვენი [სანელებელი]; გოგრის გადამუშავებული თესლი [სანელებელი]; კანაფის გადამუშავებული თესლი [სანელებელი]; ხორბალი, გადამუშავებული; ატრიაზე დამზადებული კერძები მცირეწლოვანთათვის.

35 – ცომეულის, მარცვლეული ნაწარმის, პურის, პურ-ფუნთუშეულის, კრუსანების, ტკბილეულობის, ნამცხვრების, სენდვიჩების, მაკარონის, ნაყინის, საკვები ყინულის, თაფლის, შოკოლადის, ყავის, ჩაის, კაკაოს, ყავაზე, ჩაიზე, კაკაოზე დამზადებული სასმელების, ყელეების, ხილფაფების, კომპოტების, ალკოჰოლური და უალკოჰოლო სასმელების, სანელებლების, საკაზმების საცალო ვაჭრობა; საცხოვრების მიერ გაწეული საცალო ვაჭრობის მომსახურება.

43 – საკვებითა და სასმლით უზრუნველყოფა; საკვებისა და სასმლის მომზადების მომსახურება; რესტორნის მიერ გაწეული მომსახურება; საკვების შეკვეთით დამზადებისა და ადგილზე მიტანის მომსახურება (ქეითერიინგი); საკვები და სასმლის მიწოდება შეკვეთით საცხოვრების მიერ; ბარის მიერ გაწეული მომსახურება; სასაუზმეების მიერ გაწეული მომსახურება; კაფეტერიების მიერ გაწეული მომსახურება; კოქტეილბარების მიერ გაწეული მომსახურება; ჩაის ოთახები; ბისტრო; პიცერია; სახაჭაპურე; ბარ-რესტორნების მიერ გაწეული მომსახურება; თვითმომსახურების რესტორნების მიერ გაწეული მომსახურება; მობილური რესტორნების მიერ გაწეული მომსახურება; საკვებითა და სასმლით უზრუნველყოფა ინტერნეტ-კავებში; რესტორნები საკვების გატანის მომსახურებით;

საკვების გასატანად მომზადების მომსახურება; ქველმოქმედების მომსახურება, კერძოდ, საკვებისა და სასმლის დარიგება გაჭირვებულებსათვის; რესტორნებსა და ბარებში საკვებისა და სასმლის მიწოდება; რესტორნებსა და ბარებში საკვებითა და სასმლით უზრუნველყოფა; დროებითი რესტორნების მიერ გაწეული მომსახურება; საკვებისა და სასმლის გატანის მომსახურება, კერძოდ, რესტორნიდან გატანის მომსახურება თვითონ ან მიტანით; საკვებისა და სასმლის მომზადება და მიწოდება დაუყოვნებლივ მოხმარებისათვის; დროებითი საცხოვრებლით უზრუნველყოფა; სასტუმროს მიერ გაწეული მომსახურება; გამომცხვარი ნაწარმით უზრუნველყოფა; საკონდიტრო ნაწარმით უზრუნველყოფა; ინფორმაციით უზრუნველყოფა საცხობის, საკონდიტრო ნაწარმის, საკვების შესახებ.

(260) AM 2023 120840 A

(210) AM 120840

(220) 2022 12 21

(731) შპს „ვინფაქ პროფესიონალ“
 უნივერსიტეტის ქ. 24, სადარ. 4, სართ. 7,
 0186, თბილისი, საქართველო

(540)



(591) წითელი, მწვანე, თეთრი, ლურჯი
 (531) 01.15.21; 05.03.13; 05.03.14; 27.05.01;
 27.05.03; 27.05.17; 29.01.14

(511)

3 – კოსმეტიკური და საპირფარეოსო პრეპარატები (არასამკურნალო); მათეთრებელი პრეპარატები და სხვა სარეცხი ნივთიერებები; წმენდის, გაპრიალების, გაუცხიმოვნებისა და აბრაზიული დამუშავების პრეპარატები; პარფიუმერია, ეთერზეთები; კბილის პასტები (არასამკურნალო).

(260) AM 2023 120844 A

(210) AM 120844

(220) 2022 12 21

(731) ჰამიდი შარიათი
 ყიფშიძის ქ. 3ბ, თბილისი, საქართველო

(540)



(591) D8D222 ოქროსფერი, 000000 შავი
 (531) 25.01.01; 25.01.05; 25.01.13; 25.01.25;
 25.03.13; 27.05.10; 29.01.12

(511)

41 – განათლება; სასწავლო პროცესის უზრუნველყოფა; გართობა; სპორტული და კულტურული ღონისძიებები.

(260) AM 2023 120849 A

(210) AM 120849

(220) 2022 12 21

(731) ფილიპ მორის პროდაქტს ს.ა.
 კე ჟანრენო 3, 2000 ნევშატელი, შვეიცარია

(740) პავლე მეიფარიანი

(540)



(591) რუხი ფერის სხვადასხვა ელფერი, თეთრი
 (531) 26.04.02; 26.04.16; 26.04.18; 26.04.22;
 26.04.24; 27.05.24

(511)

34 – სადენიანი გამოსაორთქლებლები („ვაპორაიზერები“ ან „ვეიპორაიზერები“) ელექტრონული სიგარეტებისათვის და მოწვევისათვის განკუთვნილი ელექტრონული მოწყობილობებისათვის; დაუმუშავებელი ან დამუშავებული თამბაქო; თამბაქოს ნაწარმი სიგარეტის, სიგარეტების, პაპიროსების, სიგარილოების, თვითგახვევადი (თვითნაკეთი) სიგარეტებისათვის განკუთვნილი თამბაქოს, ჩიბუხის თამბაქოს, სადექი თამბაქოს, საბურნუთე თამბაქოსა და კრეტეკის ჩათვლით; სნუსი; თამბაქოს შემცვლელები (არასამედიცინო დანიშნულების); მწველთა საკუთვნო, სიგარეტის და პაპიროსის ქაღალდისა და მილაკების (ჰილზების), სიგარეტის ფილტრების, თამბაქოსათვის განკუთვნილი ქილების, სიგარეტის კოლოფების (პორტსიგარეტის), საფერფლებების, ჩიბუხების, სიგარეტის გასახვევად განკუთვნილი ჯიბის მოწყობილობებისა და სანთებლების ჩათვლით; ასანთი; თამბაქოს ჩხირები (თამბაქოს „სტიკები“), თამბაქოს ნაწარმი მათი შემდგომი გახურების მიზნით, ელექტრონული მოწყობილობები და მათი ნაწილები სიგარეტების ან თამბაქოს გასახურებლად ნიკოტინის შემცველი აეროზოლის გამოყოფისათვის შესუნთქვის მიზნით; თხევადი ნიკოტინის ხსნარები ელექტრონულ სიგარეტებში გამოსაყენებლად; მოწვევისათვის განკუთვნილი ელექტრონული მოწყობილობები; ელექტრონული სიგარეტები; ელექტრონული სიგარეტები, როგორც ტრადიციული სიგარეტების შემცვლელი; ელექტრონული მოწყობილობები ნიკოტინის შემცველი აეროზოლის შესუნთქვისათვის; ორალური დანიშნულების გამოსაორთქლებელი მოწყობილობები მწველთათვის, თამბაქოს პროდუქცია და თამბაქოს შემცვლელი; მწველთა საკუთვნო ელექტრონული სიგარეტებისათვის; ნაწილები და ფიტინგები 34-ე კლასში შემავალი ზემოთ ჩამოთვლილი ნაწარმისათვის; მოწყობილობები გახურებული სიგარეტების, სიგარეტის და ასევე გახურებული თამბაქოს ჩხირების ჩასაქრობად; პორტსიგარები (კოლოფები) ელექტრონული მრავალჯერადად დასატენი სიგარეტებისათვის.

(260) AM 2023 120850 A

(210) AM 120850

(220) 2022 12 21

(731) ფილიპ მორის პროდაქტს ს.ა.

კე ჟანრენო 3, 2000 ნევმატელი, შვეიცარია

(740) პავლე მეიფარიანი

(540)



(591) რუხი ფერის სხვადასხვა ელფერი, თეთრი
(531) 26.04.02; 26.04.16; 26.04.18; 26.04.22;

26.04.24; 27.05.24

(511)

34 – სადენიანი გამოსაორთქლებლები („ვაპორაიზერები“ ან „ვეიპორაიზერები“) ელექტრონული სიგარეტებისათვის და მოწვევისათვის განკუთვნილი ელექტრონული მოწყობილობებისათვის; დაუმუშავებელი ან დამუშავებული თამბაქო; თამბაქოს ნაწარმი სიგარეტის, სიგარეტების, პაპიროსების, სიგარილოების, თვითგახვევადი (თვითნაკეთი) სიგარეტებისათვის განკუთვნილი თამბაქოს, ჩიბუხის თამბაქოს, სადექი თამბაქოს, საბურნუთე თამბაქოსა და კრეტეკის ჩათვლით; სნუსი; თამბაქოს შემცვლელი (არასამედიცინო დანიშნულების); მწველთა საკუთვნო, სიგარეტის და პაპიროსის ქაღალდისა და მილაკების (ჰილზების), სიგარეტის ფილტრების, თამბაქოსათვის განკუთვნილი ქილების, სიგარეტის კოლოფების (პორტსიგარეტის), საფერფლებების, ჩიბუხების, სიგარეტის გასახვევად განკუთვნილი ჯიბის მოწყობილობებისა და სანთებლების ჩათვლით; ასანთი; თამბაქოს ჩხირები (თამბაქოს „სტიკები“), თამბაქოს ნაწარმი მათი შემდგომი გახურების მიზნით, ელექტრონული მოწყობილობები და მათი ნაწილები სიგარეტების ან თამბაქოს გასახურებლად ნიკოტინის შემცველი აეროზოლის გამოყოფისათვის შესუნთქვის მიზნით; თხევადი ნიკოტინის ხსნარები ელექტრონულ სიგარეტებში გამოსაყენებლად; მოწვევისათვის განკუთვნილი ელექტრონული მოწყობილობები; ელექტრონული სიგარეტები; ელექტრონული სიგარეტები, როგორც ტრადიციული სიგარეტების შემცვლელი;

ლები; ელექტრონული მოწყობილობები ნიკოტინის შემცველი აეროზოლის შესუნთქვისათვის; ორალური დანიშნულების გამოსაორთქლებელი მოწყობილობები მწვევლათათვის, თამბაქოს პროდუქცია და თამბაქოს შემცველები; მწვევლთა საკუთვნო ელექტრონული სიგარეტებისათვის; ნაწილები და ფიტინგები 34-ე კლასში შემავალი ზემოთ ჩამოთვლილი ნაწარმისათვის; მოწყობილობები გახურებული სიგარეტების, სიგარეტის და, ასევე, გახურებული თამბაქოს ჩხირების ჩასაქრობად; პორტსიგარები (კოლოფები) ელექტრონული მრავალჯერადად დასატენი სიგარეტებისათვის.

(260) AM 2023 120851 A

(210) AM 120851

(220) 2022 12 22

(731) ფილიპ მორის პროდაქტს ს.ა.

კე ჟანრენო 3, 2000 ნევშატელი, შვეიცარია

(740) პავლე მეიფარიანი

(540)



(591) რუხი ფერის სხვადასხვა ელფერი, თეთრი

(531) 26.04.02; 26.04.16; 26.04.18; 26.04.22;

26.04.24; 27.05.24

(511)

34 – სადენიანი გამოსაორთქლებლები („ვაპორაიზერები“ ან „ვეიპორაიზერები“) ელექტრონული სიგარეტებისათვის და მოწვევისათვის განკუთვნილი ელექტრონული მოწყობილობებისათვის; დაუმუშავებელი ან დამუშავებული თამბაქო; თამბაქოს ნაწარმი სიგარეტის, სიგარეტების, პაპიროსების, სიგარილოების, თვითგახვევადი (თვითნაკეთი) სიგარეტებისათვის განკუთვნილი თამბაქოს, ჩიბუხის თამბაქოს, საღეჭი თამბაქოს, საბურნუთე თამბაქოსა და კრეტეკის ჩათვლით; სნუსი; თამბაქოს შემცველები (არასამედიცინო დანიშნულების); მწვევლთა საკუთვნო, სიგარეტის და პაპიროსის ქაღალდი-

სა და მილაკების (ჰილზების), სიგარეტის ფილტრების, თამბაქოსათვის განკუთვნილი ქილების, სიგარეტის კოლოფების (პორტსიგარების), საფერფლებების, ჩიბუხების, სიგარეტის გასახვევად განკუთვნილი ჯიბის მოწყობილობებისა და სანთებლების ჩათვლით; ასანთი; თამბაქოს ჩხირები (თამბაქოს „სტიკები“), თამბაქოს ნაწარმი მათი შემდგომი გახურების მიზნით, ელექტრონული მოწყობილობები და მათი ნაწილები სიგარეტების ან თამბაქოს გასახურებლად ნიკოტინის შემცველი აეროზოლის გამოყოფისათვის შესუნთქვის მიზნით; თხევადი ნიკოტინის ხსნარები ელექტრონულ სიგარეტებში გამოსაყენებლად; მოწვევისათვის განკუთვნილი ელექტრონული მოწყობილობები; ელექტრონული სიგარეტები; ელექტრონული სიგარეტები, როგორც ტრადიციული სიგარეტების შემცვლელი; ელექტრონული მოწყობილობები ნიკოტინის შემცველი აეროზოლის შესუნთქვისათვის; ორალური დანიშნულების გამოსაორთქლებელი მოწყობილობები მწვევლათათვის, თამბაქოს პროდუქცია და თამბაქოს შემცველები; მწვევლთა საკუთვნო ელექტრონული სიგარეტებისათვის; ნაწილები და ფიტინგები 34-ე კლასში შემავალი ზემოთ ჩამოთვლილი ნაწარმისათვის; მოწყობილობები გახურებული სიგარეტების, სიგარეტის და ასევე გახურებული თამბაქოს ჩხირების ჩასაქრობად; პორტსიგარები (კოლოფები) ელექტრონული მრავალჯერადად დასატენი სიგარეტებისათვის.

(260) AM 2023 120852 A

(210) AM 120852

(220) 2022 12 22

(731) ფილიპ მორის პროდაქტს ს.ა.

კე ჟანრენო 3, 2000 ნევშატელი, შვეიცარია

(740) პავლე მეიფარიანი

(540)



(591) რუხი ფერის სხვადასხვა ელფერი, თეთრი
(531) 26.04.02; 26.04.16; 26.04.18; 26.04.22;
26.04.24; 27.05.24

(511)

34 – სადენიანი გამოსაორთქლებლები („ვაპორაიზერები“ ან „ვეიპორაიზერები“) ელექტრონული სიგარეტებისათვის და მოწვევისათვის განკუთვნილი ელექტრონული მოწყობილობებისათვის; დაუმუშავებელი ან დამუშავებული თამბაქო; თამბაქოს ნაწარმი სიგარეტის, სიგარეტების, პაპიროსების, სიგარილოების, თვითგახვევადი (თვითნაკეთი) სიგარეტებისათვის განკუთვნილი თამბაქოს, ჩიბუხის თამბაქოს, საღეჭი თამბაქოს, საბურნუთე თამბაქოსა და კრეტეკის ჩათვლით; სნუსი; თამბაქოს შემცვლელები (არასამედიცინო დანიშნულების); მწველთა საკუთვნო, სიგარეტის და პაპიროსის ქაღალდისა და მილაკების (ჰილზების), სიგარეტის ფილტრების, თამბაქოსათვის განკუთვნილი ქილების, სიგარეტის კოლოფების (პორტსიგარეტის), საფერფლებების, ჩიბუხების, სიგარეტის გასახვევად განკუთვნილი ჯიბის მოწყობილობებისა და სანთებლების ჩათვლით; ასანთი; თამბაქოს ჩხირები (თამბაქოს „სტიკები“), თამბაქოს ნაწარმი მათი შემდგომი გახურების მიზნით, ელექტრონული მოწყობილობები და მათი ნაწილები სიგარეტების ან თამბაქოს გასახურებლად ნიკოტინის შემცველი აეროზოლის გამოყოფისათვის შესუნთქვის მიზნით; თხევადი ნიკოტინის ხსნარები ელექტრონულ სიგარეტებში გამოსაყენებლად; მოწვევისათვის განკუთვნილი ელექტრონული მოწყობილობები; ელექტრონული სიგარეტები; ელექტრონული სიგარეტები, როგორც ტრადიციული სიგარეტების შემცვლელები; ელექტრონული მოწყობილობები ნიკოტინის შემცველი აეროზოლის შესუნთქვისათვის; ორალური დანიშნულების გამოსაორთქლებელი მოწყობილობები მწველთათვის, თამბაქოს პროდუქცია და თამბაქოს შემცვლელები; მწველთა საკუთვნო ელექტრონული სიგარეტებისათვის; ნაწილები და ფიტინგები 34-ე კლასში შემავალი ზემოთ ჩამოთვლილი ნაწარმისათვის; მოწყობილობები გახურებული სიგარეტების, სიგარეტის და ასევე გახურებული თამბაქოს ჩხირების ჩასაქრობად; პორტსიგარეტი (კოლოფები) ელექტრონული მრავალჯერადად დასატენი სიგარეტებისათვის.

(260) AM 2023 120854 A

(210) AM 120854

(220) 2022 12 22

(731) ფილიპ მორის პროდაქტს ს.ა.

კე ჟანრენო 3, 2000 ნევმატელი, შვეიცარია

(740) პავლე მეიფარიანი

(540)



(591) რუხი ფერის სხვადასხვა ელფერი, თეთრი

(531) 26.04.16; 26.04.18; 26.04.22; 26.04.24;
27.05.24

(511)

34 – სადენიანი გამოსაორთქლებლები („ვაპორაიზერები“ ან „ვეიპორაიზერები“) ელექტრონული სიგარეტებისათვის და მოწვევისათვის განკუთვნილი ელექტრონული მოწყობილობებისათვის; დაუმუშავებელი ან დამუშავებული თამბაქო; თამბაქოს ნაწარმი სიგარეტის, სიგარეტების, პაპიროსების, სიგარილოების, თვითგახვევადი (თვითნაკეთი) სიგარეტებისათვის განკუთვნილი თამბაქოს, ჩიბუხის თამბაქოს, საღეჭი თამბაქოს, საბურნუთე თამბაქოსა და კრეტეკის ჩათვლით; სნუსი; თამბაქოს შემცვლელები (არასამედიცინო დანიშნულების); მწველთა საკუთვნო, სიგარეტის და პაპიროსის ქაღალდისა და მილაკების (ჰილზების), სიგარეტის ფილტრების, თამბაქოსათვის განკუთვნილი ქილების, სიგარეტის კოლოფების (პორტსიგარეტის), საფერფლებების, ჩიბუხების, სიგარეტის გასახვევად განკუთვნილი ჯიბის მოწყობილობებისა და სანთებლების ჩათვლით; ასანთი; თამბაქოს ჩხირები (თამბაქოს „სტიკები“), თამბაქოს ნაწარმი მათი შემდგომი გახურების მიზნით, ელექტრონული მოწყობილობები და მათი ნაწილები სიგარეტების ან თამბაქოს გასახურებლად ნიკოტინის შემცველი აეროზოლის გამოყოფისათვის შესუნთქვის მიზნით; თხევადი ნიკოტინის ხსნარები ელექტრონულ სიგარეტებში გამოსაყენებლად; მოწვევისათვის განკუთვნილი ელექტრონული მოწყობილობები; ელექტრონუ-

ლი სიგარეტები; ელექტრონული სიგარეტები, როგორც ტრადიციული სიგარეტების შემცვლელი; ელექტრონული მოწყობილობები ნიკოტინის შემცველი აეროზოლის შესუნთქვისათვის; ორალური დანიშნულების გამოსაორთქლებელი მოწყობილობები მწვევლათვის, თამბაქოს პროდუქცია და თამბაქოს შემცვლელი; მწვევლთა საკუთვნი ელექტრონული სიგარეტებისათვის; ნაწილები და ფიტინგები 34-ე კლასში შემავალი ზემოთ ჩამოთვლილი ნაწარმისათვის; მოწყობილობები გახურებული სიგარეტების, სიგარეტის და ასევე გახურებული თამბაქოს ჩხირების ჩასაქრობად; პორტსიგარები (კოლოფები) ელექტრონული მრავალჯერადად დასატენი სიგარეტებისათვის.

(260) AM 2023 120856 A

(210) AM 120856

(220) 2022 12 22

(731) ფილიპ მორის პროდაქტს ს.ა.

კე ჟანრენო 3, 2000 ნევშატელი, შვეიცარია

(740) პავლე მეიფარიანი

(540)



(591) რუხი ფერის სხვადასხვა ელფერი, თეთრი

(531) 26.04.16; 26.04.18; 26.04.22; 26.04.24;

27.05.24

(511)

34 – სადენიანი გამოსაორთქლებლები („ვაპორაიზერები“ ან „ვეიპორაიზერები“) ელექტრონული სიგარეტებისათვის და მოწვევისათვის განკუთვნილი ელექტრონული მოწყობილობებისათვის; დაუმუშავებელი ან დამუშავებული თამბაქო; თამბაქოს ნაწარმი სიგარეტის, სიგარეტების, პაპიროსების, სიგარილოების, თვითგახვევადი (თვითნაკეთი) სიგარეტებისათვის განკუთვნილი თამბაქოს, ჩიბუხის თამბაქოს, სადეჭი თამბაქოს, საბურნუთე თამბაქოსა და კრეტეკის ჩათვლით; სნუსი; თამბაქოს შემცვლელი

(არასამედიცინო დანიშნულების); მწვევლთა საკუთვნი, სიგარეტის და პაპიროსის ქაღალდისა და მილაკების (ჰილზების), სიგარეტის ფილტრების, თამბაქოსათვის განკუთვნილი ქილების, სიგარეტის კოლოფების (პორტსიგარების), საფერფლებების, ჩიბუხების, სიგარეტის გასახვევად განკუთვნილი ჯიბის მოწყობილობებისა და სანთებლების ჩათვლით; ასანთი; თამბაქოს ჩხირები (თამბაქოს „სტიკები“), თამბაქოს ნაწარმი მათი შემდგომი გახურების მიზნით, ელექტრონული მოწყობილობები და მათი ნაწილები სიგარეტების ან თამბაქოს გასახურებლად ნიკოტინის შემცველი აეროზოლის გამოყოფისათვის შესუნთქვის მიზნით; თხევადი ნიკოტინის ხსნარები ელექტრონულ სიგარეტებში გამოსაყენებლად; მოწვევისათვის განკუთვნილი ელექტრონული მოწყობილობები; ელექტრონული სიგარეტები; ელექტრონული სიგარეტები, როგორც ტრადიციული სიგარეტების შემცვლელი; ელექტრონული მოწყობილობები ნიკოტინის შემცველი აეროზოლის შესუნთქვისათვის; ორალური დანიშნულების გამოსაორთქლებელი მოწყობილობები მწვევლათვის, თამბაქოს პროდუქცია და თამბაქოს შემცვლელი; მწვევლთა საკუთვნი ელექტრონული სიგარეტებისათვის; ნაწილები და ფიტინგები 34-ე კლასში შემავალი ზემოთ ჩამოთვლილი ნაწარმისათვის; მოწყობილობები გახურებული სიგარეტების, სიგარეტის და ასევე გახურებული თამბაქოს ჩხირების ჩასაქრობად; პორტსიგარები (კოლოფები) ელექტრონული მრავალჯერადად დასატენი სიგარეტებისათვის.

(260) AM 2023 120938 A

(210) AM 120938

(220) 2022 12 26

(731) შპს „ტფილისის მარანი“

ვალთაშვილის ქ. 33, ბ. 6, 0179, თბილისი, საქართველო

(540)

ზეკარი
Зекари
Zekari

(591) შავ-თეთრი

(531) 28.19

(511)

32 – მინერალური და გაზიანი წყლები.

(260) AM 2023 120948 A
 (210) AM 120948
 (220) 2022 12 28
 (731) შპს „NGS Group“
 ამალეების ქ. 47, 0105, თბილისი,
 საქართველო
 (540)

AMA

(591) 000000 შავ-თეთრი
 (511)
 43 – საკვებით და სასმელით უზრუნველყოფა;
 დროებითი საცხოვრებელით უზრუნველყოფა.

(260) AM 2023 120955 A
 (210) AM 120955
 (220) 2022 12 29
 (731) ლალინ ქენდლზ ენდ სოფუს ლტდ
 6 ჰერმონ სტრიტი, ეარპორტ სიტი, ლოდი,
 ისრაელი
 (740) გიორგი თაქთაქიშვილი
 (540)

LALINE

(591) შავ-თეთრი
 (511)
 4 – ზეთები.

35 – საქმიანობის მართვა, საცალო ვაჭრობის მა-
 ლაზიების მომსახურება და ონ-ლაინ საცალო
 ვაჭრობის მომსახურება ზეთების და, ასევე,
 სხვადასხვა ხელსაწყოებისა და კონტეინერების
 გასაყიდად.

(260) AM 2023 120956 A
 (210) AM 120956
 (220) 2022 12 29
 (731) ლალინ ქენდლზ ენდ სოფუს ლტდ
 6 ჰერმონ სტრიტი, ეარპორტ სიტი, ლოდი,
 ისრაელი
 (740) გიორგი თაქთაქიშვილი
 (540)



(591) შავ-თეთრი
 (531) 25.01.25; 25.03.15; 27.05.04

(511)
 4 – ზეთები.
 35 – საქმიანობის მართვა, საცალო ვაჭრობის მა-
 ლაზიების მომსახურება და ონ-ლაინ საცალო
 ვაჭრობის მომსახურება ზეთების და, ასევე,
 სხვადასხვა ხელსაწყოებისა და კონტეინერების
 გასაყიდად.

(260) AM 2023 121051 A
 (210) AM 121051
 (220) 2023 01 05
 (731) იტვ სტუდიოს ნეზერლენდ კონტენტ ბ.ვ.
 კოს პოსტემალაან 8, 1217 ZC ჰილვერსუმი,
 ნიდერლანდები
 (740) თამაზ შილაკაძე
 (540)



(591) მუქი ლურჯი, ლურჯი, ცისფერი, ღია
 ცისფერი, ოქროსფერი
 (531) 26.04.02; 26.04.05; 26.04.12; 26.04.22;
 26.04.24; 26.11.09; 28.19; 29.01.12

(511)
 41 – განათლება, სასწავლო პროცესის უზრუნ-
 ველოფა, გართობა, სპორტული და კულტურ-
 რული ღონისძიებები; კინოფილმების გაქირა-
 ვება; კულტურულ-საგანმანათლებლო და გა-
 სართობი კლუბები; ვიდეოფილმების მონტაჟი;
 გამართობების სამსახური; კინოფილმების წარ-
 მოება სარეკლამო ფილმების გარდა; გასართობი
 რადიოგადაცემები; კინოფილმების გაქირავება;
 ვიდეოფილმების გაქირავება; შოუ-პროგრამები;
 სატელევიზიო გასართობი გადაცემები; ტელე
 და რადიოპროგრამების წარმოება; ვიდეო-
 ფილმების წარმოება; მასტერკლასების ორგანი-
 ზება და ჩატარება; საინფორმაციო განათლება;
 საგანმანათლებლო-აღმზრდელითი მომსა-
 ხურება; პუბლიკაცია მაგიდის ელექტრონული
 საგამომცემლო სისტემების გამოყენებით; გარ-
 თობასთან დაკავშირებული ინფორმაცია; ორიენ-
 ტირება (პროფესიული) [რჩევები განათლებისა
 და სწავლების სფეროში]; დასვენებასთან დაკავ-
 შირებული ინფორმაცია; ორგანიზება (სასწავ-
 ლო ან გასართობი კონკურსების); პრაქტიკული
 ჩვევების სწავლება [დემონსტრირება]; ჩამწერი
 სტუდიები; დასვენების უზრუნველყოფა; აუ-

დიოჩანაწერების გაქირავება; ბილეთების დაჯავშნა სპექტაკლებზე; გამოცემა (წიგნების); ორგანიზება (სპორტული შეჯიბრების); გამოფენების ორგანიზაცია (კულტურულ-საგანმანათლებლო); მოდის ჩვენებების ორგანიზება გართობის მიზნით; კინოდარბაზებით უზრუნველყოფა; სანახაობების ორგანიზება [იმპრესარიოს მომსახურება]; მიღების, წვეულების პროგრამის შედგენა [გართობა]; თეატრალიზებული წარმოდგენები; ელექტრონული წიგნებისა და ჟურნალების ონლაინ გამოქვეყნება; თეატრალური წარმოდგენები; გასართობები; თამაშების ინტერაქტიური უზრუნველყოფა კომპიუტერულ ქსელში; ბიბლიოთეკები (მოდრავი); ინტერაქტიური გამოცემების უზრუნველყოფა [არაჩატვირთვადი]; ახალი ამბების სამსახური; სატელევიზიო სათამაშო შოუების წარმოება და განაწილება; გართობის მომსახურება სატელევიზიო სათამაშო შოუების სახით; გართობის სამსახურები სათამაშო შოუების განვითარების, შექმნის, წარმოების, განაწილების და წარმოების შემდგომი რედაქტირების მომსახურების სახით; სატელევიზიო სათამაშო შოუების მოსმენის სამსახურები; სათამაშო შოუებისთვის საშუალებებისა და აღჭურვილობის უზრუნველყოფა; გართობასთან, სატელევიზიო პროგრამებთან, კულტურასთან, განათლებასა და სპორტთან დაკავშირებული ინფორმაციით უზრუნველყოფა; გართობა რეალურ დროში მიმდინარე სათამაშო შოუების სახით; ბილეთების დაჯავშნის სამსახურები საგანმანათლებლო, გასართობი და სპორტული ღონისძიებებისთვის; კომპიუტერული ქსელის მეშვეობით ონლაინ რეჟიმით უზრუნველყოფილი სათამაშო მომსახურება; გართობის მომსახურება სათამაშო შოუების სახით; გართობის მომსახურება ინტერაქტიური სატელევიზიო პროგრამების და აუდიტორიის მონაწილეობით ღონისძიებების სახით; ონლაინ გართობის უზრუნველყოფა სათამაშო შოუების სახით; გასართობი თამაშით მომსახურება; უნარების თამაშებით უზრუნველყოფა; ზემოაღნიშნული მომსახურების მიწოდება პირდაპირ ეთერში ან ტელევიზიის საშუალებით ან ონლაინ რეჟიმში კომპიუტერული მონაცემთა ბაზებიდან ან ინტერნეტის ან პორტატიული, მობილური, ჯიბის ან პლანშეტური მოწყობილობებიდან; სათამაშო მომსახურებასთან, ტურნირებთან, შეჯიბრებებთან, თამაშებთან, სათამაშო შოუებთან და ღონისძიებებთან დაკავშირებული ინფორმაციით უზრუნველყოფა; გართობის მომსახურების, სატელევიზიო გასართობი მომსახურების, სპორტული აქტივობების,

კულტურული ღონისძიებების, გართობის მომსახურების, გასართობი თამაშების, ახარტული თამაშების მომსახურების, ტურნირების, შეჯიბრებების, თამაშების, სათამაშო შოუების და ღონისძიებების ორგანიზება, წარმოება, წარდგენა და უზრუნველყოფა; ინტერაქტიური ონლაინ გართობა; ვირტუალური რეალობის სათამაშო მომსახურება ონლაინ რეჟიმში კომპიუტერული ქსელის მეშვეობით; ვირტუალური რეალობის გარემოში წვდომის უზრუნველყოფა (ოთახები); გასართობი ინფორმაციით უზრუნველყოფა ინტერნეტის მეშვეობით; სატელევიზიო, საკაბელო, თანამგზავრული და ინტერნეტ-პროგრამების და ფილმების, ხმოვანი ჩანაწერების, ვიდეო ჩანაწერების და DVD დისკების წარმოება, პრეზენტაცია, გავრცელება, მაუწყებლობა და გაქირავება; სატელევიზიო პროგრამების ფორმატების განვითარება; ღონისძიებების ორგანიზება, წარმოება და წარდგენა საგანმანათლებლო, კულტურული და გართობის მიზნებისთვის; შეჯიბრებების, კონკურსების, კონცერტების, თამაშების, სათამაშო შოუების, სატელევიზიო შოუების, შოუების ორგანიზება, წარმოება, წარდგენა და უზრუნველყოფა; სტუდიური წარმოდგენების და პრეზენტაციების ორგანიზება, წარმოდგენების და პრეზენტაციების ორგანიზება; გასართობი პარკები და არკადული თამაშებით მომსახურება; არაჩამოსატვირთი ონლაინ ვიდეო-მომსახურება; წიგნების, ჟურნალების, ტექსტების, ნაბეჭდი მასალების და ჩანაწერების გამოცემა; ელექტრონული გამოცემების და ონლაინ გამოცემების, მათ შორის, ელექტრონული წიგნების, გაზეთების, ჟურნალების (პერიოდული გამოცემების), გამოცემა და უზრუნველყოფა. ზემოთ აღნიშნულ მომსახურებასთან დაკავშირებული ინფორმაცია და რჩევები.

(260) AM 2023 121123 A

(210) AM 121123

(220) 2023 01 09

(731) ტონი სალამე ფაინენს „ტ.ს.ფ.“ (ჰოლდინგ) სალ

ჯალ ელ დიბ, ზარდ ბილდინგ, 1 ფლორ, ბეირუთი, ლიბანი

(540)

(591) შავ-თეთრი

(531) 27.05.01

(511)

25 – ტანსაცმელი, პერანგები, სპორტული პერანგები; პერანგები ზრდასრულებისთვის; ბავშვის პერანგები; ყოველდღიური პერანგები; სვიტრები, შარვლები, შორტები, ქურთუკები, სავარჯიშო შარვლები, სავარჯიშო კოსტიუმები, წინდები, ყელსახვევები, ქვედატანები, კაბები; ქუდები; ფეხსაცმელები; ფეხსაცმლის ქუსლები, ქამრები [ტანსაცმელი], ხელთათმანები [ტანსაცმელი], ნაქსოვი ტანსაცმელი, კოსტიუმები შარვლით, ნაქსოვი ქუდები; სათხილამურო ქუდები [ნაქსოვი ქუდები], ქალის თეთრეული, საღამურები, მანტოები; ფეხსაცმელი; ფეხსაცმელი მოზარდებისთვის; ბავშვის ფეხსაცმელი; ფეხსაცმელი ჩვილებისთვის, სანდლები, ჩექმები, დაბალყელიანი (კოჭამდე) ფეხსაცმელი; კაცის ჩექმები, ქალის ჩექმები, სპორტული ფეხსაცმელი, საშინაო ფეხსაცმელი, ფეხსაცმელი ბრტყელი ლანჩით, ფოსტლები; მაღალქუსლიანი ფეხსაცმელი; ლანჩები; თავსაბურავი; მამაკაცის თავსაბურავი, ბავშვის თავსაბურავი, ტყავის თავსაბურავი.

(260) AM 2023 121127 A

(210) AM 121127

(220) 2023 01 10

(731) შპს „რითეილ კონსულტანტს დმსს“ ჯუმეირას ლეიქს თაუერს, ნაკვეთის NJLTE-PH2-BB1, მაზაიას ბიზნეს გამზირი BB1 N2504, დუბაი, 416610, არაბთა გაერთიანებული საამიროები

(740) ნინო გაზდელიანი

(540)



(591) ლურჯი, თეთრი

(531) 26.04.05; 26.04.22; 26.04.24; 27.05.24; 29.01.12

(511)

35 – რეკლამა; ბიზნესის მართვა; ბიზნესის ადმინისტრირება; საოფისე მომსახურება.

43 – საკვებით და სასმელით უზრუნველყოფა; დროებითი საცხოვრებელით უზრუნველყოფა.

(260) AM 2023 121132 A

(210) AM 121132

(220) 2023 01 10

(731) ბორგორნერ ინკ.

დელავერის კორპორაცია

3850 ჰემლინ როუდი ობერნ ჰილს,

მიჩიგანი 48326, აშშ

(740) თამაზ შილაკაძე

(540)

PHINIA

(591) შავ-თეთრი

(511)

7 – სამმხრივი სარქველები; ამრაკები; გადამყვანები ანთების საწინააღმდეგო და მანაწილებლებისთვის; სასოფლო-სამეურნეო იარაღების შემადგენელი ნაწილები, კერძოდ: ტურბოკომპრესორები, ჰაერსაბერები, ფრიქციული დისკოები, მუხრუჭის დისკოები, ცალმხრივი ქუროები; ჰაერის მართვის სარქველები; პნევმატიკური დაკიდების სოლენოიდები; დაბლოკვის საწინააღმდეგო სოლენოკეტის მიმმართველები; დამატებითი გამათბობლები; ღერძები; ბატარეის გამაგრებლები; ბატარეის გამათბობლები; ჰაერსაბერები; გადასაშვები სარქველი; სალონის გამათბობლები; ცენტრიდანული ტუმბოები; გადაბმულობის დისკოები; გადაბმულობის ზესადებები; გადაბმულობის მოდილები; გადაბმულობის ზამბარები; გადაბმულობის სისტემები; გადაბმის ქუროები; გამტარი ვერცხლის სარემონტო კომპლექტების შეერთების ნაწილები ტყვიებისთვის, კერძოდ, მაცენტრებელი მილისები, კონტაქტები, მილისები, მანაწილებელი კონექტორები, ანთების კაბელის მილისები, კუთხვილის მილისები, ჭრიალას მილისები, კონტაქტის მილისები, ხერხისებრი კუთხვილის მილისები, კუთხის ხერხისებრი კუთხვილის მილისები, მავნებლებისგან დამცავი რგოლები; შეხების წერტილები ანთების სისტემებისთვის; საკონტაქტო კომპლექტები; მართვის მოდულები; კონტროლერები; გამაგრებლების ტუმბოები; გადაბმულობები; ელექტროგენერატორები; ელექტროძრავები მანქანებისთვის; ფილტრები; გაშვებისწინა გათბობის საწინააღმდეგოები, კერძოდ, გადამყვანი კაბელები, გამათბობლის და სტარტერის გადამრთველები, საიზოლაციო შუასადებები (სპეისერები), დადარული ქანჩები, მაგნიტური სარქველები, თანმიმდევრული რეზისტორები ბიმეტალკონტაქტით, გამათბობლის გამაფრთხილებელი ნათურები, საფარები გამათბობლის გამაფრთხილებელი

ბელი ნათურებისთვის, სწრაფი სტარტის ნაკრები დიზელის სამგზავრო სატრანსპორტო საშუალების რელეს/მართვის ბლოკებისთვის; თბოგადამცემები; ინჟექტორები და ინჟექტორების აქსესუარები, კერძოდ, თბოიზოლაციის საყელურები, სპილენძის ბეჭდები ინჟექტორისთვის, უნივერსალური შემჭიდროების ღრუ ხრახნები, ზეთის გაჟონვის საცობები ფრქვევანას დასაბრუნებლად, ზეთის გაჟონვის შლანგები; მყისიერი სტარტის სისტემები; დაბრკოლებების დამთრგუნველი სისტემები; სადენები და სადენების აქსესუარები, კერძოდ, ძალური კაბელები, ადაპტორები, საცობები, შტეკერები, ასორტიმენტი; ბლოკირებადი მორგვეები; მაგნიტური ვენტილები; ლითონის ჯაჭვები არასავტომობილო გამოყენებისთვის, კერძოდ, მოტოციკლებისა და თოვლმავლებისთვის; სენსორული ტექნოლოგია; სენსორები; ლილვები; სახელურის ტიპის ჩამხმობები გამანაწილებლებისათვის; ამორტიზატორები; სოლენოიდური მოდულები; სოლენოიდები გადაცემებისათვის და სხვა; ანთების სანთლები და ანთების სანთლების აქსესუარები, კერძოდ, ქანჩის შემაერთებელი ბიჯები, შუასადებები, სათადარიგო ნაწილები ანთების სანთლების მოწყობილობების შესამოწმებლად და გასაწმენდად, ანთების სანთლების სამონტაჟო საშუალებები; გაშვების სისტემები; კონდენსატორის მაყურები; სინქრონიზატორები; დამჭიმები; იარაღები და საცდელი ხელსაწყოები (ტესტერები), კერძოდ, ანთების სანთლის გასაღებები, ნათურის ტესტერები, მომჭერი იარაღი ანთების სადენებისთვის, გაშვებისწინა გათბობის სანთლების ტესტერები, სამონტაჟო დამხმარე საშუალება, ჟანგბადის გადამწოდის ტესტერები, სახსნელის ცანგა ანთების სანთლის ადაპტერებისთვის, სახსნელი იარაღი ანთების კოჭებისთვის, საფართები, ანთების სანთლის კუთხვილების სარემონტო ნაკრებები, კერძოდ, ბურღები კუთხვილის ჩანართები, რგოლები, ჭრილებიანი გასაღები, ვაზნები, სათადარიგო კუთხვილის ჩანართები, ზამბარები; წყლის ფარის ჩამოსხმული ნაწილები; საწვავის შეფრქვევის სისტემა ძრავებისთვის; საწვავის ტუმბოები სახმელეთო სატრანსპორტო საშუალებებისთვის; ძრავის საწვავის ტუმბოები; ძრავის ნაწილები, კერძოდ, საწვავის შეფრქვევის ელექტრონული მოდულები და საწვავის მიწოდების მოდულები; საწვავის ფრქვევანა (ინჟექტორები); საწვავის ფრქვევანას ნაწილები სახმელეთო სატრანსპორტო საშუალებებისთვის; საწვავის რელსები ძრავებისთვის; შერჩევითი კატალიზური რედუქციის (SCR) დო-

ზირების სისტემები სატრანსპორტო საშუალებებისთვის და მათი ნაწილები; გამონაბოლქვი აირების გამწმენდი სისტემები დიზელის ძრავებისთვის და მათი ნაწილები; საწვავის სისტემის ნაწილები სახმელეთო სატრანსპორტო საშუალებებისთვის, კერძოდ, ბაკები; ნახშირის ფილტრები; საწვავის კომპრესორები ძრავებისთვის; მაღალი წნევის საწვავის დამაკავშირებელი მილები; ორთქლის მართვის სისტემები; გამონაბოლქვის მართვის სისტემები; ელექტროსტარტერი, სტარტერები მოტორებისა და ძრავებისთვის; ცვლადი დენის გენერატორები; ვენტილატორის ამძრავები; ელექტრონული მართვის ბლოკები ძრავებისთვის; წყლის ინჟექტორები და მათი ნაწილები; ჰაერსაზომები; ზეთის ფილტრები; საწვავის ფილტრები; ძრავაში ჰაერის მიწოდების მართვის სარქველები; ძრავაში უქმი სვლის მართვის სარქველები; გამონაბოლქვის სისტემის, ჟანგბადის, აზოტის ქვეჟანგის, ამიაკის, ტემპერატურის, წნევის, მყარი ნაწილაკების და ნაკადის სენსორები შიდა წვის ძრავის ნაწილების სახით; ანთების კაბელები, ანთების კოჭები, ანთების კოჭების რეზისტორები, ანთების კონდენსატორები, ანთების კონექტორები ანთების სანთლებისთვის, ანთების მანაწილებლის ხუფები, ანთების მანაწილებლის როტორები, ანთების სისტემის სადენები, ანთების მოდულები, ანთების სისტემები, ანთების სისტემები გათბობის სისტემებისთვის, ანთების მავთულის ნაკრებები; მანაწილებლები სატრანსპორტო საშუალებებისთვის; მუხრუჭები მანქანებისთვის; სამუხრუჭო სისტემები მანქანებისთვის; სამუხრუჭო აპარატურა, სატრანსპორტო საშუალებებში გამოსაყენებლის გარდა; დისკური მუხრუჭები მანქანებისთვის; მუხრუჭის ფრიქციული ზესადებები, სატრანსპორტო საშუალებებში გამოსაყენებლის გარდა; მუხრუჭის ხუნდები, სატრანსპორტო საშუალებებში გამოსაყენებლის გარდა; ხუნდიანი მუხრუჭი, სატრანსპორტო საშუალებებში გამოსაყენებლის გარდა; ძრავას სინქრონიზაციის კომპონენტები, კერძოდ, მუშტა ცვალებადი სინქრონიზაციით და მუსტას ფაზამბრუნები; მაცივებელი სითხის ტუმბოები ელექტროსატრანსპორტო საშუალებებისთვის; წყლის ტუმბოები ელექტროსატრანსპორტო საშუალებებისთვის; ზეთის ტუმბოები ელექტროსატრანსპორტო საშუალებებისთვის.

9 – მართვის პანელები; დისპლები; საინსტრუმენტო პანელის დისპლები; ძაბვის გარდამქმნელები; ელექტრონული გარდამქმნელები;

კომპიუტერის პროგრამული უზრუნველყოფა; კომპიუტერის პროგრამული უზრუნველყოფა ბატარეების სამართავად და შესამოწმებლად; დენის კონტროლიორები; ელექტრო-კონტროლერები; ძრავის კონტროლიორები; ელექტრონული ინვერტორები; ელექტრული ინვერტორები; ელექტრული დენის ინვერტორები; ინვერტორები ელექტრომომარაგებისთვის; ბატარეის ინდიკატორები; ბატარეების დამმუხტველები; ელექტრობატარეების დამმუხტველები; აკუმულატორული კვების სისტემები; დენის მრიცხველები; საჭის მართვის აპარატურა, ავტომატური, სატრანსპორტო საშუალებებისთვის; მართვის სახელურები; აქსელატორები; აჩქარებისა და დენის კონტროლერები, სადიაგნოზო სისტემები და აპარატურა ელექტრონული სატრანსპორტო საშუალებებისთვის, ელექტროძრავებისთვის და ბატარეაზე მომუშავე აპარატებისთვის; ტემპერატურის სენსორები, დინამიკური სენსორები; ელექტროენერჯის მართვის აპარატურა; ელექტრული და ელექტრონული მართვის სისტემები და აპარატურა ელექტროძრავებისა და ელექტროსატრანსპორტო საშუალებებისთვის; ელექტრული და ელექტრონული მართვის სისტემები და აპარატურა ბატარეაზე მომუშავე სატრანსპორტო საშუალებებისთვის და ბატარეაზე მომუშავე სხვა აპარატებისთვის.

12 – ჰაერის ტუმბოები; 4-თვლიანი ამძრავი სისტემები და კომპონენტები; სრული ამძრავის ელექტრონული მართვის საშუალებები და პროგრამული უზრუნველყოფა; სრული ამძრავის კომპონენტები და სისტემები; ღერძული ტუმბოები; ჯაჭვური გადაცემები; ჯაჭვის დამჭიმები; ჯაჭვები; კომპრესორები; ამორტიზატორები; დიფერენციალები; ამძრავი ჯაჭვები; საქარე სარქველები; დამამიწებელი გამტარები; გადაცემათა კოლოფები ელექტროამძრავით; წამყვანი ხიდები ელექტროამძრავით; ტრანსმისიები ელექტროამძრავით; ელექტრონული მართვის ბლოკები; ელექტროძრავები სატრანსპორტო საშუალებებისათვის; ელექტრონული ასამუშაველ-სარეგულირებელი მოწყობილობები დიზელის ძრავებისათვის; გამონაბოლქვის კონტროლის საშუალებები; გამონაბოლქვის სისტემები; ძრავის თბოსისტემები და მართვის საშუალებები; ძრავის აირგამანაწილებელი სისტემები; გამონაბოლქვის აირის რეცირკულაციის სარქველები; ვენტილატორის ამძრავის ქუროს შემსრულებელი მექანიზმი; ვენტილატორის ამძრავი; ვენტილატორები; ვენტილა-

ტორის ქურო; ვენტილატორის ქუროს კომპლექტი; ფრიქციული დისკები; საწვავის მართვის მოწყობილობები; კბილა გადაცემები და გადაცემათა კოლოფები; ინვერტორები; მაგნეტოები მოტოციკლებისთვის; ზეთის წნევის სასიგნალო გადამწოდები; ზეთის ტუმბოები; ცალმხრივი ქუროები; ჟანგბადის სენსორები; სატრანსპორტო, სახმელეთო, წყლის და საჰაერო სატრანსპორტო საშუალებებისათვის განკუთვნილი ნაწილები; ძალური ელექტრონიკა სატრანსპორტო საშუალებებისათვის; ძალური გადაცემის სისტემის ნაწილები (კომპონენტები); პროპორციული სარქველები; ტუმბოები და მათი ნაწილები; რეცირკულაციის სარქველები; რედუქტორები (მამცირებელი გადაცემები); გრიგალური ტუმბოები; რეგულატორები; რეგულატორები ავტომანქანების გენერატორებისთვის; როტაციული კომპრესორები; ჰაერის მეორეული სისტემები; ჯაჭვის თვალეები (ვარსკვლავა); სტარტერები (ამამუშაველები); თერმორეგულირების სისტემები და კომპონენტები; თერმული სისტემები; დროსელ-სარქველები; აირგამანაწილებელი მექანიზმის ჯაჭვები, მანაწილებელი ლილვის ამძრავი ჯაჭვები; სისტემის მუშაობის სინქრონიზაციის ხელსაწყოების ნაკრები, კერძოდ, ჯაჭვები, მიმმართველი ბერკეტები, დამჭიმები, ვარსკვლავები, მფაზავები და სოლენოიდები; ხრახნული კბილა თვალეები; საბურავების შემოწმების სისტემები; საბურავების შემოწმების სისტემების კომპონენტები, კერძოდ, საბურავის ელექტრონიკა, საბურავის წნევის სარქველი, ინსტრუმენტის მომართვის სადგურის (TSS) ამამუშავებელი ნაკრები, სარქველი, ხუფები და სარქველის გულარები; გრეხითი რხევის მაყუჩებლები; სარიგებელი კოლოფები; გადაცემის დიაპაზონები; ამძრავი ჯაჭვები; ტრანსმისიები; ტურბოკომპრესორები; სარქველები; ცვლადი ძალის სოლენოიდი; ცვლადი სიჩქარის ამძრავები; ნამუშევარი აირების გადასაშვები სარქველები; წყლის ტუმბოები; სენსორები სახმელეთო სატრანსპორტო საშუალებებისთვის, კერძოდ, საწვავის, წნევის და ტემპერატურის სენსორები; დომენის კონტროლერები; ძრავების შემოწმებისა და დიაგნოსტიკის მოწყობილობა და მათი ნაწილები; ავტომობილის შემოწმების მოწყობილობა, კერძოდ, ტრანსმისიისა და მუხრუჭის შემოწმების მოწყობილობა, პორტატიული დიაგნოსტიკური სკანერები, გამონაბოლქვი აირების შემოწმების მოწყობილობა, ელექტრონული აპარატურა ავტომანქანის ძრავის ზეთის შესამოწმებლად; ელექტრონული მოწყობილობის გამოსაცდელი

აპარატურა, აკუმულატორების გამოსაცდელი აპარატურა, მუხრუჭების გამოსაცდელი აპარატურა, ელექტრონული ხელსაწყოების გამოსაცდელი აპარატურა; ავტომობილის შემოწმების მოწყობილობა, კერძოდ, ხელის დიაგნოსტიკური სკანერები; დიზელის ძრავების გამონაბოლქვის აირების გამოსაცდელი ხელსაწყოები; მუხრუჭები სატრანსპორტო საშუალებებისთვის; სამუხრუჭო სისტემები სატრანსპორტო საშუალებებისთვის; სამუხრუჭო რკინის ნაკეთობები (ფურნიტურა) სატრანსპორტო საშუალებებისთვის; სამუხრუჭო ბალიშები სატრანსპორტო საშუალებებისთვის; სამუხრუჭო დოლები სატრანსპორტო საშუალებებისთვის; მუხრუჭის სუპორტები სატრანსპორტო საშუალებებისთვის; დისკური მუხრუჭები სატრანსპორტო საშუალებებისთვის; სამუხრუჭო დისკოები სატრანსპორტო საშუალებებისთვის; სამუხრუჭო ხუნდები სატრანსპორტო საშუალებებისთვის; დაკიდების სისტემები და ნაწილები სატრანსპორტო საშუალებების დაკიდების სისტემისთვის, კერძოდ, ბურთულა სახსრები, მილისები, მილისების ნაკრები, მართვის ბერკეტები, სპირალური ზამბარები, ზამბარიანი საამორტიზაციო დგარი და საყრდენები, განივი მდგრადობის და წვეადობის სტაბილიზატორები; საჭის მართვის სისტემები და ნაწილები სატრანსპორტო საშუალებების საჭის მართვის სისტემებისთვის, კერძოდ, საჭის ლარტყები, საჭის საწვევის ბუნიკები, საწვეები, მილისები, სიფონები, ქანქარა ბერკეტი, სტაბილიზატორების კომპლექტები, შიგა მილისები და საჭის ჭიღოები; კომპიუტერული პროგრამული უზრუნველყოფა, რომელიც გამოიყენება ძრავის ფუნქციების სამართავად, წვის საკონტროლოდ, მანქანის მუშაობის ასახვის და გამონაბოლქვის კონტროლის ჩათვლით; აირისა და აირისებრი საწვავის ავზები სახმელეთო სატრანსპორტო საშუალებებისთვის. კომპიუტერული პროგრამა, რომელიც გამოიყენება მანქანის ფუნქციების სამართავად.

(260) AM 2023 121133 A

(210) AM 121133

(220) 2023 01 10

(731) შპს „სტუდია ველოსიპედი“

გლდანი, VI მკრ., კორპ. 20, ბ. 81, 0107, თბილისი, საქართველო

(740) ზურაბ ბეჟაშვილი;

იოანე იარაჯული;

ლია შიხიაშვილი

(540)



აიჩაჰი აოზაჰინა

(591) შავი, თეთრი, ყვითელი, ნარინჯისფერი,

წითელი, ლურჯი, იასამნისფერი

(531) 03.02.09; 03.02.25; 28.19; 29.01.15

(511)

5 – ფარმაცევტული, სამედიცინო და ვეტერინარული პრეპარატები; სამედიცინო დანიშნულების ჰიგიენური პრეპარატები; სამედიცინო ან ვეტერინარული გამოყენებისთვის ვარგისი დიეტური საკვები და ნივთიერებები, საკვები ჩვილებისთვის; დიეტური დანამატები ადამიანებისა და ცხოველებისთვის; ლეიკოპლასტირი, სახვევი მასალა; კბილების დასამაგრებელი მასალა, სტომატოლოგიური ცვილი; სადეზინფექციო საშუალებები; მავნე მწერების გასანადგურებელი პრეპარატები, ფუნგიციდები, ჰერბიციდები.

9 – სამეცნიერო, საკვლევო, სანავიგაციო, გეოდეზიური, ფოტოგრაფიული, კინემატოგრაფიული, აუდიოვიზუალური, ოპტიკური, აწონის, გაზომვის, სიგნალიზაციის, გამოსავლენი, ტესტირების, სამაშველო და სასწავლო აპარატურა და ინსტრუმენტები; აპარატურა და ინსტრუმენტები ელექტრობის გადაცემის, გადართვების, გარდაქმნის, დაგროვების, განაწილების ან გამოყენების რეგულირების ან მართვისთვის; აპარატურა და ინსტრუმენტები ხმის ან გამოსახულების ჩაწერის, გადაცემის, აღწარმოების ან დამუშავებისთვის; მონაცემების მაგნიტური მატარებლები, ჩასაწერი დისკები, ციფრული ან ანალოგიური ჩამწერი ან დამმასხოვრებლები; მონეტებზე მომუშავე აპარატების მექანიზმები, სალარო აპარატები, მთვლელი მოწყობილობები; კომპიუტერები და კომპიუტერის პერიფერიული მოწყობილობები; მყვინთავის სამოსი, მყვინთავის ნიღბები, მყვინთავის ყურსაცობები, ცხვირის სამაგრები მყვინთავებისა და მოცურავეებისთვის, მყვინთავის ხელთათმანები,

სასუნთქი აპარატურა წყალქვეშა ცურვისთვის; ცეცხლმქრობი მოწყობილობები.

16 – ქაღალდი და მუყაო; ნაბეჭდი მასალა; საამკინძაო მასალა; ფოტოფირები; საკანცელარიო და საოფისე საკუთვნო, ავეჯის გარდა; საკანცელარიო და საყოფაცხოვრებო დანიშნულების წებოები; მხატვრების საკუთვნო და სახატავი მასალა; სახატავი ფუნჯები; სასწავლო და სადემონსტრაციო მასალა; პლასტმასის ფურცლები, ფირები და ტომრები, როგორც შესაფუთი მასალა; ტიპოგრაფიული შრიფტები, ტიპოგრაფიული კლიშეები.

21 – საოჯახო ან სამზარეულოს ნივთები და ჭურჭელი; სამზარეულოს და სუფრის ჭურჭლეულობა, დანების, ჩანგლების და კოვზების გარდა; ჯაგრისები და ღრუბლები; ფუნჯები, სამხატვრო ფუნჯების გარდა; ჯაგრისის დასამზადებელი მასალა; საწმენდი საგნები; დაუმუშავებელი და ნახევრადამუშავებული შუშა, სამშენებლო შუშის გარდა; შუშის, ფაიფურის და კერამიკის (თიხის) ნაწარმი.

24 – ქსოვილები და მათი შემცვლელები; საოჯახო თეთრეული; ფარდები, ქსოვილის ან პლასტმასის.

25 – ტანსაცმელი, ფეხსაცმელი, თავსაბურავი.

27 – ხალიჩები, ფარდაგები, ჭილოფები, საჭილოფე მასალა, ლინოლეუმი და იატაკის საფარი სხვა მასალა; გობელენები, არაქსოვილური.

28 – თამაშობები, სათამაშოები და სათამაშო საგნები; ვიდეო-თამაშების აპარატურა; ტანვარჯიშისა და სპორტის საკუთვნო; საშობაო ნაძვისხის მოსართავები.

29 – ხორცი, თევზი, ფრინველი და ნანადირევი; ხორცის ექსტრაქტები; დაკონსერვებული, გაყინული, გამხმარი და მოხარშული ან შემწვარი ხილი და ბოსტნეული; ყელეები, ხილფაფები, კომპოტები; კვერცხი; რძე, ყველი, კარაქი, იოგურტი და რძის სხვა პროდუქტები; საკვები ზეთები და ცხიმები.

30 – ყავა, ჩაი, კაკაო და ყავის შემცვლელები; ბრინჯი, მაკარონი და ატრია; ტაპიოკა და საგო; ფქვილი და მარცვლეულის პროდუქტი; პურფუნთუშეული, მაკარონი და საკონდიტრო ნაწარმი; შოკოლადი; ნაყინი, შარბათი და სხვა საკვები ყინული; შაქარი, თაფლი, ბადაგი; საფუარი, საცხობი ფხვნილები; მარილი, სანელებლები, საკმაზები, დაკონსერვებული მწვანილი;

მმარი, საწებლები და სხვა საკმაზი; ყინული (გაყინული წყალი).

32 – ლუდი; არაალკოჰოლური სასმელები; მინერალური და გაზიანი წყლები; ხილის სასმელები და წვენები; სიროფები და სხვა არაალკოჰოლური შედგენილობები სასმელების დასამზადებლად.

35 – რეკლამა; ბიზნესის მართვა; ბიზნესის ადმინისტრირება; საოფისე მომსახურება.

41 – განათლება; სასწავლო პროცესის უზრუნველყოფა; გართობა; სპორტული და კულტურული ღონისძიებები.

(260) AM 2023 121134 A

(210) AM 121134

(220) 2023 01 10

(731) შპს „აიდიეს ბორჯომი ბევერიჯიზ კომპანი“

პარერავეგის 45, კურასაო

(740) გიორგი ჯოხარიძე

(540)



(591) წითელი, ღია მწვანე, მუქი ლურჯი, მწვანე, მუქი ოქროსფერი, თეთრი, ნაცრისფერი

(531) 01.03.02; 01.03.09; 01.03.12; 01.03.15; 01.03.18; 06.01.02; 06.03.11; 06.03.14; 06.03.20; 25.01.25; 29.01.15

(511)

32 – მინერალური წყლები, არაალკოჰოლური სასმელები.

35 – რეკლამა.

(260) AM 2023 121135 A
(210) AM 121135
(220) 2023 01 10
(731) შპს „აიდიეს ბორჯომი ბევერიჯიზ კომპანი“
პარერავეგის 45, კურასაო
(740) გიორგი ჯოხარიძე
(540)



(591) ნაცრისფერი, თეთრი, წითელი, ღია მწვანე, მუქი ოქროსფერი, მუქი ლურჯი, მწვანე
(531) 03.04.07; 03.04.14; 05.03.13; 05.03.15; 06.01.02; 06.01.04; 06.19.01; 25.07.01; 25.07.07; 25.07.15
(511)
32 – მინერალური წყლები, არაალკოჰოლური სასმელები.
35 – რეკლამა.

(260) AM 2023 121136 A
(210) AM 121136
(220) 2023 01 10
(731) შპს „აიდიეს ბორჯომი ბევერიჯიზ კომპანი“
პარერავეგის N45, კურასაო
(740) გიორგი ჯოხარიძე
(540)



(591) ნაცრისფერი, მუქი ლურჯი, წითელი, მუქი ოქროსფერი, თეთრი, ღია მწვანე, მწვანე

(531) 01.03.01; 01.03.15; 01.15.15; 05.03.14; 05.03.15; 05.03.16; 06.01.02; 25.07.01; 25.07.08; 26.01.01; 29.01.15
(511)
32 – მინერალური წყლები, არაალკოჰოლური სასმელები.
35 – რეკლამა.

(260) AM 2023 121137 A
(210) AM 121137
(220) 2023 01 10
(731) ჯონტ სტოკ კომპანი „ჰალიფარმ“
ობრიშვივსკა სტრ., 6/8, ლვოვი, 79024, უკრაინა
(740) შალვა გვარამაძე
(540)

ТИОЦЕТАМ THIOSETAM

(591) შავ-თეთრი
(511)
5 – მედიკამენტები ადამიანებისათვის; ფარმაცევტული პრეპარატები.

(260) AM 2023 121138 A
(210) AM 121138
(220) 2023 01 10
(731) ჯონტ სტოკ კომპანი „ჰალიფარმ“
ობრიშვივსკა სტრ., 6/8, ლვოვი, 79024, უკრაინა
(740) შალვა გვარამაძე
(540)

ТИОТРИАЗОЛИН THIOTRIAZOLIN

(591) შავ-თეთრი
(511)
5 – მედიკამენტები ადამიანებისათვის; ფარმაცევტული პრეპარატები.

(260) AM 2023 121139 A
(210) AM 121139
(220) 2023 01 10
(731) დავით დვალისვილი
ლენინგრადის გამზ. 66, კორპ. 2, ბ. 7, მოსკოვი, რუსეთის ფედერაცია
(740) დალი ხუბუა

(540)



(591) კრემისფერი, მწვანე, ყავისფერი

(531) 05.07.06; 19.03.01; 29.01.13

(511)

29 – ხორცი, თევზი, ფრინველი და ნანადირევი; ხორცის ექსტრაქტები; დაკონსერვებული, გამხმარი და თბურად დამუშავებული ბოსტნეული და ხილი; ჟელე, მურაბა, კომპოტი; კვერცი, რძე და რძის ნაწარმი; ზეთები და საკვები ცხიმები.

31 – სოფლის მეურნეობის, ბაღჩა-ბაღისა და ტყის პროდუქტები და მარცვლეული, რომელიც არ მიეკუთვნება სხვა კლასებს; ცოცხალი ცხოველები; ცოცხალი ხილი და ბოსტნეული; თესლეული, ცოცხალი მცენარეები და ყვავილები; ცხოველთა საკვები; ალაო.

35 – რეკლამა; მართვა საქმიან სფეროში; ადმინისტრირება საქმიან სფეროში; საოფისე სამსახური.

(260) AM 2023 121212 A

(210) AM 121212

(220) 2023 01 13

(731) ნატალია ბერეჟინი

კანევესკაიას სტანიცა, კანევესკი რაიონი,

ულიცა სპორტივნიია, დომ N15,

კრასნოდარის მხარე, რუსეთის ფედერაცია

(740) ნაირა ბადალიანი

(540)

ALORA

(591) შავ-თეთრი

(511)

29 – ხორცი, თევზი, ფრინველი და ნანადირევი; ხორცის ექსტრაქტები; დაკონსერვებული, გაყინული, გამხმარი და მოხარშული ან შემწვარი ხილი და ბოსტნეული; ჟელეები, ხილფაფები, კომპოტები; კვერცი; რძე, ყველი, კარაქი, იოგურტი და რძის სხვა პროდუქტები; საკვები ზეთები და ცხიმები.

30 – ყავა, ჩაი, კაკაო და ყავის შემცველები; ბრინჯი, მაკარონი და ატრია; ტაპიოკა და საგო; ფქვილი და მარცვლეულის პროდუქტი; პურფუნთუშეული, მაკარონი და საკონდიტრო ნაწარმი; შოკოლადი; ნაყინი, შარბათი და სხვა საკვები ყინული; შაქარი, თაფლი, ბადაგი; საფურარი, საცხობი ფხვნილები; მარილი, სანელებლები, საკმაზები, დაკონსერვებული მწვანილი; ძმარი, საწებლები და სხვა საკმაზი; ყინული (გაყინული წყალი).

(260) AM 2023 121216 A

(210) AM 121216

(220) 2023 01 14

(731) ქეჯიანგ სიეფმოტო ფაუერ კო., ლტდ 116 ვუჟოუ როუდ, იუჰანგ ეკონომიკ დეველოპმენტ ზოუნ, ჰანგჟოუ 311100 ქეჯიანგ პროვინს, ჩინეთის სახალხო რესპუბლიკა

(740) გიორგი ქართველიშვილი

(540)



(591) შავ-თეთრი

(531) 24.17.09; 24.17.25; 26.11.08; 26.11.09;

27.05.22

(511)

12 – ხმელეთზე, წყალში, ჰაერში და რელსებზე გადასაადგილებელი სატრანსპორტო საშუალებები; პნევმატური საბურავები; ავტომობილის სპოილერები; მოტორიანი სკუტერები; ელექტრომძრავიანი სატრანსპორტო საშუალებები; მოტოციკლეტის ჩონჩხი/კარკასი; ელექტრომძრავები სახმელეთო სატრანსპორტო საშუალებებისათვის; მოტოციკლეტის დასაჯდომები; სატრანსპორტო საშუალებების თვლის მორგებები; ძრავები სახმელეთო სატრანსპორტო საშუალებებისათვის; მოტოციკლები; ელექტრო მოტოციკლები; ელექტრო ველოსიპედები.

(260) AM 2023 121245 A

(210) AM 121245

(220) 2023 01 19

(731) შპს „რენოვერ საქართველო“

პ. ქავთარაძის მესამე შესახ. 5, ბ. 37, 0186,

თბილისი, საქართველო

(540)

GARDEX

(591) 111010 შავი, თეთრი, ნარინჯისფერი

(531) 27.05.01; 29.01.12

(511)

8 – ხელის იარაღები და ხელის ინსტრუმენტები; მჭრელი იარაღები; პირადი იარაღი, ცეცხლსასროლი იარაღის გარდა; სამართებლები.

20 – ავეჯი, სარკეები, სურათის ჩარჩოები; არალითონური კონტეინერები, დასაწყობების ან ტრანსპორტირებისთვის; დაუმუშავებელი ან ნახევრადამუშავებული ძვლები, რქები, ვეშაპის უღვაში და სადაფი; ნიჟარები; სეპიოლიტი (ზღვის ქაფი, ხვირთქლი); ყვითელი ქარვა.

22 – თოკები და თასმები; ბადეები; კარვები და ბრეზენტები; ქსოვილის ან სინთეტიკური მასალის ტენტები; იალქნები, აფრები; ტომრები დიდი მოცულობის მასალის დასაწყობებისა და ტრანსპორტირებისთვის; ვატინა, საბალიშე და სატენი მასალა ქაღალდის, მუყაოს, რეზინის ან პლასტმასის მასალის გარდა; დაუმუშავებელი ბოჭკოვანი საფეიქრო მასალა და მათი შემცვლელი.

28 – თამაშობები, სათამაშოები და სათამაშო საგნები; ვიდეო-თამაშების აპარატურა; ტანვარჯიშისა და სპორტის საკუთვნო; საშობაო ნამცის ხის მოსართავები.

35 – რეკლამა; ბიზნესის მართვა; ბიზნესის ადმინისტრირება; საოფისე მომსახურება.

(260) AM 2023 121246 A

(210) AM 121246

(220) 2023 01 20

(731) ნეიშნლ პეინტს ჰოლდინგს ლტდ დუბაი ინტერნეშნლ ფაინენშლ სენტრ/ გეიტ ვილიჯ ბილდინგ 4/ ლეველ 3/ იუნიტ 5, დუბაი, არაბთა გაერთიანებული საამიროები

(540)



(591) შავ-თეთრი

(531) 05.05.20; 27.05.01; 27.05.22; 27.05.23

(511)

2 – საღებავები.

(260) AM 2023 121247 A

(210) AM 121247

(220) 2023 01 20

(731) ნეიშნლ პეინტს ჰოლდინგს ლტდ დუბაი ინტერნეშნლ ფაინენშლ სენტრ/ გეიტ ვილიჯ ბილდინგ 4/ ლეველ 3/ იუნიტ 5, დუბაი, არაბთა გაერთიანებული საამიროები

(540)



(591) შავ-თეთრი

(531) 26.11.08; 26.11.11; 27.05.11

(511)

2 – საღებავები.

(260) AM 2023 121301 A

(210) AM 121301

(220) 2023 01 20

(731) შპს „კახური ტრადიციული მეღვინეობა“ სულხან ცინცაძის ქ. 12, მე-3 სართ., არასაცხოვრებელი ფართი 3-6, 0160, თბილისი, საქართველო

(540)



(591) ოქროსფერი, თეთრი

(531) 27.05.03; 27.05.23; 29.01.02

(511)

35 – რეკლამა; ბიზნესის მართვა; ბიზნესის ადმინისტრირება; საოფისე მომსახურება.

(260) AM 2023 121303 A

(210) AM 121303

(220) 2023 01 20

(731) შპს „ღვინის კომპანია შუმი“ ლიონიძის ქ. 33, თელავი, საქართველო

(740) შალვა გვარამაძე
(540)

Gestalt
გემტალტი
Гештальт

(591) შავ-თეთრი
(511)
33 – ალკოჰოლიანი სასმელები (ლუდის გარდა).

(260) AM 2023 121304 A

(210) AM 121304

(220) 2023 01 20

(731) შპს „ღვინის კომპანია შუმი“
ლიონიძის ქ. 33, თელავი, საქართველო

(740) შალვა გვარამაძე
(540)

კირკე
Circe
Кирка

(591) შავ-თეთრი
(511)
3 – პარფიუმერია.

(260) AM 2023 121305 A

(210) AM 121305

(220) 2023 01 20

(731) შპს „ღვინის კომპანია შუმი“
ლიონიძის ქ. 33, თელავი, საქართველო

(740) შალვა გვარამაძე
(540)

შუმი
SHUMI
ШУМИ

(591) შავ-თეთრი
(511)
34 – თამბაქო და თამბაქოს შემცველები; სიგარეტები და სიგარები; ელექტრონული სიგარეტები და პირის აეროზოლები მწველთათვის; მწველთა საკუთვნო; ასანთი.

(260) AM 2023 121324 A

(210) AM 121324

(220) 2023 01 24

(731) შპს „ვინფაქ პროფესიონალ“
უნივერსიტეტის ქ. 24, სად. 4, სართ. 7,
ბ. 173, 0186, თბილისი, საქართველო

(540)



(591) თეთრი, ლურჯი

(531) 26.04.02; 26.04.22; 26.04.24; 27.05.01;
27.05.24; 29.01.12

(511)

3 – კოსმეტიკური და საპირფარეშო პრეპარატები (არასამკურნალო); მათეთრებელი პრეპარატები და სხვა სარეცხი ნივთიერებები; წმენდის, გაპრიალების, გაუცხიმოვნებისა და აბრაზიული დამუშავების პრეპარატები; პარფიუმერია, ეთერზეთები; კბილის პასტები (არასამკურნალო).

16 – ქაღალდი და მუყაო; ნაბეჭდი მასალა; საამკინძო მასალა; ფოტოფირები; საკანცელარიო და საოფისე საკუთვნო, ავეჯის გარდა; საკანცელარიო და საყოფაცხოვრებო დანიშნულების წებოები; მხატვრების საკუთვნო და სახატავი მასალა; სახატავი ფუნჯები; სასწავლო და სადემონსტრაციო მასალა; პლასტმასის ფურცლები, ფირები და ტომრები, როგორც შესაფუთი მასალა; ტიპოგრაფიული შრიფტები, ტიპოგრაფიული კლიშეები.

17 – დაუმუშავებელი და ნახევრადდამუშავებული რეზინი, გუტაპერჩი, გუმფისი, აზბესტი, ქარსი და ყველა ამ მასალის შემცველები; პლასტმასები და რეზინი დაპრესილი ფორმით წარმოებაში გამოსაყენებლად; დასაგმანი, შემაკავებელი და საიზოლაციო მასალა; არალითონური დრეკადი მილები და შლანგები.

(260) AM 2023 121325 A

(210) AM 121325

(220) 2023 01 24

(731) შპს „ბი თი ეი ჯორჯია“
აეროპორტი, ისანი-სამგორის რაიონი,
თბილისი, საქართველო

(740) შალვა გვარამაძე

(540)



(591) სხვადასხვა ტონის ყავისფერი, მუქი ლურჯი, თეთრი

(531) 25.07.15; 26.04.02; 26.04.06; 26.04.09; 26.04.24; 26.11.07; 27.01.12; 27.05.01; 27.05.24; 29.01.13

(511)

43 – მომსახურება საკვების და სასმელის მიწოდებაში; მომსახურება დროებითი საცხოვრებელი უზრუნველყოფაში.

(260) AM 2023 121326 A

(210) AM 121326

(220) 2023 01 24

(731) შპს „ბი თი ეი ჯორჯია“

აეროპორტი, ისანი-სამგორის რაიონი, თბილისი, საქართველო

(740) შალვა გვარამაძე

(540)



(591) ცისფერი, ნარინჯისფერი, თეთრი

(531) 26.01.12; 27.01.01; 27.01.06; 27.05.17; 29.01.13

(511)

35 – რეკლამა, მარკეტინგი და საზოგადოებრივი ურთიერთობის სფეროში გაწეული მომსახურება; გამოფენებისა და სავაჭრო ბაზრობების ორგანიზება კომერციული ან სარეკლამო მიზნებისთვის; საოფისე მომსახურება; სამდივნო მომსახურება; გაზეთებზე ხელმოწერების ორგანიზება მესამე პირთათვის; სტატისტიკური მონაცემების შეგროვება; საოფისე მანქანა-აპარატურის გაქირავება; ინფორმაციის სისტემატიზაცია კომპიუტერულ მონაცემთა ბაზებში; სატელეფონო ზარებზე მოპასუხის მომსახურება მიუწვდომელი აბონენტებისთვის; ბიზნესის მენეჯმენტი, ბიზნესის ადმინისტრირება და კონსულტაციები ბიზნესის სფეროში; საბუღალტრო აღრიცხვა; მომსახურება კომერციული კონსულ-

ტაციების სფეროში; პერსონალის დაკომპლექტება, პერსონალის დასაქმება, დასაქმების სააგენტოების მომსახურება, იმპორტ-ექსპორტის სააგენტოები; მომსახურება პერსონალის დროებითი დასაქმების სფეროში; აუქციონით მომსახურება; სხვათა სასარგებლოდ შემდეგი სხვადასხვა საქონლის თავმოყრა, სახელდობრ, ხმისა და გამოსახულების ჩამწერი, გადამცემი და აღწარმოებისთვის აპარატურის კამერების, ფოტოკამერების, სატელევიზიო აპარატურის, ვიდეო ჩამწერების, CD და DVD ფლეიერების და ჩამწერების, MP3 ფლეიერების, კომპიუტერების, დესკტოპ კომპიუტერების, პლანშეტური კომპიუტერების, მიკროფონების, ხმამალამო-ლაპარაკების, ყურსასმენების, სატელეკომუნიკაციო აპარატურის, ხმის ან გამოსახულების აღწარმოების აპარატურის, კომპიუტერის პერიფერიული მოწყობილობების, ფიჭური ტელეფონების, დამცავი სახურავების ფიჭური ტელეფონებისთვის, ტელეფონის აპარატების, კომპიუტერის პრინტერების, სკანერების [მონაცემთა დამუშავების მოწყობილობა], ფოტოასლების გადამღები მოწყობილობების, სათვალეების, მზის სათვალეების (2x), ოპტიკური ლინზების და ბუდეების, კონტეინერების, მათი ნაწილების და კომპონენტების, დეკორატიული მაგნიტების, საწოლის ელექტრო გამათბობლების და ელექტრო საბნების, არასამედიცინო გამოყენებისთვის, ბალიშის ელექტროგამათბობლების, ფეხის ელექტრო ან არაელექტრული გამათბობლების, ცხელი წყლის ბოთლების, საიუველირო ნაწარმის, საიუველირო ნაწარმის იმიტაციების (ბიჟუტერია), ოქროს, ძვირფასი ქვების და მათგან დამზადებული საიუველირო ნაწარმის, მანქეტების საკინძების, ჰალსტუხების ქინძისთავების, ქანდაკებების და მცირე ზომის ქანდაკებების დამზადებული ძვირფასი ლითონისგან, საათების, მაჯის საათების და ქრონომეტრული ინსტრუმენტების, ქრონომეტრების და მათი ნაწილების, მაჯის საათის სამაჯურების, მუსიკალური ინსტრუმენტების და ბუდეების მუსიკალური ინსტრუმენტებისთვის, ქაღალდის და მუყაოს, ქაღალდის და მუყაოს შეხვევის და გადახვევის მიზნებისათვის, მუყაოს ყუთების, ქაღალდის პირსახოცების, ტუალეტის ქაღალდის, ქაღალდის ხელსახოცების, ბეჭდვითი გამოცემების, ნაბეჭდი მასალის, წიგნების, ჟურნალების, გაზეთების, საბუღალტრო (ანგარიშების) წიგნების, დაბეჭდილი ზედნადებების, დაბეჭდილი ვაუჩერების, კალენდრების, პლაკატების, ფოტოების [ამობეჭდილი], ნახატების, სტიკერების, თვითწებვადი

სტიკერების [საკანცელარიო]; საფოსტო მარკების, საკანცელარიო ნივთების, საოფისე საკანცელარიო ნივთების, საგანმანათლებლო-აღმზრდელობითი და სასწავლო მასალის [გარდა ავეჯისა და აპარატურისა], საწერი და სახატავი ხელსაწყოების, მხატვრების მასალების, ქაღალდის ნაწარმის საკანცელარიო მიზნებისათვის, წებოების საკანცელარიო მიზნებისათვის, კალმისტრების, ფანქრების, საშლელების, წებოვანი ლენტების საკანცელარიო მიზნებისათვის, მუყაოს დაფების [მასალა მხატვრებისთვის], საწერი ქაღალდის, ასლის გადასადები ქაღალდის, ქაღალდის რულონების სალარო აპარატებისთვის, სახაზავი მასალების, ცარცის დაფების, სახატავი ფანქრების, აკვარელების [ნახატები], როზარიების, ქოლგების, მზის ქოლგების ქაღალდისათვის (parasols), მზის ქოლგების, სასეირნო ხელჯოხების, ტყავისგან, ტყავის იმიტაციებისგან ან სხვა მასალისგან დამზადებული საქონლის, განკუთვნილი ნივთების სატარებლად, ჩანთების, საფულეების, ყუთების და ჩემოდნების ტყავის ან მტკიცე ტყავისგან დამზადებული, გასადების ბუდეების, ჩემოდნების [ბარგი], ტანსაცმლის ჩანთების, სარკეების, საინფორმაციო ტაბლოების, სურათების და ნახატების ჩარჩოების, საიდენტიფიკაციო ფირების, საიდენტიფიკაციო იარაღების, სახელობითი ფირების, საიდენტიფიკაციო ეტიკეტების ხისგან ან სინთეზური მასალისგან დამზადებული, ხის, კორპის, ლელქაშის, ლერწმის, წნელის, რქის, ძვლის, სპილოს ძვლის, ვეშაპის უღვაშის, ნიჟარის, ქარვის, მარგალიტის, ზღვის ხვრთქლის, ფუტკრის ცვილის თაბაშირის ან პლასტმასისგან დამზადებული ორნამენტების და დეკორატიული საქონლის; მცირე ზომის ქანდაკებების, კედლების მოსართავი სადღესასწაულო ორნამენტების და სკულპტურების, ყველა დამზადებული ხისგან, კორპისგან, ლელქაშისგან, ლერწმისგან, წნელისგან, რქისგან, ძვლისგან, სპილოს ძვლისგან, ვეშაპის უღვაშისგან, ნიჟარისგან, ქარვისგან, მარგალიტისგან, ზღვის ხვრთქლისგან, ფუტკრის ცვილისგან, თაბაშირისა და პლასტმასისგან, ორნამენტების და დეკორატიული საქონლის დამზადებული მინისაგან, ფაიფურისაგან, კერამიკისაგან ან თიხისგან, სახელდობრ, სკულპტურების, მცირე ზომის ქანდაკებების და ვაზების, ყველა დამზადებული მინისაგან, ფაიფურისაგან, კერამიკისაგან ან თიხისგან, თამაშების და სათამაშოების, ხორცის, თევზის, ფრინველის და ნანადირევის, დამუშავებული ხორც-პროდუქტების, გამხმარი პარკოსნების, სუპების, ბულიონის, დამუშავებული

ბული ზეთისხილის, ზეთისხილის პასტის, რძის და რძის პროდუქტების, კარაქის, საკვები ზეთების, გამხმარი, დაკონსერვებული, გაყინული, მოხარშული, შებოლილი ან დამარილებული ხილის და ბოსტნეულის, ტომატის პასტის, მზა თხილის და გამხმარი ხილის საუზმეულის სახით, თხილის სპრედების და არაქისის კარაქის, ტაჰინის [სეზამის თესლის პასტა], კვერცხის და კვერცხის ფხვნილის, კარტოფილის ჩიფსების, ყავის, კაკაოს, ყავის ან კაკაოს ფუძეზე დამზადებული სასმელების, შოკოლადის ფუძეზე დამზადებული სასმელების, მაკარონის, ცომის გუფთების შიგთავსით, ატრიას, საკონდიტრო ნაწარმის და პურ-ფუნთუშეული პროდუქტების ფქვილის ფუძეზე დამზადებული, დესერტები დამზადებული ფქვილისა და შოკოლადის ფუძეზე, პურის, სიმიტის [თურქული რგოლისებრი ბლითები დაფარული სეზამის მარცვლებით], პოგაჩას [თურქული ბლითები], პიტას, სენდვიჩების, კატმერის [თურქული ცომი], ღვეზელების, ნამცხვრების, ბაქლავას [თურქული დესერტი დამზადებული ვაჟინით დაფარულ ცომის ფუძეზე], კადაიფის [თურქული დესერტი დამზადებული ცომის ფუძეზე], დესერტების ვაჟინით დაფარული ცომის ფუძით], პუდინგების, მოხარშული კრემის, კაზანდიბის [თურქული პუდინგი], ბრინჯის პუდინგის, კესკულის [თურქული პუდინგი], თაფლის, დინდგელას, სკის წებოს ადამიანის მოხმარებისთვის, პროპოლისის საკვები მიზნებისათვის, საკაზმების საკვები პროდუქტებისთვის, ვანილის [არომატიზატორები], საწებლებების, საწებლების [საკაზმები], ტომატის საწებლების, საფუარის, საცხობი ფხვნილების, ფქვილის, მანანის ბურღულის, სახამებლის საკვებისთვის, შაქრის, შაქრის კუბების, შაქრის ფხვნილის, ჩაის, ყინულოვანი ჩაის, საკონდიტრო ნაწარმის, შოკოლადის, ბისკვიტების (ორცხობილები), კრეკერების, ვაფლების, რაჰათლუკუმის, სადეჰი რეზინების, ნაყინის, საკვები ყინულების, მარილის, მარცვლეულის ფუძეზე დამზადებული წასახემსებლების, ბატიბუტის, დაღერდილი შვრიას, სიმინდის ჩიფსების, საუზმისათვის მარცვლოვნების, დამუშავებული ხორბლის ადამიანის მოხმარებისთვის, დაღერდილი ქერის ადამიანის მოხმარებისათვის, დამუშავებული შვრიის ადამიანის მოხმარებისთვის, დამუშავებული ჭვავის ადამიანის მოხმარებისთვის, ბრინჯის, მელასას (შავი ზადაგი) საკვებისათვის, სასოფლო-სამეურნეო და მეზღობა-მეზოსტნეობის პროდუქტების, თესლების, ტყის პროდუქტების, ცოცხალი ცხოველების, დაპეკლილი

კვერცხების წიწილების გამოსაჩეკად, მცენარეების, მოსართავის გამხმარი მცენარეების, ბალის ცოცხალი მწვანილის, მოსართავის ბალის გამხმარი ბალახების, ცხოველების საკვების, ალას, რომელიც არ არის ადამიანის მოხმარებისთვის განკუთვნილი, სხვადასხვა სახის ლუდის, ლუდის დასამზადებელი პრეპარატების, მინერალური წყლის, წყაროს წყლის, სუფრის წყლის, სოდიანი წყლის, ხილისა და ბოსტნეულის წვენების, ხილისა და ბოსტნეულის კონცენტრატების და ექსტრაქტების სასმელების დასამზადებლად, უალკოჰოლო გამაგრილებელი სასმელების, ენერგეტიკული სასმელების, ალკოჰოლური სასმელების [ლუდის გარდა], ღვინის, რაკის [ტრადიციული თურქული ალკოჰოლური სასმელი], ვისკის, ლიქიორების, ალკოჰოლური კოქტეილების, თამბაქოს, საღეჭი თამბაქოს, სიგარეტების, სიგარეტის, მწველთა საკუთვნილების, მათ შორის, საკუთვნილების დამზადებული ძვირფასი ლითონებისგან, მილაკების (ჩიბუხები), სატუჩების სიგარეტისა და სიგარეტებისთვის, საფერფლებების, თამბაქოს ყუთების, სიგარეტის დასახვევი ჯიბის მოწყობილობა-აპარატების, სიგარეტის ქაღალდის, თამბაქოს ჩიბუხების, კაჟის სანთებლისათვის, სანთებლების მწვევლებისთვის, სანათების, რაც მომხმარებელს საშუალებას აძლევს მოხერხებულად დაათვალიეროს და შეიძინოს ეს საქონელი, ასეთი მომსახურებები შეიძლება უზრუნველყოფილი იქნეს საცალო ვაჭრობის მაღაზიებით, საბითუმო ვაჭრობის მაღაზიებით, ელექტრონული მედიის საშუალებით ან საფოსტო შეკვეთების კატალოგების საშუალებით.

43 – მომსახურება საკვებისა და სასმელის მიწოდებაში; მომსახურება დროებითი საცხოვრებელი უზრუნველყოფაში; მომსახურება დღის ბაღებით ბავშვებისთვის; მომსახურება ცხოველთა პანსიონებში.

- (260) AM 2023 121327 A
- (210) AM 121327
- (220) 2023 01 24
- (731) შპს „ბი თი ეი ჯორჯია“
აეროპორტი, ისანი-სამგორის რაიონი,
თბილისი, საქართველო
- (740) შალვა გვარამაძე

(540)



- (591) ცისფერი, ნარინჯისფერი, თეთრი
- (531) 26.11.12; 27.05.11; 27.05.17; 29.01.12
- (511)
- 35 – საოფისე მომსახურება; ბიზნეს მენეჯმენტი, ბიზნესის ადმინისტრირება და კონსულტაციები ბიზნესის სფეროში; საბუღალტრო აღრიცხვა; საკონსულტაციო მომსახურება კომერციის სფეროში; საექსპერტო მომსახურება კომერციული და სამრეწველო პროდუქციებისათვის; აუქციონით მომსახურება.
- 43 – მომსახურება საკვებისა და სასმელის მიწოდებაში.

- (260) AM 2023 121328 A
- (210) AM 121328
- (220) 2023 01 24
- (731) შპს „ბი თი ეი ჯორჯია“
აეროპორტი, ისანი-სამგორის რაიონი,
თბილისი, საქართველო
- (740) შალვა გვარამაძე
- (540)



- (591) შავი, რუხი, თეთრი, ყვითელი, წითელი
- (531) 17.01.02; 17.01.08; 17.05.01; 17.05.17;
26.05.01; 26.05.22; 26.05.24; 27.05.24
- (511)
- 16 – ქაღალდი და მუყაო; ქაღალდი და მუყაო შესაფუთი და გასახვევი მიზნებისათვის, მუყაოს ყუთები; ქაღალდის პირსახოცები; ტუალეტის ქაღალდი; ქაღალდის ხელსახოცები; პლასტმასის მასალები შესაფუთი და გასახვევი მიზნებისათვის; ტიპოგრაფიული კლიშეები და შრიფტები; საამკინძაო მასალა; ნაბეჭდი მასალა; ბეჭდვითი გამოცემები; კალენდრები; აფიშები,

პლაკატები; ფოტოსურათები (ამობეჭდილი); ნახატები; თვითწებავადი სტიკერები [საკანცელარიო]; საფოსტო მარკები; საკანცელარიო ნივთები, საოფისე საკანცელარიო ნივთები, საგანმანათლებლო-აღმზრდელობითი და სასწავლო მასალა [გარდა ავეჯისა და აპარატურისა], საწერი და სახატავი ხელსაწყოები; მხატვრების მასალები; ქაღალდის ნაწარმი საკანცელარიო მიზნებისათვის, წებოები საკანცელარიო მიზნებისთვის; ოფისის საკუთვნობები; საღებავი ლილვაკები და სახატავი ფუნჯები ხატვისთვის; როზარიები.

21 – ხელით სამართავი არაელექტრო საწმენდი ინსტრუმენტები, ფუნჯები, გარდა სახატავი ფუნჯებისა, ფოლადის ბურბუშელა წმენდისათვის, ღრუბლები წმენდისათვის, ფოლადის ნექა წმენდისათვის, ტექსტილის ქსოვილები წმენდისთვის, ხელთათმანები ჭურჭლის რეცხვისთვის, არაელექტრო გასაპრიალებელი მანქანები საყოფაცხოვრებო მიზნებისთვის, ცოცხები ხალიჩებისთვის, შვებრები, ელექტრო ჯაგრისები, გარდა მანქანების ნაწილებისა; კბილის ჯაგრისები, კბილის ელექტროჯაგრისები, კბილების გასაწმენდი ძაფები, საპარსი ჯაგრისები, თმის ჯაგრისები, სავარცხლები; არაელექტრო საყოფაცხოვრებო ან სამზარეულოს ჭურჭლეული, რომელიც შედის ამ კლასში, ტანსაცმლის სამაგრები, ქოთნები, ქვაბები და ტაფები; საუთო დაფები და მათი მორთული გადასაფარებლები, გასაშრობი თაროები სარეცხისთვის, ტანსაცმლის გასაშრობი საკიდები; გალიები ოთახის ცხოველებისთვის, ოთახის აკვარიუმები, ტერარიუმები და ვივარიუმები ცხოველებისა და მცენარეების კულტივაციისათვის; ამ კლასში შემავალი მინის, ფაიფურის, კერამიკის (ფაიანსის) ან თიხის ორნამენტები და დეკორატიული ნაწარმი, ვაზები; სათაგურები, მწერების საჭერები, ბუზების საჭერები, ბუზსაკლავები, ცხენის კუდისებრი ბუზსაკლავები, პლასტმასის ონკანები ტუალეტის ხვრელებისთვის ვირთხებისა და მწერების წინააღმდეგ გამოსაყენებლად, არასანიტარული დანადგარების ნაწილები, ელექტრო მოწყობილობები ბუზების და მწერების მოსაზიდად და მოსაკლავად; კეთილსურნელოვანი სასაკმეველები, სუნამოს გამფრქვევები, სუნამოს პულვერიზატორები, მაკიაჟის მოსაშორებელი ელექტრო ან არაელექტრო მოწყობილობები, პუდრის ფუმფულები, ტუალეტის საკუთვნოს კოლოფები; სარწყავი შლანგის საცმები, წურწურას საცმები, სარწყავი მოწყობილობები, ბადის წურწურები; დაუმუშავებელი

ან ნახევრად დამუშავებული მინა, გარდა სამშენებლო მინისა, მინის მოზაიკა და დაფხვნილი მინა დეკორაციისთვის, გარდა მშენებლობისათვის, მინის ბამბა, საიზოლაციო ან ტექსტილის მასალების გარდა; თასები, ჯილდოს სახით განკუთვნილი სპორტული ღონისძიებებისთვის.

24 – ნაქსოვი ან უქსოვადი ტექსტილის ქსოვილები; საყოფაცხოვრებო მოხმარებისათვის ტექსტილის ნაწარმი, რომელიც არ შედის სხვა კლასებში: ფარდები, საწოლის გადასაფარებლები, ზეწრები (ტექსტილი), ბალიშისპირები, საბნები, დალიანდაგებული საბნები, პირსახოცები; დროშები, ალმები, ქსოვილის იარაღები ანუ ეტიკეტები; გასახვევი საბნები.

25 – ტანსაცმელი, მათ შორის, საცვლები და გარე ტანსაცმელი, გარდა სპეციალური დანიშნულების დამცავი ტანსაცმლისა; წინდები; ფეხსაცმელები; თავსაბურავი.

28 – თამაშები და სათამაშოები; სათამაშო ავტომატების გალერეა ვიდეო თამაშებისთვის; სათამაშო აპარატები და მანქანები გარე დისპლეის ეკრანთან და მონიტორთან გამოსაყენებლად, წინასწარი გადახდის მოწყობილობების ჩათვლით; სათამაშოები ცხოველებისთვის; სათამაშოები გარე სათამაშო მოედნებისთვის, პარკებისა და სათამაშო პარკებისთვის; ტანვარჯიშის და სპორტის საკუთვნობები, რომელიც არ შედის სხვა კლასებში; საშობაო ნაძვის ხეები ხელოვნური მასალისაგან, მოსართავები საშობაო ნაძვის ხეებისთვის, ხელოვნური თოვლი საშობაო ნაძვის ხეებისთვის, ჟღარუნები (სათამაშოები), სამახსოვრო სუვენირები წვეულებისთვის, მეჯლისებისათვის (მცირე საჩუქრები სტუმრებისთვის), ქაღალდის ქუდები წვეულებისთვის.

35 – რეკლამა, მარკეტინგი და საზოგადოებრივი ურთიერთობის სფეროში გაწეული მომსახურება; გამოფენებისა და სავაჭრო ბაზრობების ორგანიზება კომერციული ან სარეკლამო მიზნებისთვის; საოფისე მომსახურება; სამდივნო მომსახურება; გაზეთებზე ხელმოწერების ორგანიზება მესამე პირთათვის; სტატისტიკური მონაცემების შეგროვება; საოფისე მანქანა-აპარატურის გაქირავება; ინფორმაციის სისტემატიზაცია კომპიუტერულ მონაცემთა ბაზებში; სატელეფონო ზარებზე მოპასუხეთა მომსახურება მიუწვდომელი აბონენტებისთვის; ბიზნესის მენეჯმენტი, ბიზნესის ადმინისტრირება და კონსულტაციები ბიზნესის სფეროში; საბუღალტ-

რო აღრიცხვა; მომსახურება კომერციული კონსულტაციების სფეროში; პერსონალის დაკომპლექტება, პერსონალის დასაქმება, დასაქმების სააგენტოების მომსახურება, იმპორტ-ექსპორტის სააგენტოები; მომსახურება პერსონალის დროებითი დასაქმების სფეროში; კომერციული საქმიანობის შეფასება; აუქციონებით მომსახურება; სხვათა სასარგებლოდ შემდეგი სხვადასხვა საქონლის თავმოყრა, სახელდობრ, ქაღალდის და მუყაოს, ქაღალდის და მუყაოს შეხვევის და გადახვევის მიზნებისათვის, მუყაოს ყუთების, ქაღალდის პირსახოცების, ტუალეტის ქაღალდის, ქაღალდის ხელსახოცების, პლასტმასის მასალების შესაფუთი და გასახვევი მიზნებისათვის, ტიპოგრაფიული კლიშეების და შრიფტების; საამკინძაო მასალის, ნაბეჭდი მასალის, ბეჭდვითი გამოცემების; კალენდრების, აფიშების, პლაკატების, ფოტოსურათების (ამობეჭდილი); ნახატების; სტიკერების, თვითწებვადი სტიკერების [საკანცელარიო]; საფოსტო მარკების, საკანცელარიო ნივთების, საოფისე საკანცელარიო ნივთების, საგანმანათლებლო-აღმზრდელობითი და სასწავლო მასალების [გარდა ავეჯისა და აპარატურისა], საწერი და სახატავი ხელსაწყოების, მხატვრების მასალების, ქაღალდის ნაწარმის საკანცელარიო მიზნებისათვის, წებოების საკანცელარიო მიზნებისთვის, ოფისის საკუთვნივთების; საღებავი ლილვაკების და სახატავი ფუნჯების ხატვისათვის; როზარიების, ხელით სამართავი არაელექტრო საწმენდი ინსტრუმენტების, ფუნჯების, გარდა სახატავი ფუნჯებისა, ფოლადის ბურბუმელების წმენდისთვის, ღრუბლების წმენდისთვის, ფოლადის ნეჭას წმენდისთვის, ტექსტილის ტანსაცმლის წმენდისათვის, ხელთათმანების ჭურჭლის რეცხვისას გამოსაყენებლად, არაელექტრო საპირალბელი მანქანების საყოფაცხოვრებო მიზნებისთვის, ცოცხების ხალიჩებისათვის, შვებრების, ელექტრო ჯაგრისების, გარდა მანქანების ნაწილებისა, კბილის ჯაგრისების, ელექტრო კბილის ჯაგრისების, კბილის საწმენდი ძაფების, საპარსი ჯაგრისების, თმის ჯაგრისების, სავარცხლების, არაელექტრო საყოფაცხოვრებო ან სამზარეულოს ჭურჭლეულის, სარეცხის სამაგრების, ქოთნების, ქვაბების და ტაფების, საუთო დაფების და მათი მორთული გადასაფარებლების, სარეცხის საშრობი თაროების, ტანსაცმლის საშრობი საკიდების, გალიების ოთახის ცხოველებისთვის, ოთახის აკვარიუმების, ტერარიუმების და ვივარიუმების ცხოველებისა და მცენარეების კულტივაციისათვის, მინის, ფაიფურის, კერამიკის (ფაიანსის)

ან თიხის ორნამენტების და დეკორატიული ნაწარმის, ვაზების, სათაგურების, მწერების საჭერების, ბუზების საჭერების, ბუზსაკლავების, ცხენის კუდისებრი ბუზსაკლავების, პლასტმასის ონკანების ტუალეტის ხვრელებისთვის ვირთხებისა და მწერების წინააღმდეგ გამოსაყენებლად, არასანიტარული დანადგარების ნაწილების, ელექტრო მოწყობილობების ბუზების და მწერების მოსაზიდად და მოსაკლავად; კეთილსურნელოვანი სასაკმეველების, სუნამოს საფრქვევების, სუნამოს პულვერიზატორების, მაკიაჟის მოსაშორებელი ელექტრო ან არაელექტრო მოწყობილობების, პუდრის ფუმფულეების, ტუალეტის საკუთვნივთის კოლოფების, სარწყავი შლანგის საცმების, წურწურას საცმების, სარწყავი მოწყობილობების, ბადის წურწურების, დაუმუშავებელი ან ნახევრად დამუშავებული მინის, გარდა სამშენებლო მინისა, მინის მოზაიკის და დაფხვნილი მინის დეკორაციისთვის, გარდა მშენებლობისა, მინის ბამბის, გარდა ისეთისა, რომელიც გამოიყენება იზოლაციაში და ქსოვაში, თასების, ჯილდოს სახით განკუთვნილი სპორტული ღონისძიებებისთვის, ნაქსოვი ან უქსოვადი ტექსტილის ქსოვილების, საყოფაცხოვრებო მოხმარების ტექსტილის ნაწარმის, ფარდების, საწოლის გადასაფარებლების, ზეწრების (ტექსტილი), ბალიშისპირების, საბნების, დალიანდაგებული საბნების, პირსახოცების, დროშების, ალმების, ქსოვილის იარაღების, ანუ ეტიკეტების, გასახვევი საბნების (ტომრის სახით), ტანსაცმლის, მათ შორის, საცვლების და გარე ტანსაცმლის, გარდა სპეციალური დანიშნულების დამცავი ტანსაცმლისა, წინდების, ფეხსაცმელების, თავსაბურავის, თამაშების და სათამაშოების, სათამაშო ავტომატების გალერეას ვიდეო თამაშებისთვის, სათამაშო აპარატების და მანქანების გარე დისპლეის ეკრანთან და მონიტორთან გამოსაყენებლად, წინასწარი გადახდის მოწყობილობების ჩათვლით, სათამაშოების ცხოველებისთვის, სათამაშოების გარე სათამაშო მოედნებისთვის, პარკებისა და სათამაშო პარკებისთვის, ტანვარჯიშის და სპორტული საკუთვნივთების, საშობაო ნაძვის ხეების ხელოვნური მასალისაგან, მოსართავების საშობაო ნაძვის ხეებისთვის, ხელოვნური თოვლის საშობაო ნაძვის ხეებისთვის, ჟღარუნების (სათამაშოები), სამახსოვრო სუვენირების წვეულებებისთვის, მეჯლისისათვის (მცირე საჩუქრები სტუმრებისთვის), ქაღალდის ქუდების წვეულებისთვის, ხორცის, თევზის, ფრინველის და ნანადირევის, დამუშავებული ხორც-პროდუქტების,

გამხმარი პარკოსნების, სუპების, ბულიონის, დამუშავებული ზეთისხილის, ზეთისხილის პასტის, რძის და რძის პროდუქტების, კარაქის, საკვები ზეთების, გამხმარი, დაკონსერვებული, გაყინული, მოხარშული, შებოლილი ან დამარილებული ხილის და ბოსტნეულის, ტომატის პასტის, მზა თხილის და ხმელი ხილის საუზმეულის სახით, თხილის სპრედების და არაქისის კარაქის, ტაჰინის [სეზამის თესლის პასტა], კვერცხის და კვერცხის ფხვნილის, კარტოფილის ჩიფსების, ყავის, კაკაოს, ყავის ან კაკაოს ფუძეზე დამზადებული სასმელების, შოკოლადის ფუძეზე დამზადებული სასმელების, მაკარონის, ცომის გუფთების შიგთავსით, ატრიას, საკონდიტრო ნაწარმის და პურ-ფუნთუშეული პროდუქტების ფქვილის ფუძეზე დამზადებული, დესერტები დამზადებული ფქვილისა და შოკოლადის ფუძეზე, თაფლის, დინდგელას, სკის წებოს ადამიანის მოხმარებისთვის, პროპოლისის საკვები მიზნებისათვის, საკაზმების საკვები პროდუქტებისთვის, ვანილის [არომატიზატორები], სანელებლების, საწებლების [საკაზმები], ტომატის საწებლების, საფუარის, საცხობი ფხვნილების, ფქვილის, მანანის ბურღულის, სახამებლის საკვებისთვის, შაქრის, შაქრის კუბების, შაქრის ფხვნილის, ჩაის, ყინულოვანი ჩაის, საკონდიტრო ნაწარმის, შოკოლადის, ბისკვიტების (ორცხობილები), კრეკერების, ვაფლების, საღებავი რეზინების, ნაყინის, საკვები ყინულების, მარილის, მარცვლეული და მარცვლეულის ფუძეზე დამზადებული საკვები პროდუქტების, მელასას (შავი ბადაგი) საკვებისათვის, სასოფლო-სამეურნეო და მეზღვრობა-მეზოსტენობის პროდუქტების, რომელიც არ შედის სხვა კლასებში, თესლების, ტყის პროდუქტების, რომელიც არ შედის სხვა კლასებში, ცოცხალი ცხოველების, დაკეპილი კვერცხების წიწილების გამოჩეკად, მცენარეების, გამხმარი მცენარეების მოსართავად, ბადის ცოცხალი მწვანეების, ბადის გამხმარი ბალახების მოსართავად, ცხოველების საკვების, ალაოს, რომელიც არ არის ადამიანის მოხმარებისთვის განკუთვნილი, სხვადასხვა სახის ლუდის, ლუდის დასამზადებელი პრეპარატების, მინერალური წყლის, წყაროს წყლის, სუფრის წყლის, სოდიანი წყლის, ხილისა და ბოსტნეულის წვენების, ხილისა და ბოსტნეულის კონცენტრატების და ექსტრაქტების სასმელების დასამზადებლად, უალკოჰოლო გამაგრებელი სასმელების, ენერგეტიკული სასმელების, ალკოჰოლური სასმელების (ლუდის გარდა), თამბაქოს და თამბაქოს პროდუქტების, მწვეველ-

თა საკუთვნობის, მათ შორის, საკუთვნობის დამზადებული ძვირფასი ლითონებისგან, მილაკების (ჩიბუხები), სატურჩების სიგარეტისა და სიგარეტებისთვის, საფერფლეების, თამბაქოს ყუთების, სიგარეტის დასახვევი ჯიბის მოწყობილობა-აპარატების, სიგარეტის ქაღალდის, თამბაქოს ჩიბუხების, კაჟის სანთებლისათვის, სანთებლების მწვეველებისთვის, სანათების, რაც მომხმარებელს საშუალებას აძლევს მოხერხებულად დაათვალიეროს და შეიძინოს ეს საქონელი, ასეთი მომსახურება შეიძლება უზრუნველყოფილი იქნას საცალო ვაჭრობის მაღაზიებით, საბითუმო ვაჭრობის მაღაზიებით, ელექტრონული მედიის საშუალებით ან საფოსტო შეკვეთების კატალოგების საშუალებით.

43 – მომსახურება საკვებისა და სასმელის მიწოდებაში; მომსახურება დროებითი საცხოვრებელი უზრუნველყოფაში; მომსახურება დღის ბაღებით ბავშვებისთვის; მომსახურება ცხოველთა პანსიონებით.

(260) AM 2023 121329 A

(210) AM 121329

(220) 2023 01 24

(731) შპს „ბი თი ეი ჯორჯია“

აეროპორტი, ისანი-სამგორის რაიონი, თბილისი, საქართველო

(740) შალვა გვარამაძე

(540)



(591) შავი, თეთრი, ყვითელი

(531) 26.05.02; 26.05.22; 26.05.24; 27.05.01;

27.05.24; 29.01.12

(511)

16 – ქაღალდი და მუყაო; ქაღალდი და მუყაო შესაფუთი და გასახვევი მიზნებისათვის, მუყაოს ყუთები; ქაღალდის პირსახოცები; ტუალეტის ქაღალდი; ქაღალდის ხელსახოცები; პლასტმასის მასალები შესაფუთი და გასახვევი მიზნებისათვის; ტიპოგრაფიული კლიშეები და შრიფტები; საამკინძაო მასალა; ნაბეჭდი მასალა; ბეჭდვითი გამოცემები; კალენდრები; აფიშები, პლაკატები; ფოტოსურათები (ამობეჭდილი); ნახატები; თვითწებვადი სტიკერები [საკანცელარიო]; საფოსტო მარკები; საკანცელარიო ნივ-

თები, საოფისე საკანცელარიო ნივთები, საგანმანათლებლო-აღმზრდელობითი და სასწავლო მასალა [გარდა ავეჯისა და აპარატურისა], საწერი და სახატავი ხელსაწყოები; მხატვრების მასალები; ქალაქის ნაწარმი საკანცელარიო მიზნებისათვის, წებოები საკანცელარიო მიზნებისთვის; ოფისის საკუთნოები; სადებავი ლილვაკები და სახატავი ფუნჯები ხატვისთვის; როზარიები.

21 – ხელით სამართავი არაელექტრო საწმენდი ინსტრუმენტები, ფუნჯები, გარდა სახატავი ფუნჯებისა, ფოლადის ბურბუშელა წმენდისათვის, ღრუბლები წმენდისათვის, ფოლადის ნეჭა წმენდისათვის, ტექსტილის ქსოვილები წმენდისთვის, ხელთათმანები ჭურჭლის რეცხვისთვის, არაელექტრო გასაპირიალებელი მანქანები საყოფაცხოვრებო მიზნებისთვის, ცოცხები ხალიჩებისთვის, შვებრები, ელექტრო ჯაგრისები, გარდა მანქანების ნაწილებისა; კბილის ჯაგრისები, კბილის ელექტროჯაგრისები, კბილების გასაწმენდი ძაფები, საპარსი ჯაგრისები, თმის ჯაგრისები, სავარცხლები; არაელექტრო საყოფაცხოვრებო ან სამზარეულოს ჭურჭლეული, რომელიც შედის ამ კლასში, ტანსაცმლის სამაგრები, ქოთნები, ქვაბები და ტაფები; საუთო დაფები და მათი მორთული გადასაფარებლები, გასაშრობი თაროები სარეცხისთვის, ტანსაცმლის გასაშრობი საკიდები; გალიები ოთახის ცხოველებისთვის, ოთახის აკვარიუმები, ტერარიუმები და ვივარიუმები ცხოველებისა და მცენარეების კულტივაციისათვის; ამ კლასში შემავალი მინის, ფაიფურის, კერამიკის (ფაიანსის) ან თიხის ორნამენტები და დეკორატიული ნაწარმი, ვაზები; სათაგურები, მწერების საჭერები, ბუზების საჭერები, ბუზსაკლავები, ცხენის კუდისებრი ბუზსაკლავები, პლასტმასის ონკანები ტუალეტის ხვრელებისთვის ვირთხებისა და მწერების წინააღმდეგ გამოსაყენებლად, არა სანიტარული დანადგარების ნაწილები, ელექტრო მოწყობილობები ბუზების და მწერების მოსაზიდად და მოსაკლავად; კეთილსურნელოვანი სასაკმეველები, სუნამოს გამფრქვევები, სუნამოს პულვერიზატორები, მაკიაჟის მოსაშორებელი ელექტრო ან არაელექტრო მოწყობილობები, პუდრის ფუმფულები, ტუალეტის საკუთვნოს კოლოფები; სარწყავი შლანგის საცმები, წურწურას საცმები, სარწყავი მოწყობილობები, ბადის წურწურები; დაუმუშავებელი ან ნახევრად დამუშავებული მინა, გარდა სამშენებლო მინისა, მინის მოზაიკა და დაფხვნილი მინა დეკორაციისთვის, გარდა მშენებ-

ლობისათვის, მინის ბამბა, საიზოლაციო ან ტექსტილის მასალების გარდა; თასები, ჯილდოს სახით განკუთვნილი სპორტული ღონისძიებებისთვის.

24 – ნაქსოვი ან უქსოვადი ტექსტილის ქსოვილები; საყოფაცხოვრებო მოხმარებისათვის ტექსტილის ნაწარმი, რომელიც არ შედის სხვა კლასებში: ფარდები, საწოლის გადასაფარებლები, ზეწრები (ტექსტილი), ბალიშისპირები, საბნები, დალიანდაგებული საბნები, პირსახოცები; დროშები, ალმები, ქსოვილის იარაღები ანუ ეტიკეტები; გასახვევი საბნები.

25 – ტანსაცმელი, მათ შორის, საცვლები და გარე ტანსაცმელი, გარდა სპეციალური დანიშნულების დამცავი ტანსაცმლისა; წინდები; ფეხსაცმელები; თავსაბურავი.

28 – თამაშები და სათამაშოები; სათამაშო ავტომატების გალერეა ვიდეო თამაშებისთვის; სათამაშო აპარატები და მანქანები გარე დისპლეის ეკრანთან და მონიტორთან გამოსაყენებლად, წინასწარი გადახდის მოწყობილობების ჩათვლით; სათამაშოები ცხოველებისთვის; სათამაშოები გარე სათამაშო მოედნებისთვის, პარკებისა და სათამაშო პარკებისთვის; ტანვარჯიშის და სპორტის საკუთვნოები, რომელიც არ შედის სხვა კლასებში; საშობაო ნაძვის ხეები ხელოვნური მასალისაგან, მოსართავები საშობაო ნაძვის ხეებისთვის, ხელოვნური თოვლი საშობაო ნაძვის ხეებისთვის, ჟღარუნები (სათამაშოები), სამახსოვრო სუვენირები წვეულებისთვის, მეჯლისებისათვის (მცირე საჩუქრები სტუმრებისთვის), ქალაქის ქუდები წვეულებისთვის.

35 – რეკლამა, მარკეტინგი და საზოგადოებრივი ურთიერთობის სფეროში გაწეული მომსახურება; გამოფენებისა და სავაჭრო ბაზრობების ორგანიზება კომერციული ან სარეკლამო მიზნებისთვის; საოფისე მომსახურება; სამდივნო მომსახურება; გაზეთებზე ხელმოწერების ორგანიზება მესამე პირთათვის; სტატისტიკური მონაცემების შეგროვება; საოფისე მანქანა-აპარატურის გაქირავება; ინფორმაციის სისტემატიზაცია კომპიუტერულ მონაცემთა ბაზებში; სატელეფონო ზარებზე მოპასუხეთა მომსახურება მიუწვდომელი აბონენტებისთვის; ბიზნესის მენეჯმენტი, ბიზნესის ადმინისტრირება და კონსულტაციები ბიზნესის სფეროში; საბუღალტრო აღრიცხვა; მომსახურება კომერციული კონსულტაციების სფეროში; პერსონალის დაკომპლექტება, პერსონალის დასაქმება, დასაქმების სააგენტოების მომსახურება, იმპორტ-ექსპორ-

ტის სააგენტოები; მომსახურება პერსონალის დროებითი დასაქმების სფეროში; კომერციული საქმიანობის შეფასება; აუქციონებით მომსახურება; სხვათა სასარგებლოდ შემდეგი სხვადასხვა საქონლის თავმოყრა, სახელდობრ, ქაღალდის და მუყაოს, ქაღალდის და მუყაოს შეხვევის და გადახვევის მიზნებისათვის, მუყაოს ყუთების, ქაღალდის პირსახოცების, ტუალეტის ქაღალდის, ქაღალდის ხელსახოცების, პლასტმასის მასალების შესაფუთი და გასახვევი მიზნებისათვის, ტიპოგრაფიული კლიშეების და შრიფტების; საამკინძაო მასალის, ნაბეჭდი მასალის, ბეჭდვითი გამოცემების; კალენდრების, აფიშების, პლაკატების, ფოტოსურათების (ამობეჭდილი); ნახატების; სტიკერების, თვითწებვადი სტიკერების [საკანცელარიო]; საფოსტო მარკების, საკანცელარიო ნივთების, საოფისე საკანცელარიო ნივთების, საგანმანათლებლო-აღმზრდელობითი და სასწავლო მასალების [გარდა ავეჯისა და აპარატურისა], საწერი და სახატავი ხელსაწყოების, მხატვრების მასალების, ქაღალდის ნაწარმის საკანცელარიო მიზნებისათვის, წებოების საკანცელარიო მიზნებისათვის, ოფისის საკუთვნოების; საღებავი ლილვაკების და სახატავი ფუნჯების ხატვისათვის; როზარიების, ხელით სამართავი არაელექტრო საწმენდი ინსტრუმენტების, ფუნჯების, გარდა სახატავი ფუნჯებისა, ფოლადის ბურბუშელების წმენდისთვის, ღრუბლების წმენდისთვის, ფოლადის ნეჭას წმენდისთვის, ტექსტილის ტანსაცმლის წმენდისათვის, ხელთათმანების ჭურჭლის რეცხვისას გამოსაყენებლად, არაელექტრო საპრიალებელი მანქანების საყოფაცხოვრებო მიზნებისთვის, ცოცხების ხალიჩებისათვის, შვებრების, ელექტრო ჯაგრისების, გარდა მანქანების ნაწილებისა, კბილის ჯაგრისების, ელექტრო კბილის ჯაგრისების, კბილის საწმენდი მაფების, საპარსი ჯაგრისების, თმის ჯაგრისების, სავარცხლების, არაელექტრო საყოფაცხოვრებო ან სამზარეულოს ჭურჭლეულის, სარეცხის სამაგრების, ქოთნების, ქვაბების და ტაფების, საუთო დაფების და მათი მორთული გადასაფარებლების, სარეცხის საშრობი თაროების, ტანსაცმლის საშრობი საკიდების, გალიების ოთახის ცხოველებისთვის, ოთახის აკვარიუმების, ტერარიუმების და ვივარიუმების ცხოველებისა და მცენარეების კულტივაციისათვის, მინის, ფაიფურის, კერამიკის (ფაიანსის) ან თიხის ორნამენტების და დეკორატიული ნაწარმის, ვაზების, სათაგურების, მწერების საჭერების, ბუზების საჭერების, ბუზსაკლავების, ცხენის კუდისებრი ბუზსაკლავების, პლასტმასის

ონკანების ტუალეტის ხვრელებისთვის ვირთხებისა და მწერების წინააღმდეგ გამოსაყენებლად, არა სანიტარული დანადგარების ნაწილების, ელექტრო მოწყობილობების ბუზების და მწერების მოსაზიდად და მოსაკლავად; კეთილსურნელოვანი სასაკმეველების, სუნამოს საფრქვევების, სუნამოს პულვერიზატორების, მაკიაჟის მოსაშორებელი ელექტრო ან არაელექტრო მოწყობილობების, პუდრის ფუმფულების, ტუალეტის საკუთვნოს კოლოფების, სარწყავი შლანგის საცემების, წურწურას საცემების, სარწყავი მოწყობილობების, ბადის წურწურების, დაუმუშავებელი ან ნახევრად დამუშავებული მინის, გარდა სამშენებლო მინისა, მინის მოზაიკის და დაფხვნილი მინის დეკორაციისთვის, გარდა მშენებლობისა, მინის ბამბის, გარდა ისეთისა რომელიც გამოიყენება იზოლაციაში და ქსოვაში, თასების, ჯილდოს სახით განკუთვნილი სპორტული ღონისძიებებისთვის, ნაქსოვი ან უქსოვადი ტექსტილის ქსოვილების, საყოფაცხოვრებო მოხმარების ტექსტილის ნაწარმის, ფარდების, საწოლის გადასაფარებლების, ზეწერების (ტექსტილი), ბალიშისპირების, საბნების, დალიანდაგებული საბნების, პირსახოცების, დროშების, ალმების, ქსოვილის იარლიყების ანუ ეტიკეტების, გასახვევი საბნების (ტომრის სახით), ტანსაცმლის, მათ შორის საცვლების და გარე ტანსაცმლის, გარდა სპეციალური დანიშნულების დამცავი ტანსაცმლისა, წინდების, ფეხსაცმელების, თავსაბურავის, თამაშების და სათამაშოების, სათამაშო ავტომატების გალერეას ვიდეო თამაშებისთვის, სათამაშო აპარატების და მანქანების გარე დისპლეის ეკრანთან და მონიტორთან გამოსაყენებლად, წინასწარი გადახდის მოწყობილობების ჩათვლით, სათამაშოების ცხოველებისთვის, სათამაშოების გარე სათამაშო მოედნებისთვის, პარკებისა და სათამაშო პარკებისთვის, ტანვარჯიშის და სპორტული საკუთვნოების, საშობაო ნაძვის ხეების ხელოვნური მასალისაგან, მოსართავეების საშობაო ნაძვის ხეებისთვის, ხელოვნური თოვლის საშობაო ნაძვის ხეებისთვის, ჟღარუნების (სათამაშოები), სამახსოვრო სუვენირების წვეულებებისთვის, მეჯლისისათვის (მცირე საჩუქრები სტუმრებისთვის), ქაღალდის ქუდების წვეულებისთვის, ხორცის, თევზის, ფრინველის და ნანადირევის, დამუშავებული ხორც-პროდუქტების, გამხმარი პარკოსნების, სუპების, ბულიონის, დამუშავებული ზეთისხილის, ზეთისხილის პასტის, რძის და რძის პროდუქტების, კარაქის, საკვები ზეთების, გამხმარი, დაკონსერვებული, გაყინული, მოხარშული, შებოლილი

ან დამარილებული ხილის და ბოსტნეულის, ტომატის პასტის, მზა თხილის და ხმელი ხილის საუზმეულის სახით, თხილის სპრეიდების და არაქისის კარაქის, ტაჰინის [სეზამის თესლის პასტა], კვერცხის და კვერცხის ფხვნილის, კარტოფილის ჩიფსების, ყავის, კაკაოს, ყავის ან კაკაოს ფუმეზე დამზადებული სასმელების, შოკოლადის ფუმეზე დამზადებული სასმელების, მაკარონის, ცომის გუფთების შიგთავსით, ატრიას, საკონდიტრო ნაწარმის და პურ-ფუნთუშეული პროდუქტების ფქვილის ფუმეზე დამზადებული, დესერტები დამზადებული ფქვილისა და შოკოლადის ფუმეზე, თაფლის, დინდგელას, სკის წებოს ადამიანის მოხმარებისთვის, პროპოლისის საკვები მიზნებისათვის, საკაზმების საკვები პროდუქტებისთვის, ვანილის [არომატიზატორები], სანელებლების, საწებლების [საკაზმები], ტომატის საწებლების, საფუარის, საცხობი ფხვნილების, ფქვილის, მანანის ბურღულის, სახამებლის საკვებისთვის, შაქრის, შაქრის კუბების, შაქრის ფხვნილის, ჩაის, ყინულოვანი ჩაის, საკონდიტრო ნაწარმის, შოკოლადის, ბისკვიტების (ორცხობილები), კრეკერების, ვაფლების, საღებავი რეზინების, ნაყინის, საკვები ყინულების, მარილის, მარცვლეული და მარცვლეულის ფუმეზე დამზადებული საკვები პროდუქტების, მელასას (შავი ბადაგი) საკვებისათვის, სასოფლო-სამეურნეო და მეზღვეობა-მეზოსტნეობის პროდუქტების, რომელიც არ შედის სხვა კლასებში, თესლების, ტყის პროდუქტების, რომელიც არ შედის სხვა კლასებში, ცოცხალი ცხოველების, დაპეპლილი კვერცხების წიწილების გამოჩეკად, მცენარეების, გამხმარი მცენარეების მოსართავად, ბაღის ცოცხალი მწვანეების, ბაღის გამხმარი ბალახების მოსართავად, ცხოველების საკვების, ალაოს, რომელიც არ არის ადამიანის მოხმარებისთვის განკუთვნილი, სხვადასხვა სახის ლუდის, ლუდის დასამზადებელი პრეპარატების, მინერალური წყლის, წყაროს წყლის, სუფრის წყლის, სოდიანი წყლის, ხილისა და ბოსტნეულის წვენების, ხილისა და ბოსტნეულის კონცენტრატების და ექსტრაქტების სასმელების დასამზადებლად, უალკოჰოლო გამაგრებელი სასმელების, ენერგეტიკული სასმელების, ალკოჰოლური სასმელების (ლუდის გარდა), თამბაქოს და თამბაქოს პროდუქტების, მწველთა საკუთვნობის, მათ შორის, საკუთვნობის დამზადებული ძვირფასი ლითონებისგან, მილაკების (ჩიბუხები), სატუჩების სიგარეტისა და სიგარეტებისთვის, საფერფლეების, თამბაქოს ყუთების, სიგარეტის დასახვევი ჯიბის მო-

წყობილობა-აპარატების, სიგარეტის ქაღალდის, თამბაქოს ჩიბუხების, კაჟის სანთებლისათვის, სანთებლების მწვევლებისთვის, სანათების, რაც მომხმარებელს საშუალებას აძლევს მოხერხებულად დაათვალიეროს და შეიძინოს ეს საქონელი, ასეთი მომსახურება შეიძლება უზრუნველყოფილი იქნას საცალო ვაჭრობის მაღაზიებით, საბითუმო ვაჭრობის მაღაზიებით, ელექტრონული მედიის საშუალებით ან საფოსტო შეკვეთების კატალოგების საშუალებით.

43 – მომსახურება საკვებისა და სასმელის მიწოდებაში; მომსახურება დროებითი საცხოვრებელი უზრუნველყოფაში; მომსახურება დღის ბაღებით ბავშვებისთვის; მომსახურება ცხოველთა პანსიონებით.

(260) AM 2023 121330 A

(210) AM 121330

(220) 2023 01 24

(731) შპს „ბი თი ეი ჯორჯია“

აეროპორტი, ისანი-სამგორის რაიონი, თბილისი, საქართველო

(740) შალვა გვარამაძე

(540)



(591) ლურჯი, თეთრი, რუხი, ვარდისფერი, ყვითელი, წითელი, ღია მწვანე, სხვადასხვა ტონის ცისფერი

(531) 01.15.15; 01.15.21; 26.01.01; 26.01.19; 26.01.24; 26.11.12; 27.05.01; 27.05.07; 29.01.15

(511)

43 – მომსახურება საკვების და სასმელის მიწოდებაში; მომსახურება დროებითი საცხოვრებელი უზრუნველყოფაში.

(260) AM 2023 121331 A

(210) AM 121331

(220) 2023 01 24

(731) შპს „ბი თი ეი ჯორჯია“

აეროპორტი, ისანი-სამგორის რაიონი, თბილისი, საქართველო

(740) შალვა გვარამაძე

(540)



(591) თეთრი, ყავისფერი, სხვადასხვა ტონის მწვანე

(531) 05.01.03; 05.01.05; 05.01.11; 26.11.12; 27.05.01; 29.01.13

(511)

43 – მომსახურება საკვების და სასმელის მიწოდებაში; მომსახურება დროებითი საცხოვრებელი უზრუნველყოფაში (ბავშვებისთვის დღის ბაღების მომსახურების, მოხუცთა თავშესაფრების მომსახურების ჩათვლით); მომსახურება ცხოველთა პანსიონებში.

(260) AM 2023 121332 A

(210) AM 121332

(220) 2023 01 24

(731) დავით გოგოლაშვილი

სოფ. ანაგა, 22-ე ქ., III ჩიხი 2, სიღნაღი, საქართველო

(740) შოთა მეტრეველი

(540)

Wrap N Roll ვრაპ ნ როლ

(591) შავ-თეთრი

(511)

43 – საკვებით და სასმელით უზრუნველყოფა.

(260) AM 2023 121333 A

(210) AM 121333

(220) 2023 01 25

(731) შპს „ნიუ აგრო New Agro“

დავით აღმაშენებლის ხეივანი 183, 0131, თბილისი, საქართველო

(740) დავით ძამუკაშვილი

(540)



(591) მწვანე, მუქი მწვანე, თეთრი

(531) 06.19.11; 26.11.13; 27.01.12; 27.05.01; 29.01.12

(511)

1 – სასუქები.

5 – მავნე ცხოველების გასანადგურებელი პრეპარატები; ფუნგიციდები და ჰერბიციდები; ბაქტერიციდები; ბიოციდები; ინსექტიციდები; პესტიციდები.

(260) AM 2023 121334 A

(210) AM 121334

(220) 2023 01 25

(731) შპს „სევენ ჰილს“

გრიგოლ ლორთქიფანიძის ქ. 154, ისანი-სამგორის რაიონი, თბილისი,

საქართველო

(540)

მონო Mono

(591) შავ-თეთრი

(511)

16 – ქაღალდი და მუყაო; ნაბეჭდი მასალა; საამკინძაო მასალა; ფოტოფირები; საკანცელარიო და საოფისე საკუთვნო, ავეჯის გარდა; საკანცელარიო და საყოფაცხოვრებო დანიშნულების წებოები; მხატვრების საკუთვნო და სახატავი მასალა; სახატავი ფუნჯები; სასწავლო და სადემონსტრაციო მასალა; პლასტმასის ფურცლები, ფირები და ტომრები, როგორც შესაფუთი მასალა; ტიპოგრაფიული შრიფტები, ტიპოგრაფიული კლიშეები.

(260) AM 2023 121335 A

(210) AM 121335

(220) 2023 01 25

(731) შპს „სევენ ჰილს“

გრიგოლ ლორთქიფანიძის ქ. 154, ისანი-სამგორის რაიონი, თბილისი,

საქართველო

(540)

ფიფქია Pipkia

(591) შავ-თეთრი

(511)

16 – ქაღალდი და მუყაო; ნაბეჭდი მასალა; საამკინძაო მასალა; ფოტოფირები; საკანცელარიო და საოფისე საკუთვნო, ავეჯის გარდა; საკანცელარიო და საყოფაცხოვრებო დანიშნულების წებოები; მხატვრების საკუთვნო და სახატავი მასალა; სახატავი ფუნჯები; სასწავლო და სადემონსტრაციო მასალა; პლასტმასის ფურცლები, ფირები და ტომრები, როგორც შესაფუთი მასალა; ტიპოგრაფიული შრიფტები, ტიპოგრაფიული კლიშეები.

(260) AM 2023 121352 A

(210) AM 121352

(220) 2023 01 26

(731) ნტტმ ლღვ

2120 სმიტთაუნი ავენიუ, რონკონკომა,
ნიუ-იორკი 11779, აშშ

(740) თამაზ შილაკაძე

(540)

NATURE'S TRUTH

(591) შავ-თეთრი

(511)

5 – ვიტამინები და ვიტამინის პრეპარატები; ვიტამინის დანამატები; მინერალური დანამატები; კვების დანამატები; დიეტური დანამატები; საკვები დანამატები და მცენარეული დანამატები.

რეგისტრირებული სასაქონლო ნიშნები

| | |
|---|--|
| (111) M 2023 37085 R (151) 2023 07 17 (181) 2033 07 17 (260) AM 2020 110965 A (220) 2020 12 22 (732) ქეი თი & ჯი კორპორეიშნ 71, ბეოტკოტ-გილ, დაედეოკ-გუ, ტეჯონი, კორეის რესპუბლიკა | მ. კოსტავას ქ. 71ა, ბ. N33, 0171, საბურთალოს რაიონი, თბილისი, საქართველო |
| (111) M 2023 37086 R (151) 2023 07 17 (181) 2033 07 17 (260) AM 2022 118158 A (220) 2022 06 15 (732) შპს „ალტა ტექნოლოჯის“ აკაკი ბელიაშვილის ქ. 104, ფართი 12, შენობა 1, 0159, თბილისი, საქართველო | (111) M 2023 37090 R (151) 2023 07 17 (181) 2033 07 17 (260) AM 2022 119210 A (220) 2022 09 01 (732) შპს „იურიდიული ფირმა ბიზნეს ლიგალ ბიურო“ მ. კოსტავას ქ. 71ა, ბ. 33, 0171, საბურთალოს რაიონი, თბილისი, საქართველო |
| (111) M 2023 37087 R (151) 2023 07 17 (181) 2033 07 17 (260) AM 2022 118540 A (220) 2022 07 12 (732) რევიტ & კოლმენ (ოვერსიზ) ჰიჯიენ ჰომ ლიმიტიდ 103-105 ბათ როუდი, სლოუ, ბერქშირი, SL1 3UH, გაერთიანებული სამეფო | (111) M 2023 37104 R (151) 2023 08 01 (181) 2033 08 01 (260) AM 2022 116620 A (220) 2022 02 11 (732) შპს ჯორჯიან ლეჯენდ ირაკლი აბაშიძის ქ. 70, მე-3 სად. ბ. 118, 0162, თბილისი, საქართველო |
| (111) M 2023 37088 R (151) 2023 07 17 (181) 2033 07 17 (260) AM 2022 118470 A (220) 2022 07 08 (732) მაქსიმ კორჟოვ სოვეტსკაია 7/104, ხარციხისიკი, უკრაინა | (111) M 2023 37105 R (151) 2023 08 01 (181) 2033 08 01 (260) AM 2022 119015 A (220) 2022 08 17 (732) ალკალოიდ ად სკოპიე ბულვ. ალექსანდერ მაკედონსკი 12, 1000 სკოპიე, ჩრდილოეთ მაკედონიის რესპუბლიკა |
| (111) M 2023 37089 R (151) 2023 07 17 (181) 2033 07 17 (260) AM 2022 119208 A (220) 2022 09 01 (732) შპს „იურიდიული ფირმა ბიზნეს ლიგალ ბიურო“ | (111) M 2023 37106 R (151) 2023 08 01 (181) 2033 08 01 (260) AM 2022 119016 A (220) 2022 08 17 (732) ალკალოიდ ად სკოპიე ბულვ. ალექსანდერ მაკედონსკი 12, 1000 სკოპიე, ჩრდილოეთ მაკედონიის რესპუბლიკა |

(111) M 2023 37107 R
 (151) 2023 08 01
 (181) 2033 08 01
 (260) AM 2022 119014 A
 (220) 2022 08 17
 (732) ალკალოიდ ად სკოპიე
 ბულვ. ალექსანდერ მაკედონსკი 12,
 1000 სკოპიე, ჩრდილოეთ მაკედონიის
 რესპუბლიკა

(111) M 2023 37108 R
 (151) 2023 08 01
 (181) 2033 08 01
 (260) AM 2022 119017 A
 (220) 2022 08 17
 (732) ალკალოიდ ად სკოპიე
 ბულვ. ალექსანდერ მაკედონსკი 12,
 1000 სკოპიე, ჩრდილოეთ მაკედონიის
 რესპუბლიკა

(111) M 2023 37109 R
 (151) 2023 08 01
 (181) 2033 08 01
 (260) AM 2022 119113 A
 (220) 2022 08 25
 (732) ჰაიატ ინტერნემენელ კოიპრპორემენ
 150 ნორთს რივერსაიდ პლაზა, 14თს
 ფლორ, ჩიკაგო, ილინოისი, 60606, აშშ

(111) M 2023 37110 R
 (151) 2023 08 01
 (181) 2033 08 01
 (260) AM 2022 119110 A
 (220) 2022 08 25
 (732) ჰაიატ ინტერნემენელ კოიპრპორემენ
 150 ნორთს რივერსაიდ პლაზა, 14თს
 ფლორ, ჩიკაგო, IL 60606, აშშ

(111) M 2023 37111 R
 (151) 2023 08 01
 (181) 2033 08 01
 (260) AM 2022 119018 A
 (220) 2022 08 17
 (732) ალკალოიდ ად სკოპიე
 ბულვ. ალექსანდერ მაკედონსკი 12,
 1000 სკოპიე, ჩრდილოეთ მაკედონიის
 რესპუბლიკა

(111) M 2023 37112 R
 (151) 2023 08 01
 (181) 2033 08 01
 (260) AM 2022 119193 A
 (220) 2022 08 29
 (732) შპს „ქართული ღვინის სახლი“
 სოფ. ზეგაანი, 1500, გურჯაანი,
 საქართველო

(111) M 2023 37113 R
 (151) 2023 08 01
 (181) 2033 08 01
 (260) AM 2022 118723 A
 (220) 2022 07 22
 (732) შენჟენ ტკლ ნიუ ტექნოლოჯი კო., ლტდ
 9/F, ბილდინგ D4, ინტერნემენელ E
 სითი, 1001 ჟონგშან პარკ როუდ, ხილი
 სტრიტ, ნანშან დისტრიკტ, შენჟენ,
 გუანგდონგ, 518000, ჩინეთის სახალხო
 რესპუბლიკა

(111) M 2023 37114 R
 (151) 2023 08 01
 (181) 2033 08 01
 (260) AM 2022 118410 A
 (220) 2022 07 07
 (732) შპს „მარბანო“
 სოფ. დილომი, ფატმანის ქ. 10, ბ. 15,
 საბურთალოს რაიონი, თბილისი,
 საქართველო

(111) M 2023 37115 R
 (151) 2023 08 01
 (181) 2033 08 01
 (260) AM 2022 119004 A
 (220) 2022 08 16
 (732) კოსტა ლიმიტიდ
 კოსტა ჰაუზ, ჰოუტონ ჰოლ ბიზნეს პარკი,
 პორზ ავენიუ, ჰოუტონ რეგის,
 დანსტაიბლ, ბედფორდშირი LU5 5YG,
 გაერთიანებული სამეფო

(111) M 2023 37116 R
 (151) 2023 08 01
 (181) 2033 08 01
 (260) AM 2022 119348 A
 (220) 2022 09 12
 (732) შპს „სანტე ჯი ემ თი პროდუქტები“

კახეთის გზატ. მე-10 კმ. 0182, თბილისი,
საქართველო

უნივერსიტეტის ქ. 5, ნაკვეთი 06/034,
თბილისი, საქართველო

(111) M 2023 37117 R

(151) 2023 08 01

(181) 2033 08 01

(260) AM 2022 116619 A

(220) 2022 02 11

(732) სოს-კინდერდორფი

შტაფერშტრასე 10ა, 6020 ინსბრუკი,
ავსტრია

(111) M 2023 37122 R

(151) 2023 08 01

(181) 2033 08 01

(260) AM 2022 119283 A

(220) 2022 09 07

(732) დეკათლონ

4 ბულვარ დე მონს, 59650 ვილნევი
დ'ასჟი, საფრანგეთი

(111) M 2023 37118 R

(151) 2023 08 01

(181) 2033 08 01

(260) AM 2022 119212 A

(220) 2022 09 02

(732) ქეი თი & ჯი კორპორეიშნ

71, ბეოტკოტ-გილ, დაედუოკ-გუ,
ტეჯონი, კორეის რესპუბლიკა, კორეის
რესპუბლიკა

(111) M 2023 37123 R

(151) 2023 08 01

(181) 2033 08 01

(260) AM 2022 119351 A

(220) 2022 09 12

(732) ლეო ინსტიტუტი

პეტრიაშვილის ქ. 25-27-29; გალის ქ. 4,
სადარბაზო 1, ბ. 13, სართული 7-8, 0179,
მთაწმინდის რაიონი, თბილისი,
საქართველო

(111) M 2023 37119 R

(151) 2023 08 01

(181) 2033 08 01

(260) AM 2022 119492 A

(220) 2022 09 20

(732) კერტენ ანლიმიტიდ კომპანი

13-18 სითი ქიი, დუბლინი 2, ირლანდია

(111) M 2023 37124 R

(151) 2023 08 01

(181) 2033 08 01

(260) AM 2022 119352 A

(220) 2022 09 12

(732) ლეო ინსტიტუტი

პეტრიაშვილის ქ. 25-27-29; გალის ქ. 4,
სადარბაზო 1, ბ. 13, სართული 7-8, 0179,
მთაწმინდის რაიონი, თბილისი,
საქართველო

(111) M 2023 37120 R

(151) 2023 08 01

(181) 2033 08 01

(260) AM 2022 119185 A

(220) 2022 08 26

(732) შპს „ზინურუ“

ო. ონიაშვილის ქ. 30, ბ. 8, 0160,
საბურთალოს რაიონი, თბილისი,
საქართველო

(111) M 2023 37125 R

(151) 2023 08 01

(181) 2033 08 01

(260) AM 2022 119489 A

(220) 2022 09 19

(732) დეკათლონ

4 ბულვარ დე მონს, 59650 ვილნევი
დ'ასჟი, საფრანგეთი

(111) M 2023 37121 R

(151) 2023 08 01

(181) 2033 08 01

(260) AM 2022 119196 A

(220) 2022 08 31

(732) შპს „ჩემი სახლი“

(111) M 2023 37126 R

(151) 2023 08 01

(181) 2033 08 01

(260) AM 2022 119493 A

(220) 2022 09 20
 (732) სს „კორპორაცია ქინძმარაული“
 ილია ჭავჭავაძის ქ. 55, 4800, ყვარელი,
 საქართველო

ლაოჟი, დაგუტანგ ვილიჯ, ჟოუქსიანგ
 თაუნ, სიქსი სითი, ჟეჯიანგ პროვანს,
 315324, ჩინეთის სახალხო რესპუბლიკა

(111) M 2023 37127 R
 (151) 2023 08 01
 (181) 2033 08 01
 (260) AM 2022 119496 A
 (220) 2022 09 20
 (732) შპს „გოლდენგეითი“
 სულხან ცინცაძის ქ. 58, ბ. 97, 0160,
 თბილისი, საქართველო

(111) M 2023 37132 R
 (151) 2023 08 01
 (181) 2033 08 01
 (260) AM 2019 103095 A
 (220) 2019 05 14
 (732) სს „სადაზღვევო კომპანია იმედი ელ“
 ანა პოლიტკოვსკაიას ქ. 9, თბილისი,
 საქართველო

(111) M 2023 37128 R
 (151) 2023 08 01
 (181) 2033 08 01
 (260) AM 2022 119596 A
 (220) 2022 09 26
 (732) ანა ზაზაძე
 დავით გარეჯის ქ. 14ა, ბ. 38, რუსთავი,
 საქართველო

(111) M 2023 37133 R
 (151) 2023 08 01
 (181) 2033 08 01
 (260) AM 2022 117558 A
 (220) 2022 04 21
 (732) ვივო მობაილ ქომუნიკეიშენ ქო, ლტდ
 დონგგუან, ჩანგან, ვივო როუდ N1,
 გუანგდონ, 0100, ჩინეთის სახალხო
 რესპუბლიკა

(111) M 2023 37129 R
 (151) 2023 08 01
 (181) 2033 08 01
 (260) AM 2022 119616 A
 (220) 2022 09 29
 (732) შპს „გროუგროუ“
 ანასტასია ერისთავ-ხოშტარას ქ. 1, 0108,
 თბილისი, საქართველო

(111) M 2023 37134 R
 (151) 2023 08 01
 (181) 2033 08 01
 (260) AM 2022 118077 A
 (220) 2022 06 08
 (732) მეტამორფოზა დ.ო.ო.
 რადნიჩკა ცესტა 43, 10000 ზაგრები,
 ხორვატია

(111) M 2023 37130 R
 (151) 2023 08 01
 (181) 2033 08 01
 (260) AM 2022 119617 A
 (220) 2022 09 29
 (732) შპს „გროუგროუ“
 ანასტასია ერისთავ-ხოშტარას ქ. 1, 0108,
 თბილისი, საქართველო

(111) M 2023 37135 R
 (151) 2023 08 01
 (181) 2033 08 01
 (260) AM 2022 118294 A
 (220) 2022 06 24
 (732) შპს „ამალაინ გრუპი“
 დიღმის მასივი, IV კვარტ., კორპ. 25, ბ. 48,
 0159, დიდუბის რაიონი, თბილისი,
 საქართველო

(111) M 2023 37131 R
 (151) 2023 08 01
 (181) 2033 08 01
 (260) AM 2022 119791 A
 (220) 2022 10 11
 (732) იუიე კაი

(111) M 2023 37136 R
 (151) 2023 08 01
 (181) 2033 08 01
 (260) AM 2022 118406 A
 (220) 2022 07 06

(732) ტეკილა კუერვო, ს.ა. დე კ.ვ.
ავენიდა პერიფერიკო სურ No. 8500,
ტლაკეპაკე, ხალისკო, კ.პ. 45609, მექსიკა

კოსტავას ქ. 14, 0108, თბილისი,
საქართველო

(111) M 2023 37137 R
(151) 2023 08 01
(181) 2033 08 01
(260) AM 2022 118407 A
(220) 2022 07 06

(732) კრისტა ლა სანტა, ს.ა.პ.ი. დე კ.ვ.
პლასა მარისკალ სუკრე No. 46 ინტ 31,
კოლ. დელ. ვალლე, დელგასიონ ბენიტო
ჰუარეს, მეხიკო, C.P. 03100, მექსიკა

(111) M 2023 37142 R
(151) 2023 08 01
(181) 2033 08 01
(260) AM 2022 118661 A
(220) 2022 07 21
(732) მიცუბიში ჯიდომა კოგოი კაბუშიკი კაიმა
1-21, შიბაურა 3-ჩომე, მინატოკუ, ტოკიო
108-8410, იაპონია

(111) M 2023 37138 R
(151) 2023 08 01
(181) 2033 08 01
(260) AM 2022 118539 A
(220) 2022 07 12

(732) შპს „ფალავანი“
შინდისის გზატ. 19, გორი, საქართველო

(111) M 2023 37143 R
(151) 2023 08 01
(181) 2033 08 01
(260) AM 2022 118662 A
(220) 2022 07 21
(732) მიცუბიში ჯიდომა კოგოი კაბუშიკი კაიმა
1-21, შიბაურა 3-ჩომე, მინატოკუ, ტოკიო
108-8410, იაპონია

(111) M 2023 37139 R
(151) 2023 08 01
(181) 2033 08 01
(260) AM 2022 118559 A
(220) 2022 07 13

(732) შპს „ინოსან ბიოსაიენს ენდ რისერჩ“
ისნის ქ. 1, 0103, ისნის რაიონი, თბილისი,
საქართველო

(111) M 2023 37144 R
(151) 2023 08 01
(181) 2033 08 01
(260) AM 2022 118932 A
(220) 2022 08 10
(732) ლავრენტი გუბინ
ბეჟან კალანდაძის ქ. 5, ბ. 58, 0162,
კრწანისის რაიონი, თბილისი,
საქართველო

(111) M 2023 37140 R
(151) 2023 08 01
(181) 2033 08 01
(260) AM 2022 118651 A
(220) 2022 07 20

(732) შპს „აჭარა ჯგუფი“
კოსტავას ქ. 14, 0108, თბილისი,
საქართველო

(111) M 2023 37145 R
(151) 2023 08 01
(181) 2033 08 01
(260) AM 2022 119345 A
(220) 2022 09 09
(732) დიაჯეო სკოტლანდ ლიმიტედ
11 ლოხსაიდ ფლეის, ედინბურგი,
შოტლანდია, EH12 9HA, გაერთიანებული
სამეფო

(111) M 2023 37141 R
(151) 2023 08 01
(181) 2033 08 01
(260) AM 2022 118652 A
(220) 2022 07 20

(732) შპს „აჭარა ჯგუფი“

(111) M 2023 37146 R
(151) 2023 08 01
(181) 2033 08 01
(260) AM 2022 119003 A
(220) 2022 08 16
(732) შპს „პეტრო პლუს“

კრწანისის ქ. 3, კორპ. 3, ბ. 17, 0114,
თბილისი, საქართველო

სოფ. ნატახტარი, 3308, მცხეთა,
საქართველო

(111) M 2023 37147 R
(151) 2023 08 01
(181) 2033 08 01
(260) AM 2022 119581 A
(220) 2022 09 23
(732) შპს „ინექს გრუპი“
აწყურის ქ. 45, სართ. 1, თბილისი,
საქართველო

(111) M 2023 37152 R
(151) 2023 08 01
(181) 2033 08 01
(260) AM 2022 118998 A
(220) 2022 08 15
(732) შპს „ბარამბო“
სოფ. ნატახტარი, 3308, მცხეთა,
საქართველო

(111) M 2023 37148 R
(151) 2023 08 01
(181) 2033 08 01
(260) AM 2022 118851 A
(220) 2022 08 04
(732) შპს „კ.კახეთი“
საირმის ქ. 55, ბ. 85, 0194, თბილისი,
საქართველო

(111) M 2023 37153 R
(151) 2023 08 01
(181) 2033 08 01
(260) AM 2022 118999 A
(220) 2022 08 15
(732) შპს „ბარამბო“
სოფ. ნატახტარი, 3308, მცხეთა,
საქართველო

(111) M 2023 37149 R
(151) 2023 08 01
(181) 2033 08 01
(260) AM 2022 118853 A
(220) 2022 08 04
(732) შპს „კ. კახეთი“
საირმის ქ. 55, ბ. 85, 0194, თბილისი,
საქართველო

(111) M 2023 37154 R
(151) 2023 08 02
(181) 2033 08 02
(260) AM 2022 118993 A
(220) 2022 08 12
(732) შპს „ბლინქ“
დავით ბაქრაძის ქ. 6, 0119, თბილისი,
საქართველო

(111) M 2023 37150 R
(151) 2023 08 01
(181) 2033 08 01
(260) AM 2022 118996 A
(220) 2022 08 15
(732) შპს „ბარამბო“
სოფ. ნატახტარი, 3308, მცხეთა,
საქართველო

(111) M 2023 37156 R
(151) 2023 08 02
(181) 2033 08 02
(260) AM 2022 117550 A
(220) 2022 04 21
(732) სს „კოტეხი-გურჯაანის ღვინის ქარხანა“
კ. ქოროღლიშვილის ქ. 38, 1500, გურჯაანი,
საქართველო

(111) M 2023 37151 R
(151) 2023 08 01
(181) 2033 08 01
(260) AM 2022 118997 A
(220) 2022 08 15
(732) შპს „ბარამბო“

(111) M 2023 37157 R
(151) 2023 08 02
(181) 2033 08 02
(260) AM 2022 118934 A
(220) 2022 08 11
(732) შპს „ჯორჯიან ლეჯენდ“

ირაკლი აბაშიძის ქ. 70, 0162, თბილისი,
საქართველო

ლილო, ლოჭინის ხევი (ნაკვ. N05/001),
0151, თბილისი, საქართველო

(111) M 2023 37158 R
(151) 2023 08 02
(181) 2033 08 02
(260) AM 2022 116069 A
(220) 2022 01 04
(732) მეტა პლატფორმს ინკ.
1601 ვილოვ როუდ, მენლო პარკ,
კალიფორნია, 94025, აშშ

(111) M 2023 37163 R
(151) 2023 08 02
(181) 2033 08 02
(260) AM 2022 119104 A
(220) 2022 08 25
(732) შპს „თრუ ჰოსფიტალითი“
კ. აფხაზის I ჩიხი, 5, მთაწმინდის
რაიონი, თბილისი, საქართველო

(111) M 2023 37159 R
(151) 2023 08 02
(181) 2033 08 02
(260) AM 2022 119008 A
(220) 2022 08 17
(732) მონსტერ ენერჯი კომპანი, დელავერის
შტატის კორპორაცია
1 მონსტერ უეი, კორონა, კალიფორნიის
შტატი 92879, აშშ

(111) M 2023 37160 R
(151) 2023 08 02
(181) 2033 08 02
(260) AM 2022 119009 A
(220) 2022 08 17
(732) მონსტერ ენერჯი კომპანი, დელავერის
შტატის კორპორაცია
1 მონსტერ უეი, კორონა, კალიფორნიის
შტატი 92879, აშშ

(111) M 2023 37161 R
(151) 2023 08 02
(181) 2033 08 02
(260) AM 2022 119077 A
(220) 2022 08 19
(732) ფილიპ მორის ბრენდზ სარლ
კე ჟანრენო 3, 2000 ნევმატელი, შვეიცარია

(111) M 2023 37162 R
(151) 2023 08 02
(181) 2033 08 02
(260) AM 2022 119768 A
(220) 2022 10 07
(732) სს „არგო“

დაჩქარებული პროცედურით რეგისტრირებული სასაქონლო ნიშნები

რეგისტრაციის გაუქმების მოთხოვნით საჩივრის შეტანა შესაძლებელია საქპატენტის სააპელაციო პალატაში გამოქვეყნებიდან 3 თვის ვადაში.

(111) M 2023 37091 R

(151) 2023 07 18

(181) 2033 07 18

(210) AM 123516

(220) 2023 06 29

(732) ანდრიი პოიდა

ბერეზინსკას ქ., სახლი 40, ბ. 70,

დნეპროპეტროვსკის ოლქი, ქალაქი

დნიპრო, უკრაინა

(740) ნინო ნიქაბაძე

(540)



(591) თეთრი, ღია წაცრისფერი, წაცრისფერი,
მუქი წაცრისფერი

(531) 15.01.01; 15.01.17; 15.01.25; 15.03.01;

15.03.09; 15.07.01; 15.07.02; 15.07.03;

15.07.04; 26.01.01; 26.01.19; 27.05.01

(511)

8 – ხელის იარაღები და ხელის ინსტრუმენტები; მჭრელი იარაღები; პირადი იარაღი, ცეცხლ-სასროლი იარაღის გარდა; სამართებლები.

38 – მომსახურებები, რომლებიც საშუალებას აძლევს მინიმუმ ერთ მხარეს დაუკავშირდეს მეორეს, ასევე, მომსახურებები მაუწყებლობისა და მონაცემთა გადაცემისთვის.

41 – მომსახურება, რომელიც შედგება განათლებისა და სწავლების ყველა ფორმისგან, მომსახურება, რომლის ძირითადი მიზანია ხალხის გართობა, გართობა ან დასვენება, აგრეთვე, ვიზუალური ხელოვნების ან ლიტერატურის ნაწარმოებების წარდგენა საზოგადოებისთვის კულტურული ან საგანმანათლებლო მიზნებისთვის.

42 – პირთა მიერ მოწოდებული მომსახურება კომპლექსური საქმიანობის სფეროების თეორიულ და პრაქტიკულ ასპექტებთან დაკავშირებით, მათ შორის, სამეცნიერო ლაბორატორიული მომსახურება, ინჟინერია, კომპიუტერული პროგრამირება, არქიტექტურული მომსახურება ან ინტერიერის დიზაინი.

45 – იურიდიული და უსაფრთხოების სამსახურები, ისევე, როგორც ცალკეული პირადი და სოციალური მომსახურებები, რომლებიც გაწეულია სხვა პირების საჭიროებების დასაკმაყოფილებლად.

(111) M 2023 37092 R

(151) 2023 07 18

(181) 2033 07 18

(210) AM 123515

(220) 2023 06 29

(732) ენდრე ბირიჩი

გ. კიკობის ქ. 11, 0108, თბილისი,

საქართველო

(540)

Digital Nomad

(591) 000000 შავ-თეთრი

(511)

36 – მომსახურება, რომელიც ეხება საბანკო და სხვა ფინანსურ ტრანზაქციებს, ფინანსური შეფასების მომსახურებას, ასევე, სადაზღვევო და უძრავი ქონების საქმიანობას.

(111) M 2023 37093 R

(151) 2023 07 18

(181) 2033 07 18

(210) AM 123191

(220) 2023 06 05

(732) ლაქტალის დენმარკ

ინდუსტრიევის ქ. 14, C DK-3320,

სკავეინგი, დანია

(740) გიორგი გეწაძე

(540)



(591) ნარინჯისფერი, თეთრი, 050000 შავი
(531) 26.01.01; 26.01.18; 26.04.02; 26.04.22;
26.04.24; 26.11.12; 27.05.01; 27.05.17;
29.01.14

(511)

5 – ფარმაცევტული, სამედიცინო და ვეტერინარული პრეპარატები; სამედიცინო დანიშნულების ჰიგიენური პრეპარატები; სამედიცინო ან ვეტერინარული გამოყენებისთვის ვარგისი დიეტური საკვები და ნივთიერებები, საკვები ჩვილებისთვის; დიეტური დანამატები ადამიანებისა და ცხოველებისთვის; ლეიკოპლასტირი, სახვევი მასალა; კბილების დასამაგრებელი მასალა, სტომატოლოგიური ცვილი; სადენინფექციო საშუალებები; მავნე მწერების გასანადგურებელი პრეპარატები; ფუნგიციდები, ჰერბიციდები.

29 – ხორცი, თევზი, ფრინველი და ნანადირევი; ხორცის ექსტრაქტები; დაკონსერვებული, გაყინული, გამხმარი და მოხარშული ან შემწვარი ხილი და ბოსტნეული; ჟელიები, ხილფაფები, კომპოტები; კვერცხი; რძე, ყველი, კარაქი, იოგურტი და რძის სხვა პროდუქტები; საკვები ზეთები და ცხიმები.

30 – ყავა, ჩაი, კაკაო და ყავის შემცველები; ბრინჯი, მაკარონი და ატრია; ტაპიოკა და საგო; ფქვილი და მარცვლეულის პროდუქტი; პურ-ფუნთუშეული, მაკარონი და საკონდიტრო ნაწარმი; შოკოლადი; ნაყინი, შარბათი, და სხვა საკვები ყინული; შაქარი, თაფლი, ზადაგი; საფუარი, საცხობი ფხვნილები; მარილი, სანელებლები, საკაზმები, დაკონსერვებული მწვანილი; ძმარი, საწებლები და სხვა საკაზმი; ყინული (გაყინული წყალი).

32 – ლუდი; არაალკოჰოლური სასმელები; მინერალური და გაზიანი წყლები; ხილის სასმელები და წვენები; სიროფები და სხვა არაალკოჰოლური შედგენილობები სასმელების დასამზადებლად.

(111) M 2023 37094 R

(151) 2023 07 18

(181) 2033 07 18

(210) AM 112293

(220) 2021 03 24

(732) შპს „აის-კო კომპანი“

აბოვიანის ქ. 7, 0105, თბილისი,

საქართველო

(740) გიორგი თაქთაქიშვილი

(540)

პილოტი

(591) შავ-თეთრი

(531) 28.19

(511)

3 – ავტომობილების პოლირების საშუალებები; ლითონის პოლირების საშუალებები; ქრომის პოლირების საშუალებები; ტყავის საპრიალებლები; ტყავის დამცავი საშუალებები (საპრიალებლები); საპრიალებელი სპრეი.

(111) M 2023 37095 R

(151) 2023 07 21

(181) 2033 07 21

(210) AM 123581

(220) 2023 07 04

(732) შპს „ბიო თაიმი“

დიდი ლილო, თეთრი ხევის დასახლება,

სამგორის რაიონი, თბილისი,

საქართველო

(540)

ბიოთაიმი · BIOTIME

(591) მუქი მწვანე, თეთრი

(531) 27.05.01; 27.05.10; 27.05.22; 28.19; 29.01.12

(511)

35 – რეკლამა; ბიზნესის მართვა; ბიზნესის ადმინისტრირება; საოფისე მომსახურება.

39 – ტრანსპორტირება; საქონლის შეფუთვა და დასაწყობება; მოგზაურობის ორგანიზება.

(111) M 2023 37096 R

(151) 2023 07 21

(181) 2033 07 21

(210) AM 123584

(220) 2023 07 04

(732) ალინა ბოლბატ

პარიზის კომუნას ქ. 12, მარიუპოლი,

87513, უკრაინა

(740) შალვა გიორგაძე
(540)



(591) შავ-თეთრი
(531) 11.03.02; 26.04.02; 26.04.05; 26.04.16;
26.04.22; 26.04.24; 27.03.01; 27.03.15;
27.05.01; 27.05.24

(511)
43 – საკვებით და სასმელით უზრუნველყოფა;
დროებითი საცხოვრებელი უზრუნველყოფა.

(111) M 2023 37097 R
(151) 2023 07 21
(181) 2033 07 21
(210) AM 123611
(220) 2023 07 11

(732) ილია ფროდიაშვილი
ვარკეთილი 3, II მკრ., კორპ. 23,
ბ. 49, თბილისი, საქართველო

(540)



(591) წითელი, თეთრი
(531) 26.01.01; 26.01.12; 26.04.02; 26.04.05;
26.04.06; 26.04.10; 26.04.22; 26.04.24;
26.11.12; 27.05.24; 29.01.12

(511)
4 – სამრეწველო ზეთები და საპოხი მასალა,
ცივილი; საპოხი მასალები; მტვრის შთამნთქმე-
ლი, დამატენიანებელი და შემკვრელი შედგენი-
ლობები; საწვავი და გამანათებლები; სანთლები
და პატრუქები განათებისთვის.

(111) M 2023 37098 R
(151) 2023 07 21
(181) 2033 07 21
(210) AM 123654
(220) 2023 07 13

(732) შპს „გიანთი ლოჯისტიკსი“
გულიას მოედანი, გვარდ.სამმ.მ/ტ.,
ნაკვეთ. 4/2, სართ. 3, 0114, თბილისი,
საქართველო

(540)



(591) ნაცრისფერი, მწვანე
(531) 26.11.12; 26.15.01; 27.05.01; 27.05.10;
29.01.12

(511)
39 – ტრანსპორტირება; საქონლის შეფუთვა და
დასაწყობება; მოგზაურობის ორგანიზება.

(111) M 2023 37099 R
(151) 2023 07 21
(181) 2033 07 21
(210) AM 123615
(220) 2023 07 11

(732) მოჰამადალი დარაბი
ირანის ქუჩა, ჯებელის ხეივანი 3,
თეირანი, ირანი

(740) ცოტნე ცერცვაძე
(540)



(591) წითელი, ვარდისფერი, ყვითელი,
ნაცრისფერი, ყავისფერი, ლურჯი, თეთრი,
შავი
(531) 03.04.01; 03.04.02; 03.04.04; 03.04.05;
03.04.13; 27.05.22; 29.01.15

(511)
29 – რძე, ყველი, კარაქი, იოგურტი და რძის
სხვა პროდუქტები.

(111) M 2023 37100 R
(151) 2023 07 21
(181) 2033 07 21
(210) AM 123868
(220) 2023 07 14

(732) შპს „ნექსტ სეილს“
შალვა ინასარიძის ქ. 24, ბ. 64, 6010,
ბათუმი, საქართველო

(540)



(591) შავ-თეთრი
(531) 27.05.01; 27.05.21
(511)

36 – დაზღვევა; ფინანსური საქმიანობა; ფულად-საკრედიტო საქმიანობა; უძრავ ქონებასთან დაკავშირებული საქმიანობა.

37 – სამშენებლო მომსახურება; სამონტაჟო და სარემონტო მომსახურება; სამთო მოპოვება, ნავთობისა და გაზის ჭაბურღილები.

43 – საკვებით და სასმელით უზრუნველყოფა; დროებითი საცხოვრებელი უზრუნველყოფა.

(111) M 2023 37101 R
(151) 2023 07 24
(181) 2033 07 24
(210) AM 123599
(220) 2023 07 06

(732) სს „ქართული ლუდის კომპანია“
სოფ. საგურამო, 3311, მცხეთა,
საქართველო

(540)

12 მარცვალი
12 martsvali
12 мартсвали

(591) შავ-თეთრი
(511)

32 – ლუდი; არაალკოჰოლური სასმელები; მინერალური და გაზიანი წყლები; ხილის სასმელები და წვენები; სიროფები და სხვა არაალკოჰოლური შედგენილობები სასმელების დასამზადებლად.

(111) M 2023 37102 R
(151) 2023 07 24
(181) 2033 07 24
(210) AM 123613
(220) 2023 07 11

(732) შპს „სანტე ჯი ემ თი პროდუქტები“
კახეთის გზატ. მე-10 კმ. 0182, თბილისი,
საქართველო

(540)



(591) თეთრი, 286806 მუქი მწვანე, FCF807
ყვითელი, E81414 წითელი
(531) 02.01.11; 02.01.15; 08.03.08; 08.03.09;
26.02.03; 28.19; 29.01.15

(511)
29 – ხორცი, თევზი, ფრინველი და ნანადირევი; ხორცის ექსტრაქტები; დაკონსერვებული, გაყინული, გამხმარი და მოხარშული ან შემწვარი ხილი და ბოსტნეული; ყელეები, ხილფაფები, კომპოტები; კვერცხი; რძე, ყველი, კარაქი, იოგურტი და რძის სხვა პროდუქტები; საკვები ზეთები და ცხიმები.

(111) M 2023 37103 R
(151) 2023 07 24
(181) 2033 07 24
(210) AM 123914
(220) 2023 07 19

(732) შპს „უელტექ პლუს“
მ. თამარაშვილის ქ. 13ო, ბლოკი C,
კომერციული ფართი 10, 0162,
საბურთალოს რაიონი, თბილისი,
საქართველო

(540)



(591) შავი, წითელი, თეთრი
(531) 26.01.01; 27.05.10; 27.05.17
(511)

10 – ქირურგიული, სამედიცინო, სტომატოლოგიური და ვეტერინარული აპარატურა და ინსტრუმენტები; ხელოვნური კიდურები, თვალეზი და კბილები (პროთეზები); ორთოპედიული საგნები; მასალა ქირურგიული ნაკერის დადებისთვის; უნარშეზღუდული ადამიანების საჭი-

როებებზე მორგებული თერაპიული და დამხმარე მოწყობილობები; აპარატურა მასაჟისთვის; აპარატურა, მოწყობილობები და საშუალებები ჩვილი ბავშვებისთვის; აპარატურა, მოწყობილობები და საშუალებები სექსუალური აქტივობისთვის.

44 – სამედიცინო მომსახურება; ვეტერინარული მომსახურება; ჰიგიენური და კოსმეტიკური მომსახურება ადამიანებისა და ცხოველებისთვის; მომსახურება სოფლის მეურნეობის, მებაღეობისა და მეტყევეობის სფეროში.

(111) M 2023 37155 R

(151) 2023 08 02

(181) 2033 08 02

(210) AM 123514

(220) 2023 06 29

(732) შპს „ბიარ ჯორჯია“

თევდორე მღვდლის ქ. 55, თბილისი, საქართველო

(740) გიორგი თაქთაქიშვილი

(540)



(591) ყვითელი, ოქროსფერი, თეთრი, წითელი, შავი

(531) 01.15.23; 03.04.01; 03.04.02; 03.04.05;

03.04.13; 05.07.02; 05.11.15; 17.01.02;

17.01.03; 17.05.21; 26.01.01; 26.01.15;

26.01.16; 26.01.20; 26.01.21; 28.19; 29.01.15

(526) ლაზიკა LAZIKA

(511)

32 – ლუდი; არაალკოჰოლური სასმელები; მინერალური და გაზიანი წყლები; ხილის სასმელები და წვენები; სიროფები და სხვა არაალკოჰოლური შედგენილობები სასმელების დასამზადებლად.

(111) M 2023 37164 R

(151) 2023 08 03

(181) 2033 08 03

(210) AM 124020

(220) 2023 07 24

(732) დახურული ტიპის სააქციო საზოგადოება „ტაბატერა“

ხიმიკი (ქიმიკოსები), სუმგაითის ქიმიური სამრეწველო პარკი, AZ5002, სუმგაითი,

აზერბაიჯანი

(740) გიორგი ყავლაშვილი

(540)

როიალ ქლაბ

(591) შავ-თეთრი

(511)

34 – ასანთი; სატუჩები სიგარეტისა და სიგარის მუნდმტუკებისათვის (ქარვის); თამბაქო, თუთუნის; თამბაქოს ქისები; სიგარეტის ჰილზები; სიგარეტის ფილტრები; სანთებლები; სანთების დასატენი აირიანი ბალონები; ჩიბუხები; თამბაქოს ქალაღის წიგნაკები; შთამთქმელი ქალაღი ჩიბუხისათვის; სადეჭი თამბაქო; სიგარები; საჭრელი სამარჯვები (სიგარის ბოლოს); სიგარის ყუთები; პორტსიგარები; მუნდმტუკები სიგარისათვის; სიგარეტები თამბაქოს შემცველებით; სიგარეტები; სიგარეტის დასახვევი ჯიბის მოწყობილობები; მუნდმტუკები სიგარეტისათვის; სატუჩები (სიგარეტის მუნდმტუკის); პაპიროსის, სიგარეტის ქალაღი; სიგარილოები; ჩიბუხის გასაწმენდი მოწყობილობები; კაჟი სანთებლისათვის; მოსაწევი ბალახები; ჩიბუხის სადგარები; საასანთეები; თამბაქოს ჭურჭელი; ბურნუთი; საბურნუთეები; ასანთის კოლოფები; საფერფლეები; საფურთხელები სადეჭი თამბაქოს მომხმარებლებისათვის; დამტენიანებელი კოლოფები სიგარეტისათვის; ელექტრო სიგარეტები; თხევადი ნიკოტინის ხსნარი ელექტრო სიგარეტებში გამოსაყენებლად; პირიდან გამოსაორთქლებლები მწველთათვის; არომატული ნივთიერებები თამბაქოსთვის, ეთერზეთების გარდა; არომატული ნივთიერებები ელექტრო სიგარეტებში გამოსაყენებლად, ეთერზეთების გარდა; სიგარეტის სანთებლებისთვის ფითილები; ჩილიმები.

(111) M 2023 37165 R

(151) 2023 08 03

(181) 2033 08 03

(210) AM 124064

(220) 2023 07 27

(732) დახურული ტიპის სააქციო საზოგადოება „ტაბატერა“

ხიმიკი (ქიმიკოსები), სუმგაითის ქიმიური სამრეწველო პარკი, AZ5002, სუმგაითი,

აზერბაიჯანი

(740) გიორგი ყავლაშვილი
(540)

X7

(591) შავ-თეთრი
(511)

34 – ასანთი; სატუჩეები სიგარეტისა და სიგარის მუნდშტუკებისათვის (ქარვის); თამბაქო, თუ-თუნი; თამბაქოს ქისები; სიგარეტის ჰილზები; სიგარეტის ფილტრები; სანთებლები; სანთებლის დასატენი აირიანი ბალონები; ჩიბუხები; თამბაქოს ქაღალდის წიგნაკები; შთამნთქმელი ქაღალდი ჩიბუხისათვის; საღეჭი თამბაქო; სიგარები; საჭრელი სამარჯვები (სიგარის ბოლოს); სიგარის ყუთები; პორტსიგარები; მუნდშტუკები სიგარისათვის; სიგარეტები თამბაქოს შემცვლელით; სიგარეტები; სიგარეტის დასახვევი ჯიბის მოწყობილობები; მუნდშტუკები სიგარეტისათვის; სატუჩეები (სიგარეტის მუნდშტუკის); პაპიროსის, სიგარეტის ქაღალდი; სიგარილოები; ჩიბუხის გასაწმენდი მოწყობილობები; კაჟი სანთებლისათვის; მოსაწევი ბალახები; ჩიბუხის სადგარები; საასანთეები; თამბაქოს ჭურჭელი; ბურნუთი; საბურნუთეები; ასანთის კოლოფები; საფერფლეები; საფურთხელები საღეჭი თამბაქოს მომხმარებლებისათვის; დამტენიანებელი კოლოფები სიგარეტისათვის; ელექტრო სიგარეტები; თხევადი ნიკოტინის ხსნარი ელექტრო სიგარეტებში გამოსაყენებლად; პირიდან გამოსაორთქლებლები მწველთათვის; არომატული ნივთიერებები თამბაქოსთვის, ეთერზეთების გარდა; არომატული ნივთიერებები ელექტრო სიგარეტებში გამოსაყენებლად, ეთერზეთების გარდა; სიგარეტის სანთებლებისთვის ფითილები; ჩილიმები.

(111) M 2023 37166 R
(151) 2023 08 03
(181) 2033 08 03
(210) AM 124065
(220) 2023 07 27

(732) დახურული ტიპის სააქციო საზოგადოება „ტაბატერა“
ხიმიკი (ქიმიკოსები), სუმგაითის ქიმიური სამრეწველო პარკი, AZ5002, სუმგაითი, აზერბაიჯანი

(740) გიორგი ყავლაშვილი
(540)

**პრემიერი
Premier**

(591) შავ-თეთრი
(511)

34 – ასანთი; სატუჩეები სიგარეტისა და სიგარის მუნდშტუკებისათვის (ქარვის); თამბაქო, თუ-თუნი; თამბაქოს ქისები; სიგარეტის ჰილზები; სიგარეტის ფილტრები; სანთებლები; სანთებლის დასატენი აირიანი ბალონები; ჩიბუხები; თამბაქოს ქაღალდის წიგნაკები; შთამნთქმელი ქაღალდი ჩიბუხისათვის; საღეჭი თამბაქო; სიგარები; საჭრელი სამარჯვები (სიგარის ბოლოს); სიგარის ყუთები; პორტსიგარები; მუნდშტუკები სიგარისათვის; სიგარეტები თამბაქოს შემცვლელით; სიგარეტები; სიგარეტის დასახვევი ჯიბის მოწყობილობები; მუნდშტუკები სიგარეტისათვის; სატუჩეები (სიგარეტის მუნდშტუკის); პაპიროსის, სიგარეტის ქაღალდი; სიგარილოები; ჩიბუხის გასაწმენდი მოწყობილობები; კაჟი სანთებლისათვის; მოსაწევი ბალახები; ჩიბუხის სადგარები; საასანთეები; თამბაქოს ჭურჭელი; ბურნუთი; საბურნუთეები; ასანთის კოლოფები; საფერფლეები; საფურთხელები საღეჭი თამბაქოს მომხმარებლებისათვის; დამტენიანებელი კოლოფები სიგარეტისათვის; ელექტრო სიგარეტები; თხევადი ნიკოტინის ხსნარი ელექტრო სიგარეტებში გამოსაყენებლად; პირიდან გამოსაორთქლებლები მწველთათვის; არომატული ნივთიერებები თამბაქოსთვის, ეთერზეთების გარდა; არომატული ნივთიერებები ელექტრო სიგარეტებში გამოსაყენებლად, ეთერზეთების გარდა; სიგარეტის სანთებლებისთვის ფითილები; ჩილიმები.

(111) M 2023 37167 R
(151) 2023 08 03
(181) 2033 08 03
(210) AM 124066
(220) 2023 07 27

(732) დახურული ტიპის სააქციო საზოგადოება „ტაბატერა“
ხიმიკი (ქიმიკოსები), სუმგაითის ქიმიური სამრეწველო პარკი, AZ5002, სუმგაითი, აზერბაიჯანი

(740) გიორგი ყავლაშვილი
(540)

**ლინკოლნი
Lincoln**

(591) შავ-თეთრი
(511)

34 – ასანთი; სატუჩეები სიგარეტისა და სიგარის მუნდშტუკებისათვის (ქარვის); თამბაქო, თუ-

თუნი; თამბაქოს ქისები; სიგარეტის ჰილზები; სიგარეტის ფილტრები; სანთებლები; სანთებლის დასატენი აირიანი ბალონები; ჩიბუხები; თამბაქოს ქაღალდის წიგნაკები; შთამნთქმელი ქაღალდი ჩიბუხისათვის; სადეჭი თამბაქო; სიგარები; საჭრელი სამარჯვები (სიგარის ბოლოს); სიგარის ყუთები; პორტსიგარები; მუნდ-შტუკები სიგარისათვის; სიგარეტები თამბაქოს შემცველებით; სიგარეტები; სიგარეტის დასახვევი ჯიბის მოწყობილობები; მუნდშტუკები სიგარეტისათვის; სატუჩები (სიგარეტის მუნდშტუკის); პაპიროსის, სიგარეტის ქაღალდი; სიგარილოები; ჩიბუხის გასაწმენდი მოწყობილობები; კაჟი სანთებლისათვის; მოსაწევი ბალახები; ჩიბუხის სადგარები; სასანთებები; თამბაქოს ჭურჭელი; ბურნუთი; საბურნუთეები; ასანთის კოლოფები; საფერფლეები; საფურთხელები სადეჭი თამბაქოს მომხმარებლებისათვის; დამტენიანებელი კოლოფები სიგარეტისათვის; ელექტრო სიგარეტები; თხევადი ნიკოტინის ხსნარი ელექტრო სიგარეტებში გამოსაყენებლად; პირიდან გამოსაორთქლებლები მწველთათვის; არომატული ნივთიერებები თამბაქოსთვის, ეთერზეთების გარდა; არომატული ნივთიერებები ელექტრო სიგარეტებში გამოსაყენებლად, ეთერზეთების გარდა; სიგარეტის სანთებლებისთვის ფითილები; ჩილიმები.

- (111) M 2023 37168 R
- (151) 2023 08 03
- (181) 2033 08 03
- (210) AM 124124
- (220) 2023 07 31
- (732) შპს „სამზეო“

ვაჟა-ფშაველას გამზ. 71, ვაკის რაიონი, თბილისი, საქართველო

(540)

სამზეო

- (591) შავ-თეთრი
- (511)
- 43 – საკვებით და სასმელით უზრუნველყოფა; დროებითი საცხოვრებელი უზრუნველყოფა.

- (111) M 2023 37169 R
- (151) 2023 08 03
- (181) 2033 08 03
- (210) AM 124019
- (220) 2023 07 24
- (732) იანლი იე

ლილოს დასახ. ჭირნახულის ქ. 1, ისანი-სამგორის რაიონი, თბილისი, საქართველო

(540)



- (591) შავი, თეთრი, ყვითელი, წარინჯისფერი, წითელი
- (531) 03.07.06; 27.05.01; 29.01.14
- (511)
- 25 – ტანსაცმელი, ფეხსაცმელი, თავსაბურავი.

- (111) M 2023 37170 R
- (151) 2023 08 03
- (181) 2033 08 03
- (210) AM 124053
- (220) 2023 07 27
- (732) სპირიტ ეიჯ ტექნოლოჯი ლიმიტიდ რუმ 1003, 10/F თაურ 1, ლიპპო სენტერ, 89 ქუინსვეი, ჰონგ-კონგი
- (740) გიორგი ქართველიშვილი
- (540)

FUNKY LANDS

- (591) შავ-თეთრი
- (511)
- 34 – თამბაქო; სიგარეტები თამბაქოს შემცველებით, არასამედიცინო მიზნებისთვის; ელექტრო სიგარეტები; თხევადი ხსნარები ელექტრო სიგარეტებში გამოსაყენებლად; ფილტრირანი სიგარეტები; პირიდან გამოსაორთქლებლები მწველთათვის; თხევადი ნიკოტინის ხსნარები ელექტრო სიგარეტებში გამოსაყენებლად; სიგარეტის ფილტრები; სიგარეტები; არომატული ნივთიერებები ელექტრო სიგარეტებში გამოსაყენებლად, ეთერზეთების გარდა; კარტრიჯები ელექტრო სიგარეტებისთვის; ხელსაწყოები თამბაქოს გასაცხელებლად ინჰალაციის მიზნით; ელექტრო სიგარეტების ჩიბუხები; პორტსიგარები; სიგარები; მოსაწევი ბალახები; ელექტრონული სიგარები; ელექტრო სიგარეტების ყუთები; ელექტრონული სიგარეტის შესაცვლელი და სტრუქტურული ნაწილები; ელექტრონული სიგარეტის ატომიზატორები.

(111) M 2023 37171 R
 (151) 2023 08 03
 (181) 2033 08 03
 (210) AM 124060
 (220) 2023 07 27
 (732) შპს „ნიუ ფარმა“
 ცაბაძის ქ., კორპ. 5, ბ. 32, გორი,
 საქართველო
 (540)

ფუროლინი
Furolin
Фуролини

(591) 000000 შავ-თეთრი
 (511)
 5 – ფარმაცევტული პრეპარატები; სამედიცინო დანიშნულების ჰიგიენური პრეპარატები; სამედიცინო დანიშნულების დიეტური საკვები და ნივთიერებები, ბავშვთა საკვები; დიეტური დანამატები ადამიანებისათვის; კბილის დასაბჯენი და კბილის ტვიფრის დასამზადებელი მასალა.

(111) M 2023 37172 R
 (151) 2023 08 03
 (181) 2033 08 03
 (210) AM 124059
 (220) 2023 07 27
 (732) შპს „ნიუ ფარმა“
 ცაბაძის ქ., კორპ. 5, ბ. 32, გორი,
 საქართველო
 (540)

ურსოქოლი
Ursoqol
Урсокол

(591) შავ-თეთრი
 (511)
 5 – ფარმაცევტული პრეპარატები; სამედიცინო დანიშნულების ჰიგიენური პრეპარატები; სამედიცინო დანიშნულების დიეტური საკვები და ნივთიერებები, ბავშვთა საკვები; დიეტური დანამატები ადამიანებისათვის; კბილის დასაბჯენი და კბილის ტვიფრის დასამზადებელი მასალა.

(111) M 2023 37173 R
 (151) 2023 08 03
 (181) 2033 08 03
 (210) AM 124062
 (220) 2023 07 27
 (732) ნიკოლოზ ხომერიკი
 ნუცუბიძის ქ. 55ა, თბილისი, საქართველო;
 გიორგი ჯიქია
 ცოტნე დადიანის ქ. 21, თბილისი, საქართველო
 (740) შალვა გვარამაძე
 (540)



(591) შავ-თეთრი
 (531) 19.07.01; 19.07.10; 26.02.07; 26.11.12;
 26.11.13; 27.05.01; 27.05.24
 (511)
 33 – არაყი.

(111) M 2023 37174 R
 (151) 2023 08 03
 (181) 2033 08 03
 (210) AM 123928
 (220) 2023 07 20
 (732) სს „საქართველოს ბანკი“
 გაგარინის ქ. 29ა, 0160, თბილისი,
 საქართველო
 (740) გიორგი თაქთაქიშვილი
 (540)

STEM
სკოლა

(591) შავ-თეთრი
 (511)
 35 – რეკლამა; საქმიან სფეროში მართვისა და ადმინისტრირების მომსახურება; კონსულტაციები საქმიანობის მართვისა და ორგანიზაციის საკითხებში; საგანმანათლებლო დაწესებულებებში სასაწავლო კურსების ადმინისტრაციული მომსახურების უზრუნველყოფა.

41 – განათლება; სასწავლო პროცესის უზრუნველყოფა; გართობა; სპორტული და კულტურული ღონისძიებები; აკადემიები [განათლება]; სკოლა-ინტერნატები; წიგნების გამოცემა; კულტურულ-საგანმანათლებლო და გასართობი კლუბები; კოლოკვიუმების ორგანიზება და ჩატარება; სასწავლო ან გასართობი კონკურსების ორგანიზება; კონფერენციების ორგანიზება და ჩატარება; კონგრესების ორგანიზება და ჩატარება; დაუსწრებელი სწავლება; ინფორმაცია აღზრდისა და განათლების საკითხებში; საგანმანათლებლო-აღმზრდელობითი მომსახურება; კულტურულ-საგანმანათლებლო გამოფენების ორგანიზაცია; თამაშების ინტერაქტიული უზრუნველყოფა კომპიუტერულ ქსელში; პროფესიული ორიენტირება [რჩევები განათლებისა და სწავლების სფეროში]; ბიბლიოთეკები; პრაქტიკული ჩვევების სწავლება [დემონსტრირება]; ელექტრონული წიგნებისა და ჟურნალ-გაზეთების გამოცემა; გასართობი რადიოგადაცემები; სემინარების ორგანიზება და ჩატარება; სიმპოზიუმების ორგანიზება და ჩატარება; მასტერ-კლასების ორგანიზება და ჩატარება; სასწავლო კურსების ორგანიზება; ცნობიერების ასამაღლებელი სემინარებისა და მასტერ-კლასების ჩატარება; სასწავლო კურსების მოწყობასთან, ჩატარებასა და ორგანიზაციასთან დაკავშირებული საკონსულტაციო და საინფორმაციო მომსახურება; ქველმოქმედებისა და კორპორატიული სოციალური პასუხისმგებლობის პროგრამები, კერძოდ, საგანმანათლებლო ღონისძიებების ჩატარება მასტერ-კლასებისა და სემინარების სახით; ყველა ზემოაღნიშნული მომსახურება უზრუნველყოფილი, ასევე, ონლაინ.

(111) M 2023 37175 R

(151) 2023 08 03

(181) 2033 08 03

(210) AM 123927

(220) 2023 07 20

(732) სს „საქართველოს ბანკი“
გაგარინის ქ. 29ა, 0160, თბილისი,
საქართველო

(740) გიორგი თაქთაქიშვილი

(540)

სტემ სკოლა

(591) შავ-თეთრი

(511)

35 – რეკლამა; საქმიან სფეროში მართვისა და ადმინისტრირების მომსახურება; კონსულტა-

ციები საქმიანობის მართვისა და ორგანიზაციის საკითხებში; საგანმანათლებლო დაწესებულებებში სასაწავლო კურსების ადმინისტრაციული მომსახურების უზრუნველყოფა.

41 – განათლება; სასწავლო პროცესის უზრუნველყოფა; გართობა; სპორტული და კულტურული ღონისძიებები; აკადემიები [განათლება]; სკოლა-ინტერნატები; წიგნების გამოცემა; კულტურულ-საგანმანათლებლო და გასართობი კლუბები; კოლოკვიუმების ორგანიზება და ჩატარება; სასწავლო ან გასართობი კონკურსების ორგანიზება; კონფერენციების ორგანიზება და ჩატარება; კონგრესების ორგანიზება და ჩატარება; დაუსწრებელი სწავლება; ინფორმაცია აღზრდისა და განათლების საკითხებში; საგანმანათლებლო-აღმზრდელობითი მომსახურება; კულტურულ-საგანმანათლებლო გამოფენების ორგანიზაცია; თამაშების ინტერაქტიული უზრუნველყოფა კომპიუტერულ ქსელში; პროფესიული ორიენტირება [რჩევები განათლებისა და სწავლების სფეროში]; ბიბლიოთეკები; პრაქტიკული ჩვევების სწავლება [დემონსტრირება]; ელექტრონული წიგნებისა და ჟურნალ-გაზეთების გამოცემა; გასართობი რადიოგადაცემები; სემინარების ორგანიზება და ჩატარება; სიმპოზიუმების ორგანიზება და ჩატარება; მასტერ-კლასების ორგანიზება და ჩატარება; სასწავლო კურსების ორგანიზება; ცნობიერების ასამაღლებელი სემინარებისა და მასტერ-კლასების ჩატარება; სასწავლო კურსების მოწყობასთან, ჩატარებასა და ორგანიზაციასთან დაკავშირებული საკონსულტაციო და საინფორმაციო მომსახურება; ქველმოქმედებისა და კორპორატიული სოციალური პასუხისმგებლობის პროგრამები, კერძოდ, საგანმანათლებლო ღონისძიებების ჩატარება მასტერ-კლასებისა და სემინარების სახით; ყველა ზემოაღნიშნული მომსახურება უზრუნველყოფილი, ასევე, ონლაინ.

(111) M 2023 37176 R

(151) 2023 08 03

(181) 2033 08 03

(210) AM 123926

(220) 2023 07 20

(732) სს „საქართველოს ბანკი“
გაგარინის ქ. 29ა, 0160, თბილისი,
საქართველო

(740) გიორგი თაქთაქიშვილი

(540)

იდეათეკიდან

(591) შავ-თეთრი

(511)

35 – რეკლამა; საქმიან სფეროში მართვისა და ადმინისტრირების მომსახურება; კონსულტაციები საქმიანობის მართვისა და ორგანიზაციის საკითხებში; საგანმანათლებლო დაწესებულებებში სასაწავლო კურსების ადმინისტრაციული მომსახურების უზრუნველყოფა.

41 – განათლება; სასწავლო პროცესის უზრუნველყოფა; გართობა; სპორტული და კულტურული ღონისძიებები; ბიბლიოთეკები, მათ შორის, წიგნების ხელზე გამცემი ბიბლიოთეკები, მოძრავი ბიბლიოთეკები, ელექტრონული ბიბლიოთეკები, ონლაინ აკადემიური ბიბლიოთეკები; მედიათეკის მომსახურება; ფონოთეკების მომსახურება; ბიბლიოთეკის საკონსულტაციო მომსახურება.

(111) M 2023 37177 R

(151) 2023 08 03

(181) 2033 08 03

(210) AM 123925

(220) 2023 07 20

(732) სს „საქართველოს ბანკი“

გაგარინის ქ. 29ა, 0160, თბილისი,
საქართველო

(740) გიორგი თაქთაქიშვილი

(540)

იდეა თეკა

(591) შავ-თეთრი

(511)

35 – რეკლამა; საქმიან სფეროში მართვისა და ადმინისტრირების მომსახურება; კონსულტაციები საქმიანობის მართვისა და ორგანიზაციის საკითხებში; საგანმანათლებლო დაწესებულებებში სასაწავლო კურსების ადმინისტრაციული მომსახურების უზრუნველყოფა.

41 – განათლება; სასწავლო პროცესის უზრუნველყოფა; გართობა; სპორტული და კულტურული ღონისძიებები; ბიბლიოთეკები, მათ შორის, წიგნების ხელზე გამცემი ბიბლიოთეკები, მოძრავი ბიბლიოთეკები, ელექტრონული ბიბლიოთეკები, ონლაინ აკადემიური ბიბლიოთეკები; მედიათეკის მომსახურება; ფონოთეკების მომსახურება; ბიბლიოთეკის საკონსულტაციო მომსახურება.

(111) M 2023 37178 R

(151) 2023 08 03

(181) 2033 08 03

(210) AM 123924

(220) 2023 07 20

(732) სს „საქართველოს ბანკი“

გაგარინის ქ. 29ა, 0160, თბილისი,
საქართველო

(740) გიორგი თაქთაქიშვილი

(540)

იდეათეკა

(591) შავ-თეთრი

(511)

35 – რეკლამა; საქმიან სფეროში მართვისა და ადმინისტრირების მომსახურება; კონსულტაციები საქმიანობის მართვისა და ორგანიზაციის საკითხებში; საგანმანათლებლო დაწესებულებებში სასაწავლო კურსების ადმინისტრაციული მომსახურების უზრუნველყოფა.

41 – განათლება; სასწავლო პროცესის უზრუნველყოფა; გართობა; სპორტული და კულტურული ღონისძიებები; ბიბლიოთეკები, მათ შორის, წიგნების ხელზე გამცემი ბიბლიოთეკები, მოძრავი ბიბლიოთეკები, ელექტრონული ბიბლიოთეკები, ონლაინ აკადემიური ბიბლიოთეკები; მედიათეკის მომსახურება; ფონოთეკების მომსახურება; ბიბლიოთეკის საკონსულტაციო მომსახურება.

საერთაშორისო სასაქონლო ნიშნები, რომლებზეც გამოტანილია გადაწყვეტილება დაცვის მინიჭების შესახებ

გადაწყვეტილების გასაჩივრება შესაძლებელია საქპატენტის სააპელაციო პალატაში გამოქვეყნებიდან 3 თვის ვადაში ან მცხეთის რაიონული სასამართლოს ადმინისტრაციულ საქმეთა კოლეგიაში 1 თვის ვადაში (მის.: ქ. მცხეთა, სამხედროს ქ. №17).

(260) AM 2023 106415 A*
(800) 1498397
(151) 2019 06 17
(891) 2019 06 17
(731) Inner Mongolia Yili Industrial Group Co., Ltd.
No. 1 Jinshan Road, Jinshan Development
Zone, Hohhot, 100033, Inner Mongolia, China
(540)



(591) Black, white
(531) 26.01.02; 26.01.20; 26.11.12; 28.03
(511)
29 – soymilk; almond milk-based beverages; peanut milk-based beverages; condensed milk; protein milk; coconut milk-based beverages; milk tea (milk based); milk beverages, milk predominating; almond milk; milk; soya milk; milk shakes; rice milk; cocoa milk (milk based); lactic acid bacteria drinks.

30 – Coffee beverages; tea; cubic sugar; milk slices (candy); oat flakes; high-protein cereal bars; glutinous rice balls for lantern festival; rice noodles (strip); instant noodles; instant dry vermicelli; edible starches; ice cream; frozen yogurt [confectionery ices]; ice sucker; vinegar; preparations for stiffening whipped cream; gluten additives for culinary purposes; coffee beverages with milk; chocolate beverages with milk; tea-based beverages; iced tea; caramels [candy]; confectionery; honey; corn flakes; oat-based food; muesli; cereal-based snack food; rice-based snack food; dessert mousses [confectionery]; steamed stuffed bun; pizzas; chinese take-away; cereal preparations; rice cracker (puffed food); sherbets [ices]; meat tenderizer for household purpose; unroasted coffee; cocoa beverages with milk; cocoa-based beverages; chocolate-based beverages; candy; sweetmeats [candy]; instant rices; chips [cereal products]; salt; condiments; husked oats; ice cubes; water ice; aromatic preparations for food; gluten prepared as foodstuff; coffee; artificial coffee; royal jelly; cakes; pastries; bread; cereal bars; dumpling; freeze-dried dishes with main ingredient being rice; flour; ice, natural or artificial; ice for refreshment; edible ices; ice-cream brick; yeast.

32 – sparkling water; fruit nectars, non-alcoholic; non-alcoholic beverages flavored with tea; powders used in the preparation of fruit-based beverages; legume drink; protein enriched sports drinks; preparations for making beverages; mineral water (beverages); vegetable juices [beverages]; sorbets [beverages]; non-alcoholic beverages; fermented drink made from ground beans; non-alcoholic beverages flavoured with coffee; non-alcoholic fruit extracts; non-alcoholic fruit juice beverages; whey drink; kvass (non-alcoholic beverage); smoothies; soya-based beverages, other than milk substitutes; ginger juice drink; fruit juice; water (beverage); isotonic beverages; soft drinks; pure water (beverages); vegetable drink.

(260) AM 2023 112330 A*
(800) 1582718
(151) 2021 02 15
(891) 2021 02 15
(731) Basf SE
Carl-Bosch-Str. 38, Ludwigshafen am Rhein,
Germany
(540)



(591) Black, white
(511)
5 – Insecticides.

(260) AM 2023 118977 A
(800) 1677627
(151) 2022 05 24
(891) 2022 05 24
(731) Obshchestvo s Ogranichennoy Otvetstvennostyu "Kvadrat-C"
pr-d Khlebozavodskiy, d. 7, str. 10, etazh 2,
Pom. 223, vn.ter.g.m.o. Nagatino-Sadovniki,
RU-115230 Moscow, Russian Federation
(540)



(591) Red, yellow, green, sky blue, blue and dark grey
(531) 26.13.25; 27.05.01; 27.05.09; 27.05.10;
29.01.15

(511)

3 – Abrasive paper; abrasives; adhesives for affixing false eyelashes; adhesives for affixing false hair; adhesives for cosmetic purposes; after-shave lotions; air fragrance reed diffusers; air fragrancing preparations; almond milk for cosmetic purposes; almond oil; almond soap; aloe vera preparations for cosmetic purposes; alum stones [astringents]; amber [perfume]; ammonia [volatile alkali] [detergent]; antiperspirant soap; antiperspirants [toiletries]; antistatic dryer sheets; antistatic preparations for household purposes; aromatics [essential oils]; astringents for cosmetic purposes; baby wipes impregnated with cleaning preparations; badian essence; balms, other than for medical purposes; basma [cosmetic dye]; bath preparations, not for medical purposes; bath salts, not for medical purposes; beard dyes; beauty masks; bergamot oil; bleaching preparations [decolorants] for cosmetic purposes; bleaching preparations [decolorants] for household purposes; bleaching salts; bleaching soda; body glitter; body paint for cosmetic purposes; breath freshening preparations for personal hygiene; breath freshening sprays; breath freshening strips; cake flavourings [essential oils]; cakes of toilet soap; canned pressurized air for cleaning and dusting purposes; carbides of metal [abrasives]; chemical cleaning preparations for household purposes; cleaning chalk; cleaning preparations; preparations for cleaning dentures; cleansers for intimate personal hygiene purposes, non medicated; cleansing milk for toilet purposes; cloths impregnated with a detergent for cleaning; cobblers' wax; collagen preparations for cosmetic purposes; colorants for toilet purposes; colour run prevention laundry sheets; colour-brightening chemicals for household purposes [laundry]; colour-removing preparations; corundum [abrasive]; cosmetic creams; cosmetic dyes; cosmetic kits; cosmetic pencils; cosmetic preparations for baths; cosmetic preparations for eyelashes; cosmetic preparations for skin care; cosmetic preparations for slimming purposes; cosmetics; cosmetics for animals; cosmetics for children; cotton swabs for cosmetic purposes; cotton wool for cosmetic purposes; cotton wool impregnated with make-up removing preparations; creams for leather; decorative transfers for cosmetic purposes; degreasers, other than for use in manufacturing processes; dental bleaching gels; dentifrices; denture polishes; deodorant soap; deodorants for human beings or for animals; deodorants for pets; depilatory preparations; descaling preparations for household purposes; detergents, other than for use in manufacturing operations and for medical purposes; diamantine [abrasive]; double eyelid tapes; douching preparations for personal sanitary or deodorant purposes [toiletries]; dry shampoos; dry-cleaning preparations; drying agents for dishwashing machines; eau de Cologne; emery; emery cloth; emery paper; essential oils; essential oils of cedarwood; essential oils of citron; essential oils of lemon; ethereal essences; extracts of flowers [perfu-

mes]; eye-washes, not for medical purposes; eyebrow cosmetics; eyebrow pencils; fabric softeners for laundry use; false eyelashes; false nails; flavourings for beverages [essential oils]; floor wax; floor wax removers [scouring preparations]; food flavourings [essential oils]; fumigation preparations [perfumes]; gaultheria oil; gel eye patches for cosmetic purposes; geraniol; glass cloth [abrasive cloth]; greases for cosmetic purposes; grinding preparations; hair conditioners; hair dyes; hair lotions; hair spray; hair straightening preparations; hair waving preparations; heliotropine; henna [cosmetic dye]; herbal extracts for cosmetic purposes; hydrogen peroxide for cosmetic purposes; incense; ionone [perfumery]; jasmine oil; Javelle water; joss sticks; lacquer-removing preparations; laundry bleach; laundry blueing; laundry glaze; laundry preparations; laundry soaking preparations; lavender oil; lavender water; leather bleaching preparations; leather preservatives [polishes]; preparations to make the leaves of plants shiny; lip glosses; lipstick cases; lipsticks; liquid latex body paint for cosmetic purposes; lotions for cosmetic purposes; make-up; make-up powder; make-up preparations; make-up removing preparations; mascara; massage candles for cosmetic purposes; massage gels, other than for medical purposes; micellar water; mint essence [essential oil]; mint for perfumery; moustache wax; mouthwashes, not for medical purposes; musk [perfumery]; nail art stickers; nail care preparations; nail glitter; nail varnish; nail varnish removers; neutralizers for permanent waving; non-slipping liquids for floors; non-slipping wax for floors; oil of turpentine for degreasing; oils for cleaning purposes; oils for cosmetic purposes; oils for perfumes and scents; oils for toilet purposes; paint stripping preparations; pastes for razor strops; perfumery; perfumes; petroleum jelly for cosmetic purposes; phytocosmetic preparations; polish for furniture and flooring; polishing creams; polishing paper; polishing preparations; polishing rouge; polishing stones; polishing wax; pomades for cosmetic purposes; potpourris [fragrances]; pumice stone; quillaia bark for washing; rose oil; rust removing preparations; sachets for perfuming linen; safrol; sandcloth; sandpaper; scented water; scented wood; scouring solutions; shampoos for animals [non-medicated grooming preparations]; shampoos for pets [non-medicated grooming preparations]; shampoos; shaving preparations; shaving soap; shaving stones [astringents]; shining preparations [polish]; shoe cream; shoe polish; shoe wax; shoemakers' wax; silicon carbide [abrasive]; skin whitening creams; smoothing preparations [starching]; smoothing stones; soap for brightening textile; soap for foot perspiration; soap; soda lye; stain removers; starch for laundry purposes; starch glaze for laundry purposes; sun-tanning preparations [cosmetics]; sun-screen preparations; tailors' wax; talcum powder, for toilet use; teeth whitening strips; terpenes [essential oils]; tissues impregnated with cosmetic lotions; tissues impregnated with make-up removing preparati-

ons; toilet water; toiletry preparations; toothpaste; tripoli stone for polishing; turpentine for degreasing; preparations for unblocking drain pipes; vaginal washes for personal sanitary or deodorant purposes; varnish-removing preparations; volcanic ash for cleaning; wallpaper cleaning preparations; washing soda, for cleaning; wax for parquet floors; whitening; windscreen cleaning liquids.

5 – Absorbent cotton; acai powder dietary supplements; acaricides; acetates for pharmaceutical purposes; acids for pharmaceutical purposes; acne treatment preparations; aconitine; adhesive plasters; adhesive tapes for medical purposes; adhesives for dentures; adjuvants for medical purposes; air deodorizing preparations; air purifying preparations; albumin dietary supplements; albuminous foodstuffs for medical purposes; albuminous preparations for medical purposes; alcohol for pharmaceutical purposes; aldehydes for pharmaceutical purposes; algicides; alginates dietary supplements; alginates for pharmaceutical purposes; alkaline iodides for pharmaceutical purposes; alkaloids for medical purposes; alloys of precious metals for dental purposes; almond milk for pharmaceutical purposes; aloe vera preparations for pharmaceutical purposes; aluminium acetate for pharmaceutical purposes; amino acids for medical purposes; amino acids for veterinary purposes; anaesthetics; analgesics; angostura bark for medical purposes; animal washes [insecticides]; anti-uric preparations; antibacterial handwashes; antibacterial soap; antibiotics; anticryptogamic preparations; antioxidant pills; antiparasitic collars for animals; antiparasitic preparations; antiseptic cotton; antiseptics; appetite suppressant pills; appetite suppressants for medical purposes; aseptic cotton; asthmatic tea; astringents for medical purposes; babies' diaper-pants; babies' diapers; bacterial poisons; bacterial preparations for medical and veterinary use; bacteriological preparations for medical and veterinary use; balms for medical purposes; balsamic preparations for medical purposes; bandages for dressings; barks for pharmaceutical purposes; bath preparations for medical purposes; bath salts for medical purposes; bicarbonate of soda for pharmaceutical purposes; biocides; biological preparations for medical purposes; biological preparations for veterinary purposes; biological tissue cultures for medical purposes; biological tissue cultures for veterinary purposes; bismuth preparations for pharmaceutical purposes; bismuth subnitrate for pharmaceutical purposes; blood for medical purposes; blood plasma; bone cement for surgical and orthopaedic purposes; bone void fillers comprised of living tissues; bouillons for bacteriological cultures; bacteriological culture mediums; bracelets impregnated with insect repellent; breast-nursing pads; bromine for pharmaceutical purposes; bronchodilating preparations; bunion pads; by-products of the processing of cereals for dietetic or medical purposes; cachets for pharmaceutical purposes; cachou for pharmaceutical purposes; preparations for callouses; calomel [fungici-

de]; camphor for medical purposes; camphor oil for medical purposes; cannabis for medical purposes; capsules for medicines; capsules made of dendrimer-based polymers, for pharmaceuticals; carbolineum [parasiticide]; casein dietary supplements; castor oil for medical purposes; cattle washes [insecticides]; caustic pencils; caustics for pharmaceutical purposes; cedar wood for use as an insect repellent; cellulose esters for pharmaceutical purposes; cellulose ethers for pharmaceutical purposes; cement for animal hooves; charcoal for pharmaceutical purposes; chemical conductors for electrocardiograph electrodes; chemical contraceptives; chemical preparations for medical purposes; chemical preparations for pharmaceutical purposes; chemical preparations for the diagnosis of pregnancy; chemical preparations for treating diseases affecting cereal plants; chemical preparations for treating diseases affecting vine plants; chemical preparations for treating mildew; chemical preparations for treating phyloxera; chemical preparations for treating wheat blight; chemical preparations for veterinary purposes; chemical reagents for medical or veterinary purposes; chemico-pharmaceutical preparations; chewing gum for medical purposes; chilblain preparations; chinoline for medical purposes; chloroform; cocaine for medical purposes; cod liver oil; collagen for medical purposes; collodion for pharmaceutical purposes; collyrium; compresses; condurango bark for medical purposes; contact lens cleaning preparations; solutions for contact lenses; contraceptive sponges; cooling sprays for medical purposes; corn remedies; corn rings for the feet; cotton for medical purposes; cotton swabs for medical purposes; cream of tartar for pharmaceutical purposes; creosote for pharmaceutical purposes; croton bark; crystallized rock sugar for medical purposes; cultures of microorganisms for medical or veterinary use; curare; decoctions for pharmaceutical purposes; dental abrasives; dental amalgams; dental amalgams of gold; dental cements; dental impression materials; dental lacquer; dental mastics; deodorants for clothing and textiles; deodorants, other than for human beings or for animals; deodorizers for litter trays; depuratives; preparations for destroying dry rot fungus; preparations for destroying mice; preparations for destroying noxious animals; detergents for medical purposes; diabetic bread adapted for medical use; diagnostic biomarker reagents for medical purposes; diagnostic preparations for medical purposes; diagnostic preparations for veterinary purposes; diaper changing mats, disposable, for babies; diapers for incontinence; diapers for pets; diastase for medical purposes; dietary fibre; dietary supplements for animals; dietary supplements with a cosmetic effect; dietetic beverages adapted for medical purposes; dietetic foods adapted for medical purposes; dietetic substances adapted for medical use; digestives for pharmaceutical purposes; digitalin; dill oil for medical purposes; disinfectant soap; disinfectants; disinfectants for chemical toilets; disinfectants for hygiene purposes;

dog washes [insecticides]; douching preparations for medical purposes; dressings, medical; drugs for medical purposes; elixirs [pharmaceutical preparations]; enzyme dietary supplements; enzyme preparations for medical purposes; enzyme preparations for veterinary purposes; enzymes for medical purposes; enzymes for veterinary purposes; ergot for pharmaceutical purposes; esters for pharmaceutical purposes; ethers for pharmaceutical purposes; eucalyptol for pharmaceutical purposes; extracts of hops for pharmaceutical purposes; eyepatches for medical purposes; preparations to facilitate teething; febrifuges; fennel for medical purposes; ferments for pharmaceutical purposes; first-aid boxes, filled; fish meal for pharmaceutical purposes; flour for pharmaceutical purposes; flowers of sulfur for pharmaceutical purposes; fly catching paper; fly destroying preparations; fly glue; food for babies; formic aldehyde for pharmaceutical purposes; freeze-dried food adapted for medical purposes; freeze-dried meat adapted for medical purposes; frostbite salve for pharmaceutical purposes; fumigating sticks; fumigation preparations for medical purposes; fungicides; gallic acid for pharmaceutical purposes; gamboge for medical purposes; gases for medical purposes; gauze for dressings; gelatine for medical purposes; gentian for pharmaceutical purposes; germicides; glucose dietary supplements; glucose for medical purposes; glycerine for medical purposes; glycerophosphates; greases for medical purposes; greases for veterinary purposes; guaiacol for pharmaceutical purposes; gum for medical purposes; gurjun balsam for medical purposes; haematogen; haemoglobin; haemorrhoid preparations; haemostatic pencils; headache relief sticks; herbal extracts for medical purposes; herbal teas for medicinal purposes; herbicides; homogenized food adapted for medical purposes; hormones for medical purposes; hydrastine; hydrastinine; hydrated chloral for pharmaceutical purposes; hydrogen peroxide for medical purposes; immunostimulants; infant formula; injectable dermal fillers; insect repellent incense; insect repellents; insecticidal animal shampoos; insecticidal veterinary washes; insecticides; iodides for pharmaceutical purposes; iodine for pharmaceutical purposes; iodoform; Irish moss for medical purposes; isotopes for medical purposes; jalap; jujube, medicated; lacteal flour for babies; larvae exterminating preparations; laxatives; lead water; lecithin dietary supplements; lecithin for medical purposes; leeches for medical purposes; lice treatment preparations [pediculicides]; lime-based pharmaceutical preparations; liniments; linseed dietary supplements; linseed for pharmaceutical purposes; linseed meal for pharmaceutical purposes; linseed oil dietary supplements; lint for medical purposes; liquorice for pharmaceutical purposes; lotions for pharmaceutical purposes; lotions for veterinary purposes; lupulin for pharmaceutical purposes; magnesia for pharmaceutical purposes; malt for pharmaceutical purposes; malted milk beverages

for medical purposes; mangrove bark for pharmaceutical purposes; massage candles for therapeutic purposes; massage gels for medical purposes; medical preparations for slimming purposes; medicated after-shave lotions; medicated animal feed; medicated dentifrices; medicated dry shampoos; medicated eye-washes; medicated hair lotions; medicated shampoos; medicated shampoos for pets; medicated soap; medicated sweets; medicated toiletry preparations; medicated toothpaste; medicinal alcohol; medicinal drinks; medicinal hair growth preparations; medicinal herbs; medicinal infusions; medicinal mud; medicinal oils; medicinal roots; medicinal tea; medicine cases, portable, filled; medicines for alleviating constipation; medicines for dental purposes; medicines for human purposes; medicines for veterinary purposes; melissa water for pharmaceutical purposes; menthol; mercurial ointments; preparations of microorganisms for medical or veterinary use; milk ferments for pharmaceutical purposes; milk sugar for pharmaceutical purposes; milking grease; mineral dietary supplements; mineral water salts; mineral waters for medical purposes; mint for pharmaceutical purposes; moleskin for medical purposes; mothproofing paper; mothproofing preparations; moulding wax for dentists; mouthwashes for medical purposes; mud for baths; mustard for pharmaceutical purposes; mustard plasters; myrobalan bark for pharmaceutical purposes; narcotics; nervines; nicotine gum for use as an aid to stop smoking; nicotine patches for use as aids to stop smoking; nutraceutical preparations for therapeutic or medical purposes; nutritional supplements; nutritive substances for microorganisms; oil of turpentine for pharmaceutical purposes; ointments for pharmaceutical purposes; opiates; opium; opodeldoc; ophotherapy preparations; oxygen baths; oxygen cylinders, filled, for medical purposes; oxygen for medical purposes; pants, absorbent, for incontinence; panty liners [sanitary]; paper for mustard plasters; parasiticides; pastilles for pharmaceutical purposes; pearl powder for medical purposes; pectin for pharmaceutical purposes; pediculicidal shampoos; pepsins for pharmaceutical purposes; peptones for pharmaceutical purposes; pesticides; petroleum jelly for medical purposes; pharmaceutical preparations; pharmaceutical preparations for skin care; pharmaceutical preparations for treating dandruff; pharmaceutical preparations for treating sunburn; pharmaceuticals; phenol for pharmaceutical purposes; phosphates for pharmaceutical purposes; phytotherapy preparations for medical purposes; plant extracts for pharmaceutical purposes; poisons; pollen dietary supplements; pomades for medical purposes; porcelain for dental prostheses; potassium salts for medical purposes; poultices; powder of cantharides; powdered milk for babies; pre-filled syringes for medical purposes; propolis dietary supplements; propolis for pharmaceutical purposes; protein dietary supplements; protein supplements for animals; purgatives; pyrethrum powder; quassia for medical purposes; quebracho for me-

dical purposes; quinine for medical purposes; quinquina for medical purposes; radioactive substances for medical purposes; radiological contrast substances for medical purposes; radium for medical purposes; rat poison; reagent paper for medical purposes; reagent paper for veterinary purposes; preparations for reducing sexual activity; remedies for foot perspiration; remedies for perspiration; repellents for dogs; rhubarb roots for pharmaceutical purposes; royal jelly dietary supplements; royal jelly for pharmaceutical purposes; rubber for dental purposes; salts for medical purposes; salts for mineral water baths; sanitary panties; sanitary tampons; sanitary towels; sarsaparilla for medical purposes; scapulars for surgical purposes; seawater for medicinal bathing; sedatives; semen for artificial insemination; serotherapeutic medicines; serums; personal sexual lubricants; sexual stimulant gels; siccatives [drying agents] for medical purposes; slimming pills; slug exterminating preparations; smelling salts; smoking herbs for medical purposes; sodium salts for medical purposes; soil-sterilizing preparations; solvents for removing adhesive plasters; soporifics; starch for dietetic or pharmaceutical purposes; stem cells for medical purposes; stem cells for veterinary purposes; sterilizing preparations; steroids; stick liquorice for pharmaceutical purposes; strychnine; styptic preparations; sugar for medical purposes; sulfonamides [medicines]; sulfur sticks [disinfectants]; sunburn ointments; suppositories; surgical dressings; surgical glues; surgical implants comprised of living tissues; swim diapers, disposable, for babies; swim diapers, reusable, for babies; syrups for pharmaceutical purposes; tanning pills; tartar for pharmaceutical purposes; teeth filling material; therapeutic preparations for the bath; thermal water; thymol for pharmaceutical purposes; tincture of iodine; tinctures for medical purposes; tissues impregnated with pharmaceutical lotions; tobacco extracts [insecticides]; tobacco-free cigarettes for medical purposes; tonics [medicines]; preparations of trace elements for human and animal use; transplants [living tissues]; preparations for the treatment of burns; turpentine for pharmaceutical purposes; vaccines; vaginal washes for medical purposes; vermifuges; vermin destroying preparations; vesicants; veterinary preparations; vitamin preparations; vitamin supplement patches; vulnerary sponges; wadding for medical purposes; wart pencils; wheat germ dietary supplements; yeast dietary supplements; yeast for pharmaceutical purposes; dietary biologically active supplements; nutritional supplements for medical use.

(260) AM 2023 119839 A

(800) 1689306

(151) 2022 07 05

(891) 2022 07 05

(731) Tovarishchestvo s Ogranichennoy

Otvetstvennostyu "Torgovaya Kompaniya
"PLYUS"

ulitsa Kabdolova 16, korpus 1, ofis 301,
Auezovskiy rayon, 050062 gorod Almaty,
Kazakhstan

(540)



(591) White and turquoise

(531) 25.03.01; 27.05.24; 29.01.12

(511)

10 – Bed vibrators; vibromassage apparatus; orthopedic articles; waterbeds for medical purposes; air beds for medical purposes; beds specially made for medical purposes; masks for use by medical personnel; child-birth mattresses; air mattresses for medical purposes; furniture especially made for medical purposes; gloves for massage; cushions for medical purposes; pads for preventing pressure sores on patient bodies; air pillows for medical purposes; soporific pillows for insomnia; heating cushions, electric, for medical purposes; air cushions for medical purposes.

20 – Bumper guards for cots, other than bed linen; bolsters; valet stands; coatstands; coat hangers; shoulder poles [yokes]; display stands; showcases [furniture]; newspaper display stands; covers for clothing [wardrobe]; coffins; doors for furniture; divans; mirrors [looking glasses]; hand-held mirrors [toilet mirrors]; bamboo, unworked or semi-worked; animal claws; animal hooves; coral; meerschaum; whalebone, unworked or semi-worked; stag antlers; tortoiseshell; horn, unworked or semi-worked; animal horns; rattan; corozo; plaited straw, except matting; wickerwork; hampers [baskets] for the transport of items; works of art of wood, wax, plaster or plastic; cabinet work; reeds [plaiting materials]; settees; index cabinets [furniture]; drain traps [valves] of plastic; water-pipe valves of plastic; valves, not of metal, other than parts of machines; mats for infant playpens; bed casters, not of metal; furniture casters, not of metal; bassinets; chests of drawers; console tables; lecterns; bakers' bread baskets; Moses baskets; bottle casings of wood; tool boxes, not of metal, empty; armchairs; hairdressers' chairs; deck chairs; hospital beds; waterbeds, not for medical purposes; bedsteads of wood; air beds, not for medical purposes; beds; cots for babies; edgings of plastic for furniture; brackets, not of metal, for furniture; table tops; sash fasteners, not of metal, for windows; coathooks, not of metal; curtain hooks; clothes hooks, not of metal; bag hangers, not of metal; beds for household pets; nesting boxes for household pets; ladders of wood or plastics; playpens for babies; air mattresses, not for medical purposes; camping mattresses; mattresses; furniture; furniture of metal; inflatable furniture; office furniture; school furniture; mobiles [decoration]; legs for furniture; feet for furniture; bed bases; furniture partitions of wood; freestanding partitions [furniture]; head-rests [furniture]; trays, not of metal; trestles [furniture]; magazine racks; reusable

baby changing mats; pet cushions; pillows; cushions; head support cushions for babies; anti-roll cushions for babies; air cushions, not for medical purposes; air pillows, not for medical purposes; head positioning pillows for babies; racks [furniture]; library shelves; shelves for file cabinets; furniture shelves; shelves for storage; wood ribbon; straw edgings; towel stands [furniture]; hat stands; inflatable publicity objects; counters [tables]; bedding, except linen; door handles, not of metal; knobs, not of metal; writing desks; bath seats for babies; benches [furniture]; sofas; shelving units; umbrella stands; gun racks; trolleys for computers [furniture]; lap desks; dressing tables; washstands [furniture]; typing desks; massage tables; tables of metal; wall-mounted baby changing platforms; saw benches [furniture]; desks; portable desks; tea trolleys; dinner wagons [furniture]; tables; chairs [seats]; high chairs for babies; shower chairs; chests, not of metal; stools; footstools; trolleys [furniture]; bed fittings, not of metal; furniture fittings, not of metal; chaise longues; screens [furniture]; filing cabinets; medicine cabinets; plate racks [furniture]; meat safes; bookcases; wardrobes; cupboards; bamboo curtains; slatted indoor blinds; screens for fireplaces [furniture]; lockers [furniture]; chests for toys; tool chests, not of metal, empty; boxes of wood or plastic; letter boxes, not of metal or masonry; bottle racks; scratching posts for cats; scratching posts for cats; sleeping pads [mats or cushions]; book rests [furniture]; drafting tables.

24 – Frieze [cloth]; banners of textile or plastic; velvet; household linen; diapered linen; bath linen, except clothing; bed linen; table linen, not of paper; cot bumpers [bed linen]; buckram; fustian; sleeping bag liners; felt; bunting of textile or plastic; gauze [cloth]; damask; jersey [fabric]; table runners, not of paper; druggist; shower curtains of textile or plastic; curtains of textile or plastic; net curtains; zephyr [cloth]; canvas for tapestry or embroidery; bolting cloth; baby buntings; crepe [fabric]; crepon; marabouts [cloth]; furniture coverings of textile; fabrics for textile use; filtering materials of textile; wall hangings of textile; non-woven textile fabrics; plastic material [substitute for fabrics]; textile material; tablemats of textile; bio-uac sacks being covers for sleeping bags; sleeping bags; sleeping bags for babies; moleskin [fabric]; muslin fabric; pillowcases; bed blankets; blankets for household pets; brocades; diaper changing cloths for babies; handkerchiefs of textile; picnic blankets; travelling rugs [lap robes]; coasters of textile; bed valances; linings [textile]; curtain holders of textile material; bed covers; bed covers of paper; furniture coverings of plastic; towels of textile; hemp cloth; gummed cloth, other than for stationery purposes; printers' blankets of textile; cloth; door curtains; bedsheets; eiderdowns [down coverlets]; bath mitts; shrouds; calico; taffeta [cloth]; ticks [mattress covers]; tick [linen]; lingerie fabric; fabric, impervious to gases, for aeronautical balloons; jute fabric; fabric for footwear; ra-

mie fabric; esparto fabric; rayon fabric; fibreglass fabrics for textile use; adhesive fabric for application by heat; linen cloth; upholstery fabrics; hemp fabric; lining fabric for footwear; traced cloths for embroidery; chenille fabric; printed calico cloth; knitted fabric; cotton fabrics; silk fabrics for printing patterns; woollen cloth; elastic woven fabrics; fabric; haircloth [sackcloth]; cheese cloth; tulle; trellis [cloth]; covers for cushions; covers [loose] for furniture; fitted toilet lid covers of fabric; pillow shams; cheviots [cloth]; silk [cloth]; mattress covers; face towels of textile; fabric imitating animal skins.

35 – Import-export agency services; advertising agency services; cost price analysis; rental of advertising space; marketing; marketing in the framework of software publishing; targeted marketing; business management of performing artists; organization of exhibitions for commercial or advertising purposes; organization of trade fairs for commercial or advertising purposes; commercial intermediation services; sales promotion for others; production of advertising films; distribution of samples; dissemination of advertising matter; direct mail advertising; editing of publicity texts; providing commercial information and advice for consumers in the choice of products and services; provision of an online marketplace for buyers and sellers of goods and services; provision of an online marketplace for buyers and sellers of goods and services; presentation of goods on communication media, for retail purposes; wholesale services for pharmaceutical, veterinary and sanitary preparations and medical supplies; retail services for pharmaceutical, veterinary and sanitary preparations and medical supplies.

44 – Massage; medical assistance; alternative medicine services.

(260) AM 2023 119840 A
 (800) 1689308
 (151) 2022 04 14
 (891) 2022 04 14
 (731) Qingdao Etsong Technology Co., LTD
 Room 901, No. 20, Huayang Road, Shibei
 District, Qingdao, Shandong, China
 (540)

Eter

(591) Black, white
 (531) 27.05.17
 (511)
 34 – Tobacco; cigars; cigarettes; snuff; electronic cigarettes; pipe tobacco; cigarette cases; matches; lighters for smokers; filter filaments for cigarettes.

(260) AM 2023 119841 A
 (800) 1689326
 (151) 2022 05 02
 (891) 2022 05 02
 (731) Fondazione DI Religione Don Bosco Nel
 Mondo
 Via Marsala, 42, I-00185 Roma, Italy
 (540)



**Don Bosco Global
 Youth Film Festival**

(591) Red, orange, light blue, blue and black
 (531) 07.01.24; 16.03.01; 16.03.05; 27.05.01;
 27.05.09; 27.05.19; 27.05.22; 29.01.14
 (511)
 41 – Education, training, entertainment, sport and cultural activities.

(260) AM 2023 119842 A
 (800) 1689385
 (151) 2022 09 21
 (891) 2022 09 21
 (731) Unilever IP Holdings B.V.
 Weena 455, NL-3013 AL Rotterdam,
 Netherlands
 (540)

STARCHASER

(591) Black, white
 (511)
 30 – Ice cream; water ices; frozen confectionery.

(260) AM 2023 119843 A
 (800) 1689391
 (151) 2022 09 19
 (891) 2022 09 19
 (731) Kia Corporation
 12, Heolleung-ro, Seocho-gu, Seoul 06797,
 Republic of Korea
 (540)

Kia

(591) Black, white
 (511)
 28 – Toys for domestic pets; ornaments for Christmas trees, except illumination articles and confectionery; toys; toy vehicles; dolls; toys (playthings); scale-

del vehicles; toy cars; toy aircraft; toy robots; drones [toys]; remote controls for operating scale model vehicles; electric ride-on toy cars for children or infants; toys designed to be attached to car seats; games and playthings; portable games and toys incorporating telecommunication functions; games; video game apparatus; machines for physical exercises; bags specially adapted for sports equipment; gymnastic and sporting articles; golf bags.

(260) AM 2023 119932 A
 (800) 1690518
 (151) 2022 03 02
 (891) 2022 03 02
 (731) Asos Holdings Limited
 Greater London House, Hampstead Road,
 London NW1 7FB, United Kingdom
 (540)

TOPMAN

(591) Black, white
 (511)
 25 – Clothing, footwear, headwear; outerwear; sportswear; activewear; overcoats; coats; jackets; mantillas; parkas; pelerines; ponchos; anoraks; dresses; skirts; ball gowns; prom dresses; lace dresses; wedding dresses; embroidered dresses; bridesmaid dresses; tea dresses; satin dresses; jerseys; jumper dresses; knitwear; jumpers; cardigans; pullovers; sweaters; hooded tops; hooded sweatshirts; sweatshirts; suits; uniforms; suits; wedding suits; cummerbunds; blouses; shirts; shirt fronts; short-sleeve shirts; t-shirts; tee-shirts; polo shirts; tops; tunics; trousers; pants; jeans; dungarees; shorts; jogging pants; chinos; trouser straps; braces; clothing of imitations of leather; clothing of leather; clothing of synthetic leather; bandanas; caps; beanies; berets; scarves; shower caps; earmuffs; hats; paper hats; headbands; hoods; cap peaks; top hats; turbans; veils; scarfs; shawls; ready-made clothing; shoes; boots; sandals; trainers; sneakers; leather shoes; suede shoes; heeled shoes; canvas footwear; beach shoes; footmuffs; non-slipping devices for footwear; tips for footwear; heelpieces for footwear; half-boots; heels; lace boots; slippers; soles for footwear; inner soles; footwear uppers; boot uppers; flip-flops for use as footwear; sliders being footwear; belts; money belts; bibs (not of paper); brassieres; camisoles; corsets; capes; bodices; dressing gowns; bath robes; layettes; petticoats; slips; morning coats; wristbands; collars; detachable collars; articles made from faux fur, namely, clothing, footwear and headgear; gloves; mittens; muffs; leggings; leg warmers; hosiery; socks; stocking suspenders; stockings; tights; tutus; leotards; ready-made linings; sleep masks; face masks [clothing]; face coverings [clothing]; neckties; ties; bow ties; playsuits; jumpsuits; pocket squares; pockets for clothing; lingerie; underpants; underwear; bralettes; lace underwear; satin underwear; satin sleepwear; satin camisoles; velvet camisoles; nightwear; lounge-

wear; pyjamas; nighties; sleepsuits; saris; sarongs; togas; shoulder wraps for clothing; beachwear; swimwear; swimsuits; bathing trunks; swimming costumes; bikinis; bikini tops; waistcoats; vests; tank tops; base layer clothing; bodysuits; coordinates [clothing]; costumes; fancy dress costumes; aprons; tracksuits; football clothing; football kits (football uniform); replica football kits; football boots [shoes]; studs for football boots [shoes]; socks for football; sportswear, including sportswear for football, five-a-side football, volleyball, rugby, basketball, tennis, skiing, golf, baseball, running, gymnastics and exercise in general, not included in other classes; clothing for dance; sports shoes; ballet shoes; jazz shoes; articles of golf clothing; golf shorts; golf shirts; golf caps; golf trousers; moisture-wicking sports pants; moisture-wicking sports shirts; sports bras; moisture-wicking sports bras; articles of clothing, footwear, headgear.

(260) AM 2023 119933 A
 (800) 1690522
 (151) 2021 12 30
 (891) 2021 12 30
 (731) BTL Industries
 Tzar Kaloyan str 8, BG-1000 Sofia, Bulgaria
 (540)



(591) Black, white
 (531) 26.03.23; 26.04.03; 27.05.01; 27.05.15;
 27.05.25

(511)
 10 – Medical apparatus and instruments; aesthetic apparatus and instruments for aesthetic therapy; veterinary apparatus and instruments; diagnostic apparatus for medical purposes; surgical apparatus and instruments; therapeutic apparatus and instruments; aesthetic massage apparatus; apparatus for the treatment of cellulite; therapeutic facial masks; apparatus for nerve stimulation; gynaecological and urological apparatus and instruments; cardiovascular instruments and apparatus; cardiographic apparatus and instruments; electrocardiograph monitoring apparatus; physical therapy equipment; physiotherapy and rehabilitation equipment; dental apparatus and instruments; beds specially made for medical purposes; contraceptives, non-chemical; artificial limbs; orthopedic articles; suture materials; masks and equipment for artificial respiration; apparatus for the alleviation of breathing difficulties; respirators for medical purposes; face masks for medical use; lung ventilators; protective visors for medical use; protective clothing for medical purposes.

44 – Medical services; gynecology services; medical equipment rental; cosmetic and plastic surgery; beauty

salon services; beauty salon services; liposuction services; removal of body cellulite; physiotherapy; consulting services relating to health care; massage; providing weight loss program services; mental health services; health clinic services; therapy services; hygienic and beauty care; beauty care for human beings; rental of equipment for human hygiene and beauty care.

(260) AM 2023 119934 A
 (800) 1690563
 (151) 2022 09 14
 (891) 2022 09 14
 (731) Likino bus plant – Ltd.
 Kalinina Street, 1, Likino-Dulevo, Orekhovo-Zuevo, RU-142671 Moscow region, Russian Federation

(540)



(591) Black, white
 (531) 28.05
 (511)
 12 – Motor buses; motor coaches; automobile bodies; bodies for vehicles.

(260) AM 2023 119935 A
 (800) 1690572
 (151) 2022 06 21
 (891) 2022 06 21
 (731) MHCS
 9 avenue de Champagne, F-51200 Epernay, France

(540)

BOLD OPEN DATABASE

(591) Black, white
 (511)
 38 – Provision of access to computer databases; electronic transmission of data, information, images and sounds via computer and the internet; transmission of podcasts; electronic newsletter services; provision of online forums, provision of discussion forums on the Internet, provision of user access to global computer networks, provision of access to databases, teleconferencing services; electronic messaging services; providing online chat rooms and electronic bulletin boards for transmission of messages among users in the field of general interest; providing access to an Internet site featuring technology that enables online users to create personal profiles featuring social networking information and to share such information.

42 – Computer services, namely creating virtual communities for registered users to organize groups and events, participate in discussions, and engage in social, business and community networking; computing services, namely hosting electronic infrastructure for

others for arranging and conducting interactive meetings, events and discussions via communication networks.

45 – Social introduction, networking and social introduction services for entrepreneurs; providing social services and information of a social nature in the field of entrepreneurship; providing legal information on business and entrepreneurship issues from searchable databases and directories, including text, electronic documents, databases, graphic illustrations and audiovisual information, over computer and communication networks.

(260) AM 2023 120087 A
(800) 1692250
(151) 2022 09 21
(891) 2022 09 21
(731) Unilever IP Holdings B.V.
Weena 455, NL-3013 AL Rotterdam,
Netherlands
(540)

SUNLOVER

(591) Black, white
(511)
30 – Ice cream; water ices; frozen confectionery.

(260) AM 2023 120088 A
(800) 1692315
(151) 2022 09 28
(891) 2022 09 28
(731) Bolotov Oleksii Oleksandrovykh
vul. Dvirthseva, 42, kv. 127, m. Kramatorsk
84301, Donetska obl., Ukraine
(540)

ARTAK

(591) Black, white
(511)
33 – Alcoholic beverages, except beer; alcoholic preparations for making beverages; alcoholic beverages containing fruit; aperitifs; brandy; fruit brandy; wine; fortified wines; grape wine; sparkling grape wines; dessert wines; sparkling wines; vintage wines; table wines; aperitif wines; wines; cooking wine; sparkling wine; fruit wines; sweet wines; still wines; vodka; japanese sweet grape wine containing extracts of ginseng and cinchona bark; digestifs [liqueurs and spirits]; cocktails; liqueurs; pre-mixed alcoholic beverages, other than beer-based; piquette; cider; low alcohol drinks, except beers; spirits [beverages]; distilled beverages.

(260) AM 2023 120126 A
(800) 1674058
(151) 2022 03 15
(891) 2022 10 07
(731) The William Carter Company
3438 Peachtree Road NE, Suite 1800,
Atlanta GA 30326, USA
(540)

CARTER'S

(591) Black, white
(511)
24 – Bedding for infants-namely, crib sheets, blankets, towels and face cloths, bunting.
25 – Knitted union suits, vests, drawers, clothing for infants and children-namely, underwear, swimwear, shirts, blouses, dresses, skirts, pants, slacks, shorts, coveralls, creepers, overalls, jackets, vests, sleepwear, bibs, booties, bonnets, and slippers.
35 – Retail store and on-line retail store services featuring clothing, footwear, headwear, bedding, handbags, furniture, toys, and related accessory products for infants and children.

(260) AM 2023 120192 A
(800) 1693261
(151) 2022 06 06
(891) 2022 06 06
(731) Asia Fuji Elevator Co., Ltd.
D-02, Middle Section of Shaoyang Avenue,
Shuangqing District, Shaoyang City, 422002
Hunan Province, China
(540)



(591) Black, white
(531) 26.03.01; 26.03.12; 26.03.24
(511)
7 – Crane; lifting equipment (term considered too vague by the International Bureau – Rule 13 (2) (b) of the Regulations); elevator operating device; elevator (elevator) (term considered too vague by the International Bureau – Rule 13 (2) (b) of the Regulations); escalator; lifting device (term considered too vague by the International Bureau – Rule 13 (2) (b) of the Regulations); crane (lifting device) (term considered too vague by the International Bureau – Rule 13 (2) (b) of the Regulations); moving sidewalk; hoist; stereo garage with lifting equipment (term considered too vague by the International Bureau – Rule 13 (2) (b) of the Regulations).

(260) AM 2023 120193 A
 (800) 1693264
 (151) 2022 06 14
 (891) 2022 06 14
 (731) Egis Gyógyszergyár Zrt.
 Keresztúri út 30-38., H-1106 Budapest,
 Hungary

(540)

ТРОСОЛЮТ

(591) Black, white
 (531) 28.05
 (511)
 3 – Cosmetics and cosmetic preparations.

5 – Pharmaceutical preparations for human purposes; dietetic substances adapted for medical use; dietary supplements; medicinal ointments; medicated skin creams; plasters, materials for dressings.

(260) AM 2023 120194 A
 (800) 1693265
 (151) 2022 06 14
 (891) 2022 06 14
 (731) Egis Gyógyszergyár Zrt.
 Keresztúri út 30-38., H-1106 Budapest,
 Hungary

(540)

ТРОМИЛИН

(591) Black, white
 (531) 28.05
 (511)
 3 – Cosmetics and cosmetic preparations.

5 – Pharmaceutical preparations for human purposes; dietetic substances adapted for medical use; dietary supplements; medicinal ointments; medicated skin creams; plasters, materials for dressings.

(260) AM 2023 120195 A
 (800) 1693266
 (151) 2022 06 14
 (891) 2022 06 14
 (731) Egis Gyógyszergyár Zrt.
 Keresztúri út 30-38., H-1106 Budapest,
 Hungary

(540)

ЛУЛЛОМИН

(591) Black, white
 (531) 28.05
 (511)
 3 – Cosmetics and cosmetic preparations.

5 – Pharmaceutical preparations for human purposes; dietetic substances adapted for medical use; dietary supplements; medicinal ointments; medicated skin creams; plasters, materials for dressings.

(260) AM 2023 120262 A
 (800) 1694066
 (151) 2022 06 16
 (891) 2022 06 16
 (731) Mykhailo Chobanian
 prosp. Nauky, 34, kv. 22, m. Kyiv, 03083,
 Ukraine

(540)

MIXO

(591) Black, white
 (511)
 36 – Financial analysis; banking; stock brokerage services; stocks and bonds brokerage; securities brokerage; brokerage; issuance of travelers' checks; issuance of credit cards; issuance of tokens of value; investment of funds; arranging finance for construction projects; preparation of quotes for cost estimation purposes; online banking; fiduciary; debt advisory services; electronic transfer of virtual currencies; electronic funds transfer; providing financial information; providing financial information via a website; capital investment; mortgage banking; clearing, financial; stock exchange quotations; crowdfunding; pawnbrokerage; providing rebates at participating establishments of others through use of a membership card; loans (financing); instalment loans; bail-bonding; exchanging money; processing of debit card payments; processing of credit card payments; organization of monetary collections; real estate appraisal; fiscal valuation; lending against security; mutual funds; surety services; financing services; e-wallet payment services; savings bank services; provident fund services; financial management; financial management of reimbursement payments for others; financial consultancy; financial valuation of intellectual property assets; financial appraisals in responding to requests for proposals; financial appraisals in responding to calls for tenders; financial evaluation (insurance, banking, real estate); financial sponsorship; financial research; financial exchange of virtual currency; financial customs brokerage services; clearing-houses, financial; hire-purchase financing; lease-purchase financing; business liquidation services, financial; retirement payment services.

42 – Computer system analysis; graphic arts design; graphic design of promotional materials; off-site data backup; research and development of new products for others; research in the field of telecommunications technology; duplication of computer programs; electronic data storage; electronic monitoring of personally identifying information to detect identity theft via the internet; electronic monitoring of credit card activity to detect fraud via the internet; providing information relating to computer technology and programming via a website; providing search engines for the internet; engineering; installation of computer software; information technology services provided on an outsourcing basis; computer programming; conversion of data or documents from physical to electronic

media; conversion of computer programs and data, other than physical conversion; computer technology consultancy; telecommunications technology consultancy; internet security consultancy; data security consultancy; information technology (IT) consultancy; computer software consultancy; computer security consultancy; consultancy in the design and development of computer hardware; website design consultancy; monitoring of computer systems for detecting unauthorized access or data breach; monitoring of computer systems to detect breakdowns; monitoring of computer systems by remote access; maintenance of computer software; updating of computer software; platform as a service (PaaS); user authentication services using technology for e-commerce transactions; user authentication services using single sign-on technology for online software applications; hosting computer websites; data encryption services; computer virus protection services; software as a service (SaaS); computer system design; computer software design; rental of web servers; computer rental; rental of computer software; industrial design; software development in the framework of software publishing; creating and designing website-based indexes of information for others (information technology services); technological consultancy; cloud computing; server hosting; styling (industrial design).

(260) AM 2023 120269 A

(800) 1694183

(151) 2022 09 19

(891) 2022 09 19

(731) Obshchestvo s Ogranichennoy Otvetstvennostiyu "SINDIKAOIL"

ul. Dovatorcev, dom 47 korpus B,
pomeshchenie 57, RU-355042 Stavropol,
Stavropolskiy kray, Russian Federation

(540)

ABSEL

(591) Black, white

(531) 27.05.01

(511)

1 – Agar-agar for industrial purposes; nitrogen; actinium; alkaloids; alginates for the food industry; alginates for industrial purposes; crotonic aldehyde; ammonium aldehyde; aldehydes; americium; amyl acetate; ammonia; ammonia [volatile alkali] for industrial purposes; anhydrous ammonia; acetic anhydride; anhydrides; anti-knock substances for internal combustion engines; disinfectants; antioxidants for use in the manufacture of cosmetics; antioxidants for use in the manufacture of pharmaceuticals; antioxidants for use in manufacture; antistatic preparations, other than for household purposes; antifreeze; size for use in the textile industry; argon; lead arsenate; astatine; aluminium acetate; lime acetate; lead acetate; acetate of cellulose, unprocessed; acetates [chemicals]; acetylene; acetone;

chemicals used in fermenting wine; barium; barytes; albumin [animal or vegetable, raw material]; animal albumen [raw material]; iodised albumen; malt albumen; benzene; benzol; bentonite; berkelium; bicarbonate of soda for chemical purposes; potassium dioxalate; biostimulants for plants; bichromate of potassium; bichromate of soda; bauxite; bromine for chemical purposes; albuminized paper; baryta paper; diazo paper; blueprint paper; test paper, chemical; self-toning paper [photography]; nitrate paper; sensitized paper; photometric paper; borax; agglutinants for concrete; gas purifying preparations; polish removing substances; preparations for the separation of greases; substances for preventing runs in stockings; water-softening preparations; limestone hardening substances; tanning substances; adhesives for industrial purposes; tensio-active agents; foundry binding substances; concrete-aeration chemicals; leather-dressing chemicals; chemical preparations for the manufacture of paints; chemicals for the manufacture of pigments; starch-liquifying chemicals [ungluing agents]; flower preservatives; seed preserving substances; viscose; bismuth; vitamins for the food industry; vitamins for use in the manufacture of cosmetics; vitamins for use in the manufacture of pharmaceuticals; witherite; distilled water; sea water for industrial purposes; acidulated water for recharging batteries; heavy water; lye water for the food industry; hydrogen; seaweeds [fertilizers]; grafting wax for trees; gadolinium; getters [chemically active substances]; protective gases for welding; solidified gases for industrial purposes; basic gallate of bismuth; gallium; gambier; helium; electrophoresis gels; genes of seeds for agricultural production; hydrazine; aluminium hydrate; hydrates; hypsulphites; hypochlorite of soda; ceramic glazings; glycol; expanded clay for hydroponic plant growing [substrate]; kaolin; alumina; glycerides; glycerine for industrial purposes; glucose for the food industry; glucose for industrial purposes; glucosides; gluten for the food industry; gluten for industrial purposes; holmium; hormones for hastening the ripening of fruit; peat pots for horticulture; graphene; graphite for industrial purposes; guano; humus; gurjun balsam for use in the manufacture of varnish; dextrine size; detergents for use in manufacturing processes; defoliants; diastase for industrial purposes; manganese dioxide; titanium dioxide for industrial purposes; zirconia; oil dispersants; petroleum dispersants; dispersions of plastics; dysprosium; bichloride of tin; detergent additives to gasoline; ceramic compositions for sintering [granules and powders]; chemical additives to drilling muds; chemical additives to insecticides; chemical additives for oils; chemical additives to motor fuel; chemical additives to fungicides; dolomite for industrial purposes; tan-wood; yeast for use in biofuel production; yeast for scientific purposes; europium; gelatine for photographic purposes; gelatine for industrial purposes; auxiliary fluids for use with abrasives; fluids for hydraulic circuits; liquids for removing sulphates from

batteries; power steering fluid; brake fluid; magnetic fluid for industrial purposes; transmission fluid; tree cavity fillers [forestry]; glaziers' putty; moderating materials for nuclear reactors; diatomaceous earth; fuller's earth for use in textile industry; lime chloride; isotopes for industrial purposes; active chemical ingredients; ion exchangers [chemicals]; ytterbium; yttrium; iodine for industrial purposes; iodine for chemical purposes; aluminium iodide; alkaline iodides for industrial purposes; casein for the food industry; casein for industrial purposes; kainite; potassium; californium; calomel [mercurous chloride]; gum arabic for industrial purposes; tartar other than for pharmaceutical purposes; camphor, for industrial purposes; calcium carbide; silicon carbide [raw material]; carbide; lime carbonate; magnesium carbonate; carbonates; cement [metallurgy]; cassiopium [lutetium]; catalysts; biochemical catalysts; catechu; caustics for industrial purposes; alum; ammonia alum; aluminium alum; chrome alum; quebracho for industrial purposes; ketones; kieselgur; cinematographic film, sensitized but not exposed; oxygen for industrial purposes; nitric acid; benzoic acid; boric acid for industrial purposes; tartaric acid; tungstic acid; gallic acid for the manufacture of ink; glutamic acid for industrial purposes; tannic acid; iodic acid; phenol for industrial purposes; citric acid for industrial purposes; lactic acid; formic acid; persulphuric acid; oleic acid; picric acid; pyrogallic acid; salicylic acid; sebacic acid; sulphuric acid; sulphurous acid; stearic acid; carbonic acid; spirits of vinegar [dilute acetic acid]; phosphoric acid; hydrofluoric acid; cholic acid; chromic acid; oxalic acid; acids; benzene-based acids; fatty acids; mineral acids; arsenious acid; adhesives for billposting; leather glues; adhesives for wall tiles; adhesives for wallpaper; glue for industrial purposes; gums [adhesives] for industrial purposes; birdlime; conductive adhesives; isinglass other than for stationery, household or alimentary purposes; starch paste [adhesive], other than for stationery or household purposes; stem cells other than for medical or veterinary purposes; collagen for industrial purposes; collodion; compost; beer preserving agents; preservatives for use in the pharmaceutical industry; mangrove bark for industrial purposes; tan; starch for industrial purposes; silicon; creosote for chemical purposes; krypton; xenon; xylene; xylol; biological tissue cultures, other than for medical or veterinary purposes; curium; lactose [raw material]; lactose for the food industry; lactose for industrial purposes; lanthanum; dry ice [carbon dioxide]; lecithin [raw material]; lecithin for the food industry; lecithin for industrial purposes; lithium; magnesite; manganate; oils for tanning leather; oils for currying leather; oils for preparing leather in the course of manufacture; oils for the preservation of food; transmission oil; carbolineum for the protection of plants; paper pulp; wood pulp; grafting mastic for trees; mastic for leather; mastic for tires; oil cement [putty]; synthetic materials for absorbing oil; brazing prepara-

tions; ceramic materials in particulate form, for use as filtering media; filtering materials of unprocessed plastics; filtering materials of mineral substances; filtering materials of vegetable substances; filtering materials of chemical substances; metalloids; alkaline-earth metals; alkaline metals; methane; methyl benzene; methyl benzol; flour for industrial purposes; tapioca flour for industrial purposes; potato flour for industrial purposes; soap [metallic] for industrial purposes; arsenic; emollients for industrial purposes; animal manure; nanopowders for industrial purposes; sodium; naphthalene; sal ammoniac; toxic gas neutralizers; neodymium; neon; neptunium; ammonium nitrate; nitrate of uranium; nitrates; combusting preparations [chemical additives to motor fuel]; nitrous oxide; baryta; uranium oxide; oxalates; lithia [lithium oxide]; lead oxide; antimony oxide; chromium oxide; cobalt oxide for industrial purposes; mercuric oxide; olivine [chemical preparations]; gallnuts; purification preparations; wine finings; textile-brightening chemicals; beer-clarifying and preserving agents; must-finishing preparations; reducing agents for use in photography; bases [chemical preparations]; wax-bleaching chemicals; fat-bleaching chemicals; organic digestate [fertilizer]; paste fillers for automobile body repair; pectin for the food industry; pectin for industrial purposes; pectin [photography]; perborate of soda; humus top dressing; percarbonates; hydrogen peroxide for industrial purposes; persulphates; perchlorates; foundry sand; plastisols; ferrotype plates [photography]; plasticizers; plastics, unprocessed; x-ray films, sensitized but not exposed; plutonium; chemical coatings for ophthalmic lenses; polonium; potash; potash water; earth for growing; praseodymium; rubber preservatives; masonry preservatives, except paints and oils; brickwork preservatives, except paints and oils; cement preservatives, except paints and oils; preservatives for tiles, except paints and oils; bacteriological preparations for acetification; vulcanising preparations; renovating preparations for phonograph records; currying preparations for leather; currying preparations for skins; galvanizing preparations; metal hardening preparations; fixing baths [photography]; opacifiers for glass; opacifiers for enamel; ungluing preparations; metal annealing preparations; metal tempering preparations; preparations for preventing the tarnishing of lenses; preparations for preventing the tarnishing of glass; cement-waterproofing chemicals, except paints; plant growth regulating preparations; wallpaper removing preparations; anti-boil preparations for engine coolants; fulling preparations for use in textile industry; scale removing preparations, other than for household purposes; fertilizing preparations; flashlight preparations; finishing preparations for use in the manufacture of steel; sizing preparations; animal carbon preparations; preparations of microorganisms, other than for medical and veterinary use; corrosive preparations; cryogenic preparations; dehydrating preparations for industrial purposes; degreasing

preparations for use in manufacturing processes; gum solvents; oil-bleaching chemicals; decolorants for industrial purposes; meat tenderizers for industrial purposes; preparations for stimulating cooking for industrial purposes; anti-incrustants; preparations of trace elements for plants; wetting preparations for use in the textile industry; wetting preparations for use in dyeing; wetting preparations for use in bleaching; enzyme preparations for the food industry; enzyme preparations for industrial purposes; filtering preparations for the beverages industry; chemical preparations to prevent mildew; chemical preparations to prevent wheat smut; chemical condensation preparations; chemical preparations for smoking meat; chemical preparations for facilitating the alloying of metals; chemical preparations to prevent diseases affecting vine plants; chemical preparations to prevent diseases affecting cereal plants; engine-decarbonising chemicals; fulling preparations; fuel-saving preparations; coal saving preparations; damp proofing preparations, except paints, for masonry; anti-sprouting preparations for vegetables; preparations of the distillation of wood alcohol; chemical substances for preserving foodstuffs; benzene derivatives; cellulose derivatives [chemicals]; promethium; protactinium; protein [raw material]; proteins for the food industry; proteins for use in manufacture; mordants for metals; radium for scientific purposes; radon; solvents for varnishes; anti-frothing solutions for batteries; drilling muds; galvanizing baths; solutions for cyanotyping; silver salt solutions for silvering; toning baths [photography]; rhenium; mercury; rubidium; carbon black for industrial purposes; soot for industrial or agricultural purposes; lamp black for industrial purposes; samarium; saccharin; selenium; salpetre; sulphur; carbon sulphide; silicates; aluminium silicate; silicones; scandium; topsoil; foundry molding preparations; potting soil; acrylic resins, unprocessed; conductive resins, unprocessed; synthetic resins, unprocessed; epoxy resins, unprocessed; soda ash; calcined soda; caustic soda for industrial purposes; barium compounds; fluorspar compounds; salts [fertilisers]; salts [chemical preparations]; ammoniacal salts; ammonium salts; salts of precious metals for industrial purposes; salts for galvanic cells; salt for preserving, other than for foodstuffs; salts for coloring metal; salts for industrial purposes; iron salts; gold salts; iodised salts; calcium salts; sodium salts [chemical preparations]; salt, raw; salts from rare earth metals; mercury salts; toning salts [photography]; chrome salts; chromic salts; salts of alkaline metals; rock salt; mold-release compounds; fire extinguishing compositions; compositions for the manufacture of phonograph records; compositions for the manufacture of technical ceramics; compositions for repairing inner tubes of tires [tyres]; tire repairing compositions; acid proof chemical compositions; glutinous tree-banding preparations; adhesive preparations for surgical bandages; fireproofing preparations; compositions for threading; sauce for preparing tobacco; amyl alcohol;

vinic alcohol; wood alcohol; ethyl alcohol; alcohol; adjuvants, other than for medical or veterinary purposes; cement for footwear; concrete preservatives, except paints and oils; water glass [soluble glass]; strontium; substrates for soil-free growing [agriculture]; barium sulphate; vitriol; sulphates; antimony sulphide; sulphides; benzoic sulphinide; sulphonic acids; sumac for use in tanning; superphosphates [fertilisers]; antimony; thallium; talc [magnesium silicate]; tannin; cream of tartar for the food industry; cream of tartar for industrial purposes; cream of tartar for chemical purposes; tellurium; terbium; thermal paste; tetrachlorides; carbon tetrachloride; acetylene tetrachloride; technetium; thiocarbanilide; titanite; sensitized cloth for photography; blueprint cloth; toluol; fuel for nuclear reactors; thorium; peat [fertiliser]; gum tragacanth for industrial purposes; thulium; carbonic hydrates; carbon; activated carbons; carbon for filters; animal charcoal; animal carbon; bone charcoal; blood charcoal; nitrogenous fertilisers; fish meal fertilizers; pyrolygneous acid [wood vinegar]; uranium; chemical intensifiers for paper; chemical intensifiers for rubber; vulcanisation accelerators; enzymes for the food industry; enzymes for industrial purposes; ferments for chemical purposes; milk ferments for the food industry; milk ferments for industrial purposes; milk ferments for chemical purposes; fermium; ferrocyanides; fixing solutions [photography]; flavonoids [phenolic compounds] for industrial purposes; flocculants; soldering fluxes; brazing fluxes; formic aldehyde for chemical purposes; phosphatides; phosphates [fertilisers]; phosphorus; photographic paper; photosensitive plates; sensitized photographic plates; sensitized films, unexposed; photographic developers; photographic sensitizers; chemical preparations for use in photography; photographic emulsions; francium; fluorine; chemicals for forestry, except fungicides, herbicides, insecticides and parasiticides; glass-frosting chemicals; leather-renovating chemicals; glass-staining chemicals; enamel-staining chemicals; oil-separating chemicals; water-purifying chemicals; oil-purifying chemicals; welding chemicals; condensation-preventing chemicals; stain-preventing chemicals for use on fabrics; anti-tarnishing chemicals for windows; leather-waterproofing chemicals; textile-waterproofing chemicals; chemical preparations, except pigments, for the manufacture of enamel; radiator flushing chemicals; leather-impregnating chemicals; textile-impregnating chemicals; horticulture chemicals, except fungicides, herbicides, insecticides and parasiticides; agricultural chemicals, except fungicides, weedkillers, herbicides, insecticides and parasiticides; soil conditioning preparations; chimney cleaners, chemical; industrial chemicals; color-brightening chemicals for industrial purposes; refrigerants; coolants for vehicle engines; chlorine; chlorates; hydrochlorates; aluminium chloride; magnesium chloride; chlorides; chromates; flowers of sulphur for chemical purposes; caesium; cellulose; cement for mending broken articles; cerium; prussiates;

nitrogenous lime [manure]; cymene; loam; slag [fertilisers]; size for finishing and priming; spinel [chemical preparations]; alkalis; caustic alkali; plant extracts for use in the manufacture of food; plant extracts for use in the manufacture of cosmetics; plant extracts for use in the manufacture of pharmaceuticals; tea extracts for the food industry; tea extracts for use in the manufacture of cosmetics; tea extracts for use in the manufacture of pharmaceuticals; radioactive elements for scientific purposes; rare earths; fissionable chemical elements; emulsifiers; erbium; ethane; methyl ether; sulphuric ether; ethyl ether; glycol ether; ethers; esters; cellulose ethers for industrial purposes; cellulose esters for industrial purposes.

4 – Anthracite; petrol; biomass fuel; wood briquettes; combustible briquettes; petroleum jelly for industrial purposes; wax [raw material]; ozocerite [ozokerite]; illuminating wax; industrial wax; belting wax; carnauba wax; beeswax; beeswax for use in the manufacture of cosmetics; gas for lighting; oil-gas; fuel gas; producer gas; solidified gas [fuel]; fuel; lubricating graphite; additives, non-chemical, to motor-fuel; firewood; cutting fluids; fish oil, not edible; greases for the preservation of leather; grease for leather; grease for boats; tallow; industrial grease; kerosene; coke; lanolin for use in the manufacture of cosmetics; ligroin; wax for skis; mazut; fuel oil; oils for the preservation of leather; oils for paints; oils for releasing form work [building]; oils for lighting; oil for the preservation of masonry; textile oil; lubricating oil; industrial oil; moistening oil; gear oil; coal tar oil; coal naphtha; castor oil for technical purposes; bone oil for industrial purposes; motor oil; sunflower oil for industrial purposes; rape oil for industrial purposes; lubricants; naphtha; petroleum, raw or refined; nightlights [candles]; oleine; paraffin; dust removing preparations; soya bean oil preparations for non-stick treatment of cooking utensils; non-slipping preparations for belts; coal dust [fuel]; firelighters; perfumed candles; christmas tree candles; tapers; soy candles; grease for arms [weapons]; lubricating grease; grease for belts; vaporized fuel mixtures; dust absorbing compositions; dust binding compositions for sweeping; dust laying compositions; alcohol [fuel]; stearine; benzene fuel; gas oil; lighting fuel; xylene fuel; mineral fuel; carburants; fuel with an alcoholic base; peat [fuel]; blocks of peat [fuel]; tinder; lignite; hookah charcoal; charcoal [fuel]; coal; coal briquettes; lamp wicks; wicks for candles; ceresine; wood chips for use as fuel; wood chips for smoking and flavouring foods; electrical energy; ethanol [fuel].

7 – 3D bioprinters; 3D printers; vending machines; welding machines, electric; welding apparatus, gas-operated; vulcanisation apparatus; acetylene cleaning apparatus; high pressure washers; apparatus for drawing up beer under pressure; aerated water making apparatus; aerated beverage-making machines; electrical apparatus for sealing plastics [packaging]; electric

arc cutting apparatus; electric arc welding apparatus; electric welding apparatus; inking apparatus for printing machines; soldering apparatus, electric; fittings for engine boilers; expansion tanks [parts of machines]; drums [parts of machines]; reels, mechanical, for flexible hoses; brake shoes other than for vehicles; concrete mixers [machines]; bioreactors for use in manufacturing biopharmaceuticals; reels for weaving looms; harrows; journal boxes [parts of machines]; bulldozers; hoppers [mechanical discharging]; mine borers; truck lifts; rolling mill cylinders; crank shafts; printing rollers for machines; camshafts for vehicle engines; transmission shafts, other than for land vehicles; valves [parts of machines]; fans for motors and engines; saw benches [parts of machines]; winnowers; vibrators [machines] for industrial use; bearings [parts of machines]; water heaters being parts of machines; bellows [parts of machines]; agitators; drilling rigs, floating or non-floating; lawnmowers [machines]; card clothing [parts of carding machines]; nail extractors, electric; emergency power generators; alternators; dynamos; bicycle dynamos; current generators; generators of electricity; hydraulic controls for machines, motors and engines; mufflers for motors and engines; drilling heads [parts of machines]; drilling bits [parts of machines]; cylinder heads for engines; soldering blow pipes, gas-operated; gas-operated blow torches; raking machines; stalk separators [machines]; sieves [machines or parts of machines]; mud catchers and collectors [machines]; tarring machines; rubber tracks being parts of crawlers on mining machines; rubber tracks being parts of crawlers on snow ploughs; rubber tracks being parts of crawlers on loading-unloading machines and apparatus; rubber tracks being parts of crawlers on agricultural machines; rubber tracks being parts of crawlers on construction machines; hydraulic engines and motors; aeronautical engines; aeroplane engines; engines for air cushion vehicles; compressed air engines; engines for boats; motors, other than for land vehicles; disintegrators; tympan [parts of printing presses]; holding devices for machine tools; turf removing ploughs; pump diaphragms; door closers, hydraulic; door closers, pneumatic; chisels for machines; jacks [machines]; rack and pinion jacks; moving pavements [sidewalks]; electric hand drills; domestic crushers/grinders, electric; flues for engine boilers; reapers; reapers and binders; millstones; rakes for raking machines; shredders [machines] for industrial use; kitchen grinders, electric; vegetable shredders, electric; injectors for engines; incubators for eggs; tools [parts of machines]; ski edge sharpening tools, electric; hand-held tools, other than hand-operated; agricultural implements, other than hand-operated; air condensers; control cables for machines, engines or motors; capstans; mangles; rotary steam presses, portable, for fabrics; ditches [ploughs]; carburettors; slides for knitting machines; cranks for machines, motors and engines; road rollers; pressure valves [parts of machines]; clack valves

[parts of machines]; pressure reducers [parts of machines]; hoods [parts of machines]; machine wheels; machine boiler scale collectors; shoe lasts [parts of machines]; piston rings; grease rings [parts of machines]; reapers and threshers; coalcutting machines; compressors [machines]; air pumps [garage installations]; compressors for refrigerators; conveyors [machines]; belt conveyors; converters for steelworks; condensers [steam] [parts of machines]; aerocondensers; diggers [machines]; rams [machines]; thermic lances [machines]; mechanized livestock feeders; boxes for matrices [printing]; grease boxes [parts of machines]; housings [parts of machines]; harvesting machines; steam engine boilers; coffee grinders, other than hand-operated; taps [parts of machines, engines or motors]; cranes [lifting and hoisting apparatus]; roller bridges; mobile cranes; drain cocks; spray guns for paint; cranks [parts of machines]; potters' wheels; grindstones [parts of machines]; cultivators [machines]; soldering lamps; winches; blades [parts of machines]; ploughshares; belts for conveyors; lubricators [parts of machines]; igniting magnetos; handling machines, automatic [manipulators]; churns; matrices for use in printing; machine fly-wheels; shearing machines for animals; blowing machines; knitting machines; galvanizing machines; bending machines; ironing machines; mineworking machines; blowing machines for the compression, exhaustion and transport of gases; blowing machines for the compression, sucking and carrying of grain; net hauling machines [fishing]; electroplating machines; bottle sealing machines; sealing machines for industrial purposes; embossing machines; engraving machines; finishing machines; crushing machines; waste disposals; stropping machines; earth moving machines; cord making machines; lace making machines; butter machines; cigarette machines for industrial purposes; sausage machines; stereotype machines; hosiery looms; dyeing machines; bottle washing machines; dishwashers; machines for the application of sizing; bottle filling machines; cheese slicers, electric; racket stringing machines; leatherworking machines; dairy machines; glass working machines; tobacco processing machines; corn husking machines; painting machines; oil refining machines; peeling machines; machines for processing plastics; ore treating machines; printing machines for use on sheet metal; brewing machines; whitewashing machines; road sweeping machines [self-propelled]; leather paring machines; machines for generating gas by electrolysis; bitumen making machines; papermaking machines; pasta making machines, electric; sugar making machines; weeding machines; sifting machines; cinder sifters [machines]; puddling machines; notchers [machine tools]; bread cutting machines; road making machines; railroad constructing machines; machines for the textile industry; rammers [machines]; rail-laying machines; bottle capping machines; bottle stoppering machines; trash compacting machines; vegetable peelers, electric; die-stamping machines;

stamping machines; darning machines; milking machines; drainage machines; wrapping machines; grain separators; bookbinding apparatus and machines for industrial purposes; machines and apparatus for cleaning, electric; machines and apparatus for carpet shampooing, electric; machines and apparatus for polishing [electric]; punching machines; riveting machines; kitchen machines, electric; foundry machines; smoothing presses; fleshing machines; flour mill machines; type-setting machines [printing]; hemming machines; grating machines for vegetables; braiding machines; rinsing machines; wringing machines for laundry; cutting machines; steam engines; printing machines; rotary printing presses; industrial inkjet printing machines; compressed air machines; tilling machines for agricultural purposes; trimming machines; spinning machines; filling machines; friezing machines; cutters [machines]; satinizing machines; agricultural machines; mixing machines; sorting machines for industry; stitching machines; washing machines [laundry]; coin-operated washing machines; laundry washing machines incorporating a drying tumbler; clippers [machines]; spinning frames; looms; kneading machines; typographic machines; type-setting machines [photocomposition]; beating machines; beaters, electric; packing machines; packaging machines; filtering machines; molding machines; carding machines; sewing machines; typecasting machines; electromechanical machines for chemical industry; labelers [machines]; mills [machines]; mills for household purposes, other than hand-operated; centrifugal mills; machine wheelwork; feeders [parts of machines]; transmission mechanisms, other than for land vehicles; forge bellows; mixers [machines]; blenders, electric, for household purposes; vacuum cleaner bags; threshing machines; pneumatic hammers; hammers [parts of machines]; tilt hammers; power hammers; reeling apparatus, mechanical; motorized cultivators; motors for boats; meat choppers, electric; superchargers; guides for machines; suction nozzles for vacuum cleaners; vacuum cleaner attachments for disseminating perfumes and disinfectants; pumps [machines]; pumps [parts of machines, engines or motors]; aerating pumps for aquaria; vacuum pumps [machines]; compressed air pumps; pumps for heating installations; beer pumps; pumps for counter-current swimming; lubricating pumps; self-regulating fuel pumps; fuel dispensing pumps for service stations; centrifugal pumps; hydrogen dispensing pumps for service stations; tin openers, electric; knives for mowing machines; chaff cutter blades; knives, electric; knives being parts of machines; shears, electric; scissors, electric; vegetable spiralizers, electric; engine mounts, other than for land vehicles; bearing brackets for machines; spraying machines; axles for machines; steam traps; chucks [parts of machines]; drill chucks [parts of machines]; exhaust manifold for engines; soldering irons, gas-operated; soldering irons, electric; superheaters; gears, other than for land vehicles; re-

duction gears other than for land vehicles; drilling machines; saws [machines]; chain saws; guns [tools using explosive cartridges]; glue guns, electric; compressed air guns for the extrusion of mastics; carburetter feeders; feeding apparatus for engine boilers; loading ramps; ploughs; pneumatic transporters; pneumatic controls for machines, motors and engines; hangers [parts of machines]; anti-friction pads for machines; roller bearings; self-oiling bearings; bearings for transmission shafts; ball-bearings; elevators [lifts]; hoists; lifts, other than ski-lifts; pulleys; saw blades [parts of machines]; pistons [parts of machines or engines]; plunger pistons; pistons for engines; pistons for cylinders; catalytic converters; torque converters other than for land vehicles; fuel conversion apparatus for internal combustion engines; presses [machines for industrial purposes]; wine presses; fodder presses; basket presses; printing presses; typographic presses; swaging machines; pneumatic or hydraulic linear actuators, other than for land vehicles; pedal drives for sewing machines; portable laser imprinters; cleaning appliances utilizing steam; food processors, electric; springs [parts of machines]; spinning wheels; punches for punching machines; vacuum cleaners; touchless stationary vacuums; radiators [cooling] for motors and engines; sewage pulverisers; air brushes for applying colour; regulators [parts of machines]; pressure regulators [parts of machines]; speed governors for machines, engines and motors; cutting blow pipes, gas-operated; blade holders [parts of machines]; loom shafts; gears for weaving looms; belts for machines; lift belts; fan belts for motors and engines; dynamo belts; belts for motors and engines; adhesive bands for pulleys; industrial robots; household cleaning and laundry robots with artificial intelligence; 3d printing pens; kick starters for motorcycles; joysticks being parts of machines, other than for game machines; stuffing boxes [parts of machines]; paper feeders [printing]; whisks, electric, for household purposes; sparking plugs for internal combustion engines; glow plugs for diesel engines; tedding machines; steam/oil separators; cream/milk separators; ball rings for bearings; sowers [machines]; pigs for cleaning pipes; snow ploughs; sheaf-binding machines; shaft couplings [machines]; juice extractors, electric; chaff cutters; teat cups for milking machines; stands for machines; machine tools; nut-tapping machines; wood-working machines; sharpening machines; bicycle assembling machines; paring machines; stone working machines; metalworking machines; size adjustment cutting machines for industrial purposes; threading machines; trueing machines; planing machines; lathes [machine tools]; milling machines; metal drawing machines; rolling mills; starters for motors and engines; stators [parts of machines]; glaziers' diamonds [parts of machines]; tables for machines; derricks; slide rests [parts of machines]; spin dryers [not heated]; heat exchangers [parts of machines]; transmissions for machines; boiler tubes [parts of machines]; wind turbi-

nes; hydraulic turbines; turbocompressors; central vacuum cleaning installations; suction machines for industrial purposes; machines for the mineralization of drinking water; vehicle washing installations; degreasers [machines]; dust exhausting installations for cleaning purposes; sifting installations; pneumatic tube conveyors; dust removing installations for cleaning purposes; condensing installations; floating production, storage and offloading [fpso] units; pneumatic waste oil drainers; lifting apparatus; air suction machines; dividing machines; igniting devices for internal combustion engines; washing apparatus; binding apparatus for hay; extractors for mines; hydraulic door openers and closers [parts of machines]; pneumatic door openers and closers [parts of machines]; door openers, electric; curtain drawing devices, electrically operated; adhesive tape dispensers [machines]; anti-pollution devices for motors and engines; beverage preparation machines, electromechanical; food preparation machines, electromechanical; portable ultrasonic washing devices for laundry; lift operating apparatus; control mechanisms for machines, engines or motors; shoe polishers, electric; machines and apparatus for wax-polishing, electric; air cushion devices for moving loads; handling apparatus for loading and unloading; elevating apparatus; carriage aprons; filter presses; filters for cleaning cooling air, for engines; filters being parts of machines or engines; molds [parts of machines]; printing plates; journals [parts of machines]; centrifugal machines; elevator chains [parts of machines]; driving chains other than for land vehicles; cylinders for motors and engines; cylinders for machines; printing cylinders; pneumatic jacks; shuttles [parts of machines]; universal joints [cardan joints]; connecting rods for machines, motors and engines; steam mops; pulleys [parts of machines]; vacuum cleaner hoses; screwdrivers, electric; brushes [parts of machines]; dynamo brushes; brushes for vacuum cleaners; brushes, electrically operated; carbon brushes [electricity]; ejectors; robotic exoskeleton suits, other than for medical purposes.

9 – 3D scanners; DVD players; ticket dispensers; juke boxes, musical; fire engines; answering machines; electrical adapters; batteries for electronic cigarettes; accumulators, electric; batteries, electric, for vehicles; accelerometers; actinometers; alidades; breathalyzers; altimeters; ammeters; apparatus for testing breast milk, other than for medical or veterinary use; nanoparticle size analysers; anemometers; anodes; aerials; anticathodes; apertometers [optics]; high-frequency apparatus; testing apparatus not for medical purposes; electro-dynamic apparatus for the remote control of railway points; electrodynamic apparatus for the remote control of signals; monitoring apparatus, other than for medical purposes; sound recording apparatus; global positioning system [gps] apparatus; remote control apparatus; distillation apparatus for scientific purposes; diffraction apparatus [microscopy]; air analysis apparatus; apparatus to check franking; sound

transmitting apparatus; breathing apparatus for underwater swimming; breathing apparatus, except for artificial respiration; apparatus and installations for the production of x-rays, not for medical purposes; cash registers; electric apparatus for commutation; intercommunication apparatus; stills for laboratory experiments; projection apparatus; fire extinguishing apparatus; radiological apparatus for industrial purposes; x-ray apparatus not for medical purposes; blueprint apparatus; blinkers [signalling lights]; stereoscopic apparatus; telephone apparatus; facsimile machines; fermentation apparatus for laboratory use; phototelegraphy apparatus; electric apparatus for remote ignition; acid hydrometers; salinometers; acidimeters for batteries; aerometers; beacons, luminous; battery jars; automated teller machines [atm]; barometers; anode batteries; galvanic batteries; solar batteries; solar panels for the production of electricity; batteries, electric; balances [steelyards]; betatrons; binoculars; bioreactors for cell culturing for scientific research; bioreactors for laboratory use; biochips; electronic tags for goods; lens hoods; magnetic tape units for computers; computer memory devices; fire hose nozzles; encoded identification bracelets, magnetic; connected bracelets [measuring instruments]; safety tarpaulins; electronic key fobs being remote control apparatus; bulletproof clothing; signalling buoys; life buoys; marking buoys; directional compasses; vacuum gauges; variometers; internal cooling fans for computers; verniers; scales; baby scales; bathroom scales; letter scales; weighbridges; precision balances; scales with body mass analysers; rods [surveying instruments]; camcorders; video baby monitors; video cassettes; video projectors; video telephones; video screens; viewfinders, photographic; electric plugs; micrometer screws for optical instruments; viscosimeters; circuit closers; wavemeters; voltmeters; flash lamps for smartphones; mechanical signs; switchboxes [electricity]; current rectifiers; gas testing instruments; gasometers [measuring instruments]; galvanometers; hands free kits for phones; headsets; headsets for playing video games; heliographic apparatus; apparatus for generating gas for calibration purposes; hygrometers; hydrometers; weights; peepholes [magnifying lenses] for doors; hairdressing training heads [teaching apparatus]; holograms; plotters; sounding leads; plumb bobs; telemeters; gauges; parking sensors for vehicles; piezoelectric sensors; densimeters; densitometers; holders adapted for mobile telephones and smartphones; detectors; smoke detectors; infrared detectors; false coin detectors; joysticks for use with computers, other than for video games; slides [photography]; slide projectors; diaphragms [photography]; dictating machines; thin film speakers; wearable speakers; dynamometers; light-emitting diodes [led]; quantum dot light-emitting diodes [qled]; organic light-emitting diodes [oled]; floppy disks; phonograph records; disks, magnetic; optical discs; calculating disks; disk drives for computers; juke boxes for com-

puters; head-mounted displays; wearable video display monitors; electronic numeric displays; dna chips; electronic interactive whiteboards; electronic notice boards; electric wire harnesses for automobiles; bullet-proof waistcoats; life jackets; reflective safety vests; identification threads for electric wires; nose clips for divers and swimmers; biometric locks; padlocks, electronic; locks, electric; bells [warning devices]; alarm bells, electric; electric door bells; signal bells; acoustic conduits; mirrors for inspecting work; safety signs [luminous]; road signs, luminous or mechanical; warning signs [luminous]; signs, luminous; downloadable emoticons for mobile phones; marine depth finders; probes for scientific purposes; buzzers; needles for surveying compasses; styli for record players; eyewear; reflective articles for wear, for the prevention of accidents; measures; pressure measuring apparatus; simulators for the steering and control of vehicles; inverters [electricity]; pressure indicators; automatic indicators of low pressure in vehicle tyres; temperature indicators; incubators for bacteria culture; measuring instruments; cosmographic instruments; mathematical instruments; levelling instruments; instruments containing eyepieces; surveying instruments; azimuth instruments; interfaces for computers; ionization apparatus not for the treatment of air or water; satellite finder meters; spark-guards; coaxial cables; fibre [fiber (am.)] optic cables; cables, electric; calipers; slide calipers; screw-tapping gauges; calorimeters; calculating machines; pocket calculators; decompression chambers; rearview cameras for vehicles; cinematographic cameras; thermal imaging cameras; mouth guards for sports; life-saving capsules for natural disasters; electronic pens [visual display units]; holders for electric coils; biometric identity cards; identity cards, magnetic; video game cartridges; ink cartridges, unfilled, for printers and photocopiers; memory cards for video game machines; encoded magnetic cards; riding helmets; protective helmets; carriers for dark plates [photography]; cathodes; spools [photography]; choking coils [impedance]; coils, electric; electromagnetic coils; cinematographic film, exposed; computer keyboards; solenoid valves [electromagnetic switches]; wire connectors [electricity]; thin client computers; downloadable cryptographic keys for receiving and spending crypto assets; encoded key cards; electronic book readers; electronic agendas; push buttons for bells; dashboard mats adapted for holding mobile telephones and smartphones; magnetic encoders; visors for helmets; collectors, electric; portable speakers; calibrating rings; smart rings; mobile phone ring holders; mobile phone ring stands; ring sizers; protective suits for aviators; commutators; compact discs [audio-video]; comparators; marine compasses; computers; quantum computers; laptop computers; tablet computers; notebook computers; wearable computers; capacitors; contacts, electric; controllers for servo motors; smart home hubs; musical instrument digital interface controllers being audio inter-

faces; electronic controllers for servo motors; wind socks for indicating wind direction; traffic cones; branch boxes [electricity]; distribution boxes [electricity]; junction boxes [electricity]; battery boxes; cabinets for loudspeakers; diving suits; haptic suits, other than for medical purposes; downloadable e-wallets; evacuation chairs; galena crystals [detectors]; covers for electric outlets; logs [measuring instruments]; lasers, not for medical purposes; lactodensimeters; lactometers; vacuum tubes [radio]; darkroom lamps [photography]; selfie ring lights for smartphones; thermionic tubes; amplifying tubes; flashlights [photography]; head cleaning tapes [recording]; magnetic tapes; videotapes; surveying chains; fire escapes; rulers [measuring instruments]; square rulers for measuring; slide-rules; circular slide rules; contact lenses; correcting lenses [optics]; optical lenses; optical condensers; sounding lines; electricity conduits; measuring spoons; magnifying glasses [optics]; waling glasses; magnets; decorative magnets; crash test dummies; resuscitation mannequins [teaching apparatus]; trackballs [computer peripherals]; manometers; security tokens [encryption devices]; divers' masks; solderers' helmets; protective masks, not for medical purposes; dust masks incorporating air purification; respiratory masks, other than for artificial respiration; materials for electricity mains [wires, cables]; voting machines; money counting and sorting machines; material testing instruments and machines; furniture especially made for laboratories; megaphones; portable media players; diaphragms [acoustics]; diaphragms for scientific apparatus; metal detectors for industrial or military purposes; digital weather stations; metronomes; rules [measuring instruments]; carpenters' rules; dressmakers' measures; mechanisms for coin-operated apparatus; mechanisms for counter-operated apparatus; coin-operated mechanisms for television sets; shutter releases [photography]; micrometers; microprocessors; microscopes; microtomes; microphones; wireless speaker microphones; audio mixers; modems; lightning arresters; monitors [computer hardware]; monitors [computer programs]; selfie sticks [hand-held monopods]; terminals [electricity]; junction sleeves for electric cables; data sets, recorded or downloadable; teeth protectors; temperature indicator labels, not for medical purposes; knee-pads for workers; headphones; earpieces for remote communication; surveyors' levels; sound recording carriers; magnetic data media; optical data media; electronic sheet music, downloadable; computer game software, recorded; computer software, recorded; downloadable computer software for managing cryptocurrency transactions using blockchain technology; software as a medical device [samd], downloadable; sheaths for electric cables; identification sheaths for electric wires; weighing machines; computer hardware; punched card machines for offices; shoes for protection against accidents, irradiation and fire; objectives [lenses] [optics]; lenses for astrophotography; selfie lenses; egg-candlers; fire

extinguishers; rescue laser signalling flares; electrified fences; limiters [electricity]; clothing for protection against accidents, irradiation and fire; clothing for protection against fire; asbestos clothing for protection against fire; clothing especially made for laboratories; survival blankets; ozonisers [ozonators]; octants; eyepieces; ohmmeters; wrist rests for use with computers; spectacle frames; oscillographs; plumb lines; mirrors [optics]; spectacles [optics]; spectacles for correcting colour blindness; sunglasses; goggles for sports; electronic collars to train animals; finger sizers; signalling panels, luminous or mechanical; biometric passports; wah-wah pedals; effects pedals for guitars; radio pagers; pince-nez; electronic pocket translators; transmitters [telecommunication]; telephone transmitters; transmitters of electronic signals; switches, electric; periscopes; data gloves; gloves for divers; gloves for protection against accidents; gloves for protection against x-rays for industrial purposes; asbestos gloves for protection against accidents; ovens for laboratory use; droppers for measuring, other than for medical or household purposes; laboratory pipettes; pyrometers; planimeters; plane tables [surveying instruments]; plates for batteries; computer software platforms, recorded or downloadable; wafers for integrated circuits; printed circuit boards; compact disc players; cassette players; sound recording strips; mobile phone screen protectors; x-ray films, exposed; films, exposed; life-saving rafts; animal signalling rattles for directing livestock; laboratory trays; digital signs; stands adapted for laptops; in-car telephone handset cradles; cooling pads for laptop computers; airbags for safety purposes for fall protection; semiconductors; polarimeters; personal digital assistants [pdas]; fire pumps; graduated glassware; weight belts for divers; life belts; fuses; circuit breakers; converters, electric; telerupters; food analysis apparatus; diagnostic apparatus, not for medical purposes; distance recording apparatus; distance measuring apparatus; speed measuring apparatus [photography]; appliances for measuring the thickness of leather; apparatus for measuring the thickness of skins; speed checking apparatus for vehicles; teaching apparatus; time recording apparatus; apparatus and instruments for astronomy; surveying apparatus and instruments; weighing apparatus and instruments; nautical apparatus and instruments; navigational instruments; optical apparatus and instruments; apparatus and instruments for physics; chemistry apparatus and instruments; measuring apparatus; measuring devices, electric; boiler control instruments; meteorological instruments; naval signalling apparatus; observation instruments; navigation apparatus for vehicles [on-board computers]; satellite navigational apparatus; regulating apparatus, electric; telecommunication apparatus in the form of jewellery; precision measuring apparatus; electric actuators; electric linear actuators; audio – and video-receivers; prisms [optics]; computer software applications, downloadable; wireless portable printers for use with

laptops and mobile devices; ticket printers; printers for use with computers; hemline markers; retorts' stands; apparatus for changing record player needles; photographic racks; cleaning apparatus for phonograph records; fire beaters; sighting telescopes for firearms; telescopic sights for artillery; test tubes; pressure indicator plugs for valves; magnetic wires; telegraph wires; telephone wires; wires, electric; conductors, electric; copper wire, insulated; fuse wire; computer programs, recorded; computer game software, downloadable; computer programs, downloadable; computer operating programs, recorded; computer screen saver software, recorded or downloadable; record players; central processing units [processors]; rods for water diviners; electronic publications, downloadable; distribution consoles [electricity]; control panels [electricity]; radar apparatus; baby monitors; masts for wireless aerials; transmitting sets [telecommunication]; radios; vehicle radios; sprinkler systems for fire protection; frames for photographic transparencies; screens for photoengraving; flowmeters; walkie-talkies; voltage surge protectors; voltage regulators for vehicles; stage lighting regulators; speed regulators for record players; reducers [electricity]; washing trays [photography]; marking gauges [joinery]; t-squares for measuring; time switches, automatic; relays, electric; safety restraints, other than for vehicle seats and sports equipment; body harnesses for support when lifting loads; x-ray photographs, other than for medical purposes; rheostats; respirators for filtering air; retorts; refractometers; refractors; grids for batteries; security surveillance robots; laboratory robots; teaching robots; telepresence robots; humanoid robots with artificial intelligence for use in scientific research; electric sockets; height measuring instruments; speaking tubes; horns for loudspeakers; subwoofers; saccharometers; light conducting filaments [optical fibers [fibres]]; traffic-light apparatus [signalling devices]; dog whistles; signalling whistles; sports whistles; sextants; inductors [electricity]; life nets; nets for protection against accidents; fire alarms; signals, luminous or mechanical; rescue flares, non-explosive and non-pyrotechnic; sirens; electronic access control systems for interlocking doors; scanners [apparatus] for performing automotive diagnostics; hand-held electronic dictionaries; smart speakers; integrated circuit cards [smart cards]; smartglasses; smartphones; foldable smartphones; smartwatches; connections for electric lines; couplings, electric; sonars; sound locating instruments; lighting ballasts; resistances, electric; spectrograph apparatus; spectrocopes; speed indicators; alcoholmeters; satellites for scientific purposes; protection devices for personal use against accidents; audiovisual teaching apparatus; charging stations for electric vehicles; radiotelegraphy sets; radiotelephony sets; spectacle lenses; anti-glare glasses; optical glass; personal stereos; stereoscopes; stands for photographic apparatus; stroboscopes; fire boats; sulphitometers; bags adapted for laptops; dry-

ing racks [photography]; spherometers; integrated circuits; printed circuits; meters; parking meters; mileage recorders for vehicles; portable ultrafine dust meters; revolution counters; abacuses; hourglasses; taximeters; ear plugs for divers; tachometers; television apparatus; telegraphs [apparatus]; telescopes; teleprompters; teleprinters; cordless telephones; theodolites; credit card terminals; interactive touch screen terminals; thermo-hygrometers; thermometers, not for medical purposes; thermostats; thermostats for vehicles; climate control digital thermostats; cupels [laboratory]; tone arms for record players; totalizers; transistors [electronic]; transponders; protractors [measuring instruments]; transformers [electricity]; step-up transformers; resuscitation training simulators; vehicle breakdown warning triangles; triodes; starter cables for motors; electric discharge tubes, other than for lighting; capillary tubes for laboratory use; neon signs; pitot tubes; x-ray tubes not for medical purposes; telephone receivers; headgear being protective helmets; squares for measuring; quantity indicators; petrol gauges; water level indicators; electric loss indicators; light-emitting electronic pointers; clinometers; levels [instruments for determining the horizontal]; mercury levels; spirit levels; urinometers; amplifiers for servo motors; amplifiers; particle accelerators; electric installations for the remote control of industrial operations; steering apparatus, automatic, for vehicles; balancing apparatus; video recorders; sound reproduction apparatus; invoicing machines; tape recorders; protection devices against x-rays, not for medical purposes; railway traffic safety appliances; data processing apparatus; oxygen transvasing apparatus; theft prevention installations, electric; devices for the projection of virtual keyboards; film cutting apparatus; drying apparatus for photographic prints; optical character readers; centering apparatus for photographic transparencies; dosimeters; battery chargers; mobile phone chargers; chargers for electric batteries; chargers for electronic cigarettes; sound alarms; sounding apparatus and machines; life-saving apparatus and equipment; apparatus for editing cinematographic film; cathodic anti-corrosion apparatus; couplers [data processing equipment]; anti-theft warning apparatus; computer peripheral devices; anti-interference devices [electricity]; demagnetizing apparatus for magnetic tapes; acoustic couplers; alarms; fog signals, non-explosive; whistle alarms; adding machines; readers [data processing equipment]; heat regulating apparatus; photocopiers [photographic, electrostatic, thermic]; electric and electronic effects units for musical instruments; bar code readers; head-up display apparatus for vehicles; downloadable ring tones for mobile phones; downloadable image files; downloadable music files; animated cartoons; filters for respiratory masks; filters for ultraviolet rays, for photography; filters for use in photography; usb flash drives; magic lanterns; optical lamps; signal lanterns; cameras [photography]; glazing apparatus for photographic prints; shutters

[photography]; darkrooms [photography]; photometers; flash-bulbs [photography]; digital photo frames; enlarging apparatus [photography]; photovoltaic cells; containers for contact lenses; contact lens cases incorporating ultrasonic cleaning functions; spectacle cases; containers for microscope slides; cases especially made for photographic apparatus and instruments; chromatography apparatus for laboratory use; chronographs [time recording apparatus]; laboratory centrifuges; spectacle chains; cyclotrons; compasses for measuring; frequency meters; time clocks [time recording devices]; petri dishes; sleeves for laptops; covers for personal digital assistants [pdas]; covers for tablet computers; fire blankets; chips [integrated circuits]; jigs [measuring instruments]; pedometers; fire-extinguishing balls; meteorological balloons; electrified rails for mounting spot lights; asbestos screens for firemen; fire hose; virtual reality headsets; protective helmets for sports; neural helmets, not for medical purposes; head guards for sports; lifeboats; snorkels; cell phone straps; spectacle cords; tripods for cameras; switchboards; distribution boards [electricity]; equalizers [audio apparatus]; workmen's protective face-shields; projection screens; radiology screens for industrial purposes; fluorescent screens; exposure meters [light meters]; electrolysis apparatus for laboratory use; ducts [electricity]; galvanic cells; downloadable graphics for mobile phones; epidiascopes; ergometers; armatures [electricity]; black boxes [data recorders].

11 – Lamp shades; steam accumulators; heat accumulators; defrosters for vehicles; adsorption apparatus for generating gas; disinfectant apparatus for medical purposes; distillation apparatus; desiccating apparatus; hydromassage bath apparatus; disinfectant apparatus; air deodorising apparatus; ionization apparatus for the treatment of air or water; coffee roasters; beverage cooling apparatus; apparatus for fertilizer irrigation; hand drying apparatus for washrooms; fruit roasters; water purifying apparatus and machines; refrigerating apparatus and machines; underfloor heating apparatus and installations; drying apparatus and installations; membrane apparatus for generating gas; freezers; heating and cooling apparatus for dispensing hot and cold beverages; drying apparatus; fermentation apparatus for industrial purposes; coolers for furnaces; expansion tanks for central heating installations; flushing tanks; refining towers for distillation; bidets; bioreactors for use in the treatment of wastewater; bioreactors for use in the treatment of waste; boilers, other than parts of machines; bath tubs; spa baths [vessels]; bath tubs for sitz baths; waffle irons, electric; fans [air-conditioning]; fans [parts of air-conditioning installations]; electric fans for personal use; roasting spits; refrigerating display cabinets [display cases]; heated display cabinets; dehumidifiers; water heaters; flushing apparatus; air reheaters; extractor hoods for kitchens; gas condensers, other than parts of machines; acetylene generators; fog machines; microbubble

generators for baths; hydrants; burners; acetylene burners; gas burners; burners for lamps; germicidal burners; incandescent burners; laboratory burners; oil burners; alcohol burners; hot water bottles; footwarmers, electric or non-electric; bedwarmers; usb-powered hand warmers; pocket warmers; warming pans; roasting apparatus; food dehydrators, electric; lampshade holders; stills; showers; refrigerating containers; gas lighters; friction lighters for igniting gas; chimney blowers; coils [parts of distilling, heating or cooling installations]; furnace ash boxes; evaporators; electric appliances for making yogurt; shower cubicles [enclosures (am.)]; turkish bath cabinets, portable; heating apparatus; cool boxes, electric; walk-in refrigerators; fireplaces, domestic; chimney flues; coffee capsules, empty, for electric coffee machines; structural framework for ovens; cooking pots, electric; air valves for steam heating installations; level controlling valves in tanks; thermostatic valves [parts of heating installations]; electrically heated carpets; light bulbs; light bulbs, electric; solar thermal collectors [heating]; distillation columns; fire bars; ventilation hoods; ventilation hoods for laboratories; lamp globes; air conditioning apparatus; air conditioners for vehicles; gas boilers; washing coppers; heating boilers; coffee machines, electric; coffee machines incorporating water purifiers; taps for pipes and pipelines; mixer taps for water pipes; electrically heated mugs; forges, portable; lava rocks for use in barbecue grills; couscous cookers, electric; electric lights for christmas trees; acetylene flares; safety lamps; gas lamps; curling lamps; nail lamps; curing lamps, not for medical purposes; germicidal lamps for purifying air; light bulbs for directional signals for vehicles; arc lamps; laboratory lamps; oil lamps; ultraviolet ray lamps, not for medical purposes; miners' lamps; electric lamps; chandeliers; barbecues; watering machines for agricultural purposes; ice-cream making machines; beer brewing machines, electric, for household purposes; soya milk making machines, electric; snow-making machines; pounded rice cake making machines, electric, for household purposes; membranes for reverse osmosis units; filters for water filtering apparatus; multicookers; footmuffs, electrically heated; heaters for baths; heaters for heating irons; immersion heaters; brackets for gas burners; anti-splash tap nozzles; heat pumps; filaments for electric lamps; magnesium filaments for lighting; heating filaments, electric; luminous house numbers; socks, electrically heated; heating apparatus for defrosting windows of vehicles; hot air bath fittings; bath fittings; loading apparatus for furnaces; kiln furniture [supports]; sauna bath installations; refrigerating appliances and installations; directional lights for bicycles; running lights for vehicles; electrically heated clothing; blankets, electric, not for medical purposes; fabric steamers; lamp reflectors; vehicle reflectors; hearths; lightsticks, battery-operated; electric cooktops; food steamers, electric; steam boilers, other than parts of machines;

pasteurisers; lamp casings; sockets for electric lights; coffee percolators, electric; stoves [heating apparatus]; bakers' ovens; hot air ovens; kitchen ranges [ovens]; microwave ovens [cooking apparatus]; microwave ovens for industrial purposes; incinerators; kilns; solar furnaces; dental ovens; ovens, other than for laboratory use; urinals being sanitary fixtures; feeding apparatus for heating boilers; heating plates; cookers; hot plates; wine cellars, electric; heaters, electric, for feeding bottles; aquarium heaters; usb-powered cup heaters; aquarium lights; heating cushions [pads], electric, not for medical purposes; clean chambers [sanitary installations]; electric vessels for making ices and ice cream; tortilla presses, electric; water intake apparatus; apparatus for dehydrating food waste; fumigation apparatus, not for medical purposes; gas scrubbing apparatus; oil-scrubbing apparatus; glue-heating appliances; forage drying apparatus; water filtering apparatus; air purifying apparatus and machines; ice machines and apparatus; cooling appliances and installations; cooking apparatus and installations; lighting apparatus and installations; sanitary apparatus and installations; cooking rings; lighting apparatus for vehicles; light-emitting diodes [led] lighting apparatus; heating apparatus for solid, liquid or gaseous fuels; heating apparatus, electric; hot air apparatus; steam facial apparatus [saunas]; safety accessories for water or gas apparatus and pipes; regulating and safety accessories for gas apparatus; regulating accessories for water or gas apparatus and pipes; regulating and safety accessories for water apparatus; regulating and safety accessories for gas pipes; roasting jacks; plate warmers; anti-glare devices for vehicles [lamp fittings]; rotisseries; radiator caps; searchlights; diving lights; light projectors; washers for water taps; heat guns; radiators [heating]; central heating radiators; radiators, electric; sinks; kitchen sinks incorporating integrated worktops; drip irrigation emitters [irrigation fittings]; light diffusers; atomic piles; heat regenerators; pressure water tanks; roasters; beverage urns, electric; lamps; ceiling lights; toilet seats; hydroponic growing systems; lighting installations for air vehicles; scrubbers [parts of gas installations]; tanning beds; lamp glasses; sterilizers; water sterilizers; air sterilisers; air driers; laundry dryers, electric; hair driers; malt roasters; tobacco roasters; tajines, electric; heat exchangers, other than parts of machines; thermo-pots, electric; standard lamps; toasters; discharge tubes, electric, for lighting; lamp chimneys; luminous tubes for lighting; water-pipes for sanitary installations; flues for heating boilers; boiler pipes [tubes] for heating installations; heat-stabilized polypropylene pipes for heating installations; water closets; toilets, portable; humidifiers; humidifiers for central heating radiators; membrane filtration units for water treatment apparatus; wash-hand bowls [parts of sanitary installations]; toilet bowls; water conduits installations; air conditioning installations; desalination plants; processing installations for fuel and nuclear modera-

ting material; watering installations, automatic; cooling installations for water; cooling installations for liquids; milk cooling installations; cooling installations for tobacco; water purification installations; purification installations for sewage; steam generating installations; water distribution installations; air filtering installations; swimming pool chlorinating apparatus; ventilation [air-conditioning] installations and apparatus; ventilation [air-conditioning] installations for vehicles; water softening apparatus and installations; cooling installations and machines; reverse osmosis units; heating installations; heaters for vehicles; hot water heating installations; polymerisation installations; water supply installations; flare stacks for use in oil refineries; ash conveyor installations, automatic; disinfectant apparatus for dispensing solutions into water-pipes for sanitary installations; deodorizing apparatus, not for personal use; whirlpool-jet apparatus; air cooling apparatus; sous-vide cookers, electric; aquarium filtration apparatus; cooking utensils, electric; flares; headlights for automobiles; vehicle headlights; filters for air conditioning; filters for drinking water; reverse osmosis membrane filters for water treatment; automobile lights; bicycle lights; cycle lights; lights for vehicles; pocket searchlights; head torches; lanterns for lighting; candle lanterns; street lamps; chinese lanterns; fountains; ornamental fountains; chocolate fountains, electric; air fryers; deep fryers, electric; shaped fittings for ovens; oven fittings made of fireclay; bread-making machines; refrigerators; refrigerators, cooling apparatus and freezers for medical storage purposes; chromatography apparatus for industrial purposes; kettles, electric.

12 – Motor buses; motor coaches; motor homes; driverless cars [autonomous cars]; motor racing cars; lorries; cars; hydrogen-fueled cars; robotic cars; sports cars; concrete mixing vehicles; refrigerated vehicles; caravans; shock absorbers for automobiles; suspension shock absorbers for vehicles; space vehicles; aircraft; aeronautical apparatus, machines and appliances; hot air balloons; ski carriers for cars; luggage carriers for vehicles; bumpers for automobiles; vehicle bumpers; tires for vehicle wheels; barges; brake shoes for vehicles; tailboard lifts [parts of land vehicles]; buffers for railway rolling stock; waggons; tilt trucks; railway carriages; sleeping cars; dining cars; refrigerated wagons [railroad vehicles]; transmission shafts for land vehicles; cycles; electric bicycles; valves for vehicle tires [tyres]; helicopters; helicams; automobile hoods; pushchair hoods; hoods for vehicles; oars; paddles for canoes; sculls; screws [propellers] for ships; surveillance towers specially adapted for vehicles; lug nuts for vehicle wheels; seaplanes; hydroplanes; flanges of railway wheel tires; trucks with a crane feature incorporated; horns for vehicles; treads for vehicles [roller belts]; doors for vehicles; motors for cycles; motorcycle engines; motors for land vehicles; jet engines for land vehicles; driving motors for land vehicles; screw-propellers; screw-propellers for boats;

airships; rims for vehicle wheels; brake discs for vehicles; telfer railways [cable cars]; self-balancing boards; dredgers [boats]; hand cars; military drones; civilian drones; delivery drones; camera drones; vehicle bonnet pins; adhesive rubber patches for repairing inner tubes; bicycle bells; rearview mirrors; port-holes; cars for cable transport installations; inner tubes for pneumatic tires [tyres]; inner tubes for bicycle tyres; canoes; hoods for vehicle engines; cranks for land vehicle components, other than for engines; boats; caissons [vehicles]; wheels for bicycles, cycles; vehicle wheels; mine cart wheels; casters for trolleys [vehicles] [carts (am.)]; brake pads for automobiles; diving bells; hub caps; pushchairs; pet strollers; side cars; prams; brake linings for vehicles; ships; baskets adapted for cycles; gear boxes for land vehicles; ships' hulls; fenders for ships; bands for wheel hubs; ejector seats for aircraft; wheelchairs; caps for vehicle fuel tanks; boat hooks; automobile bodies; tipping bodies for lorries [trucks]; bodies for vehicles; treads for re-reading tires [tyres]; locomotives; masts for boats; golf carts [vehicles]; sprinkling trucks; propulsion mechanisms for land vehicles; transmission mechanisms for land vehicles; self-balancing electric unicycles; mopeds; motor scooters; motorcycles; rubbish trucks; tyre mousse inserts; fitted footmuffs for prams; fitted footmuffs for pushchairs; freewheels for land vehicles; clutches for land vehicles; repair outfits for inner tubes; fitted dashboard covers for vehicles; bicycle pumps; upholstery for vehicles; rims for bicycle wheels; windows for vehicles; engine mounts for land vehicles; axles for vehicles; headlight wipers; parachutes; ferry boats; pedals for cycles; ashtrays for automobiles; gearing for land vehicles; carts; horse-drawn carriages; forklift trucks; straddle carriers; head-rests for vehicle seats; bicycle kickstands; motorcycle kickstands; vehicle running boards; cup holders for vehicles; air bags [safety devices for automobiles]; ski lifts; chairlifts; casings for pneumatic tyres; sleeping berths for vehicles; pontoons; torque converters for land vehicles; pneumatic or hydraulic linear actuators for land vehicles; cigar lighters for automobiles; non-skid devices for vehicle tires; anti-glare devices for vehicles; anti-theft devices for vehicles; sun-blinds adapted for automobiles; trailers for transporting bicycles; bicycle trailers; balance weights for vehicle wheels; shock absorbing springs for vehicles; pulks for transportation; cycle frames; motorcycle frames; spars for ships; reduction gears for land vehicles; safety belts for vehicle seats; security harness for vehicle seats; vehicle suspension springs; self-driving robots for delivery; rudders; cycle handle bars; motorcycle handlebars; vehicle joysticks; cranks for cycles; signal arms for vehicles; push scooters [vehicles]; aeroplanes; amphibious airplanes; sleighs [vehicles]; kick sledges; brake segments for vehicles; cycle saddles; luggage nets for vehicles; dress guards for bicycles; fitted pushchair mosquito nets; anti-theft alarms for vehicles; reversing alarms for vehicles; safety seats for chil-

dren, for vehicles; vehicle seats; bellows for articulated buses; hydraulic circuits for vehicles; water scooters [personal watercraft]; mobility scooters; self-balancing scooters; snowmobiles; rolling stock for railways; rolling stock for funicular railways; spokes for bicycle wheels; vehicle wheel spokes; spoilers for vehicles; ambulances; autonomous underwater vehicles for seabed inspections; amphibious vehicles; armoured vehicles; all-terrain vehicles; water vehicles; air vehicles; swamp-going vehicles; vehicles for locomotion by land, air, water or rail; snow-going vehicles; air cushion vehicles; remotely operated vehicles for underwater inspections; remote control vehicles, other than toys; electric vehicles; tricycles; carrier tricycles; inclined ways for boats; windscreens; windscreen wipers; hubs for bicycle wheels; vehicle wheel hubs; rescue boats; saddlebags adapted for bicycles; railway couplings; trailer hitches for vehicles; couplings for land vehicles; wheelbarrows; trolleys; handling carts; sack-barrows; shopping trolleys [carts (am.)]; fishing trolleys; hose carts; bogies for railway cars; ladle cars; tilting-carts; roll cage trolleys; cleaning trolleys; cycle brakes; brakes for vehicles; torsion bars for vehicles; tractors; tramcars; military vehicles for transport; aerial conveyors; trailers [vehicles]; funnels for ships; funnels for locomotives; turbines for land vehicles; oarlocks; disengaging gear for boats; cable transport apparatus and installations; spoke clips for wheels; tipping apparatus [parts of railway wagons]; steering gears for ships; cleats [nautical]; funiculars; vans [vehicles]; cycle chains; motorcycle chains; driving chains for land vehicles; anti-skid chains; transmission chains for land vehicles; undercarriages for vehicles; pushchair covers; spare tire covers; covers for vehicle steering wheels; saddle covers for bicycles; saddle covers for motorcycles; seat covers for vehicles; vehicle covers [shaped]; automobile chassis; vehicle chassis; connecting rods for land vehicles, other than parts of motors and engines; axle journals; gears for cycles; tubeless tires [tyres] for bicycles, cycles; tires for bicycles, cycles; automobile tires [tyres]; tyres for snow ploughs; tires, solid, for vehicle wheels; solid tyres for vehicle wheels.

35 – Arranging subscriptions to telecommunication services for others; import-export agencies; commercial information agency services; advertising agency services; cost price analysis; rental of cash registers; rental of office equipment in co-working facilities; rental of advertising space; business auditing; financial auditing; business intermediary services relating to the matching of potential private investors with entrepreneurs needing funding; employment agency services; computerized file management; accounting; invoicing; demonstration of goods; transcription; opinion polling; marketing studies; business investigations; business research; marketing research; personnel recruitment; business management and organization consultancy; business organization consultancy; business management consultancy; personnel manage-

ment consultancy; professional business consultancy; consultancy regarding advertising communication strategies; consultancy regarding public relations communication strategies; layout services for advertising purposes; marketing; marketing in the framework of software publishing; influencer marketing; targeted marketing; business management of performing artists; business management of sports people; writing of curriculum vitae for others; writing of publicity texts; scriptwriting for advertising purposes; news clipping services; updating and maintenance of information in registries; updating and maintenance of data in computer databases; updating of advertising material; word processing; online retail services for downloadable and pre-recorded music and movies; online retail services for downloadable ring tones; online retail services for downloadable digital music; organization of exhibitions for commercial or advertising purposes; arranging newspaper subscriptions for others; arranging subscriptions to electronic toll collection [etc] services for others; organization of fashion shows for promotional purposes; organization of trade fairs; shop window dressing; business appraisals; preparation of business profitability studies; payroll preparation; data search in computer files for others; sponsorship search; administrative assistance in responding to calls for tenders; business management assistance; commercial or industrial management assistance; commercial intermediation services; providing business information; providing business information via a website; providing commercial and business contact information; providing telephone directory information; providing commercial information and advice for consumers in the choice of products and services; provision of an online marketplace for buyers and sellers of goods and services; providing user reviews for commercial or advertising purposes; web indexing for commercial or advertising purposes; providing user rankings for commercial or advertising purposes; presentation of goods on communication media, for retail purposes; media relations services; auctioneering; conducting of commercial events; economic forecasting; sales promotion for others; promotion of goods and services through sponsorship of sports events; promotion of goods through influencers; production of teleshopping programmes; production of advertising films; office machines and equipment rental; rental of advertising time on communication media; publicity material rental; rental of billboards [advertising boards]; rental of vending machines; rental of sales stands; rental of photocopying machines; consumer profiling for commercial or marketing purposes; publication of publicity texts; radio advertising; development of advertising concepts; bill-posting; distribution of samples; dissemination of advertising matter; direct mail advertising; registration of written communications and data; publicity; online advertising on a computer network; advertising by mail order; television advertising; compilation of

statistics; compilation of information into computer databases; business inquiries; systemization of information into computer databases; administrative services for medical referrals; corporate communications services; negotiation of business contracts for others; negotiation and conclusion of commercial transactions for third parties; compiling indexes of information for commercial or advertising purposes; tax preparation; drawing up of statements of accounts; telemarketing services; psychological testing for the selection of personnel; interim business management; outsourced administrative management for companies; business management of hotels; business management for freelance service providers; business project management services for construction projects; commercial administration of the licensing of the goods and services of others; business management of reimbursement programmes for others; computerized management of medical records and files; administration of consumer loyalty programs; administration of frequent flyer programs; administrative processing of purchase orders; pay per click advertising; administrative services for the relocation of businesses; public relations; commercial lobbying services; competitive intelligence services; business consulting services for digital transformation; advisory services for business management; lead generation services; modelling for advertising or sales promotion; typing; online ordering services in the field of restaurant take-out and delivery; market intelligence services; appointment reminder services [office functions]; data processing services [office functions]; website traffic optimization; wholesale services for pharmaceutical, veterinary and sanitary preparations and medical supplies; appointment scheduling services [office functions]; tax filing services; search engine optimization for sales promotion; retail services for works of art provided by art galleries; retail services for pharmaceutical, veterinary and sanitary preparations and medical supplies; retail services relating to bakery products; gift registry services; price comparison services; business intermediary services relating to the matching of various professionals with clients; reception services for visitors [office functions]; advertising services to create brand identity for others; secretarial services; procurement services for others [purchasing goods and services for other businesses]; shorthand; outsourcing services [business assistance]; telephone answering for unavailable subscribers; telephone switchboard services; photocopying services; business efficiency expert services.

42 – Water analysis; computer system analysis; handwriting analysis [graphology]; chemical analysis; rental of data centre facilities; rental of meters for the recording of energy consumption; energy auditing; geological test drilling; recovery of computer data; quantum computing; business card design; graphic design of promotional materials; industrial design; graphic arts design; computer virus protection services; oil-fi-

eld surveys; geological surveys; geotechnical investigations; engineering; installation of computer software; weather forecasting; clinical trials; material testing; textile testing; bacteriological research; biological research; geological research; research in the field of environmental protection; cosmetic research; mechanical research; research in the field of welding; research in the field of building construction; research in the field of telecommunications technology; research in the field of artificial intelligence technology; research in the field of physics; chemical research; research and development of new products for others; medical research; scientific and technological research relating to patent mapping; scientific and technological research in the field of natural disasters; scientific research; analysis for oil-field exploitation; underwater exploration; research in the field of excavation; technological research; calibration [measuring]; web site design consultancy; computer security consultancy; information technology [it] consulting services; artificial intelligence consultancy; computer technology consultancy; consultancy in the design and development of computer hardware; architectural consultation; internet security consultancy; computer software consultancy; telecommunication network security consultancy; data security consultancy; technological consultancy; oil-well testing; quality control; vehicle roadworthiness testing; culturing of cells for scientific research purposes; cryptocurrency mining; land surveying; dress designing; updating of computer software; monitoring of computer systems to detect breakdowns; monitoring of computer systems for detecting unauthorized access or data breach; monitoring of computer systems by remote access; electronic monitoring of credit card activity to detect fraud via the internet; electronic monitoring of personally identifying information to detect identity theft via the internet; writing of computer code; software as a service [saas]; maintenance of computer software; authenticating works of art; design of show scenery; design of interior decor; quality evaluation of wool; digitization of documents [scanning]; conversion of data or documents from physical to electronic media; urban planning; platform as a service [paas]; providing virtual computer systems through cloud computing; providing online geographic maps, not downloadable; providing geographic information; providing information relating to computer technology and programming via a website; providing search engines for the internet; conversion of computer programs and data, other than physical conversion; conducting technical project studies; computer system design; golf course design; rental of web servers; computer rental; rental of computer software; design of prototypes; unlocking of mobile phones; geological prospecting; oil prospecting; hosting computer websites; development of video and computer games; development of computer platforms; construction drafting; computer software design; software development in the framework of

software publishing; cloud seeding; digital forensic investigations in the field of computer crimes; server hosting; user authentication services using blockchain technology; consultancy in the field of energy-saving; creating and maintaining web sites for others; computer graphic design for video projection mapping; design of computer-simulated models; design of costumes; computer programming; technical writing; copying of computer programs; architectural services; information technology services provided on an outsourcing basis; chemistry services; packaging design; off-site data backup; computer programming services for data processing; telecommunications technology consultancy; scientific laboratory services; user authentication services using single sign-on technology for online software applications; user authentication services using technology for e-commerce transactions; cartographic or thermographic measurement services by drone; logo design services; styling [industrial design]; cartography services; software engineering services for data processing; exploration services in the field of the oil, gas and mining industries.

(260) AM 2023 120270 A

(800) 1694213

(151) 2022 08 15

(891) 2022 08 15

(731) Aktsionernoe Obschestvo "Nizhegorodsky Khimiko-Farmatsevtichesky Zavod"
Salganskaya St., 7, RU-603950 Nizhny
Novgorod, Russian Federation

(540)

ЛАКТОДЕПАНТОЛ

(591) Black, white

(531) 28.05

(511)

3 – Abrasives; amber [perfume]; descaling preparations for household purposes; antistatic preparations for household purposes; aromatics [essential oils]; air fragrancing preparations; cake flavourings [essential oils]; flavourings for beverages [essential oils]; food flavourings [essential oils]; breath freshening sprays; canned pressurized air for cleaning and dusting purposes; balms, other than for medical purposes; basma [cosmetic dye]; lip glosses; nail glitter; polishing stones; abrasive paper; emery paper; polishing paper; petroleum jelly for cosmetic purposes; shoe polish; cobblers' wax; cotton wool impregnated with make-up removing preparations; cotton wool for cosmetic purposes; sachets for perfuming linen; drying agents for dishwashing machines; adhesives for cosmetic purposes; scented water; Javelle water; lavender water; mi-cellar water; toilet water; wax for parquet floors; floor wax; non-slipping wax for floors; depilatory wax; mo-stache wax; creams for leather; polish for furniture and flooring; shoemakers' wax; polishing wax; tailors' wax; massage gels, other than for medical purposes;

heliotropine; dental bleaching gels; geraniol; make-up; deodorants for pets; deodorants for human beings or for animals; depilatory preparations; air fragrance reed diffusers; scented wood; perfumes; non-slipping liquids for floors; windscreen cleaning liquids; greases for cosmetic purposes; volcanic ash for cleaning; perfumery; decorative transfers for cosmetic purposes; ionone [perfumery]; shaving stones [astringents]; smoothing stones; eyebrow pencils; cosmetic pencils; silicon carbide [abrasive]; carbides of metal [abrasives]; alum stones [astringents]; tripoli stone for polishing; adhesives for affixing false eyelashes; adhesives for affixing false hair; hair conditioners; quillaia bark for washing; corundum [abrasive]; beard dyes; colorants for toilet purposes; cosmetic dyes; body paint for cosmetic purposes; starch for laundry purposes; starch glaze for laundry purposes; shoe cream; polishing creams; cosmetic creams; skin whitening creams; polishing rouge; incense; hair spray; nail varnish; liquid latex body paint for cosmetic purposes; hair lotions; lotions for cosmetic purposes; after-shave lotions; beauty masks; oils for cleaning purposes; oils for perfumes and scents; oils for cosmetic purposes; oils for toilet purposes; essential oils; essential oils of cedarwood; essential oils of lemon; essential oils of citron; bergamot oil; gaultheria oil; jasmine oil; lavender oil; almond oil; rose oil; oil of turpentine for degreasing; whitening; cleaning chalk; almond milk for cosmetic purposes; cleansing milk for toilet purposes; musk [perfumery]; soap; deodorant soap; shaving soap; soap for brightening textile; cakes of toilet soap; antiperspirant soap; soap for foot perspiration; almond soap; mint for perfumery; cosmetic kits; emery; gel eye patches for cosmetic purposes; nail art stickers; false nails; eau de Cologne; extracts of flowers [perfumes]; joss sticks; pastes for razor strops; toothpaste; pumice stone; lipstick cases; hydrogen peroxide for cosmetic purposes; breath freshening strips; teeth whitening strips; sandcloth; glass cloth [abrasive cloth]; lipsticks; pomades for cosmetic purposes; breath freshening preparations for personal hygiene; shaving preparations; bath preparations, not for medical purposes; cosmetic preparations for baths; hair straightening preparations; hair waving preparations; laundry soaking preparations; grinding preparations; smoothing preparations [starching]; colour-removing preparations; leather bleaching preparations; polishing preparations; denture polishes; mouthwashes, not for medical purposes; cosmetic preparations for slimming purposes; laundry glaze; preparations to make the leaves of plants shiny; eye-washes, not for medical purposes; fabric softeners for laundry use; preparations for washing; dry-cleaning preparations; paint stripping preparations; lacquer-removing preparations; make-up removing preparations; floor wax removers [scouring preparations]; varnish-removing preparations; rust removing preparations; nail care preparations; cleaning preparations; preparations for cleaning dentures; wallpaper cleaning preparations; preparati-

ons for unblocking drain pipes; chemical cleaning preparations for household purposes; collagen preparations for cosmetic purposes; bleaching preparations [decolorants] for household purposes; laundry bleach; aloe vera preparations for cosmetic purposes; sunscreen preparations; colour-brightening chemicals for household purposes [laundry]; shining preparations [polish]; make-up powder; diamantine [abrasive]; stain removers; nail varnish removers; vaginal washes for personal sanitary or deodorant purposes; scouring solutions; false eyelashes; colour run prevention laundry sheets; tissues impregnated with cosmetic lotions; tissues impregnated with make-up removing preparations; antistatic dryer sheets; baby wipes impregnated with cleaning preparations; safrol; massage candles for cosmetic purposes; laundry blueing; turpentine for degreasing; potpourris [fragrances]; bleaching soda; washing soda, for cleaning; bath salts, not for medical purposes; bleaching salts; fumigation preparations [perfumes]; leather preservatives [polishes]; ammonia [volatile alkali] [detergent]; astringents for cosmetic purposes; eyebrow cosmetics; make-up preparations; sun-tanning preparations [cosmetics]; hair dyes; neutralizers for permanent waving; cosmetic preparations for eyelashes; cosmetic preparations for skin care; shoe wax; dentifrices; cosmetics; cosmetics for children; cosmetics for animals; mascara; detergents, other than for use in manufacturing operations and for medical purposes; cleansers for intimate personal hygiene purposes, non medicated; douching preparations for personal sanitary or deodorant purposes [toiletries]; degreasers, other than for use in manufacturing processes; bleaching preparations [decolorants] for cosmetic purposes; toiletry preparations; antiperspirants [toiletries]; phytocosmetic preparations; talcum powder, for toilet use; cotton swabs for cosmetic purposes; terpenes [essential oils]; emery cloth; cloths impregnated with a detergent for cleaning; henna [cosmetic dye]; shampoos; shampoos for animals [non-medicated grooming preparations]; shampoos for pets [non-medicated grooming preparations]; dry shampoos; sandpaper; soda lye; herbal extracts for cosmetic purposes; ethereal essences; badian essence; mint essence [essential oil].

5 – Pharmaceuticals, medical and veterinary preparations; sanitary preparations for medical purposes; dietetic food and substances adapted for medical or veterinary use, food for babies; dietary supplements for human beings and animals; plasters, materials for dressings; material for dental fillings and dental impressions; disinfectants; preparations for destroying noxious animals; fungicides, herbicides; acaricides; aconitine; alkaloids for medical purposes; alginates for pharmaceutical purposes; algicides; aldehydes for pharmaceutical purposes; dental amalgams of gold; dental amalgams; amino acids for veterinary purposes; amino acids for medical purposes; analgesics; anaesthetics; antibiotics; antiseptics; medicine cases, portable, filled; first-aid boxes, filled; aluminium ace-

tate for pharmaceutical purposes; acetates for pharmaceutical purposes; germicides; oxygen cylinders, filled, for medical purposes; balms for medical purposes; bandages for dressings; diagnostic biomarker reagents for medical purposes; biocides; bracelets impregnated with insect repellent; bromine for pharmaceutical purposes; paper for mustard plasters; fly catching paper; reagent paper for veterinary purposes; reagent paper for medical purposes; mothproofing paper; petroleum jelly for medical purposes; vaccines; oxygen baths; antiseptic cotton; aseptic cotton; absorbent cotton; wadding for medical purposes; cotton for medical purposes; dietetic substances adapted for medical use; radiological contrast substances for medical purposes; nutritive substances for microorganisms; radioactive substances for medical purposes; bismuth subnitrate for pharmaceutical purposes; melissa water for pharmaceutical purposes; seawater for medicinal bathing; mineral waters for medical purposes; thermal water; dietary fibre; moulding wax for dentists; gases for medical purposes; guaiacol for pharmaceutical purposes; massage gels for medical purposes; sexual stimulant gels; haematogen; haemoglobin; hydrastine; hydrastinine; glycerine for medical purposes; glycerophosphates; glucose for medical purposes; gentian for pharmaceutical purposes; hormones for medical purposes; mustard for pharmaceutical purposes; mustard plasters; mud for baths; medicinal mud; contraceptive sponges; gamboge for medical purposes; gurjun balsam for medical purposes; deodorizers for litter trays; air deodorizing preparations; deodorants, other than for human beings or for animals; deodorants for clothing and textiles; diastase for medical purposes; digitalin; vitamin supplement patches; mineral dietary supplements; dietary supplements; albumin dietary supplements; dietary supplements for animals; yeast dietary supplements; alginate dietary supplements; glucose dietary supplements; casein dietary supplements; lecithin dietary supplements; linseed oil dietary supplements; propolis dietary supplements; protein dietary supplements; protein supplements for animals; royal jelly dietary supplements; pollen dietary supplements; wheat germ dietary supplements; linseed dietary supplements; acai powder dietary supplements; dietary supplements with a cosmetic effect; enzyme dietary supplements; yeast for pharmaceutical purposes; gelatine for medical purposes; cod liver oil; isotopes for medical purposes; immunostimulants; insecticides; iodine for pharmaceutical purposes; iodides for pharmaceutical purposes; alkaline iodides for pharmaceutical purposes; iodoform; calomel [fungicide]; cream of tartar for pharmaceutical purposes; tartar for pharmaceutical purposes; camphor for medical purposes; capsules for medicines; cachets for pharmaceutical purposes; capsules made of dendrimer-based polymers, for pharmaceuticals; haemostatic pencils; wart pencils; caustic pencils; carbolineum [parasiticide]; caustics for pharmaceutical purposes; cachou for pharmaceutical purposes; quassia for medical purposes;

quebracho for medical purposes; oxygen for medical purposes; gallic acid for pharmaceutical purposes; acids for pharmaceutical purposes; adhesives for dentures; surgical glues; stem cells for veterinary purposes; stem cells for medical purposes; cocaine for medical purposes; collagen for medical purposes; collodion for pharmaceutical purposes; corn rings for the feet; cannabis for medical purposes; medicated sweets; angostura bark for medical purposes; barks for pharmaceutical purposes; cedar wood for use as an insect repellent; condurango bark for medical purposes; croton bark; mangrove bark for pharmaceutical purposes; myrobalan bark for pharmaceutical purposes; quinquina for medical purposes; medicated animal feed; medicinal roots; rhubarb roots for pharmaceutical purposes; lint for medical purposes; starch for dietetic or pharmaceutical purposes; creosote for pharmaceutical purposes; blood for medical purposes; biological tissue cultures for veterinary purposes; biological tissue cultures for medical purposes; cultures of microorganisms for medical or veterinary use; curare; dental lacquer; liquorice for pharmaceutical purposes; milk sugar for pharmaceutical purposes; adhesive plasters; medicines for alleviating constipation; adhesive tapes for medical purposes; lecithin for medical purposes; lotions for veterinary purposes; medicated hair lotions; lotions for pharmaceutical purposes; medicated after-shave lotions; personal sexual lubricants; lupulin for pharmaceutical purposes; magnesia for pharmaceutical purposes; liniments; ointments for pharmaceutical purposes; sunburn ointments; mercurial ointments; frostbite salve for pharmaceutical purposes; gauze for dressings; medicinal oils; mustard oil for medical purposes; camphor oil for medical purposes; castor oil for medical purposes; oil of turpentine for pharmaceutical purposes; dill oil for medical purposes; dental mastics; dental abrasives; dressings, medical; surgical dressings; drugs for medical purposes; medicines for veterinary purposes; serotherapeutic medicines; medicines for human purposes; medicines for dental purposes; menthol; medicinal drinks; moleskin for medical purposes; almond milk for pharmaceutical purposes; powdered milk for babies; royal jelly for pharmaceutical purposes; milk ferments for pharmaceutical purposes; Irish moss for medical purposes; flour for pharmaceutical purposes; linseed meal for pharmaceutical purposes; fish meal for pharmaceutical purposes; fly glue; antibacterial soap; disinfectant soap; medicated soap; freeze-dried meat adapted for medical purposes; mint for pharmaceutical purposes; dietetic beverages adapted for medical purposes; malted milk beverages for medical purposes; injectable dermal fillers; bone void fillers comprised of living tissues; narcotics; medicinal infusions; tincture of iodine; eucalyptol for pharmaceutical purposes; tinctures for medical purposes; opium; opodeldoc; decoctions for pharmaceutical purposes; antiparasitic collars for animals; cotton swabs for medical purposes; cotton wool swabs for medical purposes;

stick liquorice for pharmaceutical purposes; sulfur sticks [disinfectants]; pastilles for pharmaceutical purposes; medicated toothpaste; pectin for pharmaceutical purposes; pepsins for pharmaceutical purposes; peptones for pharmaceutical purposes; hydrogen peroxide for medical purposes; pesticides; leeches for medical purposes; blood plasma; nicotine patches for use as aids to stop smoking; eyepatches for medical purposes; poultices; compresses; scapulars for surgical purposes; babies' diapers; diapers for pets; swim diapers, reusable, for babies; swim diapers, disposable, for babies; diapers for incontinence; diaper changing mats, disposable, for babies; bunion pads; breast-nursing pads; pomades for medical purposes; powder of cantharides; pyrethrum powder; anti-uric preparations; bacterial preparations for medical and veterinary use; bacteriological preparations for medical and veterinary use; balsamic preparations for medical purposes; albuminous preparations for medical purposes; biological preparations for veterinary purposes; biological preparations for medical purposes; bismuth preparations for pharmaceutical purposes; vitamin preparations; diagnostic preparations for veterinary purposes; diagnostic preparations for medical purposes; douching preparations for medical purposes; bath preparations for medical purposes; therapeutic preparations for the bath; haemorrhoid preparations; preparations for callouses; lice treatment preparations [pediculicides]; acne treatment preparations; preparations to facilitate teething; preparations for the treatment of burns; fumigation preparations for medical purposes; opotherapy preparations; air purifying preparations; bronchodilating preparations; preparations for reducing sexual activity; sterilizing preparations; soil-sterilizing preparations; corn remedies; pharmaceutical preparations for treating dandruff; vermin destroying preparations; herbicides; preparations for destroying dry rot fungus; larvae exterminating preparations; fly destroying preparations; preparations for destroying mice; slug exterminating preparations; pharmaceutical preparations for skin care; contact lens cleaning preparations; preparations of microorganisms for medical or veterinary use; lime-based pharmaceutical preparations; styptic preparations; medicated eye-washes; medicinal hair growth preparations; nutraceutical preparations for therapeutic or medical purposes; opiates; anticryptogamic preparations; aloe vera preparations for pharmaceutical purposes; preparations of trace elements for human and animal use; sulfonamides [medicines]; pharmaceutical preparations; pharmaceutical preparations for treating sunburn; enzyme preparations for veterinary purposes; enzyme preparations for medical purposes; phytotherapy preparations for medical purposes; chemico-pharmaceutical preparations; chemical preparations for veterinary purposes; chemical preparations for the diagnosis of pregnancy; chemical preparations for medical purposes; chemical preparations for treating diseases affecting cereal plants; chemical preparations for treating wheat

blight; chemical preparations for treating diseases affecting vine plants; chemical preparations for treating mildew; chemical preparations for treating phylloxera; chemical preparations for pharmaceutical purposes; chilblain preparations; mothproofing preparations; collyrium; lead water; chemical conductors for electrocardiograph electrodes; albuminous foodstuffs for medical purposes; dietetic foods adapted for medical purposes; by-products of the processing of cereals for dietetic or medical purposes; homogenized food adapted for medical purposes; freeze-dried food adapted for medical purposes; pharmaceuticals; sanitary towels; panty liners [sanitary]; propolis for pharmaceutical purposes; pearl powder for medical purposes; radium for medical purposes; hydrated chloral for pharmaceutical purposes; solvents for removing adhesive plasters; vaginal washes for medical purposes; solutions for contact lenses; chemical reagents for medical or veterinary purposes; gum for medical purposes; rubber for dental purposes; chewing gum for medical purposes; nicotine gum for use as an aid to stop smoking; insect repellents; insect repellent incense; repellents for dogs; tissues impregnated with pharmaceutical lotions; sarsaparilla for medical purposes; sugar for medical purposes; crystallized rock sugar for medical purposes; asthmatic tea; fumigating sticks; massage candles for therapeutic purposes; linseed for pharmaceutical purposes; tobacco-free cigarettes for medical purposes; siccatives [drying agents] for medical purposes; syrups for pharmaceutical purposes; turpentine for pharmaceutical purposes; milking grease; greases for veterinary purposes; greases for medical purposes; lacteal flour for babies; infant formula; soporifics; bicarbonate of soda for pharmaceutical purposes; bath salts for medical purposes; salts for mineral water baths; salts for medical purposes; potassium salts for medical purposes; sodium salts for medical purposes; smelling salts; mineral water salts; malt for pharmaceutical purposes; semen for artificial insemination; alcohol for pharmaceutical purposes; medicinal alcohol; alloys of precious metals for dental purposes; ergot for pharmaceutical purposes; cooling sprays for medical purposes; antibacterial handwashes; adjuvants for medical purposes; astringents for medical purposes; vermifuges; disinfectants for hygiene purposes; disinfectants for chemical toilets; appetite suppressants for medical purposes; medical preparations for slimming purposes; parasiticides; mouthwashes for medical purposes; medicated dentifrices; febrifuges; depuratives; animal washes [insecticides]; detergents for medical purposes; cattle washes [insecticides]; dog washes [insecticides]; insecticidal veterinary washes; vesicants; purgatives; remedies for perspiration; remedies for foot perspiration; chemical contraceptives; antiparasitic preparations; sedatives; laxatives; tonics [medicines]; medicated toiletry preparations; digestives for pharmaceutical purposes; nervines; bouillons for bacteriological cultures; steroids; headache relief sticks; strychnine; suppositories; serums;

tanning pills; appetite suppressant pills; slimming pills; jujube, medicated; antioxidant pills; sanitary tampons; vulnery sponges; thymol for pharmaceutical purposes; smoking herbs for medical purposes; medicinal herbs; transplants [living tissues]; surgical implants comprised of living tissues; pants, absorbent, for incontinence; sanitary panties; babies' diaper-pants; charcoal for pharmaceutical purposes; fennel for medical purposes; porcelain for dental prostheses; phenol for pharmaceutical purposes; enzymes for veterinary purposes; enzymes for medical purposes; ferments for pharmaceutical purposes; formic aldehyde for pharmaceutical purposes; phosphates for pharmaceutical purposes; quinine for medical purposes; chinoline for medical purposes; diabetic bread adapted for medical use; chloroform; flowers of sulfur for pharmaceutical purposes; cement for animal hooves; bone cement for surgical and orthopaedic purposes; dental cements; medicinal tea; herbal teas for medicinal purposes; insecticidal animal shampoos; medicated shampoos; medicated shampoos for pets; pediculicidal shampoos; medicated dry shampoos; pre-filled syringes for medical purposes; eucalyptus for pharmaceutical purposes; herbal extracts for medical purposes; plant extracts for pharmaceutical purposes; tobacco extracts [insecticides]; extracts of hops for pharmaceutical purposes; elixirs [pharmaceutical preparations]; ethers for pharmaceutical purposes; esters for pharmaceutical purposes; cellulose esters for pharmaceutical purposes; cellulose ethers for pharmaceutical purposes; rat poison; poisons; bacterial poisons; jalap; angioprotectors; antiplatelet agents; anticoagulants; anti-inflammatory preparations; antithrombotic agents; decongestants; pharmaceutical preparations for the treatment of nervous system diseases; pharmaceutical preparations for the treatment of articular-ligamentous disorders; pharmaceutical preparations for the treatment of musculoskeletal disorders; pharmaceutical preparations for the treatment of diseases; pharmaceutical preparations for treating injuries; pharmaceuticals for the treatment of thrombophlebitis; anti-itch pharmaceutical preparations; venotonic pharmaceuticals; pharmaceutical preparations for the treatment of venous system diseases; pharmaceutical preparations for the treatment of lymphatic system diseases; pharmaceutical preparations for the treatment of rheumatic lesion; pharmaceutical preparations for the treatment and prevention of vaginal infections; pharmaceutical preparations for the normalization of the vaginal microflora; preparations for normalization of vaginal pH; pharmaceutical preparations for treatment of bacterial infections; pharmaceutical preparations for stimulation of regeneration of mucous membranes.

(260) AM 2023 120271 A
 (800) 1694217
 (151) 2022 06 16
 (891) 2022 06 16
 (731) Azalai Services LLC, Société À Responsabilité Limitée
 25 Greystone Manor, LEWES DE 19958,
 County Sussex, USA

(540)



(591) Brown color variants on a white background
 (531) 02.09.01; 26.13.25; 27.05.01; 27.05.10;
 29.01.07

(511)

43 – Services for providing food and beverages; temporary accommodation; bar services; catering services; hotel services; temporary accommodation reservation.

(260) AM 2023 120272 A
 (800) 1694224
 (151) 2022 10 04
 (891) 2022 10 04
 (731) Apple Inc.
 One Apple Park Way, Cupertino CA 95014,
 USA

(540)

STAGE MANAGER

(591) Black, white
 (511)
 9 – Downloadable computer software for use in accessing, browsing, organizing, arranging, managing, prioritizing, and viewing multiple computer applications.

(260) AM 2023 120276 A
 (800) 1694343
 (151) 2022 10 04
 (891) 2022 10 04
 (731) Hanseatic Tea Export GmbH
 Konsul-Smidt-Strasse 8J, 28217 Bremen,
 Germany

(540)

Germanika

(591) Black, white
 (511)
 32 – Beer; non-alcoholic beverages; mineral and aerated waters; fruit beverages and fruit juices; syrups and

other non-alcoholic preparations for making beverages; aperitifs, non-alcoholic; barley wine [beer]; lithia water; seltzer water; soda water; waters [beverages]; table waters; kvass [non-alcoholic beverage]; cocktails, non-alcoholic; beer-based cocktails; lemonades; isotonic beverages; non-alcoholic honey-based beverages; rice-based beverages, other than milk substitutes; soya-based beverages, other than milk substitutes; aloe vera drinks, non-alcoholic; whey beverages; protein-enriched sports beverages; soft drinks; non-alcoholic beverages flavoured with coffee; non-alcoholic beverages flavoured with tea; non-alcoholic fruit juice beverages; energy drinks; fruit nectars, non-alcoholic; orgeat; de-alcoholized beer; ginger beer; malt beer; powders for effervescing beverages; sarsaparilla [non-alcoholic beverage]; syrups for lemonade; syrups for beverages; smoothies; tomato juice [beverage]; cider, non-alcoholic; vegetable juices [beverages]; preparations for making non-alcoholic beverages; preparations for making carbonated water; must; grape must, unfermented; beer wort; malt wort; pastilles for effervescing beverages; sherbets [drinks]; non-alcoholic fruit extracts; extracts of hops for making beer; non-alcoholic essences for making beverages.

(260) AM 2023 120282 A

(800) 1694534

(151) 2022 07 27

(891) 2022 07 27

(731) GR. Sarantis Anonymi Viomichaniki & Emporiki Etairia Kallyntikon Endymaton Oikiakon & Pharmakeftikon Eidon 26, Amarousiou-Xalandriou, GR-151 25 Amarousio, Greece

(540)



(591) Green

(531) 05.03.13; 05.03.14; 25.03.01; 25.03.11; 27.05.03; 27.05.24; 29.01.12

(511)

3 – Pre-moistened towelettes impregnated with dishwashing detergent; cleaning preparations impregnated into pads; impregnated paper tissues for cleaning dishware; dishwashing detergents; commercial laundry detergents; laundry detergents for household cleaning use; laundry blueing; detergent soap; household detergents; cleaning and fragrancing preparations; window cleaners in spray form; spray cleaners for household use; toilet cleaners; cloths impregnated with a detergent for cleaning; paper hand towels impregnated with cleaning agents; pre-moistened towelettes impregnated with cleaning agents.

6 – Aluminium foil.

8 – Disposable tableware [cutlery] made of plastics.

16 – Food wrapping plastic film; food wrapping plastic film for household use; plastic film roll stock for packaging food; parchment paper; plastic food storage bags for household use; bags of plastics for lining refuse bins; garbage bags of plastics [for household use]; plastic bags for household use; plastic sandwich bags; plastic oven cooking bags; bags for microwave cooking; garbage bags of paper or of plastics; rubbish bags; ice cube bags; sandwich bags; sandwich bags [paper]; paper lunch bags.

17 – Recycled plastics; recycled compound plastics.

21 – Aluminium bakeware; aluminium cookware; aluminium moulds [kitchen utensils]; disposable aluminium foil containers for household purposes; baking trays made of aluminium; glasses [receptacles]; paper cups; eyeglass cleaning cloths; tumblers; cooking pots; fireproof dishes; cooking pot sets; earthenware; bakeware; tableware, other than knives, forks and spoons; tableware, cookware and containers; cooking pots for use in microwave ovens; cookware, except forks, knives and spoons; household or kitchen utensils; kitchen utensils of silicon; utensils for household purposes; pie servers; cake servers; baking dishes; mopping brushes; kitchen sponges; scouring sponges; scouring pads; mop pails; mop heads; swivel mops; pads of metal for cleaning; mop wringer buckets; steel wool for cleaning; steelwool; abrasive pads; household scouring pads; abrasive sponges for kitchen [cleaning] use; gloves for household purposes; dusting gloves; household gloves for cleaning purposes; rubber gloves for household use; sponges; sponges for household purposes; cloths for cleaning; microfiber cloths for cleaning; lintless cleaning cloths; floor cloths; dishes; biodegradable plates; biodegradable paper pulp-based plates; disposable table plates; insulated lids for plates and dishes; dishes for microwave ovens; paper plates; serving platters; table plates; plastic plates; straws for drinking.

24 – Disposable cloths; textile tissues.

(260) AM 2023 120284 A

(800) 1694570

(151) 2022 09 07

(891) 2022 09 07

(731) VP Holdings

Visbijas prospekts 7, LV-1014 Rīga, Latvia

(540)

VPLAB ULTRAMEN'S

(591) Black, white

(531) 27.05.01

(511)

5 – Dietetic substances adapted for medical use; mineral waters for medical purposes; vitamin supplement

patches; dietary supplements; mineral dietary supplements; albumin dietary supplements; dietary supplements consisting of vitamins; yeast dietary supplements; alginate dietary supplements; glucose dietary supplements; casein dietary supplements; lecithin dietary supplements; linseed oil dietary supplements; propolis dietary supplements; protein dietary supplements; royal jelly dietary supplements; pollen dietary supplements; wheat germ dietary supplements; linseed dietary supplements; acai powder dietetic supplements; enzyme dietary supplements; yeast for pharmaceutical purposes; starch for dietetic or pharmaceutical purposes; milk sugar for pharmaceutical purposes; almond milk for pharmaceutical purposes; powdered milk for babies; royal jelly for pharmaceutical purposes; milk ferments for pharmaceutical purposes; flour for pharmaceutical purposes; linseed meal for pharmaceutical purposes; fish meal for pharmaceutical purposes; freeze-dried meat adapted for medical purposes; dietetic beverages adapted for medical purposes; malted milk beverages for medical purposes; food for babies; albuminous foodstuffs for medical purposes; dietetic foods adapted for medical purposes; by-products of the processing of cereals for dietetic or medical purposes; homogenized food adapted for medical purposes; freeze-dried food adapted for medical purposes; lacteal flour for babies; infant formula; malt for pharmaceutical purposes.

(260) AM 2023 120301 A
 (800) 1695150
 (151) 2022 08 28
 (891) 2022 08 28
 (731) Zim Integrated Shipping Services Ltd.
 9 Sakharov Andrei St., Haifa, Israel
 (540)



(591) Blue
 (531) 01.01.01; 01.01.05; 01.01.10; 27.05.17;
 27.05.23; 29.01.04

(511)
 12 – Vehicles for travelling and transport on water; vessels; ships; apparatus for locomotion and transport on water; land vehicles; apparatus for locomotion and transport on land; transport containers for use in vehicles.

35 – Business management of freight and freight transport logistics; business management services in the field of freight and freight transport relating to shipment processing, preparing freight and freight transport documents and invoices, preparing shipping do-

cuments and invoices, tracking and tracing documents, packages and freight over computer networks, intranets, and the internet for business purposes; business administration services relating to electronic tracking and tracing of freight information for others; administrative processing of purchase orders; administrative services relating to customs clearance; regulatory submission management, namely, business administration assistance for others in preparing and filing documents related to customs and to cross-border transportation of freight, with governmental and regulatory bodies.

39 – Transport, packaging, and storage of freight by land, sea and air; arranging transportation by land, sea and air; freight forwarding services by land, air and sea; freight transportation and freight transportation logistics services; consultation in the field of sea land and air freight transportation; freight loading and unloading services; freight ship transport; freight train transport; freight loading services; air freight shipping services; warehousing and distribution services, namely, storage, distribution, pick-up, delivery and packing for shipment of documents, packages, goods, raw materials, and other freight for others; supply chain logistics and reverse logistics, namely, storage, transportation and delivery of documents, packages, goods, raw materials, and other freight for others by air, rail, ship or truck; stevedoring; freight brokerage; rental and leasing of containers; arranging for pickup, delivery, storage and transportation of documents, packages, freight and parcels via ground and air carriers.

(260) AM 2023 120302 A
 (800) 1695151
 (151) 2022 08 28
 (891) 2022 08 28
 (731) Zim Integrated Shipping Services Ltd.
 9 Sakharov Andrei St., Haifa, Israel
 (540)



(591) Black, white
 (531) 01.01.01; 01.01.05; 01.01.10; 27.05.17;
 27.05.23; 27.05.24

(511)
 12 – Vehicles for travelling and transport on water; vessels; ships; apparatus for locomotion and transport on water; land vehicles; apparatus for locomotion and transport on land; transport containers for use in vehicles.

35 – Business management of freight and freight transport logistics; business management services in the field of freight and freight transport relating to shipment processing, preparing freight and freight transport documents and invoices, preparing shipping documents and invoices, tracking and tracing documents, packages and freight over computer networks, intranets, and the internet for business purposes; business administration services relating to electronic tracking and tracing of freight information for others; administrative processing of purchase orders; administrative services relating to customs clearance; regulatory submission management, namely, business administration assistance for others in preparing and filing documents related to customs and to cross-border transportation of freight, with governmental and regulatory bodies.

39 – Transport, packaging, and storage of freight by land, sea and air; arranging transportation by land, sea and air; freight forwarding services by land, air and sea; freight transportation and freight transportation logistics services; consultation in the field of sea land and air freight transportation; freight loading and unloading services; freight ship transport; freight train transport; freight loading services; air freight shipping services; warehousing and distribution services, namely, storage, distribution, pick-up, delivery and packing for shipment of documents, packages, goods, raw materials, and other freight for others; supply chain logistics and reverse logistics, namely, storage, transportation and delivery of documents, packages, goods, raw materials, and other freight for others by air, rail, ship or truck; stevedoring; freight brokerage; rental and leasing of containers; arranging for pickup, delivery, storage and transportation of documents, packages, freight and parcels via ground and air carriers.

(260) AM 2023 120303 A
 (800) 1695152
 (151) 2022 08 28
 (891) 2022 08 28
 (731) Zim Integrated Shipping Services Ltd.
 9 Sakharov Andrei St., Haifa, Israel
 (540)

ZIM

(591) Black, white
 (511)
 12 – Vehicles for travelling and transport on water; vessels; ships; apparatus for locomotion and transport on water; land vehicles; apparatus for locomotion and transport on land; transport containers for use in vehicles.
 35 – Business management of freight and freight transport logistics; business management services in the field of freight and freight transport relating to shipment processing, preparing freight and freight transport documents and invoices, preparing shipping do-

cuments and invoices, tracking and tracing documents, packages and freight over computer networks, intranets, and the internet for business purposes; business administration services relating to electronic tracking and tracing of freight information for others; administrative processing of purchase orders; administrative services relating to customs clearance; regulatory submission management, namely, business administration assistance for others in preparing and filing documents related to customs and to cross-border transportation of freight, with governmental and regulatory bodies.

39 – Transport, packaging, and storage of freight by land, sea and air; arranging transportation by land, sea and air; freight forwarding services by land, air and sea; freight transportation and freight transportation logistics services; consultation in the field of sea land and air freight transportation; freight loading and unloading services; freight ship transport; freight train transport; freight loading services; air freight shipping services; warehousing and distribution services, namely, storage, distribution, pick-up, delivery and packing for shipment of documents, packages, goods, raw materials, and other freight for others; supply chain logistics and reverse logistics, namely, storage, transportation and delivery of documents, packages, goods, raw materials, and other freight for others by air, rail, ship or truck; stevedoring; freight brokerage; rental and leasing of containers; arranging for pickup, delivery, storage and transportation of documents, packages, freight and parcels via ground and air carriers.

(260) AM 2023 120305 A
 (800) 1695174
 (151) 2022 07 04
 (891) 2022 07 04
 (731) Onlife Inc.
 8 The Green, Suite #11883, Dover DE 19901,
 USA
 (540)



(591) Black, white
 (531) 26.03.01; 26.03.07; 26.03.24; 26.11.09
 (511)
 9 – Downloadable computer programs for video and computer games; computer game software downloadable from a global computer network; downloadable augmented reality software for playing computer games; downloadable computer game software via a global computer network and wireless devices; downloadable interactive multimedia computer game programs; downloadable computer game for use on mobile and cellular phones; downloadable interactive ga-

me programs; downloadable interactive game software; downloadable interactive multimedia computer game programs; downloadable virtual reality game software; downloadable augmented reality software for use in mobile devices for integrating electronic data with real world environments for the purpose of finding, locating and interacting with users; downloadable augmented reality software for use in mobile devices for integrating electronic data with real world environments for the purpose of posting reviews and recommendations on products and services of others; downloadable computer application software for mobile phones, namely, software for purchasing and buying goods with virtual currency; downloadable augmented reality software for creating, developing, storing, managing, manipulating, processing, transforming, deploying, distributing, displaying, sharing and transmitting augmented reality (AR) content and virtual reality (VR) content.

35 – Promoting the goods and services of others through user reviews and recommendations on the products and services of others, via an interactive website and mobile application; promoting the goods and services of others by providing a website featuring coupons, rebates, price-comparison information, product reviews, links to the retail websites of others, and discount information; promoting the sale of goods and services of others by means of contests and incentive award programs; promoting the goods and services of others; data processing services; market research services; analyzing and compiling business data for market research purposes; advertising, marketing and promotion services.

36 – Cryptocurrency services, namely, providing a digital currency or digital token for use by members of an on-line community via a global computer network.

41 – Providing on-line computer games; entertainment services, namely, providing on-line computer games; virtual reality game services provided on-line from a computer network; providing online computer games in the field of finding, locating and interacting with users and places; virtual reality game services provided on-line from a computer network.

42 – Design and development of computer game software; computer software development; computer programming of computer games; providing non-downloadable software for finding, locating and interacting with other users and places via a website; electronic data storage; computer programming services for creating, developing and designing augmented reality (AR) applications and virtual reality (VR) applications; providing temporary use of a non-downloadable web application for creating, developing, storing, managing, manipulating, processing, transforming, deploying, distributing, displaying, sharing and transmitting augmented reality (AR) content and virtual reality (VR) content; providing temporary use of a non-downloadable web application for creating, developing, storing, managing, manipulating, processing, transforming, deploying, distributing, displaying, sharing and interacting with other users and places.

lity (VR) content; providing temporary use of a non-downloadable web application for creating, developing and designing augmented reality (AR) and virtual reality (VR) applications; providing temporary use of on-line non-downloadable software and applications for enabling augmented reality (AR) applications and virtual reality (VR) applications to access backend services; digital asset management, namely, providing use of on-line non-downloadable computer software for performing digital asset management; providing temporary use of on-line non-downloadable software and applications for finding, locating and interacting with other users and places.

45 – Online social networking services.

(260) AM 2023 120306 A
 (800) 1695185
 (151) 2022 09 07
 (891) 2022 09 07
 (731) VP Holdings

Visbijas prospekts 7, LV-1014 Rīga, Latvia
 (540)



(591) Black, white
 (531) 27.05.01
 (511)

5 – Dietetic substances adapted for medical use; mineral waters for medical purposes; vitamin supplement patches; dietary supplements; mineral dietary supplements; albumin dietary supplements; dietary supplements consisting of vitamins; yeast dietary supplements; alginate dietary supplements; glucose dietary supplements; casein dietary supplements; lecithin dietary supplements; linseed oil dietary supplements; propolis dietary supplements; protein dietary supplements; royal jelly dietary supplements; pollen dietary supplements; wheat germ dietary supplements; linseed dietary supplements; acai powder dietetic supplements; enzyme dietary supplements; yeast for pharmaceutical purposes; starch for dietetic or pharmaceutical purposes; milk sugar for pharmaceutical purposes; almond milk for pharmaceutical purposes; powdered milk for babies; royal jelly for pharmaceutical purposes; milk ferments for pharmaceutical purposes; flour for pharmaceutical purposes; linseed meal for pharmaceutical purposes; fish meal for pharmaceutical purposes; freeze-dried meat adapted for medical purposes; dietetic beverages adapted for medical purposes; malted milk beverages for medical purposes; food for babies; albuminous foodstuffs for medical purposes; dietetic foods adapted for medical purposes; by-products of the processing of cereals for dietetic or medical purposes; homogenized food adapted for medical purposes; freeze-dried food adapted for medical purposes; lacteal flour for babies; infant formula; malt for pharmaceutical purposes.

30 – Flavourings, other than essential oils, for cakes; flavourings, other than essential oils, for beverages; food flavourings, other than essential oils; cereal bars; high-protein cereal bars; cereal bars enriched with vitamins and minerals, other than for medical or veterinary purposes; bulgur; edible paper; waffles; vermicelli; natural sweeteners; seawater for cooking; seaweed [condiment]; malt biscuits; glucose for culinary purposes; croutons; buckwheat, processed; gluten additives for culinary purposes; yeast; thickening agents for cooking foodstuffs; leaven; rice-based snack food; cereal-based snack food; coffee substitutes; vegetal preparations for use as coffee substitutes; zephyr being confectionery; fruit jellies [confectionery]; pastries; peanut confectionery; almond confectionery; pasta; frozen yogurt [confectionery ices]; cocoa; caramels [sweets]; quinoa, processed; gluten prepared as food-stuff; sweets; liquorice [confectionery]; peppermint sweets; dulce de leche; coffee; starch for food; crackers; custard; hominy grits; semolina; oatmeal; crushed barley; groats for human food; corn, milled; corn, roasted; couscous; noodles; lollipops [confectionery]; macaroni; maltose; marzipan; honey; royal jelly; ice cream; bean meal; buckwheat flour; tapioca flour; potato flour; corn flour; nut flours; flour; wheat flour; soya flour; barley meal; confectionery in the form of mousses; chocolate mousses; muesli; cocoa beverages with milk; coffee beverages with milk; coffee-based beverages; cocoa-based beverages; chamomile-based beverages; tea-based beverages; chocolate beverages with milk; chocolate-based beverages; infusions, not medicinal; crushed oats; husked oats; chocolate-coated nuts; stick liquorice [confectionery]; soya bean paste; pastila [confectionery]; lozenges [confectionery]; biscuits; popcorn; powders for making cereal-based beverages enriched with vitamins, minerals, protein; powders for making coffee-based beverages enriched with vitamins, minerals, protein; powders for making chocolate-based beverages enriched with vitamins, minerals, protein; powders for making ice cream; powders for making beverages with milk enriched with vitamins, minerals, protein; baking powder; aromatic preparations for food; condiments; cereal preparations; oat-based food; propolis; spices; rice pudding; puddings; cake powder; fruit coulis [sauces]; chewing gum; rice; instant rice; wheat germ for human consumption; sugar; palm sugar; sesame seeds [seasonings]; processed seeds for use as a seasoning; agave syrup [natural sweetener]; candy bars; cooking salt; sorbets [ices]; sauces [condiments]; spaghetti; chocolate-based spreads; chocolate spreads containing nuts; rusks; tarts; dough; almond paste; bread; chips [cereal products]; corn flakes; oat flakes; flowers or leaves for use as tea substitutes; chicory [coffee substitute]; tea; iced tea; chocolate; essences for food-stuffs, except etheric essences and essential oils; husked barley.

32 – Lithia water; seltzer water; soda water; waters [beverages]; carbonated water; mineral water [bevera-

ges]; table waters; cocktails, non-alcoholic; lemonades; non-alcoholic beverages; isotonic beverages; non-alcoholic honey-based beverages; rice-based beverages, other than milk substitutes; soya-based beverages, other than milk substitutes; aloe vera drinks, non-alcoholic; whey beverages; sports beverages enriched with vitamins and minerals; protein-enriched sports beverages; soft drinks; non-alcoholic beverages flavoured with coffee; non-alcoholic beverages flavoured with tea; non-alcoholic fruit juice beverages; energy drinks; fruit nectars, non-alcoholic; powders for effervescing beverages; syrups for lemonade; syrups for beverages; smoothies; vegetable juices [beverages]; fruit juices; preparations for making beverages; pastilles for effervescing beverages; sherbets [beverages]; non-alcoholic fruit extracts; non-alcoholic essences for making beverages.

(260) AM 2023 120307 A
 (800) 1695196
 (151) 2022 10 05
 (891) 2022 10 05
 (731) Wolt Enterprises Oy
 Arkadiankatu 6, FI-00100 Helsinki, Finland
 (540)

WOLT

(591) Black, white
 (511)
 9 – Sunglasses; computer peripheral devices; mouse pads; chargers; power banks; loudspeakers; headphones; sleeves for laptops; cell phone covers; decorative magnets; mobile phone holders; helmets for bicycles; helmets for motorcyclists.

16 – Planners [printed matter]; albums; photographic albums; albums for stickers; almanacs; bookmarkers; comic books; covers [stationery]; drawing materials; composition books; drawing pens; drawing rulers; drawing sets; folders [stationery]; paper folders; money holders; bond paper; writing tablets; envelopes [stationery]; writing stationery; loose-leaf binders; data books; address books; trading cards; posters; postcards; printed calendars; occasion cards; colouring books; stickers [stationery]; pens; pencils; rubber erasers; pencil boxes; pencil sets; pencil sharpeners; pencil holders; school supplies [stationery]; table napkins of paper; table linen of paper; tablecloths of paper; writing sets; writing materials.

18 – Trunks and suitcases; umbrellas and parasols; rucksacks; school bags; weekend bags; duffel bags; bags for campers; beach bags; briefcases [leather goods]; pocket wallets; key cases; credit card cases [wallets]; attaché cases; bags; courier bags.

21 – Tableware, cookware and containers; mugs; dishes; thermal insulated bags for food or beverages; insulating flasks.

25 – Clothing; footwear; headgear; gloves [clothing]; coats; outerclothing.

35 – Wholesale and retail services relating to the following goods: sunglasses, computer peripheral devices, mouse pads, chargers, power banks, loudspeakers, headphones, sleeves for laptops, cell phone covers, decorative magnets, mobile phone holders, helmets for bicycles, helmets for motorcyclists; wholesale and retail services relating to the following goods: planners [printed matter], albums, photographic albums, albums for stickers, almanacs, bookmarks, comic books, covers [stationery], drawing materials, composition books, drawing pens, drawing rulers, drawing sets, folders [stationery], paper folders, money holders, bond paper, writing tablets, envelopes [stationery], writing stationery, loose-leaf binders, data books, address books; wholesale and retail services relating to the following goods: trading cards, posters, postcards, printed calendars, occasion cards, colouring books, stickers [stationery], pens, pencils, rubber erasers, pencil boxes, pencil sets, pencil sharpeners, pencil holders, school supplies [stationery], table napkins of paper, table linen of paper, tablecloths of paper, writing sets, writing materials, albums for stickers; wholesale and retail services relating to the following goods: trunks and suitcases, umbrellas and parasols, rucksacks, school bags, weekend bags, duffel bags, bags for campers, beach bags, briefcases [leather goods], pocket wallets, key cases, credit card cases [wallets], attaché cases, bags, courier bags; wholesale and retail services relating to the following goods: tableware, cookware and containers, mugs, dishes, thermal insulated bags for food or beverages, insulating flasks; wholesale and retail services relating to the following goods: clothing, footwear, headgear, gloves [clothing], coats, outerclothing.

(260) AM 2023 120308 A
 (800) 1695265
 (151) 2022 03 22
 (891) 2022 03 22
 (731) Koppert B.V.

Veilingweg 14, NL-2651 BE Berkel en Rodenrijs, Netherlands

(540)



(591) Black, white
 (531) 27.05.04; 27.05.17; 27.05.21; 27.05.25
 (511)

1 – Fertilizers; biostimulants for plants; soil conditioners; biological products for stimulating the growth

and development and improvement of crops; substances for promoting plant growth; plant growth nutrients; growth regulating preparations for crops; seed preserving substances; adjuvants for agriculture, horticulture and forestry.

5 – Preparations and products for the protection of crops against pests, vermin, diseases and insects included in this class, including preparations and products for the protection of crops against pests, vermin, diseases and insects based on micro-organisms or natural substances included in this class; biocides; pesticides; insecticides; fungicides; acaricides; parasiticides; preparations and products for controlling pests and vermin, including insects; herbicides; adhesive strips impregnated with insect attractant preparations or impregnated with glue for attracting and killing insects; insect catching adhesives being insect attractants; insect repellents; insect attractants; repellents for animals; veterinary preparations; parasite-killing agents; nutritional supplements for animals.

9 – Software for use in agriculture, horticulture, forestry and livestock healthcare and farming; computer hardware for use in agriculture, horticulture, forestry and livestock healthcare and farming; application software for use in agriculture, horticulture, forestry and livestock healthcare and farming; downloadable software applications for use in agriculture, horticulture, forestry and livestock healthcare and farming; mobile apps for use in agriculture, horticulture, forestry and livestock healthcare and farming; computer software platforms for use in agriculture, horticulture, forestry and livestock healthcare and farming; environmental monitoring software for use in agriculture, horticulture, forestry and livestock healthcare and farming; measuring, detecting and monitoring instruments, indicators and controllers for use in agriculture, horticulture, forestry and livestock healthcare and farming; monitoring instruments for use in agriculture, horticulture, forestry and livestock healthcare and farming; observation instruments for use in agriculture, horticulture, forestry and livestock healthcare and farming.

20 – Beehives; nest boxes for bumblebees.

21 – Devices for pest and vermin control; electric household diffusers for insect, pest and vermin repellents; insect traps; fly traps.

31 – Agricultural, horticultural, forestry and livestock products and grains not included in other classes; live animals, including live animals for pest control and for pollination; animal feed; dried insects for animal feed; insects (dried) for use in animal nutrition.

44 – Agriculture, horticulture, forestry and livestock healthcare and farming services; advisory and consultancy services relating to agriculture, horticulture, forestry and livestock healthcare and farming; services relating to the control and extermination of insects, micro-organisms, pests and vermin for agriculture,

horticulture, forestry and livestock and pollination; consultancy in the field of biological pest control and in the field of natural pollination; cultivation of insects, mites, nematodes, fungi, bacteria and bumblebees; consultancy in relation to agricultural services for the analysis of samples taken from crops for determining possible diseases and pests; pest control in the nature on-site checking (including by hand) to determine possible plant diseases and pests; pest control services for agriculture, horticulture and forestry by placing traps (possibly in combination with bait) for detecting insects whereby diseases and pests, caused by those insects, can be determined and controlled; providing pest control information based on samples taken and checking (including by hand) for possible diseases and pests; the aforementioned services also provided through the use of drones, agricultural, horticultural, forestry and livestock machines, equipment, apparatus and vehicles.

(260) AM 2023 120309 A
 (800) 1695281
 (151) 2022 04 19
 (891) 2022 04 19
 (731) Levent Kimya Sanayi Ve Ticaret Anonim Şirketi
 Antalya Organize Sanayi Bölgesi, 1. Kısım 1.
 Cadde No:12 Döşemealtı, Antalya, Türkiye
 (540)



(591) Black, white
 (531) 01.15.23; 26.01.02; 26.01.13; 26.01.19;
 27.05.02; 27.05.17
 (511)
 1 – Chemicals used in industry, science, photography, agriculture, horticulture and forestry; chemicals for pool, powder chlorine, liquid chlorine, liquid acid, powder acid, pH reducing chemical preparations, pH booster, particle solvent, water conditioning chemicals; chemical preparations used for prevention of lime, biological moss and fungus which multiplies on metal surfaces in a humid environment in hot water boiler, steam boiler and heating system; corrosive preparations; hydrochloric acid.
 3 – Bleaching and cleaning preparations, namely, detergents other than for use in manufacturing operations and for medical purposes, laundry bleach, fabric softeners for laundry use, stain removers, dishwasher detergents; soaps; abrasive preparations including emery cloth, sandpaper, pumice stone, abrasive pastes; polishing preparations for leather, vinyl, metal

and wood, namely, polishes and creams for leather, vinyl, metal and wood; wax for polishing; cleaning preparation for tile, toilet, sink, bath tub, vinyl floor covering, glazed tile, marble and mosaic; wallpaper cleaner, plastic and oil paint cleaners, carpet and seat cleaner; shirt, collar and arm grime cleaner; body oil stains cleaner, blood cleaner for fabrics and other surfaces, cleaner for liquid fuel stains, tar cleaner, coal tar cleaner, polishes for metal; cleaning chalk, drain opener and obstruction removers for household use; shampoo, detergent, mechanics cleaning powders, dishwashing machine powder, dishwashing machine salts and polisher, bleaching preparations, washing soda, laundry softener, laundry whitening, laundry glaze, abrasive and polishing preparations in the form of liquid and powder, soap powder, soft soap, liquid hand soap, liquid and powder detergents for the washing machine, glass cleaning substances for glass surface; substances for laundry use, washing dishes and cleaning of all kinds of surfaces; fabric softeners, fabric conditioner; floor and carpet cleaners; cleaning chalk and lime removers for use in all types of devices and machines, including electrical devices and machines; filter cleaner, resin cleaner, oil and dirt cleaner, cleaning chalk, lime purifying for aluminum pots and containers and auto radiators, lime purifying chemicals for copper and iron surfaces, glass cleaning chemicals.

(260) AM 2023 120312 A
 (800) 1695330
 (151) 2022 10 02
 (891) 2022 10 02
 (731) Fashion Nova LLC
 2801 E. 46TH STREET, VERNON CA 90058,
 USA
 (540)

NOVABEAUTY

(591) Black, white
 (511)
 3 – Cosmetics, toilet preparations and perfumery products, namely, lipsticks, lip gloss, lip liners, lip balms, lip color palettes; eye shadows, eye lining pencils, liquid eye liners, eye makeup, mascara, eyebrow pencils, artificial eyelashes, eyeshadow palettes; blushers, multi-use cosmetic sticks, foundation makeup, pressed powder, loose powder, makeup remover, concealers, multi-use colored creams, powders and gels for use on face, cleansers, namely, facial cleansers and skin cleansers; exfoliators, namely, non-medicated skin and facial exfoliators; moisturizers for the face and body, masks for the face and body, skin toners, eye creams, disposable wipes impregnated with cleansing compounds for use on skin; non-medicated skin care creams, lotions, oils, sprays, and gels for the face and body; non-medicated beauty lotions, serums and sprays for the face and body; anti-cellulite and body firming creams, lotions, serums and sprays for

the face and body; nail polish, nail enamel; nail polish remover; suncare lotions, skin bronzers, sun tanning lotions, sunscreens, self-tanning preparations, after-sun skin soothers and rehydrators, namely, sun creams, lotions and gels; fragrances for personal use, all sold on trademark owner's e-commerce website and in trademark owner's retail stores.

(260) AM 2023 120319 A

(800) 1695487

(151) 2022 10 05

(891) 2022 10 05

(731) Vaxcyte Inc.

825 Industrial Road, Suite 300, San Carlos

CA 94070, USA

(540)

VAXCYTE

(591) Black, white

(511)

5 – Vaccines; vaccine preparations; therapeutic vaccines.

42 – Research and development of vaccines and medicines.

(260) AM 2023 120320 A

(800) 1695496

(151) 2022 09 28

(891) 2022 09 28

(731) Vienna Insurance Group AG

Wiener Versicherung Gruppe

Schottenring 30, A-1010 Wien, Austria

(540)



(591) Black, red, white

(531) 24.01.13; 24.13.25; 26.11.01; 26.11.06;
26.11.08; 26.11.13; 27.05.09; 27.05.10;
27.05.11; 29.01.13

(511)

36 – Insurance; financial affairs; monetary affairs; real estate affairs.

(260) AM 2023 120321 A

(800) 1695504

(151) 2022 05 11

(891) 2022 05 11

(731) BTL Industries

Tzar Kaloyan str 8, BG-1000 Sofia,

Bulgaria

(540)

EMFEMME

(591) Black, white

(511)

10 – Medical apparatus and instruments; aesthetic apparatus and instruments for aesthetic therapy, namely medical treatment apparatus and instruments generating electrical, magnetic, electromagnetic, mechanical or thermal therapeutic energy; aesthetic apparatus and aesthetic therapy instruments, namely medical treatment apparatus and instruments for body shaping, skin tightening, cellulite reduction, skin rejuvenation, wrinkle reduction, scar reduction, stretch mark reduction; aesthetic massage apparatus; gynaecological apparatus and instruments; urological apparatus and instruments; medical apparatus and instruments, namely medical treatment apparatus and instruments for genital rejuvenation, treatment of sexual dysfunction, strengthening muscles of the pelvic floor

(260) AM 2023 120322 A

(800) 1695505

(151) 2022 07 11

(891) 2022 07 11

(731) Euro Games Technology Ltd.

4, "Maritsa" Str., "Vranya-Lozen-Triugulnika",

BG-1151 Sofia, Bulgaria

(540)



(591) Yellow, red, green, black, white and brown

(531) 01.01.05; 01.15.07; 01.15.09; 27.05.01;
27.05.02; 27.05.03; 27.05.09; 27.05.10;
29.01.15

(511)

9 – Software; computer gaming software; computer software packages; computer operating system software; computer software, recorded; software drivers; virtual reality software; games software; entertainment software for computer games; computer programs for network management; operating computer software for main frame computers; monitors (computer hardware); computer hardware; apparatus for recording images; monitors (computer programs); computer game programs; computer programs for recorded games; apparatus for recording, transmission or reproduction of sound or images; communications servers [computer hardware]; electronic components for gambling machines; computer application software featuring games and gaming; computer software for the administration of on-line games and gaming; computer hardware for games and gaming; hardware and software for gambling, gambling machines, gambling

games on the Internet and via telecommunication network.

28 – Gaming machines for gambling; chips for gambling; mah-jong; arcade games; gambling machines operating with coins, notes and cards; games; electronic games; parlor games; gaming chips; gaming tables; slot machines [gaming machines]; LCD game machines; slot machines and gaming devices; coin-operated amusement machines; roulette chips; poker chips; chips and dice [gaming equipment]; gaming equipment for casinos; roulette tables; gaming roulette wheels; casino games; gambling machines and amusement machines, automatic and coin-operated; coin-operated amusement machines and/or electronic coin-operated amusement machines with or without the possibility of gain; boxes for coin-operated machines, slot machines and gaming machines; electronic or electrotechnical amusement machines and apparatus, gaming machines, coin-operated entertainment machines; housings for coin-operated machines, gaming equipment, gaming machines, machines for gambling; electropneumatic and electrical gambling machines (slot machines).

41 – Gambling; entertainment services related to gambling; gaming services for entertainment purposes; casino, gaming and gambling services; training in the development of software systems; provision of gaming equipment for gambling halls; providing casino equipment [gambling]; gaming machine entertainment services; providing casino facilities [gambling]; gaming hall services; amusement arcade services; games equipment rental; rental of gaming machines; providing amusement arcade services; rental of gaming machines with images of fruits; editing or recording of sounds and images; sound recording and video entertainment services; hire of sound reproducing apparatus; provision of gaming equipment for casinos; providing of casino facilities; online gambling services; casino, gaming and gambling services; provision of gaming facilities, gaming hall facilities, Internet casinos and online gambling services.

(260) AM 2023 120392 A

(800) 1696128

(151) 2022 04 25

(891) 2022 04 25

(731) Kazar Group Spółka z ograniczoną
Odpowiedzialnością

Lwowska 154, PL-37-700 Przemysł, Poland

(540)

kazar

(591) Black, white

(531) 27.05.01

(511)

3 – Scouring substances; leather and shoe cleaning and polishing preparations; cleaning agents for house-

hold purposes; soap; ethereal oils; cosmetics; hair lotions; perfumery and fragrances; dentifrices; perfumes; scented sachets; scented room sprays; shoe cream; leather preservatives [polishes]; boot wax; air fragrancing preparations; cosmetic creams and lotions; body lotions; hand lotions; hand creams; shower creams; cream soaps; shower gels; soaps and gels; shampoos; hair conditioners; shoe cleaning sprays; shoe cleaners [preparations]; detergent compositions for cleaning shoes.

9 – Prescription eyeglasses; sunglasses; spectacle frames; contact lenses; optical glass; magnifying glasses [optics]; chains for sunglasses; spectacle cases; spectacle cords; eyewear cases; memory sticks; electronic memory units; covers for data storage devices; carrying cases for cellular phones; cases for smartphones; portable telecommunications apparatus; portable chargers; software; software for tablet computers; downloadable software; computer software, recorded; software for smartphones; protective and safety equipment; protective masks; breathing masks; mobile apps; dust masks incorporating air purification; dust masks.

14 – Key fobs of common metal; key fobs of precious metals; key rings [split rings with trinket or decorative fob]; jewellery; cabochons; time instruments; cases [fitted] for clocks; jewellery rolls; cuff links; charms for key rings; clasps for jewellery; amulets [jewellery]; shoe jewellery; watches.

18 – Leather luggage straps; girths of leather; rucksacks; bags; purses; gentlemen's handbags; hipsacks; pocket wallets; card cases [notecases]; credit-card holders; key cases; business card cases; vanity cases, not fitted; umbrellas; luggage, bags, wallets and carrying bags; shoulder bags; handbags; boston bags; clutches [purses]; bumbags; beach bags; travelling sets [leatherware]; shoe bags for travel; briefcases; folio cases; school bags; bags for sports; shaving bags sold empty; luggage tags; handbag frames; grips [bags]; shoulder straps; travel garment covers; nappy bags; bags made of imitation leather; flight bags; wash bags for carrying toiletries.

25 – Clothing; shoes; insoles for footwear; gloves [clothing]; soles for footwear; hats; shoe straps; neckerchiefs; face mask [clothing]; footwear uppers; trousers of leather; leather jackets; leather waistcoats; leather suits; clothing of leather; dresses made from skins; leather belts [clothing]; leather shoes; leather slippers.

(260) AM 2023 120393 A

(800) 1696129

(151) 2022 03 28

(891) 2022 03 28

(731) PPF A.S.

Evropská 2690/17, CZ-160 41 Praha 6,
Dejvice, Czech Republic

(540)



(591) Navy blue and lime green

(531) 24.17.02; 26.04.18; 27.05.21; 29.01.12

(511)

9 – Scientific, nautical, surveying, photographic, cinematographic, optical apparatus and instruments; apparatus and instruments for weighing, measuring, signalling, checking (supervision), life-saving included in this class and teaching apparatus and instruments; apparatus and instruments for conducting, switching, transforming, accumulating, regulating or controlling of electric current; apparatus for recording, conversion, transmission or reproduction of sound or images; magnetic data media; optical data media; recording discs; SD cards; micro SD cards; USB flash drives; memory cards; hard disc drives; mechanisms for coin-operated apparatus; calculating machines; data-processing apparatus and computers; apparatus for transmission of sound and image; telecommunication apparatus; mobile telecommunication apparatus; mobile telecommunication kits; computer hardware; computer software; computer software, downloadable from the Internet; multimedia applications; PDA (personal digital assistant) pocket PCs; mobile telephones; laptop computers; telecommunication network apparatus; operating software for telecommunication networks and for telecommunication apparatus; video cameras; cameras; MP3 and MP4 players; electronic publications (downloadable); periodicals in electronic form; electronic databases and databases products; information and data in electronic form; downloadable data, information and databases recorded on data carriers, electronic data carriers, computer and communication networks of all kinds; covers for mobile phones and computers; protective films and cases adapted for mobile phones and computers; parts and accessories for all the aforesaid goods included in this class.

16 – Printed matter, paper labels, printed forms, brochures, printed catalogues, printed manuals, printed reference, user and other manuals, printed instructions for use and document files relating to user guides for computing, telecommunication and technical equipment and apparatus.

35 – Advertising, publicity and promotional activities; marketing; rental of advertising time to advertisers; providing commercial or advertising information and data; commercial services provided by means of the Internet or other media; data search in computer files for others; online advertising; intermediation in the fi-

eld of business relations; business management assistance; business administration; office functions; retail and wholesale services in connection with scientific, nautical, surveying, photographic, cinematographic, optical apparatus and instruments, apparatus and instruments for weighing, measuring, signaling, checking (supervision), life-saving included in class 9 and teaching apparatus and instruments, apparatus and instruments for conducting, switching, transforming, accumulating, regulating or controlling of electric current, apparatus for recording, conversion, transmission or reproduction of sound or images, magnetic data media, optical data media, recording discs, SD cards, micro SD cards, USB flash drives, memory cards, hard disc drives, mechanisms for coin-operated apparatus, calculating machines, data-processing apparatus and computers, apparatus for transmission of sound and image, telecommunication apparatus, mobile telecommunication apparatus, mobile telecommunication kits, computer hardware, computer software, computer software, downloadable from the Internet, multimedia applications, PDA (personal digital assistant), pocket PCs, mobile telephones, laptop computers, telecommunication network apparatus, operating software for telecommunication networks and for telecommunication apparatus, video cameras, cameras, MP3 and MP4 players, electronic publications (downloadable), periodicals in electronic form, electronic databases and databases products, information and data in electronic form, downloadable data, information and databases recorded on data carriers, electronic data carriers, computer and communication networks of all kinds, covers for mobile phones and computers, protective films and cases adapted for mobile phones and computers, parts and accessories for all the aforesaid goods included in class 9, online retail and wholesale services in connection with scientific, nautical, surveying, photographic, cinematographic, optical apparatus and instruments, apparatus and instruments for weighing, measuring, signaling, checking (supervision), life saving included in class 9 and teaching apparatus and instruments, apparatus and instruments for conducting, switching, transforming, accumulating, regulating or controlling of electric current, apparatus for recording, conversion, transmission or reproduction of sound or images, magnetic data media, optical data media, recording discs, SD cards, micro SD cards, USB flash drives, memory cards, hard disc drives, mechanisms for coin operated apparatus, calculating machines, data-processing apparatus and computers, apparatus for transmission of sound and image, telecommunication apparatus, mobile telecommunication apparatus, mobile telecommunication kits, computer hardware, computer software, computer software, downloadable from the Internet, multimedia applications, PDA (personal digital assistant), pocket PCs, mobile telephones, laptop computers, telecommunication network apparatus, operating software for telecommunication networks and for telecommunica-

tion apparatus, video cameras, cameras, MP3 and MP4 players, electronic publications (downloadable), periodicals in electronic form, electronic databases and databases products, information and data in electronic form, downloadable data, information and databases recorded on data carriers, electronic data carriers, computer and communication networks of all kinds, covers for mobile phones and computers, protective films and cases adapted for mobile phones and computers, parts and accessories for all the aforesaid goods included in class 9, business mediation in the trade of scientific, nautical, surveying, photographic, cinematographic, optical apparatus and instruments, apparatus and instruments for weighing, measuring, signaling, checking (supervision), life-saving included in class 9 and teaching apparatus and instruments, apparatus and instruments for conducting, switching, transforming, accumulating, regulating or controlling of electric current, apparatus for recording, conversion, transmission or reproduction of sound or images, magnetic data media, optical data media, recording discs, SD cards, micro SD cards, USB flash drives, memory cards, hard disc drives, mechanisms for coin-operated apparatus, calculating machines, data-processing apparatus and computers, apparatus for transmission of sound and image, telecommunication apparatus, mobile telecommunication apparatus, mobile telecommunication kits, computer hardware, computer software, computer software, downloadable from the Internet, multimedia applications, PDA (personal digital assistant), pocket PCs, mobile telephones, laptop computers, telecommunication network apparatus, operating software for telecommunication networks and for telecommunication apparatus, video cameras, cameras, MP3 and MP4 players, electronic publications (downloadable), periodicals in electronic form, electronic databases and databases products, information and data in electronic form, downloadable data, information and databases recorded on data carriers, electronic data carriers, computer and communication networks of all kinds, covers for mobile phones and computers, protective films and cases adapted for mobile phones and computers, parts and accessories for all the aforesaid goods included in class 9; computerized data processing; systematization of information into computer databases; market research and market analysis; promotion by electronic means, including via Internet search engines; consultancy in the field of Internet marketing; rental of advertising spaces; dissemination of advertising matter; opinion polling; collecting, classifying, sorting and updating of data; administration and management of databases with marketing information; providing business information, including via Internet, via the cable network or via other forms of data transmission; information, consultancy and advisory services in relation to the aforesaid services in this class; providing market research services and consumer product information for

others by brokers and other professional information providers.

36 – Banking; factoring; financing services; hire-purchase financing; financial analysis; financial evaluation (insurance, banking, real estate); financial information; financial consultancy; financial management; financial sponsorship; financial clearing houses; financial clearing; mortgage banking; investment of funds; capital investment; brokerage services; stocks and bonds brokerage; securities brokerage; online banking; insurance consultancy; providing financial information via a website; providing of rebates at participating establishments of others through use of a membership card; loans (financing); instalment loans; lending against security; financial research; insurance underwriting; fire insurance underwriting; accident insurance underwriting; health insurance underwriting; life insurance underwriting; insurance and reinsurance brokerage.

37 – Building construction supervision services relating to the construction of industrial complexes and residential buildings; construction, assembly relating to the installation, maintenance and repair of telecommunication equipment, radio communication equipment and data processing machines and equipment; installation, assembly relating to the installation, maintenance and repair of domestic and foreign telecommunication equipment and other equipment; installation, assembly relating to the installation, maintenance and repair of electrical machinery, apparatus and equipment; installation, assembly services relating to the installation, maintenance and repair of measuring and control equipment.

38 – Wireless broadcasting; electronic bulletin board services (telecommunication services); information about telecommunications; communication by fiber optic networks; communication by cellular phones; communication by computer terminals; online transmission of greeting cards; paging (radio, telephone or other means of electronic communication); providing internet chatrooms; providing online forums; providing access to databases; providing telecommunication connections to a global computer network; providing telecommunications channels for teleshopping services; providing user access to global computer networks; rental of access time to global computer networks; rental of fax machines; rental of modems; rental of apparatus for transmitting messages; rental of telephones; rental of telecommunication equipment; transmission of digital files; electronic mail transmission; facsimile transmission; telegram transmission; video-on-demand transmission; computer-aided transmission of messages and images; radio communication; radio broadcasting; satellite transmission; voice mail services; news agency services; telecommunications routing and junction services; streaming of data; communication by telephone; telephone

services; communication by telegraph; telegraph services; teleconferencing services; television broadcasting; telex services; videoconferencing services; cable television broadcasting; messaging services; communications (telecommunications); network telecommunication services; mobile telecommunication services; telecommunication services provided via Internet portals; providing access to mobile telecommunication networks; activity in the field of telecommunication, mobile telecommunication and data communication services; landline telecommunication services, provision of broadband telecommunications access; wireless broadband communication services; broadcasting services; television broadcasting services; broadcasting services relating to IP/TV or based on IP/TV; IP/TV access services; television broadcasting services provided via the Internet Protocol technology, including IP/TV television and IP/TV; providing access to the Internet; services of e-mail, text and multimedia messages; services relating to the provision of access to computer networks, in particular reservation, provision and rental of access time to data networks and databases, in particular to the Internet; provision of access to computer databases and communication services relating thereto; advisory services relating to rental of telecommunication equipment; providing access to information via data networks; expert advisory and consultancy services in the field of telecommunication and data communication services; information, consultancy and advisory services in relation to the aforesaid services in this class; rental of telecommunications apparatus; rental of data transmission apparatus; rental of telecommunication apparatus and installations.

41 – Publishing and writing of texts, other than publicity texts; education and training; training services; entertainment, sports and cultural activities; interactive entertainment services; electronic games services provided via computer networks or communication networks; entertainment and information services relating to the aforesaid services provided via telecommunication networks; news reporters services; television entertainment services; providing entertainment via television and IP/TV; information, consultancy and advisory services relating to the aforesaid services in this class.

42 – Development of databases; updating of computer software; computer system analysis; cloud computing; digitization of documents (scanning); electronic monitoring of personally identifying information to detect identity theft via the Internet; electronic monitoring of credit card activity to detect fraud via the Internet; off-site data backup; graphic design of promotional materials; websites hosting services; installation of computer software; conversion of computer programs and data other than physical conversion; duplication of computer programs; recovery of computer data; unlocking of mobile phones; platform as a service (Pa-

aS); computer programming; information technology (IT) consultancy; Internet security consultancy; consultancy in the design and development of computer hardware; website design consultancy; computer software consultancy; computer technology consultancy, data encryption services, telecommunications technology consultancy; data security consultancy; computer security consultancy; providing information on computer technology and programming via a website; information technology services provided on an outsourcing basis; rental of computer software; rental of computers and data processing equipment; rental of web servers; surveying, providing search engine for the Internet; server hosting; monitoring of computer systems for detecting unauthorized access or data breach; monitoring of computer systems to detect breakdowns; software as a service (SaaS); computer software design, computer system design; maintenance of computer software; development of computer platforms; software development in the framework of software publishing; research in the field of telecommunications technology; monitoring of computer systems by remote access; scientific and technological services and research and development relating thereto; industrial analysis and research; research in the field of telecommunications, data services and telecommunication technology; designing, development and analysis of computer, telecommunication and data systems; rental of computers and data processing apparatus and installations; monitoring of telecommunication and data systems; technical consulting services in the field of information technology, computer technology and data technology; engineering services in the field of information, telecommunications and data technology; design and development of computer hardware and software; information technology engineering services; computer programming services; programming services; recovery of computer data; consultancy in the field of computer software, consultancy in the design and development of computer hardware; backup and copying of computer programs; rental of computers; creation, design and development of computer software; installation and maintenance of computer software; rental of computer software and hardware; conversion of data or documents from physical to electronic media; conversion of data and computer programs (not physical conversion); creating and maintaining websites for others; webhosting; planning and designing services in the field of telecommunication equipment; information, consultancy and advisory services relating to the aforesaid services in this class.

-
- (260) AM 2023 120394 A
 - (800) 1696130
 - (151) 2022 04 05
 - (891) 2022 04 05
 - (731) İpekyol Giyim Sanayipazarlama Ve

Ticaret A.Ş.
 Merkez Mah. Kazim Orbay Cad.,
 Ipekyol Konf. 35 1 Şişli, İstanbul, Türkiye

(540)



(591) Black, white

(531) 25.07.01; 26.13.25; 27.05.23

(511)

18 – Unworked or semi-worked leather and animal skins, imitations of leather, stout leather, leather used for linings; goods made of leather, imitations of leather or other materials, designed for carrying items, included in this class, namely, all-purpose carrying bags; bags, wallets, boxes and trunks made of leather or stout leather, keycases; trunks [luggage], suitcases; umbrellas; parasols; sun umbrellas; walking sticks; whips; harness; saddlery; stirrups; straps of leather (saddlery).

25 – Clothing, including underwear and outer clothing, other than special purpose protective clothing; socks, mufflers [clothing], shawls, bandanas, scarves, belts [clothing]; footwear, shoes, slippers, sandals; headgear, hats, caps with visors, berets, caps [headwear], skull caps.

35 – Advertising, marketing and public relations; organization of exhibitions and trade fairs for commercial or advertising purposes; development of advertising concepts; provision of an online marketplace for buyers and sellers of goods and services; office functions; secretarial services; arranging newspaper subscriptions for others; compilation of statistics; rental of office machines; systemization of information into computer databases; telephone answering for unavailable subscribers; business management, business administration and business consultancy; accounting; commercial consultancy services; personnel recruitment, personnel placement, employment agencies, import-export agencies; temporary personnel placement services; auctioneering; the bringing together, for the benefit of others, of a variety of goods, namely, bleaching and cleaning preparations, detergents other than for use in manufacturing operations and for medical purposes, laundry bleach, fabric softeners for laundry use, stain removers, dishwasher detergents, perfumery, non-medicated cosmetics, fragrances, deodorants for personal use and animals, soaps, dental care preparations: dentifrices, denture polishes, tooth whitening preparations, mouthwashes, not for medical purposes, abrasive preparations, emery cloth, sandpaper, pumice stone, abrasive pastes, polishing preparations for leather, vinyl, metal and wood, polishes and cre-

ams for leather, vinyl, metal and wood, wax for polishing, candles, wicks, semi-finished wax, wax and paraffin for lighting purposes, pharmaceutical and veterinary preparations for medical purposes, chemical preparations for medical and veterinary purposes, chemical reagents for pharmaceutical and veterinary purposes, medicated cosmetics, dietary supplements for pharmaceutical and veterinary purposes, dietary supplements, nutritional supplements, medical preparations for slimming purposes, food for babies, herbs and herbal beverages adapted for medicinal purposes, deodorants, other than for human beings or for animals, air purifying preparations, air deodorising preparations, disinfectants, antiseptics, detergents for medical purposes, medicated soaps, disinfectant soaps, antibacterial hand lotions, forks, spoons, knives and non-electric cutters, slicers, peelers for kitchen use, including those made of precious metals, side arms and blades (weapons), tools and apparatus for personal beauty care use, tools and apparatus for shaving, epilation, manicure and pedicure, electric hand implements for straightening and curling hair, scissors, hand-operated [non-electric] hand tools for the repair of machines, apparatus and vehicles and for use in construction, agriculture, horticulture and forestry, none of them being power tools, electric or non-electric irons, steam irons, handles for hand-operated hand tools, measurement apparatus and equipment including those for scientific, nautical, topographic, meteorologic, industrial and laboratory purposes, thermometers, not for medical purposes, barometers, ammeters, voltmeters, hygrometers, testing apparatus not for medical purposes, telescopes, periscopes, directional compasses, speed indicators, laboratory apparatus, microscopes, magnifying glasses, stills, binoculars, ovens and furnaces for laboratory experiments, apparatus for recording, transmission or reproduction of sound or images, cameras, photographic cameras, television apparatus, video recorders, CD and DVD players and recorders, MP3 players, computers, desktop computers, tablet computers, wearable technological devices (smart watches, wristbands, head-mounted devices), microphones, loudspeakers, earphones, telecommunications apparatus, apparatus for the reproduction of sound or images, computer peripheral devices, cell phones, covers for cell phones, telephone apparatus, computer printers, scanners [data processing equipment], photocopiers, magnetic and optical data carriers and computer software and programmes recorded thereto, downloadable and recordable electronic publications, encoded magnetic and optical cards, movies, tv series and video music clips recorded on magnetic, optical and electronic media, antennas, satellite antennas, amplifiers for antennas, parts of the aforementioned goods, ticket dispensers, automatic teller machines (ATM), electronic components used in the electronic parts of machines and apparatus, semi-conductors, electronic circuits, integrated circuits, chips [integrated circuits], diodes, transistors

[electronic], magnetic heads for electronic apparatus, electronic locks, photocells, remote control apparatus for opening and closing doors, optical sensors, counters and quantity indicators for measuring the quantity of consumption, automatic time switches, clothing for protection against accidents, irradiation and fire, safety vests and life-saving apparatus and equipment, eyeglasses, sunglasses, optical lenses and cases, containers, parts and components thereof, apparatus and instruments for conducting, transforming, accumulating or controlling electricity, electric plugs, junction boxes [electricity], electric switches, circuit breakers, fuses, lighting ballasts, battery starter cables, electrical circuit boards, electric resistances, electric sockets, transformers [electricity], electrical adapters, battery chargers, electric door bells, electric and electronic cables, batteries, electric accumulators, solar panels for production of electricity, alarms and anti-theft alarms, other than for vehicles, electric bells, signalling apparatus and instruments, luminous or mechanical signs for traffic use, fire extinguishing apparatus, fire engines, fire hose and fire hose nozzles, radar apparatus, sonars, night vision apparatus and instruments, decorative magnets, metronomes, lighting installations, lights for vehicles and interior-exterior spaces, installations for air-conditioning and ventilating, cooling installations and freezers, electric and gas-powered devices, installations and apparatus for cooking, drying and boiling, cookers, electric cooking pots, electric water heaters, barbecues, electric laundry driers, hair driers, hand drying apparatus, water softening apparatus, water purification apparatus, water purification installations, waste water purification installations, electric bed warmers and electric blankets, not for medical use, electric pillow warmers, electric or non-electric footwarmers, hot water bottles, electrically heated socks, pasteurizers and sterilizers, fireworks, jewellery, imitation jewellery, gold, precious stones and jewellery made thereof, cufflinks, tie pins, statuettes and figurines of precious metal, clocks, watches and chronometrical instruments, chronometers and their parts, watch straps, trophies made of precious metal, rosaries, musical instruments and cases for musical instruments, paper and cardboard, paper and cardboard for packaging and wrapping purposes, cardboard boxes, paper towels, toilet paper, paper napkins, printed publications, printed matter, books, magazines, newspapers, bill books, printed dispatch notes, printed vouchers, calendars, posters, photographs [printed], paintings, stickers [stationery], postage stamps, stationery, office stationery, instructional and teaching material [except furniture and apparatus], writing and drawing implements, artists' materials, paper products for stationery purposes, adhesives for stationery purposes, pens, pencils, erasers, adhesive tapes for stationery purposes, cardboard cartons [artists' materials], writing paper, copying paper, paper rolls for cash registers, drawing materials, chalkboards, painting pencils, watercolors [paintings], un-

worked or semi-worked leather and animal skins, imitations of leather, stout leather, leather used for linings, goods made of leather, imitations of leather or other materials, designed for carrying items, bags, wallets, boxes and trunks made of leather or stout leather, keycases, trunks [luggage], suitcases, umbrellas, parasols, sun umbrellas, walking sticks, whips, harness, saddlery, stirrups, straps of leather (saddlery), furniture, made of any kind of material, mattresses, pillows, air mattresses and cushions, not for medical purposes, water beds, mirrors, beehives, artificial honeycombs and sections of wood for honeycombs, bouncing chairs for babies, playpens for babies, cradles, infant walkers, display boards, frames for pictures and paintings, identification plates, identification tags, nameplates, identification labels made of wood or synthetic materials, packaging containers of wood or plastics, casks for use in transportation or storage, barrels, storage drums, tanks, boxes, storage containers, transportation containers, chests, loading pallets and closures for the aforementioned goods, of wood or plastics, small hardware goods of wood or synthetic materials, furniture fittings, of wood or synthetic materials, opening and closing mechanisms of wood or synthetic materials, ornaments and decorative goods of wood, cork, reed, cane, wicker, horn, bone, ivory, whalebone, shell, amber, mother-of-pearl, meerschaum, beeswax, plastic or plaster namely figurines, holiday ornaments for walls, sculptures, trophies, baskets, fishing baskets, kennels, nesting boxes and beds for household pets, portable ladders and mobile boarding stairs of wood or synthetic materials, bamboo curtains, roller indoor blinds [for interiors], slatted indoor blinds, strip curtains, bead curtains for decoration, curtain hooks, curtain rings, curtain tie-backs, curtain rods, non-metal wheel chocks, hand-operated non-electric cleaning instruments and appliances, brushes, other than paintbrushes, steel chips for cleaning, sponges for cleaning, steel wool for cleaning, cloths of textile for cleaning, gloves for dishwashing, non-electric polishing machines for household purposes, brooms for carpets, mops, toothbrushes, electric toothbrushes, dental floss, shaving brushes, hair brushes, combs, non-electric household or kitchen utensils, [other than forks, knives, spoons], services [dishes], pots and pans, bottle openers, flower pots, drinking straws, non-electric cooking utensils, ironing boards and shaped covers therefor, drying racks for washing, clothes drying hangers, cages for household pets, indoor aquariums, vivariums and indoor terrariums for animals and plant cultivation, ornaments and decorative goods of glass, porcelain, earthenware or clay namely statues, figurines, vases and trophies, perfume burners, perfume sprayers, perfume vaporizers, electric or non-electric make-up removing appliances, powder puffs, toilet cases, ropes, strings, rope ladders, hammocks, fishing nets, tents, awnings, tarpaulins, sails, vehicle covers, not fitted, bags of textile, for packaging, padding and stuffing materials, except of

rubber and plastics, including those of wool and cotton, textile fibers, raw spun fiber, glass fibers for textile use, yarns and threads for textile use, threads and yarns for sewing, embroidery and knitting, thread, elastic yarns and threads for textile use, woven or non-woven textile fabrics, textile goods for household use, curtains, bed covers, sheets (textile), pillowcases, blankets, quilts, towels, flags, pennants, labels of textile, swaddling blankets, sleeping bags for camping, clothing, including underwear and outerclothing, other than special purpose protective clothing, socks, mufflers [clothing], shawls, bandanas, scarves, belts [clothing], footwear, shoes, slippers, sandals, headgear, hats, caps with visors, berets, caps [headwear], skull caps, footwear, shoes, slippers, sandals, headgear, hats, caps with visors, berets, caps [headwear], skull caps, laces and embroidery, guipures, festoons, ribbons (haberdashery), ribbons and braid, fastening tapes for clothing, cords for clothing, letters and numerals for marking linen, embroidered emblems, badges for wear, not of precious metal, shoulder pads for clothing, buttons for clothing, fasteners for clothing, eyelets for clothing, zippers, buckles for shoes and belts, fasteners, shoe and belt buckles, pins, other than jewellery, adhesive patches for decoration of textile articles, laces, needles, sewing needles, needles for sewing machines, needles for knitting and embroidery, boxes for needles, needle cushions, artificial flowers, artificial fruits, hair pins, hair buckles, hair bands, decorative articles for the hair, not made of precious metal, wigs, hair extensions, electric or non-electric hair curlers, other than hand implements, carpets, rugs, mats, prayer rugs, linoleum, artificial turf, linoleum for covering floors, gymnasium mats, wallpaper, wall hangings not of textile, games and toys, toys for animals, meat, fish, poultry and game, processed meat products, dried pulses, soups, bouillon, processed olives, olive paste, milks of animal origin, milks of herbal origin, milk products, butter, edible oils, dried, preserved, frozen, cooked, smoked or salted fruits and vegetables, tomato paste, prepared nuts and dried fruits as snacks, hazelnut spreads and peanut butter, tahini (sesame seed paste), eggs and powdered eggs, potato chips, coffee, cocoa, coffee or cocoa based beverages, chocolate based beverages, pasta, stuffed dumplings, noodles, pastries and bakery products based on flour, desserts based on flour and chocolate, bread, simit [Turkish ring-shaped bagel covered with sesame seeds], pogaça [Turkish bagel], pita, sandwiches, katmer [Turkish pastry], pies, cakes, baklava [Turkish dessert based on dough coated with syrup], kadayıf [Turkish dessert based on dough], desserts based on dough coated with syrup, puddings, custard, kazandibi [Turkish pudding], rice pudding, keşkül [Turkish pudding], honey, bee glue for human consumption, propolis for food purposes, condiments for foodstuff, vanilla (flavoring), spices, sauces (condiments), tomato sauce, yeast, baking powder, flour, semolina, starch for food, sugar, cube sugar, powde-

red sugar, tea, ice tea, confectionery, chocolate, biscuits, crackers, wafers, chewing gums, ice-cream, edible ices, salt, cereal-based snack food, popcorn, crushed oats, corn chips, breakfast cereals, processed wheat for human consumption, crushed barley for human consumption, processed oats for human consumption, processed rye for human consumption, rice, molasses for food, agricultural and horticultural products, seeds, forestry products, live animals, fertilized eggs for hatching, plants, dried plants for decoration, fresh garden herbs, dried garden herbs for decoration, animal foodstuffs, malt not for human consumption, underlays for pets, cat litters, beers, preparations for making beer, mineral water, spring water, table water, soda water, fruit and vegetable juices, fruit and vegetable concentrates and extracts for making beverages, non-alcoholic soft drinks, energy drinks, protein-enriched sports beverages, alcoholic beverages (except beers), wines, raki (traditional Turkish alcoholic drink), whisky, liqueurs, alcoholic cocktails, tobacco, chewing tobacco, cigarettes, cigars, smokers' articles including those made of precious metals, pipes, mouthpieces for cigars and cigarettes, ashtrays, tobacco boxes, pocket apparatus for rolling cigarettes, cigarette paper, tobacco pipes, firestones, lighters for smokers, electronic cigarettes and their cartridges, matches, enabling customers to conveniently view and purchase those goods, such services may be provided by retail stores, wholesale outlets, by means of electronic media or through mail order catalogues.

(260) AM 2023 120395 A

(800) 1696148

(151) 2022 07 05

(891) 2022 07 05

(731) Rhofa S.R.L.

Via Arena 29, I-61022 VALLEFOGLIA (PU), Italy

(540)

rother

(591) Black, white

(531) 26.15.25; 27.01.25

(511)

9 – Light switches; electric breakers [switches]; cables, electric; cell switches [electricity]; circular slide rules; coils, electric; conductors, electric; connections for electric lines; connectors [electricity]; distribution boxes [electricity]; distribution boards [electricity]; lighting control panels; illumination regulators; remote control apparatus for controlling lighting; distribution consoles [electricity]; electricity conduits; materials for electricity mains [wires, cables]; electricity conduits; cable covers [conduits]; electrified rails for mounting spot lights; electro-dynamic apparatus for the remote control of signals; electrolysis apparatus; electromagnetic coils; control panels [electricity]; el-

ectrical adapters; electric sockets; multi-outlet socket blocks; plug adaptors; plug connectors; aerials; ammeters; amplifying tubes; anti-theft warning apparatus; armatures [electricity]; battery jars; battery boxes; battery chargers; branch boxes [electricity]; buzzers; junction sleeves for electric cables; lightning conductors; LED light engines; flashing safety lights; emergency warning lights; apparatus and instruments for conducting, switching, transforming, accumulating, regulating or controlling electricity; electric transformers for lighting.

11 – Lighting apparatus and installations; incandescent light bulbs; light bulbs, electric; LED luminaires; LED lamps; pocket torches, electric; aquarium lights; electric lamps; lamps; wall lights; spotlights; diving lights; lampshades; ceiling lights; oil lamps; solar cell lighting apparatus; solar lamps; searchlights; floor lamps; lanterns for lighting; electric torches; LED flashlights; head torches; helmet lights; light diffusers; light-emitting diodes [LED] lighting apparatus; igniters; outdoor lighting fixtures; street lamps; roadlights; installations for street lighting; light projectors; strip lights; neon lamps for illumination; emergency lighting installations; lighting apparatus for vehicles; mobile light towers; floodlights; light panels; lighting fittings; discharge tubes, electric, for lighting; luminous tubes for lighting; luminous cables for lighting purposes; LED light strips; fairy lights for festive decoration; filaments for electric lamps; gas lamps; laboratory lamps; lamp glasses; lamp chimneys; lamp globes; lamp reflectors; lampshades; ventilating fans; turbine ventilators [ventilation apparatus]; suction ventilators; ceiling fans; electric fans; table fans; aeolian ventilators; ventilating fans; ventilation grilles being parts of extractor fans; solar powered ventilation apparatus.

(260) AM 2023 120396 A
 (800) 1696150
 (151) 2022 07 08
 (891) 2022 07 08
 (731) Stropus Ltd.

7-9 Riga Fereou, Lizantia Court, office 310,
 Agioi Omologites, CY-1087 Nicosia, Cyprus

(540)

ARISEN

(591) Bronze, dark bronze, grey and dark brown
 (531) 27.05.01; 27.05.03; 27.05.04; 29.01.13
 (511)

9 – Recorded and downloadable media files, namely, video files, audio files, image files and text files in the field of gambling, betting, wagering, lotteries, casinos, card games, educational games, games, where the result depends on mastery, skill of the player and ot-

her games of chance, including for arranging tournaments, competitions, game shows, events; downloadable computer software for use as an electronic wallets; interfaces for computers; memory cards for video game machines; integrated circuit cards (smart cards); video game cartridges; computer game software, downloadable; computer game software, recorded; computer programs, downloadable, in the field of gambling, betting, wagering, lotteries, casinos, card games, educational games, games, where the result depends on mastery, skill of the player and other games of chance, including for arranging tournaments, competitions, game shows, events and for providing access to the related content; computer programs, recorded, in the field of gambling, betting, wagering, lotteries, casinos, card games, educational games, games, where the result depends on mastery, skill of the player and other games of chance, including for arranging tournaments, competitions, game shows, events and for providing access to the related content; computer operating programs, recorded, in the field of gambling, betting, wagering, lotteries, casinos, card games, educational games, games, where the result depends on mastery, skill of the player and other games of chance, including for arranging tournaments, competitions, game shows, events and for providing access to the related content; computer software applications, downloadable, in the field of gambling, betting, wagering, lotteries, casinos, card games, educational games, games, where the result depends on mastery, skill of the player and other games of chance, including for arranging tournaments, competitions, game shows, events and for providing access to the related content; computer software platforms, recorded and downloadable, in the field of gambling, betting, wagering, lotteries, casinos, card games, educational games, games, where the result depends on mastery, skill of the player and other games of chance, including for arranging tournaments, competitions, game shows, events and for providing access to the related content; downloadable computer software and computer programs in the field of gambling, betting, wagering, lotteries, casinos, card games, educational games, games, where the result depends on mastery, skill of the player and other games of chance, including for arranging tournaments, competitions, game shows, events; downloadable computer software platforms in the field of gambling, betting, wagering, lotteries, casinos, card games, educational games, games, where the result depends on mastery, skill of the player and other games of chance, including for arranging tournaments, competitions, game shows, events, for use in social networks; downloadable computer software applications in the field of gambling, betting, wagering, lotteries, casinos, card games, educational games, games, where the result depends on mastery, skill of the player and other games of chance, including for arranging tournaments, competitions, game shows, events; downloadable video game software;

downloadable interactive video game software; downloadable computer programs for playing electronic games and computer software platforms downloaded via the Internet, electronic mail or via portable, mobile, handheld or tablet devices, for use in accessing social networks; electronic downloadable publications in the nature of blogs and podcasts, namely, in video, audio and text format in the field of gambling, betting, wagering, lotteries, casinos, card games, educational games, games, where the result depends on mastery, skill of the player and other games of chance, including for arranging tournaments, competitions, game shows, events; electronic downloadable publications in the nature of blogs and podcasts, namely, in video, audio and text format in the field of gambling, betting, wagering, lotteries, casinos, card games, educational games, games, where the result depends on mastery, skill of the player and other games of chance, including for arranging tournaments, competitions, game shows, events, distributed via the Internet, electronic mail or portable, mobile, handheld and tablet devices; recorded or downloadable applications for electronic games; computer software downloadable and recorded for a game engine for developing and using video games; downloadable and recorded computer game software for generating and displaying slot machine betting results; downloadable or recorded computer software for casino games, slot machines and online electronic games; downloadable game software for electronic devices; downloadable sports betting game software; downloadable graphical user interface software; interactive entertainment software for creating, using, managing, monitoring and supervising on-line gaming, betting and gambling portals, contests and tournaments, and for managing customer relationships and customer accounts, used for computers; downloadable computer software used in the provision of entertainment services, namely, in the field of gambling, betting, wagering, lotteries, casinos, card games, educational games, games, where the result depends on mastery, skill of the player and other games of chance; entertainment systems consisting of computer hardware and downloadable game software in the field of gambling, betting, wagering, lotteries, casinos, card games, educational games, games, where the result depends on mastery, skill of the player and other games of chance, including for arranging tournaments, competitions, game shows, events and for providing access to the related content; computer software and computers with multimedia and interactive functions in the field of gambling, betting, wagering, lotteries, casinos, card games, educational games, games, where the result depends on mastery, skill of the player and other games of chance, including for arranging tournaments, competitions, game shows, events and for providing access to the related content; apparatus and devices for recording, transmission, reproduction of sound, data and images in the field of gambling, betting, wagering, lotteries, casinos, card ga-

mes, educational games, games, where the result depends on mastery, skill of the player and other games of chance, including for arranging tournaments, competitions, game shows, events and for providing access to the related content; downloadable computer software and downloadable computer software platform, incorporating a single or multiple computer applications featuring functional and graphical elements for creating, operating, managing, monitoring and supervising on-line gaming, betting and gambling portals, contests and tournaments, and for management of customer relationship and customer accounts; downloadable computer game software and computer software for gambling used for slot machines; downloadable computer game programs and computer programs for gambling, betting, wagering, lotteries, casinos, card games, educational games, games, where the result depends on mastery, skill of the player and other games of chance, for electronic mobile devices and cell phones; downloadable computer game software applications and computer software applications for gambling, betting, wagering, lotteries, casinos, card games, educational games, games, where the result depends on mastery, skill of the player and other games of chance; downloadable computer software, in particular, for gambling, betting, wagering, lotteries, casinos, card games, educational games, games, where the result depends on mastery, skill of the player and other games of chance, for playing via telecommunications networks and the Internet, with or without prizes; electronic virtual reality motion simulators; virtual reality headsets for games; downloadable virtual reality software for simulation while playing video games; virtual reality software for education while playing video games; downloadable virtual and augmented reality software for playing video games; downloadable virtual reality software for telecommunications; downloadable virtual reality game software; electronic number generators in the field of gambling, betting, wagering, lotteries, casinos, card games, educational games, games, where the result depends on mastery, skill of the player and other games of chance, including for arranging tournaments, competitions, game shows, events; downloadable computer operating systems software; recorded computer game programs with sports elements; telecommunication equipment for computer networks and for data transmission in the field of gambling, betting, wagering, lotteries, casinos, card games, educational games, games, where the result depends on mastery, skill of the player and other games of chance, including for arranging tournaments, competitions, game shows, events and for providing access to the related content; computer screen saver software, recorded or downloadable; blank smart cards; magnetically encoded credit cards as overdraft cards; magnetically encoded credit cards as stored value cards; magnetically encoded credit cards as debit cards; magnetically encoded credit cards as stored value cards; magnetically encoded cre-

dit cards as payment cards; magnetically encoded credit cards as prepaid cards; magnetically encoded credit cards as cards with magnetic memory and memory module; encoded electronic chip cards containing data for use in financial applications programs, loyalty programs, incentive programs and benefits for cardholders; protected encoded identity cards; identity cards with encoded protective features; magnetic encoded identity cards with holograms; photographic and cinematographic apparatus and instruments for use in gambling, betting, wagering, lotteries, casinos, card games, educational games, games, where the result depends on mastery, skill of the player and other games of chance, including for arranging tournaments, competitions, game shows, events and for providing access to the related content; downloadable computer game programs for pocket devices.

35 – Advertising for tournaments, competitions, game shows, events in the field of gambling, betting, wagering, lotteries, casinos, card games, educational games, games, where the result depends on mastery, skill of the player and other games of chance; administrative assistance in responding to requests for proposals (RFPs) in the field of gambling, betting, wagering, lotteries, casinos, card games, educational games, games, where the result depends on mastery, skill of the player and other games of chance, including for providing access to the related content; administrative processing of purchase orders in the field of gambling, betting, wagering, lotteries, casinos, card games, educational games, games, where the result depends on mastery, skill of the player and other games of chance, including for providing access to the related content; administration of consumer loyalty programs for tournaments, competitions, game shows, events in the field of gambling, betting, wagering, lotteries, casinos, card games, educational games, games, where the result depends on mastery, skill of the player and other games of chance; negotiation of business contracts for others; market studies in the field of gambling, betting, wagering, lotteries, casinos, card games, educational games, games, where the result depends on mastery, skill of the player and other games of chance, including for providing access to the related content; opinion polling for tournaments, competitions, game shows, events in the field of gambling, betting, wagering, lotteries, casinos, card games, educational games, games, where the result depends on mastery, skill of the player and other games of chance; invoicing for tournaments, competitions, game shows, events in the field of gambling, betting, wagering, lotteries, casinos, card games, educational games, games, where the result depends on mastery, skill of the player and other games of chance; payroll preparation for tournaments, competitions, game shows, events in the field of gambling, betting, wagering, lotteries, casinos, card games, educational games, games, where the result depends on mastery, skill of the player and other games of

chance; demonstration of goods; business inquiries in the field of gambling, betting, wagering, lotteries, casinos, card games, educational games, games, where the result depends on mastery, skill of the player and other games of chance, including for providing access to the related content; business management assistance in the field of gambling, betting, wagering, lotteries, casinos, card games, educational games, games, where the result depends on mastery, skill of the player and other games of chance, including for providing access to the related content; commercial or industrial management assistance in the field of gambling, betting, wagering, lotteries, casinos, card games, educational games, games, where the result depends on mastery, skill of the player and other games of chance, including for providing access to the related content; advisory services for business management; providing user reviews for commercial or advertising purposes in the field of gambling, betting, wagering, lotteries, casinos, card games, educational games, games, where the result depends on mastery, skill of the player and other games of chance, including for providing access to the related content; providing business information via a website in the field of gambling, betting, wagering, lotteries, casinos, card games, educational games, games, where the result depends on mastery, skill of the player and other games of chance, including for providing access to the related content; providing business information in the field of gambling, betting, wagering, lotteries, casinos, card games, educational games, games, where the result depends on mastery, skill of the player and other games of chance, including for providing access to the related content; providing commercial and business contact information; providing commercial information and advice for consumers in the choice of products and services; providing user rankings for commercial or advertising purposes in the field of gambling, betting, wagering, lotteries, casinos, card games, educational games, games, where the result depends on mastery, skill of the player and other games of chance, including for providing access to the related content; compilation of information into computer databases; compilation of statistics; web indexing for commercial or advertising purposes in the field of gambling, betting, wagering, lotteries, casinos, card games, educational games, games, where the result depends on mastery, skill of the player and other games of chance, including for providing access to the related content; business management of sports people; commercial administration of the licensing of the goods and services of others; computerized file management; business management consultancy in the field of gambling, betting, wagering, lotteries, casinos, card games, educational games, games, where the result depends on mastery, skill of the player and other games of chance, including for providing access to the related content; consultancy regarding advertising communication strategies in the field of gam-

bling, betting, wagering, lotteries, casinos, card games, educational games, games, where the result depends on mastery, skill of the player and other games of chance, including for providing access to the related content; consultancy regarding public relations communication strategies in the field of gambling, betting, wagering, lotteries, casinos, card games, educational games, games, where the result depends on mastery, skill of the player and other games of chance, including for providing access to the related content; marketing in the field of gambling, betting, wagering, lotteries, casinos, card games, educational games, games, where the result depends on mastery, skill of the player and other games of chance, including for providing access to the related content; influencer marketing in the field of gambling, betting, wagering, lotteries, casinos, card games, educational games, games, where the result depends on mastery, skill of the player and other games of chance, including for providing access to the related content; marketing in the framework of software publishing in the field of gambling, betting, wagering, lotteries, casinos, card games, educational games, games, where the result depends on mastery, skill of the player and other games of chance, including for providing access to the related content; targeted marketing in the field of gambling, betting, wagering, lotteries, casinos, card games, educational games, games, where the result depends on mastery, skill of the player and other games of chance, including for providing access to the related content; marketing research in the field of gambling, betting, wagering, lotteries, casinos, card games, educational games, games, where the result depends on mastery, skill of the player and other games of chance, including for providing access to the related content; provision of an online marketplace for buyers and sellers of goods and services; writing of publicity texts in the field of gambling, betting, wagering, lotteries, casinos, card games, educational games, games, where the result depends on mastery, skill of the player and other games of chance, including for providing access to the related content; scriptwriting for advertising purposes in the field of gambling, betting, wagering, lotteries, casinos, card games, educational games, games, where the result depends on mastery, skill of the player and other games of chance, including for providing access to the related content; word processing in the field of gambling, betting, wagering, lotteries, casinos, card games, educational games, games, where the result depends on mastery, skill of the player and other games of chance, including for providing access to the related content; updating of advertising material; updating and maintenance of data in computer databases; updating and maintenance of information in registries; organization of exhibitions for commercial or advertising purposes; organizing and conducting various events, campaigns, promotions, media promotions, surveys, contests and presentations for com-

mercial or advertising purposes; rental of advertising space; competitive intelligence services; corporate communications services; layout services for advertising purposes; website traffic optimization; media relations services; business consulting services for digital transformation; lead generation services; advertising agency services; public relations; online retail services for downloadable digital music; online retail services for downloadable ring tones; online retail services for downloadable and pre-recorded music and movies; data search in computer files for others; sponsorship search in the field of gambling, betting, wagering, lotteries, casinos, card games, educational games, games, where the result depends on mastery, skill of the player and other games of chance, including for providing access to the related content; search engine optimization for sales promotion; conducting of commercial events; publicity material rental; rental of advertising time on communication media; rental of vending machines; rental of sales stands; publication of publicity texts; radio advertising in the field of gambling, betting, wagering, lotteries, casinos, card games, educational games, games, where the result depends on mastery, skill of the player and other games of chance, including for providing access to the related content; pay per click advertising in the field of gambling, betting, wagering, lotteries, casinos, card games, educational games, games, where the result depends on mastery, skill of the player and other games of chance, including for providing access to the related content; outdoor advertising in the field of gambling, betting, wagering, lotteries, casinos, card games, educational games, games, where the result depends on mastery, skill of the player and other games of chance, including for providing access to the related content; advertising by mail order in the field of gambling, betting, wagering, lotteries, casinos, card games, educational games, games, where the result depends on mastery, skill of the player and other games of chance, including for providing access to the related content; direct mail advertising in the field of gambling, betting, wagering, lotteries, casinos, card games, educational games, games, where the result depends on mastery, skill of the player and other games of chance, including for providing access to the related content; online advertising on a computer network in the field of gambling, betting, wagering, lotteries, casinos, card games, educational games, games, where the result depends on mastery, skill of the player and other games of chance, including for providing access to the related content; distribution of samples; dissemination of advertising matter; development of advertising concepts; systemization of information into computer databases; compiling indexes of information for commercial or advertising purposes; consumer profiling for commercial or marketing purposes; sales promotion for others; promotion of goods and services through sponsorship of sports events; promotion of goods through influencers; pro-

duction of advertising films; television advertising; telemarketing services; providing consumer information via the Internet webpages and web-sites regarding a variety of goods and advertising information on the list of services provided, enabling consumers to conveniently view, order, purchase these goods and services from the web-pages and web-sites on the Internet as well as to receive the necessary information about these goods and services; the bringing together, for the benefit of others, of a variety of goods, excluding the transport thereof, enabling customers to conveniently view and purchase those goods, at the hypermarkets, department stores, shopping centers; business organization and management in the fields of entertainment services, television entertainment services, sports activities and cultural activities.

38 – Telecommunications services for providing Internet access to services of gambling, betting, wagering, lotteries, casinos, card games, educational games, games, where the result depends on mastery, skill of the player and other games of chance and for providing access to the related content; providing access to databases; providing user access to global computer networks; providing Internet chatrooms in the field of gambling, betting, wagering, lotteries, casinos, card games, educational games, games, where the result depends on mastery, skill of the player and other games of chance, including for providing access to the related content; providing online forums in the field of gambling, betting, wagering, lotteries, casinos, card games, educational games, games, where the result depends on mastery, skill of the player and other games of chance, including for providing access to the related content; video-on-demand transmission; transmission of electronic mail; computer aided transmission of messages and images in the field of gambling, betting, wagering, lotteries, casinos, card games, educational games, games, where the result depends on mastery, skill of the player and other games of chance, including for providing access to the related content; transmission of podcasts; transmission of digital files in the field of gambling, betting, wagering, lotteries, casinos, card games, educational games, games, where the result depends on mastery, skill of the player and other games of chance, including for providing access to the related content; message sending in the field of gambling, betting, wagering, lotteries, casinos, card games, educational games, games, where the result depends on mastery, skill of the player and other games of chance, including for providing access to the related content via a website; electronic bulletin board services as telecommunications services in the field of gambling, betting, wagering, lotteries, casinos, card games, educational games, games, where the result depends on mastery, skill of the player and other games of chance, including for providing access to the related content; data streaming; rental of access time to global computer networks; wireless broadcasting; providing access to

databases featuring information content of websites and portals as communication services; audio, video and multimedia broadcasting via the Internet and other communication networks; electronic transmission of data by computers in the field of gambling, betting, wagering, lotteries, casinos, card games, educational games, games, where the result depends on mastery, skill of the player and other games of chance, including for providing access to the related content; consulting services in the field of communications services, namely, electronic transmission of data and documents among users of computers via communication networks; wireless broadband communication services using computer networks in the field of gambling, betting, wagering, lotteries, casinos, card games, educational games, games, where the result depends on mastery, skill of the player and other games of chance, including for providing access to the related content; data transmission by electronic means; electronic transmission of data by video broadcasting services; electronic data transmission, including audiovisual data, via a global computer network or the Internet; electronic communication services by electronic computer terminals in the field of gambling, betting, wagering, lotteries, casinos, card games, educational games, games, where the result depends on mastery, skill of the player and other games of chance, including for providing access to the related content; data transmission via electronic communication in the field of gambling, betting, wagering, lotteries, casinos, card games, educational games, games, where the result depends on mastery, skill of the player and other games of chance, including for providing access to the related content; electronic data exchange, namely, exchange of data stored in databases accessible via telecommunication networks in the field of gambling, betting, wagering, lotteries, casinos, card games, educational games, games, where the result depends on mastery, skill of the player and other games of chance, including for providing access to the related content; electronic messaging services in the field of gambling, betting, wagering, lotteries, casinos, card games, educational games, games, where the result depends on mastery, skill of the player and other games of chance, including for providing access to the related content; electronic messaging services via computers in the field of gambling, betting, wagering, lotteries, casinos, card games, educational games, games, where the result depends on mastery, skill of the player and other games of chance, including for providing access to the related content; rental of access time to computer databases; video and audio material streaming services on the Internet; electronic transmission and dissemination of data, including information, via computer networks and the Internet in the field of gambling, betting, wagering, lotteries, casinos, card games, educational games, games, where the result depends on mastery, skill of the player and other games of chance, including for providing

access to the related content; electronic transmission of data, audio, video and multimedia files, including transmission of downloadable files and files transmitted over a global computer network; transmission of information in real time; transmission (routing) of audio, images and digital signals.

41 – Videotaping for tournaments, competitions, game shows, events in the field of gambling, betting, wagering, lotteries, casinos, card games, educational games, games, where the result depends on mastery, skill of the player and other games of chance; booking of seats for shows; sound engineering services for tournaments, competitions, game shows, events in the field of gambling, betting, wagering, lotteries, casinos, card games, educational games, games, where the result depends on mastery, skill of the player and other games of chance; organization of tournaments, competitions, game shows, events in the field of gambling, betting, wagering, lotteries, casinos, card games, educational games, games, where the result depends on mastery, skill of the player and other games of chance; party planning as entertainment; video editing services for tournaments, competitions, game shows, events in the field of gambling, betting, wagering, lotteries, casinos, card games, educational games, games, where the result depends on mastery, skill of the player and other games of chance; lighting technician services for tournaments, competitions, game shows, events in the field of gambling, betting, wagering, lotteries, casinos, card games, educational games, games, where the result depends on mastery, skill of the player and other games of chance; music composition services for tournaments, competitions, game shows, events in the field of gambling, betting, wagering, lotteries, casinos, card games, educational games, games, where the result depends on mastery, skill of the player and other games of chance; film directing, other than advertising films, in the field of gambling, betting, wagering, lotteries, casinos, card games, educational games, games, where the result depends on mastery, skill of the player and other games of chance, including for providing access to the related content; production of tournaments, competitions, game shows, events in the field of gambling, betting, wagering, lotteries, casinos, card games, educational games, games, where the result depends on mastery, skill of the player and other games of chance; film production, other than advertising films, in the field of gambling, betting, wagering, lotteries, casinos, card games, educational games, games, where the result depends on mastery, skill of the player and other games of chance, including for providing access to the related content; scriptwriting, other than for advertising purposes, for arranging tournaments, competitions, game shows, events in the field of gambling, betting, wagering, lotteries, casinos, card games, educational games, games, where the result depends on mastery, skill of the player and other games of chance; presentation of live performances for to-

urnaments, competitions, game shows, events in the field of gambling, betting, wagering, lotteries, casinos, card games, educational games, games, where the result depends on mastery, skill of the player and other games of chance; rental of audio equipment for tournaments, competitions, game shows, events in the field of gambling, betting, wagering, lotteries, casinos, card games, educational games, games, where the result depends on mastery, skill of the player and other games of chance; rental of show scenery for tournaments, competitions, game shows, events in the field of gambling, betting, wagering, lotteries, casinos, card games, educational games, games, where the result depends on mastery, skill of the player and other games of chance; rental of sports equipment, except vehicles, for tournaments, competitions, game shows, events in the field of gambling, betting, wagering, lotteries, casinos, card games, educational games, games, where the result depends on mastery, skill of the player and other games of chance; online publication of electronic books and journals, in the field of gambling, betting, wagering, lotteries, casinos, card games, educational games, games, where the result depends on mastery, skill of the player and other games of chance, including for providing access to the related content; publication of texts, other than publicity texts, in the field of gambling, betting, wagering, lotteries, casinos, card games, educational games, games, where the result depends on mastery, skill of the player and other games of chance, including for providing access to the related content; electronic desktop publishing; providing user reviews for entertainment or cultural purposes; providing information in the field of entertainment; providing online videos in the field of gambling, betting, wagering, lotteries, casinos, card games, educational games, games, where the result depends on mastery, skill of the player and other games of chance, non-downloadable; providing sports facilities; practical training as demonstration in the field of gambling, betting, wagering, lotteries, casinos, card games, educational games, games, where the result depends on mastery, skill of the player and other games of chance; training services in the field of gambling, betting, wagering, lotteries, casinos, card games, educational games, games, where the result depends on mastery, skill of the player and other games of chance, provided via simulators; games equipment rental; rental of sports training simulators; providing casino facilities for the services of gambling, betting, wagering, lotteries, card games, educational games, games, where the result depends on mastery, skill of the player and other games of chance; gambling services; electronic game services provided online from a computer network; providing amusement arcade services; providing information in the field of gambling, betting, wagering, lotteries, casinos, card games, educational games, games, where the result depends on mastery, skill of the

player and other games of chance, including for providing access to the related content; organization of competitions in the field of gambling, betting, wagering, lotteries, casinos, card games, educational games, games, where the result depends on mastery, skill of the player and other games of chance, including for providing access to the related content live or via television, or online via computer databases, or via the Internet, or via portable, mobile, handheld or tablet devices; organization of lotteries, including live or via television, or online via computer databases, or via the Internet, or via portable, mobile, handheld or tablet devices; organization of sports competitions, including live or via television, or online via computer databases, or via the Internet, or via portable, mobile, handheld or tablet devices; layout services, other than for advertising purposes; online gambling services provided via a computer network; virtual reality gaming services provided online from a computer network; providing online and offline gaming services for accepting bets; providing online and offline card game services; providing online and offline poker game services; providing online and offline game services, where the result depends on the mastery, skill of the player; providing online and offline game services for the control of entertainment games, in the field of gambling, betting, wagering, lotteries, casinos, card games, educational games, games, where the result depends on mastery, skill of the player and other games of chance, including for tournaments, competitions, game shows, events and for providing access to the related content; arranging, conducting and presenting, other than for commercial or advertising purposes, of tournaments, competitions, game shows, and other entertainment events in the field of gambling, betting, wagering, lotteries, casinos, card games, educational games, games, where the result depends on mastery, skill of the player and other games of chance, live or via television, or online via computer databases, or via the Internet, or via portable, mobile, handheld or tablet devices; multiplayer card game services provided live or via television, or online via computer databases, or via the Internet, or via portable, mobile, handheld or tablet devices; organization and conducting entertainment presentations; providing the aforesaid services online via computer databases, or via the Internet, or via portable, mobile, handheld or tablet devices; providing online game services for electronic games provided via the Internet; providing online and offline card game services for several participants.

42 – Computer system analysis in the field of gambling, betting, wagering, lotteries, casinos, card games, educational games, games, where the result depends on mastery, skill of the player and other games of chance; off-site data backup in the field of gambling, betting, wagering, lotteries, casinos, card games, educational games, games, where the result depends on mastery, skill of the player and other games

of chance; research and development of new products for others in the field of gambling, betting, wagering, lotteries, casinos, card games, educational games, games, where the result depends on mastery, skill of the player and other games of chance, including for tournaments, competitions, game shows, events and for providing access to the related content; duplication of computer programs; electronic data storage; electronic monitoring of personally identifying information to detect identity theft via the Internet; providing information relating to computer technology and programming via a website; installation of a computer software; information technology services provided on an outsourcing basis; computer programming; conversion of computer programs and data, other than physical conversion; computer technology consultancy; telecommunications technology consultancy; Internet security consultancy; data security consultancy; information technology (IT) consultancy; computer software consultancy; computer security consultancy; consultancy in the design of websites in the field of gambling, betting, wagering, lotteries, casinos, card games, educational games, games, where the result depends on mastery, skill of the player and other games of chance; monitoring of computer systems for detecting unauthorized access or data breach; monitoring of computer systems to detect breakdowns; monitoring of computer systems by remote access to detect breakdowns; maintenance of computer software; updating of computer software; platform as a service (PaaS) featuring computer software platforms for use in database management; user authentication services using technology for e-commerce transactions; user authentication services using single sign-on technology for online software applications; hosting computer web sites; data encryption services; computer system design; rental of web servers; computer rental; rental of computer software; development of computer platforms in the field of gambling, betting, wagering, lotteries, casinos, card games, educational games, games, where the result depends on mastery, skill of the player and other games of chance; software development in the framework of software publishing in the field of gambling, betting, wagering, lotteries, casinos, card games, educational games, games, where the result depends on mastery, skill of the player and other games of chance; creating and maintaining websites for others in the field of gambling, betting, wagering, lotteries, casinos, card games, educational games, games, where the result depends on mastery, skill of the player and other games of chance; creating and designing website-based indexes of information for others using information technology services in the field of gambling, betting, wagering, lotteries, casinos, card games, educational games, games, where the result depends on mastery, skill of the player and other games of chance; cloud computing featuring software for use in database management; server hosting; computer system administration of

user accounts in computer networks; computer-aided videographic design; development of software in accordance with the individual needs of the client in the field of gambling, betting, wagering, lotteries, casinos, card games, educational games, games, where the result depends on mastery, skill of the player and other games of chance; technical data analysis; development of interactive multimedia software; development of software for data conversion and conversion of multimedia content into various protocols; design and development of software for gambling, betting, wagering, lotteries, casinos, card games, educational games, games, where the result depends on mastery, skill of the player and other games of chance, including for virtual reality; leasing of computer hardware; software development of Internet platforms in the field of gambling, betting, wagering, lotteries, casinos, card games, educational games, games, where the result depends on mastery, skill of the player and other games of chance; development and design of computer software for video games; testing of computer hardware and software; providing temporary use of online non-downloadable software for access and operation in cloud computing environments; software as a service (SaaS), namely, a web platform that provides software for viewing, detecting, searching, configuring content, managing and exploring content in the field of gambling, betting, wagering, lotteries, casinos, card games, educational games, games, where the result depends on mastery, skill of the player and other games of chance; providing temporary use of non-downloadable computer software for computer games and gambling; providing temporary use of non-downloadable game software; research, development and design of computer software for a computer platform that includes one or more applications that contain functional and graphical elements in the field of gambling, betting, wagering, lotteries, casinos, card games, educational games, games, where the result depends on mastery, skill of the player and other games of chance; application service providers (ASP), namely, hosting computer software applications of others for creating, using, managing, monitoring and supervising online gaming and gambling portals, contests and tournaments, and for managing customer relationships and customer accounts; providing temporary use of non-downloadable software for creating, using, managing, monitoring and supervising on-line gaming, betting and gambling portals, contests and tournaments, and for management of customer relationship and customer accounts.

(260) AM 2023 120403 A
 (800) 1696242
 (151) 2022 09 01
 (891) 2022 09 01
 (731) Noblewood Limited
 Arch. Makariou III, 206, Chrysalia

Court, 5TH Floor, CY-3030 Limassol, Cyprus
 (540)



(591) Black, white
 (531) 03.09.18; 25.01.15; 25.05.01; 27.05.02;
 27.05.19
 (511)
 33 – Gin.

(260) AM 2023 120404 A
 (800) 1696253
 (151) 2022 02 06
 (891) 2022 02 06
 (731) Dsm Grup Danışmanlık İletişim Ve
 Satış Ticaret A.Ş.
 Maslak Mahallesi Büyükdere Caddesi, (Spine
 Plaza) No:243, İç Kapı No:19 Sarıyer, İstanbul,
 Türkiye

(540)
Trendyolmilla Glam

(591) Black, white
 (531) 27.05.01
 (511)
 3 – Adhesives for cosmetic purposes; after-shave lotions; air fragrance reed diffusers; air fragrancing preparations; antiperspirant soap; antiperspirants [toilettries]; antistatic preparations for household purposes; aromatics [essential oils]; astringents for cosmetic purposes; baby wipes impregnated with cleaning preparations; balms, other than for medical purposes; bath preparations, not for medical purposes; bath salts, not for medical purposes; beard dyes; beauty masks; bleaching preparations [decolorants] for cosmetic purposes; bleaching preparations [decolorants] for household purposes; body glitter; body paint for cosmetic purposes; breath freshening preparations for personal hygiene; cake flavourings [essential oils]; chemical cleaning preparations for household purposes; cleaning chalk; cleaning preparations; cloths impregnated with a detergent for cleaning; colorants for toilet purposes; colour-brightening chemicals for household purposes [laundry]; colour-removing preparations; colour run prevention laundry sheets; cosmetic dyes; cosmetic creams; cosmetic kits; cosmetic pencils; cosmetic preparations for baths; cosmetic preparations for eyelashes; cosmetic preparations for skin care; cosmetic preparations for slimming purposes; cosmetics; cosmetics for animals; cosmetics for children; cotton swabs for cosmetic purposes; cotton wool for cosmetic purposes; cotton wool impregnated with

make-up removing preparations; creams for leather; decorative transfers for cosmetic purposes; degreasers, other than for use in manufacturing processes; dental bleaching gels; dentifrices; denture polishes; deodorants for human beings or for animals; depilatory preparations; depilatory wax; detergents, other than for use in manufacturing operations and for medical purposes; douching preparations for personal sanitary or deodorant purposes [toiletries]; dry-cleaning preparations; dry shampoos; eau de Cologne; emery cloth; emery paper; essential oils; eyebrow cosmetics; eyebrow pencils; eye-washes, not for medical purposes; fabric softeners for laundry use; false eyelashes; false nails; flavourings for beverages [essential oils]; floor wax; floor wax removers [scouring preparations]; food flavourings [essential oils]; fumigation preparations [perfumes]; gel eye patches for cosmetic purposes; grinding preparations; hair conditioners; hair dyes; hair lotions; hair spray; hair straightening preparations; hair waving preparations; henna [cosmetic dye]; herbal extracts for cosmetic purposes; hydrogen peroxide for cosmetic purposes; incense; laundry preparations; lip glosses; lipstick cases; lipsticks; lotions for cosmetic purposes; make-up; make-up powder; make-up preparations; make-up removing preparations; mascara; massage candles for cosmetic purposes; massage gels, other than for medical purposes; micellar water; moustache wax; mouthwashes, not for medical purposes; nail art stickers; nail care preparations; nail glitter; nail varnish; nail varnish removers; oils for perfumes and scents; paint stripping preparations; perfumery; perfumes; petroleum jelly for cosmetic purposes; polish for furniture and flooring; polishing creams; polishing paper; polishing preparations; polishing rouge; polishing stones; polishing wax; potpourris [fragrances]; pomades for cosmetic purposes; preparations for cleaning dentures; preparations for unblocking drain pipes; pumice stone; sandpaper; scented water; scented wood; scouring solutions; shampoos; shampoos for animals [non-medicated grooming preparations]; shampoos for pets [non-medicated grooming preparations]; shaving preparations; shaving soap; shaving stones [astringents]; shoe cream; shoe polish; shoe wax; skin whitening creams; smoothing preparations [starching]; soaps; soap for brightening textile; soap for foot perspiration; stain removers; starch glaze for laundry purposes; talcum powder, for toilet use; tissues impregnated with cosmetic lotions; tissues impregnated with make-up removing preparations; toiletry preparations; toilet water; toothpaste; washing soda, for cleaning.

18 – Goods made of leather, imitations of leather or other materials namely key holders being key cases, wallets, purses, bags, straps, boxes, key cases, trunks [luggage], suitcases; umbrellas, parasols, walking sticks; carrying bags; sports bags; backpacks; backpacks for carrying infants; bags [envelopes, pouches] of leather, for packaging; bags for campers; bags for carrying animals; bags for carrying pets; bags for

climbers; beach bags; belt pouches; briefcases; cases of leather or leatherboard; clothing for pets; coin pouches; collars for animals; cosmetic bags sold empty; cosmetic cases, empty; costumes for animals; covers for animals; credit card cases and holders [leatherware]; document cases; garment bags for travel; harness fittings; harness for animals; harness straps; hiking sticks; labels of leather; luggage tags; saddlery; slings for carrying infants.

25 – Clothing, footwear and headwear for human beings namely clothing; outer clothing; waterproof clothing; overalls; overcoats; paper clothing; parkas; pelerines; pelisses; petticoats; pockets for clothing; ponchos; rash guards; ready-made clothing; shirt fronts; shirts; shirt yokes; short-sleeve shirts; coats; collars [clothing]; combinations [clothing]; suits; dresses; dressing gowns; dress shields; sweaters; aprons [clothing]; jackets [clothing]; clothing of imitations of leather; clothing of leather; liveries; maniples; mantillas; masquerade costumes; leggings [leg warmers]; leggings [trousers]; leotards; tee-shirts; tights; trousers; trouser straps; uniforms; vests, babies' pants [underwear]; bibs, not of paper; layettes [clothing]; bathing caps; bathing suits; bathing trunks; bath robes; bath sandals; bath slippers; beach clothes; beach shoes; wet suits for water-skiing; cyclists' clothing jackets [clothing]; jerseys [clothing]; judo uniforms; jumper dresses; karate uniforms; kimonos; knitwear [clothing]; fishing vests; furs [clothing]; fur stoles; clothing containing slimming substances; clothing for gymnastics; clothing incorporating LEDs; motorists' clothing; belts [clothing]; money belts [clothing]; headwear; berets; caps being headwear; hats; headbands [clothing]; headscarves; hoods [clothing]; visors being headwear; ear muffs [clothing]; cuffs; detachable collars; gloves [clothing]; mittens; muffs [clothing]; neck gaiters; neckties; paper hats [clothing]; shower caps; ready-made linings [parts of clothing]; saris; sarongs; sashes for wear; scarfs; shawls; veils [clothing]; togas; turbans; bandanas [neckerchiefs]; ascots; bodices [lingerie]; camisoles; corselets; corsets [underclothing]; garters; girdles; boxer shorts; braces for clothing [suspenders]; gaiters; pyjamas; panties; brasieres; underpants; underwear; sweat-absorbent underwear; hosiery; stockings; stocking suspenders; footwear; shoes; footwear uppers; boots; boots for sports; boot uppers; sandals; football boots; foot muffs, not electrically heated; gymnastic shoes; half-boots; heelpieces for footwear; heelpieces for stockings; heel protectors for shoes; heels; inner soles; galoshes; breeches for wear; non-slipping devices for footwear; ski boots; ski gloves; skirts; shorts; skull caps; sleep masks; slippers; slips [underclothing]; socks; sock suspenders; soles for footwear; sports jerseys; sports shoes; sports singlets.

35 – Advertising; business management; business administration; office functions; organization, operation and supervision of loyalty and incentive schemes;

advertising services provided via the Internet; production of television and radio advertisements; accountancy; auctioneering; trade fairs; opinion polling; data processing; provision of business information; advertising agency services; advertising services provided for others; database management; compilation of information into computer databases; business consulting services; business consulting services in the field of web based events, conferences, training programs, learning programs, and seminars; business consulting services in the field of delivering web-based knowledge; business consulting services in the field of online collaboration and collaboration technologies; business consulting services in the fields of sales and marketing; business project management services; business project management services relating to development, set up, staging, production, recording, monitoring and follow-up for web based events, conferences, training programs, learning programs, and seminars; market research and business consulting services; business consultancy services relating to facilitating the transaction of business via local and global computer networks by locating and providing referrals for the delivery of a wide variety of business and consumer products and services; dissemination of business information of goods and services of others via local and global computer networks; business consultancy services relating to providing a web site on a global computer network by which third parties can offer and source goods and services, place, determine the status of and fulfil trade leads and orders, enter into contracts and transact business; providing computerized online ordering services; advertising of goods and services of others via local and global computer networks; international import and export agency services; rental of advertising space on communication media; online trading services relating to electronic auctioneering and providing online business evaluation relating thereto; providing a directory of third party web sites to facilitate business transactions; business consultancy services relating to operating an electronic marketplace for the buyers and sellers of goods and/or services on a global computer network; business assistance relating to facilitating business transaction via local and global computer networks; corporate management consultancy services; marketing and promotion services; publication of publicity materials; marketing of vacant premises; dissemination of advertising materials, updating of advertising materials, compilation of advertisements for use as web pages on the Internet; rental of advertising space; computer data processing; sales, business and promotional information services; telephone answering (for unavailable subscribers); telephone answering (for others); auctioneering provided on the Internet; personnel management; provision of sales, business, advertising and promotional information through a global computer network and via the Internet; presentation of goods on communication media

for retail purposes; retail and wholesale of cosmetics, perfumery, toiletries, dentifrices, soaps, detergents, deodorants for personal use and household use, bleaching and cleaning preparations, dental care preparations, dentifrices, mouth washes, polishing preparations, candles, wax, pharmaceuticals, veterinary and medical preparations, disinfectants, dietary supplements, baby food, herbs and herbal beverages, sanitary preparations, sanitary diapers, sanitary pads, goods and materials of common metal used for storage, wrapping, packaging and sheltering purposes, containers of metal (storage, transport), metal boxes, packaging containers of metal, aluminium foil, storage containers of metal, metal containers for the transportation of goods, ladders of metal, ironmongery, small hardware of metal, safes of metal, machines, machine tools and industrial robots for processing and shaping wood, metals, glass, plastics and minerals, 3D printers, electric kitchen machines for chopping, grinding, crushing, mixing and mincing foodstuff, washing machines, laundry washing machines, dishwashers, spin driers (not heated), electric cleaning machines for cleaning floors, carpets or floorings, vacuum cleaners and parts thereof, forks, spoons, knives and non-electric cutters, slicers, peelers for kitchen use, including those made of precious metals, tools and apparatus for personal beauty care use: tools and apparatus for shaving, epilation, manicure and pedicure, electric hand implements for straightening and curling hair, scissors, handoperated hand tools for the repair of machines, apparatus and vehicles and for use in construction, agriculture, horticulture and forestry, electric or non-electric irons, steam irons, thermometers, microscopes, magnifying glasses, apparatus for recording, transmission or reproduction of sound or images, cameras, photographic cameras, television apparatus, video recorders, CD and DVD players and recorders, MP3 players, computers, desktop computers, tablet computers, microphones, loudspeakers, earphones, telecommunications apparatus, apparatus for the reproduction of sound or images, computer peripheral devices, cell phones, covers for cell phones, telephone apparatus, computer printers, scanners as data processing equipment, photocopiers, magnetic and optic data carriers and computer software and programmes recorded thereto, downloadable and recordable electronic publications, encoded magnetic and optic cards, photocells, optical sensors, counters, clothing for protection against accidents, irradiation and fire, safety vests and life-saving apparatus and equipment, eyeglasses, sunglasses, optical lenses and cases, containers, parts and components thereof, decorative magnets, metronomes, medical orthopaedic articles, corsets for medical purposes, orthopaedic shoes, elastic bandages and supportive bandages, condoms, babies' bottles, babies' pacifiers, teats, teeters for babies, lighting installations, hair driers, hand drying apparatus, water softening apparatus, electric bed warmers and electric blankets, not for medical use, electric pillow

warmers, electric or nonelectric foot warmers, hot water bottles, pasteurizers and sterilizers, motorcycles, mopeds, vehicle seats, head-rests for vehicle seats, safety seats for children, for vehicles, seat covers for vehicles, vehicle covers, sun-blinds adapted for vehicles, wipers for vehicles, baby carriages, wheelchairs, pushchairs, shopping carts, shopping trolleys, fireworks, sprays for personal defence, jewellery, watches, statuettes and figurines of precious metal, clocks, watches, parts thereof, chronometers, music instruments, their cases, paper and cardboard, paper and cardboard for packaging and wrapping purposes, cardboard boxes, paper towels, toilet paper, paper napkins, plastic materials for packaging and wrapping purposes, printed publications, printed matter, books, magazines, newspapers, bill books, printed dispatch notes, printed vouchers, calendars, posters, photographs [printed], paintings, stickers [stationery], postage stamps, stationery, office stationery, instructional and teaching material [except furniture and apparatus], writing and drawing implements, artists' materials, paper products for stationery purposes, adhesives for stationery purposes, pens, pencils, erasers, adhesive tapes for stationery purposes, cardboard cartons [artists' materials], writing paper, copying paper, paper rolls for cash registers, drawing materials, chalkboards, painting pencils, watercolours [paintings], stationery, instructional and teaching material, writing and drawing implements, artists' materials, paper products for stationery purposes, adhesives for stationery purposes, pens, pencils, erasers, adhesive tapes for stationery purposes, cardboard cartons [artists' materials], writing paper, copying paper, paper rolls for cash registers, drawing materials, chalkboards, painting pencils, watercolours [paintings], paint roller, paint brushes, rosaries, goods made of leather, imitations of leather or other materials designed for carrying items, bags, wallets, straps, boxes and trunks made of leather or stout leather, key cases, trunks [luggage], suitcases, umbrellas, parasols, walking sticks, monuments and statuettes of stone, concrete and marble, furniture, mattresses, pillows, air mattresses and cushions, sleeping bags for camping, water beds, mirrors, bouncing chairs for babies, playpens for babies, cradles, infant walkers, display boards, frames for pictures and paintings, identification plates, identification tags, nameplates, identification labels made of wood or synthetic materials, packaging containers of wood or plastics, storage containers, chests, ornaments and decorative goods of wood, cork, reed, cane, wicker, horn, bone, ivory, whalebone, shell, amber, mother-of-pearl, meerscham, beeswax, plastic or plaster, figurines, holiday ornaments for walls and sculptures, baskets, kennels, nesting boxes and beds for household pets, cages for household pets, indoor aquariums, vivarium and indoor terrariums for animals and plant cultivation, bamboo curtains, roller indoor blinds [for interiors], slatted indoor blinds, strip curtains, bead curtains for decoration, curtain hooks, curtain rings, curtain tie-

backs, curtain rods, hand-operated non-electric cleaning instruments and appliances, brushes, other than paintbrushes, sponges for cleaning, steel wool for cleaning, cloths of textile for cleaning, gloves for dishwashing, non-electric polishing machines for household purposes, brooms for carpets, mops, tooth brushes, shaving brushes, hair brushes, non-electric household or kitchen utensils, service dishes, pots and pans, bottle openers, flower pots, drinking straws, non-electric cooking utensils, ironing boards and shaped covers therefor, drying racks for washing, clothes drying hangers, ornaments and decorative goods of glass, porcelain, earthenware or clay, statues, figurines and vases, perfume burners, perfume sprayers, perfume vaporizers, electric or non-electric make-up removing appliances, powder puffs, toilet cases, plant watering devices and containers, ropes, strings, hammocks, tents, bags of textile, yarns, threads, textile goods for household use, curtains, bed covers, sheets (textile), pillowcases, blankets, quilts, towels, flags, labels, blankets, clothing, headgear, footwear, swimwear, scarves, hats, caps, Laces and embroidery, guipures, festoons, ribbons (haberdashery), ribbons and braid, fastening tapes for clothing, cords for clothing, letters and numerals for marking linen, embroidered emblems, badges for wear, not of precious metal, shoulder pads for clothing, buttons for clothing, fasteners for clothing, eyelets for clothing, zippers, buckles for shoes and belts, fasteners, shoe and belt buckles, pins, other than jewellery, adhesive patches for decoration of textile articles, laces, needles, sewing needles, needles for sewing machines, needles for knitting and embroidery, boxes for needles, needle cushions, artificial flowers, artificial fruits, hair pins, hair buckles, hair bands, decorative articles for the hair, wigs, hair extensions, electric or non-electric hair curlers, carpets, rugs, mats, wallpaper, wall hangings, games, toys, gymnastic and sporting articles, fishing tackle, artificial fishing bait, decoys for hunting and fishing, Christmas trees of artificial material, ornaments for Christmas trees, artificial snow, rattles (playthings), novelties for parties, paper party hats, foodstuff, beverages, matches, tobacco and tobacco products enabling customers to conveniently view and purchase those goods, such services may be provided by retail stores, wholesale outlets, through vending machines, mail order catalogues or by means of electronic media, for example, through web sites or television shopping programmes.

(260) AM 2023 120405 A
 (800) 1696254
 (151) 2022 02 06
 (891) 2022 02 06
 (731) Dsm Grup Danışmanlık İletişim Ve Satış
 Ticaret A.Ş.
 Maslak Mahallesi Büyükdere Caddesi,

(Spine Plaza) No:243, İç Kapı No:19 Sarıyer,
İstanbul, Türkiye

(540)

Trendyol Man

(591) Black, white

(531) 27.05.01

(511)

3 – Adhesives for cosmetic purposes; after-shave lotions; air fragrance reed diffusers; air fragrancing preparations; antiperspirant soap; antiperspirants [toiletries]; antistatic preparations for household purposes; aromatics [essential oils]; astringents for cosmetic purposes; baby wipes impregnated with cleaning preparations; balms, other than for medical purposes; bath preparations, not for medical purposes; bath salts, not for medical purposes; beard dyes; beauty masks; bleaching preparations [decolorants] for cosmetic purposes; bleaching preparations [decolorants] for household purposes; body glitter; body paint for cosmetic purposes; breath freshening preparations for personal hygiene; cake flavourings [essential oils]; chemical cleaning preparations for household purposes; cleaning chalk; cleaning preparations; cloths impregnated with a detergent for cleaning; colorants for toilet purposes; colour-brightening chemicals for household purposes [laundry]; colour-removing preparations; colour run prevention laundry sheets; cosmetic dyes; cosmetic creams; cosmetic kits; cosmetic pencils; cosmetic preparations for baths; cosmetic preparations for eyelashes; cosmetic preparations for skin care; cosmetic preparations for slimming purposes; cosmetics; cosmetics for animals; cosmetics for children; cotton swabs for cosmetic purposes; cotton wool for cosmetic purposes; cotton wool impregnated with make-up removing preparations; creams for leather; decorative transfers for cosmetic purposes; degreasers, other than for use in manufacturing processes; dental bleaching gels; dentifrices; denture polishes; deodorants for human beings or for animals; depilatory preparations; depilatory wax; detergents, other than for use in manufacturing operations and for medical purposes; douching preparations for personal sanitary or deodorant purposes [toiletries]; dry-cleaning preparations; dry shampoos; eau de Cologne; emery cloth; emery paper; essential oils; eyebrow cosmetics; eyebrow pencils; eye-washes, not for medical purposes; fabric softeners for laundry use; false eyelashes; false nails; flavourings for beverages [essential oils]; floor wax; floor wax removers [scouring preparations]; food flavourings [essential oils]; fumigation preparations [perfumes]; gel eye patches for cosmetic purposes; grinding preparations; hair conditioners; hair dyes; hair lotions; hair spray; hair straightening preparations; hair waving preparations; henna [cosmetic dye]; herbal extracts for cosmetic purposes; hydrogen peroxide for cosmetic purposes; incense; laundry preparations; lip glosses; lipstick cases; lipsticks; lotions for cosmetic purposes; make-up; make-up po-

uder; make-up preparations; make-up removing preparations; mascara; massage candles for cosmetic purposes; massage gels, other than for medical purposes; micellar water; moustache wax; mouthwashes, not for medical purposes; nail art stickers; nail care preparations; nail glitter; nail varnish; nail varnish removers; oils for perfumes and scents; paint stripping preparations; perfumery; perfumes; petroleum jelly for cosmetic purposes; polish for furniture and flooring; polishing creams; polishing paper; polishing preparations; polishing rouge; polishing stones; polishing wax; potpourris [fragrances]; pomades for cosmetic purposes; preparations for cleaning dentures; preparations for unblocking drain pipes; pumice stone; sandpaper; scented water; scented wood; scouring solutions; shampoos; shampoos for animals [non-medicated grooming preparations]; shampoos for pets [non-medicated grooming preparations]; shaving preparations; shaving soap; shaving stones [astringents]; shoe cream; shoe polish; shoe wax; skin whitening creams; smoothing preparations [starching]; soaps; soap for brightening textile; soap for foot perspiration; stain removers; starch glaze for laundry purposes; talcum powder, for toilet use; tissues impregnated with cosmetic lotions; tissues impregnated with make-up removing preparations; toiletry preparations; toilet water; toothpaste; washing soda, for cleaning.

14 – Alarm clocks; alloys of precious metal; amulets [jewellery]; bracelets [jewellery]; boxes of precious metal; bracelets made of embroidered textile [jewellery]; brooches [jewellery]; busts of precious metal; chains [jewellery]; charms for key rings; chronographs [watches]; chronometers; chronometric instruments; chronoscopes; clasps for jewellery; clock cases; clock hands; clocks; clocks and watches, electric; clockworks; coins; control clocks [master clocks]; copper tokens; cuff links; crucifixes as jewellery; diamonds; earrings; figurines of precious metal; gold thread [jewellery]; gold, unwrought or beaten; hat jewellery; ingots of precious metals; jewellery; jewellery boxes; jewellery charms; jewellery hat pins; key rings [split rings with trinket or decorative fob]; medals; misbaha [prayer beads]; necklaces [jewellery]; ornamental pins; pearls [jewellery]; pins [jewellery]; precious metals, unwrought or semi-wrought; precious stones; presentation boxes for jewellery; presentation boxes for watches; retractable key rings; rings [jewellery]; ruthenium; silver, unwrought or beaten; silver thread [jewellery]; stopwatches; statues of precious metal; threads of precious metal [jewellery]; tie clips; tie pins; watch bands; watch chains; watches; watch glasses; watch hands; watch springs; works of art of precious metal; wristwatches.

18 – Goods made of leather, imitations of leather or other materials namely key holders being key cases, wallets, purses, bags, straps, boxes, key cases, trunks [luggage], suitcases; umbrellas, parasols, walking sticks; carrying bags; sports bags; backpacks; back-

packs for carrying infants; bags [envelopes, pouches] of leather, for packaging; bags for campers; bags for carrying animals; bags for carrying pets; bags for climbers; beach bags; belt pouches; briefcases; cases of leather or leatherboard; clothing for pets; coin pouches; collars for animals; cosmetic bags sold empty; cosmetic cases, empty; costumes for animals; covers for animals; credit card cases and holders [leatherware]; document cases; garment bags for travel; harness fittings; harness for animals; harness straps; hiking sticks; labels of leather; luggage tags; saddlery; slings for carrying infants.

25 – Clothing, footwear and headwear for human beings namely clothing; outer clothing; waterproof clothing; overalls; overcoats; paper clothing; parkas; pelerines; pelisses; petticoats; pockets for clothing; ponchos; rash guards; ready-made clothing; shirt fronts; shirts; shirt yokes; short-sleeve shirts; coats; collars [clothing]; combinations [clothing]; suits; dresses; dressing gowns; dress shields; sweaters; aprons [clothing]; jackets [clothing]; clothing of imitations of leather; clothing of leather; liveries; maniples; mantillas; masquerade costumes; leggings [leg warmers]; leggings [trousers]; leotards; tee-shirts; tights; trousers; trouser straps; uniforms; vests, babies' pants [underwear]; bibs, not of paper; layettes [clothing]; bathing caps; bathing suits; bathing trunks; bath robes; bath sandals; bath slippers; beach clothes; beach shoes; wet suits for water-skiing; cyclists' clothing jackets [clothing]; jerseys [clothing]; judo uniforms; jumper dresses; karate uniforms; kimonos; knitwear [clothing]; fishing vests; furs [clothing]; fur stoles; clothing containing slimming substances; clothing for gymnastics; clothing incorporating LEDs; motorists' clothing; belts [clothing]; money belts [clothing]; headwear; berets; caps being headwear; hats; headbands [clothing]; headscarves; hoods [clothing]; visors being headwear; ear muffs [clothing]; cuffs; detachable collars; gloves [clothing]; mittens; muffs [clothing]; neck gaiters; neckties; paper hats [clothing]; shower caps; ready-made linings [parts of clothing]; saris; sarongs; sashes for wear; scarfs; shawls; veils [clothing]; togas; turbans; bandanas [neckerchiefs]; ascots; bodices [lingerie]; camisoles; corselets; corsets [underclothing]; garters; girdles; boxer shorts; braces for clothing [suspenders]; gaiters; pyjamas; panties; brassieres; underpants; underwear; sweat-absorbent underwear; hosiery; stockings; stocking suspenders; footwear; shoes; footwear uppers; boots; boots for sports; boot uppers; sandals; football boots; foot muffs, not electrically heated; gymnastic shoes; half-boots; heelpieces for footwear; heelpieces for stockings; heel protectors for shoes; heels; inner soles; galoshes; breeches for wear; non-slipping devices for footwear; ski boots; ski gloves; skirts; shorts; skull caps; sleep masks; slippers; slips [underclothing]; socks; sock suspenders; soles for footwear; sports jerseys; sports shoes; sports singlets.

35 – Advertising; business management; business administration; office functions; organization, operation and supervision of loyalty and incentive schemes; advertising services provided via the Internet; production of television and radio advertisements; accountancy; auctioneering; trade fairs; opinion polling; data processing; provision of business information; advertising agency services; advertising services provided for others; database management; compilation of information into computer databases; business consulting services; business consulting services in the field of web based events, conferences, training programs, learning programs, and seminars; business consulting services in the field of delivering web-based knowledge; business consulting services in the field of online collaboration and collaboration technologies; business consulting services in the fields of sales and marketing; business project management services; business project management services relating to development, set up, staging, production, recording, monitoring and follow-up for web based events, conferences, training programs, learning programs, and seminars; market research and business consulting services; business consultancy services relating to facilitating the transaction of business via local and global computer networks by locating and providing referrals for the delivery of a wide variety of business and consumer products and services; dissemination of business information of goods and services of others via local and global computer networks; business consultancy services relating to providing a web site on a global computer network by which third parties can offer and source goods and services, place, determine the status of and fulfil trade leads and orders, enter into contracts and transact business; providing computerized online ordering services; advertising of goods and services of others via local and global computer networks; international import and export agency services; rental of advertising space on communication media; online trading services relating to electronic auctioneering and providing online business evaluation relating thereto; providing a directory of third party web sites to facilitate business transactions; business consultancy services relating to operating an electronic marketplace for the buyers and sellers of goods and/or services on a global computer network; business assistance relating to facilitating business transaction via local and global computer networks; corporate management consultancy services; marketing and promotion services; publication of publicity materials; marketing of vacant premises; dissemination of advertising materials, updating of advertising materials, compilation of advertisements for use as web pages on the Internet; rental of advertising space; computer data processing; sales, business and promotional information services; telephone answering (for unavailable subscribers); telephone answering (for others); auctioneering provided on the Internet; personnel management; provision of sales, business, advertising and

promotional information through a global computer network and via the Internet; presentation of goods on communication media for retail purposes; retail and wholesale of cosmetics, perfumery, toiletries, dentifrices, soaps, detergents, deodorants for personal use and household use, bleaching and cleaning preparations, dental care preparations, dentifrices, mouth washes, polishing preparations, candles, wax, pharmaceuticals, veterinary and medical preparations, disinfectants, dietary supplements, baby food, herbs and herbal beverages, sanitary preparations, sanitary diapers, sanitary pads, goods and materials of common metal used for storage, wrapping, packaging and sheltering purposes, containers of metal (storage, transport), metal boxes, packaging containers of metal, aluminium foil, storage containers of metal, metal containers for the transportation of goods, ladders of metal, ironmongery, small hardware of metal, safes of metal, machines, machine tools and industrial robots for processing and shaping wood, metals, glass, plastics and minerals, 3D printers, electric kitchen machines for chopping, grinding, crushing, mixing and mincing foodstuff, washing machines, laundry washing machines, dishwashers, spin driers (not heated), electric cleaning machines for cleaning floors, carpets or floorings, vacuum cleaners and parts thereof, forks, spoons, knives and non-electric cutters, slicers, peelers for kitchen use, including those made of precious metals, tools and apparatus for personal beauty care use: tools and apparatus for shaving, epilation, manicure and pedicure, electric hand implements for straightening and curling hair, scissors, handoperated hand tools for the repair of machines, apparatus and vehicles and for use in construction, agriculture, horticulture and forestry, electric or non-electric irons, steam irons, thermometers, microscopes, magnifying glasses, apparatus for recording, transmission or reproduction of sound or images, cameras, photographic cameras, television apparatus, video recorders, CD and DVD players and recorders, MP3 players, computers, desktop computers, tablet computers, microphones, loudspeakers, earphones, telecommunications apparatus, apparatus for the reproduction of sound or images, computer peripheral devices, cell phones, covers for cell phones, telephone apparatus, computer printers, scanners as data processing equipment, photocopiers, magnetic and optic data carriers and computer software and programmes recorded thereto, downloadable and recordable electronic publications, encoded magnetic and optic cards, photocells, optical sensors, counters, clothing for protection against accidents, irradiation and fire, safety vests and life-saving apparatus and equipment, eyeglasses, unglasses, optical lenses and cases, containers, parts and components thereof, decorative magnets, metronomes, medical orthopaedic articles, corsets for medical purposes, orthopaedic shoes, elastic bandages and supportive bandages, condoms, babies' bottles, babies' pacifiers, teats, teeters for babies, lighting installations, hair dri-

ers, hand drying apparatus, water softening apparatus, electric bed warmers and electric blankets, not for medical use, electric pillow warmers, electric or nonelectric foot warmers, hot water bottles, pasteurizers and sterilizers, motorcycles, mopeds, vehicle seats, headrests for vehicle seats, safety seats for children, for vehicles, seat covers for vehicles, vehicle covers, sunblinds adapted for vehicles, wipers for vehicles, baby carriages, wheelchairs, pushchairs, shopping carts, shopping trolleys, fireworks, sprays for personal defence, jewellery, watches, statuettes and figurines of precious metal, clocks, watches, parts thereof, chronometers, music instruments, their cases, paper and cardboard, paper and cardboard for packaging and wrapping purposes, cardboard boxes, paper towels, toilet paper, paper napkins, plastic materials for packaging and wrapping purposes, printed publications, printed matter, books, magazines, newspapers, bill books, printed dispatch notes, printed vouchers, calendars, posters, photographs [printed], paintings, stickers [stationery], postage stamps, stationery, office stationery, instructional and teaching material [except furniture and apparatus], writing and drawing implements, artists' materials, paper products for stationery purposes, adhesives for stationery purposes, pens, pencils, erasers, adhesive tapes for stationery purposes, cardboard cartons [artists' materials], writing paper, copying paper, paper rolls for cash registers, drawing materials, chalkboards, painting pencils, watercolours [paintings], stationery, instructional and teaching material, writing and drawing implements, artists' materials, paper products for stationery purposes, adhesives for stationery purposes, pens, pencils, erasers, adhesive tapes for stationery purposes, cardboard cartons [artists' materials], writing paper, copying paper, paper rolls for cash registers, drawing materials, chalkboards, painting pencils, watercolours [paintings], pint roller, paint brushes, rosaries, goods made of leather, imitations of leather or other materials designed for carrying items, bags, wallets, straps, boxes and trunks made of leather or stout leather, key cases, trunks [luggage], suitcases, umbrellas, parasols, walking sticks, monuments and statuettes of stone, concrete and marble, furniture, mattresses, pillows, air mattresses and cushions, sleeping bags for camping, water beds, mirrors, bouncing chairs for babies, playpens for babies, cradles, infant walkers, display boards, frames for pictures and paintings, identification plates, identification tags, nameplates, identification labels made of wood or synthetic materials, packaging containers of wood or plastics, storage containers, chests, ornaments and decorative goods of wood, cork, reed, cane, wicker, horn, bone, ivory, whalebone, shell, amber, mother-of-pearl, meerschaum, beeswax, plastic or plaster, figurines, holiday ornaments for walls and sculptures, baskets, kennels, nesting boxes and beds for household pets, cages for household pets, indoor aquariums, vivarium and indoor terrariums for animals and plant cultivation, bamboo cur-

tains, roller indoor blinds [for interiors], slatted indoor blinds, strip curtains, bead curtains for decoration, curtain hooks, curtain rings, curtain tie-backs, curtain rods, hand-operated non-electric cleaning instruments and appliances, brushes, other than paintbrushes, sponges for cleaning, steel wool for cleaning, cloths of textile for cleaning, gloves for dishwashing, non-electric polishing machines for household purposes, brooms for carpets, mops, tooth brushes, shaving brushes, hair brushes, non-electric household or kitchen utensils, service dishes, pots and pans, bottle openers, flower pots, drinking straws, non-electric cooking utensils, ironing boards and shaped covers therefor, drying racks for washing, clothes drying hangers, ornaments and decorative goods of glass, porcelain, earthenware or clay, statues, figurines and vases, perfume burners, perfume sprayers, perfume vaporizers, electric or non-electric make-up removing appliances, powder puffs, toilet cases, plant watering devices and containers, ropes, strings, hammocks, tents, bags of textile, yarns, threads, textile goods for household use, curtains, bed covers, sheets (textile), pillowcases, blankets, quilts, towels, flags, labels, blankets, clothing, headgear, footwear, swimwear, scarves, hats, caps, Laces and embroidery, guipures, festoons, ribbons (haberdashery), ribbons and braid, fastening tapes for clothing, cords for clothing, letters and numerals for marking linen, embroidered emblems, badges for wear, not of precious metal, shoulder pads for clothing, buttons for clothing, fasteners for clothing, eyelets for clothing, zippers, buckles for shoes and belts, fasteners, shoe and belt buckles, pins, other than jewellery, adhesive patches for decoration of textile articles, laces, needles, sewing needles, needles for sewing machines, needles for knitting and embroidery, boxes for needles, needle cushions, artificial flowers, artificial fruits, hair pins, hair buckles, hair bands, decorative articles for the hair, wigs, hair extensions, electric or non-electric hair curlers, carpets, rugs, mats, wallpaper, wall hangings, games, toys, gymnastic and sporting articles, fishing tackle, artificial fishing bait, decoys for hunting and fishing, Christmas trees of artificial material, ornaments for Christmas trees, artificial snow, rattles (playthings), novelties for parties, paper party hats, foodstuff, beverages, matches, tobacco and tobacco products enabling customers to conveniently view and purchase those goods, such services may be provided by retail stores, wholesale outlets, through vending machines, mail order catalogues or by means of electronic media, for example, through web sites or television shopping programmes.

- (260) AM 2023 120406 A
- (800) 1696288
- (151) 2022 02 15
- (891) 2022 02 15
- (731) Orhan Atasay

Üniversite Mahallesi Civan Sokak, Allure
Tower No 1/117 Avcılar, İstanbul, Türkiye
(540)



- (591) Red, white
- (531) 01.15.15; 02.01.22; 23.01.05; 27.03.15;
27.05.01; 27.05.07; 27.05.08; 27.05.09;
27.05.10; 29.01.12

(511)
7 – Construction equipment: bulldozers, buckets for earth moving machines, excavators, road construction and paving machines, drilling machines, rock drilling machines, sweeping machines and robotic mechanisms with the same function; machinery and robotic mechanisms used in agriculture, animal husbandry, agriculture and grain/fruit/vegetable/food processing, beverage making and processing machinery; bearings, ball or roller bearings; alternators, generators, electric generators, solar powered generators; electric and gas welding machines, electric arc welding devices, electric soldering devices, electric arc cutting devices, electric welding machine electrodes and robots with the same function; packaging machines, fill-plug and seal machines, labeling machines, sorters, and robots and robotic mechanisms (including electrical plastic closing/sealing devices [packing]); pumps without machinery or engine parts (including fuel filling and distribution pumps and their guns); automatic vending machines; electric opening and closing mechanisms for vehicle windows; machines, machine tools and industrial robots for the processing and shaping of wood, metal, glass and plastic materials, extractors for mines; three-dimensional printers; lifting, transporting and conveying machinery: elevators, escalators, cranes, robotic mechanisms with the same function; engines, electric motors, their parts and assemblies, except for land vehicles: hydraulic and pneumatic controls, brakes, brake linings, other than for vehicles, cranks-hafts, gears, cylinders, pistons, turbines, filters being parts of machines or engines; parts used in land vehicles and included in this class: oil, fuel and air filters for vehicles, exhausts, exhaust manifolds, cylinders for engines, cylinder heads, pistons, carburetors, fuel conversion devices, fuel injectors, fuel saving devices, pumps, valves, starters, dynamos, spark plugs bearings and ball or roller bearings for engines and motors; tire removal and mounting machines; paint machines, automatic paint spray guns, electric, hydraulic and pneumatic punching machines and guns, electric glue guns, compressed air or spray guns for machines, power drills, chainsaws, jigsaws, spiral machines, compressed air generators, compressors, car wash machines and robots that have the same function as the machines and tools listed above; printing machines; textile machines, sewing machines and industrial

robots with the same function; kitchen power tools for chopping, grinding, mashing, whisking and crumbling; washing machines, namely, washing and dish-washing machines, spin dryers [not heated]; electric machines, vacuum cleaners and parts thereof for cleaning floors, carpets or upholstery; galvanizing machines and electrolysis apparatus for electroplating; mechanical cylinder seals for machinery and engines.

9 – Devices for recording, transferring or reproducing sound and image: cameras, cinematographic cameras, televisions, videos, cd-dvd recording and player devices, mp3 players, computers, desktop tablet computers, wearable technological devices, namely, smart-watches, smart wristbands and head-mounted cameras, microphones, speakers, headphones; communication and duplication devices and computer peripheral equipment: mobile phones and their cases, fixed telephones, telephone exchanges, computer printers, scanners, copiers; antennas, satellite dishes, amplifiers and parts thereof; elements used in the electronics of machines and devices: semiconductors, electronic circuits, integrated chips (chips), diodes, transistors, magnetic heads; electronic locks, photocells, remote control apparatus for opening and closing doors, sensors; protective clothing, protection and life-saving equipment; electrical energy transmission, conversion, storage and control devices and tools: plugs, junction boxes, switches, breakers, fuses, ballasts, battery jump starters, electrical panels, resistors, electric sockets, transformers, adapters, chargers, cables used in electricity, electronics, batteries, accumulators, solar panels for electricity generation; signal bells, luminous or mechanical traffic signs and traffic-light apparatus [signalling devices]; radars, submarine radars (sonars), night vision apparatus and instruments; metronomes; measuring instruments, instruments, including those for science, nautical, topography, meteorology, industrial and laboratory use: non-medical thermometers, barometers, ammeters, voltmeters, humidity meters, test equipment, telescopes, periscopes, compasses; vehicle indicators; materials used in laboratories: microscopes, magnifiers, binoculars, experimental materials and devices; magnetic and optical record carriers and computer programs and software recorded on them; electronic publications that can be downloaded via computer networks and recorded on magnetic and optical media; cards with magnetic/optical reader, motion pictures, serials and video music clips recorded on magnetic, optical and electronic media; ticket dispensers, cash machines; counters and timers that measure the amount of consumption per unit time; eyeglasses, sunglasses, lenses and their cases, cases, parts and accessories for eyeglasses; devices which main function is warning and alarm (except vehicle alarms), namely, warning signs [luminous], security warning apparatus, anti-theft warning apparatus and alarms, electric bells; fire-fighting appliances and devices, namely, fire engines, fire hose and fire pumps; decorative magnets.

11 – Solid, liquid or gaseous fuel and electrical heating devices: combi boilers, boilers, electric heaters, heat exchangers, stoves, cookers; solar thermal collectors [heating]; air conditioning and ventilation devices; electric and gas powered appliances, machines and appliances for cooking, drying and boiling: ovens, electric pots, electric kettles, barbecues, barbecues, electric clothes dryers, hair dryers and hand dryers; water softening equipment, water treatment equipment, water treatment plant, waste treatment plant; filters for aquariums; pasteurizing and sterilizing machines; lighting devices (vehicles, indoor and outdoor lighting fixtures); steam, gas and fog (smoke) generators: steam generators (boilers), acetylene generators, oxygen generators, nitrogen generators; electric coolers and freezers; non-medical electric heating cushions, blankets and heating pads, electric or non-electric foot warmers, hot water bags (thermophores), electrically heated socks; industrial type cooking, drying and cooling installation.

35 – Advertising, marketing and public relations services, organization of exhibitions and fairs for commercial and advertising purposes, development of advertising concepts; provision of an online marketplace for buyers and sellers of goods and services; office functions; secretarial services, arranging newspaper subscriptions for others, compilation of statistics, rental of office machines, systematization of information in computer databases, telephone answering services; business management, administration and consultancy in the field of accounting, personnel job placement, recruitment, personnel selection, personnel supply services, import-export agency services, temporary personnel assignment; invoicing services for others; organization and execution of auctions; the bringing together, for the benefit of others, of a variety of goods, namely, parts of motors and engines of all kinds, namely, starters, mufflers and cylinders for motors and engines of any type, electric cleaning and polishing apparatus, namely, electric shoe polishers, electric machines and apparatus for carpet shampooing and vacuum cleaners, 3d printers, industrial robots, certain special vehicles not for transportation purposes, namely, road sweeping machines, road making machines, bulldozers, snow ploughs, as well as rubber tracks as parts of those vehicles' crawlers, apparatus and instruments for scientific research in laboratories, training apparatus and simulators, namely, resuscitation mannequins, simulators for the steering and control of vehicles, apparatus and instruments for controlling and monitoring aircraft, watercraft and unmanned vehicles, namely, navigational instruments, transmitters, compasses for measuring, gps apparatus, automatic steering apparatus for vehicles, safety and security apparatus and instruments, namely, safety nets, signalling lights, traffic-light apparatus, fire engines, sound alarms, security tokens being encryption devices, clothing that protects against serious or life-

threatening injuries, namely, clothing for protection against accidents, irradiation and fire, bullet-proof clothing, protective helmets, head guards for sports, mouth guards for sports, protective suits for aviators, knee-pads for workers, optical apparatus and instruments, namely, eyeglasses, contact lenses, magnifying glasses, mirrors for inspecting work, peepholes, magnets, smartwatches, wearable activity trackers, joysticks for use with computers, other than for video games, virtual reality headsets, smartglasses, eyeglass cases, cases for smartphones, cases especially made for photographic apparatus and instruments, automated teller machines, invoicing machines, material testing instruments and machines, batteries and chargers for electronic cigarettes, electric and electronic effects units for musical instruments, laboratory robots, teaching robots, security surveillance robots, humanoid robots with artificial intelligence for use in scientific research, air-conditioning apparatus and installations, ovens, other than for laboratory use, namely, dental ovens, microwave ovens, bakers' ovens, stoves being heating apparatus, solar thermal collectors, chimney flues, chimney blowers, hearths, domestic fireplaces, sterilizers, incinerators, lighting apparatus and installations, namely, luminous tubes for lighting, searchlights, luminous house numbers, vehicle reflectors, lights for vehicles, lamps, namely, electric lamps, gas lamps, laboratory lamps, oil lamps, street lamps, safety lamps, tanning beds, bath installations, bath fittings, bath plumbing fixtures, toilets, urinals, fountains, chocolate fountains, electrically heated pads, cushions and blankets, not for medical purposes, hot water bottles, electrically heated clothing, electric appliances for making yogurt, bread-making machines, coffee machines, ice-cream making machines, ice machines and apparatus enabling customers to conveniently view and purchase those goods, such services may be provided by retail stores, wholesale outlets, by means of electronic media or through mail order catalogues.

(260) AM 2023 120408 A

(800) 1696311

(151) 2022 02 16

(891) 2022 02 16

(731) Orhan Atasay

Üniversite Mahallesi Civan Sokak, Allure
Tower NO 1/117 Avcılar, İstanbul, Türkiye

(540)



(591) Blue, Turquoise

(531) 26.13.25; 27.05.01; 27.05.03; 27.05.22;
29.01.12

(511)

7 – Construction equipment: bulldozers, buckets for earth moving machines, excavators, road construction and paving machines, drilling machines, rock drilling machines, sweeping machines and robotic mechanisms with the same function; machinery and robotic mechanisms used in agriculture, animal husbandry, agriculture and grain/fruit/vegetable/food processing, beverage making and processing machinery; bearings, ball or roller bearings; alternators, generators, electric generators, solar powered generators; electric and gas welding machines, electric arc welding devices, electric soldering devices, electric arc cutting devices, electric welding machine electrodes and robots with the same function; packaging machines, fill-plug and seal machines, labeling machines, sorters, and robots and robotic mechanisms (including electrical plastic closing/sealing devices [packing]); pumps without machinery or engine parts (including fuel filling and distribution pumps and their guns); automatic vending machines; electric opening and closing mechanisms for vehicle windows; machines, machine tools and industrial robots for the processing and shaping of wood, metal, glass and plastic materials, extractors for mines; three-dimensional printers; lifting, transporting and conveying machinery: elevators, escalators, cranes, robotic mechanisms with the same function; engines, electric motors, their parts and assemblies, except for land vehicles: hydraulic and pneumatic controls, brakes, brake linings, other than for vehicles, crankshafts, gears, cylinders, pistons, turbines, filters being parts of machines or engines; parts used in land vehicles and included in this class: oil, fuel and air filters for vehicles, exhausts, exhaust manifolds, cylinders for engines, cylinder heads, pistons, carburetors, fuel conversion devices, fuel injectors, fuel saving devices, pumps, valves, starters, dynamos, spark plugs bearings and ball or roller bearings for engines and motors; tire removal and mounting machines; paint machines, automatic paint spray guns, electric, hydraulic and pneumatic punching machines and guns, electric glue guns, compressed air or spray guns for machines, power drills, chainsaws, jigsaws, spiral machines, compressed air generators, compressors, car wash machines and robots that have the same function as the machines and tools listed above; printing machines; textile machines, sewing machines and industrial robots with the same function; kitchen power tools for chopping, grinding, mashing, whisking and crumbling; washing machines, namely, washing and dishwashing machines, spin dryers [not heated]; electric machines, vacuum cleaners and parts thereof for cleaning floors, carpets or upholstery; galvanizing machines and electrolysis apparatus for electroplating; mechanical cylinder seals for machinery and engines.

9 – Devices for recording, transferring or reproducing sound and image: cameras, cinematographic cameras, televisions, videos, cd-dvd recording and player devices, mp3 players, computers, desktop tablet compu-

ters, wearable technological devices, namely, smart-watches, smart wristbands and head-mounted cameras, microphones, speakers, headphones; communication and duplication devices and computer peripheral equipment: mobile phones and their cases, fixed telephones, telephone exchanges, computer printers, scanners, copiers; antennas, satellite dishes, amplifiers and parts thereof; elements used in the electronics of machines and devices: semiconductors, electronic circuits, integrated chips (chips), diodes, transistors, magnetic heads; electronic locks, photocells, remote control apparatus for opening and closing doors, sensors; protective clothing, protection and life-saving equipment; electrical energy transmission, conversion, storage and control devices and tools: plugs, junction boxes, switches, breakers, fuses, ballasts, battery jump starters, electrical panels, resistors, electric sockets, transformers, adapters, chargers, cables used in electricity, electronics, batteries, accumulators, solar panels for electricity generation; signal bells, luminous or mechanical traffic signs and traffic-light apparatus [signalling devices]; radars, submarine radars (sonars), night vision apparatus and instruments; metronomes; measuring instruments, instruments, including those for science, nautical, topography, meteorology, industrial and laboratory use: non-medical thermometers, barometers, ammeters, voltmeters, humidity meters, test equipment, telescopes, periscopes, compasses; vehicle indicators; materials used in laboratories: microscopes, magnifying glasses, binoculars, experimental materials and devices; magnetic and optical record carriers and computer programs and software recorded on them; electronic publications that can be downloaded via computer networks and recorded on magnetic and optical media; cards with magnetic/optical reader, motion pictures, serials and video music clips recorded on magnetic, optical and electronic media; ticket dispensers, cash machines; counters and timers that measure the amount of consumption per unit time; eyeglasses, sunglasses, lenses and their cases, cases, parts and accessories for eyeglasses; devices which main function is warning and alarm (except vehicle alarms), namely, warning signs [luminous], security warning apparatus, anti-theft warning apparatus and alarms, electric bells; fire-fighting appliances and devices, namely, fire engines, fire hose and fire pumps; decorative magnets.

11 – Solid, liquid or gaseous fuel and electrical heating devices: combi boilers, boilers, electric heaters, heat exchangers, stoves, cookers; solar thermal collectors [heating]; air conditioning and ventilation devices; electric and gas powered appliances, machines and appliances for cooking, drying and boiling: ovens, electric pots, electric kettles, barbecues, barbecues, electric clothes dryers, hair dryers and hand dryers; water softening equipment, water treatment equipment, water treatment plant, waste treatment plant; filters for aquariums; pasteurizing and sterilizing machines; lighting devices (vehicles, indoor and outdoor

lighting fixtures); steam, gas and fog (smoke) generators: steam generators (boilers), acetylene generators, oxygen generators, nitrogen generators; electric coolers and freezers; non-medical electric heating cushions, blankets and heating pads, electric or non-electric foot warmers, hot water bags (thermophores), electrically heated socks; industrial type cooking, drying and cooling installation.

35 – Advertising, marketing and public relations services, organization of exhibitions and fairs for commercial and advertising purposes, development of advertising concepts; provision of an online marketplace for buyers and sellers of goods and services; office functions; secretarial services, arranging newspaper subscriptions for others, compilation of statistics, rental of office machines, systematization of information in computer databases, telephone answering services; business management, administration and consultancy in the field of accounting, personnel job placement, recruitment, personnel selection, personnel supply services, import-export agency services, temporary personnel assignment; invoicing services for others; organization and execution of auctions; the bringing together, for the benefit of others, of a variety of goods, namely, parts of motors and engines of all kinds, namely, starters, mufflers and cylinders for motors and engines of any type, electric cleaning and polishing apparatus, namely, electric shoe polishers, electric machines and apparatus for carpet shampooing and vacuum cleaners, 3d printers, industrial robots, certain special vehicles not for transportation purposes, namely, road sweeping machines, road making machines, bulldozers, snow ploughs, as well as rubber tracks as parts of those vehicles' crawlers, apparatus and instruments for scientific research in laboratories, training apparatus and simulators, namely, resuscitation mannequins, simulators for the steering and control of vehicles, apparatus and instruments for controlling and monitoring aircraft, watercraft and unmanned vehicles, namely, navigational instruments, transmitters, compasses for measuring, gps apparatus, automatic steering apparatus for vehicles, safety and security apparatus and instruments, namely, safety nets, signalling lights, traffic-light apparatus, fire engines, sound alarms, security tokens being encryption devices, clothing that protects against serious or life-threatening injuries, namely, clothing for protection against accidents, irradiation and fire, bullet-proof clothing, protective helmets, head guards for sports, mouth guards for sports, protective suits for aviators, knee-pads for workers, optical apparatus and instruments, namely, eyeglasses, contact lenses, magnifying glasses, mirrors for inspecting work, peepholes, magnets, smart-watches, wearable activity trackers, joysticks for use with computers, other than for video games, virtual reality headsets, smartglasses, eyeglass cases, cases for smartphones, cases especially made for photographic apparatus and instruments, automated teller machines, invoicing machines, material testing instru-

ments and machines, batteries and chargers for electronic cigarettes, electric and electronic effects units for musical instruments, laboratory robots, teaching robots, security surveillance robots, humanoid robots with artificial intelligence for use in scientific research, air-conditioning apparatus and installations, ovens, other than for laboratory use, namely, dental ovens, microwave ovens, bakers' ovens, stoves being heating apparatus, solar thermal collectors, chimney flues, chimney blowers, hearths, domestic fireplaces, sterilizers, incinerators, lighting apparatus and installations, namely, luminous tubes for lighting, searchlights, luminous house numbers, vehicle reflectors, lights for vehicles, lamps, namely, electric lamps, gas lamps, laboratory lamps, oil lamps, street lamps, safety lamps, tanning beds, bath installations, bath fittings, bath plumbing fixtures, toilets, urinals, fountains, chocolate fountains, electrically heated pads, cushions and blankets, not for medical purposes, hot water bottles, electrically heated clothing, electric appliances for making yogurt, bread-making machines, coffee machines, ice-cream making machines, ice machines and apparatus enabling customers to conveniently view and purchase those goods, such services may be provided by retail stores, wholesale outlets, by means of electronic media or through mail order catalogues.

(260) AM 2023 120409 A

(800) 1696478

(151) 2022 09 19

(891) 2022 09 19

(731) Kia Corporation

12, Heolleung-ro, Seocho-gu, Seoul 06797,
Republic of Korea

(540)

Kia

(591) Black, white

(511)

42 – Marine, aerial and land surveying; design of industrial robots; design of mechanical equipment for car manufacturing; design services for parts of motor vehicles; motor vehicle design; design of cars; design of products; design of vehicles and vehicle parts and components; design of apparatus and machines for filling purposes; textile design services for motor vehicle trim; programming of multimedia applications; design and development of application software for metaverse environments; design and development of application software for security tokens (encryption devices); development of computer software for 3D content/stereoscopic 3D projectionD animation technology; user authentication services using blockchain technology; software engineering; computer software planning for vehicle manufacturing; development of control software for electrical vehicle equipment; software design and development services; data conversion of electronic information; design and development

of virtual reality software; design, maintenance, rental and updating of computer software; design and development of operating software for metaverse environments; design and development of game software for metaverse environments; maintenance of application software for metaverse environments; maintenance of operating software for metaverse environments; maintenance of game software for metaverse environments; avatar-related virtual reality software development services; computer software development; data encryption services; development of image processing software; hosting platforms on the Internet for online content; providing paas (platform as a service); product research and development; testing, inspection and research services in the fields of agriculture, livestock breeding and fisheries; research relating to mechanical engineering; rental of laboratory robots; engineering services relating to robotics; engineering services of land vehicle industry; development of technologies for the fabrication of circuits for wireless communication, electronic data processing, consumer electronic, automotive electronics; inspection of motor vehicles before transport [for roadworthiness]; vehicle roadworthiness testing; inspection of motor vehicles [for roadworthiness]; development of vehicles; automobile inspection; providing scientific information relating to performance and operation of car; automobile technology research; automotive wheel testing; research and development of power converters/inverter/charger for used in renewable energy systems; monitoring of battery charging status [as parts of quality control services]; maintenance of computer software used for operating filling apparatus and machines; quality control; product testing of original vehicle form; inspection of vehicles for road-worthiness; inspection services for new and used vehicles for persons buying or selling their vehicles; quality assurance services for automobiles; technological research services in the field of automobiles, including autonomous, electric, hybrid, hydrogen and connected vehicles; environmental testing.

(260) AM 2023 120410 A

(800) 1696497

(151) 2022 09 24

(891) 2022 09 24

(731) KRKA, Tovarna Zdravil, D.D., Novo mesto
Šmarješka cesta 6, SI-8000 Novo mesto,
Slovenia

(540)

ATORVITIMB

(591) Black, white

(511)

5 – Pharmaceutical preparations.

(260) AM 2023 120411 A
 (800) 1696565
 (151) 2022 09 08
 (891) 2022 09 08
 (731) Kokourov Igor Nikolaevich
 prospect Zhukova, 11, kv. 274, RU-664050
 Irkutsk, Russian Federation



(591) Green, white and yellow.
 (531) 05.13.25; 25.01.13; 25.01.25; 27.01.12;
 27.05.11; 29.01.12
 (511)
 32 – Beer; mineral and aerated waters; fruit beverages
 and fruit juices; syrups and other preparations for
 making beverages.
 33 – Alcoholic beverages, except beer.

(260) AM 2023 120412 A
 (800) 1696619
 (151) 2022 02 15
 (891) 2022 02 15
 (731) Orhan Atasay
 Üniversite Mahallesi Civan Sokak, Allure
 Tower No 1/117 Avcılar, İstanbul, Türkiye



(591) Blue, red
 (531) 26.01.04; 26.01.24; 26.03.01; 26.03.05;
 26.03.24; 26.11.01; 26.11.08; 27.05.01;
 27.05.09; 27.05.10; 27.05.11; 28.01; 28.19;
 29.01.12
 (511)
 7 – Construction equipment: bulldozers, buckets for
 earth moving machines, excavators, road construction
 and paving machines, drilling machines, rock drilling
 machines, sweeping machines and robotic mecha-
 nisms with the same function; machinery and robotic
 mechanisms used in agriculture, livestock breeding,
 agricultural sectors and grain/fruit/vegetable/food pro-
 cessing, beverage making and processing machinery;
 bearings, ball or roller bearings; alternators, genera-
 tors, electric generators, solar powered generators; el-
 ectric and gas welding machines, electric arc welding
 devices, electric soldering devices, electric arc cutting
 devices, electric welding machine electrodes and ro-
 bots with the same function; packaging machines, fill-
 plug and seal machines, labeling machines, sorters,
 and robots and robotic mechanisms (including elec-

trical plastic closing/sealing devices [packing]);
 pumps without machinery or engine parts (including
 fuel filling and distribution pumps and their guns);
 automatic vending machines; electric opening and
 closing mechanisms for vehicle windows; machines,
 machine tools and industrial robots for the processing
 and shaping of wood, metal, glass and plastic mate-
 rials, extractors for mines; three-dimensional printers;
 lifting, transporting and conveying machinery: eleva-
 tors, escalators, cranes, robotic mechanisms with the
 same function; engines, electric motors, their parts
 and assemblies, except for land vehicles: hydraulic
 and pneumatic controls, brakes, brake linings, other
 than for vehicles, crankshafts, gears, cylinders, pis-
 tons, turbines, filters being parts of machines or en-
 gines; parts used in land vehicles and included in this
 class: oil, fuel and air filters for vehicles, exhausts,
 exhaust manifolds, cylinders for engines, cylinder
 heads, pistons, carburetors, fuel conversion devices,
 fuel injectors, fuel saving devices, pumps, valves,
 starters, dynamos, spark plugs bearings and ball or ro-
 ller bearings for engines and motors; tire removal and
 mounting machines; paint machines, automatic paint
 spray guns, electric, hydraulic and pneumatic pun-
 ching machines and guns, electric glue guns, com-
 pressed air or spray guns for machines, power drills,
 chainsaws, jigsaws, spiral machines, compressed air
 generators, compressors, car wash machines and ro-
 bots that have the same function as the machines and
 tools listed above; printing machines; textile machi-
 nes, sewing machines and industrial robots with the
 same function; kitchen power tools for chopping,
 grinding, mashing, whisking and crumbling; washing
 machines, namely, washing and dishwashing machi-
 nes, spin dryers [not heated]; electric machines, vacu-
 um cleaners and parts thereof for cleaning floors,
 carpets or upholstery; galvanizing machines and elec-
 trolysis apparatus for electroplating; mechanical cy-
 linder seals for machinery and engines.

9 – Devices for recording, transferring or reproducing
 sound and image: cameras, cinematographic cameras,
 televisions, videos, cd-dvd recording and player de-
 vices, mp3 players, computers, desktop tablet compu-
 ters, wearable technological devices, namely, smart-
 watches, smart wristbands and head-mounted came-
 ras, microphones, speakers, headphones; communica-
 tion and duplication devices and computer peripheral
 equipment: mobile phones and their cases, fixed telep-
 phones, telephone exchanges, computer printers, scan-
 ners, copiers; antennas, satellite dishes, amplifiers and
 parts thereof; elements used in the electronics of ma-
 chines and devices: semiconductors, electronic cir-
 cuits, chips [integrated circuits], diodes, transistors,
 magnetic heads; electronic locks, photocells, remote
 control apparatus for opening and closing doors, sen-
 sors; protective clothing, protection and life-saving
 equipment; electrical energy transmission, conversion,
 storage and control devices and tools: plugs, junction
 boxes, switches, breakers, fuses, ballasts, battery jump

starters, electrical panels, resistors, electric sockets, transformers, adapters, chargers, cables used in electricity, electronics, batteries, accumulators, solar panels for electricity generation; signal bells, luminous or mechanical traffic signs and traffic-light apparatus [signalling devices]; radars, submarine radars (sonars), night vision apparatus and instruments; metronomes; measuring instruments, instruments, including those for science, nautical, topography, meteorology, industrial and laboratory use: non-medical thermometers, barometers, ammeters, voltmeters, humidity meters, test equipment, telescopes, periscopes, compasses; vehicle indicators; materials used in laboratories: microscopes, magnifiers, binoculars, experimental materials and devices; magnetic and optical record carriers and computer programs and software recorded on them; electronic publications that can be downloaded via computer networks and recorded on magnetic and optical media; cards with magnetic/optical reader, motion pictures, serials and video music clips recorded on magnetic, optical and electronic media; ticket dispensers, cash machines; counters and timers that measure the amount of consumption per unit time; eyeglasses, sunglasses, lenses and their cases, cases, parts and accessories for eyeglasses; devices which main function is warning and alarm (except vehicle alarms), namely, warning signs [luminous], security warning apparatus, anti-theft warning apparatus and alarms, electric bells; fire-fighting appliances and devices, namely, fire engines, fire hose and fire pumps; decorative magnets.

11 – Solid, liquid or gaseous fuel and electrical heating devices: combi boilers, boilers, electric heaters, heat exchangers, stoves, cookers; solar thermal collectors [heating]; air conditioning and ventilation devices; electric and gas powered appliances, machines and appliances for cooking, drying and boiling: ovens, electric pots, electric kettles, barbecues, barbecues, electric clothes dryers, hair dryers and hand dryers; water softening equipment, water treatment equipment, water treatment plant, waste treatment plant; filters for aquariums; pasteurizing and sterilizing machines; lighting devices (vehicles, indoor and outdoor lighting fixtures); steam, gas and fog (smoke) generators: steam generators (boilers), acetylene generators, oxygen generators, nitrogen generators; electric coolers and freezers; non-medical electric heating cushions, blankets and heating pads, electric or non-electric foot warmers, hot water bags (thermophores), electrically heated socks; industrial type cooking, drying and cooling installation.

35 – Advertising, marketing and public relations services, organization of exhibitions and fairs for commercial and advertising purposes, development of advertising concepts; provision of an online marketplace for buyers and sellers of goods and services; office functions; secretarial services, arranging newspaper subscriptions for others, compilation of statistics, ren-

tal of office machines, systematization of information in computer databases, telephone answering services; business management, administration and consultancy in the field of accounting, personnel job placement, recruitment, personnel selection, personnel supply services, import-export agency services, temporary personnel assignment; invoicing services for others; organization and execution of auctions; the bringing together, for the benefit of others, of a variety of goods, namely, parts of motors and engines of all kinds, namely, starters, mufflers and cylinders for motors and engines of any type, electric cleaning and polishing apparatus, namely, electric shoe polishers, electric machines and apparatus for carpet shampooing and vacuum cleaners, 3d printers, industrial robots, certain special vehicles not for transportation purposes, namely, road sweeping machines, road making machines, bulldozers, snow ploughs, as well as rubber tracks as parts of those vehicles' crawlers, apparatus and instruments for scientific research in laboratories, training apparatus and simulators, namely, resuscitation mannequins, simulators for the steering and control of vehicles, apparatus and instruments for controlling and monitoring aircraft, watercraft and unmanned vehicles, namely, navigational instruments, transmitters, compasses for measuring, gps apparatus, automatic steering apparatus for vehicles, safety and security apparatus and instruments, namely, safety nets, signalling lights, traffic-light apparatus, fire engines, sound alarms, security tokens being encryption devices, clothing that protects against serious or life-threatening injuries, namely, clothing for protection against accidents, irradiation and fire, bullet-proof clothing, protective helmets, head guards for sports, mouth guards for sports, protective suits for aviators, knee-pads for workers, optical apparatus and instruments, namely, eyeglasses, contact lenses, magnifying glasses, mirrors for inspecting work, peepholes, magnets, smartwatches, wearable activity trackers, joysticks for use with computers, other than for video games, virtual reality headsets, smartglasses, eyeglass cases, cases for smartphones, cases especially made for photographic apparatus and instruments, automated teller machines, invoicing machines, material testing instruments and machines, batteries and chargers for electronic cigarettes, electric and electronic effects units for musical instruments, laboratory robots, teaching robots, security surveillance robots, humanoid robots with artificial intelligence for use in scientific research, air-conditioning apparatus and installations, ovens, other than for laboratory use, namely, dental ovens, microwave ovens, bakers' ovens, stoves being heating apparatus, solar thermal collectors, chimney flues, chimney blowers, hearths, domestic fireplaces, sterilizers, incinerators, lighting apparatus and installations, namely, luminous tubes for lighting, searchlights, luminous house numbers, vehicle reflectors, lights for vehicles, lamps, namely, electric lamps, gas lamps, laboratory lamps, oil lamps, street lamps, sa-

fety lamps, tanning beds, bath installations, bath fittings, bath plumbing fixtures, toilets, urinals, fountains, chocolate fountains, electrically heated pads, cushions and blankets, not for medical purposes, hot water bottles, electrically heated clothing, electric appliances for making yogurt, bread-making machines, coffee machines, ice-cream making machines, ice machines and apparatus enabling customers to conveniently view and purchase those goods, such services may be provided by retail stores, wholesale outlets, by means of electronic media or through mail order catalogues.

(260) AM 2023 120413 A

(800) 1696620

(151) 2022 02 15

(891) 2022 02 15

(731) Orhan Atasay

Üniversite Mahallesi Civan Sokak, Allure
Tower No 1/117 Avcılar, İstanbul, Türkiye

(540)

Depoint

(591) Black, light blue

(531) 26.01.03; 27.05.01; 27.05.04; 29.01.12

(511)

7 – Construction equipment: bulldozers, buckets for earth moving machines, excavators, road construction and paving machines, drilling machines, rock drilling machines, sweeping machines and robotic mechanisms with the same function; machinery and robotic mechanisms used in agriculture, animal husbandry, agriculture and grain/fruit/vegetable/food processing, beverage making and processing machinery; bearings, ball or roller bearings; alternators, generators, electric generators, solar powered generators; electric and gas welding machines, electric arc welding devices, electric soldering devices, electric arc cutting devices, electric welding machine electrodes and robots with the same function; packaging machines, fill-plug and seal machines, labeling machines, sorters, and robots and robotic mechanisms (including electrical plastic closing/sealing devices [packing]); pumps without machinery or engine parts (including fuel filling and distribution pumps and their guns); automatic vending machines; electric opening and closing mechanisms for vehicle windows; machines, machine tools and industrial robots for the processing and shaping of wood, metal, glass and plastic materials, extractors for mines; three-dimensional printers; lifting, transporting and conveying machinery: elevators, escalators, cranes, robotic mechanisms with the same function; engines, electric motors, their parts and assemblies, except for land vehicles: hydraulic and pneumatic controls, brakes, brake linings, other than for vehicles, crankshafts, gears, cylinders, pistons, turbines, filters being parts of machines or engines; parts used in land

vehicles and included in this class: oil, fuel and air filters for vehicles, exhausts, exhaust manifolds, cylinders for engines, cylinder heads, pistons, carburetors, fuel conversion devices, fuel injectors, fuel saving devices, pumps, valves, starters, dynamos, spark plugs bearings and ball or roller bearings for engines and motors; tire removal and mounting machines; paint machines, automatic paint spray guns, electric, hydraulic and pneumatic punching machines and guns, electric glue guns, compressed air or spray guns for machines, power drills, chainsaws, jigsaws, spiral machines, compressed air generators, compressors, car wash machines and robots that have the same function as the machines and tools listed above; printing machines; textile machines, sewing machines and industrial robots with the same function; kitchen power tools for chopping, grinding, mashing, whisking and crumbling; washing machines, namely, washing and dishwashing machines, spin dryers [not heated]; electric machines, vacuum cleaners and parts thereof for cleaning floors, carpets or upholstery; galvanizing machines and electrolysis apparatus for electroplating; mechanical cylinder seals for machinery and engines.

9 – Devices for recording, transferring or reproducing sound and image: cameras, cinematographic cameras, televisions, videos, cd-dvd recording and player devices, mp3 players, computers, desktop tablet computers, wearable technological devices, namely, smart-watches, smart wristbands and head-mounted cameras, microphones, speakers, headphones; communication and duplication devices and computer peripheral equipment: mobile phones and their cases, fixed telephones, telephone exchanges, computer printers, scanners, copiers; antennas, satellite dishes, amplifiers and parts thereof; elements used in the electronics of machines and devices: semiconductors, electronic circuits, chips [integrated circuits], diodes, transistors, magnetic heads; electronic locks, photocells, remote control apparatus for opening and closing doors, sensors; protective clothing, protection and life-saving equipment; electrical energy transmission, conversion, storage and control devices and tools: plugs, junction boxes, switches, breakers, fuses, ballasts, battery jump starters, electrical panels, resistors, electric sockets, transformers, adapters, chargers, cables used in electricity, electronics, batteries, accumulators, solar panels for electricity generation; signal bells, luminous or mechanical traffic signs and traffic-light apparatus [signalling devices]; radars, submarine radars (sonars), night vision apparatus and instruments; metronomes; measuring instruments, instruments, including those for science, nautical, topography, meteorology, industrial and laboratory use: non-medical thermometers, barometers, ammeters, voltmeters, humidity meters, test equipment, telescopes, periscopes, compasses; vehicle indicators; materials used in laboratories: microscopes, magnifying glasses, binoculars, experimental materials and devices; magnetic and optical record carriers and computer programs

and software recorded on them; electronic publications that can be downloaded via computer networks and recorded on magnetic and optical media; cards with magnetic/optical reader, motion pictures, serials and video music clips recorded on magnetic, optical and electronic media; ticket dispensers, cash machines; counters and timers that measure the amount of consumption per unit time; eyeglasses, sunglasses, lenses and their cases, cases, parts and accessories for eyeglasses; devices which main function is warning and alarm (except vehicle alarms), namely, warning signs [luminous], security warning apparatus, anti-theft warning apparatus and alarms, electric bells; fire-fighting appliances and devices, namely, fire engines, fire hose and fire pumps; decorative magnets.

11 – Solid, liquid or gaseous fuel and electrical heating devices: combi boilers, boilers, electric heaters, heat exchangers, stoves, cookers; solar thermal collectors [heating]; air conditioning and ventilation devices; electric and gas powered appliances, machines and appliances for cooking, drying and boiling: ovens, electric pots, electric kettles, barbecues, barbecues, electric clothes dryers, hair dryers and hand dryers; water softening equipment, water treatment equipment, water treatment plant, waste treatment plant; filters for aquariums; pasteurizing and sterilizing machines; lighting devices (vehicles, indoor and outdoor lighting fixtures); steam, gas and fog (smoke) generators: steam generators (boilers), acetylene generators, oxygen generators, nitrogen generators; electric coolers and freezers; non-medical electric heating cushions, blankets and heating pads, electric or non-electric foot warmers, hot water bags (thermophores), electrically heated socks; industrial type cooking, drying and cooling installation.

35 – Advertising, marketing and public relations services, organization of exhibitions and fairs for commercial and advertising purposes, development of advertising concepts; provision of an online marketplace for buyers and sellers of goods and services; office functions; secretarial services, arranging newspaper subscriptions for others, compilation of statistics, rental of office machines, systematization of information in computer databases, telephone answering services; business management, administration and consultancy in the field of accounting, personnel job placement, recruitment, personnel selection, personnel supply services, import-export agency services, temporary personnel assignment; invoicing services for others; organization and execution of auctions; the bringing together, for the benefit of others, of a variety of goods, namely, parts of motors and engines of all kinds, namely, starters, mufflers and cylinders for motors and engines of any type, electric cleaning and polishing apparatus, namely, electric shoe polishers, electric machines and apparatus for carpet shampooing and vacuum cleaners, 3d printers, industrial robots, certain special vehicles not for transportation purposes,

namely, road sweeping machines, road making machines, bulldozers, snow ploughs, as well as rubber tracks as parts of those vehicles' crawlers, apparatus and instruments for scientific research in laboratories, training apparatus and simulators, namely, resuscitation mannequins, simulators for the steering and control of vehicles, apparatus and instruments for controlling and monitoring aircraft, watercraft and unmanned vehicles, namely, navigational instruments, transmitters, compasses for measuring, gps apparatus, automatic steering apparatus for vehicles, safety and security apparatus and instruments, namely, safety nets, signalling lights, traffic-light apparatus, fire engines, sound alarms, security tokens being encryption devices, clothing that protects against serious or life-threatening injuries, namely, clothing for protection against accidents, irradiation and fire, bullet-proof clothing, protective helmets, head guards for sports, mouth guards for sports, protective suits for aviators, knee-pads for workers, optical apparatus and instruments, namely, eyeglasses, contact lenses, magnifying glasses, mirrors for inspecting work, peepholes, magnets, smartwatches, wearable activity trackers, joysticks for use with computers, other than for video games, virtual reality headsets, smartglasses, eyeglass cases, cases for smartphones, cases especially made for photographic apparatus and instruments, automated teller machines, invoicing machines, material testing instruments and machines, batteries and chargers for electronic cigarettes, electric and electronic effects units for musical instruments, laboratory robots, teaching robots, security surveillance robots, humanoid robots with artificial intelligence for use in scientific research, air-conditioning apparatus and installations, ovens, other than for laboratory use, namely, dental ovens, microwave ovens, bakers' ovens, stoves being heating apparatus, solar thermal collectors, chimney flues, chimney blowers, hearths, domestic fireplaces, sterilizers, incinerators, lighting apparatus and installations, namely, luminous tubes for lighting, searchlights, luminous house numbers, vehicle reflectors, lights for vehicles, lamps, namely, electric lamps, gas lamps, laboratory lamps, oil lamps, street lamps, safety lamps, tanning beds, bath installations, bath fittings, bath plumbing fixtures, toilets, urinals, fountains, chocolate fountains, electrically heated pads, cushions and blankets, not for medical purposes, hot water bottles, electrically heated clothing, electric appliances for making yogurt, bread-making machines, coffee machines, ice-cream making machines, ice machines and apparatus enabling customers to conveniently view and purchase those goods, such services may be provided by retail stores, wholesale outlets, by means of electronic media or through mail order catalogues.

(260) AM 2023 120414 A

(800) 1696621

(151) 2022 02 15

(891) 2022 02 15

(731) Orhan Atasay

Üniversite Mahallesi Civan Sokak, Allure

Tower No 1/117 Avcılar, İstanbul,

Türkiye

(540)



(591) Black, red

(531) 26.04.05; 26.04.22; 26.04.24; 26.11.01;

26.11.13; 27.05.01; 27.05.09; 27.05.10;

27.05.12; 28.19; 29.01.13

(511)

7 – Construction equipment: bulldozers, buckets for earth moving machines, excavators, road construction and paving machines, drilling machines, rock drilling machines, sweeping machines and robotic mechanisms with the same function; machinery and robotic mechanisms used in agriculture, animal husbandry, agriculture and grain/fruit/vegetable/food processing, beverage making and processing machinery; bearings, ball or roller bearings; alternators, generators, electric generators, solar powered generators; electric and gas welding machines, electric arc welding devices, electric soldering devices, electric arc cutting devices, electric welding machine electrodes and robots with the same function; packaging machines, fill-plug and seal machines, labeling machines, sorters, and robots and robotic mechanisms (including electrical plastic closing/sealing devices [packing]); pumps without machinery or engine parts (including fuel filling and distribution pumps and their guns); automatic vending machines; electric opening and closing mechanisms for vehicle windows; machines, machine tools and industrial robots for the processing and shaping of wood, metal, glass and plastic materials, extractors for mines; three-dimensional printers; lifting, transporting and conveying machinery: elevators, escalators, cranes, robotic mechanisms with the same function; engines, electric motors, their parts and assemblies, except for land vehicles: hydraulic and pneumatic controls, brakes, brake linings, other than for vehicles, crankshafts, gears, cylinders, pistons, turbines, filters being parts of machines or engines; parts used in land vehicles and included in this class: oil, fuel and air filters for vehicles, exhausts, exhaust manifolds, cylinders for engines, cylinder heads, pistons, carburetors, fuel conversion devices, fuel injectors, fuel saving devices, pumps, valves, starters, dynamos, spark plugs bearings and ball or roller bearings for engines and

motors; tire removal and mounting machines; paint machines, automatic paint spray guns, electric, hydraulic and pneumatic punching machines and guns, electric glue guns, compressed air or spray guns for machines, power drills, chainsaws, jigsaws, spiral machines, compressed air generators, compressors, car wash machines and robots that have the same function as the machines and tools listed above; printing machines; textile machines, sewing machines and industrial robots with the same function; kitchen power tools for chopping, grinding, mashing, whisking and crumbling; washing machines, namely, washing and dishwashing machines, spin dryers [not heated]; electric machines, vacuum cleaners and parts thereof for cleaning floors, carpets or upholstery; galvanizing machines and electrolysis apparatus for electroplating; mechanical cylinder seals for machinery and engines.

9 – Devices for recording, transferring or reproducing sound and image: cameras, cinematographic cameras, televisions, videos, cd-dvd recording and player devices, mp3 players, computers, desktop tablet computers, wearable technological devices, namely, smartwatches, smart wristbands and head-mounted cameras, microphones, speakers, headphones; communication and duplication devices and computer peripheral equipment: mobile phones and their cases, fixed telephones, telephone exchanges, computer printers, scanners, copiers; antennas, satellite dishes, amplifiers and parts thereof; elements used in the electronics of machines and devices: semiconductors, electronic circuits, chips [integrated circuits], diodes, transistors, magnetic heads; electronic locks, photocells, remote control apparatus for opening and closing doors, sensors; protective clothing, protection and life-saving equipment; electrical energy transmission, conversion, storage and control devices and tools: plugs, junction boxes, switches, breakers, fuses, ballasts, battery jump starters, electrical panels, resistors, electric sockets, transformers, adapters, chargers, cables used in electricity, electronics, batteries, accumulators, solar panels for electricity generation; signal bells, luminous or mechanical traffic signs and traffic-light apparatus [signalling devices]; radars, submarine radars (sonars), night vision apparatus and instruments; metronomes; measuring instruments, instruments, including those for science, nautical, topography, meteorology, industrial and laboratory use: non-medical thermometers, barometers, ammeters, voltmeters, humidity meters, test equipment, telescopes, periscopes, compasses; vehicle indicators; materials used in laboratories: microscopes, magnifying glasses, binoculars, experimental materials and devices; magnetic and optical record carriers and computer programs and software recorded on them; electronic publications that can be downloaded via computer networks and recorded on magnetic and optical media; cards with magnetic/optical reader, motion pictures, serials and video music clips recorded on magnetic, optical and electronic media; ticket dispensers, cash machines;

counters and timers that measure the amount of consumption per unit time; eyeglasses, sunglasses, lenses and their cases, cases, parts and accessories for eyeglasses; devices which main function is warning and alarm (except vehicle alarms), namely, warning signs [luminous], security warning apparatus, anti-theft warning apparatus and alarms, electric bells; fire-fighting appliances and devices, namely, fire engines, fire hose and fire pumps; decorative magnets.

11 – Solid, liquid or gaseous fuel and electrical heating devices: combi boilers, boilers, electric heaters, heat exchangers, stoves, cookers; solar thermal collectors [heating]; air conditioning and ventilation devices; electric and gas powered appliances, machines and appliances for cooking, drying and boiling: ovens, electric pots, electric kettles, barbecues, barbecues, electric clothes dryers, hair dryers and hand dryers; water softening equipment, water treatment equipment, water treatment plant, waste treatment plant; filters for aquariums; pasteurizing and sterilizing machines; lighting devices (vehicles, indoor and outdoor lighting fixtures); steam, gas and fog (smoke) generators: steam generators (boilers), acetylene generators, oxygen generators, nitrogen generators; electric coolers and freezers; non-medical electric heating cushions, blankets and heating pads, electric or non-electric foot warmers, hot water bags (thermophores), electrically heated socks; industrial type cooking, drying and cooling installation.

35 – Advertising, marketing and public relations services, organization of exhibitions and fairs for commercial and advertising purposes, development of advertising concepts; provision of an online marketplace for buyers and sellers of goods and services; office functions; secretarial services, arranging newspaper subscriptions for others, compilation of statistics, rental of office machines, systematization of information in computer databases, telephone answering services; business management, administration and consultancy in the field of accounting, personnel job placement, recruitment, personnel selection, personnel supply services, import-export agency services, temporary personnel assignment; invoicing services for others; organization and execution of auctions; the bringing together, for the benefit of others, of a variety of goods, namely, parts of motors and engines of all kinds, namely, starters, mufflers and cylinders for motors and engines of any type, electric cleaning and polishing apparatus, namely, electric shoe polishers, electric machines and apparatus for carpet shampooing and vacuum cleaners, 3d printers, industrial robots, certain special vehicles not for transportation purposes, namely, road sweeping machines, road making machines, bulldozers, snow ploughs, as well as rubber tracks as parts of those vehicles' crawlers, apparatus and instruments for scientific research in laboratories, training apparatus and simulators, namely, resuscitation mannequins, simulators for the steering and control

of vehicles, apparatus and instruments for controlling and monitoring aircraft, watercraft and unmanned vehicles, namely, navigational instruments, transmitters, compasses for measuring, gps apparatus, automatic steering apparatus for vehicles, safety and security apparatus and instruments, namely, safety nets, signalling lights, traffic-light apparatus, fire engines, sound alarms, security tokens being encryption devices, clothing that protects against serious or life-threatening injuries, namely, clothing for protection against accidents, irradiation and fire, bullet-proof clothing, protective helmets, head guards for sports, mouth guards for sports, protective suits for aviators, knee-pads for workers, optical apparatus and instruments, namely, eyeglasses, contact lenses, magnifying glasses, mirrors for inspecting work, peepholes, magnets, smartwatches, wearable activity trackers, joysticks for use with computers, other than for video games, virtual reality headsets, smartglasses, eyeglass cases, cases for smartphones, cases especially made for photographic apparatus and instruments, automated teller machines, invoicing machines, material testing instruments and machines, batteries and chargers for electronic cigarettes, electric and electronic effects units for musical instruments, laboratory robots, teaching robots, security surveillance robots, humanoid robots with artificial intelligence for use in scientific research, air-conditioning apparatus and installations, ovens, other than for laboratory use, namely, dental ovens, microwave ovens, bakers' ovens, stoves being heating apparatus, solar thermal collectors, chimney flues, chimney blowers, hearths, domestic fireplaces, sterilizers, incinerators, lighting apparatus and installations, namely, luminous tubes for lighting, searchlights, luminous house numbers, vehicle reflectors, lights for vehicles, lamps, namely, electric lamps, gas lamps, laboratory lamps, oil lamps, street lamps, safety lamps, tanning beds, bath installations, bath fittings, bath plumbing fixtures, toilets, urinals, fountains, chocolate fountains, electrically heated pads, cushions and blankets, not for medical purposes, hot water bottles, electrically heated clothing, electric appliances for making yogurt, bread-making machines, coffee machines, ice-cream making machines, ice machines and apparatus enabling customers to conveniently view and purchase those goods, such services may be provided by retail stores, wholesale outlets, by means of electronic media or through mail order catalogues.

-
- (260) AM 2023 120415 A
 - (800) 1696792
 - (151) 2022 08 19
 - (891) 2022 08 19
 - (731) Pepco Poland Sp. z o.o.
Strzeszyńska 73A, PL-60-479 Poznań,
Poland

(540)

pepco°

(591) Black, white

(531) 24.17.09; 24.17.25; 26.01.01; 26.01.03;
27.05.01

(511)

35 – Retail and wholesale services in relation to the following goods: toiletries, deodorant and anti-perspirant preparations, oral hygiene preparations, hair goods, water-based personal lubricants, silicone-based personal lubricants, condoms, cosmetic preparations for skin care, makeup; retail and wholesale services in relation to the following goods: cleaning and freshening preparations, sanitary preparations for medical purposes, absorbent articles for personal hygiene, sanitary towels, sanitary tampons, babies' napkins, hair brushes, decorative articles for the hair, hair grips, barrettes (hair slides), hair bands; retail and wholesale services in relation to the following goods: razors, non-electric, hair removal and shaving preparations, nail cosmetics, air fresheners, mosquito repellents for application to the skin, toilet paper in roll form; retail and wholesale services in relation to the following goods: of books, wood for do-it-yourself purposes, adhesives for do-it-yourself purposes, hand tools and implements, hand-operated, paint brushes, arts, crafts and modelling equipment; retail and wholesale services in relation to the following goods: coffee, tea, cocoa, cocoa drinks, milk beverages, non-alcoholic drinks, sparkling soft drinks, fruit juices, non-aerated water, aerated waters, beer and non-alcoholic beer, spirits (beverages), wine, sparkling wine; retail and wholesale services in relation to the following goods: grain-based savoury snacks, corn-based savoury snacks, chocolate confectionery, gum sweets, candy, candy bars and chewing gum, cookies, pastries, pastry preparations, bread biscuits, chocolate, lollipops, jellybeans; retail and wholesale services in relation to the following goods: sauces (condiments), dressings for salad, pasta sauces, ketchup, mayonnaise, mustard, chocolate cream, dairy-based dips, cooked dishes with a vegetable base, ready meals containing rice, ready-made dishes of meat, instant soup, edible spices.

(260) AM 2023 120416 A

(800) 1696848

(151) 2022 08 04

(891) 2022 08 04

(731) 2M Kablo Sanayi Ve Ticaret A.Ş.

Gaziosmanpaşa Osb Mahallesi 4.Cadde,
No: 18 A Çerkezköy, Tekirdağ, Türkiye

(540)

FireKab

(591) Red and white

(531) 01.15.05; 27.05.01; 27.05.07; 29.01.01

(511)

9 – Apparatus and instruments for conducting, transforming, accumulating or controlling electricity; electric cables and electrical power supplies, batteries, electric accumulators; alarms and anti-theft alarms, other than for vehicles, electric bells.

(260) AM 2023 120417 A

(800) 1696969

(151) 2022 10 21

(891) 2022 10 21

(731) Essity Hygiene and Health Aktiebolag

Mölnåls bro 2, SE-405 03 Göteborg, Sweden

(540)

ODORBLOCK

(591) Black, white

(511)

16 – Paper towels; hand towels of paper; face towels of paper; handkerchiefs of paper; paper tissues; paper napkins; bathroom tissues; toilet paper; napkins of paper for removing make-up; wipes made of cellulose or paper; kitchen rolls of paper or cellulose; paper table napkins.

(260) AM 2023 120422 A

(800) 1148676

(151) 2012 10 12

(891) 2022 11 02

(731) Zeyko Tarım Gıda, Sanayi İthalat İhracat

Pazarlama, Limited Şirketi

Organize Sanayi Bölgesi, Aydın, Türkiye

(540)

Loras

(591) Black, white

(531) 27.05.17

(511)

30 – Coffee, cocoa, drinks based coffee and cocoa, drinks based chocolate, macaronis, noodles, pastry and bakery manufactures, desserts confectionery, honey, royal jelly, propolis, spice flavorer for foods, pastes, ferments, baking powders, all kinds of flours, farinas, food starches, granulated sugar, cube sugar, castor sugar, teas, iced teas, toffees, chocolates, biscuits, crackers, wafers, chewing gums, ice creams, edible ice, salt, cereals, processed grains and products, molasses.

(260) AM 2023 120425 A
 (800) 1255169
 (151) 2015 01 21
 (891) 2022 10 27
 (731) Emco spol. s.r.o.
 Türkova 2319/5b, CZ-149 00 Praha
 4 – Chodov, Czech Republic
 (540)



(591) White and red
 (531) 26.01.18; 27.05.03; 29.01.12
 (511)
 30 – Coffee, tea, cocoa, artificial coffee, honey, sugar, golden syrup, rice, tapioca, sago, yeast, pastry, confectionery, porridge oats, corn flakes, chips, muesli, waffles, biscuits, chocolate products, flour and cereal preparations, bread, bakery products, ice cream, baking powder, cereal products for personal consumption, for example cereals for breakfast and flavored cereals made of wheat, rye, barley, oats, maize and rice and flavored with honey, cocoa, nuts, sugar, fruit and chocolate; salt, mustard, vinegar, sauces (condiments), spices, ice for refreshment.

(260) AM 2023 120463 A
 (800) 1697468
 (151) 2022 10 19
 (891) 2022 10 19
 (731) KRKA, Tovarna Zdravil, D.D., Novo mesto
 Šmarješka cesta 6, SI-8000 Novo mesto,
 Slovenia
 (540)

ATOREZAM

(591) Black, white
 (511)
 5 – Pharmaceutical preparations.

(260) AM 2023 120464 A
 (800) 1697469
 (151) 2022 10 19
 (891) 2022 10 19
 (731) KRKA, Tovarna Zdravil, D.D., Novo mesto
 Šmarješka cesta 6, SI-8000 Novo mesto,
 Slovenia
 (540)

COTOLURIN

(591) Black, white
 (511)
 5 – Pharmaceutical preparations.

(260) AM 2023 120475 A
 (800) 1697686
 (151) 2022 10 13
 (891) 2022 10 13
 (731) Japan Tobacco Inc.
 1-1, Toranomom 4-chome, Minato-ku, Tokyo,
 Japan
 (540)



(591) Black, white
 (531) 03.07.01; 03.07.16; 25.07.07; 26.11.01;
 26.11.13; 26.11.14; 27.05.01
 (511)
 34 – Tobacco, raw or manufactured; smoking tobacco, pipe tobacco, rolling tobacco, chewing tobacco, snus; cigarettes, electronic cigarettes, liquid for electronic cigarettes, tobacco vaporizer, cigars, cigarillos; snuff; smokers' articles included in this class; cigarette paper, cigarette tubes and matches.

(260) AM 2023 120476 A
 (800) 1697693
 (151) 2022 10 06
 (891) 2022 10 06
 (731) Acino Pharma AG
 Birsweg 2, CH-4253 Liesberg, Switzerland
 (540)

LIBARTYS

(591) Black, white
 (511)
 5 – Pharmaceutical products; pharmaceutical and veterinary preparations.

(260) AM 2023 120477 A
 (800) 1697694
 (151) 2022 10 26
 (891) 2022 10 26
 (731) Acino Pharma AG
 Birsweg 2, CH-4253 Liesberg, Switzerland
 (540)

Glyfenda

(591) Black, white
 (511)
 5 – Pharmaceutical products; pharmaceutical and veterinary preparations; hygienic products for medical use; dietetic substances for medical use; disinfectants.

(260) AM 2023 120478 A
 (800) 1697709
 (151) 2022 08 23
 (891) 2022 08 23
 (731) Alende Holdings OU
 Kesklinna linnaosa, Rotermanni 6, EE-10111
 Tallinn, Estonia

(540)

Bitguana

(591) Black, white
 (511)
 36 – Accounts receivables financing; debit account services; deposit-taking; deposit-holding; financial administration of deposit taking; deposit accounts services; maintaining mortgage escrow accounts; maintaining escrow accounts for investments; financial assistance; financing and funding services; facilitating and arranging financing; arranging the provision of finance; financial services relating to the securing of funds; financing services; financing services relating to maternity care; financing services relating to hotels; financial guardianship [financial management]; financial trust management; providing information relating to trusteeship of financial futures contracts; financial management via the internet; arranging the provision of finance; financial information, data, advice and consultancy services; financial investment; financial investment; providing information and analysis via the internet in the field of financial investments; financial management; financial management services relating to convalescent institutions; financial loss management; raising of financial capital; provision of financial protection against foreign exchange risks; account debiting services; financial banking; financial services provided via the internet; financial management services provided via the internet; provision of investment capital; financial investment; virtual currency transfer services.

(260) AM 2023 120479 A
 (800) 1697739
 (151) 2022 05 30
 (891) 2022 05 30
 (731) Limited liability company "Suncity"
 Zavodskoy dr., 1, H13 apt., 10 rm., Ryazan,
 RU-390013 Ryazan region, Russian Federation

(540)



(591) Black, white
 (531) 24.01.05; 27.01.01; 27.05.01; 27.05.09;
 27.05.10; 27.05.22

(511)
 25 – Mittens; caps being headwear; visors being headwear; fingerless gloves; ear muffs [clothing]; gloves [clothing]; scarfs; headscarfs; headbands [clothing]; money belts [clothing]; headwear; hats.

(260) AM 2023 120483 A
 (800) 1697894
 (151) 2022 09 19
 (891) 2022 09 19
 (731) Branq UK Limited
 Redland house 157 Redland road, Redland,
 Bristol BS6 6YE, United Kingdom

(540)



(591) Green
 (531) 05.05.20; 05.05.21; 27.05.01; 27.05.10;
 29.01.03

(511)
 8 – Glaziers' diamonds [parts of hand tools]; apparatus for tattooing; laser hair removal apparatus, other than for medical purposes; razors, electric or non-electric; sharpening steels; scythe stones; gimlets [hand tools]; borers; augers [hand tools]; carpenters' augers; pickhammers; weeding forks [hand tools]; carving forks; table forks; agricultural forks [hand tools]; lawn clippers [hand instruments]; harpoons; harpoons for fishing; nail extractors, hand-operated; rakes [hand tools]; sand trap rakes; cutter bars [hand tools]; whetstone holders; priming irons [hand tools]; sculptors' chisels; lifting jacks, hand-operated; hand drills, hand-operated; truncheons; clamps for carpenters or coopers; spades [hand tools]; rabbeting planes; chisels; engraving needles; tattoo needles; cutlery; edge tools [hand tools]; choppers being knives; garden tools, hand-operated; abrading instruments [hand instruments]; numbering punches; goffering irons; implements for decanting liquids [hand tools]; depilation appliances, electric and non-electric; sharpening instruments; blade sharpening instruments; livestock marking tools; nail clippers, electric or non-electric; oyster openers; polishing irons [glazing tools]; ear-piercing apparatus; tube cutting instruments; wire strippers [hand tools]; riveters [hand tools]; expanders [hand tools]; cutters; cutting tools [hand tools]; ski edge sharpening tools, hand-operated; hand tools, hand-operated; sterile body piercing instruments; stamping-out tools [hand tools]; picks [hand tools]; sharpening stones; punch rings [knuckle dusters]; trowels; centre punches [hand tools]; daggers; pickaxes; mallets [hand instruments]; pliers; punch pliers [hand tools];

blades [weapons]; annular screw plates; spanners [hand tools]; tap wrenches; ladles [hand tools]; foundry ladles [hand tools]; meat claws; breast drills; lasts [shoemakers' hand tools]; scythe rings; instruments for punching tickets; diggers [hand tools]; rams [hand tools]; scythes; hainault scythes; fire irons; emery grinding wheels; grindstones [hand tools]; sledgehammers; thistle extractors [hand tools]; nail nippers; tree pruners; nail drawers [hand tools]; ice picks; blades [hand tools]; razor blades; blades for planes; plane irons; jig-saws; spoons; table knives, forks and spoons for babies; table knives, forks and spoons of plastic; crow bars; trowels [gardening]; shovels [hand tools]; palette knives; machetes; beard clippers; hair clippers for personal use, electric and non-electric; hair clippers for animals [hand instruments]; taps [hand tools]; fireplace bellows [hand tools]; swords; hammers [hand tools]; emergency hammers; fullers [hand tools]; stone hammers; masons' hammers; riveting hammers [hand tools]; mattocks; ditchers [hand tools]; manicure sets; manicure sets, electric; pedicure sets; needle files; bits [hand tools]; files [tools]; emery files; air pumps, hand-operated; hand pumps; shaving cases; knives; mincing knives; cheese slicers, non-electric; fruit segmenters; egg slicers, non-electric; vegetable knives; pizza cutters, non-electric; scaling knives; hobby knives [scalpels]; fruit corers; moulding irons; ceramic knives; tin openers, non-electric; farriers' knives; multipurpose knives; budding knives; hunting knives; penknives; grafting tools [hand tools]; carving knives; braiders [hand tools]; box cutters; bill-hooks; paring knives; cleavers; scissors; wick trimmers [scissors]; shears; cattle shearers; border shearers; pruning shearers; shearers [hand instruments]; sword scabbards; kitchen mandolines; vegetable slicers, hand-operated; vegetable spiralizers, hand-operated; vegetable peelers, hand-operated; agricultural implements, hand-operated; side arms, other than firearms; stropping instruments; screwdrivers, non-electric; hand-operated corn cob strippers; sabres; stirring sticks for mixing paint; reamer sockets; drill holders [hand tools]; perforating tools [hand tools]; rammers [hand tools]; emery boards; nail files; nail files, electric; saws [hand tools]; bow saws; tweezers; hair-removing tweezers; guns [hand tools]; non-electric caulking guns; guns, hand-operated, for the extrusion of mastics; dies [hand tools]; fruit pickers [hand tools]; saw blades [parts of hand tools]; shear blades; tool belts [holders]; hair braiders, electric; table cutlery [knives, forks and spoons]; crimping irons; hand implements for hair curling; vegetable choppers; money scoops; instruments and tools for skinning animals; fingernail polishers, electric or non-electric; hackles [hand tools]; pin punches; nail punches; fish tapes [hand tools]; food processors, hand-operated; punches [hand tools]; insecticide vaporizers [hand tools]; syringes for spraying insecticides; reamers; frames for handsaws; saw holders; rasps [hand tools]; paring irons [hand tools]; graving tools [hand tools];

milling cutters [hand tools]; razor strops; leather strops; planes; scythe handles; knife handles; handles for hand-operated hand tools; levers; marline spikes; bits [parts of hand tools]; hollowing bits [parts of hand tools]; pruning scissors; silver plate [knives, forks and spoons]; pruning knives; sickles; drawing knives; scrapers [hand tools]; scrapers for skis; mortise chisels; caulking irons; gouges [hand tools]; mortars for pounding [hand tools]; mitre boxes [hand tools]; branding irons; hatchets; adzes [tools]; vices; bench vices [hand implements]; hoop cutters [hand tools]; axes; holing axes; fulling tools [hand tools]; earth rammers [hand tools]; tube cutters [hand tools]; hoes [hand tools]; squares [hand tools]; extension pieces for braces for screw taps; embossers [hand tools]; apparatus for destroying plant parasites, hand-operated; metal wire stretchers [hand tools]; metal band stretchers [hand tools]; flat irons; irons [non-electric hand tools]; hand-operated fruit slicers; razor cases; ratchets [hand tools]; scraping tools [hand tools]; awls; spatulas [hand tools]; spatulas for use by artists; wine bottle foil cutters, hand-operated; bayonets; pin-cers; curling tongs; cuticle tweezers; eyelash curlers.

19 – Aquaria [structures]; alabaster; door frames, not of metal; asbestos cement; asphalt; beams, not of metal; balustrades, not of metal; huts; swimming pools [structures], not of metal; silos, not of metal; arbours [structures], not of metal; concrete; bitumen; plastic landscape edgings; joists, not of metal; telephone booths, not of metal; beacons, not of metal, non-luminous; building paper; busts of stone, concrete or marble; bird baths [structures], not of metal; binding agents for making briquettes; binding material for road repair; stained-glass windows; felt for building; aviaries [structures], not of metal; gates, not of metal; diving boards, not of metal; geotextiles; gypsum [building material]; plaster; clay; potters' clay; earth for bricks; roofing shingles; gravel; aquarium gravel; granite; tar; armoured doors, not of metal; doors, not of metal; swing doors, not of metal; accordion doors, not of metal; folding doors, not of metal; coal tar; chimney pots, not of metal; prefabricated houses [kits], not of metal; parquet floor boards; floating floor boards, not of metal; memorial plaques, not of metal; wood for making household utensils; veneer wood; mouldable wood; chimney shafts, not of metal; jalousies, not of metal; roof gutters, not of metal; street gutters, not of metal; agglomerated bagasses of cane [building material]; road signs, non-luminous and non-mechanical, not of metal; non-luminous and non-mechanical signs, not of metal; limestone; lime; fences, not of metal; works of stonemasonry; works of art of stone, concrete or marble; cabanas, not of metal; soundproof booths, transportable, not of metal; stone; rubble; artificial stone; building stone; paint spraying booths, not of metal; gravestones; reeds for building; horticultural frames, not of metal; framework, not of metal, for building; greenhouse frames, not of metal; cornices, not of metal; bitumen paper for building; wood pulp bo-

ard for building; paperboard for building; skating rinks [structures], not of metal; quartz; caissons for construction work under water; bricks; firebricks; water-pipe valves, not of metal or plastic; drain traps [valves], not of metal or plastic; cask wood; mooring bollards, not of metal; cement posts; pillars, not of metal, for building; chimney cowls, not of metal; brackets, not of metal, for building; buildings, not of metal; buildings, transportable, not of metal; stringers [parts of staircases], not of metal; silica [quartz]; roofing, not of metal; roofing, not of metal, incorporating photovoltaic cells; manhole covers, not of metal; xylolith; chicken-houses, not of metal; manufactured timber; sawn timber; building timber; wood, semi-worked; staircases, not of metal; road marking sheets and strips of synthetic material; reinforcing materials, not of metal, for building; bituminous products for building; road coating materials; materials for making and coating roads; fireclay; pitch; building materials, not of metal; refractory construction materials, not of metal; masts [poles], not of metal; raw chalk; calcareous marl; mosaics for building; mouldings, not of metal, for building; marble; slate powder; porches [structures], not of metal; tombs, not of metal; flashing, not of metal, for building; roof flashing, not of metal; perches; duckboards, not of metal; wall claddings, not of metal, for building; mouldings, not of metal, for cornices; coatings [building materials]; tomb or grave enclosures, not of metal; laths, not of metal; wood panelling; wall linings, not of metal, for building; palings, not of metal; crash barriers, not of metal, for roads; latticework, not of metal; windows, not of metal; olivine for building; shuttering, not of metal, for concrete; posts, not of metal, for power lines; props, not of metal; rubber bearings for seismic isolation of buildings; branching pipes, not of metal; fair huts; tombs [monuments], not of metal; monuments, not of metal; acoustic panels, not of metal; wainscotting, not of metal; signalling panels, non-luminous and non-mechanical, not of metal; building panels, not of metal; parquet flooring; partitions, not of metal; lintels, not of metal; casement windows, not of metal; aquarium sand; play sand; silver sand; sand, except foundry sand; sandstone for building; tarred strips for building; planks of wood for building; rocket launching platforms, not of metal; platforms, prefabricated, not of metal; wall tiles, not of metal; floor tiles, not of metal; tiles, not of metal, for building; paving slabs, not of metal; cement slabs; grave slabs, not of metal; tile floorings, not of metal; slabs, not of metal, for building; scaffolding, not of metal; armour-plating, not of metal; asphalt paving; wood paving; paving blocks, not of metal; luminous paving blocks; macadam; fireproof cement coatings; bituminous coatings for roofing; roof coverings, not of metal; wooden floor boards; cladding, not of metal, for building; linings, not of metal, for building; fireplace mantles, not of metal; door panels, not of metal; floors, not of metal; sills, not of metal; porphyry [stone]; ceilings, not of metal; floating

docks, not of metal, for mooring boats; agglomerated cork for building; window frames, not of metal; mortar for building; asbestos mortar; tanks of masonry; scantlings [carpentry]; furrings of wood; vinyl siding; pilings, not of metal; pigsties, not of metal; insect screens, not of metal; burial vaults, not of metal; schists; outdoor blinds, not of metal and not of textile; shutters, not of metal; statues of stone, concrete or marble; alabaster glass; safety glass; glass granules for road marking; window glass for building; window glass, other than vehicle window glass; building glass; plate glass [windows] for building; insulating glass for building; enamelled glass, for building; tombstone stelae, not of metal; stables, not of metal; advertisement columns, not of metal; posts, not of metal; telegraph posts, not of metal; hips for roofing; stair-treads [steps], not of metal; tombstone plaques, not of metal; greenhouses, transportable, not of metal; terra-cotta [building material]; penstock pipes, not of metal; water-pipes, not of metal; gutter pipes, not of metal; ducts, not of metal, for ventilating and air-conditioning installations; drain pipes, not of metal; chimneys, not of metal; rigid pipes, not of metal, for building; sandstone pipes; turnstiles, not of metal; tufa; angle irons, not of metal; lengthening pieces, not of metal, for chimneys; bicycle parking installations, not of metal; plywood; figurines of stone, concrete or marble; flagpoles [structures], not of metal; foundry moulds, not of metal; rock crystal; cement; cement for blast furnaces; cement for furnaces; magnesia cement; pantiles, not of metal; roofing tiles, not of metal; slate; roofing slates; slag [building material]; slag stone; railway sleepers, not of metal; wood veneers; clinker ballast; concrete building elements; letter boxes of masonry.

20 – Picture frame brackets; recycling bins, not of metal; bottles [containers], not of metal, for compressed gas or liquid air; bamboo, unworked or semi-worked; bumper guards for cots, other than bed linen; reels, not of metal, non-mechanical, for flexible hoses; sew-on tags of plastic or rubber for clothing; pulleys of plastics for blinds; bolts, not of metal; casks of wood for decanting wine; mooring buoys, not of metal; casks, not of metal; barrels, not of metal; identification bracelets, not of metal; sideboards; busts of wood, wax, plaster or plastic; costume stands; bolsters; fans for personal use, non-electric; work benches; vice benches [furniture]; valet stands; coatstands; coat hangers; shoulder poles [yokes]; screws, not of metal; display stands; showcases [furniture]; newspaper display stands; jewellery organizer displays; removable covers for sinks; collars, not of metal, for fastening pipes; comb foundations for beehives; signboards of wood or plastics; loading gauge rods, not of metal, for railway wagons; nuts, not of metal; covers for clothing [wardrobe]; shoe pegs, not of metal; nesting boxes; coffins; doors for furniture; curtain holders, not of textile material; dowels, not of metal; divans; towel dispensers, fixed, not of metal; door closers, not of

metal, non-electric; kennels for household pets; bird-houses; keyboards for hanging keys; display boards; plugs [dowels], not of metal; containers, not of metal, for liquid fuel; troughs, not of metal, for mixing mortar; oil drainage containers, not of metal; packaging containers of plastic; indoor window blinds [furniture]; indoor window blinds of paper; indoor window blinds of woven wood; indoor window blinds of textile; flower-stands [furniture]; curtain tie-backs; clips, not of metal, for cables and pipes; binding screws, not of metal, for cables; clips of plastic for sealing bags; rivets, not of metal; imitation tortoiseshell; locks, not of metal, for vehicles; padlocks, other than electronic, not of metal; locks, other than electric, not of metal; bead curtains for decoration; door bolts, not of metal; bottle closures, not of metal; closures, not of metal, for containers; latches, not of metal; mirrors [looking glasses]; hand-held mirrors [toilet mirrors]; number-plates, not of metal; scratching posts for cats; animal claws; animal hooves; coral; meerschaum; whalebone, unworked or semi-worked; stag antlers; tortoiseshell; horn, unworked or semi-worked; animal horns; rattan; corozo; plaited straw, except matting; wickerwork; hampers [baskets] for the transport of items; works of art of wood, wax, plaster or plastic; cabinet work; reeds [plaiting materials]; settees; jerrycans, not of metal; curtain rods; index cabinets [furniture]; reels of wood for yarn, silk, cord; drain traps [valves] of plastic; water-pipe valves of plastic; valves, not of metal, other than parts of machines; staves of wood; plastic keys; plastic key cards, not encoded and not magnetic; mats for infant playpens; reusable baby changing mats; sleeping pads; mats, removable, for sinks; saw horses; bed casters, not of metal; furniture casters, not of metal; brush mountings; chopping blocks [tables]; wind chimes [decoration]; door bells, not of metal, non-electric; bottle caps, not of metal; bassinets; tent pegs, not of metal; curtain rings; split rings, not of metal, for keys; chests of drawers; console tables; waste dumpsters, not of metal, other than for medical use; containers, not of metal [storage, transport]; floating containers, not of metal; lecterns; dog kennels; bakers' bread baskets; baskets, not of metal; moses baskets; bottle casings of wood; tool boxes, not of metal, empty; taps, not of metal, for casks; armchairs; hairdressers' chairs; deck chairs; beds; hospital beds; waterbeds, not for medical purposes; bedsteads of wood; air beds, not for medical purposes; cots for babies; edgings of plastic for furniture; brackets, not of metal, for furniture; screw tops, not of metal, for bottles; table tops; sash fasteners, not of metal, for windows; coathooks, not of metal; curtain hooks; clothes hooks, not of metal; bag hangers, not of metal; beds for household pets; nesting boxes for household pets; ladders of wood or plastics; playpens for babies; tailors' dummies; mattresses; air mattresses, not for medical purposes; camping mattresses; furniture; furniture of metal; inflatable furniture; office furniture; school furniture; mobiles [decoration]; door knockers, not of me-

tal; shoe dowels, not of metal; curtain rails; runners, not of metal, for sliding doors; legs for furniture; feet for furniture; house numbers, not of metal, non-luminous; cask hoops, not of metal; door stops, not of metal or rubber; window stops, not of metal or rubber; hanging closet organizers; mouldings for picture frames; bed bases; plastic ramps for use with vehicles; furniture partitions of wood; freestanding partitions [furniture]; mother-of-pearl, unworked or semi-worked; ambroid plates; loading pallets, not of metal; handling pallets, not of metal; transport pallets, not of metal; mirror tiles; head-rests [furniture]; trays, not of metal; stakes, not of metal, for plants or trees; trestles [furniture]; magazine racks; book rests [furniture]; stands for calculating machines; pet cushions; pillows; cushions; cushions for lining pet crates; head support cushions for babies; anti-roll cushions for babies; air cushions, not for medical purposes; air pillows, not for medical purposes; head positioning pillows for babies; racks [furniture]; library shelves; shelves for file cabinets; furniture shelves; plate racks [furniture]; shelves for storage; wood ribbon; straw edgings; towel stands [furniture]; hat stands; bathtub grab bars, not of metal; cask stands, not of metal; inflatable publicity objects; counters [tables]; bedding, except linen; corks for bottles; corks; stoppers, not of glass, metal or rubber; sealing caps, not of metal; stair rods; flower-pot pedestals; standing desks; embroidery frames; dispensers for dog waste bags, fixed, not of metal; drawer organizers; shells; picture frames; sections of wood for beehives; crucifixes of wood, wax, plaster or plastic, other than jewellery; containers, not of metal, for compressed gas or liquid air; reservoirs, not of metal nor of masonry; fodder racks; curtain rollers; door handles, not of metal; knobs, not of metal; fishing baskets; writing desks; bath seats for babies; seats of metal; benches [furniture]; vats, not of metal; honeycombs; sofas; plugs, not of metal; statues of wood, wax, plaster or plastic; oyster shells; silvered glass [mirrors]; shelving units; ambroid bars; umbrella stands; gun racks; trolleys for computers [furniture]; lap desks; dressing tables; washstands [furniture]; tables; typing desks; massage tables; tables of metal; wall-mounted baby changing platforms; saw benches [furniture]; desks; portable desks; tea trolleys; dinner wagons [furniture]; drafting tables; steps [ladders], not of metal; step stools, not of metal; chairs [seats]; high chairs for babies; shower chairs; chests, not of metal; placards of wood or plastics; nameplates, not of metal; stools; bathroom stools; footstools; crates; trolleys [furniture]; straw plaits; mobile boarding stairs, not of metal, for passengers; straw mattresses; decorations of plastic for foodstuffs; beehives; bathroom vanities [furniture]; door fasteners, not of metal; window fasteners, not of metal; funerary urns; window closers, not of metal, non-electric; door openers, not of metal, non-electric; window openers, not of metal, non-electric; winding spools, not of metal, non-mechanical, for flexible hoses; figurines of wood, wax,

plaster or plastic; hand-held flagpoles, not of metal; door fittings, not of metal; coffin fittings, not of metal; bed fittings, not of metal; furniture fittings, not of metal; window fittings, not of metal; infant walkers; garment covers [storage]; covers specially made for handling and transport of bottles, not of metal, for compressed gas; stuffed animals; stuffed birds; hinges, not of metal; chaise longues; poles, not of metal; screens [furniture]; luggage lockers; filing cabinets; medicine cabinets; lockers [furniture]; meat safes; bookcases; kitchen dressers [furniture]; wardrobes; cupboards; window pulleys, not of metal; bamboo curtains; slatted indoor blinds; sneeze guards; screens for fireplaces [furniture]; labels of plastic; yellow amber; drawers for furniture; chests for toys; tool chests, not of metal, empty; boxes of wood or plastic; letter boxes, not of metal or masonry; bottle racks.

21 – Autoclaves, non-electric, for cooking; indoor aquaria; wine aerators; buckets; automatic opening and closing trash cans; cookie jars; candle jars [holders]; china ornaments; dishes; vegetable dishes; saucers; boxes for sweets; bottles; demijohns; busts of porcelain, ceramic, earthenware, terra-cotta or glass; vases; epergnes; fruit bowls; inflatable bath tubs for babies; bird baths; baby baths, portable; plungers for clearing blocked drains; waffle irons, non-electric; diaper disposal pails; ice buckets; mop wringer buckets; buckets made of woven fabrics; whisks, non-electric, for household purposes; cooking skewers of metal; towel rails and rings; clothing stretchers; barbecue forks; serving forks; hair for brushes; horsehair for brush-making; funnels; pie funnels; candle warmers, electric and non-electric; carpet beaters [hand instruments]; signboards of porcelain or glass; candle extinguishers; heads for electric toothbrushes; flower pots; chamber pots; glue-pots; cruets; decanters; large-toothed combs for the hair; combs for animals; tea cosies; abrasive sponges for scrubbing the skin; bath sponges; make-up sponges; sponges for household purposes; sponge holders; stands for portable baby baths; toothpick holders; soap holders; table napkin holders; holders for flowers and plants [flower arranging]; tea bag rests; shaving brush stands; toilet paper holders; toilet paper dispensers; soap dispensers; plug-in diffusers for mosquito repellents; aromatic oil diffusers, other than reed diffusers, electric and non-electric; ironing boards; cutting boards for the kitchen; bread boards; washing boards; crushers for kitchen use, non-electric; strainers for household purposes; smoke absorbers for household purposes; containers for household or kitchen use; kitchen containers; glass jars [carboys]; heat-insulated containers; heat-insulated containers for beverages; thermally insulated containers for food; glass flasks [containers]; closures for pot lids; chamois leather for cleaning; toothpicks; ceramics for household purposes; majolica; works of art of porcelain, ceramic, earthenware, terra-cotta or glass; kitchen grinders, non-electric; cleaning instruments, hand-operated; cabarets [trays]; stew-pans; co-

uscous cooking pots, non-electric; cooking pots, non-electric; flower-pot covers, not of paper; shaving brushes; make-up brushes; cages for household pets; bird-cages; cages for collecting insects; baking mats; ladles for serving wine; polishing leather; hot pots, not electrically heated; glass bulbs [receptacles]; shoe trees; napkin rings; poultry rings; rings for birds; disposable aluminium foil containers for household purposes; coin banks; piggy banks; bread baskets for household purposes; baskets for household purposes; waste paper baskets; feeding troughs; pet feeding bowls, automatic; mangers for animals; lunch boxes; insect collectors' boxes; tea caddies; washtubs; earthenware saucepans; mess-tins; cauldrons; coffee percolators, non-electric; coffeepots, non-electric; coffee grinders, hand-operated; mugs; beer mugs; tankards; rat traps; pot lids; aquarium hoods; butter-dish covers; dish covers; cheese-dish covers; reusable silicone food covers; buttonhooks; reusable ice cubes; jugs; perfume burners; watering cans; fly traps; insect traps; ice cream scoops; mixing spoons [kitchen utensils]; basting spoons [cooking utensils]; serving spoons; pie servers; spatulas for kitchen use; valet trays [receptacles for small objects] for household purposes; litter boxes for pets; butter dishes; material for brush-making; polishing materials for making shiny, except preparations, paper and stone; tablemats, not of paper or textile; noodle machines, hand-operated; lint removers, electric or non-electric; pasta makers, hand-operated; polishing apparatus and machines, for household purposes, non-electric; pepper mills, hand-operated; mills for household purposes, hand-operated; feather-dusters; brooms; isothermic bags; decorating bags for confectioners; cooking mesh bags, other than for microwaves; bowls [basins]; pet feeding bowls; soup bowls; mosaics of glass, not for building; dishcloths; saucepan scourers of metal; soap boxes; mouse traps; meat grinders, non-electric; cooking pot sets; nozzles for watering cans; pouring spouts; wine pourers; cake decorating tips and tubes; nozzles for watering hose; fitted picnic baskets, including dishes; toilet cases; floss for dental purposes; fibreglass thread, other than for textile use; cookie [biscuit] cutters; pastry cutters; sprinklers; syringes for watering flowers and plants; egg yolk separators; cotton waste for cleaning; wool waste for cleaning; cleaning tow; cold packs for chilling food and beverages; chopsticks; cocktail stirrers; food steamers, non-electric; pepper pots; abrasive mitts for scrubbing the skin; oven mitts; animal grooming gloves; gloves for household purposes; car washing mitts; polishing gloves; gardening gloves; pestles for kitchen use; droppers for household purposes; wine-tasting pipettes; droppers for cosmetic purposes; plates for diffusing aromatic oil; plates to prevent milk boiling over; dripping pans; trays for household purposes; trays of paper, for household purposes; lazy susans; heaters for feeding bottles, non-electric; candelabra [candlesticks]; trivets [table utensils]; coasters, not of paper or textile; grill supports; menu card

holders; knife rests for the table; mats, not of paper or textile, for beer glasses; flat-iron stands; egg cups; abrasive pads for kitchen purposes; scouring pads; drinking troughs; serving ladles; powdered glass for decoration; pottery; pots; vessels for making ices and ice cream, non electric; painted glassware; tableware, other than knives, forks and spoons; porcelain ware; earthenware; crystal [glassware]; cosmetic utensils; trouser presses; tortilla presses, non-electric [kitchen utensils]; tube squeezers for household purposes; fruit presses, non-electric, for household purposes; deodorizing apparatus for personal use; cruet sets for oil and vinegar; make-up removing appliances; spice sets; apparatus for wax-polishing, non-electric; bottle openers, electric and non-electric; glove stretchers; boot jacks; crumb trays; tie presses; potholders; clothes-peg; glass stoppers; roaster pans; powder compacts, empty; perfume vaporizers; powder puffs; dusting apparatus, non-electric; foam toe separators for use in pedicures; combs; electric combs; grills [cooking utensils]; sifters [household utensils]; drinking horns; shoe horns; candle drip rings; broom handles; salad bowls; place mats, not of paper or textile; beverage urns, non-electric; sugar bowls; beaters, non-electric; egg separators, non-electric, for household purposes; services [dishes]; coffee services [tableware]; liqueur sets; tea services [tableware]; sieves [household utensils]; cinder sifters [household utensils]; tea strainers; siphon bottles for carbonated water; rolling pins, domestic; frying pans; squeegees [cleaning instruments]; steel wool for cleaning; currycombs; smart medicine bottles, sold empty; blenders, non-electric, for household purposes; scoops for household purposes; straws for drinking; salt cellars; drinking vessels; refrigerating bottles; bulb basters; cups of paper or plastic; glasses [receptacles]; drinking glasses; statues of porcelain, ceramic, earthenware, terra-cotta or glass; figurines of porcelain, ceramic, earthenware, terra-cotta or glass; glass for vehicle windows [semi-finished product]; fused silica [semi-worked product], other than for building; plate glass [raw material]; opal glass; glass, unworked or semi-worked, except building glass; opaline glass; glass incorporating fine electrical conductors; enamelled glass, not for building; glass wool, other than for insulation; vitreous silica fibres, other than for textile use; fibreglass, other than for insulation or textile use; mortars for kitchen use; portable cool boxes, non-electric; soup tureens; drying racks for laundry; rotary washing lines; tajines, non-electric; basins [receptacles]; table plates; paper plates; disposable table plates; graters for kitchen use; insulating flasks; indoor terrariums [plant cultivation]; indoor terrariums [vivariums]; roller tubes for peeling garlic; cloth for washing floors; polishing cloths; cloths for cleaning; dusting cloths [rags]; furniture dusters; wax-polishing appliances, non-electric, for shoes; water apparatus for cleaning teeth and gums; electric devices for attracting and killing insects; watering devices; ultrasonic pest repellers; utensils for

household purposes; kitchen utensils; cooking utensils, non-electric; figurines of porcelain, ceramic, earthenware, terracotta or glass for cakes; coffee filters, non-electric; flasks; water flossers; hip flasks; drinking bottles for sports; boot trees; moulds [kitchen utensils]; egg poachers; cake moulds; baking cases of paper; baking cases of silicone; ice cube moulds; cookery moulds; deep fryers, non-electric; comb cases; bread bins; fly swatters; teapots; kettles, non-electric; cups; garlic presses [kitchen utensils]; ironing board covers, shaped; tea infusers; decorative glass spheres; mops; mop wringers; cocktail shakers; cosmetic spatulas; cosmetic stamps, sold empty; corkscrews, electric and non-electric; animal bristles [brushware]; pig bristles for brush-making; brushes; sound wave vibration hairbrushes; dishwashing brushes; ski wax brushes; brushes for cleaning tanks and containers; lamp-glass brushes; horse brushes; scrubbing brushes; toothbrushes; toothbrushes, electric; basting brushes; carpet sweepers; shoe brushes; tar-brushes, long handled; toilet brushes; electric brushes, except parts of machines; eyebrow brushes; nail brushes; eyelash brushes; barbecue tongs; nutcrackers; ice tongs; salad tongs; sugar tongs; decanter tags; nest eggs, artificial; boxes for dispensing paper towels; dustbins; window-boxes; boxes of glass.

(260) AM 2023 120484 A
 (800) 1161191
 (151) 2013 04 11
 (891) 2022 10 27
 (731) Oy Karl Fazer AB
 Fazerintie 6, FI-01230 Vantaa, Finland
 (540)



(591) Blue, light blue and white
 (531) 01.01.02; 01.01.09; 01.15.09; 26.01.03;
 26.11.12; 26.15.01; 29.01.12

(511)
 29 – Meat, fish, poultry and game; meat extracts; preserved, frozen, dried and cooked fruits and vegetables; jellies, jams, compotes; eggs; milk and milk products; edible oils and fats.

30 – Coffee, tea, cocoa and artificial coffee; rice; tapioca and sago; flour and preparations made from cereals; bread, pastry and confectionery; ices; sugar, honey, treacle; yeast, baking-powder; salt; mustard; vinegar, sauces (condiments); spices; ice; pastilles; chewing gum; muesli bars.

32 – Beers; mineral and aerated waters and other non-alcoholic beverages; fruit beverages and fruit juices; syrups and other preparations for making beverages.

(260) AM 2023 120536 A

(800) 1697974

(151) 2022 05 13

(891) 2022 05 13

(731) Trive Investment B.V.

Claude Debussylaan 46, NL-1082 MD

Amsterdam, Netherlands

(540)

TRIVE

(591) Black, white

(511)

35 – Business assistance, management and administrative services; administrative support and data processing services; business consultancy and advisory services; human resources management and recruitment services; administration of foreign business affairs; arranging of business introductions; business management of insurance agencies and brokers on an outsourcing basis; business management organisation; business organisation; business process management and consulting; business project management; office functions services; preparation of economic reports; drawing up statistics; advisory services relating to commercial transactions; arranging of commercial and business contacts; arranging of trading transactions and commercial contracts; bidding quotation; business intermediary services relating to the matching of potential private investors with entrepreneurs needing funding; foreign trade information and consultation; negotiation and conclusion of commercial transactions for third parties; negotiation and conclusion of commercial transactions for third parties via telecommunication systems; price analysis services; provision of information concerning commercial sales; providing information relating to tax preparation and tax filing services; business administration; office functions; business investigations; economic forecasting and analysis for business and financial purposes; market analysis; market research and market studies for business and financial purposes; arranging commercial studies and compiling commercial reports; information and data compiling and analysing relating to business management.

36 – Financial services; monetary affairs; brokerage services, including investment brokerage; pawn brokerage; exchange brokerage; money brokerage; insurance brokerage; commodities brokerage; credit brokerage; mortgage brokerage; stock brokerage; bonds brokerage; securities brokerage; traded options brokerage; brokerage of currency; brokerage of futures; capital investment brokerage; brokerage of bonds; insurance; insurance of credit risks (factoring); banking services, including mortgages; services of securities

houses, money transfer; capital and fund investment; services in the field of finance, loans, credit and mortgage payments; automated banking services; payment services, namely, providing electronic processing of electronic funds transfer, ach, credit card, debit card, electronic check and electronic payments; private banking services; telebanking; internet banking; banking via mobile telephones or by other electronic communication means, including the internet; financial information; savings services; trading of securities; clearing and execution of financial securities transactions; securities exchange services; trading of securities options; overseas market securities futures; brokerage services with regard to the purchase and sale of and investment of bonds, shares, stocks and other such securities; property management; securities underwriting; securities trade execution services; handling subscriptions and offerings of securities; trading of securities index futures; private equity financial investments, private equity investment funds, private equity financing; trading of equities, equity derivatives, futures, stocks, shares, swaps and options; lease-purchase financing, insurance and financial mediation with regard to insurance and insurance underwriting; providing of guarantees; investment companies and funds; financial transactions; financial consultancy and information; electronic stock exchange services and electronic financial trading services utilizing internal financial crossing exchanges and networks; assistance, advice and consultancy in the field of financial planning, analysis, management and organisation; financial research, evaluations; surveys, information and research; arranging financial studies and compiling financial reports; fiscal assessments, valuations and consultancy relating thereto; real estate agency services relating to negotiation in the purchase and sale of real estate, real estate management and appraisal; services in the field of mortgages and mortgaging of movable property and real estate; financial services relating to automated methods for crossing and other payment order processing; providing stock market information; payment and credit services; hire-purchase financing; issuance of credit cards, debit cards, payment cards, chip payment cards and bank cards and financial services for the management of credit cards, debit cards, payment cards, chip cards and bank cards; cash management; safety deposit services; bankers clearing services; making debit and credit entries for book-keeping purposes; cheque encashment services; insurance services; financing of loans; financing of loans against security, including margin lending of stocks; financial investment; investment management; capital investment services; trustee services; financial management services; agency services and brokerage of bonds and other securities; investment advice; research into and evaluation of credit worthiness; financial guarantees (surety services); financial analysis and preparation of financial reports; financial research services; financing services (securing funds for ot-

hers); administration of financial affairs; computerised financial services; acceptance of deposits; lending securities, acquisition and transfer of monetary claims; money exchange and foreign exchange transactions, currency exchange services; financial management of a financing company; financial participation in partnerships, enterprises, institutions and organisations; financial affairs on behalf of subsidiary companies and holdings; provision of information, advisory and consultancy services relating to all of the aforesaid services; the aforesaid services whether or not via electronic channels, including the internet; providing purchase protection services for goods and services purchased by others via a global computer network and wireless networks, namely, providing fraud reimbursement services in the field of credit card purchases and electronic payment purchases, and providing secure commercial transactions for credit card purchases and electronic payment purchases; credit card transaction processing services; bill payments services; providing electronic mobile payment services for others in the nature of providing secure commercial transactions and payment options using a mobile device at a point of sale; credit card transaction processing services and payment processing services in the field of credit card payments and electronic payments; financial risk management services, namely, financial analysis of transactions for payment fraud or illegality, compliance in the nature of analysing transactions for compliance with payment transaction regulations, and anti-fraud and money laundering controls in the nature of financial analysing transactions for fraud and illegal monetary transactions; stored value card and debit card services in the nature of electronic debit card transaction processing and processing electronic payments made through prepaid cards.

41 – Providing electronic and on-line publications; publication of educational and training guides and teaching materials; education services in the field of banking, finance, brokerage, trading and auditing; arrangement of conferences, seminars, courses, lectures, presentations, workshops, tutorials and training in the field of banking, finance, brokerage, trading and auditing for educational purposes.

42 – Electronic data storage; providing temporary use of on-line non-downloadable software for processing electronic payments; providing temporary use of online non-downloadable authentication software for controlling access to and communications with computers and computer networks; providing temporary use of online non-downloadable software for processing electronic payments; providing temporary use of online non-downloadable software for creating, preparing, managing, sending, processing, tracking, and reconciling invoices; providing temporary use of online non-downloadable software for issuing receipts regarding mobile payment transactions; providing temporary use of online non-downloadable computer software

for tracking and analysing payment activity; providing temporary use of online non-downloadable software to prevent fraud, facilitate integration with loyalty and reward platforms to allow tracking of purchases and accrual of rewards, and enable merchants to embed checkouts in third party sites and applications to sell and take payments on third party platforms; providing temporary use of online non-downloadable software to evaluate and detect fraud and illegality in payment transactions, manage compliance validation; electronic monitoring of financial transactions for fraud, money laundering, and illegality in the field of electronic funds transfer and electronic payment processing services; providing temporary use of online non-downloadable software for customizing application programming interfaces (api's), integrating pay in methods to digital wallets, sharing payment data between users and generating reports, managing disputed charges, and automating chargebacks; application service provider (asp) featuring application programming interface (api) software for payment collection, payment transactions, forwarding data and information processing; electronic data storage.

(260) AM 2023 120537 A

(800) 1698009

(151) 2022 08 16

(891) 2022 08 16

(731) Victron Energy B.V.

De Paal 35, NL-1351 JG Almere, Netherlands

(540)



(591) Blue and black

(531) 26.11.03; 26.11.12; 26.11.13; 27.05.10; 29.01.12

(511)

9 – Apparatus and instruments for the conduction, distribution, conversion, storage, regulation and management of electricity; apparatus and instruments for accumulating and storing electricity; apparatus and instruments for controlling electricity; photovoltaic apparatus for generating electricity; electric cables and wires; electric cables for adapters; electric cables for splitters; power inlets; junction boxes for electric wires; measuring, detecting, monitoring and controlling devices; electricity measuring instruments; controllers and energy regulators; sensors, detectors and monitoring instruments; solar charge controllers; dongles; autotransformers; galvanic isolators; photovoltaic apparatus and installations for generating solar electricity for home use; inverters; photovoltaic inverters; electrical inverters; DC/AC inverters; AC/DC inverters; inverters for power supply; inverters used in solar power generation; isolation transformers; chargers; current collectors; current transformers; current meters; current limiters; current converters; current shunts; current breakers; current rectifiers; current testers;

fault current breakers; alternating current adaptors; electric current adaptors; current overload protectors; direct current converters; DC-DC converters; electric current sensors; ac current sensors; energy meters; electric current transformers; voltage transformers; voltage stabilizers; voltage regulators; voltage dividers; voltage meters; voltage limiters; voltage detectors; voltage testers; high voltage transformers; voltage monitor modules; induction voltage regulators; voltage surge suppressors; static voltage regulators; maximum power point trackers; electric current switches; electric current rectifiers; fuses for electric current; electric current control devices; instruments for distributing electric current; voltage converters; voltage multipliers; voltage-to-current converters; voltage stabilizing power supply; voltage regulators for vehicles; high voltage power supplies; low voltage power supplies; distribution amplifiers; distribution transformers; distribution boards; electricity distribution boards; distribution consoles (electricity); electric power distribution apparatus; panels for the distribution of electricity; power conditioners; power modules; power connectors; power adapters; power distribution systems; power adaptors; power amplifiers; power controllers; power capacitors; power switches; power analyzers; power testers; power stabilisers; power meters; power cables; power banks; power wires; electric power units; power units [transformers]; power conditioning apparatus; power packs [batteries]; electrical power adaptors; power units [batteries]; power line protectors; power line conditioners; static power converters; power packs [transformers]; electric power analyzers; power distributing boxes; electronic power controllers; outdoor power relays; electronic power transformers; underwater power cables; power regulating apparatus; low power microcontrollers; electric power converters; power distributors [electrical]; electrical distributing busbars; high current distributors; switching power supply apparatus; uninterruptible power supply apparatus; electrical power distribution blocks; electric power supply sockets; electrical power outlet boxes; electric power supply units; mains power units (electric -); power-line transmission apparatus; electrical power extension cords; power transformers for amplification; AC/DC power supplies; DC input power supplies; high-voltage power supplies; low-voltage power supplies; accumulators for photovoltaic power; solar-powered battery chargers; solar-powered rechargeable batteries; distribution boxes for electrical power; voltage regulators for electric power; high-frequency switching power supplies; uninterruptible power supply apparatus [battery]; modules for photovoltaic power generation; apparatus for improving power efficiency; crystalline silicon solar power cells; portable power supplies (rechargeable batteries); apparatus for diagnosing electrical power installations; electric batteries for powering electric vehicles; photovoltaic installations for generating elec-

tricity [photovoltaic power plants]; apparatus and instruments for regulating the distribution of electricity; apparatus and instruments for conducting the distribution of electricity; apparatus and instruments for controlling the distribution of electricity; apparatus and instruments for switching the distribution of electricity; apparatus and instruments for transforming the distribution of electricity; apparatus and instruments for accumulating the distribution of electricity; measurement apparatus; data loggers and recorders; computer networking and data communications equipment; controller area network (can bus); computer networks; data processing equipment and accessories (electrical and mechanical); sensors; sensor controllers; electronic sensors; infrared sensors; detectors; electric monitoring apparatus; electric monitoring units; voltage monitoring units; electronic measurement sensors; monitoring control apparatus [electric]; panels for the control of electricity; electric control devices for energy management; electronic apparatus for the remote control of signals; computer software for controlling and managing electricity; apparatus and instruments for controlling the use of electricity; wireless controllers to remotely monitor and control the function and status of other electrical, electronic, and mechanical devices or systems; remote controls; programmable controls; microprocessor controls; electrical controls; remote controllers; multiport controllers; inverter controllers; programmable controllers; electrical controllers; energy control devices; electronic control systems; electrical terminal blocks being dual studs with bus bar; electrical terminal blocks being studs with bus bar; automatic control apparatus; electric control panels; electric control apparatus; process controlling software; electric power controllers; software for operating and managing integrated circuit components; auxiliary battery packs; transfer switches; DC distribution systems; battery adapters; battery booster cables; battery boxes; battery cables; battery cases; battery charge devices; battery chargers; battery charging devices for motor vehicles; battery charging equipment; battery compensation chargers; battery jars; battery jump starters; battery leads; battery packs; battery preheaters; battery separators; battery starters; battery terminals; battery management systems; battery protectors; battery isolators; battery connectors; battery switches; software for apparatus and instruments for the conduction, distribution, conversion, storage, regulation and management of electricity; software for monitoring, analysing, controlling and running physical world operations; electrical engineering software; networking software; computer network hardware; computer bus network; network management apparatus; network management software; network communication apparatus; software for remote diagnostics; diagnostic apparatus, not for medical purposes; testing apparatus for diagnostic purposes [other than medical]; cellular modem; cellular network modem; GPS receivers; automatic solar tracking

sensors; electronic sensors for measuring solar radiation; solar energy collectors for electricity generation; photovoltaic apparatus and installations for generating solar electricity; photovoltaic apparatus for converting solar radiation to electrical energy; monitors; monitor screens; tablet monitors; touchscreen monitors; monitoring instruments; monitoring apparatus and instruments; mains monitoring apparatus (electric -); temperature monitors for industrial use; temperature monitors for household use; nonintrusive load monitoring [NILM] apparatus; apparatus for monitoring electrical energy consumption; monitoring apparatus, other than for medical purposes; software for apparatus for measuring, monitoring and analyzing electricity consumption; power relays; midi fuses; mega fuses; field effect transistors (FET); buck-boost converters; solar cells; photovoltaic solar modules; load break isolators; electric transformers; electric voltage transformers; electronic power supplies; power dividers [electric]; regulated power supply apparatus; battery balancers; battery combiners; software for battery monitors; software for power inverters; software for electric inverters.

(260) AM 2023 120540 A
 (800) 1698089
 (151) 2022 08 18
 (891) 2022 08 18
 (731) "Medical Center "M.T.K." Limited Liability Company
 Mykola Amosov str., 10, Kyiv 03680, Ukraine
 (540)

TIVOR-L

(591) Black, white
 (511)
 5 – Pharmaceuticals and veterinary preparations; sanitary preparations for medical purposes; dietetic food and substances adapted for medical use; food for babies; plasters, materials for dressings; material for dental fillings and dental impressions; disinfectants; vermin destroying preparations; fungicides, herbicides.

(260) AM 2023 120543 A
 (800) 1698200
 (151) 2022 10 25
 (891) 2022 10 25
 (731) "Ficosota" OOD
 Madara Blvd. 48, Shumen, BG-9700, Bulgaria
 (540)



(591) Brown black
 (531) 05.03.13; 05.03.14; 26.13.25; 27.05.10;
 29.01.12
 (511)
 3 – Bath soap; liquid soap; skin care preparations; shower gels; hair shampoos; hair conditioner; body lotion.
 5 – Antibacterial soap; medicated soap; disinfectant soap.

(260) AM 2023 120545 A
 (800) 1698247
 (151) 2022 09 20
 (891) 2022 09 20
 (731) Philip Morris Products S.A.
 Quai Jeanrenaud 3, CH-2000 Neuchâtel,
 Switzerland
 (540)



(591) Black, white
 (531) 01.15.15; 26.11.12
 (511)
 34 – Wired vaporizers for electronic cigarettes and electronic smoking devices; tobacco, raw or manufactured; tobacco products, including cigars, cigarettes, cigarillos, tobacco for roll-your-own cigarettes, pipe tobacco, chewing tobacco, snuff tobacco, kretek; snus; tobacco substitutes (not for medical purposes); smokers' articles, namely cigarette paper and tubes, cigarette filters, tobacco tins, cigarette cases and ashtrays, pipes, pocket apparatus for rolling cigarettes, lighters; matches; tobacco sticks, tobacco products for the purpose of being heated, electronic devices and their parts for the purpose of heating cigarettes or tobacco in order to release nicotine-containing aerosols for inhalation; liquid nicotine solutions for use in electronic cigarettes; electronic smoking devices; electronic cigarettes; electronic cigarettes as substitutes for traditional cigarettes; electronic devices for the inhalation of nicotine-containing aerosols; oral vaporizing devices for smokers, tobacco products and tobacco substitutes; smokers' articles for electronic cigarettes; parts and fittings for the aforesaid products included in this class; devices for extinguishing heated cigarettes and cigars as well as heated tobacco sticks; electronic rechargeable cigarette cases.

(260) AM 2023 120546 A
 (800) 1698248
 (151) 2022 09 20
 (891) 2022 09 20
 (731) Philip Morris Products S.A.
 Quai Jeanrenaud 3, CH-2000 Neuchâtel,
 Switzerland

(540)



(591) Black, white
 (531) 01.15.15; 26.11.12

(511)

34 – Wired vaporizers for electronic cigarettes and electronic smoking devices; tobacco, raw or manufactured; tobacco products, including cigars, cigarettes, cigarillos, tobacco for roll-your-own cigarettes, pipe tobacco, chewing tobacco, snuff tobacco, kretek; snus; tobacco substitutes (not for medical purposes); smokers' articles, namely cigarette paper and tubes, cigarette filters, tobacco tins, cigarette cases and ashtrays, pipes, pocket apparatus for rolling cigarettes, lighters; matches; tobacco sticks, tobacco products for the purpose of being heated, electronic devices and their parts for the purpose of heating cigarettes or tobacco in order to release nicotine-containing aerosols for inhalation; liquid nicotine solutions for use in electronic cigarettes; electronic smoking devices; electronic cigarettes; electronic cigarettes as substitutes for traditional cigarettes; electronic devices for the inhalation of nicotine-containing aerosols; oral vaporizing devices for smokers, tobacco products and tobacco substitutes; smokers' articles for electronic cigarettes; parts and fittings for the aforesaid products included in this class; devices for extinguishing heated cigarettes and cigars as well as heated tobacco sticks; electronic rechargeable cigarette cases.

(260) AM 2023 120549 A
 (800) 1698321
 (151) 2022 09 13
 (891) 2022 09 13
 (731) Joint Stock Company "Melon Fashion Group"
 10-aya Krasnoarmeyskaya, 22, Letter A,
 premises 1-H, 6 floor, RU-190103 Saint
 Petersburg, Russian Federation

(540)

Z A R I N A

(591) Black, white
 (531) 27.05.01

(511)

3 – Abrasives; descaling preparations for household purposes; antistatic preparations for household purposes; aromatics [essential oils]; air fragrancing preparations; balms, other than for medical purposes; lip glosses; nail glitter; body glitter; petroleum jelly for cosmetic purposes; cotton wool for cosmetic purposes; cotton wool impregnated with make-up removing preparations; sachets for perfuming linen; adhesives for cosmetic purposes; scented water; micellar water; toilet water; depilatory wax; tailors' wax; creams for leather; shoemakers' wax; polishing wax; massage gels, other than for medical purposes; dental bleaching gels; make-up; deodorants for pets; deodorants for human beings or for animals; depilatory preparations; air fragrance reed diffusers; scented wood; perfumes; windscreen cleaning liquids; greases for cosmetic purposes; perfumery; decorative transfers for cosmetic purposes; eyebrow pencils; cosmetic pencils; adhesives for affixing false eyelashes; adhesives for affixing false hair; hair conditioners; cosmetic dyes; body paint for cosmetic purposes; laundry starch; shoe cream; cosmetic creams; skin whitening creams; hair spray; nail varnish; hair lotions; lotions for cosmetic purposes; after-shave lotions; beauty masks; oils for perfumes and scents; oils for cosmetic purposes; oils for toilet purposes; essential oils; oils for cleaning purposes; cleansing milk for toilet purposes; soap; cosmetic kits; gel eye patches for cosmetic purposes; nail art stickers; double eyelid tapes; false nails; eau de Cologne; cotton sticks for cosmetic purposes; toothpaste; pumice stone; lipstick cases; breath freshening strips; lipsticks; pomades for cosmetic purposes; cosmetic preparations for baths; bath preparations, not for medical purposes; hair straightening preparations; toiletries; hair waving preparations; mouthwashes, not for medical purposes; cosmetic preparations for slimming purposes; laundry glaze; fabric softeners for laundry use; preparations for washing; lacquer-removing preparations; make-up removing preparations; nail care preparations; cleaning preparations; collagen preparations for cosmetic purposes; bleaching preparations [decolorants] for household purposes; laundry bleach; aloe vera preparations for cosmetic purposes; sunscreen preparations; colour-brightening chemicals for household purposes [laundry]; breath freshening preparations for personal hygiene; make-up powder; stain removers; nail varnish removers; vaginal washes for personal sanitary or deodorant purposes; false eyelashes; baby wipes impregnated with cleaning preparations; tissues impregnated with cosmetic lotions; tissues impregnated with make-up removing preparations; potpourris [fragrances]; bath salts, not for medical purposes; fumigation preparations [perfumes]; leather preservatives [polishes]; astringents for cosmetic purposes; eyebrow cosmetics; make-up preparations; sun-tanning preparations [cosmetics]; hair dyes; neutralizers for permanent waving; cosmetic preparations for eyelashes; cosmetic preparations for skin care;

shoe polish; dentifrices; cosmetics; cosmetics for children; cosmetics for animals; mascara; cleansers for intimate personal hygiene purposes, non medicated; douching preparations for personal sanitary or deodorant purposes [toiletries]; detergents, other than for use in manufacturing operations and for medical purposes; degreasers, other than for use in manufacturing processes; bleaching preparations [decolorants] for cosmetic purposes; toiletry preparations; antiperspirants [toiletries]; cotton swabs for cosmetic purposes; shampoos; shampoos for animals [non-medicated grooming preparations]; shampoos for pets [non-medicated grooming preparations]; dry shampoos; extracts of flowers [perfumes]; ethereal essences; mint essence [essential oil].

9 – Electronic tags for goods; 3D spectacles; identity cards, magnetic; encoded magnetic cards; decorative magnets; spectacles; sunglasses; goggles for sports; pince-nez; spectacle lenses; anti-glare glasses; bags adapted for laptops; USB flash drives; containers for contact lenses; spectacle cases; cases for smartphones; cases especially made for photographic apparatus and instruments; spectacle chains; sleeves for laptops; covers for tablet computers; cell phone straps; spectacle cords.

14 – Agates; diamonds; amulets [jewellery]; anchors [clock – and watchmaking]; barrels [clock – and watchmaking]; bracelets [jewellery]; bracelets made of embroidered textile [jewellery]; watch bands; charms for key rings; jewellery charms; brooches [jewellery]; alarm clocks; pins [jewellery]; ornamental pins; tie pins; jewellery hat pins; beads for making jewellery; pearls made of ambroid [pressed amber]; busts of precious metal; jewellery rolls; jet, unwrought or semi-wrought; jewellery findings; key rings [split rings with trinket or decorative fob]; retractable key rings; pearls [jewellery]; copper tokens; tie clips; cuff links; clasps for jewellery; badges of precious metal; gold, unwrought or beaten; Cloisonné jewellery [jewellery (am.)]; works of art of precious metal; jewellery; ivory jewellery; jewellery of yellow amber; iridium; cabochons; precious stones; semi-precious stones; spun silver [silver wire]; necklaces [jewellery]; split rings of precious metal for keys; rings [jewellery, jewelry (am.)]; boxes of precious metal; presentation boxes for jewellery; watch cases [parts of watches]; clock cases; pendulums [clock – and watchmaking]; medals; locket [jewellery]; precious metals, unwrought or semi-wrought; movements for clocks and watches; clockworks; coins; gold thread [jewellery]; threads of precious metal [jewellery]; silver thread [jewellery]; olivine [gems]; osmium; palladium; platinum [metal]; chronometric instruments; watch springs; rhodium; ruthenium; stopwatches; silver, unwrought or beaten; earrings; ingots of precious metals; alloys of precious metal; statues of precious metal; watch glasses; paste jewellery; watch hands; clock hands; ornaments of jet; shoe jewellery; hat jewellery; figurines of precious

metal; presentation boxes for watches; chronographs [watches]; chronometers; chronoscopes; chains [jewellery]; watch chains; dials [clock – and watchmaking]; atomic clocks; watches; sundials; clocks and watches, electric; control clocks [master clocks]; clocks; wristwatches; jewellery boxes; spinel [precious stones].

16 – Fountain pens; aquarelles; albums; almanacs; document laminators for office use; mimeograph apparatus and machines; atlases; posters; banknotes; banners of paper; paper bows, other than haberdashery or hair decorations; name badges [office requisites]; table linen of paper; tickets; baggage claim check tags of paper; forms, printed; announcement cards [stationery]; glitter for stationery purposes; note books; pads [stationery]; drawing pads; wristbands for the retention of writing instruments; pamphlets; booklets; paper; paper sheets [stationery]; waxed paper; paper for recording machines; paper for radiograms; papers for painting and calligraphy; electrocardiograph paper; drawer liners of paper, perfumed or not; wood pulp paper; carbon paper; copying paper [stationery]; parchment paper; writing paper; rice paper; luminous paper; toilet paper; wrapping paper; filter paper; washi; blotters; newsletters; rollers for typewriters; house painters' rollers; composing sticks; modelling wax, not for dental purposes; signboards of paper or cardboard; sewing patterns; bunting of paper; newspapers; electrotypes; hectographs; modelling clay; polymer modelling clay; terrestrial globes; drawing sets; engravings; slate pencils; pencil leads; document holders [stationery]; pencil holders; chalk holders; holders for cheque books; holders for stamps [seals]; page holders; name badge holders [office requisites]; diagrams; table runners of paper; engraving plates; writing slates; blackboards; galley racks [printing]; drawing boards; advertisement boards of paper or cardboard; duplicators; punches [office requisites]; cream containers of paper; magazines [periodicals]; money clips; clips for name badge holders [office requisites]; tags for index cards; pen clips; bookmarks; etching needles; tracing needles for drawing purposes; periodicals; printed publications; paper shredders for office use; graphic representations; credit card imprinters, non-electric; paper creasers [office requisites]; graining combs; drawing instruments; calendars; tracing paper; tracing cloth; tracing patterns; gums [adhesives] for stationery or household purposes; lithographic stones; ink stones [ink reservoirs]; pencils; pencil lead holders; charcoal pencils; pictures; transfers [decalcomanias]; paintings [pictures], framed or unframed; cardboard; wood pulp board [stationery]; hat boxes of cardboard; cards; index cards [stationery]; geographical maps; paper tapes and cards for the recordal of computer programmes; trading cards, other than for games; perforated cards for Jacquard looms; catalogues; spools for inking ribbons; flower-pot covers of paper; paintbrushes; painters' brushes; writing brushes; typewriter keys; glue for stationery or household purposes; isinglass for sta-

tionery or household purposes; gluten [glue] for stationery or household purposes; starch paste [adhesive] for stationery or household purposes; printing blocks; books; colouring books; manifolds [stationery]; comic books; drawing pins; cigar bands; envelopes [stationery]; boxes of paper or cardboard; cases for stamps [seals]; paint boxes for use in schools; correcting fluids [office requisites]; printed coupons; stencils [stationery]; French curves; paper ribbons, other than haberdashery or hair decorations; gummed tape [stationery]; typewriter ribbons; barcode ribbons; adhesive tapes for stationery or household purposes; correcting tapes [office requisites]; inking ribbons; self-adhesive tapes for stationery or household purposes; square rulers for drawing; drawing rulers; flyers; absorbent sheets of paper or plastic for foodstuff packaging; humidity control sheets of paper or plastic for foodstuff packaging; viscose sheets for wrapping; sheets of reclaimed cellulose for wrapping; plastic bubble packs for wrapping or packaging; steel letters; type [numerals and letters]; lithographs; letter trays; paint trays; architects' models; postage stamps; plastics for modelling; graphic prints; modelling materials; teaching materials [except apparatus]; sealing compounds for stationery purposes; adhesives [glues] for stationery or household purposes; padding materials of paper or cardboard; bookbinding material; packing [cushioning, stuffing] materials of paper or cardboard; packaging material made of starches; filtering materials of paper; tablemats of paper; addressing machines; pencil sharpening machines, electric or non-electric; bookbinding apparatus and machines [office equipment]; typewriters, electric or non-electric; franking machines for office use; chalk for lithography; writing chalk; tailors' chalk; marking chalk; spray chalk; bags [envelopes, pouches] of paper or plastics, for packaging; garbage bags of paper or of plastics; painters' easels; hand-rests for painters; printing sets, portable [office requisites]; bibs of paper; bibs, sleeved, of paper; stickers [stationery]; fingerstalls for office use; writing cases [stationery]; cords for bookbinding; paper knives [letter openers]; printed sheet music; numbering apparatus; bottle envelopes of paper or cardboard; sealing wafers; covers [stationery]; passport holders; protective covers for books; plastic cling film, extensible, for palletization; embroidery designs [patterns]; handwriting specimens for copying; oleographs; musical greeting cards; greeting cards; postcards; etchings; conical paper bags; bags for microwave cooking; palettes for painters; ink sticks; pantographs [drawing instruments]; loose-leaf binders; files [office requisites]; folders for papers; papier mâché; pastels [crayons]; modelling paste; pen cases; pen wipers; office perforators; pens [office requisites]; nibs of gold; nibs; steel pens; drawing pens; song books; seals [stamps]; sealing stamps; clipboards; address plates for addressing machines; handkerchiefs of paper; plastic film for wrapping; transparencies [stationery]; desk mats; trays for sorting and counting

money; coasters of paper; bookends; stamp stands; mats of paper for beer glasses; stands for pens and pencils; photograph stands; obliterating stamps; inking pads; stamp pads; binding strips [bookbinding]; face towels of paper; towels of paper; inking sheets for document reproducing machines; inking sheets for duplicators; cloth for bookbinding; gummed cloth for stationery purposes; printers' blankets, not of textile; portraits; paperweights; writing cases [sets]; inkstands; office requisites, except furniture; writing materials; writing instruments; drawing materials; school supplies [stationery]; adhesive tape dispensers [office requisites]; hand labelling appliances; printed matter; lithographic works of art; prospectuses; printed timetables; ledgers [books]; printers' galleys; indexes; paper cutters [office requisites]; rubber erasers; elastic bands for offices; T-squares for drawing; graphic reproductions; retractable reels for name badge holders [office requisites]; penholders; marking pens [stationery]; tissues of paper for removing make-up; paper wipes for cleaning; place mats of paper; tablecloths of paper; paper clasps; document files [stationery]; scrapers [erasers] for offices; paper-clips; clips for offices; erasing products; biological samples for use in microscopy [teaching materials]; histological sections for teaching purposes; steatite [tailor's chalk]; writing board erasers; composing frames [printing]; sealing wax; arithmetical tables; placards of paper or cardboard; writing or drawing books; fabrics for bookbinding; stationery; pencil sharpeners, electric or non-electric; stencil plates; stencils for decorating food and beverages; cardboard tubes; Indian inks; moisteners [office requisites]; moisteners for gummed surfaces [office requisites]; squares for drawing; chart pointers, non-electronic; bottle wrappers of paper or cardboard; envelope sealing machines for offices; sealing machines for offices; vignetting apparatus; apparatus for mounting photographs; stapling presses [office requisites]; manuals [handbooks]; figurines of papier mâché; paper coffee filters; flags of paper; silver paper; moulds for modelling clays [artists' materials]; photo-engravings; photographs [printed]; stencil cases; canvas for painting; chromolithographs [chromos]; animation cels; compasses for drawing; numbers [type]; artists' watercolour saucers; ink; correcting ink [heliography]; inkwells; blueprints; stencils; erasing shields; balls for ball-point pens; desktop cabinets for stationery [office requisites]; printing type; address stamps; stamps [seals]; shields [paper seals]; prints [engravings]; labels of paper or cardboard.

18 – Mountaineering sticks; luggage tags; pocket wallets; saddlecloths for horses; business card cases; reins; reins for guiding children; sling bags for carrying infants; harness fittings; credit card cases [wallets]; parts of rubber for stirrups; chamois leather, other than for cleaning purposes; umbrellas; parasols; saddlery; frames for umbrellas or parasols; frames for bags [structural parts of bags]; card cases [notecases]; cases of leather or leatherboard; valves of leather;

whips; imitation leather; leather, unworked or semi-worked; leatherboard; casings, of leather, for springs; umbrella rings; hat boxes of leather; boxes of leather or leatherboard; boxes of vulcanized fibre; purses; chain mesh purses; fastenings for saddles; butts [parts of hides]; saddle trees; bags [envelopes, pouches] of leather, for packaging; moleskin [imitation of leather]; travelling sets [leatherware]; knee-pads for horses; muzzles; halters; vanity cases, not fitted; furniture coverings of leather; clothing for pets; covers for animals; trimmings of leather for furniture; collars for animals; hiking sticks; conference folders; music cases; slings for carrying infants; goldbeaters' skin; cat o' nine tails; leather leashes; pads for horse saddles; horseshoes; girths of leather; leathercloth; horse blankets; garment bags for travel; shoulder belts [straps] of leather; briefcases; traces [harness]; fur; randsels [Japanese school satchels]; haversacks; leather straps; straps for soldiers' equipment; harness straps; straps for skates; straps of leather [saddlery]; chin straps, of leather; stirrup leathers; umbrella handles; walking stick handles; suitcase handles; grips for holding shopping bags; rucksacks; backpacks for carrying infants; travelling bags; riding saddles; net bags for shopping; umbrella or parasol ribs; stirrups; bags; bags for climbers; tool bags, empty; handbags; beach bags; saddlebags; compression cubes adapted for luggage; bags for sports; bags for campers; reusable shopping bags; wheeled shopping bags; school bags; pouch baby carriers; travelling trunks; trunks [luggage]; nose bags [feed bags]; bridoons; walking sticks; umbrella sticks; walking stick seats; tefillin [phylacteries]; bits for animals [harness]; bridles [harness]; harness for animals; key cases; horse collars; suitcases; motorized suitcases; suitcases with wheels; valises; attaché cases; covers for horse saddles; umbrella covers; kid; curried skins; animal skins; cattle skins; leather cord; blinkers [harness]; labels of leather; game bags [hunting accessories].

25 – Wimples; bandanas [neckerchiefs]; underwear; sweat-absorbent underwear; berets; overalls; boas [necklets]; teddies [underclothing]; boxer shorts; ankle boots; ski boots; boots for sports; breeches for wear; trousers; football shoes; brassieres; adhesive bras; valenki [felted boots]; mittens; collars [clothing]; detachable collars; shirt yokes; veils [clothing]; gabardines [clothing]; galoshes; neckties; ascots; gaiters; spats; leggings [leg warmers]; boot uppers; corselets; jerseys [clothing]; waistcoats; sports jerseys; hosiery; heels; heelpieces for footwear; hoods [clothing]; hat frames [skeletons]; pockets for clothing; scarves; caps being headwear; kimonos; cap peaks; visors being headwear; tights; slips [underclothing]; combinations [clothing]; wet suits for water-skiing; bodices [lingerie]; corsets [underclothing]; suits; bathing suits; masquerade costumes; beach clothes; headscarves; leotards; jackets [clothing]; stuff jackets [clothing]; fishing vests; leggings [trousers]; liveries; camisoles; sports singlets; cuffs; short-sleeve shirts; mantillas;

coats; sleep masks; furs [clothing]; fingerless gloves; mitres [hats]; muffs [clothing]; footmuffs, not electrically heated; bibs, not of paper; bibs, sleeved, not of paper; fur stoles; hairdressing capes; heel protectors for shoes; ear muffs [clothing]; socks; sweat-absorbent socks; footwear; gymnastic shoes; beach shoes; sports shoes; clothing; paper clothing; outerclothing; embroidered clothing; ready-made clothing; motorists' clothing; cyclists' clothing; clothing for gymnastics; clothing of imitations of leather; latex clothing; clothing of leather; waterproof clothing; clothing incorporating LEDs; uniforms; clothing containing slimming substances; fittings of metal for footwear; maniples; overcoats; knickers; parkas; pelerines; gloves [clothing]; ski gloves; pyjamas; bathing trunks; shirt fronts; pocket squares; dresses; headbands [clothing]; garters; sock suspenders; stocking suspenders; ready-made linings [parts of clothing]; dress shields; soles for footwear; braces [suspenders] for clothing; half-boots; lace boots; ponchos; girdles; belts [clothing]; sashes for wear; money belts [clothing]; layettes [clothing]; non-slipping devices for footwear; heelpieces for stockings; welts for footwear; chasubles; shirts; wooden shoes; sandals; bath sandals; boots; jumper dresses; saris; sarongs; sweaters; footwear uppers; inner soles; albs; bath slippers; togas; knitwear [clothing]; underpants; shoes; slippers; skull caps; turbans; headwear; aprons [clothing]; judo uniforms; karate uniforms; tee-shirts; rash guards; dressing gowns; bath robes; top hats; tips for footwear; stockings; sweat-absorbent stockings; shawls; paper hats [clothing]; shower caps; bathing caps; neck tube scarves; studs for football shoes; hats; babies' pants [underwear]; gaiter straps; pelisses; esparto shoes or sandals; skirts; petticoats; skorts.

35 – Arranging subscriptions to telecommunication services for others; import-export agency services; commercial information agency services; advertising agency services; cost price analysis; rental of advertising space; business auditing; employment agency services; computerized file management; book-keeping; invoicing; demonstration of goods; transcription of communications [office functions]; opinion polling; market studies; business investigations; business research; marketing research; personnel recruitment; business management and organization consultancy; business organization consultancy; business management consultancy; personnel management consultancy; professional business consultancy; consultancy regarding advertising communication strategies; consultancy regarding public relations communication strategies; layout services for advertising purposes; marketing; targeted marketing; business management of performing artists; business management of sports people; writing of curriculum vitae for others; scriptwriting for advertising purposes; news clipping services; updating and maintenance of information in registries; updating and maintenance of data in computer databases; updating of advertising material; word

processing; online retail services for downloadable and pre-recorded music and movies; online retail services for downloadable ring tones; online retail services for downloadable digital music; organization of exhibitions for commercial or advertising purposes; arranging newspaper subscriptions for others; organization of fashion shows for promotional purposes; organization of trade fairs; shop window dressing; business appraisals; payroll preparation; data search in computer files for others; sponsorship search; administrative assistance in responding to calls for tenders; business management assistance; commercial or industrial management assistance; commercial intermediation services; providing business information; providing business information via a website; providing commercial and business contact information; providing commercial information and advice for consumers in the choice of products and services; provision of an online marketplace for buyers and sellers of goods and services; providing user reviews for commercial or advertising purposes; web indexing for commercial or advertising purposes; providing user rankings for commercial or advertising purposes; presentation of goods on communication media, for retail purposes; media relations services; economic forecasting; auctioneering; wholesale services for pharmaceutical, veterinary and sanitary preparations and medical supplies; retail services for works of art provided by art galleries; retail services for pharmaceutical, veterinary and sanitary preparations and medical supplies; sales promotion for others; promotion of goods and services through sponsorship of sports events; production of teleshopping programmes; production of advertising films; office machines and equipment rental; rental of advertising time on communication media; publicity material rental; rental of billboards [advertising boards]; rental of vending machines; rental of sales stands; rental of photocopying machines; consumer profiling for commercial or marketing purposes; publication of publicity texts; radio advertising; development of advertising concepts; bill-posting; distribution of samples; dissemination of advertising matter; direct mail advertising; registration of written communications and data; editing of publicity texts; advertising; online advertising on a computer network; outdoor advertising; advertising by mail order; television advertising; compilation of statistics; compilation of information into computer databases; business inquiries; systemization of information into computer databases; advisory services for business management; corporate communications services; negotiation of business contracts for others; negotiation and conclusion of commercial transactions for third parties; compiling indexes of information for commercial or advertising purposes; tax preparation; drawing up of statements of accounts; telemarketing services; psychological testing for the selection of personnel; interim business management; outsourced administrative management for companies; business ma-

agement of hotels; business management for freelance service providers; business project management services for construction projects; commercial administration of the licensing of the goods and services of others; business management of reimbursement programmes for others; administration of consumer loyalty programs; administration of frequent flyer programs; administrative processing of purchase orders; administrative services for the relocation of businesses; public relations; competitive intelligence services; modelling for advertising or sales promotion; typing; market intelligence services; appointment reminder services [office functions]; website traffic optimization; appointment scheduling services [office functions]; tax filing services; search engine optimization for sales promotion; gift registry services; price comparison services; pay per click advertising; secretarial services; procurement services for others [purchasing goods and services for other businesses]; shorthand; outsourcing services [business assistance]; telephone answering for unavailable subscribers; photocopying services; efficiency experts.

(260) AM 2023 120550 A
 (800) 1698376
 (151) 2022 08 03
 (891) 2022 08 03
 (731) Sanofi
 46 avenue de la Grande Armée, F-75017 Paris,
 France
 (540)



(591) Pantone 266 C (violet) and Pantone black 6C
 (531) 24.17.02; 27.05.01; 27.05.17; 27.05.21;
 29.01.12

(511)
 1 – Chemical products used for manufacture of pharmaceutical and cosmetic preparations and substances.
 3 – Non-medicated preparations for skin hygiene, care and maintenance; body hygiene products, namely, toiletries; cosmetic products; soaps; dentifrices.
 5 – Pharmaceutical and veterinary products sold on prescription or over the counter; sanitary products for medicine; dietetic substances for medical use; chemical preparations for medical or pharmaceutical use; vaccines; food for babies; plasters, materials for dressings; materials for dental fillings and dental impressions; disinfectants; vitamins, vitamin-based preparations, dietetic substances for medical use; natural dietetic foods and remedies based on medicinal plants for medical or veterinary use; beverages and foodstuffs

for medicinal use; food supplements and additives for medicinal use; mineral food supplements for medicinal use; nutritional supplements, plant-based preparations for medicinal use; food supplements containing proteins, carbohydrates, lipids and/or fibers, or micronutrients such as vitamins and/or minerals, amino acids and/or fatty acids, for medical use; plant-based products and plant extracts for medicinal use; preparations for making dietetic or medicated beverages; medicinal preparations; chemical preparations for medicinal use; substances for medicinal use; medicated candy and confectionery for medicinal use; pharmacological preparations for skin care.

9 – Contact lenses; spectacles and optical glasses; software in the field of health; video and audio cassettes, CD-ROMs in the field of health, medical imaging software; software as a medical device [SaMD], downloadable; software and applications for mobile devices; software for Web applications only for information and advisory purposes in the field of health; software for Web applications, for sending, receiving and storing digital data, solely for use in the field of health.

10 – Surgical, medical, dental and veterinary apparatus and instruments; artificial limbs, eyes and teeth; orthopedic articles; suture materials; medical imaging apparatus; X-ray apparatus for medical use.

35 – Business consultancy services; consultation services, namely, providing consumer information relating to goods and services; advertising and marketing services; commercial information for customers on pharmaceutical products; business management and administration in the field of health; distribution of printed promotional material in the field of health; promotion and public awareness campaign services in the field of health; advice on communication strategy (advertising and public relations); advertising services for promoting public awareness concerning health issues.

38 – Telecommunication services and particularly transmission of information by radio, telephone, television and computer terminals on Internet sites concerning health care; transmission of information on behalf of third parties in the field of health; communication of information intended for patients or healthcare professionals via computers, the Internet, television and radio; providing online chat rooms and electronic bulletin boards for transmission of messages among computer users concerning healthcare, pharmaceutical products and medical and pharmaceutical developments.

41 – Education and training in the field of health; organization of seminars, conferences and congresses in the field of health; publishing of magazines, books and guides and dissemination of digital media for information and training in the field of health.

42 – Scientific and technological services namely chemical research, biological and pharmaceutical research, design and development of software and databases, in the field of health; clinical studies; scientific information services by providing scientific data.

44 – Medical services; veterinary services; hygienic and beauty care, consulting relating to pharmacy and health; providing information with respect to health; providing medical and scientific information; providing medical information on any medium, including online via the Internet and social networks.

(260) AM 2023 120565 A
 (800) 1698952
 (151) 2022 06 28
 (891) 2022 06 28
 (731) Willis Group Limited
 51 Lime Street, London EC3M 7DQ,
 United Kingdom
 (540)



(591) Purple
 (531) 27.05.01; 27.05.17; 29.01.05
 (511)

9 – Computer software; electronic downloadable publications, podcasts, and videos.

16 – Printed matter and publications.

35 – Management of commercial and business enterprises; business consulting services; business management consulting; business risk management; business information services; business consulting services in the fields of business risk management, human resources, personnel, workforce effectiveness, employee job evaluation, employer-employee communications, employee safety, employee relocation, business management and operations, contingency planning, strategic planning, operations, mergers and acquisitions, organizational structure and reorganization, and product development and marketing; market research and analysis services; outsourcing services; systemization and compilation of information into computerized databases; market reports and studies; conducting business research and surveys; preparing business reports; custom preparation of business communications for use by employers to communicate with employees; administration of employee benefit plans, employee profit-sharing plans, employee stock purchase plans, employee savings, pension and retirement plans, and employee health care, dental, and prescription plans; customer service management relating to administrative processing of insurance claims.

36 – Financial services; investment services; insurance services; insurance brokerage services; insurance underwriting services; financial risk management; actuarial services; actuarial consulting; financial consul-

ting services in relation to insurance, financial risk management, financial services, investments, employee compensation and benefits, employee benefit plans, employee profit-sharing plans, employee stock purchase plans, employee savings, pension and retirement plans, and employee health care, dental, and prescription plans; administration of financial affairs relating to employee benefit plans, employee profit-sharing plans, employee stock purchase plans, employee savings, pension and retirement plans, and employee health care, dental, and prescription plans; financial research and information services; financial, direct risk, and insurance risk management services; financial research and information services; financial management of insurance claims; insurance services in the nature of loss control management for others; providing insurance information; financial risk management services, namely, insurance portfolio analysis and insurance portfolio optimization; financial consulting and advice services for enterprise risk management (ERM) to assist with rating agency requirements.

41 – Educational services, including workshops, seminars, and other educational programs and providing electronic non-downloadable publications, podcasts, and videos in relation to human resources, employee compensation and benefits, retirement planning, pension and retirement plans, profit-sharing plans, stock purchase plans, health care, health care plans, dental plans, and prescription plans; educational services, including workshops, seminars, and other educational programs and providing electronic non-downloadable publications, podcasts, and videos in relation to personnel management, workforce effectiveness, rewards management, employee job evaluation, personnel policies, employer-employee communications, employee safety, employee relocation, and outsourcing; educational services, including workshops, seminars, and other educational programs and providing electronic non-downloadable publications, podcasts, and videos in relation to business and organizational management and operations, organizational structure and reorganization, product development and marketing, mergers and acquisitions, strategic planning, contingency planning, change management, and information technology; educational services, including workshops, seminars, and other educational programs and providing electronic non-downloadable publications, podcasts, and videos in relation to insurance, insurance claims, risk management, risk evaluation, actuarial matters, financial services, investments, financial planning, financial modeling, asset allocation, catastrophe modeling, claims management, and quality assurance.

42 – Computer and information technology consultation; design, development and implementation of computer software, databases, websites, and intranets; design, development and testing of computer hardware;

re; computer systems integration services; computer programming and computer modeling services; computer project management services; application service provider (ASP) services; providing temporary use of online non-downloadable software.

(260) AM 2023 120566 A
 (800) 1699013
 (151) 2022 07 20
 (891) 2022 07 20
 (731) World Medicine İlaç San.Ve Tic.A.Ş.
 15 Temmuz Mah. Cami Yolu Cad. 50,
 Bağcılar, İstanbul, Türkiye

TANIVIR–ТАНИВИР

(540)
 (591) Black, white
 (531) 24.17.01; 27.05.01; 28.05
 (511)
 5 – Pharmaceutical and veterinary preparations for medical purposes, chemical preparations for medical purposes, dietary supplements, including those adapted for medical purposes, dietary supplements for slimming purposes, food for babies, herbs and herbal beverages adapted for medicinal purposes, sanitary preparations for medical use, hygienic pads, hygienic tampons, plasters, materials for dressings, diapers, including those made of paper and textiles, preparations for destroying vermin, fungicides, herbicides, deodorants, other than for human beings or for animals, air deodorising preparations, disinfectants, antiseptics, detergents for medical purposes.

(260) AM 2023 120567 A
 (800) 1699067
 (151) 2022 08 30
 (891) 2022 08 30
 (731) Bonduelle
 La Woestyne, F-59173 Renescure, France



(540)
 (591) Pantone green: 343 C
 (531) 05.03.15; 26.11.12; 27.05.08; 29.01.13
 (511)
 29 – Meat; meat extracts; fish; seafood (not live); crustaceans (not live); snails (not live); poultry; game; Canned, frozen, deep-frozen, dried and cooked, bottled fruit and vegetables; jams; fruit jelly; compotes; eggs; milk and dairy products; cheeses; creams [dairy products]; yogurts; edible oils and fats; preserved mushrooms; canned and bottled fruit, vegetables; can-

ned and bottled steamed vegetables, salad vegetables, cooked vegetables; canned and bottled mushrooms, corn, beans, peas, chickpeas, carrots, lentils, mixed vegetables, flageolet beans, broad beans, potatoes, fruit; canned and bottled goods based on vegetables, mushrooms, corn, beans, peas, chickpeas, carrots, lentils, mixed vegetables, flageolet beans, broad beans, potatoes, fruits; canned and bottled mixtures of vegetables, fruit; vegetables, fruits, mixtures of vegetables and fruits being deep-frozen; deep-frozen cooked vegetables; deep-frozen, cooked, dried or canned mushrooms, corn, beans, peas, chickpeas, carrots, lentils, mixed vegetables, flageolet beans, broad beans, potatoes; canned olives; mashed potatoes; vegetable or vegetable-based purees; deep-frozen potatoes and vegetable puree; soups; potages; broths; vegetable soups; canned or deep-frozen vegetable soups; prepared or freshly cooked, canned, bottled or deep-frozen dishes, preparations and food based on vegetables, starches, potatoes, sweet potatoes, fruit, dried fruit, cheese, meat, chicken, soy meats and steaks, tofu, vegetable and plant-based meats and steaks; deep-frozen French fries; tomato purée; fruit salads, vegetable salads; preserved olives; salads based on vegetables, starches, potatoes, sweet potatoes, fruit, dried fruit, cheese, meat, chicken, falafels, soy meats and steaks, tofu, vegetarian and plant-based meats and steaks; raw vegetable salad; mixed green vegetable salads; salads, mixed salads in bags; soy meats and steaks, tofu; vegetarian meats and steaks; plant-based meats and steaks.

30 – Rice; flour and preparations made from cereals; salt; mustard; vinegar; sauces (condiments); pastry and confectionery; bread; edible ices; ice for refreshment; ice cream; frozen yogurts; spices; preserved garden herbs; flavorings (other than essential oils); aromatic preparations for food; seasonings; vinaigrette; rusks; biscuits and cookies; cakes; tarts; pies; pizzas; beverages based on chocolate, coffee, cocoa, tea; buns; snacks based on cereals and rice; dishes, preparations based on cereals; noodle-based prepared meals; chocolate; condiments; couscous semolina; tabbouleh; salad dressings; cooked corn; roasted corn; popcorn; salads, dishes, food, preparations based on wheat, rice, pasta, corn, semolina, quinoa, bulgur, barley; biscuits and cookies for aperitifs; bread-based aperitif products; dried aromatic herbs for culinary use; deep-frozen aromatic herbs for culinary use.

31 – Agricultural, horticultural and forestry products (neither prepared nor processed); grains (seeds); natural flowers and plants; fresh fruits and vegetables; corn; fresh garden herbs; fresh mushrooms; fresh olives.

32 – Vegetable juices (beverages); non-alcoholic beverages based on vegetable juices.

35 – Advertising; business management assistance; market study; commercial information and advice for consumers (consumer advice shop); demonstration of

goods; sales promotion for third parties; collection of data in a central file; computer file management; public relations; retail services for meat, meat extracts, fish, seafood [not live], crustaceans [not live], snails [not live], poultry, game, canned, frozen, deep-frozen, dried and cooked, bottled fruits and vegetables, jams, fruit jelly, compotes, eggs, milk and dairy products, cheeses, creams [dairy products], yogurt, edible oils and fats, canned mushrooms, cans and jars of fruits, vegetables, cans and jars of steamed vegetables, salad vegetables, cooked vegetables, cans and jars of mushrooms, corn, beans, peas, chickpeas, carrots, lentils, mixed vegetables, flageolet beans, broad beans, potatoes, fruits, cans and jars based on vegetables, mushrooms, corn, beans, peas, chickpeas, carrots, lentils, mixed vegetables, flageolet beans, broad beans, potatoes, fruit, cans and jars of vegetable mixes, fruits, vegetables, fruits, deep-frozen vegetable and fruit mixes, deep-frozen cooked vegetables, mushrooms, corn, beans, peas, chickpeas, carrots, lentils, mixed vegetables, flageolet beans, broad beans, deep-frozen, cooked, dried or canned potatoes, canned olives, mashed potatoes, vegetable or vegetable-based puree, vegetable puree, deep-frozen potatoes, soups, thick soups, broths, vegetable soups, deep-frozen or canned vegetable soups, dishes, prepared or freshly cooked, canned, bottled or deep-frozen dishes, preparations and culinary fare based on vegetables, starches, potatoes, sweet potatoes, fruits, dried fruits, cheeses, meats, chicken, meat and soy steaks, tofu, vegetarian and plant-based meats and steaks, deep-frozen french fries, tomato puree, vegetable salads, fruit, canned olives, vegetable-based salads, starchy foods, potatoes, sweet potatoes, fruit, dried fruits, cheeses, meats, chicken, falafel, soy meats and steaks, tofu, vegetarian and plant-based meats and steaks, raw vegetable salads, mixed green salads, salads, mixed salads in bags, meat and soy steaks, tofu, vegetarian meats and steaks, meats and vegetable steaks, rice, flour and preparations made from cereals, salt, mustard, vinegar, sauces [condiments], pastry and confectionery, bread, edible ices, ices, ice cream, frozen yogurt, spices, preserved garden herbs, flavorings [other than essential oils], aromatic preparations for food, seasoning, vinaigrette, rusks, biscuits, cakes, tarts, pies, pizzas, chocolate-, coffee-, cocoa-, tea-based beverages, buns, cereal-, rice-based snack foods, dishes, cereal-based preparations, noodle-based prepared meals, chocolate, condiments, couscous semolina, tabbouleh, salad dressings, cooked corn, roasted corn, popcorn, salads, dishes, culinary fare, preparations based on wheat, rice, pasta, corn, semolina, quinoa, bulgur wheat, barley, biscuits for aperitifs, bread-based aperitif products, dried aromatic herbs for culinary use, deep-frozen aromatic herbs for culinary use, agricultural, horticultural and forestry products [neither prepared nor processed], grains [seeds], natural plants and flowers, fresh fruits and vegetables, corn, fresh garden herbs, fresh mushrooms, fresh olives, vegetable juices [beve-

rages], alcohol-free beverages based on vegetable juices; retail sale services in specialty stores, in stands, in specialized corners, by means of a website or any other form of electronic communication media for meat, meat extracts, fish, seafood [not live], crustaceans [not live], snails [not live], poultry, game, canned, frozen, deep-frozen, dried and cooked, bottled fruits and vegetables, jams, fruit jelly, compotes, eggs, milk and dairy products, cheeses, creams [dairy products], yogurt, edible oils and fats, canned mushrooms, cans and jars of fruits, vegetables, cans and jars of steamed vegetables, salad vegetables, cooked vegetables, cans and jars of mushrooms, corn, beans, peas, chickpeas, carrots, lentils, mixed vegetables, flageolet beans, broad beans, potatoes, fruits, cans and jars based on vegetables, mushrooms, corn, beans, peas, chickpeas, carrots, lentils, mixed vegetables, flageolet beans, broad beans, potatoes, fruit, cans and jars of vegetable mixes, fruits, vegetables, fruits, deep-frozen vegetable and fruit mixes, deep-frozen cooked vegetables, mushrooms, corn, beans, peas, chickpeas, carrots, lentils, mixed vegetables, flageolet beans, broad beans, deep-frozen, cooked, dried or canned potatoes, canned olives, mashed potatoes, vegetable or vegetable-based puree, vegetable puree, deep-frozen potatoes, soups, thick soups, broths, vegetable soups, deep-frozen or canned vegetable soups, prepared or freshly cooked, canned, bottled or deep-frozen dishes, preparations and culinary fare based on vegetables, starches, potatoes, sweet potatoes, fruits, dried fruits, cheeses, meats, chicken, meat and soy steaks, tofu, vegetarian and plant-based meats and steaks, deep-frozen french fries, tomato puree, vegetable salads, fruit, canned olives, vegetable-based salads, starchy foods, potatoes, sweet potatoes, fruit, dried fruits, cheeses, meats, chicken, falafel, soy meats and steaks, tofu, vegetarian and plant-based meats and steaks, raw vegetable salads, mixed green salads, salads, mixed salads in bags, meat and soy steaks, tofu, vegetarian meats and steaks, meats and vegetable steaks, rice, flour and preparations made from cereals, salt, mustard, vinegar, sauces [condiments], pastry and confectionery, bread, edible ices, ices, ice cream, frozen yogurt, spices, preserved garden herbs, flavorings [other than essential oils], aromatic preparations for food, seasoning, vinaigrette, rusks, biscuits, cakes, tarts, pies, pizzas, chocolate-, coffee-, cocoa-, tea-based beverages, buns, cereal-, rice-based snack foods, dishes, cereal-based preparations, noodle-based prepared meals, chocolate, condiments, couscous semolina, tabbouleh, salad dressings, cooked corn, roasted corn, popcorn, salads, dishes, culinary fare, preparations based on wheat, rice, pasta, corn, semolina, quinoa, bulgur, barley, biscuits for aperitifs, bread-based aperitif products, dried aromatic herbs for culinary use, deep-frozen aromatic herbs for culinary use, agricultural, horticultural and forestry products [neither prepared nor processed], grains [seeds], natural plants and flowers, fresh fruits and vegetables, corn, fresh garden herbs, fresh mush-

rooms, fresh olives, vegetable juices [beverages], alcohol-free beverages based on vegetable juices.

43 – Restaurant services; mobile catering services; fast-food restaurants; snack bar services; street food and drinks; bar services; catering services; coffee shops; cafeterias; canteens; street food; self-service restaurant services; advice relating to cooking recipes; providing information in the nature of recipes.

(260) AM 2023 120569 A

(800) 1699401

(151) 2022 10 10

(891) 2022 10 10

(731) Vonovia SE

Universitätsstraße 133, 44803 Bochum,
Germany

(540)

Vonovia

(591) Black, white

(511)

36 – Real estate affairs; apartment house management; estate management; real estate management; rental of apartments; rental of offices [real estate]; rental of commercial real estate; real estate appraisal; leasing of real estate; accommodation bureau services [apartments]; rent collection; real estate agency services; real estate brokerage; acquiring, holding and disposing of interests in German and foreign corporations that acquire, manage and sell real estate and estate in Germany and abroad; insurance; establishment and management of real estate funds; advice on construction financing; mortgage brokerage services; mediation of construction financing; finance services; monetary affairs; arranging the provision of finance; hire-purchase financing; safekeeping of valuables; credit bureau services; insurance brokerage.

37 – Janitorial services; construction information; construction supervision; implementation of construction projects; housing construction; redevelopment of buildings through construction, installation and repair work; demolition of buildings; building sealing; elevator installation and repair; construction; roofing services; building insulating; burglar alarm installation and repair; chimney sweeping; door assembly; window assembly; window cleaning; fire alarm installation and repair; cleaning of buildings [exterior surface]; cleaning of buildings [interior]; scaffolding; plastering; heating equipment installation and repair; swimming-pool maintenance; plumbing; installation and repair of air-conditioning apparatus; kitchen equipment installation; freezing equipment installation and repair; varnishing; painting; machinery installation, maintenance and repair; masonry; upholstery; furniture maintenance; pump repair; rat exterminating; rental of cleaning machines; repair of security locks; repair information; rustproofing; pest control; street

cleaning; telephone installation and repair; joinery; rental of cleaning machines; linen ironing; washing of linen; repair of buildings and parts of buildings.

(260) AM 2023 120570 A
 (800) 1699403
 (151) 2022 10 13
 (891) 2022 10 13
 (731) Wolt Enterprises OY
 Arkadiankatu 6, FI-00100 Helsinki, Finland
 (540)



(591) turquoise, white
 (531) 25.03.03; 27.05.24; 29.01.12
 (511)
 9 – Computer software; mobile application software; software for the purpose of providing access to an online shop; software for retail services; e-commerce software; software for operating an online store.
 35 – Retail services and on-line retail services for foodstuff, prepared meals, food and drinking utensils, beverages, alcoholic beverages, confectionery, dietary supplements, vitamins, foodstuff for animals; retail services and on-line retail services for cosmetic products, toiletries, cosmetic and toilet utensils, hair fastening articles and ornaments; retail services and on-line retail services for health care products, pharmaceutical preparations, medical preparations, veterinary preparations, dietetic food and foodstuffs, plasters, dressing aids, household utensils, tobacco products, detergents and cleaning preparations, sanitary preparations, disinfectants; retail services and on-line retail services for fuels, motoring and automotive equipment and accessories, automotive chemicals, parts and spare parts for vehicles, magazines, books, letter sets, office papers, printing papers, notes, notebooks, forms, office books, office requisites, printed matter, crafts equipment, drawing and artist's materials, stationery; retail services and on-line retail services for domestic electronic equipment, information technology equipment, audio-visual equipment, audio devices, radio receivers, multimedia devices, photographic devices, wearable computers, mobile phones, smartwatches, wearable activity trackers, Global Positioning System [GPS] apparatus, movies, musical instruments; retail services and on-line retail services for household appliances, beauty appliances, health care appliances, domestic electric equipment, apparatus and instruments for conducting, switching, transforming, accumulating, regulating or controlling the distribution or use of electricity, lighting devices, lamps, furniture, mirrors, furnishings, household utensils; retail services and on-line retail services for items of small metal hardware, HVAC products, fireplaces, tools and power-operated tools, renovation materials,

building materials, fixing devices, small objects of metal, machine tools, paints, lacquers, preservatives, coatings, thinners, preparations for removing paint, carpets, protective equipment, sauna heaters, sauna products, bathroom vanities; retail services and on-line retail services for home security products, first aid products, bags, carrying bags, back bags, wallets and other carriers, umbrellas, eyeglasses, sunglasses, jewels, watches and clocks, horological and chronometric instruments, clothing, shoes, headgear, clothing for animals, furnishing accessories, furnishing textiles, household textiles, carpets, rugs and mats, decorations, textiles, sewing articles; retail services and on-line retail services for horticultural and gardening products, patio furniture, buildings, garden machinery, flowers and seeds; retail services and on-line retail services for firearms and ammunition, games, video game apparatus, sporting articles, vehicles, bicycles, bicycle parts, bicycle accessories; retail services and on-line retail services for camping equipment, fishing equipment, swimming pools, swimming pool equipment, toys, playthings, articles for children and babies, articles for pets, articles for cleaning purposes, articles for the care of clothing and footwear, articles for cooking, kitchen utensils, cutlery, tableware and fireworks; loyalty, incentive and bonus program services.

39 – Delivery services; delivery of groceries; distribution services; delivery of goods; packaging and storage of goods; transport and delivery of packages; transportation logistics.

42 – Software as a service; software as a service for the purpose of providing an online shop.

(260) AM 2023 120583 A
 (800) 1597865
 (151) 2021 03 29
 (891) 2022 11 15
 (731) Bioiberica, S.A.U.
 c. Antic Camí de Tordera, 109-119, E-08389
 Palafolls, Spain
 (540)

COLLAVANT

(591) Black, white
 (511)
 1 – Chemical products for use in industry, science and photography, as well as in agriculture, horticulture and forestry; biological preparations for industry and science.
 5 – Pharmaceutical products, preparations for medical and veterinary use; hygienic and sanitary products for medical use; dietetic food and substances for medical or veterinary use, food for babies; food supplements for humans or animals; disinfectants.

(260) AM 2023 120584 A
 (800) 1631925
 (151) 2021 07 15
 (891) 2022 11 11
 (731) Shenzhen Sako Solar Co., LTD.
 608 Building C, He-Xi HuangGangLing
 Industrial Park, Hangcheng Area, Taoyuan
 Community, Xixiang, Baoan, Shenzhen City,
 517100 GuangDong Province, China
 (540)



(591) Black, white
 (531) 27.05.01; 27.05.17
 (511)
 9 – Frequency converter; inverters [electricity]; voltage stabilizing power supply; voltage regulators; low voltage power supply; transformers; integrated circuits; control panels [electricity]; automation installations for power stations; electronic surveillance apparatus; radios; batteries, electric; solar batteries; solar panels for the production of electricity; photovoltaic devices and equipment for solar power generation; wires, electric; materials for electricity mains [wires, cables]; measuring instruments; light boxes; computer software applications, downloadable.

(260) AM 2023 120585 A
 (800) 1634285
 (151) 2021 04 22
 (891) 2022 10 12
 (731) Güntner Group Europe GmbH
 Hans-Güntner-Str. 2, 82256 Fürstfeldbruck,
 Germany
 (540)



(591) Black, white
 (531) 26.13.25; 26.15.25
 (511)
 7 – Condensing installations, namely air condensers, air-cooled condensers, axial fan condensers, steam condensers, refrigeration condensers; steam engines; pumps (machine or engine parts, machinery), pumps for heating installations, pumps for cooling installations; vacuum pumps, centrifugal pumps, lubricating pumps, refrigerant recovery pumps; regulators [parts of machines]; heat exchangers [parts of machines]; compressors, in particular refrigerant compressors for heating installations; refrigerant compressors for cooling installations, compressors for refrigerators, com-

pressors for recovering and recycling refrigerant gases; heat sinks for use in machines; radiators [cooling] for motors and engines.

9 – Apparatus and instruments for conducting, switching, transforming, accumulating, regulating and controlling the distribution of electricity; apparatus and instruments for regulating and controlling pressure, temperature, fan speed, noise or water; electronic control circuits for electric fans; electronic control circuits for electric valves; computer software and computer programs; computer application software for use in implementing the Internet of Things [IoT]; sensory software, electrical connecting plugs; plasma display panels; electric installations for the remote control of industrial operations; sensors, namely coolant-temperature sensors, pressure sensors, sensors for use in the control of engines, electronic control sensors for motors; refrigerant meters; refrigerant scales; electrical and thermal control devices; programmable controllers; wireless controllers to remotely monitor and control the function and status of other electrical, electronic, and mechanical devices or systems; central processing unit coolers; electronic process control units, namely, being industrial process control hardware and software for cooling and heating processes; climate control digital thermostats; diagnostic, monitoring, heat regulating and testing apparatus, not for medical purposes; all the aforesaid goods in particular in relation to refrigeration, cooling, air conditioning, purifying, heat and heat exchanger technology.

11 – Apparatus for heating, steam generating, refrigerating, drying, ventilating and water supply purposes; heat exchangers not being parts of machines, in particular lamellar heat exchangers, plate heat exchangers, tubular heat exchangers; fittings for heat exchangers; cooling installations and machines, in particular oil coolers, glycol dry coolers, water dry coolers, water cooling towers; refrigerant condensers; freezers; shock frosters; dry cooling apparatus for cooling media; refrigerating machines; refrigerating containers; chilling chambers, coolers for furnaces; refrigeration units; refrigerating apparatus, appliances and installations; ice machines and apparatus; freezing machines; cooling installations for liquids; driers for refrigeration systems; chiller units being parts of water cooling installations; finned tubes; heating and cooling apparatus and equipment for waste heat recovery; installations for the cooling of air; air conditioning fans; filters for air conditioning; air conditioning and parts of air conditioning systems; ventilating installations; ventilator frames; air conditioning panels for use in walk-in coolers; air heating apparatus; evaporators, in particular industrial high-performance evaporators, tubular evaporators and heat pump evaporators; heating installations; gas boilers; gas condensers, others than parts of machines; air heaters; level controlling valves in tanks; regulating and safety accessories for water apparatus; heat regenerators; he-

at accumulators; electric radiators, heat pumps, heat sinks for use in cooling apparatus; heat sinks for use in ventilating apparatus; heat sinks for use in heating apparatus; air purifying apparatus and machines, air filtering installations and apparatus, germicidal lamps for purifying air and water filtering installations; air filters for industrial and household use; water distribution installations; air cooling apparatus; condenser tubes; parts of the all above goods.

35 – Collective buying services, commercial evaluation services, auction services, commercial information agency services, import-export agency services, online information and ordering services in the field of refrigeration, cooling, air conditioning, purifying, heat and heat exchanger technology; retailing and wholesaling, mail order services and online retail and wholesale store services in the field of refrigeration, cooling, air conditioning, purifying, heat and heat exchanger technology, in particular in relation to condensing installations, condensers, pumps, compressors, heat exchangers, heat sinks, radiators, software, control systems, sensors, monitoring, test and heat regulating systems, refrigerating apparatus, machines and installations, cooling equipment and machines, heating apparatus and installations, air conditioning apparatus and installations, air purifying installations, water distribution installations and water cooling towers and in relation to parts of these goods; consultancy in the field of procuring goods and services in the field of refrigeration, cooling, air conditioning, purifying, heat and heat exchanger technology; providing of business and commercial information and consultancy for consumers in the field of refrigeration, cooling, air conditioning, purifying, heat and heat exchanger technology.

37 – Installation, cleaning, repair, refurbishment and maintenance in relation to refrigerating apparatus and installations, cooling equipment and machines, refrigerating machines, heat exchangers, heating apparatus, pumps, condensers, condensing installations, air conditioning apparatus and installations, air filtering and purifying installations, water distribution installations and water cooling towers and parts of these goods; construction management services; installation services, namely interference suppression in electric apparatus and in air conditioning installations and apparatus; construction consultancy; rental of cooling equipment, refrigerating apparatus and installations, cooling equipment and machines, refrigerating machines, heat exchangers, heating apparatus, pumps, condensers, condensing installations, air conditioning apparatus and installations, air filtering and purifying installations, water distribution installations and water cooling towers; advisory services and rental of objects in connection with the providing of the aforesaid services, included in this class; all aforesaid services in particular in relation to refrigeration, cooling, air conditioning, purifying, heat and heat exchanger techno-

logy; all aforesaid services not in relation to apparatus and machines for the manufacture or processing of food.

40 – Recycling, in particular of heat exchangers and packaging material.

42 – Scientific and technological services; industrial analysis and research services; material testing, technical testing, in particular technical testing of heat exchangers for recyclability, corrosion, material fatigue, wear, fracturing and leak tightness; technical testing and measurement services in relation to performance and energy consumption of heat exchangers; product and installation design, development, planning and civil engineering services; research and development of installations, processes and product [engineering services]; architectural and urban planning services and correspondent consultancy services; design and development of computer software; information technology [IT] consultancy services, namely development, programming and implementation of software; cloud computing; hosting of computer sites (websites); software as a service (SaaS); monitoring of computer systems by remote access; testing, authentication and quality control; technological consultation services; providing technical advice relating to energy-saving measures; consultancy relating to energy use and energy efficiency; advisory services relating to industrial engineering; all aforesaid services in particular in relation to refrigeration, cooling, air conditioning, purifying, heat and heat exchanger technology; all aforesaid services not in relation to apparatus and machines for the manufacture or processing of food.

(260) AM 2023 120586 A
 (800) 1681009
 (151) 2022 07 22
 (891) 2022 11 15
 (731) Cihan International Trade Dış Ticaret Limited Şirketi
 Karaduvar Sb Mah., Serbest Bölge 11. Cad. 42
 1, Akdeniz, Mersin, Türkiye
 (540)



(591) Red, white
 (531) 01.05.02; 01.05.23; 27.05.02; 27.05.17;
 27.05.19; 29.01.12

(511)
 29 – Meat, fish, poultry and game; processed meat products; dried pulses; soups; bouillon; processed olives; olive pastes; milks of animal origin; milk of plant

origin; milk products; butter; edible oils; dried, preserved, frozen, cooked, smoked or salted fruits and vegetables; tomato paste; prepared nuts and dried fruits as snacks; hazelnut spreads; peanut butter; tahini (sesame seed paste); eggs; powdered eggs; potato chips.

30 – Coffee, cocoa; coffee or cocoa based beverages, chocolate based beverages; pasta, stuffed dumplings, noodles; pastries and bakery products based on flour; desserts based on flour and chocolate; bread, simit [turkish ring-shaped bagel covered with sesame seeds], poğaça [turkish bagel], pita, sandwiches, katmer [turkish pastry], pies, cakes, baklava [turkish dessert based on dough coated with syrup], kadayif [turkish dessert based on dough]; desserts based on dough coated with syrup; puddings, custard, kazandibi [turkish pudding], rice pudding, keşkül [turkish pudding]; honey, bee glue for human consumption, propolis for food purposes; condiments for foodstuff, vanilla (flavoring), spices, sauces (condiments), tomato sauce; yeast, baking powder; flour, semolina, starch for food; sugar, cube sugar, powdered sugar; tea, iced tea; confectionery, chocolate, biscuits, crackers, wafers; chewing gums; ice-cream, edible ices; salt; cereal-based snack food, popcorn, crushed oats, corn chips, breakfast cereals, processed wheat for human consumption, crushed barley for human consumption, processed oats for human consumption, processed rye for human consumption, rice; molasses for food.

(260) AM 2023 120587 A

(800) 1682773

(151) 2022 04 22

(891) 2022 09 30

(731) Saic-Gm-Wuling Automobile Co., LTD.

No. 18, Hexi Road, Liunan District, Liuzhou,
545007 Guangxi, China

(540)



(591) Black, white

(531) 26.13.25; 26.15.25

(511)

12 – Locomotives; remote control vehicles, other than toys; electric vehicles; vehicles for locomotion by land, air, water or rail; automobiles; driverless cars [autonomous cars]; robotic cars; automobile hoods; automobile bodies; shock absorbers for automobiles; sun-blinds adapted for automobiles; vehicle wheel hubs; anti-theft devices for vehicles; bicycles; push

scooters [vehicles]; motorized tricycles; electric tricycles; motorized bicycles; cable cars; luggage trucks; tyres for vehicle wheels; air vehicles; boats; suspension shock absorbers for vehicles; luggage carriers for vehicles; children's safety seats for vehicles; windscreen wipers; seat covers for vehicles; windscreens; steering wheels for vehicles; side view mirrors for vehicles.

37 – Repair information; construction; construction of commodity houses; quarrying services; cleaning of buildings [interior]; cleaning of buildings [exterior surface]; burner maintenance and repair; office machines and equipment installation, maintenance and repair; motor vehicle maintenance and repair; vehicle lubrication; vehicle service stations [refuelling and maintenance]; vehicle cleaning; vehicle breakdown repair services; vehicle battery charging; photographic apparatus repair; strong-room maintenance and repair; rustproofing; tyre balancing; repair of rubber tires; leather care, cleaning and repair; disinfecting; elevator installation and repair.

(260) AM 2023 120588 A

(800) 1686226

(151) 2022 08 22

(891) 2022 11 09

(731) Aimbridge Parent Inc.

5301 Headquarters Drive, Plano TX 75024,
USA

(540)



(591) Black, white

(531) 24.03.07; 24.03.18; 24.17.02; 26.01.05;
26.01.18; 26.01.21; 27.05.01

(511)

35 – Hotel management for others; business management of hotels; managing and operating hotels and resorts for others; preparation of financial reports for others for business or commercial purposes; employment staffing consultation services; franchise services, namely, offering business management assistance in the establishment and operation of hotels and resorts; business management advisory services relating to franchising; business management consulting, strategic business planning, and business management advisory services; market analysis; preparing financial reports for others; concept and brand development consulting for corporate and individual clients.

36 – Capital management services, namely, project budget oversight in the field of property renovation; franchising services, namely, providing financial information and advice regarding the establishment and/or operation of hotels and resorts; receivership of non-performing hotels and resorts; receivership services for non-performing hotels and resorts.

37 – Construction, maintenance, and renovation of property; renovation of hotel and resort properties; advisory and consulting services in the field of renovation and property repositioning.

(260) AM 2023 120590 A
 (800) 1689192
 (151) 2022 08 23
 (891) 2022 11 09
 (731) Aimbridge Parent Inc.
 5301 Headquarters Drive, Plano TX 75024,
 USA
 (540)



(591) The color(s) gold is/are claimed as a feature of the mark

(531) 24.05.01; 26.01.01; 26.01.05; 26.01.18;
 26.01.21; 26.01.21; 27.05.01; 29.01.02

(511)
 35 – Hotel management for others; business management of hotels; managing and operating hotels and resorts for others; preparation of financial reports for others for business or commercial purposes; employment staffing consultation services; franchise services, namely, offering business management assistance in the establishment and operation of hotels and resorts; business management advisory services relating to franchising; business management consulting, strategic business planning, and business management advisory services; market analysis; preparing financial reports for others; concept and brand development consulting for corporate and individual clients.

36 – Capital management services, namely, project budget oversight in the field of property renovation; franchising services, namely, providing financial information and advice regarding the establishment and/or operation of hotels and resorts; receivership of non-performing hotels and resorts; receivership services for non-performing hotels and resorts.

37 – Construction, maintenance, and renovation of property; renovation of hotel and resort properties;

advisory and consulting services in the field of renovation and property repositioning.

(260) AM 2023 120653 A
 (800) 1699968
 (151) 2022 07 04
 (891) 2022 07 04
 (731) Egis Gyógyszergyár Zrt.
 Keresztúri út 30-38., H-1106 Budapest,
 Hungary
 (540)

MABSEN

(591) Black, white
 (511)
 5 – Pharmaceutical preparations for human use; dietic substances adapted for medical use; vitamin compositions; mineral food supplements; dietary supplements.

(260) AM 2023 120654 A
 (800) 1699969
 (151) 2022 07 04
 (891) 2022 07 04
 (731) Egis Gyógyszergyár Zrt.
 Keresztúri út 30-38., H-1106 Budapest,
 Hungary
 (540)

MOBIPRES

(591) Black, white
 (511)
 5 – Pharmaceutical preparations for human use; dietic substances adapted for medical use; vitamin compositions; mineral food supplements; dietary supplements.

(260) AM 2023 120655 A
 (800) 1699983
 (151) 2022 09 19
 (891) 2022 09 19
 (731) AMB Sarl
 1 Rue Jean Jaurès, F-74000 Annecy, France
 (540)



(591) Black, white

(531) 05.03.14; 26.13.25

(511)

33 – Aperitifs; arrack; brandy; wine; piquette; whisky; alcoholic beverages; vodka; anisette; kirsch; bitters; sweet liqueurs; digestifs [liqueurs and spirits]; cocktails; vodka-based alcoholic carbonated beverages with fruit flavoring; gin; curacao; anise [liqueur]; liqueurs; pre-mixed alcoholic beverages, other than beer-based; alcoholic beverages, except beer; alcoholic beverages containing fruit; spirits [beverages]; distilled beverages; hydromel [mead]; peppermint liqueurs; rum; sake; perry; cider; rice alcohol; alcoholic extracts; fruit extracts, alcoholic; alcoholic essences.

(260) AM 2023 120656 A

(800) 1699988

(151) 2022 07 01

(891) 2022 07 01

(731) Sanofi

46 avenue de la Grande Armée, F-75017 Paris, France

(540)

The logo for Sanofi, featuring the word "sanofi" in a bold, lowercase, sans-serif font. The letter 'i' at the end has a small blue dot above it.

(591) Pantone 266C (violet) and black

(531) 24.17.02; 27.05.01; 27.05.04; 27.05.17; 29.01.12

(511)

1 – Chemical products used for manufacture of pharmaceutical and cosmetic preparations and substances.

3 – Non-medicated preparations for skin hygiene, care and maintenance; body hygiene products, namely, toiletries; cosmetic products; soaps; dentifrices.

5 – Pharmaceutical and veterinary products sold on prescription or over the counter; sanitary products for medicine; dietetic substances for medical use; chemical preparations for medical or pharmaceutical use; vaccines; food for babies; plasters, materials for dressings; materials for dental fillings and dental impressions; disinfectants; vitamins, vitamin-based preparations, dietetic substances for medical use; natural dietetic foods and remedies based on medicinal plants for medical or veterinary use; beverages and foodstuffs for medicinal use; food supplements and additives for medicinal use; mineral food supplements for medicinal use; nutritional supplements, plant-based preparations for medicinal use; food supplements containing proteins, carbohydrates, lipids and/or fibers, or micronutrients such as vitamins and/or minerals, amino acids and/or fatty acids, for medical use; plant-based products and plant extracts for medicinal use; preparations for making dietetic or medicated beverages; medicinal preparations; chemical preparations for medicinal use; substances for medicinal use; medicated candy and confectionery for medicinal use; pharmacological preparations for skin care.

9 – Contact lenses; spectacles and optical glasses; software in the field of health; video and audio cassettes, CD-ROMs in the field of health, medical imaging software; software as a medical device [SaMD], downloadable; software and applications for mobile devices; software for Web applications only for information and advisory purposes in the field of health; software for Web applications, for sending, receiving and storing digital data, solely for use in the field of health.

10 – Surgical, medical, dental and veterinary apparatus and instruments; artificial limbs, eyes and teeth; orthopedic articles; suture materials; medical imaging apparatus; X-ray apparatus for medical use.

35 – Business consultancy services; providing information and advice to consumers concerning a selection of products and items to be sold; advertising and marketing services; commercial information for customers on pharmaceutical products; business management and administration in the field of health; distribution of printed promotional material in the field of health; promotion and public awareness campaign services in the field of health; advice on communication strategy (advertising and public relations).

38 – Telecommunication services and particularly transmission of information by radio, telephone, television and computer terminals on Internet sites concerning health care; transmission of information on behalf of third parties in the field of health; communication of information intended for patients or healthcare professionals via computers, the Internet, television and radio; providing online chat rooms and electronic bulletin boards for transmission of messages among computer users concerning healthcare, pharmaceutical products and medical and pharmaceutical developments.

41 – Education and training in the field of health; organization of seminars, conferences and congresses in the field of health; publishing of magazines, books and guides and dissemination of digital media for information and training in the field of health.

42 – Scientific and technological services namely chemical research, biological and pharmaceutical research, design and development of software and databases, in the field of health; conducting of clinical trials; scientific information services by providing scientific data.

44 – Medical services; veterinary services; hygienic and beauty care, consulting relating to pharmacy and health; health monitoring and prevention services and information with respect to health; providing medical information; providing medical information on any medium, including online via the Internet and social networks.

(260) AM 2023 120657 A
 (800) 1700010
 (151) 2022 07 04
 (891) 2022 07 04
 (731) Egis Gyógyszergyár Zrt.
 Keresztúri út 30-38., H-1106 Budapest,
 Hungary

(540)

DOBOCAL

(591) Black, white
 (511)
 5 – Pharmaceutical preparations for human use; dietic substances adapted for medical use; vitamin compositions; mineral food supplements; dietary supplements.

(260) AM 2023 120658 A
 (800) 1700054
 (151) 2022 05 17
 (891) 2022 05 17
 (731) SRP Sadid Otomotiv Anonim Şirketi
 Selimpaşa Mah. 5003 Sok. No:15, TR-34490
 Silivri İstanbul, Türkiye

(540)



(591) Blue, yellow, white
 (531) 27.05.01; 27.05.04; 27.05.17; 27.05.22;
 27.05.23; 29.01.12

(511)
 7 – Machines, machine tools and industrial robots for processing and shaping wood, metals, glass, plastics and minerals, 3D printers; construction machines and robotic mechanisms (machines) for use in construction; bulldozers, diggers (machines), excavators, road construction and road paving machines, drilling machines, rock drilling machines, road sweeping machines; lifting, loading and transmission machines and robotic mechanisms (machines) for lifting, loading and transmission purposes; elevators, escalators and cranes; machines and robotic mechanisms (machines) for use in agriculture and animal breeding, machines and robotic mechanisms (machines) for processing cereals, fruits, vegetables and food, machines for preparing and processing beverages; engines and motors, other than for land vehicles, parts and fittings therefor; hydraulic and pneumatic controls for engines and motors, brakes other than for vehicles, brake linings for engines, crankshafts, gearboxes, other than for land vehicles, cylinders for engines, pistons for engines, turbines, not for land vehicles, filters for engines and motors, oil, air and fuel filters for land vehicle engines, exhausts for land vehicle engines, exhaust

manifolds for land vehicle engines, engine cylinders for land vehicles, engine cylinder heads for land vehicles, pistons for land vehicle engines, carburetors for land vehicles, fuel conversion apparatus for land vehicle engines, injectors for land vehicle engines, fuel economisers for land vehicle engines, pumps for land vehicle engines, valves for land vehicle engines, starter motors for land vehicles, dynamos for land vehicle engines, sparking plugs for land vehicle engines, bearings (parts of machines), roller or ball bearings; machines for mounting and detaching tires; alternators, current generators, electric generators, current generators operated with solar energy; painting machines, automatic spray guns for paint, electric, hydraulic and pneumatic punching machines and guns, electric adhesive tape dispensers (machines), electric guns for compressed gas or liquid spraying machines, electric hand drills, electric hand saws, electric jigsaw machines, spiral machines, compressed air machines, compressors (machines), vehicle washing installations, robotic mechanisms (machines) with the above-mentioned functions; electric and gas-operated welding apparatus, electric arc welding apparatus, electric soldering apparatus, electric arc cutting apparatus, electrodes for welding machines, industrial robots (machines) with the abovementioned functions; printing machines; packaging machines, filling, plugging and sealing machines, labellers (machines), sorting machines, industrial robots (machines) with the abovementioned functions, electroplating machines; scaling machines for industrial purposes; machines for textile processing, sewing machines, industrial robots (machines) with the abovementioned functions; hydrogen dispensing pumps for service stations; pumps for counter-current swimming; aerating pumps for aquaria; compressed air pumps; air pumps [garage installations], fuel dispensing pumps for service stations, self-regulating fuel pumps; electric kitchen machines for chopping, grinding, crushing, mixing and mincing foodstuff, washing machines, laundry washing machines, dishwashers, spin driers (not heated), electric cleaning machines for cleaning floors, carpets or floorings, vacuum cleaners and parts thereof; automatic vending machines; galvanizing and electroplating machines; electric door openers and closers; gaskets for engines and motors.

12 – Motor land vehicles, motorcycles, mopeds, engines and motors for land vehicles, clutches for land vehicles, transmissions, transmission belts and transmission chains for land vehicles, gearing for land vehicles, brakes, brake discs and brake linings for land vehicles, vehicle chassis, automobile bonnets, vehicle suspension springs, shock absorbers for automobiles, gearboxes for land vehicles, steering wheels for vehicles, rims for vehicle wheels; bicycles and their bodies, handlebars and mudguards for bicycles; vehicle bodies, tipping bodies for trucks, trailers for tractors, frigorific bodies for land vehicles, trailer hitches for vehicles; vehicle seats, head-rests for vehicle seats,

safety seats for children, for vehicles, seat covers for vehicles, vehicle covers (shaped), sun-blinds adapted for vehicles; direction signals and arms for direction signals for vehicles, windscreen wipers and wiper arms for vehicles; inner and outer tires for vehicle wheels, tubeless tires, tire-fixing sets comprised of tire patches and tire valves for vehicles; windows for vehicles, safety windows for vehicles, rearview mirrors and wing mirrors for vehicles; anti-skid chains for vehicles; luggage carriers for vehicles, bicycle and ski carriers for cars, saddles for bicycles or motorcycles; air pumps for vehicles, for inflating tires; anti-theft alarms for vehicles, horns for vehicles; safety belts for vehicle seats, air bags (safety devices for automobiles); baby carriages, wheelchairs, pushchairs; wheelbarrows, shopping carts, single or multi-wheeled wheelbarrows, shopping trolleys, grocery carts, handling carts; rail vehicles; locomotives, trains, trams, waggons, cable cars, chairlifts, vehicles for locomotion by water and their parts, other than their motors and engines, vehicles for locomotion by air and their parts, other than their motors and engines.

35 – Advertising, marketing and public relations, organization of exhibitions and trade fairs for commercial or advertising purposes, provision of an online marketplace for buyers and sellers of goods and services, office functions, secretarial services, arranging newspaper subscriptions for others, compilation of statistics, rental of office machines, systemization of information into computer databases, telephone answering for unavailable subscribers, business management, business administration and business consultancy, accounting, commercial consultancy services, personnel recruitment, personnel placement, employment agencies, import-export agencies, temporary personnel placement services, auctioneering, the bringing together, for the benefit of others, of a variety of goods, namely, machines, machine tools and industrial robots for processing and shaping wood, metals, glass, plastics and minerals, 3D printers, construction machines and robotic mechanisms (machines) for use in construction, bulldozers, diggers (machines), excavators, road construction and road paving machines, drilling machines, rock drilling machines, road sweeping machines, lifting, loading and transmission machines and robotic mechanisms (machines) for lifting, loading and transmission purposes, elevators, escalators and cranes, machines and robotic mechanisms (machines) for use in agriculture and animal breeding, machines and robotic mechanisms (machines) for processing cereals, fruits, vegetables and food, machines for preparing and processing beverages, engines and motors, parts and fittings therefor, hydraulic and pneumatic controls for engines and motors, brakes, brake linings for engines, crankshafts, gearboxes, cylinders for engines, pistons for engines, turbines, not for land vehicles, filters for engines and motors, oil, air and fuel filters for land vehicle engines, exhausts for land vehicle engines, exhaust mani-

folds for land vehicle engines, engine cylinders for land vehicles, engine cylinder heads for land vehicles, pistons for land vehicle engines, carburetors for land vehicles, fuel conversion apparatus for land vehicle engines, injectors for land vehicle engines, fuel economisers for land vehicle engines, pumps for land vehicle engines, valves for land vehicle engines, starter motors for land vehicles, dynamos for land vehicle engines, sparking plugs for land vehicle engines, bearings (parts of machines), roller or ball bearings, machines for mounting and detaching tires, alternators, current generators, electric generators, current generators operated with solar energy, painting machines, automatic spray guns for paint, electric, hydraulic and pneumatic punching machines and guns, electric adhesive tape dispensers (machines), electric guns for compressed gas or liquid spraying machines, electric hand drills, electric hand saws, electric jigsaw machines, spiral machines, compressed air machines, compressors (machines), vehicle washing installations, robotic mechanisms (machines) with the abovementioned functions, electric and gas-operated welding apparatus, electric arc welding apparatus, electric soldering apparatus, electric arc cutting apparatus, electrodes for welding machines, industrial robots (machines) with the abovementioned functions, printing machines, packaging machines, filling, plugging and sealing machines, labellers (machines), sorting machines, industrial robots (machines) with the abovementioned functions, electroplating machines, sealing machines for industrial purposes, machines for textile processing, sewing machines, industrial robots (machines) with the abovementioned functions, hydrogen dispensing pumps for service stations, pumps for counter-current swimming, aerating pumps for aquaria, compressed air pumps, air pumps [garage installations], fuel dispensing pumps for service stations, self-regulating fuel pumps, electric kitchen machines for chopping, grinding, crushing, mixing and mincing foodstuff, washing machines, laundry washing machines, dishwashers, spin driers (not heated), electric cleaning machines for cleaning floors, carpets or floorings, vacuum cleaners and parts thereof, automatic vending machines, galvanizing and electroplating machines, electric door openers and closers, gaskets for engines and motors, motor land vehicles, motorcycles, mopeds, engines and motors for land vehicles, clutches for land vehicles, transmissions, transmission belts and transmission chains for land vehicles, gearing for land vehicles, brakes, brake discs and brake linings for land vehicles, vehicle chassis, automobile bonnets, vehicle suspension springs, shock absorbers for automobiles, gearboxes for land vehicles, steering wheels for vehicles, rims for vehicle wheels, bicycles and their bodies, handlebars and mudguards for bicycles, vehicle bodies, tipping bodies for trucks, trailers for tractors, frigorific bodies for land vehicles, trailer hitches for vehicles, vehicle seats, head-rests for vehicle seats, safety seats for children, for vehicles, seat co-

vers for vehicles, vehicle covers (shaped), sun-blinds adapted for vehicles, direction signals and arms for direction signals for vehicles, windscreen wipers and wiper arms for vehicles, inner and outer tires for vehicle wheels, tubeless tires, tire-fixing sets comprised of tire patches and tire valves for vehicles, windows for vehicles, safety windows for vehicles, rearview mirrors and wing mirrors for vehicles, anti-skid chains for vehicles, luggage carriers for vehicles, bicycle and ski carriers for cars, saddles for bicycles or motorcycles, air pumps for vehicles, for inflating tires, anti-theft alarms for vehicles, horns for vehicles, safety belts for vehicle seats, air bags (safety devices for automobiles), baby carriages, wheelchairs, pushchairs, wheelbarrows, shopping carts, single or multi-wheeled wheelbarrows, shopping trolleys, grocery carts, handling carts, rail vehicles, locomotives, trains, trams, waggons, cable cars, chairlifts, vehicles for locomotion by water and their parts, vehicles for locomotion by air and their parts, enabling customers to conveniently view and purchase those goods, such services may be provided by retail stores, wholesale outlets, by means of electronic media or through mail order catalogues.

(260) AM 2023 120659 A
 (800) 1700058
 (151) 2022 10 21
 (891) 2022 10 21
 (731) IPG Ink Inc.
 5900 Balcones Drive Ste 100, Austin TX
 78731, USA
 (540)



(591) Black, white
 (531) 01.15.11; 27.05.01; 27.05.08; 27.05.10;
 27.05.24
 (511)
 34 – Cigarettes; snuff; ashtrays for smokers; cigarette cases; cigarette filters; cigarette holders; cigarette paper; electronic cigarettes; filter tips for cigarettes; flavourings, other than essential oils, for tobacco; flavourings, other than essential oils, for use in electronic cigarettes; lighters for smokers; liquid nicotine solutions for use in electronic cigarettes; smokers' mouthpieces for electronic cigarettes; tobacco pipes.

(260) AM 2023 120660 A
 (800) 1700122
 (151) 2022 07 04
 (891) 2022 07 04
 (731) Egis Gyógyszergyár Zrt.
 Keresztúri út 30-38., H-1106 Budapest,
 Hungary

(540)

LISIA

(591) Black, white
 (511)
 5 – Pharmaceutical preparations for human use; dietic substances adapted for medical use; vitamin compositions; mineral food supplements; dietary supplements.

(260) AM 2023 120661 A
 (800) 1700123
 (151) 2022 07 04
 (891) 2022 07 04
 (731) Egis Gyógyszergyár Zrt.
 Keresztúri út 30-38., H-1106 Budapest,
 Hungary
 (540)

NOFRAC

(591) Black, white
 (511)
 5 – Pharmaceutical preparations for human use; dietic substances adapted for medical use; vitamin compositions; mineral food supplements; dietary supplements.

(260) AM 2023 120662 A
 (800) 1700132
 (151) 2022 09 19
 (891) 2022 09 19
 (731) AMB Sarl
 1 Rue Jean Jaurès, F-74000 Annecy, France
 (540)



(591) Black, white
 (531) 18.03.02; 18.03.23; 26.11.03
 (511)
 33 – Aperitifs; arrack; brandy; wine; piquette; whisky; alcoholic beverages; vodka; anisette; kirsch; bitters; sweet liqueurs; digestifs [liqueurs and spirits]; cocktails; vodka-based alcoholic carbonated beverages with fruit flavoring; gin; curacao; anise; liqueurs; premixed alcoholic beverages, other than beer-based; alcoholic beverages, except beer; alcoholic beverages containing fruit; spirits [beverages]; distilled beverages; hydromel [mead]; peppermint liqueurs; rum; sake; cider; rice alcohol; alcoholic extracts; fruit extracts, alcoholic; alcoholic essences.

(260) AM 2023 120663 A

(800) 1700145

(151) 2021 12 31

(891) 2021 12 31

(731) Vimpi Viskoz Mayi Pompalari İmalat,
Sanayi Ve Ticaret Limited Şirketi
Sincan Sanayi Sitesi 231. Sok. No:11, Sincan,
Ankara, Türkiye

(540)



(591) Brown, yellow, white

(531) 26.01.03; 26.01.24; 26.03.07; 26.03.23;
26.04.16; 27.05.01; 29.01.13

(511)

35 – Advertising, marketing and public relations; organization of exhibitions and trade fairs for commercial or advertising purposes; design for advertising (term considered too vague by the International Bureau – Rule 13 (2) (b) of the Regulations); provision of an online marketplace for buyers and sellers of goods and services; office functions; secretarial services; arranging newspaper subscriptions for others; compilation of statistics; rental of office machines; systemization of information into computer databases; telephone answering for unavailable subscribers; business management, business administration and business consultancy services; accounting; commercial consultancy services; personnel recruitment, personnel placement, employment agencies, import-export agencies; temporary personnel placement services; auctioneering; the bringing together, for the benefit of others, of a variety of goods, ores of non-precious metal, common metals and their alloys and semi-finished products made of these materials, irons for construction, mats and stirrups of common metals for buildings, common metals in the form of plate, billet, stick, profile, sheet and sheeting, goods and materials of common metal used for storage, wrapping, packaging and sheltering purposes, containers of metal (storage, transport), buildings of metal, frames of metal for building, poles of metal for building, metal boxes, packaging containers of metal, aluminium foil, fences made of metal, guard barriers of metal, metal tubes, storage containers of metal, metal containers for the transportation of goods, ladders of metal, goods of common metal for filtering and sifting purposes, included in this class, doors, windows, shutters, jalousies and their cases and fittings of metal, non-electric cables and wires of metal, ironmongery, small hardware of metal, screws of metal, nails, bolts of metal, nuts of metal, pegs of metal, flakes of metal, pitons of metal, metal chains, furniture casters of metal, fittings

of metal for furniture, industrial metal wheels, door handles of metal, window handles of metal, hinges of metal, metal latches, metal locks, metal keys for locks, metal rings, metal pulleys, ventilation ducts, vents, vent covers, pipes, chimney caps, manhole covers, grilles of metal for ventilation, heating, sewage, telephone, underground electricity and air conditioning installations, metal panels or boards (non-luminous and non-mechanical) used for signalling, route showing, publicity purposes, signboards of metal, advertisement columns of metal, signaling panels of metal, non-luminous and non-mechanical traffic signs of metal, pipes of metal for transportation of liquids and gas, drilling pipes of metal and their metal fittings, valves of metal, couplings of metal for pipes, elbows of metal for pipes, clips of metal for pipes, connectors of metal for pipes, safes (strong boxes) of metal, metal railway materials, metal rails, metal railway ties, railway switches, bollards of metal, floating docks of metal, mooring buoys of metal, anchors, metal moulds for casting, other than machine parts, works of art made of common metals or their alloys, trophies of common metal, metal closures, bottle caps of metal, metal poles, metal pillars, scaffolding of metal, metal stakes, metal towers, metal pallets and metal ropes for lifting, loading and transportation purposes, metal hangers, ties, straps, tapes and bands used for load-lifting and load-carrying, wheel chocks made primarily of metal, metal profile laths for vehicles for the purposes of decoration, machines, machine tools and industrial robots for processing and shaping wood, metals, glass, plastics and minerals, 3d printers, construction machines and robotic mechanisms (machines) for use in construction: bulldozers, diggers (machines), excavators, road construction and road paving machines, drilling machines, rock drilling machines, road sweeping machines, lifting, loading and transmission machines and robotic mechanisms (machines) for lifting, loading and transmission purposes: elevators, escalators and cranes, machines and robotic mechanisms (machines) for use in agriculture and animal breeding, machines and robotic mechanisms (machines) for processing cereals, fruits, vegetables and food, machines for preparing and processing beverages, engines and motors, other than for land vehicles, parts and fittings therefor: hydraulic and pneumatic controls for engines and motors, brakes other than for vehicles, brake linings for engines, crankshafts, gearboxes, other than for land vehicles, gearboxes, cylinders for engines, pistons for engines, turbines, not for land vehicles, filters for engines and motors, oil, air and fuel filters for land vehicle engines, exhausts for land vehicle engines, exhaust manifolds for land vehicle engines, engine cylinders for land vehicles, engine cylinder heads for land vehicles, pistons for land vehicle engines, carburetors for land vehicles, fuel conversion apparatus for land vehicle engines, injectors for land vehicle engines, fuel economisers for land vehicle engines, pumps for land vehicle engines, valves for land vehic-

le engines, starter motors for land vehicles, dynamos for land vehicle engines, sparking plugs for land vehicle engines, bearings (parts of machines), roller or ball bearings, machines for mounting and detaching tires, alternators, current generators, electric generators, current generators operated with solar energy, painting machines, automatic spray guns for paint, electric, hydraulic and pneumatic punching machines and guns, electric adhesive tape dispensers (machines), electric guns for compressed gas or liquid spraying machines, electric hand drills, electric hand saws, electric jigsaw machines, spiral machines, compressed air machines, compressors (machines), vehicle washing installations, robotic mechanisms (machines) with the abovementioned functions, electric and gas-operated welding apparatus, electric arc welding apparatus, electric soldering apparatus, electric arc cutting apparatus, electrodes for welding machines, industrial robots (machines) with the abovementioned functions, printing machines, packaging machines, filling, plugging and sealing machines, labellers (machines), sorting machines, industrial robots (machines) with the abovementioned functions, electric packing machines for plugging and sealing of plastics, machines for textile processing, sewing machines, industrial robots (machines) with the abovementioned functions, pumps other than parts of machines or engines, fuel dispensing pumps for service stations, self-regulating fuel pumps, electric kitchen machines for chopping, grinding, crushing, mixing and mincing foodstuff, washing machines, laundry washing machines, dishwashers, spin driers (not heated), electric cleaning machines for cleaning floors, carpets or floorings, vacuum cleaners and parts thereof, automatic vending machines, galvanizing and electroplating machines, electric door openers and closers, gaskets for engines and motors, lighting installations, lights for vehicles and interior-exterior spaces, heating installations using solid, liquid or gas fuels or electricity, central heating boilers, boilers for heating installations, radiators [heating], heat exchangers, not parts of machines, stoves, kitchen stoves, solar thermal collectors [heating], installations for air-conditioning and ventilating, cooling installations and freezers, electric and gas-powered devices, installations and apparatus for cooking, drying and boiling: cookers, electric cooking pots, electric water heaters, barbecues, electric laundry driers, hair driers, hand drying apparatus, sanitary installations, taps [faucets], shower installations, toilets [water-closets], shower and bathing cubicles, bath tubs, toilet seats, sinks, wash-hand basins [parts of sanitary installations], washers for water taps, stuffings (tap valves), water softening apparatus, water purification apparatus, water purification installations, waste water purification installations, electric bed warmers and electric blankets, not for medical use, electric pillow warmers, electric or non-electric footwarmers, hot water bottles, electrically heated socks, filters for aquariums and aquarium filtration apparatus,

industrial type installations for cooking, drying and cooling purposes, pasteurizers and sterilizers, motor land vehicles, motorcycles, mopeds, engines and motors for land vehicles, clutches for land vehicles, transmissions, transmission belts and transmission chains for land vehicles, gearing for land vehicles, brakes, brake discs and brake linings for land vehicles, vehicle chassis, automobile bonnets, vehicle suspension springs, shock absorbers for automobiles, gearboxes for land vehicles, steering wheels for vehicles, rims for vehicle wheels, bicycles and their bodies, handlebars and mudguards for bicycles, vehicle bodies, tipping bodies for trucks, trailers for tractors, frigorific bodies for land vehicles, trailer hitches for vehicles, vehicle seats, head-rests for vehicle seats, safety seats for children, for vehicles, seat covers for vehicles, vehicle covers (shaped), sun-blinds adapted for vehicles, direction signals and arms for direction signals for vehicles, windscreen wipers and wiper arms for vehicles, inner and outer tires for vehicle wheels, tubeless tires, tire-fixing sets comprised of tire patches and tire valves for vehicles, windows for vehicles, safety windows for vehicles, rearview mirrors and wing mirrors for vehicles, anti-skid chains for vehicles, luggage carriers for vehicles, bicycle and ski carriers for cars, saddles for bicycles or motorcycles, air pumps for vehicles, for inflating tires, anti-theft alarms for vehicles, horns for vehicles, safety belts for vehicle seats, air bags (safety devices for automobiles), baby carriages, wheelchairs, pushchairs, wheelbarrows, shopping carts, single or multi-wheeled wheelbarrows, shopping trolleys, grocery carts, handling carts, rail vehicles, locomotives, trains, trams, waggons, cable cars, chairlifts, vehicles for locomotion by water and their parts, other than their motors and engines, vehicles for locomotion by air and their parts, other than their motors and engines enabling customers to conveniently view and purchase those goods, such services may be provided by retail stores, wholesale outlets, by means of electronic media or through mail order catalogues.

(260) AM 2023 120664 A
 (800) 1700171
 (151) 2022 09 19
 (891) 2022 09 19
 (731) Kia Corporation
 12, Heolleung-ro, Seocho-gu, Seoul 06797,
 Republic of Korea
 (540)

Kia

(591) Black, white
 (511)
 12 – Wheelchairs; parachutes; tractors; vehicles for locomotion by land, air, water or rail; civilian drones; air vehicles; pilotless aircraft; land vehicles; mobility scooters; robotic cars; motor trucks; automatic transport vehicles; driverless cars [autonomous cars]; buses; structural parts for buses; sports cars; coach vans;

parts and fittings for motorcycles; motorcycles; driverless cars; self-driving cars; automobiles; lane departure warning systems for automobiles; parts and fittings for automobiles; electrically operated scooters; electric cars; hybrid power scooters; camping vehicles; camping trailers; invalids' carriages; bicycles; electric bicycles; automobile tires; suspension shock absorbers for vehicles; brakes for land vehicles; tractors for agricultural purposes; motors and engines for land vehicles; electric drives for land vehicles; rubber belts for land vehicles transmissions; couplings for land vehicles; electric motors for motor cars.

(260) AM 2023 120680 A
 (800) 1700633
 (151) 2022 10 18
 (891) 2022 10 18
 (731) Google LLC
 1600 Amphitheatre Parkway, Mountain View
 CA 94043, USA
 (540)



(591) The color(s) green, yellow, red, and blue is/are claimed as a feature of the mark.

(531) 26.04.04; 26.11.12; 29.01.14
 (511)

9 – Downloadable and recorded software for facilitating commercial transactions through electronic means via wireless networks, global computer networks and mobile telecommunication devices; Downloadable and recorded software for enabling processing of electronic funds transfers and payments made via ACH, credit cards, debit cards, prepaid cards, wireless wallets, mobile wallets, electronic wallets, electronic check and electronic, mobile and online payments; Downloadable and recorded software for organizing, storing, providing access to, redeeming, scanning, sharing, and providing information about goods, services, discounts, tickets, boarding passes, admission tickets, transit passes, coupons, rebates, discounts, event tickets, vaccination cards, incentive programs, gift cards, special offers, rewards, and consumer loyalty programs; Downloadable and recorded software for processing, facilitating, verifying, and authenticating mobile payments and contactless transactions with retailers, merchants, and vendors using a mobile device; Downloadable and recorded software for capturing, managing, and storing credit card and debit card information.

36 – Financial services, namely, providing, processing, verifying and authenticating mobile payments, commercial transactions and payment options, loyalty

reward card transactions, pre-paid cards, contactless credit and debit card transactions, and bill payment transactions with retailers, merchants, and vendors via mobile devices; Financial transaction services, namely, providing secure commercial transactions and payment options.

42 – Providing temporary use of online non-downloadable software for facilitating commercial transactions through electronic means via wireless networks, global computer networks and mobile telecommunication devices; Providing temporary use of online non-downloadable software for enabling processing of electronic funds transfers and payments made via ACH, credit cards, debit cards, prepaid cards, wireless wallets, mobile wallets, electronic wallets, electronic check and electronic, mobile and online payments; Providing temporary use of online non-downloadable software for organizing, storing, providing access to, redeeming, scanning, sharing, and providing information about goods, services, discounts, tickets, boarding passes, admission tickets, transit passes, coupons, rebates, discounts, event tickets, vaccination cards, incentive programs, gift cards, special offers, rewards, and consumer loyalty programs; Providing temporary use of online non-downloadable software for processing, facilitating, verifying, and authenticating mobile payments and contactless transactions with retailers, merchants, and vendors using a mobile device; Application service provider featuring application programming interface (API) software for integration of online payment systems, loyalty and rewards programs, tickets, passes, coupons, and special offers between merchants and customers.

(260) AM 2023 120682 A
 (800) 1700654
 (151) 2022 09 30
 (891) 2022 09 30
 (731) Saic-GM-Wuling Automobile Co., LTD.
 No. 18, Hexi Road, Liunan District, Liuzhou,
 545007 Guangxi, China
 (540)



(591) Black, white
 (531) 27.05.01
 (511)

12 – Automobile chassis; engines for land vehicles; automobile bodies; shock absorbers for automobiles; vehicle wheels; motorized bicycles; bicycles; trolleys; cable cars; tyres for vehicle wheels; air vehicles; yachts; windscreen wipers; upholstery for vehicles; hand trucks; vehicles for locomotion by land, air, water or rail; automobiles.

37 – Repair information; machinery installation, maintenance and repair; motor vehicle maintenance and repair; vehicle service stations [refuelling and mainte-

nance]; rustproofing; retreading of tyres; repair of rubber tyres; vehicle lubrication; vehicle washing; varnishing.

(260) AM 2023 120683 A
 (800) 1700658
 (151) 2022 11 08
 (891) 2022 11 08
 (731) LLC "Coffee Like"
 Lenina ul., d.21, office 401, g. Izhevsk,
 g. Izhevsk G.O., RU-426004 Udmurtskaya
 resp., Russian Federation
 (540)



(591) Black, white
 (531) 19.03.01; 27.05.01
 (526) COFFEE
 (511)

21 – Heat-insulated containers; heat-insulated containers for beverages; porcelain ware; earthenware; cups of paper or plastic; glasses [receptacles]; drinking glasses; insulating flasks; hip flasks; drinking bottles for sports; cups.

25 – Caps being headwear; socks; ponchos; sweaters; tee-shirts.

30 – Coffee flavourings; cocoa substitutes; coffee substitutes; vegetal preparations for use as coffee substitutes; tea substitutes; cocoa; coffee capsules, filled; coffee; unroasted coffee; cocoa beverages with milk; coffee beverages with milk; coffee-based beverages; cocoa-based beverages; chamomile-based beverages; tea-based beverages; tea beverages with milk; chocolate beverages with milk; chocolate-based beverages; flowers or leaves for use as tea substitutes; chicory [coffee substitute]; herbal teas; tea; kelp tea; iced tea.

35 – Demonstration of goods; consultancy regarding advertising communication strategies; consultancy regarding public relations communication strategies; provision of an online marketplace for buyers and sellers of goods and services; presentation of food and beverages on communication media, for retail purposes; sales promotion of food and beverages for others; publicity material rental; dissemination of advertising matter; advertising; commercial administration of the licensing of the goods and services of others; administration of consumer loyalty programs; administrative processing of purchase orders; retail services for food and beverages; procurement services for others [purchasing goods and services for other businesses].

43 – Snack-bar services; café services; cafeteria services; rental of cooking apparatus; rental of chairs, tables, table linen, glassware; rental of tents; rental of transportable buildings; restaurant services; self-ser-

vice restaurant services; bar services; food and drink catering.

(260) AM 2023 120688 A
 (800) 1700835
 (151) 2022 08 31
 (891) 2022 08 31
 (731) Guangdong Mancando Information Technology Co., LTD.
 Floor 22 (Whole Floor), Vanke Sanyuanli Center, No. 31, Airport Road, Baiyun District, Guangzhou City, 510080 Guangdong Province, China

(540)



(591) Black, white
 (531) 27.05.01; 27.05.17; 28.03
 (511)

12 – Adhesive patch for tube or tire; repair outfits for inner tubes; adhesive rubber patches for repairing inner tubes; traction pad for vehicle tires; inflatable inner tube for wheels; pneumatic tyres; inner tubes for pneumatic tires; casings for pneumatic tires; treads for retreading tires; tubular tires; tire patch; spikes for tyres; tire mousse inserts; tire repair patch; inner tube (automobile tire); automobile tires; inner tube of car tire; commercial vehicle tire; anti-skid spikes for vehicle tires; inner tube for vehicle tire; tyres for vehicle wheels; tyres, solid, for vehicle wheels.

(260) AM 2023 120693 A
 (800) 1273220
 (151) 2015 08 26
 (891) 2022 11 11
 (731) Arla Foods a/s
 Sønderhøj 14, DK-8260 Viby J, Denmark
 (540)



(591) Black, white
 (511)
 29 – Milk and milk products, including cheese and yoghurt; condensed and dehydrated milk; strained yoghurt; cream (dairy products); whipped cream; cream cheese; cheese spreads; milk and cream in powder form; milk based dessert mousses; edible oils and fats; cheese sticks; cheese bites; snack bites mainly based on cheese; soups; preparations for making soups; vegetable soup preparations; mixes for making soup; soup powders; soup cubes; soup pastes; dairy puddings; dessert sauces based on dairy products; powders for making milk based desserts, including souffles and

mousses; non-dairy whipped cream (vegetable fat based whipped cream).

30 – Sauces, including cooking sauces, tomato sauces, tomato based sauces, bechamel sauces and cheese sauces; flavourings for soups; puddings; puddings in powder form; powders for making puddings.

(260) AM 2023 120694 A

(800) 1608562

(151) 2021 06 08

(891) 2022 09 20

(731) Guangdong Nanguang Photo&Video Systems Co., Ltd.

Dongli Section, Highway 324, Chenghai, Shantou City, Guangdong Province, China

(540)

NANLITE

(591) Black, white

(531) 27.05.01; 27.05.09; 27.05.17

(511)

9 – Flashlights [photography]; flash-bulbs [photography]; camera flashes; photograph apparatus cases; photograph apparatus bags; darkroom lamps [photography]; remote control apparatus; downloadable software applications for mobile phones; light-emitting diodes [LED]; light dimmers [regulators], electric; video cameras; optical condensers; microcontrollers; chargeable batteries, electric.

11 – Lamps; LED lamps; light-emitting diodes [LED] lighting apparatus; LED light bulbs; luminous tubes for lighting; fluorescent lamp tubes; arc lamps; spotlights; stage lighting apparatus; reflector spotlights for photography; light projectors; light diffusers.

(260) AM 2023 120738 A

(800) 1700975

(151) 2022 04 12

(891) 2022 04 12

(731) Meraji Nicolai

Str. Lesnaia nr. 1, MD-6112 Beșghioz, Ceadăr-Lunga, Republic of Moldova

(540)

BANZAI

(591) Black, white

(511)

29 – Meat, fish, poultry and game; meat extracts; preserved, frozen, dried and cooked fruits and vegetables; jellies, jams, compotes; eggs, milk and milk products; edible oils and fats.

(260) AM 2023 120740 A

(800) 1701049

(151) 2022 08 18

(891) 2022 08 18

(731) Airgsm PTE. LTD.

79 ANSON ROAD, #23-01, Singapore 079906, Singapore

(540)



(591) Black, orange, brown

(531) 26.04.04; 26.04.09; 26.11.06; 26.11.07; 26.11.12; 26.13.25; 29.01.15

(511)

9 – Software and applications for mobile devices.

35 – Online retail services.

38 – Telecommunications.

(260) AM 2023 120741 A

(800) 1701054

(151) 2022 11 02

(891) 2022 11 02

(731) Montres Tudor SA

Rue François-Dussaud 3, CH-1211 Genève 26, Switzerland

(540)

BLACK BAY 54

(591) Black, white

(511)

14 – Timepieces, namely, watches, wrist-watches, component parts for timepieces and accessories for timepieces not included in other classes, clocks and other chronometric instruments, chronometers, chronographs (timepieces), watch bands, dials (timepieces), boxes and cases for timepieces and jewelry, watch movements and their parts; jewelry; precious stones and semi-precious stones; precious metals and alloys thereof; pins (jewelry).

(260) AM 2023 120742 A

(800) 1701153

(151) 2022 10 19

(891) 2022 10 19

(731) ResponsAbility Investments AG

Zollstrasse 17, CH-8005 Zürich, Switzerland

(540)



(591) Black, white

(531) 26.04.18; 27.05.01; 27.05.21; 27.05.24
 (511)
 36 – Financial, monetary and banking services; insurance services; real estate affairs.

(260) AM 2023 120779 A
 (800) 1701764
 (151) 2022 09 15
 (891) 2022 09 15
 (731) Joint Stock Company "Alium"
 territory Quarter A, 2, Obolensk settlement,
 Serpukhov, RU-142279 Moscow region,
 Russian Federation

(540)
BEHAPYC
VENARUS

(591) Black, white
 (531) 27.05.01; 28.05
 (511)
 3 – Toothpaste; bleaching preparations and other substances for laundry use; laundry bleach; cleaning, polishing, scouring and abrasive preparations; toiletry preparations; cosmetics; perfumery; essential oils.

(260) AM 2023 120780 A
 (800) 1701811
 (151) 2022 11 17
 (891) 2022 11 17
 (731) Kerry Ingredients France, SAS
 43 Rue Louis Pasteur, F-62575 Blendecques,
 France

(540)

(591) Lime green
 (531) 05.01.05; 05.01.16; 26.04.05; 26.04.15;
 26.04.18; 27.05.01; 29.01.12
 (511)
 29 – Frozen fruit purees; pasteurised fruit purees; frozen fruits; frozen fruit coulis; prepared, dried, cooked and frozen fruits and vegetables.

(260) AM 2023 120781 A
 (800) 1701823
 (151) 2022 07 25
 (891) 2022 07 25
 (731) Euro Games Technology Ltd.
 4, "Maritsa" Str., "Vranya-Lozen-Triugulnika",
 BG-1151 Sofia, Bulgaria

(540)

(591) White, orange, yellow, silver and black
 (531) 26.04.18; 27.05.01; 27.05.03; 27.05.17;
 29.01.15
 (511)
 9 – Software; computer gaming software; computer software packages; computer operating system software; computer software, recorded; software drivers; virtual reality software; games software; entertainment software for computer games; computer programs for network management; operating computer software for main frame computers; monitors (computer hardware); computer hardware; apparatus for recording images; monitors (computer programs); computer game programs; computer programs for recorded games; apparatus for recording, transmission or reproduction of sound or images; communications servers [computer hardware]; electronic components for gambling machines; computer application software featuring games and gaming; computer software for the administration of on-line games and gaming; computer hardware for games and gaming; hardware and software for gambling, gambling machines, gambling games on the Internet and via telecommunication network.

28 – Gaming machines for gambling; chips for gambling; mah-jong; arcade games; gambling machines operating with coins, notes and cards; games; electronic games; parlor games; gaming chips; gaming tables; slot machines [gaming machines]; LCD game machines; slot machines and gaming devices; coin-operated amusement machines; roulette chips; poker chips; chips and dice [gaming equipment]; gaming equipment for casinos; roulette tables; gaming roulette wheels; casino games; gambling machines and amusement machines, automatic and coin-operated; coin-operated amusement machines and/or electronic coin-operated amusement machines with or without the possibility of gain; boxes for coin-operated machines, slot machines and gaming machines; electronic or electrotechnical amusement machines and apparatus, gaming machines, coin-operated entertainment machines; housings for coin-operated machines, gaming equipment, gaming machines, machines for gambling; electropneumatic and electrical gambling machines (slot machines).

41 – Gambling; entertainment services related to gambling; gaming services for entertainment purposes; casino, gaming and gambling services; training in the development of software systems; provision of gaming equipment for gambling halls; providing casino equipment [gambling]; gaming machine entertainment services; providing casino facilities [gambling]; gaming hall services; amusement arcade services; games

equipment rental; rental of gaming machines; providing amusement arcade services; rental of gaming machines with images of fruits; editing or recording of sounds and images; sound recording and video entertainment services; hire of sound reproducing apparatus; provision of gaming equipment for casinos; providing of casino facilities; online gambling services; casino, gaming and gambling services; provision of gaming facilities, gaming hall facilities, Internet casinos and online gambling services.

(260) AM 2023 120782 A

(800) 1701825

(151) 2022 08 30

(891) 2022 08 30

(731) Limited Liability Company "Kombinat Konditerskikh Izdeliy "Ageyevskiy"
Pobeda avenue, bld. 75 A, letter I, RU-440047
Penza city, Russian Federation

(540)



(591) Violet

(531) 05.07.02; 28.05; 29.01.05

(511)

30 – Vanilla flavorings for culinary purposes; flavourings, other than essential oils, for cakes; flavourings, other than essential oils, for beverages; coffee flavorings; food flavourings, other than essential oils; baozi; bagels; cereal bars; high-protein cereal bars; pancakes; savory pancakes; brioches; bread rolls; pains au chocolat; edible paper wafers; edible rice paper; edible paper; burritos; vanillin [vanilla substitute]; waffles; natural sweetening substances; binding agents for ice cream; malt biscuits; mirror icing [mirror glaze]; cake frosting [icing]; glucose for culinary purposes; toast; gluten additives for culinary purposes; yeast; thickening agents for cooking foodstuffs; leaven; rice-based snacks; cereal snacks; coffee substitutes; vegetal preparations for use as coffee substitutes; zephyr [confectionery]; fruit jellies [confectionery]; candy decorations for cakes; confectionery for decorating Christmas trees; flour confectionery; peanut confectionery; almond confectionery; fruit confectionery; pasta; ground ginger; frozen yogurt [confectionery ices]; cocoa; caramels [candies]; quiche; gluten prepared as foodstuff; flour-based dumplings; candies; liquorice [confectionery]; peppermint sweets; mints for breath freshening; dulce de leche; cinnamon [spice]; coffee; unroasted coffee; food starch; crackers; rice crackers; crème brûlée; custard; croissants; hominy grits; semolina; oatmeal; crushed barley; groats for human food; corn, milled; corn, roasted; potato-based flatbreads; rice cakes; macarons [pastries]; marzipan; honey; meringue; royal jelly; buckwheat flour; tapioca flour; nut flours; flour; wheat flour; soya flour; barley

flour; confectionery in the form of mousses; chocolate mousse; granola; mint for confectionery; cocoa beverages with milk; coffee beverages with milk; coffee drinks; cocoa-based drinks; chamomile-based beverages; tea-based beverages; chocolate beverages with milk; chocolate-based beverages; chocolate-based fillings for cakes and pies; custard-based fillings for cakes and pies; nougat; apple fritters; onigiri; chocolate covered nuts; nutmeg; stick liquorice [confectionery]; ginger paste [condiment]; treacle; pâtés en croûte; cookies; coconut macarons; almond cookies; sugar cookies; petit-beurre biscuits; custard cookies; pies; pastries; pizza; fondants [confectionery]; popcorn; baking powders; pralines; food flavourings; condiments; cereal preparations; oat-based food; profiteroles; gingerbread, including gingerbread without glazing; spices; petits fours; puddings; rice pudding; cake powder; fruit coulis [sauces]; ravioli; crystallized rock sugar; palm sugar; processed seeds for use as a seasoning; agave syrup [natural sweetener]; golden syrup; sweets; savory pancake mixes; cookie mixes; batter mixes; baking soda [bicarbonate of soda for cooking purposes]; table salt; celery salt; sorbets [ices]; cranberry sauce [condiment]; soy sauce; tomato sauce; sauces [condiments]; pasta sauces; apple sauce [condiment]; spaghetti; chocolate spreads; chocolate spreads containing nuts; preparations for stiffening whipped cream; soufflés [pastries]; breadcrumbs; sushki [bread rings]; sandwiches; tacos; tapioca; tarts; dough; cookie dough; frozen cookie dough; almond paste; rice pulp for culinary purposes; cake batter; tortillas; cakes; frozen cakes; chocolate decorations for cakes; vinegar; bakery products; chips [cereal products]; cornflakes; oat flakes; hot dogs; cheeseburgers [sandwiches]; chocolate; essences for foodstuffs, except etheric essences and essential oils; husked barley.

(260) AM 2023 120784 A

(800) 1701831

(151) 2022 09 15

(891) 2022 09 15

(731) Joint Stock Company "Alium"
Territory Quarter A, 2, Obolensk Settlement,
Serpukhov, Ru-142279 Moscow Region,
Russian Federation

(540)

Венапус

(591) Black, white

(531) 28.05

(511)

5 – Pharmaceuticals; veterinary preparations; hygiene preparations for medical purposes; dietetic substances adapted for medical use; food for babies; plasters; dressings, medical; teeth filling material; dental impression materials; disinfectants; preparations for destroying noxious animals; fungicides; herbicides; acaricides; aconitine; alkaloids for medical purposes; algici-

des; aldehydes for pharmaceutical purposes; dental amalgams of gold; dental amalgams; amino acids for veterinary purposes; amino acids for medical purposes; antibiotics; aluminium acetate for pharmaceutical purposes; acetates for pharmaceutical purposes; germicides; balms for medical purposes; hygienic bandages; bandages for dressings; biocides; bromine for pharmaceutical purposes; paper for mustard plasters; fly catching paper; mothproofing paper; petroleum jelly for medical purposes; vaccines; oxygen baths; aseptic cotton; absorbent cotton; wadding for medical purposes; radiological contrast substances for medical purposes; nutritive substances for microorganisms; radioactive substances for medical purposes; bismuth subnitrate for pharmaceutical purposes; melissa water for pharmaceutical purposes; seawater for medicinal bathing; mineral waters for medical purposes; thermal water; dietary fibre; moulding wax for dentists; gases for medical purposes; guaiacol for pharmaceutical purposes; haematogen; haemoglobin; hydrastine; hydrastinine; glycerine for medical purposes; glycerophosphates; glucose for medical purposes; gentian for pharmaceutical purposes; hormones for medical purposes; mustard for pharmaceutical purposes; mustard plasters; mud for baths; medicinal mud; gamboge for medical purposes; gurjun balsam for medical purposes; deodorants, other than for human beings or for animals; diastase for medical purposes; digitalin; feed additives for medical purposes; mineral dietary supplements; nutritional supplements; yeast for pharmaceutical purposes; gelatine for medical purposes; cod liver oil; isotopes for medical purposes; insecticides; iodine for pharmaceutical purposes; iodides for pharmaceutical purposes; alkaline iodides for pharmaceutical purposes; iodoform; calomel [fungicide]; cream of tartar for pharmaceutical purposes; tartar for pharmaceutical purposes; camphor for medical purposes; capsules for medicines; cachets for pharmaceutical purposes; pastilles for pharmaceutical purposes; haemostatic pencils; wart pencils; caustic pencils; carbolineum [parasiticide]; caustics for pharmaceutical purposes; cachou for pharmaceutical purposes; quassia for medical purposes; quebracho for medical purposes; gallic acid for pharmaceutical purposes; acids for pharmaceutical purposes; adhesives for dentures; fly glue; cocaine for medical purposes; collodion for pharmaceutical purposes; corn rings for the feet; medicated sweets; angostura bark for medical purposes; barks for pharmaceutical purposes; cedar wood for use as an insect repellent; condurango bark for medical purposes; croton bark; mangrove bark for pharmaceutical purposes; myrobalan bark for pharmaceutical purposes; quinquina for medical purposes; medicinal roots; rhubarb roots for pharmaceutical purposes; lint for medical purposes; starch for dietetic or pharmaceutical purposes; creosote for pharmaceutical purposes; blood for medical purposes; cultures of microorganisms for medical or veterinary use; curare; dental lacquer; liquorice for pharmaceutical purposes;

milk sugar for pharmaceutical purposes; adhesive plasters; medicines for alleviating constipation; lecithin for medical purposes; lotions for veterinary purposes; dog lotions; lupulin for pharmaceutical purposes; magnesia for pharmaceutical purposes; liniments; ointments for pharmaceutical purposes; sunburn ointments; mercurial ointments; gauze for dressings; anti-horsefly oils; medicinal oils; mustard oil for medical purposes; camphor oil for medical purposes; castor oil for medical purposes; oil of turpentine for pharmaceutical purposes; dill oil for medical purposes; dental mastics; dental abrasives; surgical dressings; serotherapeutic medicines; medicines for veterinary purposes; medicines for human purposes; medicines for dental purposes; menthol; medicinal drinks; moleskin for medical purposes; almond milk for pharmaceutical purposes; royal jelly for pharmaceutical purposes; milk ferments for pharmaceutical purposes; Irish moss for medical purposes; lacteal flour for babies; flour for pharmaceutical purposes; linseed meal for pharmaceutical purposes; fish meal for pharmaceutical purposes; mint for pharmaceutical purposes; medicine cases, portable, filled; dietetic beverages adapted for medical purposes; malted milk beverages for medical purposes; narcotics; medicinal infusions; tincture of iodine; eucalyptol for pharmaceutical purposes; tinctures for medical purposes; opium; opodeldoc; decoctions for pharmaceutical purposes; antiparasitic collars for animals; stick liquorice for pharmaceutical purposes; sulfur sticks [disinfectants]; diapers for incontinence; pants, absorbent, for incontinence; pectin for pharmaceutical purposes; pepsins for pharmaceutical purposes; peptones for pharmaceutical purposes; hydrogen peroxide for medical purposes; pills for pharmaceutical purposes; leeches for medical purposes; blood plasma; eyepatches for medical purposes; poultices; compresses; scapulars for surgical purposes; bunion pads; breast-nursing pads; pomades for medical purposes; powder of cantharides; pyrethrum powder; belts for sanitary napkins [towels]; anti-uric preparations; bacterial preparations for medical and veterinary use; bacteriological preparations for medical and veterinary use; balsamic preparations for medical purposes; albuminous preparations for medical purposes; biological preparations for veterinary purposes; biological preparations for medical purposes; bismuth preparations for pharmaceutical purposes.

(260) AM 2023 120785 A
 (800) 1701849
 (151) 2022 11 17
 (891) 2022 11 17
 (731) Evonik Operations GmbH
 Rellinghauser Str. 1-11, 45128 Essen, Germany

(540)

ZEODENT

(591) Black, white

(511)
1 – Silicon dioxide used as a rheology agent and abrasive in the dentifrice industry.

(260) AM 2023 120786 A

(800) 1701861

(151) 2022 10 24

(891) 2022 10 24

(731) Obshchestvo s ogranichennoy Otvetstvennostyu "Retel"

Zvenigorodskoe sh., 28, str. 2, pomeshchenie 1, komnata 1, RU-123317 Moskva, Russian Federation

(540)

BROOKLANDS
БРУКЛЭНДС

(591) Black, white

(531) 27.05.01; 27.05.11; 28.05

(511)

37 – Motor vehicle maintenance and repair; burglar alarm installation and repair; upholstery repair; installation and repair of air-conditioning apparatus; leather care, cleaning and repair; rustproofing; disinfecting; vehicle greasing; vehicle washing; painting, interior and exterior; vehicle polishing; retreading of tyres; re-tinning; anti-rust treatment for vehicles; vehicle service stations [refuelling and maintenance]; vehicle maintenance; varnishing; vehicle cleaning; vehicle breakdown repair services; dry cleaning; providing information relating to repairs; sanding; vulcanization of tyres [repair]; rebuilding engines that have been worn or partially destroyed; rebuilding machines that have been worn or partially destroyed; vehicle battery charging; tyre balancing.

(260) AM 2023 120787 A

(800) 1701876

(151) 2022 06 07

(891) 2022 06 07

(731) Asbisc Enterprises PLC

Iapetou 1, Agios Athanasios, CY-4101 Limassol, Cyprus

(540)

Prestigio
SOLUTIONS

(591) Black, white

(531) 26.04.04; 26.04.05; 26.04.06; 26.04.18;
26.04.24; 27.05.01; 27.05.24

(511)

9 – Apparatus and instruments for recording, transmitting, reproducing or processing sound, images or data; data processing apparatus; electronic numeric displays; electronic interactive whiteboards; electronic notice boards; video screens; computers; software;

computer software applications, downloadable; interactive multimedia panels [monoblocks]; stands for interactive panels; wall-mounted holders for interactive panels; software applications for interactive panels; liquid crystal displays [LCDs]; touchscreen kiosks for accessing information; interactive information kiosks; software applications for liquid crystal displays; software applications for information kiosks; interactive information touchscreen tables; LED displays for shelves and stands; LED screens; LED screens for displaying dynamic information; monoblocks [computers]; audiovisual multimedia apparatus; camcorders; microphones; sound controllers; speakers, loudspeakers; audiovisual apparatus for arranging conference calls; electronic tags for goods; stands and holders adapted for electronic price tags; controllers for electronic price tags; portable terminals for electronic price tags; software adapted for electronic price tags.

(260) AM 2023 120788 A

(800) 1701890

(151) 2022 10 17

(891) 2022 10 17

(731) Salesforce Inc.

Salesforce Tower, 415 Mission St, 3rd Fl, San Francisco CA 94105, USA

(540)

+ + + + +
+ a b | e a u

(591) Black, white

(531) 24.17.05; 24.17.06; 27.03.01

(511)

9 – Computer software for data mining, data query, and data analysis.

41 – Educational services, namely, conducting seminars, conferences, workshops, and computer application training in the fields of data mining, data query, and data analysis.

42 – Providing temporary use of on-line non-downloadable software for data mining, data query, and data analysis.

(260) AM 2023 120789 A

(800) 1701927

(151) 2022 08 10

(891) 2022 08 10

(731) Seqirus UK Limited

Point, 29 Market Street, Maidenhead, Berkshire SL6 8AA, United Kingdom

(540)

CSL SEQIRUS

(591) Black, white

(511)

1 – Chemical and biological reagents in this class; cell cultures and media in this class; laboratory and scientific test kits in this class; chemical preparations for scientific and/or industrial purposes; diagnostic and testing agents; chemical and biological reagents for non-medical purposes; chemical and biological reagents for industrial use for anti-body screening, blood grouping, and for the typing and detection of specific blood cells, determining the presence of antigens on blood cells, and the detection of relevant complement compounds and immunoglobulin subtypes; chemical test kits for the detection of specific blood cells, determining the presence of antigens on blood cells, and the detection of relevant complement compounds and immunoglobulin subtypes for laboratory or research use; chemical preparations for industrial use for anti-body screening, blood grouping, and the typing and detection of specific blood cells.

5 – Pharmaceutical preparations and substances in this class; vaccines; blood products; products derived from blood and products derived from recombinant DNA technology; serums; antibodies; medical and veterinary test kits; influenza vaccines; adjuvants and antigens; pharmaceutical preparations and substances for the treatment and/or prevention of blood or bleeding disorders; blood products, namely, blood plasma, reagent blood cells; products derived from blood and products derived from recombinant DNA technology, namely, immunoglobulins, human albumin, blood clotting factors, plasma volume expanders, blood proteins for therapeutic use; serums, namely, anti-venoms; medicated serums for the treatment of blood or bleeding disorders; test kits, namely, invitro diagnostic reagent test kits for use in detecting cell mediated immune response; pharmaceutical preparations and substances, namely, RhD reagents for the detection of specific antigens or in blood typing; pharmaceutical preparations, namely, reagent red blood cells used to detect antibodies or IgG subtypes; pharmaceutical preparations, namely, monoclonal and polyclonal antibodies; pharmaceutical preparations, namely, reagents for medical/clinical use for the typing and detection of specific blood cells, and the detection of relevant complement components and immunoglobulin subtypes.

41 – Education services including medical education services; health education; consultancy services relating to education; provision of education services via an online forum; provision of training and education courses; publication of educational materials; dissemination of educational material; weblog (blog) services; electronic publication of information on a wide range of topics, including online and over a global computer network.

42 – Scientific and technological services; research and development services relating to scientific, medical, pharmaceutical and blood products; industrial

analysis; clinical trials; conducting clinical trials; provision of testing facilities; rental of research facilities; laboratory analysis and research; management of scientific research projects; preparation of technical studies, technical reports, scientific reports; management of scientific research projects, preparation of scientific and medical research projects, preparation of statistics or reports relating to scientific and medical research; provision of research services and facilities, provision of research results, information and outcomes; provision of information relating to the aforementioned services; advisory and consultancy services relating to the aforementioned services; dissemination of information relating to the aforementioned services over a global computer network; medical laboratory services, namely, scientific testing and screening services, namely, testing of human blood plasma for safety and quality; medical laboratory services regarding human blood plasma; hosting an Internet-based database where patients can enquire about medical issues and procedures from other patients and can relay information about their medical experiences for support.

44 – Medical services; medical information services; health care services; health care information services; patient support services; providing medical information concerning blood products; providing medical information concerning vaccines, anti-venoms and immunohaematology products, namely, diagnostic reagents; patient support services, namely, providing patient medical information where patients can enquire about medical issues and procedures from other patients and can relay information about their medical experiences for support and community via an Internet-based database.

(260) AM 2023 120791 A

(800) 1701976

(151) 2022 07 29

(891) 2022 07 29

(731) Euro Games Technology Ltd.

4, "Maritsa" Str., "Vranya-Lozen-Triugulnika",
BG-1151 Sofia, Bulgaria

(540)

20 Super 7 Flame

(591) Black, white

(511)

9 – Operating computer software for main frame computers; monitors (computer hardware); computer hardware; apparatus for recording images; monitors (computer programs); computer game programs; recorded computer game programs; apparatus for recording, transmission or reproduction of sound or images; communications servers (computer hardware); electronic components for gambling machines; computer application software featuring games and gaming; computer software for the administration of online games and gaming; computer hardware for games

and gaming; computer hardware for games and gambling, on the Internet and via telecommunication network; downloadable computer game software for gambling machines on the Internet and via telecommunication network; computer systems; computer operating system software; computer terminals; interactive terminals; multimedia terminals; electronic terminals for generating lottery tickets; interactive touch screen terminals; computer touchscreens; electronic display panels; liquid crystal display screens; digital signage display panels; multimedia software; multimedia apparatus and instruments; interactive multimedia software for playing games; computer screens; led large-screen displays; liquid crystal displays [leds] for home theatres; media streaming software; computer application software for streaming audio-visual media content via the Internet; software; computer gaming software; computer software packages; computer operating system software; computer software, recorded; software drivers; virtual reality software; games software; entertainment software for computer games; computer programs for network management; electronic lottery tickets; computer software platforms; operating systems; interactive computer systems; operating system programs; computer game software for use with on-line interactive games.

28 – Gaming machines for gambling; chips for gambling; mah-jong; arcade games; gambling machines operating with coins, notes and cards; games; electronic games; parlor games; gaming chips; gaming tables; slot machines [gaming machines]; LCD game machines; slot machines and gaming devices; coin-operated amusement machines; roulette chips; poker chips; chips and dice [gaming equipment]; gaming equipment for casinos; roulette tables; gaming roulette wheels; casino games; automats and gambling machines; coin-operated amusement machines and/or electronic coin-operated amusement machines with or without the possibility of gain; boxes for coin-operated amusement machines, slot machines and gaming machines; electronic or electrotechnical amusement machines and apparatus, gaming machines, coin-operated entertainment machines; housings for coin-operated amusement machines, gaming equipment, gaming machines, machines for gambling; electropneumatic and electrical gambling machines (slot machines); lottery games; electronic targets for games and sports.

41 – Gambling; entertainment services related to gambling; gaming services for entertainment purposes; casino, gaming and gambling services; training in the development of software systems; provision of gaming equipment for gambling halls; providing casino equipment [gambling]; gaming machine entertainment services; providing casino facilities [gambling]; gaming hall services; games equipment rental; rental of gaming machines; providing amusement arcade services; rental of gaming machines with images of fruits;

editing or recording of sounds and images; sound recording and video entertainment services; hire of sound reproducing apparatus; provision of gaming equipment for casinos; providing of casino facilities; online gambling services; casino services; provision of gaming facilities and gaming hall facilities, Internet casinos and online gambling services; lottery services; organization of lotteries; provision of games by means of a computer based system; online interactive entertainment; on-line casino services; online game services through mobile devices; providing online entertainment in the nature of game tournaments; providing on-line information in the field of computer gaming entertainment; sports betting services; online sports betting services; providing online games and games of chance, in particular using non-downloadable gaming software.

(260) AM 2023 120792 A

(800) 1701982

(151) 2022 06 20

(891) 2022 06 20

(731) Analitika One Limited

16 Great Queen Street, Covent Garden, London WC2B 5AH, United Kingdom

(540)

KOVCHEG

(591) Black, white

(511)

36 – Financial, monetary and banking services; financial information, data, advice and consultancy services; financing and funding services; fundraising and financial sponsorship; arranging fundraising activities; arranging charitable collections for others; arranging charitable fundraising activities; arranging fundraising; arranging of financing for humanitarian projects; arranging of funds for overseas aid projects; charitable fund raising; charitable fund raising in view of disaster precautions and prevention; charitable fund raising in relation to victims of a foreign political regime, for political asylum or political migration; charitable fundraising; charitable fund raising services; charitable fundraising services; charitable fundraising services for underprivileged children; charitable fundraising services by means of organizing and conducting galas; charitable services, namely financial services; financial grant services; financial sponsorship; financial sponsorship and patronage; fund raising; fund raising for charitable purposes; fund raising services; fund raising for charity; fund-raising services; fundraising; fundraising services; investment of funds for charitable purposes; organisation of financial collections; organization of monetary collections; philanthropic services concerning monetary donations; political fund-raising services; political fundraising; political fundraising consulting; providing information relating to charitable fundraising; financial sponsorship (financial -); advisory, information and

consultancy services in relation to any of the aforesaid.

45 – Safety, rescue, security and enforcement services; guarding and protection services; security services for the protection of property and individuals; security services for the protection of individuals; providing information on issue relating to human rights; security services for the protection of victims of a foreign political regime, for political asylum or political migration; preparation of legal reports in the field of human rights relating to victims of a foreign political regime, for political asylum or political migration; legal services, legal advice; legal administration services; legal support services; mediation services; personal legal affairs consultancy; preparation of legal reports; providing information on issues concerning human rights; legal services in the field of immigration; legal services in relation to the protection of victims of a foreign political regime, for political asylum or political migration; legal assistance: immigration assistance; advisory services relating to regulatory affairs; arbitration, mediation and dispute resolution services; lobbying services, other than for commercial purposes; organization of political meetings; political advice political advisory services; political campaign consulting; political communications services; political consulting; political information services; political lobbying services; political research and analysis; political services; providing information on issues concerning human rights; advisory, information and consultancy services in relation to any of the aforesaid.

(260) AM 2023 120793 A

(800) 1702045

(151) 2022 06 10

(891) 2022 06 10

(731) Fédération Internationale de Football

Association (FIFA)

FIFA-Strasse 20, CH-8044 Zurich, Switzerland

(540)

FIFA 

(591) Black, white

(531) 24.13.25; 26.01.06; 26.01.24; 27.05.01;
27.05.17

(511)

9 – Eyeglasses, sunglasses, diving and swimming goggles, cases, cords and chains for sunglasses and eyeglasses; binoculars; magnets and decorative magnets; directional compasses; electronic monitoring instrument clusters; electronic control mechanisms for automobile propellants; electronic control mechanisms for automobile bodies and chassis; remote door locking systems; Hi-Fi audio systems and components; apparatus for recording, transmitting, editing, mixing and reproducing of sound and images; radios; television apparatus; flat screens; liquid crystal display screens; high-definition and plasma screens; home cinema sys-

tem apparatus; video recorders; compact disk players; portable CD players; DVD players; MP3 players; players containing music in digital format; cassette players; mini-disk players; loudspeakers; headphones; earphones; microphones; remote controls, voice-activated remote controls; navigation apparatus; PDAs (personal digital assistants); computers; data processing apparatus; computer keyboards; computer screens; modems; computer carrying cases; computer mice; mouse pads; electronic pocket translators; dictating apparatus; electronic notebooks and agendas; scanners; printers; photocopiers; facsimile machines; telephone apparatus; telephone answering machines; video telephones; cellular telephones; cases for cellular telephones; devices for handsfree use of mobile phones; earphones and headsets for cellular telephones; keyboards for cellular telephones; cellular telephone straps; special bags for carrying cellular telephones; mobile telephone handsets which include a camera feature; photographic cameras and video cameras integrated into cellular telephones; smart watches; calculating machines; credit card readers; cash exchanging machines; automated teller machines; automated teller machine (ATM); video cameras, portable video cameras with built-in videocassette recorders (camcorders); photographic equipment, photographic apparatus, cameras (cinematographic apparatus), projectors, exposed films, photographic slides, flash-bulbs (photography); special cases and cords for photographic apparatus and instruments; electric batteries and cells; karaoke apparatus and programs for karaoke; video game disks; voice-activated or manually-activated remote controls; software (recorded computer programs), including software for games; computer programs; data bank management software; screensaver software; magnetic, digital or analog recording media, recorded or not, for sounds or images; video disks, video tapes, magnetic tapes, magnetic disks, DVDs, floppy disks, optical disks, compact disks, mini-disks, CD-ROMs, all the aforesaid goods being blank or pre-recorded with music, sound or images (which may be animated); holograms; magnetic cards (encoded), including gift vouchers; memory adapters (computer equipment); smart cards [integrated circuit cards]; memory sticks (blank or prerecorded); integrated circuit cards (smart cards); microchip or magnetic credit cards, microchip or magnetic phone cards, microchip or magnetic cards for cash dispensers, microchip or magnetic cards for automated teller and money exchange machines, microchip or magnetic prepaid cards for mobile phones, microchip or magnetic travel and entertainment cards, microchip or magnetic check guarantee and debit cards; coded credit cards; digital dashboards; alarms; remote control apparatus for opening and closing vehicle doors; windsocks (for indicating wind direction); photovoltaic cells and solar electric panels; gauges; distance-measuring apparatus; apparatus for measuring and displaying speed; downloadable electronic publications; downloadable electronic

road maps; audio receivers, sound amplifiers; computer software and hardware, including set-top boxes, which can convert, supply, receive and transmit audio and video data; disk drives for computers; rechargeable batteries; protective helmets for sports; magnetic identification bracelets; electronic tickets; tickets in the form of magnetic cards; virtual reality headsets for game consoles; downloadable computer software for enabling consumers and companies to manage digital collectibles using a blockchain-based software technology and smart contracts featuring players, games, recordings, statistics, information, photos, images, game sequences, highlights and experiences in the field of football.

16 – Money clips for holding bank notes; tablecloths of paper; towels of paper; bags of paper; invitation cards; greeting cards; cardboard packaging boxes in collapsible form; gift-wrapping paper; coasters of paper, doilies and place mats of paper; garbage bags of paper or of plastics; plastic shopping bags; food wrappers; labels of paper or cardboard, hand towels of paper; tissues of paper for removing make-up; boxed tissues; handkerchiefs of paper; writing materials and school supplies (except apparatus); magnetic boards; typewriters; paper for typewriters, paper for copiers and letter paper (stationery); envelopes, themed pads of paper; notepads; writing books; scribble pads; binders, archiving boxes; document sleeves, book covers; bookmarks; lithographs; framed or unframed paintings (pictures); painting pads, drawing pads, books of games, crosswords and puzzles; luminous paper; self-adhesive labels, not of textile; crêpe paper; tissue paper, staples; staplers; flags of paper; pennants (flags) of paper; writing instruments; nibs; pencils; pens; pen sets; pencil sets; felt pens, felt-tip pens; ballpoint pens; felt-tip markers; ink; inking pads; rubber stamps; paint boxes; coloring and drawing pencils; chalks; decorations for pencils (stationery articles); printing blocks; magazines; newspapers; books and journals, particularly concerning athletes and sports events; printed teaching material; schedules (for recording results); event programs; event albums; photograph albums; autograph books; address books; diaries (planners); diaries (personal journals), road maps; entry tickets; airplane tickets and boarding passes; bank checks; printed timetables; circulars and pamphlets; comic strips; collectable trading cards; collectable trading cards in the field of sports; stickers for cars; stickers; sticker albums; calendars; posters; photographs; postcards; stamps; commemorative stamp sheets; advertising signs and banners of paper or cardboard; transfers (decalcomanias); office requisites (except furniture); correcting fluids; rubber erasers; pencil sharpeners; stands for pens and pencils; paper clips; thumbtacks; drawing rulers, adhesive tapes for stationery; adhesive tape dispensers; stencils; stencil plates; clipboards; notepad holders; bookends; stamps (seals); credit cards without magnetic coding; suitcase

labels; passport holders; cords for identity cards of paper.

25 – Clothing; shoes; headwear; shirts; knitwear (clothing); pullovers, sweatshirts; slipovers; tee-shirts; vests; jerseys; dresses; sports dresses; skirts; sports skirts; underwear; swimsuits, two-piece swimsuits (bikinis); tankinis; dressing gowns (robes); shorts; trousers; sweaters; stocking caps; caps; hats; scarves; headscarves; long scarves; shawls; visors; peaked caps; tracksuits; sweatshirts; jackets; sports jackets; stadium jackets; blazers; waterproof clothing; coats; uniforms; neckties; wristbands (clothing); wristbands against perspiration; bandeaux (clothing); gloves; aprons; bibs (not of paper); pajamas; play suits for infants and children; clothing for babies; socks and stockings; garters; belts; suspenders; sandals, flip-flops; sports shoes, namely, outdoor shoes, hiking shoes, basketball shoes, cross-training shoes, cycling shoes, indoor sports shoes, footwear for track and field athletics, tap shoes, football shoes (indoor and outdoor), football boots, canvas shoes, tennis shoes, street sports shoes, sailing shoes, aerobic shoes; clothing for athletic use, namely, fleece sweaters, jogging suits, sports knitwear, sports pants, polo shirts, sweatshirts, running pants, football style jerseys, rugby style jerseys, socks, bathing suits, warming tights and stockings, tracksuits, functional underwear, jerseys, tops with integrated bra, leotards, snow suits, snow jackets, snow pants.

35 – Advertising; commercial business management; commercial administration; employment agency services; personnel recruitment; advertising services through sponsorship; sales promotion of media rights; promotion of sports events in the field of soccer; on-line advertising services; information and advisory services in relation to commercial business management and commercial administration provided online or via the Internet; advertising and promotional services; dissemination of advertising and promotional materials; provision and rental of advertising space and advertising material; publication of advertising material and texts; rental of advertising time in film credits; television advertising, radio advertising; promotion of sports events in the field of football; promotion of the goods and services of third parties; company sponsorship research (sponsoring via advertising promotion) in relation to football competitions; compilation of advertisements for use as web pages on the Internet or on wireless electronic communication devices; provision of space on web sites for advertising goods and services; provision of an online marketplace for buyers and sellers of goods and services; on-line auction services; collection of directories for publication on the Internet and on wireless electronic communication networks; promotional marketing services; services provided by an agency for sports promotion and public relations; market study services; marketing research services; public opinion polling ser-

vices; organization of events, exhibitions, trade fairs and shows for commercial, promotional purposes; organization of advertising for trade fairs; data bank management services; compilation of statistics; collection of data, statistics and other information on sports performances; organization advice and business management; business consulting for companies; organization of promotional competitions; providing commercial information; advertising for sports events in the field of football; retailing services, including online retailing services, in relation to articles of common metals, tools and utensils, optical, audiovisual, magnetic, electric and electronic apparatus and equipment, medical apparatus and equipment, lighting, heating, cooking, refrigeration, drying and ventilation apparatus and equipment, vehicles and accessories therefor, articles of precious metals, jewelry and horological and chronometric instruments, badges and pins, musical instruments, articles of paper and cardboard, printed and stationery articles, tickets for sports events, articles of leather and imitation leather, luggage and bags, umbrellas, furniture, promotional and exhibition articles, textile articles, clothing, headgear and footwear, ribbons, cords and derivatives, floor coverings, games, toys, sports articles, food and foodstuffs, non-alcoholic and alcoholic beverages, solvents, paraffin, wax, bitumen and petroleum, motor spirits, oils, lubricants, transmission fluids, brake fluids, anti-freeze solution, coolant fluids, hydraulic fluids, fats, gasoline, gasoline for engines, diesel fuel, mazut, fuel gas, combustible gas, biofuel, hubcaps, tires, tire casings, alloys for wheels, sun screens, roof rails, carriers for transporting sports equipment, seat covers, car covers, potato chips, French fries, milk, milk beverages, drinking yogurts, milkshakes, dairy products, cheeses, soy milk (milk substitute), non-alcoholic beverages, mineral and aerated waters, energy drinks, isotonic drinks, fruit and vegetable drinks and juices, beers, lagers and ales, alcohol-free beers, coffee, tea, cocoa, cakes, cookies (biscuits), crackers, candy, edible ices, confectionery, chocolate confectionery, chocolate, corn chips, mustard, vinegar, sauces (condiments), hamburgers (sandwiches), cheeseburgers (sandwiches), sandwiches with fish, meat or vegetables, hotdogs (sandwiches), enabling customers to conveniently view and purchase those goods in stores or on the Internet or via wireless electronic communication; retail services for foodstuffs and beverages; retail sale of food and beverages enabling customers to conveniently view and purchase these food and beverages; retailing services for food in restaurants, school dining rooms, cafeterias, bakeries, delicatessens, company dining rooms, specialty food stores (ice cream stores, yogurt stores, cafés, cookie stores); retail services, including online retail services, in connection with fuel, kerosene, fuel gas, bio-fuel, motor oils and greases, lubricants and greases, hydraulic transmission oils and fluids, fluids for hydraulic circuits and hydraulic oils, enabling customers to view

and purchase those goods in stores or via the Internet or via wireless electronic communication; commercial administration services for the processing of sales made on the Internet or on wireless electronic communication devices; business administration services, namely, billing; sales promotion, namely creation of preferential programs for customers; ticket sale promotion services; customer loyalty services and customer club services for commercial, promotional and/or advertising purposes; compilation of data into a central file, namely still or animated images; retailing service for footwear, headwear, eyewear articles, articles of apparel, bags, sports bags, backpacks, sports equipment, balls for football games, works of art, trophies, toys and non-downloadable virtual accessories; services providing online marketplaces for the sale and purchase of virtual goods via Internet sites; services for organizing and conducting events and exhibitions for commercial purposes in the field of interactive entertainment, virtual reality, consumer electronics and video games; online retailing service for virtual reality and augmented reality software and hardware; online retailing service for virtual reality content and digital content, especially, pre-recorded music, video, images, text, audiovisual content and virtual reality and augmented reality game software.

38 – Telecommunication services; communications by telephones and mobile telephones; electronic communication services by telephone; radio communications; paging services; teleconferencing services; television program broadcasting; radio program broadcasting; press and news agency services; rental of telephone apparatus, facsimile and other telecommunication apparatus; transmission of commercial Internet pages online or via wireless electronic communication devices; radio and television programming and broadcasting services provided via satellite, cable or wireless networks; electronic transmission of messages; provision of access time to a blog, chat room, bulletin board or discussion service; provision of access to live chat rooms online and electronic bulletin boards enabling transmission of messages, comments and multimedia content among users, for creating a network of contacts; provision of access time to Internet sites containing road maps, information about driving directions and the location of businesses; computer-aided transmission of messages and images; rental of access time to private and commercial purchasing and ordering services via computer, a global computer network and/or interactive communication technologies; electronic mail services; provision of connections for telecommunications via data banks or the Internet; provision of access time to websites for listening to digital music on the Internet via wireless electronic communication devices; transmission (or broadcasting) of radio and television programs relating to sports and sports events; broadcasting of radio or television programs related to sports and sports events; providing connections to computer installati-

ons (telecommunications services); rental of access time to a centralized computer and to data banks; rental of access time on the Internet via a global computer network or via wireless electronic communication devices; real-time transmission (streaming) of video and audio material from the Internet; real-time transmission (streaming) of audio, video and television material; provision of access time to search engines; telecommunications services, namely, electronic transmission of virtual reality data and content.

41 – Education; training; provision of training courses; entertainment; entertainment services in the nature of public projections of sports events; organization of sporting and cultural events and activities; organization of lotteries and competitions; organization of sporting competitions and events in the field of football; providing sports facilities; fun park services; health and fitness club services; rental of audio and video equipment; production, presentation, publication and/or rental of films, sound and video recordings; publication and/or rental of interactive educational and entertainment products, namely films, books, compact discs, DVDs, mini-discs, CD-ROMs; publication of statistics and other information on sports performances; publication of radio and television reports of sports events; production and editing services for radio and television programs; photography services; photographic, audio and video recording services; production of cartoons; production of animated television programs; seat booking services for entertainment and sporting events; ticket reservation services for entertainment and sporting events; ticket sales agency services for sports events; timing of sports events; recording of sports events; organization of beauty contests; interactive entertainment; gambling services; provision of raffle services; online game services; providing online entertainment in the nature of tournaments; organization of computer game competitions including online game competitions; information relating to entertainment or education, provided on-line from a computer database or the Internet or on wireless electronic communication devices; electronic game services provided via a global computer network (the Internet) or via wireless electronic communication devices (entertainment); editing of books; electronic publication of books and journals online; entertainment services provided via chat rooms on a global computer network (the Internet) or through wireless electronic communication devices; entertainment services in the form of cinema performances; translation services; interpreter services; corporate hospitality services in the form of entertainment services; ticket agency services in connection with sports or entertainment events; providing entertainment services in VIP lounges and sky boxes both within and outside stadiums; provision of online information concerning sport and sports events from a computer databank or the Internet; entertainment services, namely, online providing of footwear, headwear, eye-

wear, clothing, bags, sports bags, backpacks, sports equipment, balls for football games, works of art, trophies, non-downloadable virtual games and toys for use in virtual environments, virtual reality games, interactive video games; entertainment services (virtual reality content and experience) provided via the Internet and other communication networks; coordinating and conducting competitions for promoting the use and development of entertainment in the nature of electronic games, virtual reality games, augmented reality games, electronic game pieces, and entertainment-related computer hardware and software with respect to entertainment in the nature of video games; organizing and conducting conferences in the field of interactive entertainment, virtual reality, consumer electronics and video games.

(260) AM 2023 120794 A
 (800) 1702071
 (151) 2022 03 17
 (891) 2022 03 17
 (731) KYB Corporation
 4-1, Hamamatsu-cho 2-chome, Minato-ku,
 Tokyo 105-5128, Japan

(540)

KAYABA

(591) Black, white
 (511)
 7 – Cutter loaders; coal-cutting machines; coal loaders; rock drills; diggers [machines]; extractors for mines; mining machines and apparatus; mechanical shovels; excavating machines; truck cranes; concrete mixers; cranes; conveyors [machines]; belts for conveyors; cargo handling machines; mobile cranes; hydraulic jacks; pneumatic jacks; jacks [machines]; winches; cranes [lifting and hoisting apparatus]; loading and unloading machines; car lifts; lifting apparatus; electric welding machines; electric welding apparatus; electric arc welding apparatus; impact wrenches; buffers [power driven, hand-operated]; metalworking machines; molds [parts of machines]; grinding machines; metal cutting machines; foundry machines; mixing machines; agitators; crushing machines; disintegrators; reapers; cultivators [machines]; harvesting machines; sowers [machines]; raking machines; painting machines; colour-washing machines; cylinders for machines; grease rings [parts of machines]; piston rings; piston segments; pistons [parts of machines or engines]; connecting rods for machines, motors and engines; hydraulic controls for motors and engines; sealing joints [parts of engines]; cylinders for motors and engines; motors other than for land vehicles; engine cylinders for land vehicles; pumps for land vehicle engines; fuel pumps for land vehicle engines; rotary pumps; hydraulic pumps; oil pumps with electric motors; oil pumps; pumps [machines]; pumps [parts of machines, engines or motors]; pumps; compressors

[machines]; ball joints [machine elements], other than for land vehicles; axles for machines; journals [parts of machines]; transmission shafts, other than for land vehicles; bearings [parts of machines]; bearings for transmission shafts; shaft couplings [machines]; hydraulic actuators, other than for land vehicles; hydraulic cylinders [parts of machines]; hydraulic motors; electric cylinders, other than for land vehicles; cylinders for industrial robots; actuators for industrial robots; reduction gears, other than for land vehicles; speed change gears, other than for land vehicles; gear boxes, other than for land vehicles; gears, other than for land vehicles; torque converters, other than for land vehicles; pulleys; transmissions for machines; transmission mechanisms, other than for land vehicles; machine wheelwork; hydraulic torque converters, other than for land vehicles; pneumatic or hydraulic linear actuators, other than for land vehicles; machine couplings and transmission components for machines; shock absorbers for machines; dampers [parts of machines]; shock absorber plungers [parts of machines]; springs [parts of machines]; springs being parts of machines, not for land vehicles; brake pads, other than for vehicles; brakes for machines; brake valves; valves [parts of pumps]; valves [parts of machines]; hydraulic valves being parts of machines; road sweeping machines, self-propelled; wheel tread cleaning devices; pneumatic door openers; pneumatic door closers; electric door openers; electric door closers; hydraulic door openers; hydraulic door closers; electric motors and parts thereof, other than for land vehicles; industrial robots and their parts and fittings; arms for industrial robots; pumps for power steering apparatus for automobiles.

9 – Electronic control apparatus for power steering system; electronic control apparatus for suspension system; electronic control apparatus for semi-active suspension system of railway cars; electronic control apparatus for active suspension systems of railway rolling stock; electronic control apparatus for electric shock absorbers; electronic control apparatus for electro-hydro valves of forklift trucks; electronic control apparatus for hydraulic valves; electronic control apparatus for hydraulic transmission system of drum rotation of concrete mixer trucks; electronic control apparatus for hydraulic pumps; electronic control apparatus for pumps; electronic control apparatus for vehicle engines; electronic control apparatus for oil pumps with electric motors; electronic control apparatus for oil pumps; electronic control apparatus for vibration control system that reduces building shake from wind and earthquakes; electronic control apparatus for vehicle transfer cases; electronic control apparatus for motors for vehicles; electronic control apparatus for collecting road surface condition data and information; computer software for vehicle operation control system; electronic circuits; computer programs, downloadable; computer software applications, downloadable; electrical and

electronic control apparatus and instruments; solar batteries; electric accumulators; electric batteries; measuring instruments; measuring apparatus; oil analyzers; testing apparatus not for medical purposes; acceleration sensors; temperature sensors; position sensors for cylinders; position sensors; proximity sensors; sensors [measurement apparatus], other than for medical use; material testing instruments and machines; strength testing machines and instruments; durability testing machines and apparatus; fatigue testing machines and instruments; pressure testing machines and instruments; testing machines and instruments for shock absorbers; monitoring and inspecting apparatus for road surface conditions; pressure measuring apparatus; measuring or testing machines and instruments; electromagnetic coils; position tracking and monitoring apparatus for concrete mixing vehicles and vehicles; Global Positioning System [GPS] apparatus; GPS tracking and location devices; monitoring apparatus, other than for medical purposes; video surveillance apparatus; vehicle tracking devices; electronic surveillance apparatus; remote control apparatus; remote monitoring equipment; dashboard cameras; rearview cameras for vehicles; camcorders; transmitters [telecommunication]; wireless communication machines and apparatus; parts and fittings for wireless communication machines and apparatus; telecommunication machines and apparatus; personal digital assistants; event recorders; solenoid valves [electromagnetic switches]; simulators for the steering and control of vehicles; vehicle driving simulators for training purposes; laser pointers; sunglasses; eyeglasses; eyewear; spectacles; downloadable music files; electronic publications; downloadable image files; fireproof automobile racing suits for safety purposes; fire-resistant clothing; articles of protective clothing for wear by motorcyclists for protection against accident or injury; helmets for motorcyclists.

(260) AM 2023 120795 A
 (800) 1702075
 (151) 2022 03 11
 (891) 2022 03 11
 (731) Innova Patent GmbH
 Konrad-Doppelmayr-Straße 1, A-6922 Wolfurt,
 Austria
 (540)

doppelmayr

(591) Black, white
 (511)
 6 – Structures of metal for transportation facilities, namely for railways, material lines, air cable railways, magnetic railways, funiculars and cable cars; containers of metal for storage, transport and packaging; metal containers for the storage and transportation of goods; building and construction materials and elements of metal; portable cabins of metal; structures and transportable buildings of metal; railway material

of metal; rails of metal; rail fastenings of metal; building materials of metal; wire for ropes; telpher cables; cables, wires and chains, of metal; ironmongery of metal for building; metal hardware; metal clamps; staples for construction use; pipes and tubes of metal; metal pallets; racks [structures] of metal; handling pallets of metal; bindings of metal; cladding panels of metal; tanks of metal; closures of metal for containers; loading pallets of metal; tension links; wire stretchers [tension links]; tension levers of metal; metal sheet, strip and coil; materials of metal for railway construction; loading gauge rods of metal for railway wagons; loading gauge rods of metal for railway wagons; railway material of metal; cabins made of metal; storage sheds of metal; seating platforms of metal; parts and fittings for all the aforesaid goods, as far as these goods are not included in other classes.

7 – Transporting machines; transporting machines; conveyors; conveyors and conveyor belts; conveyor rollers; conveying chains; conveyors [machines]; belt pulleys; winches; capstans; starters for motors and engines; linings for brakes [parts of machines]; driving devices for machines; pneumatic controls for machines, motors and engines; hydraulic controls for machines, motors and engines; springs [parts of machines]; bearings [parts of machines]; ball-bearings; couplings for machines; machine coupling and transmission components (except for land vehicles); couplings, other than for land vehicles; cranes [lifting and hoisting apparatus]; roller bridges; holding devices for machine tools; chucks [parts of machines]; electric hoists; hydraulic lifting gear; pneumatic hoists; driving devices for machines; cowlings [parts of machines]; joints [parts of engines]; lifting installations for the transport of persons and goods; lifts for use with vehicles; pneumatically operated lifting jacks [machines]; lifting and hoisting equipment, lifts; service lifts; moving walkways; drives for conveyors; drives for machines, in particular for storage and retrieval units for conveying piece goods; variable speed drives for machines; power transmission belting for machines; drive belts; drive chains; driving motors; lift installations; drives for elevators; lifts for loads, materials and for car parks; torque converters and speed governors for machines, motors and engines; power-operated boat lifts; electrically operated drain cleaning machines; unmanned transport conveyors being machines; palletisation machines; pallet transferring machines; control mechanisms for machines, engines or motors, in particular for storage and retrieval units [machine parts]; transfer machines; parts and fittings for all the aforesaid goods, none of the aforesaid goods included in other classes.

9 – Electrical controls; electronic controllers; automatic control apparatus; software; software for monitoring, analysing, controlling and running physical world operations; electric control panels; remote control apparatus; remote controls for motors; monitoring

units [electric]; measuring, detecting, monitoring and controlling devices; sensors, detectors and monitoring instruments; remote control apparatus for opening and closing doors; door opening and closing detecting sensors; seat controls; communications equipment; apparatus for transmission of communications; electronic communication installations; computers for autonomous-driving vehicles; computer systems for automated vehicle control; computer programs to operate vehicles; on board electronic systems for automatic braking; autonomous driving control systems for vehicles; vehicle automatic driving control devices; computer programs for use in autonomous control of vehicles; simulators for the steering and control of vehicles; vehicle autonomous driving systems featuring interactive displays; security software; safety, security, protection and signalling devices; security warning apparatus; parts and fittings for all the aforementioned goods, as far as these goods are not included in other classes.

12 – Vehicles and conveyances; transport carriages; aerial conveyors; carts; self-driving transport vehicles; driverless transporter vehicles; mine cars; conveying installations [ski lifts]; ski lifts; rail vehicles; funicular railcars; cable car cabins; unmanned conveying vehicles; telpher railways [cable cars]; trains [vehicles]; rail Vehicles; unmanned vehicles; remotely operated vehicles; trolleys [vehicles]; trolleys [vehicles]; driverless cars [autonomous cars]; cable transport apparatus and installations; container cars; cars for cable transport installations; vehicle seats; rail vehicles; chassis for railway cars; modular chassis systems for vehicles; couplings for land vehicles; couplings and transmission components for land vehicles; clutch mechanisms for motor cars; trailers [vehicles]; hoods for vehicle engines; chairlifts; gears for vehicles; anti-dazzle devices for vehicles; brake facings; brakes for vehicles; braking systems for vehicles and parts thereof; brake shoes for land vehicles; electronic brakes for vehicles; pallet transfer trucks; bodies for land vehicles; lorries; tipping bodies for lorries; automatically guided [driverless] material handling trucks; pickup truck caps; wheels; motor car windows; shock absorbers for bicycles; vehicle bumpers; springs for vehicle suspension systems; springs for vehicle suspension systems; air springs for vehicle suspension components for cushioning driver's seats and cabs; armrests for automobile seats; head restraints for vehicles; car seat canopies; crankcases for land vehicle components, other than for engines; powertrains, including engines and motors, for land vehicles; turbines for land vehicles; shafts for land vehicles; undercarriages; windshield wipers; railway carriages; railway couplings; vehicle chassis; funiculars; cable transport installations; autonomous vehicles, autonomous conveyances, in particular, transport carriages, aerial conveyors, self-driving transport vehicles, driverless transporter vehicles, mine cars, conveying installations [ski lifts], ski lifts, rail vehicles, funicular railcars, ca-

ble car cabins, unmanned conveying vehicles, telpher railways [cable cars], vehicles, trains [vehicles], rail vehicles; travelling trucks; ski lifts; parts and fittings for any of the aforesaid goods, the aforesaid goods not included in other classes.

19 – Building and construction materials and elements, not of metal; parts and fittings for the above-mentioned goods, none of the aforesaid goods included in other classes.

37 – Repair or maintenance of conveyors; vehicle maintenance; overhaul of vehicles; installation of conveyors; maintenance and repair of public transport vehicles; lift and elevator installation, maintenance and repair; maintenance and repair services relating to automatic door equipment; repair or maintenance of railway rolling stock; vehicle maintenance and repair; maintenance and repair of gears; maintenance and repair of chassis parts and bodies for vehicles; installation of parts for vehicles; installation of prefabricated building elements; assembly [installation] of accessories for vehicles; overhaul of machines; machinery maintenance services; renovation of machinery; repair of machines; construction; installation of machinery.

39 – Transport; transport; transportation logistics; transport services; forwarding of goods; passenger transport; passenger transport; vehicle transport services; cable-car transport; transportation of freight; storage; storage.

41 – Training; provision of training courses; organisation of seminars; organisation of seminars; seminars; arranging and conducting of conferences, congresses and symposiums; tour guide services relating to tourist destinations for cultural, entertainment, sports or educational purposes; tourist entertainment consultancy relating to the strategic orientation of adventure destinations and tourism locations for cultural, entertainment, sports or educational purposes; entertainment services in the nature of creation of tourist master plans for cultural, entertainment, sports or educational purposes; planning of tourist adventure concepts relating to cultural, entertainment, sports or education; entertainment services at family parks for cultural, entertainment, sports or educational purposes; entertainment services relating to tourism destinations for cultural, entertainment, sports or educational purposes; entertainment services in the nature of creation of plans for tourism destinations for cultural, entertainment, sports or educational purposes.

42 – Technical engineering; conducting technical project studies; technical project planning; industrial testing; technical design; technical research; preparation of technical studies; engineering services; engineering consultancy services; engineering research; technological engineering analysis; mechanical engineering; technical project planning in the field of engineering; engineering services for the design of structures; engineering services for the design of machinery; engine-

ering services for the analysis of machinery; technological and industrial research services; software development; technical planning of play areas; technical planning of family parks; engineering project management services; rental of computer hardware and computer software; creation, maintenance and adaptation of software; drafting services, design, planning, relating to the following sectors: buildings, building constructions; technical drawing; design, graphic art design, relating to the following sectors: tourist facilities, infrastructure.

(260) AM 2023 120796 A

(800) 1702123

(151) 2022 05 25

(891) 2022 05 25

(731) Willgrow UAB

Vilniaus st. 18, LT-01402 Vilnius, Lithuania

(540)



(591) Blue, green and white.

(531) 26.01.03; 26.01.12; 26.01.24; 27.05.01; 29.01.12

(511)

35 – Administrative assistance in responding to calls for tenders; administrative assistance in responding to calls for tenders; administrative services for the relocation of businesses; payroll preparation; business management of performing artists; rental of office equipment in co-working facilities; rental of office machines and equipment; book-keeping; negotiation of business contracts for others; wholesale services for pharmaceutical, veterinary and sanitary preparations and medical supplies; data search in computer files for others; data processing services [office functions]; economic forecasting; arranging subscriptions to electronic toll collection [ETC] services for others; financial auditing; photocopying services; rental of photocopying machines; writing of curriculum vitae for others; import-export agency services; compiling indexes of information for commercial or advertising purposes; compilation of information into computer databases; systemization of information into computer databases; online retail services for downloadable and pre-recorded music and movies; online retail services for downloadable ring tones; online retail services for downloadable digital music; provision of an online marketplace for buyers and sellers of goods and services; online ordering services in the field of restaurant take-out and delivery; price comparison services; rental of cash registers; administration of consumer loyalty programs; commercial or industrial management assistance; commercial intermediation services; organization of trade fairs; conducting of commercial events; commercial information and advice for consumers in the choice of products and services; commer-

cial lobbying services; commercial information agency services; provision of commercial and business contact information; updating and maintenance of data in computer databases; computerized management of medical records and files; computerized file management; competitive intelligence services; corporate communications services; interim business management; arranging newspaper subscriptions for others; business management for freelance service providers; reception services for visitors [office functions]; organization of fashion shows for promotional purposes; layout services for advertising purposes; retail services for pharmaceutical, veterinary and sanitary preparations and medical supplies; retail services relating to bakery products; retail services for works of art provided by art galleries; administrative services for medical referrals; modelling for advertising or sales promotion; tax preparation; tax filing services; news clipping services; opinion polling; gift registry services; search engine optimization for sales promotion; auctioneering services; rental of sales stands; shop window dressing; organization of exhibitions for commercial or advertising purposes; outsourcing services [business assistance]; distribution of samples; personnel recruitment; personnel management consultancy; lead generation services; transcription of communications [office functions]; promotion of goods and services through sponsorship of sports events; sales promotion for others; presentation of goods on communication media, for retail purposes; promotion of goods through influencers; demonstration of goods; administrative processing of purchase orders; negotiation and conclusion of commercial transactions for third parties; marketing in the framework of software publishing; psychological testing for the selection of personnel; radio advertising; registration of written communications and data; updating and maintenance of information in registries; advertising; pay per click advertising; direct mail advertising; production of advertising films; dissemination of advertising matter; writing of publicity texts; publication of publicity texts; development of advertising concepts; publicity material rental; updating of advertising material; advertising agency services; rental of advertising time on communication media; publicity services; advertising services to create brand identity for others; advertising by mail order; consultancy regarding advertising communication strategies; rental of billboards [advertising boards]; rental of advertising space; marketing; influencer marketing; market studies; market intelligence services; marketing research; media relations services; sponsorship search; employment agency services; cost price analysis; scriptwriting for advertising purposes; secretarial services; business consulting services for digital transformation; bill-posting; administration of frequent flyer programs; rental of vending machines; typing; compilation of statistics; business project management services for construction projects; shorthand; appointment scheduling servi-

ces [office functions]; appointment reminder services [office functions]; drawing up of statements of accounts; invoicing; word processing; telephone answering for unavailable subscribers; providing telephone directory information; telephone switchboard services; arranging subscriptions to telecommunication services for others; production of teleshopping programmes; telemarketing services; television advertising; procurement services for others [purchasing goods and services for other businesses]; targeted marketing; commercial administration of the licensing of the goods and services of others; outsourced administrative management for companies; providing user reviews for commercial or advertising purposes; consumer profiling for commercial or marketing purposes; providing user rankings for commercial or advertising purposes; business auditing; business efficiency expert services; business information; providing business information via a web site; business investigations; business appraisals; business inquiries; preparation of business profitability studies; professional business consultancy; business intermediary services relating to the matching of potential private investors with entrepreneurs needing funding; business intermediary services relating to the matching of various professionals with clients; business research; business management of sports people; business management and organization consultancy; business management consultancy; business management assistance; advisory services for business management; online advertising on a computer network; outdoor advertising; business management of hotels; public relations services; consultancy regarding public relations communication strategies; web site traffic optimization; web indexing for commercial or advertising purposes.

39 – Rental services related to vehicles, transportation, and storage; vehicle rental; rental of aero engines; horse rental; rental of horses for transportation purposes; rental of horse-boxes; bus chartering; rental of tankers; car rental; arranging car hire as part of package holidays; arranging of car hire; automobile rental reservation services; rental of automobile trailers; chauffeur driven car hire services; rental of car transporters; rental of barges; carpooling services; rental of sailboats; bicycle sharing services; rental of cycles; rental of electric bicycles; rental of electric cars; rental of dolly tracks; railway coach rental; railway truck rental; rental of railway vehicles for use in the reprofiling of rail profiles; rental of railway vehicles; rental of railway vehicles for use in the measurement of rail profiles; rental of railways; hire of rail transport; rental of rowing boats; yacht chartering; rental of canoes; rental of barrows; passenger vehicle hire; hire of road transport; rental of road vehicles; rental of commercial vehicles; rental of goods vehicles; rental of recreational vehicles; rental of ships; rental of motor racing cars; rental of wheelchairs; airplane rental; air charter brokerage services; motorcycle rental; rental of motor road vehicles; motor land vehicle hire

services; motor vehicle rental; contract hire of motor vehicles; motor vehicle hire services; rental of motor-boats; hired car transport; booking of hire cars; provision of hired vehicles; rental of aircraft parts; aircraft rental; loaning and rental of aeroplanes; aircraft charter brokerage; rental of vehicles and apparatus for locomotion by air; aircraft chartering; rental of moving vans; leasing of railroad flatcars; rental of motor homes; leasing of trailers; rental of self-propelled lifting platforms for transportation purposes; automobile vehicle renting services; rental of scooters for transportation purposes; charter of helicopters; providing information relating to aircraft rental services; providing information relating to the rental of vessels; truck and trailer rental; truck and vehicle rental; rental of lorries; rental of tractors; rental of fork-lift trucks; rental of trams; rental of transport vehicles; rental of vehicle parts; contract rental of vehicles; arranging of vehicle hire; reservation services for vehicle rental; loan of vehicles; rental of vehicle roof racks; rental of gps-equipped vehicles; rental of vehicles equipped with nacelles; rental of vehicles equipped with lifting platforms; chartering of vehicles for travelling; vehicle location services; provision of hired vehicles for the transport of passengers; rental of vehicles, in particular automobiles and lorries; chartering of transport; rental of trains; motor coach rental; rental of wagons; push-chair rental; boat rental; rental of hydrogen cars; vessel rental; rental of watercraft; chartering of watercraft, yachts, ships, boats and water vehicles; rental of trolleys; rental of wheelbarrows; rental of traction vehicle and trailers; arranging the hire of all means of transport; rental of space, structures, units and containers, for storage and transportation; hire of waste storage containers; hire of waste handling containers; rental of crates; rental of electric wine cellars; garage rental; providing information relating to the rental of refrigerators; travelling trunk rental; rental of portable storage containers; container rental; container leasing for the shipping industry; rental of containers for warehousing and storage; leasing of cargo container chassis; leasing of pallets for industrial and commercial use; hire of pallet collars; hire of pallet racks; hire of pallet cages; rental of mail boxes; rental of recycling containers; rental of pallets and containers for storage of goods; leasing of pallets for the transport or storage of goods; rental of pallets and containers for transport of goods; rental of storage lockers; rental of freezers; rental of freezers for household purposes; rental of freezers for commercial use; rental of refrigerated storage; rental of frozen food lockers; refrigerator rental; rental of refrigerator-freezers for household purposes; rental of storage cartons; rental of storage facilities; rental of storage space; rental of storage units; leasing of warehouse units; rental of storage containers; rental of warehouses; rental of warehouse space; rental of storage crates; rental of strong rooms; providing information relating to the rental of freezers; parking place rental; rental of security drones; rental

of surveillance drones; rental of photography drones; rental of garages and parking places; rental of deep water diving suits; rental of portable roadways; rental of mechanical parking systems; salvage diving apparatus (rental of -); rental of diving suits; rental of diving bells and diving suits; rental of diving bells; rental of diving helmets; rental of navigational systems; rental of gps equipment for navigational purposes; rental of aircraft engines; rental of packing or wrapping machines and apparatus; rental of packing machines; rental of loading-unloading machines and apparatus; rental of safety seats for children, for vehicles; skip hire service; rental of garage parking places; rental of freezing machines and apparatus; rental of moorings for boats; rental of vehicle parking spaces; rental of parking places and garages for vehicles; rental services related to transportation and storage; providing information relating to the rental of packing or wrapping machines and apparatus; distribution by pipeline and cable; arrangement of the transportation of hydrocarbons; transportation of waste to disposal sites; distribution of renewable energy; arrangement of the transportation of fuels; delivery of fuel to barges; transport of fuels by pipeline; distribution of gas; gas supplying [distribution]; pipeline transport of gases; electricity distribution; distribution and transmission of electricity; electricity distribution via cables; distribution of electricity to households; supply of electricity; electricity supply and distribution; leasing the use of power lines to third parties for the transmission of electricity; distribution of energy; transport of natural gas; transport and distribution of natural gas and liquefied gas; information services relating to the transportation of petroleum; information and advisory services in relation to the distribution of energy; providing information relating to the distribution of electricity; public utility services in the nature of electricity distribution; public utility services in the nature of natural gas distribution; public utilities in the nature of supplying water; consultancy services relating to the distribution of electricity; fuel distribution services; delivery of fuel; transportation of heavy fuel-oil; transmission of oil or gas through pipelines; oil distribution services; transportation of oil by pipeline; transportation of petroleum; collection of sewage through public sewers; distribution of energy for heating and cooling buildings; supply of waste heat; transportation of dry gas; collection of liquid waste; transportation of fluids by pipeline; providing information relating to water supplying services; transport of liquefied natural gas by sea; marine transport of liquefied natural gas; transport by pipeline; water distribution; water distribution and supply; water supplying; supply [transport] of water through pipes; distribution of heat; heat supplying [distribution]; transportation of waste; supply [transport] of water for domestic use; supply [transport] of water for industrial use; supply [transport] of water for agricultural use; transport of water by pipeline; supply of water by pipeline; ser-

vices for the supply of water by pipeline; water transport services; transportation of crude oil; packaging and storage of goods; filling of machines and containers; packing of goods in containers; cash replenishment of automated teller machines; replenishment of vending machines; contract filling of aerosols; filling of containers; loading and unloading of vehicles; loading of coal; loading of scrap; harbour crane unloading; unloading and repackaging services; unloading services; loading of coke; unloading cargo and luggage; unloading cargo; loading of freight containers onto rail vehicles; loading of freight containers onto ships; loading of freight containers onto trucks; loading of cargo; ship unloading; ship loading services; loading and unloading of airplanes; loading of air freight; loading of freight; loading and unloading of goods; loading of ore; loading of trucks; loading of trains; loading of slag; packing of aerosols to order and specification; arrangement of the storage of hydrocarbons; palletised freight distribution services; security storage services [transport]; storage of waste; storage of cargo after transportation; storage of aviation fuel; luggage storage; storage of furniture; cryogenic storage of biological tissue intended for subsequent implantation; storage of brochures; storage of domestic appliances; temperatures controlled storage of chemicals; storage of surgical instruments and equipment; packing of goods for removal; fuel bunkering services [storage]; warehousing of parts; bulk storage; storage of documentary records; storage of documents; gift wrapping; packaging clothing articles for transportation; storing, safekeeping of clothes; storage of clothing; storage of gaseous fuels; gas storage services; storage of electricity from electrical plants; physical storage of electronically stored digital music; physical storage of electronically stored data, documents, digital photographs, music, images, video, and computer games; physical storage of electronically stored digital photographs; physical storage of electronically stored digital video files; physical storage of electronically stored digital images; storage of electricity; storage of energy and fuels; storage of pharmaceuticals; physical storage of electronically stored digital data, photographs, audio and image files; physical storage of electronically stored data or documents; physical storage of electronically stored computer games; storage of freight; storage of weapons; storage of beverages; storage information; information services relating to refrigerated storage; providing information about temporary storage services; providing information relating to the temporary storage of personal belongings; bottling services; storage of yachts; refrigerated storage of seafood; fur storage; storage of passengers luggage; storage of commercial goods; storage of containers and cargo; container storage; storage of cosmetics; storage of cranes; freight warehousing; storage of cargo before transportation; storage of cargo; arrangement of the storage of fuels; temporary safekeeping of personal belongings; temporary storage

of keys; temporary storage of personal belongings; bonded storage; refrigerated warehousing; storage of watercraft, yachts, boats and water vehicles; packing of food; food storage services; storage of fuel oil; coin wrapping services; storage of parts for motor vehicles; storage of waste oil; storage of oil; oil bunkering services [storage]; storage services for aircraft; pallet packaging services; wrapping and packaging services; packaging services; crating services; advisory services relating to the packing of goods; advisory services relating to the storage of goods; hazardous materials warehousing; bonded storage of goods; warehouse storage; packaging of goods; crating of goods; subdividing and repackaging of goods; advisory services relating to the repacking of goods; refrigerated storage of goods; goods warehousing; storage of goods; storage and delivery of goods; storage of goods in warehouses; wrapping of goods; wrapping and packaging of goods; labelling services; packaging articles to the order and specification of others; packaging articles for transportation; storage of radioactive waste; cloak-room services; storage; bonded warehousing; consultancy services relating to storage; ship bunkering services [storage]; provision of warehousing services and facilities; hiring of storage sites; provision of shipborne storage services; cryogenic storage; providing self-storage facilities for others; parcel storage services; storage of packages; temporary storage of deliveries; packing of liquids to order and specification; storage of liquids; providing information relating to warehousing services; storage of liquefied natural gas on ships; brokerage services relating to storage; consultancy in the field of storage services provided by telephone call centers and hotlines; transportation and storage; storage of vehicle parts; refrigerated storage; provision of refrigerated storage facilities; provision of frozen storage facilities; frozen food storage services; storage of vehicles; packaging of goods in transit; storage of goods in transit; storage of contaminated waste; storage of frozen food in warehouses; storage of water in tanks; packing articles for transportation; overnight storage of letters in depots; wrapping services for baggage protection during travel; bonded storage of wines; temperature – and humidity-controlled storage of wines; provision of cold store facilities; storage of farm products; storage of farm products in warehouses; storage of agricultural foodstuffs; transport information, advice and reservation services; agency services for arranging the transportation of persons; agency services for arranging travel; agency services for arranging the transportation of goods; agency services for arranging the transportation of travellers' luggage; agency services for arranging cruises; arranging and booking of city sightseeing tours; booking of sightseeing tours through agencies; booking of holiday travel and travel tours; holiday travel reservation services; booking agency services for car hire; arranging and booking of day trips; provision of data relating to the transportation of passengers; arranging

and booking of excursions and sightseeing tours; arranging and booking of excursions; reservation of rail transport; information services relating to guarded transport; information services relating to the transportation of bitumen; information services relating to traffic speed; information services relating to traffic congestion; provision of information relating to travel routes; information services relating to road conditions; traffic information; information services relating to the movement of cargo; information services relating to the location of goods; information services relating to the transportation of goods; provision of information relating to anchorages; information services relating to transport timetables; information services relating to methods of transport; transportation information; information services relating to the transportation of crude oil; provision of information relating to motoring routes; providing information relating to car rental services; services for the provision of information relating to rail transport; provision of information relating to the transportation of passengers; providing information about travel, via the internet; providing travel information via global computer networks; providing road and traffic information; provision of information relating to road conditions; provision of information relating to road traffic conditions; provision of information relating to the transport of freight; providing flight arrival and departure information; provision of information relating to airline departures; provision of information relating to airline arrivals; fares (provision of information relating to -); services for the provision of information relating to motor transport; providing information about automobiles for lease by mean of the internet; provision of information relating to postal codes; provision of information relating to road transport; provision of information relating to airline scheduling; provision of flight information; providing transport and travel information via mobile telecommunications apparatus and devices; provision of information relating to ports; provision of information relating to marinas; providing information relating to shipbrokerage; booking and reservation services for travel tours; booking agency services relating to travel; trip planning services; arranging and booking of travel; booking of sea passages; agency services for arranging the transportation of travellers; seat reservation services for travellers; travel agency services, namely arranging transportation for travellers; travel agency services for business travel; booking agency services for travel; agents for arranging travel; travel agency services, namely, making reservations and bookings for transportation; travel agents services for arranging travel; travel ticket reservation services; ticketing services for travel; travel information; booking of tickets for travel; reservation and booking of seats for travel; seat reservations for various forms of transport; travel information about disruptions due to adverse weather conditions; planning and booking of travel and transport, via electronic

means; reservation services for travel by sea; travel consultancy and information services; consultancy for travel planning of routes; planning and booking of airline travel, via electronic means; reservation services for airline travel; booking agency services for airline travel; planning, arranging and booking of travel; planning, arranging and booking of travel by electronic means; arranging and booking of tours; travel arrangement and reservation services; travel reservation and booking services; reservation services for travel by land; reservation of seats for travel; booking of tickets for train travel; booking of travel through tourist offices; travel booking agencies; services for the booking of travel; information services relating to traffic; reservation of ferry transport; computerised distribution planning relating to transportation; computerised information services relating to the carriage of passengers; computerised information services relating to travel reservations; computerised information services relating to travel; computerised reservation services relating to the carriage of passengers; provision of travel information by computer; computerised reservation services for travel; computerised distribution advisory services relating to transport; computerised transport information services; travel consultancy; consultancy in the field of air transport; advisory services relating to road transportation; advisory services related to removals; freight brokerage [forwarding (Am.)]; freight and transport brokerage; arranging and booking of cruises; cruise reservation services; shipbrokerage; airline ticket reservation services; arranging airline tickets, cruise tickets and train tickets; booking of seats for transportation by air; reservation of berths for travel; provision of navigational information relating to the aviation; navigational advisory services; reservation of air transportation; provision of airport information services relating to aviation; advisory services relating to the distribution of goods; consultancy services relating to transportation; booking and arranging of access to airport lounges; advisory services relating to the tracking of goods in transit; shipping agency services for arranging the transportation of goods; arranging and booking of travel for package holidays; advisory services relating to the handling of goods; providing online information relating to travel; professional consultancy relating to transport; providing information relating to car transport; providing information relating to the delivery of documents, letters and parcels; providing information relating to bicycle rental services; providing information to tourists relating to excursions and sightseeing; providing information relating to marine transport services; providing information relating to the planning and booking of travel and transport, via electronic means; providing information relating to the planning and booking of airline travel, via electronic means; providing information relating to travel and transport, via electronic means; providing information relating to airline travel, via electronic means;

providing advice relating to freight forwarding services; providing information relating to cargo unloading services; providing information relating to freight brokerage; providing information relating to the rental of wheelchairs; providing information relating to air transport; providing information relating to removal services; providing information relating to the rental of warehouse space; providing information relating to vehicle driving services; providing taxi booking services via mobile applications; reservation of coach transport; consultancy in the field of travel provided by telephone call centers and hotlines; consultancy in the field of business travel provided by telephone call centers and hotlines; consultancy in the field of transport services provided by telephone call centres and hotlines; reservation services for transportation by boat; reservation services for transportation by air; reservation and booking services for transportation; reservation services for transportation by land; provision of transportation tariff information; transport brokerage; booking of transport via global computer networks; booking of rail tickets; booking of seats for transportation by rail; arranging and booking of sightseeing tours; tourist travel reservation services; booking agency services for sightseeing tours; provision of tourist travel information; providing tourist travel information, via the internet; travel tour reservation services; providing information about booking business travel, via the internet; shipping agency services; reservation services for bus transportation; providing transport and travel information; transport reservation; booking of seats for transportation by motor vehicles; booking of seats for travel; booking of seats for coach travel; booking of seats for air travel; booking of seats for rail travel; booking of seats for transportation by water; vehicle parking and storage; parking garages services; car parking [valet] services; provision of car parks and car parking services; provision of car parking facilities; car parking; car park services; boathouse services; garaging; providing information relating to the rental of mechanical parking systems; provision of information relating to moorings; slipping of yachts; harboring services for ships and boats; parking of boats; provision of moorings; aircraft parking; aircraft parking services; airport parking services; valet parking; marina services; depot services for the storage of vehicles; provision of berthing facilities; slipping of boats; boat storage; marina services [berthing, mooring, storage]; marina services [docking services]; vehicle parking; booking of airport parking; services for the garaging of vehicles; providing information relating to vehicle parking services; reservation of parking spaces; transport; travel and passenger transportation; sightseeing, tour guide and excursion services; arranging of sightseeing tours as part of package holidays; planning and arranging of sightseeing tours and day trips; arranging of sightseeing tours and excursions; personal travel tour guide services; arranging of day trips; sightseeing [tourism]; arranging of excursions

as part of package holidays; arranging of excursions; arranging of city sight-seeing tours; arranging of excursions, day trips and sightseeing tours; arranging and conducting of travel tours and sightseeing; arranging and conducting canoe expeditions; arranging and conducting horseback expeditions; services for the arranging of excursions for tourists; organization of sightseeing tours; transport services for sightseeing tours; conducting of sightseeing tours; conducting sightseeing tours for others; arranging and conducting jungle and safari expeditions; arranging of transportation for travel tours; providing vehicles for tours and excursions; provision of sightseeing tours [transport]; services for the arranging of travel tours; travel tour guide services; tour organising; ground support passenger handling services; transport of persons by land; organisation of holiday travel; package holiday services for arranging travel; arranging of holiday transport; bus transport; car sharing services; priority boarding, check-in, seating and reservation services for frequent air travelers; arranging of city sightseeing bus tours; arranging of tours and cruises; arranging of expeditions; coach transport; coordinating travel arrangements for individuals and for groups; timetable enquiry services relating to travel; pleasure boat transport; organisation of trips; yacht and boat charter services; arranging of cruises; arranging transport of passengers by air, rail and sea; arranging of passenger transport; embarking services; passenger coach services; passenger train transport; transportation of travellers' baggage; arrangement for the transportation of passengers by sea; transportation of passengers by coach; transport of people by land; transport of passengers by car; transport of passengers by funicular railway; transport of passengers by rail; passenger transportation services by sea; transport of passengers by road; transportation of passengers by ferryboat; transport of passengers by cruise ship; transportation of passengers by boat; transportation of passengers by minibus; transportation of passengers by airship; passenger transportation services by land; transportation of passengers in chauffeur driven vehicles; transport of passengers by inland water; arrangement of transportation of passengers by ships; arrangement of transportation of passengers by cars; services for arranging the transportation of travellers; arrangement of transportation of passengers by aircraft; arrangement of transportation of passengers by helicopters; arrangement of transportation of passengers by trains; arranging of passenger transportation services for others via an online application; transport of passengers by air; transport of travellers by car; transport of travellers by road; transport of travellers by land; transport of travellers by taxi; transport of travellers by tram; operating of tours; travel agency services for arranging holiday travel; travel agency services relating to travel by omnibus; arranging of travel by coach; supplying tickets to enable holders to travel; travel guide services; travel courier services; travel and tour ticket

reservation service; organization of travel and boat trips; travel and transport reservation services; air travel services; arranging of air travel; tour operator services for the booking of travel; organising of foreign travel; rental of machines which issue tickets for travel; issuing of tickets for travel; arranging for travel visas and travel documents for persons travelling abroad; travel arrangement; organizing and arranging travel; travel services; planning of journeys; operating and organizing of travel tours; travel reservation; travel guide and travel information services; itinerary travel advice services; boat cruises; pleasure boat cruises; providing cruise ships for travel; cruise ship services; cruise ship transport services; provision of cruises in yachts; charitable services, namely, providing transportation to the elderly or handicapped persons; limousine services; itinerary planning services; taxi transport for people in wheelchairs; airline ticket services; provision of transport for passengers by air; airport passenger shuttle services between the airport parking facilities and the airport; escorting of patients during transportation; preferential passenger check-in services; priority air line check-in services; arranging travel tours as a bonus program for credit card customers; propeller airplane transport; airport check-in services; airline check-in services; scheduled passenger airline services; chauffeur services; provision of transport for passengers by land; provision of transport for the elderly by road; road transport services for persons; road transport services for passengers; providing transportation to the elderly or handicapped persons [charitable services]; arranging of flights; arranging the emergency replacement of airline tickets; taxi transport; arrangement of taxi transport; transport of textiles by road; tram transport; transportation check-in services; escorting of travellers; arranging the escorting of travellers; provision of travel tours; travel tour conducting; arranging of overseas travel for cultural purposes; provision of transport for passengers by water; arranging transport for business users; arranging of business travel; minibus transport services; transport services and trips for disabled persons; transport services for the disabled; arrangement of travel to and from hotels; monorail transport; mass transit services for the general public; transport of persons and goods by land, air and water; carriage of persons by urban rapid transit rail systems; navigation (positioning, and route and course plotting); electronic tracking of parcels for third parties; global positioning system navigation services; providing customized driving directions; tracking of passenger or freight vehicles by computer or via gps; tracking of passenger vehicles by computer or via gps; cargo tracking services; tracking and tracing services for letters and parcels; route planning services; route planning [navigation services]; navigation services; ground traffic control services for aircraft; air navigation services; provision of flight plans; air traffic control services; flight planning services; vehicle routing by computer on data

networks; providing driving directions for travel purposes; tracking and tracing of shipments; locating and tracking of people and cargo for transportation purposes; transportation and delivery of goods; freight and cargo transportation and removal services; emptying [removal] of the contents of cesspits; collection of waste skips; removal of waste; collection of containers for waste materials; refuse collection services; waste removal [transport]; clearance [removal and transportation] of waste; waste disposal [transportation]; transportation of plants; car transport; carting of furniture; furniture moving; moving van services; delivery of furniture; transporting furniture; transportation of furniture of others by trucks; moving van transport; transportation of bitumen; household removals; collection of domestic waste; transportation of clothing; collection and transport of electronic scrap; transportation of pharmaceuticals by road; freighting; freight [shipping of goods]; distribution of freight by rail; transportation of animals; import and export cargo handling services; road transport services; transportation of books; collection of commercial waste; removal of commercial furniture; commercial removal services; container handling; transportation of containers; road haulage services for containers; container transport services; transportation of cosmetics; crange services; removal services [moving services]; freight train transport; freight forwarding; freight forwarding by sea; freight forwarding by air; services for freight-forwarding by air; freight forwarding between seaports; freight forwarding agency services; freight-forwarding services; services for freight-forwarding by land; freight shipping; marine freighting; freight ship transport; rail freight services; arranging the unloading of cargo; transport of freight containers by ship; transport of freight containers by rail; transport of freight containers by lorry; filling of vehicles with freight; air cargo transport; packing of freight; freight and cargo services; delivery of cargo by land; cargo delivery services; collection of freight; cargo handling; cargo handling and freight services; transportation of freight; transportation of freight by road; transportation of freight by land; transportation of cargo by land vehicle; transportation of freight by water; sea freight services; courier services for the transportation of cargo; land freight services; container stuffing of ships cargo; filling of vessels with freight; refrigerated transport of food; transportation of medical waste and special waste; transport of motor vehicles; transportation of pet animals; removal of domestic furniture; sewage transportation; sewage disposal [transport] services; dumping [transportation] of sewage waste; airline services for the transportation of cargo; ground support freight handling services provided at airports; arranging for the transport of air freight; launching of satellites; launching of satellites for others; launch and placement in prescribed orbit of satellites of others; collection of recyclable goods [transport]; removal services; lighterage services; paper and cardboard co-

llection for recycling; industrial removal services [transportation]; collection of industrial waste; transport of freight by air; arranging for the transport of goods by sea; transport of goods by inland water; emptying [removal] of the contents septic tanks; pickup and delivery of parcels and goods; clearance [removal and transportation] of liquid waste; transport of building materials; international air freight shipping services; international ocean freight shipping services; overseas removal services; pick-up and delivery of textile goods; garbage collection [trash pickup only]; handling [transport] of rubbish; tanker transport; transportation by marine container ship; vehicle transport services; transportation of vehicles; transport of contaminated waste; transport of contaminated soil; transport by heavy goods vehicles; transport of farm products; mail delivery and courier services; shipping of documents; document delivery; document delivery [hand carried]; document delivery by non-electronic means; collection of documents; delivery of correspondence; correspondence delivery by post and/or messenger; messenger courier services; courier services [messages or merchandise]; courier services for the delivery of goods; messenger services for letters; overnight transportation of letters by air; delivery and forwarding of letters and parcels; pick-up and delivery of letters; forwarding of letters; delivery of letters; collection of letters; overnight transportation of letters by road; air courier services; collection of packages; arranging the collection of packages; franking of mail; post restante services; postal services; mail forwarding; mail delivery; delivery and forwarding of mail; delivery of mail by courier; messenger services for messages; delivery of messages [courier]; message delivery; delivery of goods by messenger; courier services for merchandise; collection, transport and delivery of goods, documents, parcels and letters; transport of parcels; parcel delivery; delivery of parcels by air; delivery of parcels by courier; delivery of parcels by land; arrangement for the delivery of parcels by sea and by air; courier services for the delivery of parcels; parcel receipt services; collection of packages by sea; collection of packages by air; collection of packages by road; transportation of parcels overnight; arranging the transportation of parcels by sea; arranging the transportation of parcels by air; arranging the transportation of parcels; arranging the transportation of parcels by land; parcel collection services; express delivery of letters; services for transporting legal documents; transportation by courier; delivery of spirits; guarded transport of goods; guarded truck transport; transportation of luggage; arranging of baggage transfer; baggage check-in services; collection of luggage; baggage handling; airport baggage handling; transportation by air of baggage; services for the transportation of baggage; luggage trolley service; delivery of groceries; removal of office equipment; transportation of household effects; collection of domestic and industrial waste and trash; delivery of domestic applian-

ce parts; delivery of parts to grounded aircraft via airplane; arranging the delivery of gifts; delivery of gas cookers; forwarding agency services; barge transport; flower delivery; inspection of goods for transportation; handling of passengers luggage; removal of personal effects; arranging for the shipping of goods; portage; road haulage services; hauling; charitable services, namely distribution of clothing; charitable services, namely distribution of blankets; delivery, despatching and distribution of newspapers and magazines; delivery of newspapers; stevedoring; delivery of food by restaurants; food delivery services; distribution [transport] of retail goods; transportation services for medical staff; transportation of works of art; arrangement for the transportation of works of art; removal of household goods; removal of domestic goods; porter services; airline services for the transportation of goods; airport baggage check-in services [not including security inspection]; distribution services; hazardous waste transport services; transshipment services; pizza delivery; transport of money and valuables; transport of money; delivery of hampers containing food and drink; distribution services relating to beverages, such as alcoholic beverages; forwarding of goods; drayage services; transport of goods by rail; transportation of goods in refrigerated conditions; arranging transportation of goods; haulage services; delivery of goods; distribution [transport] of goods by sea; distribution [transport] of goods by air; distribution [transport] of goods by road; delivery of goods by rail; delivery of goods by mail order; arranging the delivery of goods by post; despatch of goods; shipping of goods; collection of goods; collection, transport and delivery of goods; arranging the collection of goods; transport of goods; carting of goods; delivery by road; delivery services; guarded transport of money and valuables; guarded transport of valuables; guarded transportation of valuables and money by lorry; nappy delivery services; transportation of parcels by sea; express delivery of goods; transportation services for nursing staff; truck transport; delivery of gift baskets with selected items regarding a particular occasion or theme; shipping; shipping services; winching of vehicles; porter services [transportation]; arranging and conducting of mail order delivery services; refrigerated transport of frozen goods; refrigerated transport of cold goods; distribution [transport] of frozen semen; transportation of fruit; delivery of bottled water to homes and offices; delivery of food and drink prepared for consumption; delivery of valuables; air transport of valuables; transport of valuables; transport of valuables in security vehicles; carting; truck hauling; transportation and delivery services by air, road, rail and sea; transport services; trolley services for others; haulier (services of a -); delivery of disposable napkins; delivery of wines; delivery of magazines; ground transportation relating to the aviation industry; guarded transportation; transport and storage of waste; dumping [transportation] of waste; bus ferry services;

sailboat transportation services; piloting of civilian drones; provision of data relating to timetables; provision of data relating to methods of transport; launching of spacecraft; transport by two-wheeled motor vehicles; river transport by boat; armoured vehicle transport; ocean shipping; services for chartering railway transport; railway transport; collection of cash from vending machines; animal rescue services [transport]; reservation services for transportation by sea; ship transport; naval tugging services; marine transport; chartering of marine vessels; operation of canal lock gates; passenger cargo services; arranging transportation of passengers by road, rail, air and sea; passenger transport; operating of road and motorway tolls; ferry-boat transport; ferryboat operating; transport of cranes; wharfage services; charitable services, namely providing transportation; boat transport; ship chartering; piloting of ships; ice-breaking; ice breaking for the shipping industry; cable car transport; operating toll roads; transport of oil; aircraft handling; airline and shipping services; airport passenger check-in services; airline services; air transport; airline transport; services for arranging transportation by air; air transportation services featuring a frequent flyer bonus program; arranging of air transport; airport transfer services; airport services; provision of airport facilities for aviation; rescue, recovery, towing and salvage services; piloting; ambulance transport; arranging and providing transport by land, sea and air; arranging transport services by land, sea and air; provision of dry dock facilities; helicopter transport; weighbridge services; bridge operation; inland waterway transport; operation of transporter bridges; arranging of transport and travel; transportation logistics; armoured-car transport; operating canal locks; arrangement of transportation; management of vehicular traffic flow through advanced communications network and technology; chartering of vehicles for transportation; vehicle-driving services; operation of stations used for transport purposes; transit services; tunnels (operation of -); turbojet airplane transport; transport of travellers; port services [docking services]; river transport; operation of locks and bridges used for transport purposes; air charter services; chauffeur services; boat chartering; transport by road; transport by land; transport by water; transport by inland water; transport by man-powered vehicles; arranging ferry transportation; motor vehicle transport services; services for the arranging of transportation; arranging transportation by land, sea, and air; services for arranging transportation by road; services for arranging transportation by rail; services for arranging transportation by water; services for the operation of tugs; parking and vehicle storage, mooring.

- (260) AM 2023 120797 A
- (800) 1702142
- (151) 2022 07 25
- (891) 2022 07 25
- (731) Euro Games Technology Ltd.
4, "Maritsa" Str., "Vranya-Lozen-Triugulnika",
BG-1151 Sofia, Bulgaria

(540)



- (591) Red, yellow, orange, purple, blue, cyan and brown
- (531) 03.11.01; 27.03.03; 27.05.03; 29.01.15
- (511)
9 – Software; computer gaming software; computer software packages; computer operating system software; computer software, recorded; software drivers; virtual reality software; games software; entertainment software for computer games; computer programs for network management; operating computer software for main frame computers; monitors (computer hardware); computer hardware; apparatus for recording images; monitors (computer programs); computer game programs; computer programs for recorded games; apparatus for recording, transmission or reproduction of sound or images; communications servers [computer hardware]; electronic components for gambling machines; computer application software featuring games and gaming; computer software for the administration of on-line games and gaming; computer hardware for games and gaming; hardware and software for gambling, gambling machines, gambling games on the Internet and via telecommunication network, all the aforesaid goods in class 9 for use in the field of gambling.
- 28 – Gaming machines for gambling; chips for gambling; mah-jong; arcade games; gambling machines operating with coins, notes and cards; games; electronic games; parlor games; gaming chips; gaming tables; slot machines [gaming machines]; LCD game machines; slot machines and gaming devices; coin-operated amusement machines; roulette chips; poker chips; chips and dice [gaming equipment]; gaming equipment for casinos; roulette tables; gaming roulette wheels; casino games; gambling machines and amusement machines, automatic and coin-operated; coin-operated amusement machines and/or electronic coin-operated amusement machines with or without the possibility of gain; boxes for coin-operated machines, slot machines and gaming machines; electronic or electrotechnical amusement machines and apparatus, gaming machines, coin-operated entertainment machines; housings for coin-operated machines, gaming equipment, gaming machines, machines for gambling; electropneumatic and electrical gambling machines (slot machines).

41 – Gambling; entertainment services related to gambling; gaming services for entertainment purposes; casino, gaming and gambling services; training in the development of software systems; provision of gaming equipment for gambling halls; providing casino equipment [gambling]; gaming machine entertainment services; providing casino facilities [gambling]; gaming hall services; amusement arcade services; games equipment rental; rental of gaming machines for gambling purposes; providing amusement arcade services; rental of gaming machines with images of fruits; editing or recording of sounds and images; sound recording and video entertainment services; hire of sound reproducing apparatus; provision of gaming equipment for casinos; providing of casino facilities; online gambling services; casino, gaming and gambling services; provision of gaming facilities, gaming hall facilities, Internet casinos and online gambling services.

(260) AM 2023 120798 A
 (800) 1702152
 (151) 2022 07 15
 (891) 2022 07 15
 (731) Shenzhen Anycubic Technology Co., Ltd.
 1201-1314, Bldg 3B, Vanke Times Square,
 No.85 Longcheng Ave, Shangjing Community,
 Longcheng Street, Longgang District,
 Shenzhen, Guangdong, China
 (540)



(591) Black, white
 (531) 26.15.09; 27.05.01
 (511)
 7 – 3D printers; engraving machines; machines for processing plastics; 3D bioprinters; washing apparatus.
 9 – Computer peripheral devices; computer software applications, downloadable; downloadable software applications for mobile phones; 3D scanners; protective films adapted for computer screens; light-emitting diodes [LED]; video screens; printed circuit boards; computer software, recorded.
 17 – Synthetic rubber; rings of rubber; synthetic resins, semi-processed; artificial resins, semi-processed; plastic filaments for 3D printing; plastic film, other than for wrapping; filtering materials of semi-processed films of plastic; flexible hoses, not of metal; non-conducting materials for retaining heat; padding materials of rubber or plastics.

35 – Advertising; presentation of goods on communication media, for retail purposes; business management assistance; sales promotion for others; provision of an online marketplace for buyers and sellers of goods and services; office machines and equipment rental; rental of vending machines.

42 – Technological research; industrial design; packaging design; computer software design; software as a service [SaaS]; platform as a service [PaaS]; software development in the framework of software publishing; providing virtual computer systems through cloud computing; user authentication services using single sign-on technology for online software applications; graphic design of promotional materials.

(260) AM 2023 120799 A
 (800) 1702223
 (151) 2022 10 11
 (891) 2022 10 11
 (731) Palfinger AG
 Lamprechtshausener Bundesstraße 8,
 A-5101 Bergheim bei Salzburg, Austria
 (540)

PB

(591) Black, white
 (511)
 7 – Lifting and hoisting equipment; platform lifts; lifting platforms; aerial work platforms; mobile elevating work platforms; lifting ramps; self-propelled working baskets; mechanical, mobile access platforms; powered access work platforms; mobile platforms, in particular loading platforms; lifting and lowering platforms for servicing, maintenance and for the construction of buildings, building exteriors, power lines, utility poles, wind power plants.
 12 – Attachments for land vehicles and land vehicle trailers, in the form of lifting and hoisting equipment; tailboard lifts [parts of land vehicles]; land vehicles incorporating lifting apparatus, especially incorporating platforms for lifting persons; land vehicle trailers incorporating lifting apparatus, especially, incorporating platforms for lifting persons; driverless cars [autonomous cars] incorporating lifting apparatus, especially, incorporating platforms for lifting persons; remote controlled land vehicles incorporating lifting apparatus, especially, incorporating platforms for lifting persons.

(260) AM 2023 120800 A
 (800) 1702261
 (151) 2022 10 25
 (891) 2022 10 25
 (731) Obshchestvo s Ogranichennoy Otvetstvennostyu "Kub"
 Leningradskiy pr-t, d. 68, str. 24, pom. VIII,

komm. 27, RU-125315 Moscow, Russian Federation

(540)

VMMGAME

(591) Black, white

(511)

20 – Furniture casters, not of metal; armchairs; deck chairs; furniture; furniture of metal; office furniture; school furniture; head-rests [furniture]; trestles [furniture]; pillows; trolleys for computers [furniture]; tables; tables of metal; desks; portable desks; chairs [seats].

(260) AM 2023 120802 A

(800) 1702348

(151) 2022 10 27

(891) 2022 10 27

(731) Individual entrepreneur Muhanov Kirill

Sergeevich

30, d. Vatagino, Balakhninskij r-n, RU-606400 Nizhegorodskaya oblast', Russian Federation

(540)



**BLACK
RUSSIA**

(591) Red, orange, grey and black

(531) 03.01.14; 03.01.16; 03.01.24; 27.05.01; 27.05.09; 29.01.13

(511)

9 – Electronic interactive whiteboards; electronic notice boards; interfaces for computers; audio interfaces; electronic book readers; computer game software, recorded; computer software, recorded; computer software platforms, recorded or downloadable; computer software applications, downloadable; computer game software, downloadable; computer programs, downloadable; computer operating programs, recorded; computer screen saver software, recorded or downloadable; electronic publications, downloadable; downloadable ring tones for mobile phones; downloadable image files; downloadable music files; animated cartoons; downloadable graphics for mobile phones; databases; mobile applications.

(260) AM 2023 120885 A

(800) 1702874

(151) 2022 07 04

(891) 2022 07 04

(731) Egis Gyógyszergyár Zrt.

Keresztúri út 30-38, H-1106 Budapest, Hungary

(540)

DEBONEG

(591) Black, white

(511)

5 – Pharmaceutical preparations for human use; dietetic substances adapted for medical use; vitamin compositions; mineral food supplements; dietary supplements.

(260) AM 2023 120891 A

(800) 1703031

(151) 2022 10 18

(891) 2022 10 18

(731) Odeon Turizm İşletmeciliği A.Ş

Ergenekon Mah. Cumhuriyet Cad., Efser Han 181 4 Şişli, İstanbul, Türkiye

(540)

CORAL TRAVEL GROUP

(591) Black, white

(511)

39 – Land, water and air transport services; rental of land, water or air vehicles; arranging of tours; travel reservation; issuing of tickets for travel; courier services (messages or merchandise); car parking; garage rental; boat storage; transport by pipeline; electricity distribution; water supplying; rescue services for vehicles and goods; storage, wrapping and packaging of goods; transport and storage of trash; transport and storage of waste.

43 – Services for providing food and drink; temporary accommodation; reservation of temporary accommodation; rental of rooms for wedding ceremonies; providing rooms for conferences and various meetings; day-nurseries (crèches); boarding for animals.

(260) AM 2023 120892 A

(800) 1703039

(151) 2022 10 24

(891) 2022 10 24

(731) Energy Dome S.P.A.

Viale Abruzzi 94, I-20131 Milano (MI), Italy

(540)

ENERGY DOME

(591) Black, white

(511)

7 – Current generators; electrical generator stations.

9 – Apparatus and instruments for accumulating and storage of electricity; electricity storage apparatus.

11 – Industrial treatment installations; installations for the collection of gases.

37 – Power infrastructure construction; maintenance of power generating apparatus and installations; maintenance and repair of energy storage installations; installation of plant of energy storage.

39 – Storage of energy and fuels; storage and distribution of electricity; electricity supply and distribution resulting from the operation of energy storage facilities.

(260) AM 2023 120893 A

(800) 1703050

(151) 2022 11 21

(891) 2022 11 21

(731) Roche Diabetes Care GmbH

Sandhofer Strasse 116, 68305 Mannheim,
Germany

(540)



(591) Orange, blue, green, yellow and black

(531) 26.11.03; 26.11.06; 26.11.13; 26.15.01;
27.05.01; 27.05.23; 29.01.15

(511)

35 – Promotion services.

41 – Education services.

44 – Medical services.

(260) AM 2023 120894 A

(800) 1703100

(151) 2022 07 19

(891) 2022 07 19

(731) Polipa Plastik Ambalaj Sanayi Ve Ticaret

Anonim Şirketi

Sancaktepe Mahallesi, Gürpınar Caddesi,
No:6, Silivri, İstanbul, Türkiye

(540)



(591) Blue, red and white

(531) 26.11.01; 26.11.13; 27.05.01; 27.05.07;
29.01.13

(511)

7 – Machines, machine tools and industrial robots for processing and shaping wood, metals, glass, plastics and minerals; construction machines and robotic mechanisms (machines) for use in construction; lifting, loading and transmission machines and robotic mechanisms (machines) for lifting, loading and transmission purposes; elevators, escalators and cranes; machines and robotic mechanisms (machines) for use in agriculture and animal breeding, machines and robotic mechanisms (machines) for processing cereals, fruits, vegetables and food; engines and motors, other than for land vehicles, parts and fittings therefor, hydraulic and pneumatic controls for engines and motors, brakes other than for vehicles, brake linings for engines, crankshafts, transmission gears for machines, cylinders for engines, pistons for engines, turbines, not for land vehicles, filters for engines and motors, oil, air and fuel filters for land vehicle engines, exhausts for land vehicle engines, exhaust manifolds for land vehicle engines, engine cylinders for land vehicles, engine cylinder heads for land vehicles, pistons for land vehicle engines, carburetors for land vehicles, fuel conversion apparatus for land vehicle engines, injectors for land vehicle engines, fuel economisers for land vehicle engines, pumps for land vehicle engines, valves for land vehicle engines, starters for motors and engines, dynamos for land vehicle engines, sparking plugs for land vehicle engines; bearings (parts of machines), roller or ball bearings; machines for mounting and detaching tires; alternators, current generators, electric generators, current generators operated with solar energy; painting machines, automatic spray guns for paint, electric, hydraulic and pneumatic punching machines and guns, electric adhesive tape dispensers (machines), electric guns for compressed gas or liquid spraying machines, electric hand drills, electric hand saws, electric jigsaw machines, spiral binding machines for industrial purposes, compressed air machines, compressors (machines), vehicle washing installations, robotic mechanisms (machines) with the abovementioned functions; electric and gas-operated welding apparatus, electric arc welding apparatus, electric soldering apparatus, electric arc cutting apparatus, electrodes for welding machines, industrial robots (machines) with the abovementioned functions; printing machines; packaging machines, filling, plugging and sealing machines for industrial purposes, labellers (machines), sorting machines, industrial robots (machines) with the abovementioned functions, electric packing machines for plugging and sealing of plastics; machines for textile processing, sewing machines, industrial robots (machines) with the abovementioned functions; pumps [machines], self-regulating fuel pumps; electric kitchen machines for chopping, grinding, crushing, mixing and mincing foodstuff, washing machines, laundry washing machines, dishwashers, spin driers (not heated), electric cleaning machines for cleaning floors, carpets or floorings, vacuum cleaners and parts thereof; automatic vending machines; galvanizing and electroplating machines; electric door openers and closers.

16 – Paper and cardboard; paper and cardboard for packaging and wrapping purposes, cardboard boxes; paper towels; toilet paper; paper napkins; plastic ma-

terials for packaging and wrapping purposes; printing blocks and types; bookbinding material; printed publications; printed matter; calendars; posters; photographs [printed]; paintings; stickers [stationery]; postage stamps; stationery, office stationery, instructional and teaching material [except furniture and apparatus]; writing and drawing implements; artists' materials; paper products for stationery purposes; adhesives for stationery purposes; office requisites; paint rollers and paintbrushes for painting.

20 – Furniture, made of any kind of material; mattresses, pillows, air mattresses and cushions, not for medical purposes, water beds, not for medical purposes; mirrors; beehives, artificial honeycombs and sections of wood for honeycombs; bouncing chairs for babies, playpens for babies, cradles, infant walkers; display boards, frames for pictures and paintings, identification plates, not of metal; identification tags, not of metal; nameplates, not of metal; identification tags of wood or synthetic materials; packaging containers of wood or plastics, casks for use in transportation or storage, barrels, storage drums, tanks, boxes, storage containers, transportation containers, chests, loading pallets and closures for the aforementioned goods, of wood or plastics; small hardware goods of wood or synthetic materials included in this class, furniture fittings, of wood or synthetic materials; ornaments and decorative goods of wood, wax, beeswax, plastic or plaster, included in this class, namely figurines, holiday ornaments for walls and sculptures, all made of wood, wax, beeswax, plastic or plaster; baskets, not of metal; fishing baskets; kennels, nesting boxes and beds for household pets; portable ladders and mobile boarding stairs of wood or synthetic materials; bamboo curtains, roller indoor blinds [for interiors], slatted indoor blinds, bead curtains for decoration, curtain hooks, curtain rings, curtain tie-backs, curtain rods.

21 – Hand-operated non-electric cleaning instruments and appliances, brushes, other than paintbrushes, steel chips for cleaning, sponges for cleaning, steel wool for cleaning, cloths of textile for cleaning, gloves for dishwashing, non-electric polishing machines for household purposes, brooms for carpets, mops; toothbrushes, electric toothbrushes, dental floss, shaving brushes, hair brushes, combs; non-electric household or kitchen utensils, included in this class, [other than forks, knives, spoons], services [dishes], pots and pans, bottle openers, flower pots, drinking straws, non-electric cooking utensils; ironing boards and shaped covers therefor, drying racks for washing, clothes drying hangers; cages for household pets, indoor aquariums, vivariums and indoor terrariums for animals and plant cultivation; ornaments and decorative goods of glass, porcelain, earthenware or clay, included in this class, namely statues, figurines and vases, all made of glass, porcelain, earthenware or clay and cups, not of precious metal; mouse traps, insect traps, electric devices for attracting and killing flies and

insects, fly catchers, fly swatters; perfume burners, perfume sprayers, perfume vaporizers, electric or non-electric make-up removing appliances, powder puffs, toilet cases; nozzles for sprinkler hose, nozzles for watering cans, watering devices, garden watering cans; unworked or semi-worked glass, except building glass, mosaics of glass and powdered glass for decoration, except for building, glass wool other than for insulation or textile use.

28 – Games and toys; arcade video game machines; game apparatus and machines for use with an external display screen and monitor, including those coin-operated; toys for animals; toys for outdoor playgrounds, parks and game parks; gymnastic and sporting articles not included in other classes; Christmas trees of artificial material, ornaments for Christmas trees, artificial snow for Christmas trees, rattles (playthings), novelties for parties, dances (party favors), paper party hats.

(260) AM 2023 120895 A

(800) 1703154

(151) 2022 08 04

(891) 2022 08 04

(731) Saha Mağazacılık Anonim Şirketi
Ayazağa Mahallesi, Kemerburgaz Caddesi,
7 C 32, Sarıyer, İstanbul, Türkiye

(540)

SNEAKS UP,

(591) Black, white

(531) 26.03.02; 26.03.24; 27.05.01; 27.05.17

(511)

25 – Clothing, including underwear and outer clothing, other than special purpose protective clothing; socks, mufflers (clothing), shawls, bandanas, scarves, belts (clothing); footwear, shoes, slippers, sandals; headgear, hats, caps with visors, berets, caps (headwear), skull caps.

35 – Advertising, marketing and public relations; organization of exhibitions and trade fairs for commercial or advertising purposes; development of advertising concepts; provision of an online marketplace for buyers and sellers of goods and services; office functions; secretarial services; arranging newspaper subscriptions for others; compilation of statistics; rental of office machines; systemization of information into computer databases; telephone answering for unavailable subscribers; business management, business administration and business consultancy; accounting; commercial consultancy services; personnel recruitment, personnel placement, employment agencies, import-export agencies; temporary personnel placement services; auctioneering; the bringing together, for the benefit of others, of a variety of goods, namely, clothing, including underwear and outer clothing, other than special purpose protective clothing, socks,

mufflers (clothing), shawls, bandanas, scarves, belts (clothing), footwear, shoes, slippers, sandals, headgear, hats, caps with visors, berets, caps (headwear), skull caps enabling customers to conveniently view and purchase those goods, such services may be provided by retail stores, wholesale outlets, by means of electronic media or through mail order catalogues.

(260) AM 2023 120896 A

(800) 1703200

(151) 2022 10 06

(891) 2022 10 06

(731) Hyundai Motor Company

12, Heolleung-ro, Seocho-gu, Seoul 06797,

Republic of Korea

(540)



(591) Blue

(531) 24.11.25; 26.01.18; 27.05.01; 29.01.04

(511)

7 – Electrically operated brushes [parts of machines]; gas pumps (gas station equipment); electric door opening and closing apparatus; cranes; vehicle lifts; hydraulic accumulators being parts of machines; brakes for machines; metalworking machines; forming machines for automobile brakepad; taps [machine tools]; faucets [parts of machines, engines or motors]; sorting machines for industry; chemical machines for industrial purposes; electronic ignitions for vehicles; mechanical engine parts for land vehicles; automotive engine blocks; motors and engines [except for land vehicles]; engines and motors for the generation of electricity; pumps for land vehicle engines; speed change gears being parts of machines; control mechanisms for machines, engines or motors; machine coupling and transmission components except for land vehicles; automatic parking installations; ignition devices for motors of land vehicles; current generators for automobiles; motors for model vehicles; generators; turbogenerators; portable electric power generators; electrodes for welding machines; snow ploughs; vacuum cleaners; robotic cleaning machines; robotic vacuum cleaners; steam cleaning machines; electric sweepers; vehicle washing machines; control mechanisms for robots; robots for industrial use; robots for helping with daily chores for household purposes; robots for machine tools; driving devices for robots; apparatus for manufacturing solar batteries; hydrogen dispensing pumps for service stations; pneumatic transporters; spring shock absorbers for machines; disc brakes being parts of machines; fuel economisers for motors and engines; fuel injector parts for land and water vehicle engines; electric starter motors; filling machines.

(260) AM 2023 120897 A

(800) 1703215

(151) 2022 11 21

(891) 2022 11 21

(731) Max International

10, rue Michel Rodange, L-2430 Luxembourg,

Luxembourg

(540)



(591) Black, red and gray

(531) 14.07.09; 26.04.07; 26.04.24; 26.15.25;

27.05.01; 27.05.09; 27.05.10; 29.01.13

(511)

12 – Trailers; trailer hitches for vehicles; coupling and transmission components for land vehicles.

(260) AM 2023 120977 A

(800) 1704028

(151) 2022 11 23

(891) 2022 11 23

(731) UAB Narbutas International

Odminių g. 3-23, LT-01122 Vilnius, Lithuania

(540)

WORKLAB

(591) Black, white

(511)

20 – Furniture; furniture fittings, not of metal.

(260) AM 2023 120978 A

(800) 1704051

(151) 2022 10 31

(891) 2022 10 31

(731) Société Jas Hennessy & Co.

Rue de la Richonne, F-16100 Cognac, France

(540)



(591) Brown, white

(531) 02.09.14; 19.01.03; 19.03.03; 19.03.24;

19.07.01; 23.01.01; 26.13.25; 27.05.01;

27.05.08; 27.05.24; 29.01.13

(511)
33 – Alcoholic beverages (with the exception of be-
ers); alcoholic extracts; alcoholic essences; alcoholic
fruit extracts.

(260) AM 2023 120983 A
(800) 1704199
(151) 2022 11 16
(891) 2022 11 16
(731) Hyundai Motor Company
12, Heolleung-ro, Seocho-gu, Seoul 06797,
Republic of Korea
(540)



(591) Blue, white
(531) 24.11.18; 24.11.25; 26.01.02; 26.01.03;
26.01.18; 27.05.01; 29.01.04

(511)
37 – Installation/maintenance/repair of compressed
natural gas charger; garage services for the mainte-
nance and repair of motor vehicles; automobile batte-
ry replacement services; vehicle battery charging; ve-
hicle repair services; maintenance, servicing and re-
pair of vehicles; electric motor vehicle maintenance
and repair; hydrogen gas refuelling service for vehi-
cles; vehicle service stations [refuelling and mainten-
ce]; repair and maintenance of automobiles and parts
thereof; providing information relating to the repair or
maintenance of automobiles; motor vehicle mainte-
nance and repair; automobile internals repair; repair
and maintenance of vehicles; inspection of automobi-
les and parts thereof prior to maintenance and repair;
natural gas refuelling service for motor vehicles; tires
maintenance and repair; recharging services for elec-
tric vehicles; repair and maintenance of engines for
motor vehicles; repair of braking devices; installation,
maintenance and repair of batteries and accumulators;
recharging of batteries and accumulators; installation
of automotive remote start systems; automobile clean-
ing and car washing; disinfecting for vehicles; cus-
tom installation of exterior, interior and mechanical
parts of vehicles [tuning]; tuning of motor vehicle.

(260) AM 2023 120984 A
(800) 1704215
(151) 2022 10 31
(891) 2022 10 31
(731) Soci t  Jas Hennessy & Co.
Rue de la Richonne, F-16100 Cognac,
France

(540)



(591) Black, silver, brown, grey
(531) 02.09.14; 19.07.01; 23.01.01; 25.01.15;
27.05.01; 27.05.08; 29.01.14

(511)
33 – Alcoholic beverages (with the exception of be-
ers); alcoholic extracts; alcoholic essences; alcoholic
fruit extracts.

(260) AM 2023 120985 A
(800) 1704231
(151) 2022 10 06
(891) 2022 10 06
(731) Hyundai Motor Company
12, Heolleung-ro, Seocho-gu, Seoul 06797,
Republic of Korea
(540)



(591) Blue
(531) 24.11.25; 26.01.03; 26.01.18; 27.05.01;
27.05.21; 29.01.04

(511)
7 – Electrically operated brushes [parts of machines];
gas pumps (gas station equipment); electric door open-
ing and closing apparatus; cranes; vehicle lifts; hyd-
raulic accumulators being parts of machines; brakes
for machines; metalworking machines; forming ma-
chines for automobile brake pad; taps [machine tools];
faucets [parts of machines, engines or motors]; sorting
machines for industry; chemical machines for indus-
trial purposes; electronic ignitions for vehicles; me-
chanical engine parts for land vehicles; automotive
engine blocks; motors and engines [except for land

vehicles]; engines and motors for the generation of electricity; pumps for land vehicle engines; speed change gears being parts of machines; control mechanisms for machines, engines or motors; machine coupling and transmission components except for land vehicles; mechanical parking systems; ignition devices for motors of land vehicles; current generators for automobiles; motors for model vehicles; generators; turbo-generators; portable electric power generators; electrodes for welding machines; snow ploughs; vacuum cleaners; robotic cleaning machines; robotic vacuum cleaners; steam cleaning machines; electric sweepers; vehicle washing machines; control mechanisms for robots; robots for industrial use; robots for helping with daily chores for household purposes; robots for machine tools; driving devices for robots; apparatus for manufacturing solar battery; hydrogen dispensing pumps for service stations; pneumatic transporters; spring shock absorbers for machines; disc brakes being parts of machines; fuel economisers for motors and engines; fuel injector parts for land and water vehicle engines; electric starter motors; filling machines.

(260) AM 2023 120986 A

(800) 1704249

(151) 2022 09 16

(891) 2022 09 16

(731) Sansure Biotech France

66 avenue des Champs-Élysées, F-75008

Paris, France

(540)

TSure

(591) Black, white

(531) 27.05.01

(511)

5 – Injectable pharmaceuticals for treatment of anaphylactic reactions; diagnostic reagents for medical use; reagents for use in medical genetic testing; medical diagnostic products for bacteriological cultures; vaccines; chemical preparations for pharmaceutical use; chemical preparations for medical use; diagnostic preparations for medical use; diagnostic kits for medical diagnostic purposes consisting of reagents for use in disease testing, health monitoring and, more specifically, predictive and preventive medicine in the fields of immune system and respiratory system detection, related diseases, cancer, infectious diseases, inflammatory disorders and oncological disorders; purified biochemicals, namely, protein arrays, fluorescent enzymes and dyes for use as reagents for medical diagnostics; chemical-pharmaceutical preparations; chemical reagents for medical or veterinary use; bacteriological preparations for medical or veterinary use; antiallergic tablets; antibiotics in the form of tablets; traditional Chinese medicinal herbs; biochemical preparations for medical use; bacteriological preparations for pharmaceutical use for the treatment of disorders of the nervous system, immune system, cardiovascu-

lar system, metabolic system, respiratory system, musculoskeletal system, genitourinary system, inflammatory disorders, dermatology, oncology, hematology, tissue and organ transplant, ophthalmology and gastroenterological disorders; biochemical medicines for the treatment of disorders of the nervous system, immune system, cardiovascular system, metabolic system, respiratory system, musculoskeletal system, genitourinary system, inflammatory disorders, dermatology, oncology, hematology, tissue and organ transplant, ophthalmology and gastroenterological disorders; diagnostic biomarking reagents for medical use; ointments for pharmaceutical use; medicinal preparations for the mouth to be taken in the nature of tablets, drops, capsules, gel capsules or tablets; drug delivery agents in the nature of tablets providing controlled release of the active ingredients for a wide variety of pharmaceuticals; demineralized water for medical use; antibiotic ointments; anti-inflammatory ointments; medicinal ointments for treating dermatological conditions; medicinal herbs; pharmaceutical and veterinary products; hygienic products for medical use; dietetic foods and substances adapted for medical or veterinary use; food for babies; dietary supplements for humans and animals; plasters, materials for dressings; teeth filling materials; dental waxes; disinfectants; vermin destroying products; fungicides; herbicides.

10 – Surgical apparatus and instruments; blood testing apparatus; veterinary apparatus and instruments; dental apparatus and instruments; artificial limbs, eyes and teeth; orthopedic articles; suture materials; medical apparatus and instruments; X-ray apparatus for medical use; x-ray diagnostic apparatus; testing apparatus for medical use; diagnostic imaging apparatus for medical use; apparatus for testing bacteria and viruses; DNA extraction and purification apparatus for medical use; medical apparatus and instruments for RNA analysis, other than for dental use; blood testing equipment; body composition analyzers for medical use; diagnostic apparatus for medical and veterinary use, in particular for detecting nucleic acid molecules in a sample, in particular in a patient sample; analysis devices for identification of bacteria for medical use; DNA and RNA testing apparatus for medical use; genetic testing apparatus for medical use; dropping pipettes for medical use; medical devices, namely, nucleic acid analyzer for medical diagnostics; immunochemical testing apparatus for medical use; laboratory instruments for medical use.

(260) AM 2023 120987 A

(800) 1704314

(151) 2022 05 23

(891) 2022 05 23

(731) Embecta Corp.

200 Bulfinch Drive, Andover MA

01810, USA

(540)



(591) Black, white

(531) 02.09.04; 26.01.03; 26.01.24; 26.11.12;
27.05.01

(511)

9 – Downloadable software for medical information, patient care and medicine management; downloadable software in the nature of a mobile application for obtaining, controlling and managing patient medical information or wearable medical devices; downloadable software in the nature of a mobile application for the collection, editing, organizing, modifying, transmission, storage and sharing of patient care instruction and medical information; and downloadable and recorded computer software, mobile applications and programming interface software and hardware for acquiring, transmitting and storing medical and physiological data.

10 – Medical devices and apparatus for patient care and delivery of medicine; medical ports, lancets, needles and syringes; kits for diabetic patients comprised primarily of syringes or pen needles, lancets, glucose tablets, and disinfectant prep pad; clipper used for destruction of medical needles; scale magnifier and needle guide for insulin syringes; pen needles used to deliver medications to manage diabetes; a subcutaneous set or a feature of subcutaneous infusion sets for use by diabetes patients in connection with insulin pumps; infusion and insulin pumps and accessories, medical sensors, meters and devices for measuring and monitoring blood and urine properties, and accessories therefor.

16 – Educational materials.

41 – Medical training and education services in the diabetes field; educational instruction on medical injection technique; online newsletter relating to diabetes healthcare; educational services, namely, providing training in the field of diabetes and diabetes care provided by means of a call center and distribution of printed and electronic materials in connection therewith.

42 – Providing software for patient information, patient care and medicine management; providing temporary use of non-downloadable cloud-based software for controlling and managing patient medical information; providing temporary use of non-downloadable cloud-based software for the collection, editing, organizing, modifying, transmission, storage and sharing of patient care instruction and medical information; software as a service (saas) and application service provider featuring application programming interface software for acquiring, storing, communica-

ting and sharing medical and physiological data, and consulting services related thereto; providing a web site for medical professionals and patients featuring medical information and data from devices used for medical monitoring purposes that feed information to the website that is processed, exchanged and accessed in real-time by users.

44 – Interactive medical monitoring, reporting and alert services for monitoring and managing diabetes.

(260) AM 2023 120988 A

(800) 1704368

(151) 2022 11 11

(891) 2022 11 11

(731) Joint Stock Company "Fats And Oil Integrated Works"

Ul. Titova 27, Ekaterinburg, RU-620085

Sverdlovskaya Oblast, Russian Federation

(540)

Novum Via

(591) Black, white

(511)

1 – Antioxidants for use in the manufacture of food supplements; antioxidants for use in the manufacture of food products; fatty acids; vitamins for the food industry; vitamins for use in the manufacture of food supplements; proteins for use in the manufacture of food supplements.

5 – Mineral dietary supplements; nutritional supplements, including dietary supplements, dietary supplements containing omega-3 fatty acids; antioxidants for use as food supplements; albumin dietary supplements; yeast dietary supplements; alginate dietary supplements; glucose dietary supplements; casein dietary supplements; lecithin dietary supplements; linseed oil dietary supplements; brewer's yeast dietary supplements; propolis dietary supplements; protein dietary supplements; royal jelly dietary supplements; pollen dietary supplements; wheat germ dietary supplements; linseed dietary supplements; whey protein dietary supplements; acai powder dietetic supplements; dietary supplements with a cosmetic effect; enzyme dietary supplements; antioxidant pills; amino acids for medical purposes; acids for pharmaceutical purposes; vitamin preparations.

29 – Oils and fats for food; peanut butter; cocoa butter for food; coconut oil for food; coconut butter; maize oil for food; sesame oil for food; linseed oil for food; extra virgin olive oil for food; olive oil for food; palm oil for food; palm kernel oil for food; sunflower oil for food; rape oil for food; butter; soya bean oil for food; vegetable oils, vegetable oil substitutes.

(260) AM 2023 120989 A
(800) 1704377
(151) 2022 10 11
(891) 2022 10 11
(731) Obshchestvo s Ogranichennoy Otvetstvennost'yu "Evrotorg"
ul. Kazintsya, d. 52a, k. 22, 220099 Minsk,
Belarus

(540)

CHEVALIER DUVALL

(591) Black, white

(511)

30 – Bread rolls; pains au chocolat; waffles; malt biscuits; fruit jellies [confectionery]; confectionery in the form of mousses; cakes; Danish pastries; pastries; peanut confectionery; almond confectionery; confectionery; fruit confectionery; caramels [sweets]; sweets; liquorice [confectionery]; peppermint sweets; mints for breath freshening; liqueur chocolates; crackers; rice crackers; macaroons [pastries]; chocolate-coated nuts; lozenges [confectionery]; biscuits; coconut macaroons; petit-beurre biscuits; pies; fondants [confectionery]; popcorn; profiteroles; gingerbread.

33 – Alcoholic beverages, except beer; alcoholic preparations for making beverages.

(260) AM 2023 120990 A
(800) 1704393
(151) 2022 07 21
(891) 2022 07 21
(731) Limited Liability Company "SPAR Middle Volga"
43B Geroya Popova St, Office 15, RU-603058
Nizhny Novgorod, Russian Federation

(540)



(591) Black, white

(531) 24.17.10; 24.17.25; 26.13.01; 27.01.01;
27.05.01; 27.05.10

(511)

35 – Advertising; business management, organization and administration; office functions; import-export agency services; rental of cash registers; rental of advertising space; business auditing; financial auditing; employment agency services; book-keeping; demonstration of goods; opinion polling; market studies; business investigations; marketing research; personnel recruitment; business management and organization consultancy; personnel management consultancy; professional business consultancy; marketing; business

management of sports people; updating of advertising material; online retail services for downloadable and pre-recorded music and movies; online retail services for downloadable digital music; organization of exhibitions for commercial or advertising purposes; organization of trade fairs; shop window dressing; business management assistance; commercial or industrial management assistance; providing commercial information and advice for consumers in the choice of products and services; commercial intermediation services; providing business information; providing user reviews for commercial or advertising purposes; provision of an online marketplace for buyers and sellers of goods and services; presentation of goods on communication media, for retail purposes; sales promotion for others; promotion of goods and services through sponsorship of sports events; promotion of goods through influencers; rental of advertising time on communication media; publicity material rental; office machines and equipment rental; consumer profiling for commercial or marketing purposes; publication of publicity texts; distribution of samples; online advertising on a computer network; compilation of information into computer databases; retail services for goods through intermediaries; procurement services for others [purchasing goods and services for other businesses]; commercial administration of the licensing of the goods and services of others; advisory services for business management; online ordering services in the field of restaurant take-out and delivery; commercial information and advice for consumers [consumer advice shop]; administrative processing of purchase orders; retail and/or wholesale services, wholesale and retail store service, on-line ordering services relating to perfumes and cosmetics, toiletries and accessories, teeth cleaning products, dental and oral care products, shaving preparations, aftershave care preparations, disinfectant and/or deodorants for personal hygiene, sunscreen preparations, preparations for make-up removal, essential oils, perfumes, makeup, decorative cosmetics, deodorants, soaps, skin care products for the body, hands, feet, face, head, cosmetic dyes, cleansing preparations, gels, conditioners, lotions, balms, creams, care masks for skin, hair, nails, bleaching preparations and other substances for laundry use, cleaning, polishing, scouring and abrasive preparations, scented candles, decorative candles, pharmaceutical preparations, medical products, veterinary, hygiene products, disinfectants, food for babies, food additives for humans and animals, cutlery, forks, spoons, sets of manicure tools, razors, household cutting products for cosmetic use, audiovisual, optical devices and instruments, optical, magnetic, digital, recorded or downloadable storage media, computers, computer equipment, computer peripherals, computer software, portable digital electronic devices, bags and cases for computer equipment and portable digital electronic devices, eyewear, devices and installations for lighting, heating, refrigeration, steam generation,

cooking and preparing beverages, drying, ventilation, water supply and sanitary purposes, jewelry, costume jewellery, key rings, cases and boxes for jewelry and costume jewellery, printed products, periodicals, stationery accessories, cases and covers [stationery], stationery, bags, sheets, film and bags of paper or plastic for packaging and wrapping, bags, purses, wallets, umbrellas, clothing for pets, utensils, household, domestic, kitchen, bathroom utensils, cleaning tools and accessories, toiletry bags, figurines made of porcelain, ceramics, faience, terracotta or glass, textiles, linen for household uses, curtains, clothes, shoes, headgear, underwear, bathing suits, games, toys, gymnastic and sports goods, fishing equipment, food products, beverages, alcoholic beverages, food and care products for animal; business consultancy, business advice and business information services with regard to the aforementioned matters.

(260) AM 2023 121014 A
 (800) 1705232
 (151) 2022 11 04
 (891) 2022 11 04
 (731) Richter Gedeon Nyrt.
 Gyömrői út 19-21., H-1103 Budapest, Hungary
 (540)

LURENSODIN

(591) Black, white
 (511)
 5 – Pharmaceutical preparations.

(260) AM 2023 121063 A
 (800) 1705505
 (151) 2022 12 01
 (891) 2022 12 01
 (731) IWI AG
 Industriestrasse 13-C, CH-6302 Zug,
 Switzerland
 (540)

Pro-Pump

(591) Black, white
 (511)
 3 – Breath freshening sprays; dental bleaching gels; toothpaste; breath freshening strips; dentifrices; mouthwashes, not for medical purposes; breath freshening preparations for personal hygiene.

(260) AM 2023 121064 A
 (800) 1705535
 (151) 2022 08 18
 (891) 2022 08 18
 (731) Venyaminov Alexey Nikolaevich
 Novo-Sadovaya st., 287, apt. 16, RU-443011
 Samara, Samara region, Russian Federation

(540)

BRUSKO

(591) Black, white
 (531) 27.05.17
 (511)
 34 – Flavourings, other than essential oils, for use in electronic cigarettes; liquid nicotine solutions for electronic cigarettes; cigarettes containing tobacco substitutes, not for medical purposes; liquid solutions for use in electronic cigarettes; electronic cigarettes.
 35 – Advertising; business management and organization consultancy; advisory services for business management.

(260) AM 2023 121065 A
 (800) 1705536
 (151) 2022 08 18
 (891) 2022 08 18
 (731) Venyaminov Alexey Nikolaevich
 Novo-Sadovaya st., 287, apt. 16, RU-443011
 Samara, Samara region, Russian Federation

(540)

BRUSKO

(591) Black, white
 (531) 26.04.05; 26.04.24; 27.05.01
 (511)
 25 – Clothing; footwear; headwear.
 32 – Beer; mineral and aerated waters and other non-alcoholic beverages; fruit beverages and fruit juices; syrups and other preparations for making beverages.
 34 – Flavourings, other than essential oils, for use in electronic cigarettes; cigarettes containing tobacco substitutes, not for medical purposes; liquid solutions for use in electronic cigarettes; electronic cigarettes.
 35 – Advertising; business management and organization consultancy; business management assistance; advisory services for business management.

(260) AM 2023 121066 A
 (800) 1705547
 (151) 2022 08 18
 (891) 2022 08 18
 (731) Venyaminov Alexey Nikolaevich
 Novo-Sadovaya st., 287, apt. 16, RU-443011
 Samara, Samara region, Russian Federation

(540)

BRUSCO

(591) Black, white
 (531) 27.05.01; 27.05.17

(511)

25 – Clothing; footwear; headwear.

32 – Beer; mineral and aerated waters and other non-alcoholic beverages; fruit beverages and fruit juices; syrups and other preparations for making beverages.

34 – Flavourings, other than essential oils, for use in electronic cigarettes; cigarettes containing tobacco substitutes, not for medical purposes; liquid solutions for use in electronic cigarettes; electronic cigarettes.

35 – Advertising; business management and organization consultancy; business management assistance; advisory services for business management.

(260) AM 2023 121067 A

(800) 1705549

(151) 2022 09 07

(891) 2022 09 07

(731) NSYNC Developments Limited

Tower Gate Place, Tal-Qroqq Street, P.O.B.,

MSD 1703 Msida, Malta

(540)

Rubyplay

(591) Black, white

(511)

41 – Gaming services; on-line gaming services and games; on-line gambling services; electronic gambling; entertainment services; gambling services; betting services; provision of gambling services, gaming services and/or betting services by means of the Internet, telephone, cellular, television, cable, satellite, radio or by any other form of communications means (electronic or otherwise); providing bingo, entertainment, gambling, gaming and betting services via websites on the Internet; operating lotteries; providing casino facilities (gambling); game services provided on-line.

**საერთაშორისო სასაქონლო ნიშნები, რომლებსაც მიენიჭა
ღაცვას საქართველოში**

(260) AM 2023 116472 A
(800) 1641753
(151) 2021 03 16
(181) 2031 03 16
(891) 2021 03 16
(511) 09, 16, 25, 35

(260) AM 2023 118690 A
(800) 1673403
(151) 2022 05 03
(181) 2032 05 03
(891) 2022 05 03
(511) 05

(260) AM 2023 117236 A
(800) 1652117
(151) 2022 01 06
(181) 2032 01 06
(891) 2022 01 06
(511) 01

(260) AM 2023 118691 A
(800) 1673430
(151) 2022 05 26
(181) 2032 05 26
(891) 2022 05 26
(511) 32

(260) AM 2023 117689 A
(800) 1659445
(151) 2022 01 17
(181) 2032 01 17
(891) 2022 01 17
(511) 25, 28, 35

(260) AM 2023 118692 A
(800) 1673432
(151) 2022 02 10
(181) 2032 02 10
(891) 2022 02 10
(511) 04, 09, 11

(260) AM 2023 118459 A
(800) 1338688
(151) 2016 12 02
(181) 2026 12 02
(891) 2022 03 04
(511) 33

(260) AM 2023 118693 A
(800) 1673463
(151) 2021 12 21
(181) 2031 12 21
(891) 2021 12 21
(511) 09, 25, 35, 38, 41

(260) AM 2023 118461 A
(800) 1468923
(151) 2019 01 09
(181) 2029 01 09
(891) 2022 06 17
(511) 25

(260) AM 2023 118694 A
(800) 1673542
(151) 2022 05 18
(181) 2032 05 18
(891) 2022 05 18
(511) 01, 35

(260) AM 2023 118462 A
(800) 1484511
(151) 2019 05 30
(181) 2029 05 30
(891) 2022 04 19
(511) 18

(260) AM 2023 118695 A
(800) 1673644
(151) 2022 06 21
(181) 2032 06 21
(891) 2022 06 21
(511) 30

(260) AM 2023 118689 A
(800) 1673396
(151) 2022 05 02
(181) 2032 05 02
(891) 2022 05 02
(511) 35, 41, 42

(260) AM 2023 118696 A
(800) 1673698
(151) 2021 12 30
(181) 2031 12 30
(891) 2021 12 30
(511) 05

(260) AM 2023 118697 A
(800) 1673709
(151) 2022 03 22
(181) 2032 03 22
(891) 2022 03 22
(511) 09, 36, 42

(260) AM 2023 118698 A
(800) 1673710
(151) 2022 03 22
(181) 2032 03 22
(891) 2022 03 22
(511) 09, 36, 42

(260) AM 2023 118706 A
(800) 1673898
(151) 2022 05 13
(181) 2032 05 13
(891) 2022 05 13
(511) 03, 05, 30, 35, 42

(260) AM 2023 118707 A
(800) 1673968
(151) 2022 05 06
(181) 2032 05 06
(891) 2022 05 06
(511) 33, 35

(260) AM 2023 118708 A
(800) 1673980
(151) 2022 05 18
(181) 2032 05 18
(891) 2022 05 18
(511) 03, 05, 10, 16

(260) AM 2023 118772 A
(800) 1674355
(151) 2022 03 02
(181) 2032 03 02
(891) 2022 03 02
(511) 30

(260) AM 2023 118787 A
(800) 1674675
(151) 2022 06 24
(181) 2032 06 24
(891) 2022 06 24
(511) 35, 41, 42

(260) AM 2023 118788 A
(800) 1674679
(151) 2022 06 27
(181) 2032 06 27
(891) 2022 06 27
(511) 32

(260) AM 2023 118789 A
(800) 1674717
(151) 2022 06 07
(181) 2032 06 07
(891) 2022 06 07
(511) 03, 05, 21

(260) AM 2023 118791 A
(800) 1674761
(151) 2022 06 11
(181) 2032 06 11
(891) 2022 06 11
(511) 24, 25

(260) AM 2023 118792 A
(800) 1674762
(151) 2022 06 11
(181) 2032 06 11
(891) 2022 06 11
(511) 24, 25

(260) AM 2023 118793 A
(800) 1674763
(151) 2022 06 11
(181) 2032 06 11
(891) 2022 06 11
(511) 24, 25

(260) AM 2023 118794 A
(800) 1674901
(151) 2022 06 27
(181) 2032 06 27
(891) 2022 06 27
(511) 09

(260) AM 2023 118795 A
(800) 1674909
(151) 2022 05 30
(181) 2032 05 30
(891) 2022 05 30
(511) 12

(260) AM 2023 118800 A
 (800) 1675082
 (151) 2022 05 20
 (181) 2032 05 20
 (891) 2022 05 20
 (511) 12

(260) AM 2023 118822 A
 (800) 1340186
 (151) 2017 02 17
 (181) 2027 02 17
 (891) 2022 07 06
 (511) 33

(260) AM 2023 118802 A
 (800) 1675093
 (151) 2022 06 24
 (181) 2032 06 24
 (891) 2022 06 24
 (511) 08, 20, 21

(260) AM 2023 118824 A
 (800) 1553679
 (151) 2020 08 31
 (181) 2030 08 31
 (891) 2022 07 13
 (511) 29

(260) AM 2023 118803 A
 (800) 1675096
 (151) 2022 02 15
 (181) 2032 02 15
 (891) 2022 02 15
 (511) 18, 35

(260) AM 2023 118866 A
 (800) 1675498
 (151) 2022 06 06
 (181) 2032 06 06
 (891) 2022 06 06
 (511) 03

(260) AM 2023 118805 A
 (800) 1675153
 (151) 2021 12 16
 (181) 2031 12 16
 (891) 2021 12 16
 (511) 12

(260) AM 2023 118867 A
 (800) 1675510
 (151) 2022 05 27
 (181) 2032 05 27
 (891) 2022 05 27
 (511) 09

(260) AM 2023 118806 A
 (800) 1675158
 (151) 2022 01 28
 (181) 2032 01 28
 (891) 2022 01 28
 (511) 29

(260) AM 2023 118868 A
 (800) 1675516
 (151) 2021 12 31
 (181) 2031 12 31
 (891) 2021 12 31
 (511) 03

(260) AM 2023 118815 A
 (800) 1675335
 (151) 2022 05 27
 (181) 2032 05 27
 (891) 2022 05 27
 (511) 09, 15

(260) AM 2023 118869 A
 (800) 1675521
 (151) 2022 04 07
 (181) 2032 04 07
 (891) 2022 04 07
 (511) 09, 28, 41

(260) AM 2023 118817 A
 (800) 1675387
 (151) 2022 05 10
 (181) 2032 05 10
 (891) 2022 05 10
 (511) 07, 09, 40, 42

(260) AM 2023 118870 A
 (800) 1675579
 (151) 2022 04 04
 (181) 2032 04 04
 (891) 2022 04 04
 (511) 09, 35, 38, 41, 42, 45

(260) AM 2023 118871 A
(800) 1675647
(151) 2022 06 27
(181) 2032 06 27
(891) 2022 06 27
(511) 05

(260) AM 2023 118872 A
(800) 1675709
(151) 2022 02 22
(181) 2032 02 22
(891) 2022 02 22
(511) 29, 30, 32

(260) AM 2023 118885 A
(800) 1675986
(151) 2022 07 04
(181) 2032 07 04
(891) 2022 07 04
(511) 30

(260) AM 2023 118886 A
(800) 1676047
(151) 2022 03 11
(181) 2032 03 11
(891) 2022 03 11
(511) 09, 28, 41

(260) AM 2023 118887 A
(800) 1676086
(151) 2022 06 27
(181) 2032 06 27
(891) 2022 06 27
(511) 29

(260) AM 2023 118888 A
(800) 1676093
(151) 2022 06 15
(181) 2032 06 15
(891) 2022 06 15
(511) 09

(260) AM 2023 118889 A
(800) 1676116
(151) 2022 04 11
(181) 2032 04 11
(891) 2022 04 11
(511) 07

(260) AM 2023 118890 A
(800) 1676145
(151) 2022 06 16
(181) 2032 06 16
(891) 2022 06 16
(511) 21

(260) AM 2023 118901 A
(800) 1676381
(151) 2022 06 08
(181) 2032 06 08
(891) 2022 06 08
(511) 05

(260) AM 2023 118902 A
(800) 1676383
(151) 2022 06 08
(181) 2032 06 08
(891) 2022 06 08
(511) 05

(260) AM 2023 118903 A
(800) 1676384
(151) 2022 06 08
(181) 2032 06 08
(891) 2022 06 08
(511) 05

(260) AM 2023 118905 A
(800) 1676388
(151) 2022 06 08
(181) 2032 06 08
(891) 2022 06 08
(511) 05

(260) AM 2023 118906 A
(800) 1676456
(151) 2022 05 18
(181) 2032 05 18
(891) 2022 05 18
(511) 05, 29, 30, 32

(260) AM 2023 118907 A
(800) 569646
(151) 1991 03 30
(181) 2031 03 30
(891) 2022 07 21
(511) 14

(260) AM 2023 118944 A
 (800) 1676522
 (151) 2022 02 02
 (181) 2032 02 02
 (891) 2022 02 02
 (511) 16, 41

(260) AM 2023 118952 A
 (800) 1676818
 (151) 2022 06 15
 (181) 2032 06 15
 (891) 2022 06 15
 (511) 16, 25, 28, 35, 41

(260) AM 2023 118945 A
 (800) 1676552
 (151) 2022 03 18
 (181) 2032 03 18
 (891) 2022 03 18
 (511) 09, 38, 41, 42

(260) AM 2023 118953 A
 (800) 1676823
 (151) 2022 06 20
 (181) 2032 06 20
 (891) 2022 06 20
 (511) 05

(260) AM 2023 118946 A
 (800) 1676553
 (151) 2022 05 22
 (181) 2032 05 22
 (891) 2022 05 22
 (511) 03, 04, 05, 06, 09, 10, 11, 16, 18, 20, 21, 24, 25,
 28, 30, 35, 37, 39, 40, 42, 44

(260) AM 2023 118958 A
 (800) 1676941
 (151) 2022 06 15
 (181) 2032 06 15
 (891) 2022 06 15
 (511) 09

(260) AM 2023 118947 A
 (800) 1676621
 (151) 2022 02 07
 (181) 2032 02 07
 (891) 2022 02 07
 (511) 09, 42

(260) AM 2023 118959 A
 (800) 1677040
 (151) 2022 07 18
 (181) 2032 07 18
 (891) 2022 07 18
 (511) 33

(260) AM 2023 118948 A
 (800) 1676655
 (151) 2022 03 02
 (181) 2032 03 02
 (891) 2022 03 02
 (511) 09, 10

(260) AM 2023 118960 A
 (800) 1677069
 (151) 2022 07 15
 (181) 2032 07 15
 (891) 2022 07 15
 (511) 21

(260) AM 2023 118949 A
 (800) 1676750
 (151) 2022 06 07
 (181) 2032 06 07
 (891) 2022 06 07
 (511) 05

(260) AM 2023 118961 A
 (800) 1677116
 (151) 2021 11 05
 (181) 2031 11 05
 (891) 2021 11 05
 (511) 42, 44

(260) AM 2023 118950 A
 (800) 1676757
 (151) 2022 05 20
 (181) 2032 05 20
 (891) 2022 05 20
 (511) 29, 30

(260) AM 2023 118962 A
 (800) 1677117
 (151) 2021 11 05
 (181) 2031 11 05
 (891) 2021 11 05
 (511) 42, 44

(260) AM 2023 118963 A
(800) 1677118
(151) 2021 11 07
(181) 2031 11 07
(891) 2021 11 07
(511) 42, 44

(260) AM 2023 118976 A
(800) 1677618
(151) 2022 06 21
(181) 2032 06 21
(891) 2022 06 21
(511) 11

(260) AM 2023 118964 A
(800) 1677120
(151) 2021 11 07
(181) 2031 11 07
(891) 2021 11 07
(511) 42, 44

(260) AM 2023 118979 A
(800) 1677678
(151) 2022 01 12
(181) 2032 01 12
(891) 2022 01 12
(511) 09, 28, 41

(260) AM 2023 118965 A
(800) 1677121
(151) 2021 11 07
(181) 2031 11 07
(891) 2021 11 07
(511) 42, 44

(260) AM 2023 118980 A
(800) 1677689
(151) 2022 01 03
(181) 2032 01 03
(891) 2022 01 03
(511) 09

(260) AM 2023 118968 A
(800) 1677189
(151) 2022 03 21
(181) 2032 03 21
(891) 2022 03 21
(511) 22

(260) AM 2023 118981 A
(800) 1677690
(151) 2022 01 03
(181) 2032 01 03
(891) 2022 01 03
(511) 09

(260) AM 2023 118969 A
(800) 1677282
(151) 2022 04 15
(181) 2032 04 15
(891) 2022 04 15
(511) 11

(260) AM 2023 118983 A
(800) 1677755
(151) 2022 05 27
(181) 2032 05 27
(891) 2022 05 27
(511) 30

(260) AM 2023 118970 A
(800) 1677393
(151) 2022 07 11
(181) 2032 07 11
(891) 2022 07 11
(511) 29, 30

(260) AM 2023 118986 A
(800) 819703
(151) 2003 11 04
(181) 2023 11 04
(891) 2022 07 22
(511) 21

(260) AM 2023 118972 A
(800) 1677479
(151) 2022 05 18
(181) 2032 05 18
(891) 2022 05 18
(511) 09, 12

(260) AM 2023 118991 A
(800) 1645222
(151) 2022 01 05
(181) 2032 01 05
(891) 2022 07 26
(511) 30

(260) AM 2023 119027 A
 (800) 1677879
 (151) 2022 06 17
 (181) 2032 06 17
 (891) 2022 06 17
 (511) 33

(260) AM 2023 119064 A
 (800) 1187308
 (151) 2013 05 06
 (181) 2023 05 06
 (891) 2022 07 29
 (511) 05, 25, 35

(260) AM 2023 119028 A
 (800) 1677881
 (151) 2022 06 17
 (181) 2032 06 17
 (891) 2022 06 17
 (511) 33

(260) AM 2023 119065 A
 (800) 1348395
 (151) 2017 03 14
 (181) 2027 03 14
 (891) 2022 08 01
 (511) 35, 41

(260) AM 2023 119029 A
 (800) 1677892
 (151) 2022 07 11
 (181) 2032 07 11
 (891) 2022 07 11
 (511) 09

(260) AM 2023 119066 A
 (800) 1392575
 (151) 2018 01 15
 (181) 2028 01 15
 (891) 2022 07 15
 (511) 05

(260) AM 2023 119059 A
 (800) 1678870
 (151) 2022 07 19
 (181) 2032 07 19
 (891) 2022 07 19
 (511) 33

(260) AM 2023 119067 A
 (800) 1436091
 (151) 2018 09 26
 (181) 2028 09 26
 (891) 2022 07 29
 (511) 32

(260) AM 2023 119061 A
 (800) 1678878
 (151) 2022 07 07
 (181) 2032 07 07
 (891) 2022 07 07
 (511) 05

(260) AM 2023 119068 A
 (800) 1462550
 (151) 2019 02 18
 (181) 2029 02 18
 (891) 2022 07 28
 (511) 29, 31, 32, 35, 44

(260) AM 2023 119062 A
 (800) 651909
 (151) 1996 03 18
 (181) 2026 03 18
 (891) 2022 08 02
 (511) 03, 05

(260) AM 2023 119069 A
 (800) 1564506
 (151) 2020 08 07
 (181) 2030 08 07
 (891) 2022 07 19
 (511) 03, 44

(260) AM 2023 119063 A
 (800) 1185672
 (151) 2013 05 06
 (181) 2023 05 06
 (891) 2022 07 29
 (511) 05, 25, 35

(260) AM 2023 119070 A
 (800) 1574202
 (151) 2020 12 23
 (181) 2030 12 23
 (891) 2022 07 19
 (511) 03, 44

(260) AM 2023 119071 A
(800) 1607096
(151) 2021 04 07
(181) 2031 04 07
(891) 2022 07 29
(511) 12, 37

(260) AM 2023 119072 A
(800) 1660891
(151) 2021 11 16
(181) 2031 11 16
(891) 2022 06 08
(511) 09

(260) AM 2023 119073 A
(800) 1661029
(151) 2021 11 16
(181) 2031 11 16
(891) 2022 06 08
(511) 09

(260) AM 2023 119216 A
(800) 1679961
(151) 2022 06 10
(181) 2032 06 10
(891) 2022 06 10
(511) 20

(260) AM 2023 119217 A
(800) 1680017
(151) 2022 04 13
(181) 2032 04 13
(891) 2022 04 13
(511) 35

(260) AM 2023 119218 A
(800) 1680056
(151) 2022 04 19
(181) 2032 04 19
(891) 2022 04 19
(511) 30

(260) AM 2023 119219 A
(800) 1680198
(151) 2022 06 10
(181) 2032 06 10
(891) 2022 06 10
(511) 07, 09, 12

(260) AM 2023 119223 A
(800) 1680250
(151) 2022 06 21
(181) 2032 06 21
(891) 2022 06 21
(511) 09

(260) AM 2023 119224 A
(800) 1680258
(151) 2022 07 28
(181) 2032 07 28
(891) 2022 07 28
(511) 05

(260) AM 2023 119225 A
(800) 1680260
(151) 2022 07 12
(181) 2032 07 12
(891) 2022 07 12
(511) 09

(260) AM 2023 119232 A
(800) 1680443
(151) 2022 05 25
(181) 2032 05 25
(891) 2022 05 25
(511) 05

(260) AM 2023 119234 A
(800) 1680533
(151) 2022 01 19
(181) 2032 01 19
(891) 2022 01 19
(511) 12

(260) AM 2023 119257 A
(800) 1289699
(151) 2015 09 18
(181) 2025 09 18
(891) 2022 08 18
(511) 09, 35, 39, 42

(260) AM 2023 119258 A
(800) 1350988
(151) 2016 11 10
(181) 2026 11 10
(891) 2022 05 16
(511) 05, 30, 35, 42, 44

(260) AM 2023 119259 A
(800) 1351304
(151) 2016 11 10
(181) 2026 11 10
(891) 2022 05 16
(511) 05, 30, 35, 42, 44

(260) AM 2023 119260 A
(800) 1369898
(151) 2017 06 15
(181) 2027 06 15
(891) 2022 08 15
(511) 25

(260) AM 2023 119261 A
(800) 1490555
(151) 2019 08 02
(181) 2029 08 02
(891) 2022 08 15
(511) 25

(260) AM 2023 119262 A
(800) 1618172
(151) 2021 08 05
(181) 2031 08 05
(891) 2022 07 08
(511) 03, 05, 35, 42, 44

(260) AM 2023 119263 A
(800) 1623630
(151) 2021 04 13
(181) 2031 04 13
(891) 2022 04 12
(511) 10

საქონლის აღბილწარმოშობის დასახელებები

დაცული აღბილწარმოშობის დასახელების ღვინოების წარმოების სპეციფიკაციების ცვლილება

მუკუზანი (რეგ. №2, თარიღი: 30.08.2005 წ.), წინანდალი (რეგ. №3, თარიღი: 30.08.2005 წ.),
ახაშენი (რეგ. №4, თარიღი: 30.08.2005 წ.), თელიანი (რეგ. №791, თარიღი: 10.12.2007 წ.)

სსიპ – საქართველოს ინტელექტუალური საკუთრების ეროვნული ცენტრის – „საქპატენტის“ სასაქონლო ნიშნების, გეოგრაფიული აღნიშვნებისა და დიზაინის დეპარტამენტის უფროსის 2023 წლის 2 აგვისტოს №6306/06, №6307/06, №6308/06 და №6309/06 ბრძანებების საფუძველზე, ცვლილება შევიდა საქართველოს ინტელექტუალური საკუთრების ეროვნულ ცენტრში – „საქპატენტი“ რეგისტრირებული ადგილწარმოშობის დასახელებების მქონე ღვინოების: „მუკუზანი“, „წინანდალი“, „ახაშენი“ და „თელიანი“ წარმოების სპეციფიკაციებში.

„საქონლის ადგილწარმოშობის დასახელებებისა და გეოგრაფიული აღნიშვნების შესახებ“ საქართველოს კანონის თანახმად, აღნიშნული ინფორმაცია ქვეყნდება საქართველოს სამრეწველო საკუთრების ოფიციალურ ბიულეტენში, ერთ ცენტრალურ და ერთ ადგილობრივ გაზეთში.

მასალების გამოქვეყნებიდან 3 თვის ვადაში საქპატენტში წარმოდგენილი შენიშვნები და დამატებითი ინფორმაცია შესასწავლად გადაეგზავნება საქართველოს გარემოს დაცვისა და სოფლის მეურნეობის სამინისტროს. თუ 3 თვის განმავლობაში საქპატენტში არ შემოვა რაიმე ინფორმაცია აღნიშნულ მასალებთან დაკავშირებით, ადგილწარმოშობის დასახელებების მქონე ღვინოების: „მუკუზანი“, „წინანდალი“, „ახაშენი“ და „თელიანი“ წარმოების სპეციფიკაციების ცვლილებები აისახება ადგილწარმოშობის დასახელებისა და გეოგრაფიული აღნიშვნების სახელმწიფო რეესტრში.

მუკუზანი

სპეციფიკაციის მე-10 მუხლი ჩამოყალიბდეს შემდეგი რედაქციით:

10. პროდუქტის ეტიკეტირების და შეფუთვის განსაკუთრებული წესები:

დასახელება „მუკუზანი“ და აღნიშვნა „დაცული ადგილწარმოშობის დასახელების ღვინო“ ეტიკეტზე, შეფუთვაზე, ასევე, ღვინის თანმხლებ დოკუმენტებში და სარეკლამო მასალებში უცხო ენებზე დაიტანება შემდეგნაირად:

ლათინური შრიფტით – MUKUZANI Protected Designation of Origin ან/და PDO
რუსული შრიფტით – МУКУЗАНИ Защищённое наименование места происхождения

წინანდალი

სპეციფიკაციის მე-10 მუხლი ჩამოყალიბდეს შემდეგი რედაქციით:

10. პროდუქტის ეტიკეტირების და შეფუთვის განსაკუთრებული წესები:

დასახელება „წინანდალი“ და აღნიშვნა „დაცული ადგილწარმოშობის დასახელების ღვინო“ ეტიკეტზე, შეფუთვაზე, ასევე, ღვინის თანმხლებ დოკუმენტებში და სარეკლამო მასალებში უცხო ენებზე დაიტანება შემდეგნაირად:

ლათინური შრიფტით – TSINANDALI Protected Designation of Origin ან/და PDO
რუსული შრიფტით – ЦИНАНДАЛИ Защищённое наименование места происхождения

ახაშენი

სპეციფიკაციის მე-10 მუხლი ჩამოყალიბდეს შემდეგი რედაქციით:

10. პროდუქტის ეტიკეტირების და შეფუთვის განსაკუთრებული წესები:

დასახელება „ახაშენი“ და აღნიშვნა „დაცული ადგილწარმოშობის დასახელების ღვინო“ ეტიკეტზე, შეფუთვაზე, ასევე, ღვინის თანმხლებ დოკუმენტებში და სარეკლამო მასალებში უცხო ენებზე დაიტანება შემდეგნაირად:

ლათინური შრიფტით – AKHASHENI Protected Designation of Origin ან/და PDO
რუსული შრიფტით – АХАШЕНИ Защищённое наименование места происхождения

თელიანი

სპეციფიკაციის მე-10 მუხლი ჩამოყალიბდეს შემდეგი რედაქციით:

10. პროდუქტის ეტიკეტირების და შეფუთვის განსაკუთრებული წესები:

დასახელება „თელიანი“ და აღნიშვნა „დაცული ადგილწარმოშობის დასახელების ღვინო“ ეტიკეტზე, შეფუთვაზე, ასევე, ღვინის თანმხლებ დოკუმენტებში და სარეკლამო მასალებში უცხო ენებზე დაიტანება შემდეგნაირად:

ლათინური შრიფტით – TELIANI Protected Designation of Origin ან/და PDO
რუსული შრიფტით – ТЕЛИАНИ Защищённое наименование места происхождения

ოფიციალური შეტყობინებები

გამოგონებები

პატენტის მოქმედების ვადის ამოწურვა

(21) AP 2003 8643

(11) P 2007 4213 B

(73) ბრისტოლ-მაიერს სკუიბ კო.

(54) კინაზაპის ახალი ინჰიბიტორები

პატენტის მოქმედების ვადის ამოწურვის თარიღი: 2023 07 18

დიზაინები

დიზაინის რეგისტრაციის მოქმედების ვადის გაბრძნობა

(11) D 2018 789 S

(73) გელა გამტკიცულაშვილი (GE)

სოფელი ნაფარული, 2211, თელავის მუნიციპალიტეტი, საქართველო (GE);

გია გამტკიცულაშვილი (GE)

სოფელი ნაფარული, 2211, თელავის მუნიციპალიტეტი, საქართველო (GE)

(54) 1.-3. შპნობა

(28) 3

(24) 2018 04 25

(18) 2028 04 25

(58) 2023 08 04

დიზაინების რეგისტრაციის მოქმედების გაუქმება

(11) D 2018 769 S

(73) ქეთევან მეტყარიაშვილი (GE)

ჭილაძის ქ. 166, 0160, თბილისი, საქართველო (GE)

(54) ქუსლის დამცავი აქსესუარი

(18) 2022 12 08

(58) 2023 07 24

(11) D 2018 784 S

(73) მიხეილ ქოჩაკიძე (GE)

ტ. ტაბიძის ქ. 56, ბ. 1, 0162, თბილისი, საქართველო (GE)

(54) 1.-10. ბოთლი ბლოკნოტის ფურცლის ეტიკეტით

(18) 2023 01 18

(58) 2023 08 02

(11) D 2013 554 S
(73) მანანა ჩუბინიძე (GE)
ს. ზაქარიაძის 14, 4600, ქუთაისი, საქართველო (GE);
ბათუ ფხაკაძე (GE)
ს. ზაქარიაძის 14, 4600, ქუთაისი, საქართველო (GE)
(54) პლასტმასის დასაკეცი ქუთი
(18) 2022 12 28
(58) 2023 07 24

(11) D 2013 529 S
(73) ოლო „ფირმა „დისნა“ (UA)
ბ-რ დრუჟი ნაროდოვ დომ 14-16, პომეშჩენიე 500, 01103, კიევი, უკრაინა (UA)
(54) ეტიკეტი
(18) 2023 01 10
(58) 2023 07 24

სამართაშორისო დიზაინების რეგისტრაციის მოქმედების ვადის
გაგრძელება

(11) DM/102 450
(73) Rolex SA
3-5-7, Rue François-Dussaud, CH-1211 GENEVE 26 (CH)
(15) 2018 07 30
(24) 2018 07 30
(18) 2028 07 30
(28) 1
(28') 1
(54) 1. WATCH DIAL

(11) DM/64597
(73) Comptoir Nouveau De La Parfumerie,
23, Rue Boissy D'Anglas F-75008 PARIS (FR)
(15) 2003 11 17
(24) 2003 11 17
(18) 2028 11 17
(28) 1
(28') 1
(54) BOTTLE

(11) DM/64745
(73) Famedtec GmbH
Hauptstrasse 42 3255 Rapperswil, BE (CH)
(15) 2003 11 28
(24) 2003 11 28
(18) 2028 11 28
(28) 1
(28') 1
(54) ELECTRIC APPLIANCE FOR HARMONISING BODILY ENERGY.

(11) DM/70343
(73) Blancpain SA
Le Rocher 12, CH-1348 LE BRASSUS (CH)
(15) 2008 06 27
(24) 2008 06 27
(18) 2028 06 27
(28) 1
(28') 1
(54) WATCH DIAL

(11) DM/70405
(73) Swatch AG (Swatch SA) (Swatch LTD.)
Jakob-Stämpfli-Strasse 94, CH-2502 Biel/Bienne (CH)
(15) 2008 07 10
(24) 2008 07 10
(18) 2028 07 10
(28) 4
(28') 4
(54) WRISTWATCHES

(11) DM/70481
(73) Swatch AG (Swatch SA) (Swatch LTD.)
Jakob-Stämpfli-Strasse 94, CH-2502 Biel/Bienne (CH)
(15) 2008 07 24
(24) 2008 07 24
(18) 2028 07 24
(28) 12
(28') 6
(54) WRIST-WATCHES

(11) DM/70610
(73) "Ital Food Industry" AD, "Trakiyska"
Str. No 10, BG-9700 Shumen (BG)
(15) 2008 07 07
(24) 2008 07 07
(18) 2028 07 07
(28) 5
(28') 5
(54) PACKAGINGS FOR CRACKERS

(11) DM/70826
(73) Total Energies SE
2 Place Jean Millier, La Défense 6 F-92400 Courbevoie (FR)
(15) 2008 10 10
(24) 2008 10 10
(18) 2028 10 10
(28) 1
(28') 1
(54) CAN

(11) DM/81344
(73) Swatch AG (Swatch SA) (Swatch LTD.)
Jakob-Stämpfli-Strasse 94, CH-2502 Biel/Bienne (CH)

(15) 2013 07 11
(24) 2013 07 11
(18) 2028 07 11
(28) 4
(28') 4
(54) 1.-2. WRISTWATCHES, 3.-4. DIALS

(11) DM/81346
(73) Swatch AG (Swatch SA) (Swatch LTD.)
Jakob-Stämpfli-Strasse 94, CH-2502 Biel/Bienne (CH)
(15) 2013 07 11
(24) 2013 07 11
(18) 2028 07 11
(28) 2
(28') 2
(54) 1.-2. WRISTWATCHES

(11) DM/81350
(73) Swatch AG (Swatch SA) (Swatch LTD.)
94, rue Jakob Stämpfli, CH-2502 Biel/Bienne (CH)
(15) 2013 07 11
(24) 2013 07 11
(18) 2028 07 11
(28) 1
(28') 1
(54) WRISTWATCH

(11) DM/81354
(73) Yandex Europe AG
Werftstrasse 4, CH-6005 Luzern (CH)
(15) 2013 05 22
(24) 2013 05 22
(18) 2028 05 22
(28) 2
(28') 2
(54) GRAPHICAL USER INTERFACES

(11) DM/81369
(73) Montres Breguet S.A.
Place de la Tour 23, CH-1344 L'ABBAYE (CH)
(15) 2013 07 16
(24) 2013 07 16
(18) 2028 07 16
(28) 1
(28') 1
(54) WATCH

(11) DM/81371
(73) Swatch AG (Swatch SA) (Swatch LTD.)
94, rue Jakob Stämpfli, CH-2502 Biel/Bienne (CH)
(15) 2013 07 19
(24) 2013 07 19
(18) 2028 07 19
(28) 1

(28') 1
(54) WATCH CASE

(11) DM/81427
(73) Swatch AG (Swatch SA) (Swatch LTD.)
Jakob-Stämpfli-Strasse 94, CH-2502 Biel/Bienne (CH)
(15) 2013 07 29
(24) 2013 07 29
(18) 2028 07 29
(28) 1
(28') 1
(54) WRISTWATCH

(11) DM/81429
(73) Omega SA (Omega AG) (Omega LTD.)
Jakob-Stämpfli-Strasse 96, CH-2502 Biel/Bienne (CH)
(15) 2013 07 29
(24) 2013 07 29
(18) 2028 07 29
(28) 1
(28') 1
(54) WATCH

(11) DM/81817
(73) Pro-Aqua International
Technologiepark 1, 91522 Ansbach (DE)
(15) 2013 06 28
(24) 2013 06 28
(18) 2028 06 28
(28) 3
(28') 3
(54) VACUUM CLEANERS

(11) DM/82815
(73) Nikolay Petrov Serdev
Layosh Koshut Str. 8, app. 24, Sofia (BG)
(15) 2013 07 05
(24) 2013 07 05
(18) 2028 07 05
(28) 2
(28') 2
(54) SURGICAL NEEDLES

სასაქონლო ნიშნები

რეგისტრაციის მოქმედების ვადის გაგრძელება

(111) M 2003 14881 R2

(151) 2003 01 14

(186) 2033 01 14

(732) თამაზ შილაკაძე

ბახტრიონის ქ. 6, ბ. 24, 0160, თბილისი,
საქართველო

(111) M 2013 23311 R1

(151) 2013 02 12

(186) 2033 02 12

(732) ასფარმა მედიკალ დენტალ ურუნლერი
ილაჩ სან. თიჯ. ა.შ.

ბაჰჩელიველერ მაჰ.რესამ ჰალიმ სოქაქ.
ქადირ ჰას იმ მერქეზი No.72 34189
სტამბოლი, თურქეთი

(111) M 2003 14870 R2

(151) 2003 01 14

(186) 2033 01 14

(732) თამაზ შილაკაძე

ბახტრიონის ქ. 6, ბ. 24, 0160, თბილისი,
საქართველო

(111) M 2013 23505 R1

(151) 2013 03 27

(186) 2033 03 27

(732) სააქციო საზოგადოება „ლომისი“
სოფ. ნატახტარი, 3308, მცხეთა,
საქართველო

(111) M 2003 14879 R2

(151) 2003 01 14

(186) 2033 01 14

(732) თამაზ შილაკაძე

ბახტრიონის ქ. 6, ბ. 24, 0160, თბილისი,
საქართველო

(111) M 2013 23968 R1

(151) 2013 09 02

(186) 2033 09 02

(732) სკეჩერს იუ.ეს.ეი ინკ. II

ვირჯინიის კორპორაცია
228 მანჰეტენ ბიჩ ბლვდ., მანჰეტენ
ბიჩი, კალიფორნია 90266, აშშ

(111) M 2003 15067 R2

(151) 2003 03 28

(186) 2033 03 28

(732) სააქციო საზოგადოება „ლომისი“

სანაპიროს ქ. 1, 0600, დაბა ახალგორი,
საქართველო

(111) M 2013 23916 R1

(151) 2013 08 14

(186) 2033 08 14

(732) დე ბევერიჯიზ ანლიმიტიდ კომპანი

საუთგეით, დუბლინ როუდ, დროგჰედა,
ქაუნთი მით, A92 YK7W, ირლანდია

(111) M 2003 15254 R2

(151) 2003 09 29

(186) 2033 09 29

(732) მიცუბიში ჯიდომა კოგოი კაბუშიკი კაიმა

1-21, შიბაურა 3-ჩომე, მინატოკუ, ტოკიო
108-8410, იაპონია

(111) M 2013 23998 R1

(151) 2013 09 02

(186) 2033 09 02

(732) ვიზა ინტერნემენელ სერვის ასოსიეიშენ

900 მეტრო სენტერ ბულვარი, ფოსტერ
სიტი, კალიფორნია 94404, აშშ

(111) M 2003 15261 R2

(151) 2003 09 29

(186) 2033 09 29

(732) ალტიკორ ინკ.

7575 ფულტონ სტრიტ ისტი, ეიდა,
მიჩიგანის შტატი 49355, აშშ

უფლებების სრული ბაღაცემა

(111) M 2013 23813 R

(732) აკვორ მენეჯმენტ კანადა ინკ.

155 ველინგტონ სტრიტ ვესტი,

ტორონტო, ონტარიო, M5V 0C3, კანადა

(770) ფემონტ სპას ინკ.

155 ველინგტონ სტრიტ ვესტი,

ტორონტო, ონტარიო M5V 0C3, კანადა

(580) 2023 07 07

(111) M 2014 24833 R

(732) ჯემალ ზადათურია

მ. ალექსიძის ქ., I შეს. 9, ბ. 13, თბილისი,

საქართველო

(770) შპს „სითი გრუფ“

ირაკლი აბაშიძის ქ. 42, ბ. 13, 0179,

თბილისი, საქართველო

(580) 2023 07 06

ფლოპდის სახელის და/ან მისამართის ცვლილებები

(111) M 2020 32201 R
 (732) გალაჰერ ლიმიტიდ
 1 ვერტერ როუდი, SW15 2LL ლონდონი,
 გაერთიანებული სამეფო
 (770) გალაჰერ ლიმიტიდ
 მემბერს ჰილი, ბრუკლენდზ როუდი,
 უეიბრიჯი, სარი KT13 0QU,
 გაერთიანებული სამეფო
 (580) 2023 07 07

(111) M 2021 34013 R
 (732) გალაჰერ ლიმიტიდ
 1 ვერტერ როუდი, SW15 2LL ლონდონი,
 გაერთიანებული სამეფო
 (770) გალაჰერ ლიმიტიდ
 მემბერს ჰილი, ბრუკლენდზ როუდი,
 უეიბრიჯი, სარი KT13 0QU,
 გაერთიანებული სამეფო
 (580) 2023 07 07

(111) M 2021 34012 R
 (732) გალაჰერ ლიმიტიდ
 1 ვერტერ როუდი, SW15 2LL ლონდონი,
 გაერთიანებული სამეფო
 (770) გალაჰერ ლიმიტიდ
 მემბერს ჰილი, ბრუკლენდზ როუდი,
 უეიბრიჯი, სარი KT13 0QU,
 გაერთიანებული სამეფო
 (580) 2023 07 07

(111) M 2021 34684 R
 (732) შპს „დეილი“
 ახმეთ მელაშვილის ქ. 2, ვარკეთილის
 მეურნეობის დასახლება, სამგორის
 რაიონი, თბილისი, საქართველო
 (770) შპს „დეილი“
 კახეთის გზატკეცილი, კორპ. 17, 0190,
 ისნის რაიონი, თბილისი, საქართველო
 (580) 2023 07 25

(111) M 2021 34679 R
 (732) გალაჰერ ლიმიტიდ
 1 ვერტერ როუდი, SW15 2LL ლონდონი,
 გაერთიანებული სამეფო

(770) გალაჰერ ლიმიტიდ
 მემბერს ჰილი, ბრუკლენდზ როუდი,
 უეიბრიჯი, სარი KT13 0QU,
 გაერთიანებული სამეფო
 (580) 2023 07 07

(111) M 2021 34686 R
 (732) შპს „დეილი“
 ახმეთ მელაშვილის ქ. 2, ვარკეთილის
 მეურნეობის დასახლება, სამგორის
 რაიონი, თბილისი, საქართველო
 (770) შპს „დეილი“
 კახეთის გზატკეცილი, კორპ. 17, 0190,
 ისნის რაიონი, თბილისი, საქართველო
 (580) 2023 07 25

(111) M 2021 34891 R
 (732) გალაჰერ ლიმიტიდ
 1 ვერტერ როუდი, SW15 2LL ლონდონი,
 გაერთიანებული სამეფო
 (770) გალაჰერ ლიმიტიდ
 მემბერს ჰილი, ბრუკლენდზ როუდი,
 უეიბრიჯი, სარი KT13 0QU,
 გაერთიანებული სამეფო
 (580) 2023 07 07

(111) M 2022 35452 R
 (732) გალაჰერ ლიმიტიდ
 1 ვერტერ როუდი, SW15 2LL ლონდონი,
 გაერთიანებული სამეფო
 (770) გალაჰერ ლიმიტიდ
 მემბერს ჰილი, ბრუკლენდზ როუდი,
 უეიბრიჯი, სარი KT13 0QU,
 გაერთიანებული სამეფო
 (580) 2023 07 07

(111) M 2023 36537 R
 (732) გალაჰერ ლიმიტიდ
 1 ვერტერ როუდი, SW15 2LL ლონდონი,
 გაერთიანებული სამეფო
 (770) გალაჰერ ლიმიტიდ
 მემბერს ჰილი, ბრუკლენდზ როუდი,
 უეიბრიჯი, სარი KT13 0QU,
 გაერთიანებული სამეფო
 (580) 2023 07 07

| | |
|---|---|
| <p>(111) M 1997 7168 R (732) კეიჯი მობილიტი კორპ. 455-12 (ჩილგოუ-დონგ), დონგსაკ-რო, პიონტექ-სი, ჯონჯი-დო, კორეის რესპუბლიკა (770) სანგიონგ მობილიტი კომპანი 150-3, ჩილგოი დონგი, პიუნგტაეკ-სი, კიუნგკი-დო, კორეის რესპუბლიკა (580) 2023 07 05</p> | <p>უეიბრიჯი, სარი, KT13 0QU, გაერთიანებული სამეფო (580) 2023 07 07</p> |
| <p>(111) M 1996 2595 R (732) გალაპერ ლიმიტიდ 1 ვერტერ როუდი, SW15 2LL ლონდონი, გაერთიანებული სამეფო (770) გალაპერ ლიმიტიდ მემბერს ჰილი, ბრუკლენდზ როუდი, უეიბრიჯი, სარი KT13 0QU, გაერთიანებული სამეფო (580) 2023 07 07</p> | <p>(111) M 2000 13575 R (732) გალაპერ ლიმიტიდ 1 ვერტერ როუდი, SW15 2LL ლონდონი, გაერთიანებული სამეფო (770) გალაპერ ლიმიტიდ მემბერს ჰილი, ბრუკლენდზ როუდი, უეიბრიჯი, სარი KT13 0QU, გაერთიანებული სამეფო (580) 2023 07 07</p> |
| <p>(111) M 1995 991 R (732) გალაპერ ლიმიტიდ 1 ვერტერ როუდი, SW15 2LL ლონდონი, გაერთიანებული სამეფო (770) გალაპერ ლიმიტიდ მემბერს ჰილი, ბრუკლენდზ როუდი, უეიბრიჯი, სარი KT13 0QU, გაერთიანებული სამეფო (580) 2023 07 07</p> | <p>(111) M 2002 14671 R (732) გალაპერ ლიმიტიდ 1 ვერტერ როუდი, SW15 2LL ლონდონი, გაერთიანებული სამეფო (770) გალაპერ ლიმიტიდ მემბერს ჰილი, ბრუკლენდზ როუდი, უეიბრიჯი, სარი KT13 0QU, გაერთიანებული სამეფო (580) 2023 07 07</p> |
| <p>(111) M 1995 985 R (732) გალაპერ ლიმიტიდ 1 ვერტერ როუდი, SW15 2LL ლონდონი, გაერთიანებული სამეფო (770) გალაპერ ლიმიტიდ მემბერს ჰილი, ბრუკლენდზ როუდი, უეიბრიჯი, სარი, KT13 0QU, გაერთიანებული სამეფო (580) 2023 07 07</p> | <p>(111) M 2002 14679 R (732) კეიჯი მობილიტი კორპ. 455-12 (ჩილგოუ-დონგ), დონგსაკ-რო, პიონტექ-სი, ჯონჯი-დო, კორეის რესპუბლიკა (770) სანგიონგ მობილიტი კომპანი 150-3 ჩილგოი-დონგი, პიუნგტაეკ-სი, კიუნგკი-დო, 459-050, კორეის რესპუბლიკა (580) 2023 07 05</p> |
| <p>(111) M 1996 4084 R (732) გალაპერ ლიმიტიდ 1 ვერტერ როუდი, SW15 2LL ლონდონი, გაერთიანებული სამეფო (770) გალაპერ ლიმიტიდ მემბერს ჰილი, ბრუკლენდზ როუდი, უეიბრიჯი, სარი, KT13 0QU, გაერთიანებული სამეფო (580) 2023 07 07</p> | <p>(111) M 2003 15193 R (732) ვაიეტ ლლკ 66 ჰადსონ ბულვარ ისტ, ნიუ-იორკი, NY 10001-2192, აშშ (770) ვაიეტ ლლკ 235 ისტ 42-ე სტრიტი, ნიუ-იორკი, N.Y. 10017, აშშ (580) 2023 06 06</p> |

(111) M 2003 15194 R
 (732) კეიჯი მობილიტი კორპ.
 455-12 (ჩილგოუ-დონგ), დონგსაკ-რო,
 პიონტექ-სი, ჯონჯი-დო, კორეის
 რესპუბლიკა
 (770) სანგიონგ მოტორ კომპანი
 150-3, ჩილკოი-დონგი, პიუნგტაეკ-სი,
 კიუნგკი-დო, კორეის რესპუბლიკა
 (580) 2023 06 26

(111) M 2004 15814 R
 (732) გალაჰერ ლიმიტიდ
 1 ვერტერ როუდი, SW15 2LL ლონდონი,
 გაერთიანებული სამეფო
 (770) გალაჰერ ლიმიტიდ
 მემბერს ჰილი, ბრუკლენდზ როუდი,
 უეიბრიჯი, სარი KT13 0QU,
 გაერთიანებული სამეფო
 (580) 2023 07 07

(111) M 2004 15694 R
 (732) გუანგქსი გოლდენ თროუტ კო., ლტდ
 N 28, ფენსიანგ როუდი, ლიუჩოუ-
 სიტი, გუანსი, ჩინეთის სახალხო
 რესპუბლიკა
 (770) გუანგქსი გოლდენ თროუტ კო., ლტდ
 N 28, იუეჯინ როუდი, ლიუჩოუ-
 სიტი, გუანგქსი 545001, ჩინეთის სახალხო
 რესპუბლიკა
 (580) 2023 06 29

(111) M 2004 15756 R
 (732) გუანგქსი გოლდენ სროატ კო., ლტდ
 N 28, ფენსიანგ როუდი, ლიუჩოუ-
 სიტი, გუანსი, ჩინეთის სახალხო
 რესპუბლიკა
 (770) გუანგქსი გოლდენ სროატ კო., ლტდ
 N 28, იუეჯინ როუდი, ლიუჩოუ-
 სიტი, გუანგქსი 545001, ჩინეთის სახალხო
 რესპუბლიკა
 (580) 2023 06 29

(111) M 2006 16435 R
 (732) გალაჰერ ლიმიტიდ
 1 ვერტერ როუდი, SW15 2LL ლონდონი,
 გაერთიანებული სამეფო
 (770) გალაჰერ ლიმიტიდ

მემბერს ჰილი, ბრუკლენდზ როუდი,
 უეიბრიჯი, სარი KT13 0QU,
 გაერთიანებული სამეფო
 (580) 2023 07 07

(111) M 2006 16771 R
 (732) გალაჰერ ლიმიტიდ
 1 ვერტერ როუდი, SW15 2LL ლონდონი,
 გაერთიანებული სამეფო
 (770) გალაჰერ ლიმიტიდ
 მემბერს ჰილი, ბრუკლენდზ როუდი,
 უეიბრიჯი, სარი KT13 0QU,
 გაერთიანებული სამეფო
 (580) 2023 07 07

(111) M 2006 16896 R
 (732) კეიჯი მობილიტი კორპ.
 455-12 (ჩილგოუ-დონგ), დონგსაკ-რო,
 პიონტექ-სი, ჯონჯი-დო, კორეის
 რესპუბლიკა
 (770) სანგიონგ მოტორ კომპანი
 150-3, ჩილკოი-დონგი, პიუნგტაეკ-სი,
 კიუნგკი-დო, კორეის რესპუბლიკა
 (580) 2023 07 05

(111) M 2008 18371 R
 (732) გალაჰერ ლიმიტიდ
 1 ვერტერ როუდი, SW15 2LL ლონდონი,
 გაერთიანებული სამეფო
 (770) გალაჰერ ლიმიტიდ
 მემბერს ჰილი, ბრუკლენდზ როუდი,
 უეიბრიჯი, სარი KT13 0QU,
 გაერთიანებული სამეფო
 (580) 2023 07 07

(111) M 2008 18491 R
 (732) გალაჰერ ლიმიტიდ
 1 ვერტერ როუდი, SW15 2LL ლონდონი,
 გაერთიანებული სამეფო
 (770) გალაჰერ ლიმიტიდ
 მემბერს ჰილი, ბრუკლენდზ როუდი,
 უეიბრიჯი, სარი KT13 0QU,
 გაერთიანებული სამეფო
 (580) 2023 07 07

(111) M 2018 29309 R
 (732) გალაჰერ ლიმიტიდ
 1 ვერტერ როუდი, SW15 2LL ლონდონი,
 გაერთიანებული სამეფო
 (770) გალაჰერ ლიმიტიდ
 მემბერს ჰილი, ბრუკლენდზ როუდი,
 KT13 0QU, უეიბრიჯი, სარი,
 გაერთიანებული სამეფო
 (580) 2023 07 07

უეიბრიჯი, KT13 0QU სარი,
 გაერთიანებული სამეფო
 (580) 2023 07 07

(111) M 2018 29310 R
 (732) გალაჰერ ლიმიტიდ
 1 ვერტერ როუდი, SW15 2LL ლონდონი,
 გაერთიანებული სამეფო
 (770) გალაჰერ ლიმიტიდ
 მემბერს ჰილი, ბრუკლენდზ როუდი,
 KT13 0QU, უეიბრიჯი, სარი,
 გაერთიანებული სამეფო
 (580) 2023 07 07

(111) M 2018 29419 R
 (732) გალაჰერ ლიმიტიდ
 1 ვერტერ როუდი, SW15 2LL ლონდონი,
 გაერთიანებული სამეფო
 (770) გალაჰერ ლიმიტიდ
 მემბერს ჰილი, ბრუკლენდზ როუდი,
 უეიბრიჯი, KT13 0QU სარი,
 გაერთიანებული სამეფო
 (580) 2023 07 07

(111) M 2018 29420 R
 (732) გალაჰერ ლიმიტიდ
 1 ვერტერ როუდი, SW15 2LL ლონდონი,
 გაერთიანებული სამეფო
 (770) გალაჰერ ლიმიტიდ
 მემბერს ჰილი, ბრუკლენდზ როუდი
 უეიბრიჯი, სარი KT13 0QU,
 გაერთიანებული სამეფო
 (580) 2023 07 07

(111) M 2018 30188 R
 (732) გალაჰერ ლიმიტიდ
 1 ვერტერ როუდი, SW15 2LL ლონდონი,
 გაერთიანებული სამეფო
 (770) გალაჰერ ლიმიტიდ
 მემბერს ჰილი, ბრუკლენდზ როუდი,

სასაქონლო ნიშნების რეგისტრაციის განქმევა

(111) M 2003 14882 R
(151) 2003 01 14
(732) მარიოტ უორლდუაიდ კორპორეიშენ
მერილენდის კორპორაცია
10400 ფერნუდ როუდი, ბეთეზდა,
მერილენდი 20817, აშშ
(141) 2023 08 04

(111) M 2003 14874 R
(151) 2003 01 14
(732) პფაიზერ პფე უეს ჰოლდინგს 4 ელელსი
235 ისტ 42-ე სტრიტი, ნიუ-იორკი,
N.Y. 10017, აშშ
(141) 2023 08 03

(111) M 2003 14934 R
(151) 2003 01 30
(732) ფარმაცია & აპჯონ კომპანი ლლკ
201 ტაბორ-როუდი, მორის-პლეინზი,
NJ 07950, აშშ
(141) 2023 08 02

(111) M 2003 14869 R
(151) 2003 01 14
(732) ბეთექ ბოია ვე ქიმიკ სანაი ა.შ.
ანკარა ასფალტი, ჰუსეინ ჩელიქ
სოქ. N9 კოზიათაგი 81090
ბოსთანჯი, სტამბოლი, თურქეთი
(141) 2023 08 02

(111) M 2003 14899 R
(151) 2003 01 14
(732) ზე კოკა-კოლა კომპანი
უან კოკა-კოლა პლაზა, ატლანტა, ჯორჯია
30313, აშშ
(141) 2023 08 02

(111) M 2003 14943 R
(151) 2003 01 30
(732) ემჯენ ინკ.
უან ემჯენ სენტერ დრაივი, თაუზენდ-
ოუკსი, კალიფორნია 91320-1799, აშშ
(141) 2023 08 02

(111) M 2003 14946 R
(151) 2003 01 30
(732) ილან ფარმა ინტერნეშენელ ლიმიტიდ
თრეჟერი ბილდინგი, ლოუერ გრანდ
კანალ სტრიტი, დუბლინი 2, ირლანდია
(141) 2023 08 02

(111) M 2003 14900 R
(151) 2003 01 14
(732) ზე კოკა-კოლა კომპანი
უან კოკა-კოლა პლაზა, ატლანტა, ჯორჯია
30313, აშშ
(141) 2023 08 04

(111) M 2003 14949 R
(151) 2003 01 30
(732) სანოფი
54 რიუ ლა ბოეტი, 75008 პარიზი,
საფრანგეთი
(141) 2023 08 02

(111) M 2003 14907 R
(151) 2003 01 14
(732) რეინოლდს ინოვეიშენს ინკ.
401 ნორთ მენ სტრიტი, უინსტონ-
სალემი, ჩრდილოეთი კაროლინა 27102,
აშშ
(141) 2023 08 02

(111) M 2013 23265 R
(151) 2013 01 25
(732) ჰარინგტონ დიველოპმენტ ინკ.
არანგო-ორილაკ ბილდინგი, ისტ 54
სტრიტი, პანამის რესპუბლიკა
(141) 2023 08 02

(111) M 2013 23266 R
(151) 2013 01 25
(732) ჰარინგტონ დიველოპმენტ ინკ.
არანგო-ორილაკ ბლდგ, ისტ 54 სტრიტი,
პანამა, პანამის რესპუბლიკა
(141) 2023 08 02

| | |
|--|--|
| (111) M 2013 23268 R (151) 2013 01 25 (732) ჯენერალ მოტორს ლლკ 300 რენესენს სენტერი, სიტი-ოფ- დეტროიტი, მიჩიგანის შტატი 48265-3000, აშშ (141) 2023 08 02 | 1-1, დოშომაჩი 4-ჩომე, ჩუო-კუ, ოსაკა, იაპონია (141) 2023 08 03 |
| (111) M 2013 23239 R (151) 2013 01 09 (732) შპს „მურად ტექსტილ“ კრწანისის ქ. 78, 0114, თბილისი, საქართველო (141) 2023 08 02 | (111) M 2013 23274 R (151) 2013 01 25 (732) ტაკედა ფარმასეუტიკალ კომპანი ლიმიტიდ 1-1, დოშომაჩი 4-ჩომე, ჩუო-კუ, ოსაკა, იაპონია (141) 2023 08 03 |
| (111) M 2013 23271 R (151) 2013 01 25 (732) ბოსტ ჰოლდინგზ N 301, 3რდ ფლ., 773-8 იეოკსამ-2 დონგ, განგნამ-გუ, სეული, კორეის რესპუბლიკა (141) 2023 08 02 | (111) M 2013 23275 R (151) 2013 01 25 (732) ტაკედა ფარმასეუტიკალ კომპანი ლიმიტიდ 1-1, დოშომაჩი 4-ჩომე, ჩუო-კუ, ოსაკა, იაპონია (141) 2023 08 03 |
| (111) M 2013 23272 R (151) 2013 01 25 (732) ბრიტიშ ამერიკენ ტობაკო ვესტერნ იუროპ კომერშელ ტრედიდინგ ლიმიტიდ გლობ ჰაუზი, 1 უოტერ სტრიტი, ლონდონი, WC2R 3LA, გაერთიანებული სამეფო (141) 2023 08 03 | (111) M 2013 23276 R (151) 2013 01 25 (732) ტაკედა ფარმასეუტიკალ კომპანი ლიმიტიდ 1-1, დოშომაჩი 4-ჩომე, ჩუო-კუ, ოსაკა, იაპონია (141) 2023 08 03 |
| (111) M 2012 23203 R (151) 2012 12 10 (732) ააიპ „საქართველოს საავტორო უფლებათა ასოციაცია“ – ქონებრივი უფლებების კოლექტიურ საფუძველზე მმართველი ორგანიზაცია დავით აღმაშენებლის გამზ. 123, 0112, თბილისი, საქართველო (141) 2023 08 04 | (111) M 2013 23277 R (151) 2013 01 25 (732) ტაკედა ფარმასეუტიკალ კომპანი ლიმიტიდ 1-1, დოშომაჩი 4-ჩომე, ჩუო-კუ, ოსაკა, იაპონია (141) 2023 08 03 |
| (111) M 2013 23273 R (151) 2013 01 25 (732) ტაკედა ფარმასეუტიკალ კომპანი ლიმიტიდ | (111) M 2013 23284 R (151) 2013 01 25 (732) ტაკედა ფარმასეუტიკალ კომპანი ლიმიტიდ 1-1, დოშომაჩი 4-ჩომე, ჩუო-კუ, ოსაკა, იაპონია (141) 2023 08 03 |

(111) M 2013 23285 R
 (151) 2013 01 25
 (732) ტაკედა ფარმასეუტიკალ კომპანი
 ლიმიტიდ
 1-1, დომომაჩი 4-ჩომე, ჩუო-კუ, ოსაკა,
 იაპონია
 (141) 2023 08 03

(111) M 2013 23286 R
 (151) 2013 01 25
 (732) ხვიჩა თვალაბეიშვილი
 გამსახურდიას გამზ. 2, ბ. 51, 0160,
 თბილისი, საქართველო
 (141) 2023 08 03

(111) M 2013 23287 R
 (151) 2013 01 25
 (732) კარენ ვარდანიანი
 ბაირონის ქ. 3, ბ. 36, ერევანი, სომხეთი
 (141) 2023 08 03

(111) M 2013 23288 R
 (151) 2013 01 25
 (732) კარენ ვარდანიანი
 ბაირონის ქ. 3, ბ. 36, ერევანი, სომხეთი
 (141) 2023 08 03

(111) M 2013 23289 R
 (151) 2013 01 25
 (732) კარენ ვარდანიანი
 ბაირონის ქ. 3, ბ. 36, ერევანი, სომხეთი
 (141) 2023 08 03

(111) M 2013 23290 R
 (151) 2013 01 25
 (732) კარენ ვარდანიანი
 ბაირონის ქ. 3, ბ. 36, ერევანი, სომხეთი
 (141) 2023 08 03

(111) M 2013 23291 R
 (151) 2013 01 25
 (732) კარენ ვარდანიანი
 ბაირონის ქ. 3, ბ. 36, ერევანი, სომხეთი
 (141) 2023 08 03

(111) M 2013 23292 R
 (151) 2013 01 25
 (732) კარენ ვარდანიანი
 ბაირონის ქ. 3, ბ. 36, ერევანი, სომხეთი
 (141) 2023 08 03

(111) M 2013 23293 R
 (151) 2013 01 25
 (732) კარენ ვარდანიანი
 ბაირონის ქ. 3, ბ. 36, ერევანი, სომხეთი
 (141) 2023 08 03

(111) M 2013 23296 R
 (151) 2013 01 25
 (732) კარგილ ინკორპორეტიდ
 15407 მაკგინტი როუდ ვესტი, უაიზატა,
 მინესოტა 55391-5624, აშშ
 (141) 2023 08 04

(111) M 2013 23300 R
 (151) 2013 01 25
 (732) შპს „ივერთა“
 სანაპიროს ქ. 10ა, 0108, თბილისი,
 საქართველო
 (141) 2023 08 04

(111) M 2013 23301 R
 (151) 2013 01 25
 (732) შპს „ივერთა“
 სანაპიროს ქ. 10ა, 0108, თბილისი,
 საქართველო
 (141) 2023 08 04

(111) M 2013 23245 R
 (151) 2013 01 09
 (732) ბრიტიშ ამერიკენ ტობაკო (ბრენდს)
 ლიმიტედ
 გლოუზ ჰაუზი, 4 ტემპლ პლეისი,
 ლონდონი WC2R 2 PG, გაერთიანებული
 სამეფო
 (141) 2023 08 04

(111) M 2013 23246 R
 (151) 2013 01 09
 (732) ნანიანგ ბრაზერს ტობაკო კომპანი
 ლიმიტიდ

9 ცინგ იეუნგ სერკითი, ტუნენ მუნი,
ნიუ ტერიტორიზი, ჰონკონგი, ჩინეთის
სახალხო რესპუბლიკა
(141) 2023 08 04

(111) M 2013 23305 R
(151) 2013 01 25
(732) შპს „კვარიათი სანსეტ“
დასახლება კვარიათი, ბათუმი, 6414,
საქართველო
(141) 2023 08 04

(111) M 2013 23247 R
(151) 2013 01 09
(732) ნანიანგ ბრაზერს ტობაკო კომპანი
ლიმიტიდ
9 ცინგ იეუნგ სერკითი, ტუნენ მუნი,
ნიუ ტერიტორიზი, ჰონკონგი, ჩინეთის
სახალხო რესპუბლიკა
(141) 2023 08 04

(111) M 2013 23252 R
(151) 2013 01 09
(732) გიორგი ჯანაშვილი
ტერენტი გრანელის ქ., შესახვევი 6,
0102, თბილისი, საქართველო
(141) 2023 08 04

(111) M 2013 23248 R
(151) 2013 01 09
(732) ნანიანგ ბრაზერს ტობაკო კომპანი
ლიმიტიდ
9 ცინგ იეუნგ სერკითი, ტუნენ მუნი,
ნიუ ტერიტორიზი, ჰონკონგი, ჩინეთის
სახალხო რესპუბლიკა
(141) 2023 08 04

(111) M 2013 23264 R
(151) 2013 01 22
(732) ჯაპან ტობაკო ინკ.
2-2-1, ტორანომონ, მინატო-კუ, ტოკიო,
იაპონია
(141) 2023 08 03

(111) M 2013 23303 R
(151) 2013 01 25
(732) შპს „ლიკა-ჯორჯია“
გაგარინის ქ., II შესახვევი 4, 0160,
თბილისი, საქართველო
(141) 2023 08 04

(111) M 2013 23229 R
(151) 2013 01 04
(732) ინდ. მეწარმე „ია კვარაცხელია“
ზ. გორგილაძის ქ. კორპ. 73, ბ. 12, 6000,
ბათუმი, საქართველო
(141) 2023 07 24

(111) M 2013 23304 R
(151) 2013 01 25
(732) უნილევერ აიპი ჰოლდინგს ბ.ვ.
ვეენა 455, 3013 AL როტერდამი,
ნიდერლანდები
(141) 2023 08 04

(111) M 2013 23259 R
(151) 2013 01 18
(732) თეიმურაზ ჯოხაძე
აკადემიკოს კაპიცას ქ., სახლი 20, ბ. 107,
მოსკოვი, რუსეთის ფედერაცია
(141) 2023 08 03

(111) M 2013 23250 R
(151) 2013 01 09
(732) შპს „ემ-დი-სი- ჯგუფი“
ალ. ყაზბეგის გამზ. 8, ბ. 1, 0160, თბილისი,
საქართველო
(141) 2023 08 04

(111) M 2013 23263 R
(151) 2013 01 22
(732) სააქციო საზოგადოება „თბილისის
თამბაქო“
გ. ნადარეიშვილის ქ. 5ა, 0120, თბილისი,
საქართველო
(141) 2023 08 03

სისტემური საკითხები გამოგონებები

საერთაშორისო კლასიფიკაციის ინდექსის და ბანაცხალის
გამოქვეყნების ნომრის შესაბამისობის ცხრილი

| საერთაშორისო კლასიფიკაციის ინდექსი (51) | ბანაცხალის გამოქვეყნების ნომერი (10) |
|--|--|
| A 61 K 31/4164; A 61 P 19/02; A 61 P 17/06; A 61 P 11/06; A 61 P 3/10; C 07 D 491/048 | AP 2023 16005 A |
| A 61 K 31/4196; A 61 P 35/00; C 07 D 455/02; C 07 D 451/02; C 07 D 471/04; C 07 D 487/04; C 07 D 491/107; C 07 D 403/14; C 07 D 401/14; C 07 D 405/14; C 07 D 413/14; C 07 D 498/04; C 07 D 417/14; C 07 D 498/08 | AP 2023 15908 A |
| A 61 K 36/00 | AP 2023 16164 A |
| A 61 K 39/00; A 61 K 39/395; A 61 P 7/02; A 61 P 37/02; C 07 K 16/40 | AP 2023 15512 A |
| A 61 K 39/29; A 61 K 39/295; A 61 P 31/20 | AP 2023 15392 A |
| A 61 K 47/40; A 61 K 47/69; A 61 K 31/5377; A 61 P 35/02 | AP 2023 15618 A |
| C 10 L 1/18; C 10 L 1/00; G 01 N 33/28 | AP 2023 15988 A |
| H 04 R 9/06 | AP 2023 15894 A |

ბანაცხალის გამოქვეყნების ნომრის და საერთაშორისო
კლასიფიკაციის ინდექსის შესაბამისობის ცხრილი

| ბანაცხალის გამოქვეყნების ნომერი (10) | საერთაშორისო კლასიფიკაციის ინდექსი (51) |
|--|--|
| AP 2023 15392 A | A 61 K 39/29; A 61 K 39/295; A 61 P 31/20 |
| AP 2023 15512 A | A 61 K 39/00; A 61 K 39/395; A 61 P 7/02; A 61 P 37/02; C 07 K 16/40 |
| AP 2023 15618 A | A 61 K 47/40; A 61 K 47/69; A 61 K 31/5377; A 61 P 35/02 |
| AP 2023 15894 A | H 04 R 9/06 |
| AP 2023 15908 A | A 61 K 31/4196; A 61 P 35/00; C 07 D 455/02; C 07 D 451/02; C 07 D 471/04; C 07 D 487/04; C 07 D 491/107; C 07 D 403/14; C 07 D 401/14; C 07 D 405/14; C 07 D 413/14; C 07 D 498/04; C 07 D 417/14; C 07 D 498/08 |
| AP 2023 15988 A | C 10 L 1/18; C 10 L 1/00; G 01 N 33/28 |
| AP 2023 16005 A | A 61 K 31/4164; A 61 P 19/02; A 61 P 17/06; A 61 P 11/06; A 61 P 3/10; C 07 D 491/048 |
| AP 2023 16164 A | A 61 K 36/00 |

საერთაშორისო კლასიფიკაციის ინდექსის, პატენტის ნომრისა
და გამომქვეყნების ნომრის შესაბამისობის ცხრილი

| საერთაშორისო კლასიფიკაციის ინდექსი (51) | პატენტის ნომერი (11) | განაცხადის გამომქვეყნების ნომერი (10) |
|---|-------------------------|--|
| A 21 D 13/11; A 21 D 13/41; A 21 D 13/13 | P 2023 7523 B | AP 2023 15661 A |
| A 61 K 31/4439; A 61 K 31/538; A 61 K 31/506; A 61 K 31/498; A 61 P 31/04; C 07 D 401/04; C 07 D 401/14; C 07 D 403/14; C 07 D 413/14 | P 2023 7522 B | AP 2023 15801 A |
| A 61 K 39/395; A 61 P 37/06; A 61 P 29/00; A 61 P 35/00 | P 2023 7528 B | AP 2023 15361 A |
| A 61 K 45/06; A 61 K 31/496; A 61 K 31/195; A 61 P 25/04; A 61 P 25/02 | P 2023 7524 B | AP 2023 15820 A |
| A 61 K 31/472; A 61 P 25/08 | P 2023 7527 B | AP 2023 15508 A |
| B 22 F 3/23; C 22 B 5/04; C 22 C 33/00 | P 2023 7525 B | AP 2023 15606 A |
| G 01 N 21/00 | P 2023 7526 B | AP 2023 15740 A |

პატენტის ნომრის, განაცხადის გამომქვეყნების ნომრისა
და საერთაშორისო კლასიფიკაციის ინდექსის შესაბამისობის ცხრილი

| პატენტის ნომერი (11) | განაცხადის გამომქვეყნების ნომერი (10) | საერთაშორისო კლასიფიკაციის ინდექსი (51) |
|-------------------------|--|---|
| P 2023 7522 B | AP 2023 15801 A | A 61 K 31/4439; A 61 K 31/538; A 61 K 31/506; A 61 K 31/498; A 61 P 31/04; C 07 D 401/04; C 07 D 401/14; C 07 D 403/14; C 07 D 413/14 |
| P 2023 7523 B | AP 2023 15661 A | A 21 D 13/11; A 21 D 13/41; A 21 D 13/13 |
| P 2023 7524 B | AP 2023 15820 A | A 61 K 45/06; A 61 K 31/496; A 61 K 31/195; A 61 P 25/04; A 61 P 25/02 |
| P 2023 7525 B | AP 2023 15606 A | B 22 F 3/23; C 22 B 5/04; C 22 C 33/00 |
| P 2023 7526 B | AP 2023 15740 A | G 01 N 21/00 |
| P 2023 7527 B | AP 2023 15508 A | A 61 K 31/472; A 61 P 25/08 |
| P 2023 7528 B | AP 2023 15361 A | A 61 K 39/395; A 61 P 37/06; A 61 P 29/00; A 61 P 35/00 |

ბანაცხაღის ნომრის, ბანაცხაღის გამომქვეყნების ნომრისა
და პატენტის ნომრის შესაბამისობის ცხრილი

| ბანაცხაღის ნომერი (21) | ბანაცხაღის გამომქვეყნების ნომერი (10) | პატენტის ნომერი (11) |
|---------------------------|---|-------------------------|
| AP 2017 15361 | AP 2023 15361 A | P 2023 7528 B |
| AP 2019 15508 | AP 2023 15508 A | P 2023 7527 B |
| AP 2021 15606 | AP 2023 15606 A | P 2023 7525 B |
| AP 2019 15661 | AP 2023 15661 A | P 2023 7523 B |
| AP 2021 15740 | AP 2023 15740 A | P 2023 7526 B |
| AP 2018 15801 | AP 2023 15801 A | P 2023 7522 B |
| AP 2020 15820 | AP 2023 15820 A | P 2023 7524 B |

ბანაცხაღი***

საერთაშორისო კლასიფიკაციის ინდექსის და ბანაცხაღის
გამომქვეყნების ნომრის შესაბამისობის ცხრილი

| საერთაშორისო კლასიფიკაციის ინდექსი (51) | ბანაცხაღის გამომქვეყნების ნომერი (10) |
|---|---|
| A 61 K 9/20; A 61 K 9/28; A 61 K 9/48; A 61 K 31/00 | AP 2023 16262 A |

ბანაცხაღის გამომქვეყნების ნომრის და საერთაშორისო
კლასიფიკაციის ინდექსის შესაბამისობის ცხრილი

| ბანაცხაღის გამომქვეყნების ნომერი (10) | საერთაშორისო კლასიფიკაციის ინდექსი (51) |
|---|---|
| AP 2023 16262 A | A 61 K 9/20; A 61 K 9/28; A 61 K 9/48; A 61 K 31/00 |

დიზაინები

საერთაშორისო კლასიფიკაციის ინდექსის და ბანაცხაღის
გამოქვეყნების ნომრის შესაბამისობის ცხრილი

| | |
|--|--|
| საერთაშორისო კლასიფიკაციის ინდექსი (51) | ბანაცხაღის გამოქვეყნების ნომერი (10) |
| 14-06 | AD 2023 1304 S |

ბანაცხაღის გამოქვეყნების ნომრის და საერთაშორისო
კლასიფიკაციის ინდექსის შესაბამისობის ცხრილი

| | |
|--|--|
| ბანაცხაღის გამოქვეყნების ნომერი (10) | საერთაშორისო კლასიფიკაციის ინდექსი (51) |
| AD 2023 1304 S | 14-06 |

დაჩქარებული პროცედურით რეგისტრირებული დიზაინი

საერთაშორისო კლასიფიკაციის ინდექსის და რეგისტრაციის ნომრის
შესაბამისობის ცხრილი

| | |
|--|-----------------------------|
| საერთაშორისო კლასიფიკაციის ინდექსი (51) | რეგისტრაციის ნომერი (11) |
| 26-05 | D 2023 975 S |

რეგისტრაციის ნომრის და საერთაშორისო კლასიფიკაციის ინდექსის
შესაბამისობის ცხრილი

| | |
|-----------------------------|---|
| რეგისტრაციის ნომერი (11) | საერთაშორისო კლასიფიკაციის ინდექსი (51) |
| D 2023 975 S | 26-05 |

ბანაცხაღის ნომრის და რეგისტრაციის ნომრის შესაბამისობის ცხრილი

| | |
|---------------------------|-----------------------------|
| ბანაცხაღის ნომერი (21) | რეგისტრაციის ნომერი (11) |
| AD 2023 1314 | D 2023 975 S |

სასაქონლო ნიშნები

რეგისტრაციის ნომრის, ბანაცხაღის ნომრის, ბანაცხაღის გამოქვეყნების ნომრისა და ბიულეტენის ნომრის შესაბამისობის ცხრილი

| რეგისტრაციის ნომერი (111) | ბანაცხაღის ნომერი (210) | ბანაცხაღის გამოქვეყნების ნომერი (260) | ბიულეტენის ნომერი |
|---------------------------|-------------------------|---------------------------------------|-------------------|
| 1 | 2 | 3 | 4 |
| M 2023 37085 R | AM 110965 | AM 2023 110965 A | 5(608)2023 |
| M 2023 37086 R | AM 118158 | AM 2023 118158 A | 3(606)2023 |
| M 2023 37087 R | AM 118540 | AM 2023 118540 A | 6(609)2023 |
| M 2023 37088 R | AM 118470 | AM 2023 118470 A | 2(605)2023 |
| M 2023 37089 R | AM 119208 | AM 2023 119208 A | 6(609)2023 |
| M 2023 37090 R | AM 119210 | AM 2023 119210 A | 6(609)2023 |
| M 2023 37091 R | AM 123516 | - | 15(618)2023 |
| M 2023 37092 R | AM 123515 | - | 15(618)2023 |
| M 2023 37093 R | AM 123191 | - | 15(618)2023 |
| M 2023 37094 R | AM 112293 | - | 15(618)2023 |
| M 2023 37095 R | AM 123581 | - | 15(618)2023 |
| M 2023 37096 R | AM 123584 | - | 15(618)2023 |
| M 2023 37097 R | AM 123611 | - | 15(618)2023 |
| M 2023 37098 R | AM 123654 | - | 15(618)2023 |
| M 2023 37099 R | AM 123615 | - | 15(618)2023 |
| M 2023 37100 R | AM 123868 | - | 15(618)2023 |
| M 2023 37101 R | AM 123599 | - | 15(618)2023 |
| M 2023 37102 R | AM 123613 | - | 15(618)2023 |
| M 2023 37103 R | AM 123914 | - | 15(618)2023 |
| M 2023 37104 R | AM 116620 | AM 2023 116620 A | 2(605)2023 |
| M 2023 37105 R | AM 119015 | AM 2023 119015 A | 6(609)2023 |
| M 2023 37106 R | AM 119016 | AM 2023 119016 A | 6(609)2023 |
| M 2023 37107 R | AM 119014 | AM 2023 119014 A | 6(609)2023 |
| M 2023 37108 R | AM 119017 | AM 2023 119017 A | 6(609)2023 |
| M 2023 37109 R | AM 119113 | AM 2023 119113 A | 5(608)2023 |
| M 2023 37110 R | AM 119110 | AM 2023 119110 A | 5(608)2023 |
| M 2023 37111 R | AM 119018 | AM 2023 119018 A | 6(609)2023 |
| M 2023 37112 R | AM 119193 | AM 2023 119193 A | 7(610)2023 |
| M 2023 37113 R | AM 118723 | AM 2023 118723 A | 5(608)2023 |
| M 2023 37114 R | AM 118410 | AM 2023 118410 A | 7(610)2023 |
| M 2023 37115 R | AM 119004 | AM 2023 119004 A | 6(609)2023 |
| M 2023 37116 R | AM 119348 | AM 2023 119348 A | 7(610)2023 |
| M 2023 37117 R | AM 116619 | AM 2022 116619 A | 18(597)2022 |
| M 2023 37117 R | AM 116619 | AM 2023 116619 A | 4(607)2023 |
| M 2023 37118 R | AM 119212 | AM 2023 119212 A | 7(610)2023 |
| M 2023 37119 R | AM 119492 | AM 2023 119492 A | 7(610)2023 |
| M 2023 37120 R | AM 119185 | AM 2023 119185 A | 7(610)2023 |
| M 2023 37121 R | AM 119196 | AM 2023 119196 A | 7(610)2023 |
| M 2023 37122 R | AM 119283 | AM 2023 119283 A | 7(610)2023 |

| 1 | 2 | 3 | 4 |
|----------------|-----------|------------------|-------------|
| M 2023 37123 R | AM 119351 | AM 2023 119351 A | 7(610)2023 |
| M 2023 37124 R | AM 119352 | AM 2023 119352 A | 7(610)2023 |
| M 2023 37125 R | AM 119489 | AM 2023 119489 A | 7(610)2023 |
| M 2023 37126 R | AM 119493 | AM 2023 119493 A | 7(610)2023 |
| M 2023 37127 R | AM 119496 | AM 2023 119496 A | 8(611)2023 |
| M 2023 37128 R | AM 119596 | AM 2023 119596 A | 7(610)2023 |
| M 2023 37129 R | AM 119616 | AM 2023 119616 A | 8(611)2023 |
| M 2023 37130 R | AM 119617 | AM 2023 119617 A | 8(611)2023 |
| M 2023 37131 R | AM 119791 | AM 2023 119791 A | 8(611)2023 |
| M 2023 37132 R | AM 103095 | AM 2023 103095 A | 7(610)2023 |
| M 2023 37133 R | AM 117558 | AM 2023 117558 A | 7(610)2023 |
| M 2023 37134 R | AM 118077 | AM 2023 118077 A | 7(610)2023 |
| M 2023 37135 R | AM 118294 | AM 2023 118294 A | 2(605)2023 |
| M 2023 37136 R | AM 118406 | AM 2023 118406 A | 2(605)2023 |
| M 2023 37137 R | AM 118407 | AM 2023 118407 A | 4(607)2023 |
| M 2023 37138 R | AM 118539 | AM 2023 118539 A | 2(605)2023 |
| M 2023 37139 R | AM 118559 | AM 2023 118559 A | 3(606)2023 |
| M 2023 37140 R | AM 118651 | AM 2023 118651 A | 7(610)2023 |
| M 2023 37141 R | AM 118652 | AM 2023 118652 A | 7(610)2023 |
| M 2023 37142 R | AM 118661 | AM 2023 118661 A | 5(608)2023 |
| M 2023 37143 R | AM 118662 | AM 2023 118662 A | 5(608)2023 |
| M 2023 37144 R | AM 118932 | AM 2023 118932 A | 5(608)2023 |
| M 2023 37145 R | AM 119345 | AM 2023 119345 A | 7(610)2023 |
| M 2023 37146 R | AM 119003 | AM 2023 119003 A | 7(610)2023 |
| M 2023 37147 R | AM 119581 | AM 2023 119581 A | 7(610)2023 |
| M 2023 37148 R | AM 118851 | AM 2023 118851 A | 5(608)2023 |
| M 2023 37150 R | AM 118996 | AM 2023 118996 A | 7(610)2023 |
| M 2023 37151 R | AM 118997 | AM 2023 118997 A | 7(610)2023 |
| M 2023 37152 R | AM 118998 | AM 2023 118998 A | 7(610)2023 |
| M 2023 37153 R | AM 118999 | AM 2023 118999 A | 7(610)2023 |
| M 2023 37154 R | AM 118993 | AM 2023 118993 A | 7(610)2023 |
| M 2023 37155 R | AM 123514 | - | 15(618)2023 |
| M 2023 37156 R | AM 117550 | AM 2023 117550 A | 6(609)2023 |
| M 2023 37157 R | AM 118934 | AM 2023 118934 A | 5(608)2023 |
| M 2023 37158 R | AM 116069 | AM 2022 116069 A | 15(594)2022 |
| M 2023 37158 R | AM 116069 | AM 2023 116069 A | 5(608)2023 |
| M 2023 37159 R | AM 119008 | AM 2023 119008 A | 7(610)2023 |
| M 2023 37160 R | AM 119009 | AM 2023 119009 A | 7(610)2023 |
| M 2023 37161 R | AM 119077 | AM 2023 119077 A | 7(610)2023 |
| M 2023 37162 R | AM 119768 | AM 2023 119768 A | 8(611)2023 |
| M 2023 37163 R | AM 119104 | AM 2023 119104 A | 8(611)2023 |
| M 2023 37164 R | AM 124020 | - | 15(618)2023 |
| M 2023 37165 R | AM 124064 | - | 15(618)2023 |
| M 2023 37166 R | AM 124065 | - | 15(618)2023 |
| M 2023 37167 R | AM 124066 | - | 15(618)2023 |
| M 2023 37168 R | AM 124124 | - | 15(618)2023 |
| M 2023 37169 R | AM 124019 | - | 15(618)2023 |
| M 2023 37170 R | AM 124053 | - | 15(618)2023 |
| M 2023 37171 R | AM 124060 | - | 15(618)2023 |

| 1 | 2 | 3 | 4 |
|----------------|-----------|---|-------------|
| M 2023 37172 R | AM 124059 | - | 15(618)2023 |
| M 2023 37173 R | AM 124062 | - | 15(618)2023 |
| M 2023 37174 R | AM 123928 | - | 15(618)2023 |
| M 2023 37175 R | AM 123927 | - | 15(618)2023 |
| M 2023 37176 R | AM 123926 | - | 15(618)2023 |
| M 2023 37177 R | AM 123925 | - | 15(618)2023 |
| M 2023 37178 R | AM 123924 | - | 15(618)2023 |

ბანაცხადის გამოქვეყნების ნომრისა და ბანაცხადის ნომრის
შესაბამისობის ცხრილი

| ბანაცხადის გამოქვეყნების ნომერი (260) | ბანაცხადის ნომერი (210) | 1 | 2 |
|--|-------------------------------|------------------|-----------|
| 1 | 2 | AM 2023 121123 A | AM 121123 |
| AM 2023 110203 A* | AM 110203 | AM 2023 121127 A | AM 121127 |
| AM 2023 110204 A* | AM 110204 | AM 2023 121132 A | AM 121132 |
| AM 2023 114671 A* | AM 114671 | AM 2023 121133 A | AM 121133 |
| AM 2023 119787 A | AM 119787 | AM 2023 121134 A | AM 121134 |
| AM 2023 119991 A | AM 119991 | AM 2023 121135 A | AM 121135 |
| AM 2023 119994 A | AM 119994 | AM 2023 121136 A | AM 121136 |
| AM 2023 120514 A | AM 120514 | AM 2023 121137 A | AM 121137 |
| AM 2023 120699 A | AM 120699 | AM 2023 121138 A | AM 121138 |
| AM 2023 120701 A | AM 120701 | AM 2023 121139 A | AM 121139 |
| AM 2023 120707 A | AM 120707 | AM 2023 121212 A | AM 121212 |
| AM 2023 120711 A | AM 120711 | AM 2023 121216 A | AM 121216 |
| AM 2023 120815 A | AM 120815 | AM 2023 121245 A | AM 121245 |
| AM 2023 120816 A | AM 120816 | AM 2023 121246 A | AM 121246 |
| AM 2023 120824 A | AM 120824 | AM 2023 121247 A | AM 121247 |
| AM 2023 120840 A | AM 120840 | AM 2023 121301 A | AM 121301 |
| AM 2023 120844 A | AM 120844 | AM 2023 121303 A | AM 121303 |
| AM 2023 120849 A | AM 120849 | AM 2023 121304 A | AM 121304 |
| AM 2023 120850 A | AM 120850 | AM 2023 121305 A | AM 121305 |
| AM 2023 120851 A | AM 120851 | AM 2023 121324 A | AM 121324 |
| AM 2023 120852 A | AM 120852 | AM 2023 121325 A | AM 121325 |
| AM 2023 120854 A | AM 120854 | AM 2023 121326 A | AM 121326 |
| AM 2023 120856 A | AM 120856 | AM 2023 121327 A | AM 121327 |
| AM 2023 120938 A | AM 120938 | AM 2023 121328 A | AM 121328 |
| AM 2023 120948 A | AM 120948 | AM 2023 121329 A | AM 121329 |
| AM 2023 120955 A | AM 120955 | AM 2023 121330 A | AM 121330 |
| AM 2023 120956 A | AM 120956 | AM 2023 121331 A | AM 121331 |
| AM 2023 121051 A | AM 121051 | AM 2023 121332 A | AM 121332 |
| | | AM 2023 121333 A | AM 121333 |
| | | AM 2023 121334 A | AM 121334 |
| | | AM 2023 121335 A | AM 121335 |
| | | AM 2023 121352 A | AM 121352 |

ბანაცხადის გამომქვეყნების ნომრის საძიებელი საქონლისა
ღა/ან მომსახურების კლასის მიხედვით

| საქონლისა ღა/ან მომსახურების კლასი (511) | ბანაცხადის გამომქვეყნების ნომერი (260) | 1 | 2 |
|---|---|----|-------------------|
| 1 | 2 | 25 | AM 2023 121328 A |
| 1 | AM 2023 121333 A | 25 | AM 2023 121329 A |
| 2 | AM 2023 121246 A | 27 | AM 2023 121133 A |
| 2 | AM 2023 121247 A | 28 | AM 2023 121133 A |
| 3 | AM 2023 120840 A | 28 | AM 2023 121245 A |
| 3 | AM 2023 121304 A | 28 | AM 2023 121328 A |
| 3 | AM 2023 121324 A | 28 | AM 2023 121329 A |
| 4 | AM 2023 120955 A | 29 | AM 2023 120824 A |
| 4 | AM 2023 120956 A | 29 | AM 2023 121133 A |
| 5 | AM 2023 121133 A | 29 | AM 2023 121139 A |
| 5 | AM 2023 121137 A | 29 | AM 2023 121212 A |
| 5 | AM 2023 121138 A | 30 | AM 2023 110203 A* |
| 5 | AM 2023 121333 A | 30 | AM 2023 110204 A* |
| 5 | AM 2023 121352 A | 30 | AM 2023 120707 A |
| 7 | AM 2023 121132 A | 30 | AM 2023 120824 A |
| 8 | AM 2023 121245 A | 30 | AM 2023 121133 A |
| 9 | AM 2023 120816 A | 30 | AM 2023 121212 A |
| 9 | AM 2023 121132 A | 31 | AM 2023 121139 A |
| 9 | AM 2023 121133 A | 32 | AM 2023 110203 A* |
| 12 | AM 2023 121132 A | 32 | AM 2023 110204 A* |
| 12 | AM 2023 121216 A | 32 | AM 2023 120938 A |
| 14 | AM 2023 114671 A* | 32 | AM 2023 121133 A |
| 14 | AM 2023 120711 A | 32 | AM 2023 121134 A |
| 16 | AM 2023 121133 A | 32 | AM 2023 121135 A |
| 16 | AM 2023 121324 A | 32 | AM 2023 121136 A |
| 16 | AM 2023 121328 A | 33 | AM 2023 120699 A |
| 16 | AM 2023 121329 A | 33 | AM 2023 121303 A |
| 16 | AM 2023 121334 A | 34 | AM 2023 120815 A |
| 16 | AM 2023 121335 A | 34 | AM 2023 120849 A |
| 17 | AM 2023 121324 A | 34 | AM 2023 120850 A |
| 20 | AM 2023 121245 A | 34 | AM 2023 120851 A |
| 21 | AM 2023 120514 A | 34 | AM 2023 120852 A |
| 21 | AM 2023 121133 A | 34 | AM 2023 120854 A |
| 21 | AM 2023 121328 A | 34 | AM 2023 120856 A |
| 21 | AM 2023 121329 A | 34 | AM 2023 121305 A |
| 22 | AM 2023 121245 A | 35 | AM 2023 114671 A* |
| 24 | AM 2023 121133 A | 35 | AM 2023 119994 A |
| 24 | AM 2023 121328 A | 35 | AM 2023 120711 A |
| 24 | AM 2023 121329 A | 35 | AM 2023 120816 A |
| 25 | AM 2023 121123 A | 35 | AM 2023 120824 A |
| 25 | AM 2023 121133 A | 35 | AM 2023 120955 A |
| | | 35 | AM 2023 120956 A |
| | | 35 | AM 2023 121127 A |
| | | 35 | AM 2023 121133 A |
| | | 35 | AM 2023 121134 A |
| | | 35 | AM 2023 121135 A |

| 1 | 2 |
|----|------------------|
| 35 | AM 2023 121136 A |
| 35 | AM 2023 121139 A |
| 35 | AM 2023 121245 A |
| 35 | AM 2023 121301 A |
| 35 | AM 2023 121326 A |
| 35 | AM 2023 121327 A |
| 35 | AM 2023 121328 A |
| 35 | AM 2023 121329 A |
| 36 | AM 2023 120701 A |
| 37 | AM 2023 120701 A |
| 41 | AM 2023 119787 A |
| 41 | AM 2023 120816 A |
| 41 | AM 2023 120844 A |
| 41 | AM 2023 121051 A |
| 41 | AM 2023 121133 A |

| 1 | 2 |
|----|------------------|
| 42 | AM 2023 120816 A |
| 43 | AM 2023 119991 A |
| 43 | AM 2023 120711 A |
| 43 | AM 2023 120824 A |
| 43 | AM 2023 120948 A |
| 43 | AM 2023 121127 A |
| 43 | AM 2023 121325 A |
| 43 | AM 2023 121326 A |
| 43 | AM 2023 121327 A |
| 43 | AM 2023 121328 A |
| 43 | AM 2023 121329 A |
| 43 | AM 2023 121330 A |
| 43 | AM 2023 121331 A |
| 43 | AM 2023 121332 A |

დაჩქარებული პროცედურით რეგისტრირებული სასაქონლო ნიშნის ნომრის
საბიუჯეტო საქონლისა და/ან მომსახურების კლასის მიხედვით

| საქონლისა და/ან მომსახურების კლასი (511) | დაჩქარებული პროცედურით რეგისტრირებული სასაქონლო ნიშნის ნომერი (111) |
|--|---|
| 1 | 2 |
| 3 | M 2023 37094 R |
| 4 | M 2023 37097 R |
| 5 | M 2023 37093 R |
| 5 | M 2023 37171 R |
| 5 | M 2023 37172 R |
| 8 | M 2023 37091 R |
| 10 | M 2023 37103 R |
| 25 | M 2023 37169 R |
| 29 | M 2023 37093 R |
| 29 | M 2023 37099 R |
| 29 | M 2023 37102 R |
| 30 | M 2023 37093 R |
| 32 | M 2023 37093 R |
| 32 | M 2023 37101 R |
| 32 | M 2023 37155 R |
| 33 | M 2023 37173 R |
| 34 | M 2023 37164 R |
| 34 | M 2023 37165 R |
| 34 | M 2023 37166 R |
| 34 | M 2023 37167 R |
| 34 | M 2023 37170 R |
| 35 | M 2023 37095 R |
| 35 | M 2023 37174 R |

| 1 | 2 |
|----|----------------|
| 35 | M 2023 37175 R |
| 35 | M 2023 37176 R |
| 35 | M 2023 37177 R |
| 35 | M 2023 37178 R |
| 36 | M 2023 37092 R |
| 36 | M 2023 37100 R |
| 37 | M 2023 37100 R |
| 38 | M 2023 37092 R |
| 39 | M 2023 37095 R |
| 39 | M 2023 37098 R |
| 41 | M 2023 37092 R |
| 41 | M 2023 37174 R |
| 41 | M 2023 37175 R |
| 41 | M 2023 37176 R |
| 41 | M 2023 37177 R |
| 41 | M 2023 37178 R |
| 42 | M 2023 37092 R |
| 43 | M 2023 37096 R |
| 43 | M 2023 37100 R |
| 43 | M 2023 37168 R |
| 44 | M 2023 37103 R |
| 45 | M 2023 37092 R |

სამრეწველო საკუთრების
ოფიციალური ბიულეტენი

15(618)

გამომცემი

დიზაინი

სასაქონლო ნიშნები

საქონლის აღბილწარმოების დასახელებები

მთავარი რედაქტორი: ნ. ბებრიშვილი

კორექტორი: ლ. ჭანტურია

დამკაზადონებლები: მ. ორდენიძე

ქ. სვანიძე

პოლიგრაფიული ჯგუფი: მ. მეჩტიშვილი

ი. გოგოლაშვილი

ლ. დოლიძე

ISSN 2720-8478

ხელმოწერილია გამოსაცემად 2023 07 07

ტირაჟი 10

შეკვეთა №15

ბიულეტენის ელექტრონული ვერსიის გაცნობა შესაძლებელია საქპატენტის ვებგვერდზე

სათავო ოფისი: 3300 ქ. მცხეთა, ანტიოქიის ქ. №5; ფაქსი: (+995 32) 2252531

0179 ქ. თბილისი, ნინო რამიშვილის ქ. №31; ტელ.: (+995 32) 2252531

info@sakpatenti.gov.ge

www.sakpatenti.gov.ge