



**NATIONAL INTELLECTUAL PROPERTY CENTER OF GEORGIA
SAKPATENTI**

**OFFICIAL BULLETIN
OF THE INDUSTRIAL PROPERTY**

18(430)

**2015
TBILISI**

INID CODES FOR IDENTIFICATION OF BIBLIOGRAPHIC DATA

INVENTIONS, UTILITY MODELS

- (10) Number of publication for application, which has been examined
- (11) Number of patent and kind of document
- (21) Serial number of application
- (22) Date of filing of the application
- (23) Date of exhibition or the date of the earlier filing and the number of application, if any
- (24) Date from which patent may have effect
- (31) Number of priority application
- (32) Date of filing of priority application
- (33) Code of the country or regional organization allotting priority application number
- (44) Date of publication of application not granted, but examined and number of bulletin
- (45) Date of publication of registered document
- (51) International Patent Classification Index
- (54) Title of the invention
- (57) Abstract
- (60) Number of examined patent document granted by foreign patent office, date from which patent has effect and country code
- (62) Number of the earlier application and in case of divided application, date of filing an application
- (71) Name, surname and address of applicant (country code)
- (72) Name, surname of inventor (country code)
- (73) Name, surname and address of patent owner (country code)
- (74) Name, surname of representative or patent attorney
- (85) Date of commencement of the national phase of International Application
- (86) Number and date of filing of international application
- (87) Number and date of publication of international application

DESIGNS

- (10) Number of publication for application
- (11) Number of patent and kind of document or number of registration
- (15) Date of registration/Date of patent renewal
- (18) Expected expiration date of patent or registration
- (21) Serial number of application
- (22) Date of filing of the application
- (23) Date of exhibition or the date of the earlier filing and the number of application, if any
- (24) Date from which patent may have effect
- (28) Number of designs included in the application
- (30) Data relating to priority (number of application, date of filing of application, two-letter code identifying the authority with whom the priority application was made)
- (31) Number of priority application
- (32) Date of filing of priority application
- (33) Code of the country or regional organization allotting priority application number
- (34) Two-letter code according to WIPO St.3 identifying the authority with which the priority application was made
- (44) Date of publication of design and number of bulletin (the first publication)
- (45) Date of publication of design registered by WIPO and number of bulletin
- (51) International Classification for designs (class and subclass of the Locarno Classification)
- (54) Title of the invention
- (55) Reproduction of the design
- (57) Description of characteristic features of the design including indication of colors
- (58) Date of recording of any kind of amendment in the Register
- (62) Number of the earlier application, registration and document number and if available the date of filing an application in case of divided application
- (71) Name, surname and address of applicant (country code)
- (72) Name, surname of creator (country code)
- (73) Name, surname and address of patent owner (country code)
- (74) Name, surname of representative or patent attorney
- (81) Contracting states concerned
 - II designated contracting states according to the 1960 Act
 - III designated contracting states according to the 1999 Act
- (85) Owner's permanent address
- (86) Owner's nationality
- (87) Owner's residence
- (88) State in which the owner has a real and effective industrial or commercial establishment

TRADEMARKS

- (111) - Number of registration
- (151) - Date of registration
- (156) - Date of the renewal
- (181) - Expected expiration date of registration
- (186) - Renewal expiration date of registration
- (141) - Date of cancel of duration of the mark
- (210) - Serial number of application
- (220) - Date of filing of the application
- (230) - Date concerning exhibition
- (260) - Number of application, for which favorable decision of examination about registration has been taken (publication number)
- (310) - Number of the first application
- (320) - Date of filing of the first application
- (330) - Code, identifying national or regional Office where the first application was made
- (511) - International Classification of Goods and Services for the purposes of registration of trade marks and/or list of goods and/or services classified according thereto
- (531) - Description of figurative elements of Trade Marks according to the International Classification of the Figurative Elements of Marks
- (540) - Reproduction of Trade Mark
- (550) - Nature and kind of Trade Mark
- (580) - Date of recording of any kind changes in respect of applications or registrations
- (591) - Information concerning colors claimed
- (731) - Name and address of the applicant
- (732) - Name and address of the holder of the registration
- (740) - Name and address of the representative
- (750) - Address for correspondence
- (770) - Name and address of the previous applicant or holder in case of change in ownership
- (771) - Previous name and address of the applicant or holder in case of change in ownership
- (791) - Name and address of the licensee
- (793) - Indication of conditions and/or restrictions under the license (Type of license, number of license agreement, data of license, data of validity of license)
- (800) - Certain data relating to the international registration of Trade Marks under the Protocol Relating to Madrid Agreement (International registration number)

CODES FOR PUBLICATION IN BULLETIN

- (21) AP 0000 000000 - serial number of application for invention
- (10) AP 0000 0000 A - number of published application for invention (first publication)
- (11) P 0000 0000 B - number of patent for invention (second publication)
- (21) API 0000 000000 - number of application for imported patent
- (11) PI 0000 0000 A - number of imported patent (first publication)
- (21) AU 0000 000000 - serial number of application for utility model
- (10) AU 0000 000 U - number of published application for utility model (first publication)
- (11) U 0000 000 Y - number of patent for utility model (second publication)
- (21) AD 0000 000000 - serial number of application for design
- (10) AD 0000 000 S - number of published application for design (first publication)
- (11) D 0000 000 S - number of patent for design (second publication)

INTERNATIONAL PATENT CLASSIFICATION FOR INVENTIONS AND UTILITY MODELS

- SECTION A - HUMAN NECESSITIES
- SECTION B - PERFORMING OPERATIONS; TRANSPORTING
- SECTION C - CHEMISTRY; METALLURGY
- SECTION D - TEXTILES; PAPER
- SECTION E - FIXED CONSTRUCTIONS
- SECTION F - MECHANICAL ENGINEERING; LIGHTING; HEATING; WEAPONS; BLASTING
- SECTION G - PHYSICS
- SECTION H - ELECTRICITY

-
- M - Trade Mark
 - (210) AM 0000 000000 - Serial number of application;
 - (260) AAM 0000 00000 A - Publication number of application;
 - (111) M 0000 00000 R - Number of registration;
 - (111) MMM0000 00000 Rn - Number of renewals, in which n=1,2,3;
 - (111) M 0000 00000 R(P) - Number of registration under partial assignment of rights
-

**NATIONAL INTELLECTUAL PROPERTY CENTER OF GEORGIA
SAKPATENTI**

**OFFICIAL BULLETIN
OF THE INDUSTRIAL PROPERTY**

18(430)

**INVENTIONS
UTILITY MODELS
DESIGNS
TRADEMARKS**

DATE OF PUBLICATION

2015 09 25

CONTENTS

PUBLISHED TITLES OF PROTECTION	3
INVENTIONS	
▪ APPLICATIONS APPROVED FOR GRANTING PATENTS	4
▪ PATENTED INVENTIONS	8
UTILITY MODELS	
▪ PATENTED UTILITY MODELS	11
DESIGNS	
▪ DESIGNS REGISTERED ACCORDING TO THE ACCELERATED PROCEDURE	12
TRADEMARKS	
▪ APPLICATIONS FILED UNDER THE NATIONAL PROCEDURE APPROVED FOR REGISTRATION	16
▪ REGISTERED TRADEMARKS	21
▪ TRADEMARKS REGISTERED ACCORDING TO THE ACCELERATED PROCEDURE	24
▪ INTERNATIONAL TRADEMARKS FOR WHICH A DECISION ON GANTING PROTECTION IS TAKEN	27
▪ INTERNATIONAL TRADEMARKS PROTECTED IN GEORGIA	63
OFFICIAL NOTIFICATIONS	
TRADEMARKS	
▪ RENEWAL OF REGISTRATIONS	65
▪ COMPLETE TRANSFER OF RIGHTS	67
▪ CHANGES IN NAMES AND/OR ADDRESSES OF OWNERS	70
CLASSIFICATION INDEXES	
INVENTIONS	74
UTILITY MODELS	76
DESIGNS	77
TRADEMARKS	78

PUBLISHED TITLES OF PROTECTION

INVENTIONS

- **APPLICATIONS APPROVED FOR GRANTING PATENTS:**
12570; 12631; 12614; 12630; 13162; 13210; 13701, 13702
- **PATENTED INVENTIONS:**
6366-6373

UTILITY MODELS

- **PATENTED UTILITY MODELS:**
1870-1873

DESIGNS

- **DESIGNS REGISTERED ACCORDING TO THE ACCELERATED PROCEDURE:**
645-647

TRADEMARKS

- **APPLICATIONS FILED UNDER THE NATIONAL PROCEDURE APPROVED FOR REGISTRATION:**
77262; 77725; 77857, 77858; 79327; 79476; 79578; 79584; 79588; 79590; 79796; 79842; 79844; 79955; 80446; 80464; 80481-80483; 80910, 80911; 80986, 80987; 80989; 80991, 80992; 81003
- **REGISTERED TRADEMARKS:**
26251-26275; 26277, 26278
- **TRADEMARKS REGISTERED ACCORDING TO THE ACCELERATED PROCEDURE:**
26250; 26276; 26279-26291
- **INTERNATIONAL TRADEMARKS FOR WHICH A DECISION ON GRANTING PROTECTIONS IS TAKEN:**
77202*; 78680; 78806; 78835; 78939; 78959-78968; 78971; 78973; 78977-78979; 79203-79208; 79210, 79211; 79213-79216; 79218, 79219; 79225; 79256, 79257; 79260-79264; 79266; 79269-79272; 79274, 79275; 79277, 79278; 79280; 79385; 79392; 79419-79423; 79425-79430; 79433-79436; 79441, 79442; 79456, 79457; 79683; 79691; 79696; 79705; 79770, 79771; 79774; 79779; 79878; 79881, 79882; 80046-80048; 80050; 80052; 80054; 80057-80059; 80061; 80180, 80181; 80285; 80438; 80439
- **INTERNATIONAL TRADEMARKS PROTECTED IN GEORGIA:**
78181; 78186; 78188; 78437-78442; 78444-78448; 78632, 78633; 78657; 78682; 78684, 78685; 78687, 78688; 78905; 78907; 78913; 78920

INVENTIONS

APPLICATIONS APPROVED FOR GRANTING PATENTS

The decision can be appealed at the Chamber of Appeal of Sakpatenti within 3 months from the publication or at the Mtskheta District Court Administrative Cases Board (Address: №17, Samkhedro str., Mtskheta), within 1 month following the publication.

PART A

A 01

(10) AP 2015 12570 A (51) Int. Cl. (2006)

A 01 N 43/42

A 61 K 31/44

(21) AP 2010 012570 (22) 2010 04 30

(31) 61/225,202; 61/341,476; 61/341,721;
12/771,076

(32) 2009 07 13; 2010 03 30; 2010 04 01;
2010 04 30

(33) US; US; US; US

(71) MEDICIS PHARMACEUTICAL
CORPORATION (US)

7720 North Dobson Road, Scottsdale,
AZ 85256 (US)

(72) NORDSIEK, Michael T. (US);

LEVY, Sharon F. (US);

LEE, James H. (US);

KULP, James H. (US);

BALAJI, Kodumudi S. (US);

MENG, Tze-Chiang (US);

WU, Jason J. (US);

BAHM, Valyn S. (US);

BABILON, Robert (US)

(74) Shalva Gvaramadze

(85) 2012 02 10

(86) PCT/US2010/033245, 2010 04 30

(54) **LOWER DOSAGE STRENGTH
IMIQUIMOD FORMULATIONS AND
SHORT DOSING REGIMENS FOR
TREATING GENITAL AND PERIANAL
WARTS**

(57) An invention relates to imiquimod (1 isobuty 1-1 H-imidazo[4,5-c]-quinolin-4-amine or 1-(2-methyl-propyl)-1H-imidazo[4,5-c]quinolin-4-arnme) low dosage application at the treatment of genital or perianal warts, when supplement with effective amount of imiquimod in treating part of body is carried out locally or transdermal.

Claims: 3 independent

16 dependent

Fig.: 39

A 43

(10) AP 2015 12631 A (51) Int. Cl. (2006)

A 43 B 7/06

A 43 B 7/12

(21) AP 2010 012631 (22) 2010 08 04

(31) 09425334.1

(32) 2009 08 28

(33) EP

(71) GEOX S.P.A. (IT)

Via Feltrina Centro, 16 I-31044

MONTEBELLUNA, Località Biadene - (Treviso)
(IT)

(72) POLEGATO MORETTI, Mario (IT)

(74) Aleksandre Gegechkori

(85) 2012 03 19

(86) PCT/EP2010/061352, 2010 08 04

(54) **INSERT FOR VAPOR-PERMEABLE
AND WATERPROOF SOLES**

(57) An insert for vapor-permeable and waterproof soles has stratified and cohesive monolithic sheet-like structure, which comprises plurality of functional layers (11) made of polymeric material that is impermeable to water in the liquid state and permeable to water vapor. At least one functional portion of insert for soles has such a thickness as to give it penetration resistance of more than approximately 10 N, assessed according to the method presented in chapter 5.8.2 of ISO 20344-2004 standard.

Claims: 2 independent

26 dependent

Fig.: 13

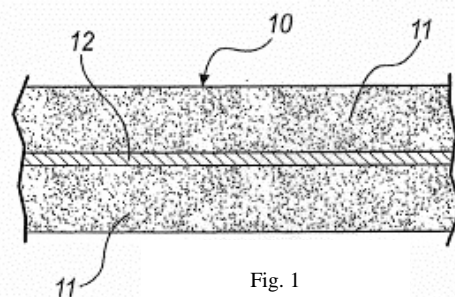

Fig. 1

(10) AP 2015 12614 A **(51) Int. Cl. (2006)****A 43 B 7/06****A 43 B 7/12**

(21) AP 2010 012614 (22) 2010 08 04

(31) 09425335.8

(32) 2009 08 28

(33) EP

(71) GEOX S.P.A. (IT)

Via Feltrina Centro, 16 I-31044

MONTEBELLUNA, Località Biadene

(Treviso) (IT)

(72) POLEGATO MORETTI, Mario (IT)

(74) Aleksandre Gegechkori

(85) 2012 03 06

(86) PCT/EP2010/061345, 2010 08 04

(54) VAPOR-PERMEABLE SHOE

(57) Vapor-permeable shoe comprises upper assembly (11) that wraps around the foot insertion region (A) and is associated, in its plantar region, with a sole (12) that has at least one vapor-permeable or perforated portion (13). Upper assembly (11) comprises structural insert (14) that has at least one waterproof portion that is sealed impermeably to the sole (12) covering its vapor-permeable or perforated portion (13) so as to prevent infiltration of liquid, through it, toward the foot insertion region (A). Waterproof portion being composed at least partly of waterproof and vapor-permeable functional element that has monolithic sheet-like structure made of polymeric material that is impermeable to water in the liquid state and is permeable to water vapor, at least one functional portion of functional element having such thickness as to give it penetration resistance that is greater than approximately 10 N, assessed according to the method presented in chapter 5.8.2 of ISO 20344-2004 standard.

Claims: 1 independent

30 dependent

Fig.: 14

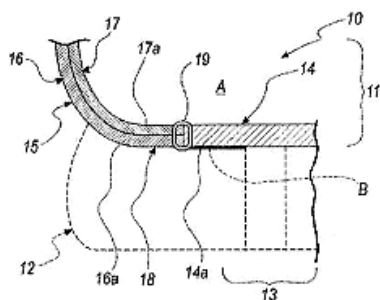

Fig. 1

(10) AP 2015 12630 A **(51) Int. Cl. (2006)****A 43 B 7/12****A 43 B 7/06**

(21) AP 2010 012630 (22) 2010 08 04

(31) 09425336.6

(32) 2009 08 28

(33) EP

(71) GEOX S.P.A. (IT)

Via Feltrina Centro, 16 I-31044

MONTEBELLUNA, Località Biadene - (Treviso) (IT)

(72) POLEGATO MORETTI, Mario (IT)

(74) Aleksandre Gegechkori

(85) 2012 03 19

(86) PCT/EP2010/061355, 2010 08 04

(54) INSERT FOR VAPOR-PERMEABLE AND WATERPROOF SOLES

(57) An insert for vapor-permeable and waterproof soles, which has a monolithic sheet-like structure, made of polymeric material that is impermeable to water in the liquid state and permeable to water vapor. At least one functional portion of insert for soles has such thickness as to give it penetration resistance of more than approximately 10 N, assessed according to the method presented in chapter 5.8.2 of ISO 20344-2004 standard.

Claims: 2 independent

22 dependent

Fig.: 12

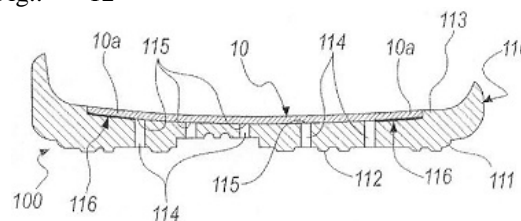

Fig. 1

A 61**(10) AP 2015 13162 A** **(51) Int. Cl. (2006)****A 61 K 31/55****A 61 P 9/04****C 07 C 209/88****C 07 C 217/74****C 07 D 223/16****C 12 P 17/10**

(21) AP 2013 013162 (22) 2013 07 15

(31) 12.56913

(32) 2012 07 17

(33) FR

(71) LES LABORATOIRES SERVIER (FR)

35, rue de Verdun, 92284 Suresnes Cedex (FR)

(72) PEDRAGOSA MOREAU, Sandrine (FR);

LEFOULON, François (FR);

MORIS VARAS, Francisco (ES);

MORIS VARAS, Javier (ES)

(74) Tamaz Shilakadze

(54) METHOD FOR ENZYMATIC SYNTHESIS OF (7S)-1-(3,4-DIMETHOXYBICYCLO [4.2.0]OCTA-1,3,5-TRIENE-7-YL)N-METHYL METHANAMINE AND APPLICATION THEREIN IVABRADINE SYNTHESIS

(57) A method for synthesis of compound of formula (IX),

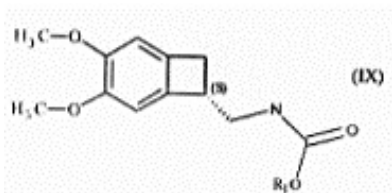

which value R^1 is provided in the claims and, which is executed with enantioselective enzymatic acylation of racemic amine of formula (IV) with $R^1O-(CO)-OR^1$ carbonate by application of lipase dissolved in organic or water solvent or in their mix, at 25-40 °C temperature. Reduction of received compound of formula (IX) is executed by application of restorative agent: $LiAlH_4$ or Red-Al, to produce compound of formula (I)

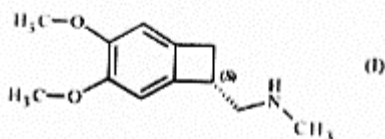

applicable at ivabradine synthesis.

Claims: 3 independent

8 dependent

Table: 5

PART C

C 07

(10) AP 2015 13210 A (51) Int. Cl. (2006)
C 07 D 239/70
C 07 D 403/12
A 61 K 31/517
A 61 P 11/00

(21) AP 2012 013210 (22) 2012 01 27

(31) 11152895.6

(32) 2011 02 01

(33) EP

(71) BOEHRINGER INGELHEIM
INTERNATIONAL GMBH (DE)
Binger Strasse 173, 55216 Ingelheim
Am Rhein (DE)

(72) OSTERMEIER, Markus (DE);
PFRENGLE, Waldemar (DE);
HUCHLER, Guenther (DE);
SIEGER, Peter (DE)

(74) Tamar Kochlamazashvili

(85) 2013 08 30

(86) PCT/EP2012/051298, 2012 01 27

(54) **9-[4-(3-CHLOR-2-FLUOR-PHENYLAMINO)-7-METHOXY-QUINAZOLIN-6-YLOXY]-1,4-DIAZASPIRO[5.5]UNDECAN-5-ONE DIMALEATE, USAGE THEREAS DRUG, AND PRODUCTION THEREOF**

(57) Compound of formula (I),

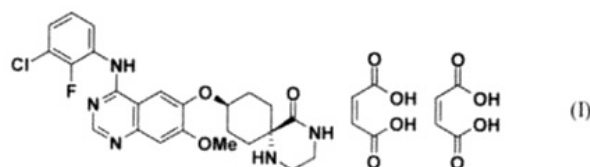

method for their production, pharmaceutical composition on a basis thereof, and its application as drug.

Claims: 11 independent

5 dependent

Table: 1

Fig.: 5

PART G

G 02

(10) AP 2015 13701 A (51) Int. Cl. (2006)

G 02 B 5/08

G 02 B 5/28

H 01 S 3/08

H 01 S 5/00

(21) AP 2015 013701 (22) 2015 01 22

(71) LEPL ILIA VEKUA SUKHUMI INSTITUTE
OF PHYSICS AND TECHNOLOGY (GE)
MIndeli Str.7, 0186, Tbilisi (GE)

(72) Guram Bokuchava (GE);
Zurab Vardosanidze (GE);
Vladimer Kuchukhidze (GE);
Davit Berishvili (GE)

(54) **MULTILAYER DIELECTRIC INTERFERENCE LASER MIRROR**

(57) There is represented multilayer dielectric interference laser mirror including two different thickness optically transparent fourth wave ($\lambda/4$) dielectric layers of high and low refractive indices spread in turn on transparent flat-parallel, flat-concave base layer having glass or quartz or other optical surfaces. At that, dielectric layers are produced with photorefraction and/or electrooptic and/or magneto-optical material and are executed with reflection control ability.

Claims: 1 independent

Fig.: 1

PART H

H 01

(10) AP 2015 13702 A (51) Int. Cl. (2006)

H 01 S 3/10

H 01 S 3/11

(21) AP 2015 013702 (22) 2015 01 22

(71) LEPL ILIA VEKUA SUKHUMI INSTITUTE
OF PHYSICS AND TECHNOLOGY (GE)
MIndeli Str.7, 0186, Tbilisi (GE)

(72) Guram Bokuchava (GE);
Zurab Vardosanidze (GE);
Vladimer Kuchukhidze (GE);
Anzor Inalishvili (GE)

(54) **METHOD AND EQUIPMENT FOR
RECEIVING GIANT LASER IMPULSES**

(57) There are represented a method and an equipment for receiving giant laser impulses. The method provides laser resonator validity modulation so, that reflection ability reduction of one of multilayer interference mirror to 8-10% and radiation of 90-95% light energy are carried out by effect with optical radiation and/or electric and/or magnetic field at obtaining maximum value of cumulated energy.

Claims: 2 independent

Fig.: 3

PATENTED INVENTIONS

PART A

A 61

- (11) P 2015 6366 B** **(51) Int. Cl. (2006)**
A 61 K 31/54
 (10) AP 2015 12693 A (44) 11(423)/2015
 (21) AP 2010 012693
 (22) 2010 10 06
 (24) 2010 10 06
 (31) 61/249,685; PCT/US2010/051553
 (32) 2009 10 08; 2010 10 06
 (33) US; WO
 (86) PCT/US2010/051553, 2010 10 06
 (73) MERCK SHARP & DOHME CORP. (US)
 126 East Lincoln Ave., Rahway,
 NJ 07065 (US)
 (72) SKOTH, Jack D. (US);
 STAMFORD, Andrew, W. (AU);
 GILBERT, Eric, J. (US);
 CUMMING, Jared, N. (US);
 ISERLOH, Ulrich (DE);
 MISIASZEK, Jeffrey, A. (US);
 LI, Guoqing (CN)
 (74) Shalva Gvaramadze
 (54) **IMINOTHIADIAZINE DIOXIDE**
COMPOUNDS AS BACE INHIBITORS,
COMPOSITIONS, AND THEIR USE

PART B

B 60

- (11) P 2015 6367 B** **(51) Int. Cl. (2006)**
B 60 L 8/00
 (10) AP 2015 12771 A (44) 11(423)/2015
 (21) AP 2010 012771
 (22) 2010 12 02
 (24) 2010 12 02
 (31) 2965/CHE/2009
 (32) 2009 12 02
 (33) IN
 (86) PCT/IN2010/000780, 2010 12 02
 (73) ARUMUGAM, Rajendra Babu (IN).
 No. 77a, P.T. Rajan Salay, c.c. Nagar, Chennai
 600 078 (IN);
 CHETTIAR, Kannappan (SG)
 3 Anson Rd, N 06-01, Springleaf Tower,
 Singapore 079909 (SG)
 (72) ARUMUGAM, Rajendra Babu (IN);
 CHETTIAR, Kannappan (SG)

- (74) Khatuna Imnadze
 (54) **WIND BASED LOAD ISOLATED**
ELECTRICAL CHARGING SYSTEM

PART C

C 07

- (11) P 2015 6373 B** **(51) Int. Cl. (2006)**
C 07 C 55/10
C 07 C 57/15
C 07 C 69/86
C 07 C 227/18
C 07 C 229/12
C 07 D 239/557
A 61 K 31/616
A 61 K 31/205
A 61 K 31/197
A 61 K 31/513
A 61 P 9/00
 (10) AP 2015 13252 A (44) 11(423)/2015
 (21) AP 2012 013252
 (22) 2012 04 27
 (24) 2012 04 27
 (31) 11163839.1; 11163841.7; 11163840.9;
 11163872.2; 111613871.4
 (32) 2011 04 27; 2011 04 27;
 2011 04 27; 2011 04 27; 2011 04 27
 (33) EP; EP; EP; EP; EP
 (86) PCT/EP2012/057806, 2012 04 27
 (73) GRINDEKS, A JOINT STOCK
 COMPANY (LV)
 53, Krustpils street LV-1057 Riga (LV)
 (72) KALVINS, Ivars (LV);
 LIEPINS, Edgars (LV);
 LOZA, Einars (LV);
 DAMBROVA, Maija (LV);
 STONANS, Ilmars (LV);
 LOLA, Daina (LV);
 KUKA, Janis (LV);
 PUGOVICS, Osvalds (LV);
 VILSKERSTS, Reinis (LV);
 GRINBERGA, Solveiga (LV)
 (74) Khatuna Imnadze
 (54) **USE OF 3-CARBOXY-N-ETHYL-N,N-**
DIMETHYLPROPAN-1-AMINIUM
SALTS IN THE TREATMENT OF
CARDIOVASCULAR DISEASE

(11) P 2015 6369 B **(51) Int. Cl. (2006)**
C 07 C 215/08
C 07 C 229/34
C 07 C 255/43
C 07 D 223/16

(10) AP 2015 13040 A (44) 11(423)/2015
(21) AP 2013 013040
(22) 2013 03 25
(24) 2013 03 25
(31) 12.52728
(32) 2012 03 27
(33) FR
(73) LES LABORATOIRES SERVIER (FR)
35, rue de Verdun, 92284 Suresnes
Cedex (FR)
(72) LE FLOHIC, Alexandre (FR);
GRAND JEAN, Mathieu (FR)
(74) Tamaz Shilakadze
(54) **NEW PROCESS FOR SYNTHESIS
OF IVABRADINE AND ADDITION
SALTS THEREWITH PHARMACEUTI-
CALLY ACCEPTABLE ACID**

(11) P 2015 6370 B **(51) Int. Cl. (2006)**
C 07 D 213/64
C 07 D 213/69
C 07 D 401/04
C 07 D 401/10
C 07 D 405/04
C 07 D 405/12
C 07 D 413/10
C 07 D 417/12
A 61 P 31/00
A 61 K 31/4412
A 61 K 31/4427
A 61 K 31/4439
A 61 K 31/4433

(10) AP 2015 13215 A (44) 11(423)/2015
(21) AP 2012 013215
(22) 2012 02 22
(24) 2012 02 22
(31) 61/449,825
(32) 2011 03 07
(33) US
(86) PCT/IB2012/050812, 2012 02 22
(73) PFIZER INC. (US)
235 East 42nd Street New York, New York
10017 (US)
(72) BROWN, Matthew Frank (US);
CHE, Ye (CN);
MELNICK, Michael Joseph (US);
MONTGOMERY, Justin Ian (US);
PLUMMER, Mark Stephen (US);
PRICE, Loren Michael (US);
REILLY, Usa (GB)
(74) Shalva Gvaramadze
(54) **FLUORO-PYRIDINONE
DERIVATIVES USEFUL AS
ANTIBACTERIAL AGENTS**

(11) P 2015 6372 B **(51) Int. Cl. (2006)**
C 07 D 237/16
C 07 D 401/10
C 07 D 407/10
A 61 K 31/50
A 61 K 31/501
A 61 P 25/18
A 61 P 29/00
A 61 P 25/28

(10) AP 2015 13407 A (44) 11(423)/2015
(21) AP 2012 013407
(22) 2012 08 21
(24) 2012 08 21
(31) 1114399.7; 1118658.2; 1203533.3
(32) 2011 08 22; 2011 10 27; 2012 02 29
(33) GB; GB; GB
(86) PCT/GB2012/000672, 2012 08 21
(73) TAKEDA PHARMACEUTICAL
COMPANY LIMITED (JP)
1-1, Doshomachi 4-chome Chuo-ku, Osaka-shi
Osaka 5410045 (JP)
(72) FARNABY, William (GB);
FIELDHOUSE, Charlotte (GB);
HAZEL, Katherine (GB);
KERR, Catrina (GB);
KINSELLA, Natasha (GB);
LIVERMORE, David (GB);
MERCHANT, Kevin (GB);
MILLER, David (GB)
(74) Aleksandre Gegechkori
(54) **PYRIDAZINONE COMPOUNDS
AND THEIR USE AS DAAO INHIBITORS**

(11) P 2015 6368 B **(51) Int. Cl. (2006)**
C 07 D 401/06
A 61 K 31/4439
A 61 P 31/18

(10) AP 2015 12882 A (44) 11(423)/2015
(21) AP 2011 012882
(22) 2011 03 28
(24) 2011 03 28
(31) 61/318,824; 61/321,573
(32) 2010 03 30; 2010 04 07
(33) US; US
(86) PCT/CA2011/000320, 2011 03 28
(73) MERCK CANADA INC. (CA)
16711 Trans-Canada Highway Kirkland,
Québec H9H 3L1 (CA)
(72) BURCH, Jason (CA);
COTE, Bernard (CA);
NGUYEN, Natalie (CA);
LI, Chun, Sing (CA);
ST-ONGE, Miguel (CA);
GAUVREAU, Danny (CA)
(74) Tamaz Shilakadze
(54) **NON-NUCLEOSIDE REVERSE
TRANSCRIPTASE INHIBITORS**

PART G

G 06

(11) P 2015 6371 B **(51) Int. Cl. (2006)**
G 06 Q 30/00

(10) AP 2015 13265 A (44) 11(423)/2015

(21) AP 2013 013265

(22) 2013 10 18

(24) 2013 10 18

(73) LTD "ANTRE 2008" (GE)

Janashias q. 28, b. 7, Tbilisi (GE)

(72) Evgeni Pichkhaia (GE)

(54) **SYSTEM AND METHOD FOR
TELECOMMUNICATION
FOODSERVICE OPTIMIZATION**

PATENTED UTILITY MODELS

PART A

A 61

(11) U 2015 1871 Y **(51) Int. Cl. (2006)**
A 61 K 36/80
B 01 D 11/02

(10) AU 2015 13380 U (44) 11(423)/2015
 (21) AU 2014 013380
 (22) 2014 02 06
 (24) 2014 02 06
 (73) Ketevan Ebralidze (GE)

Nutsubidzis perd. IV mkr., korp. 9, b. 7,
 0186, Tbilisi (GE);
 Mzia Tsitsagi (GE)
 Dighmis Masivi III kv., korp. 16, b. 17,
 Tbilisi (GE);
 Mariam Chkhaidze (GE)
 Vazha-Pshavelas VI kv., korp. 37, b. 58,
 0186, Tbilisi (GE);
 Miranda Khachidze (GE)
 A. Kurdianis q. 6, 0113, Tbilisi (GE);
 Badri Arziani (GE)
 Gogiberidzis q. 3, 0102, Tbilisi (GE);
 Manana Buzariashvili (GE)
 Sakhalkhos q. 6/90, 0144, Tbilisi (GE)

(72) Ketevan Ebralidze (GE);
 Mzia Tsitsagi (GE);
 Mariam Chkhaidze (GE);
 Miranda Khachidze (GE);
 Badri Arziani (GE);
 Manana Buzariashvili (GE)

**(54) METHOD FOR QUERCETIN
 PREPARATION**

PART B

B 28

(11) U 2015 1870 Y **(51) Int. Cl. (2006)**
B 28 B 1/00

(10) AU 2015 13058 U (44) 10(422)/2015
 (21) AU 2013 013058
 (22) 2013 04 16
 (24) 2013 04 16
 (73) Zhora Gabrichidze (GE)
 Gldanis I mkr., korp. 4, b. 44, 0167, Tbilisi (GE);
 Nani Mikava (GE)
 Gldanis I mkr., korp. 4, b. 44, 0167, Tbilisi (GE);
 Nata Gogokhia (GE)
 Gldanis I mkr., korp. 4, b. 44, 0167, Tbilisi (GE)

(72) Zhora Gabrichidze (GE);
 Nani Mikava (GE);
 Nata Gogokhia (GE)
**(54) METHOD OF "QVEVRI" MECHANICAL
 PRODUCTION**

PART C

C 07

(11) U 2015 1872 Y **(51) Int. Cl. (2006)**
C 07 B 7/22

(10) AU 2015 13588 U (44) 11(423)/2015
 (21) AU 2014 013588
 (22) 2014 10 02
 (24) 2014 10 02
 (73) Davit Oniani (GE)
 Al. Diumas q. 12, 0105, Tbilisi (GE);
 Kandit Kvitsiani (GE)
 Al. Diumas q. 12, 0105, Tbilisi (GE);
 Giorgi Ghvedashvili (GE)
 Al. Diumas q. 12, 0105, Tbilisi (GE);
 Khatuna Oniani (GE)
 Al. Diumas q. 12, 0105, Tbilisi (GE)

(72) Davit Oniani (GE);
 Kandit Kvitsiani (GE);
 Giorgi Ghvedashvili (GE);
 Khatuna Oniani (GE)

(54) BINDING MATERIAL

PART D

D 06

(11) U 2015 1873 Y **(51) Int. Cl. (2006)**
D 06 F 57/12

(10) AU 2015 13637 U (44) 11(423)/2015
 (21) AU 2014 013637
 (22) 2014 11 17
 (24) 2014 11 17
 (73) Lali Latsabidze (GE)
 Cholokashvilis q., II kvart., korp. 5, b. 8, 0113,
 Tbilisi (GE)
 (72) Lali Latsabidze (GE)
 (74) Salome Kalandadze
**(54) DRYING ROOM FOR LINEN OR
 CLOTHS WITH PROTECTIVE
 OVERLAP**

DESIGNS REGISTERED ACCORDING TO THE ACCELERATED PROCEDURE

The decision can be appealed at the Chamber of Appeal of Sakpatenti within 3 months from the publication.

- (11) D 2015 646 S (51) 09-05
 (21) AD 2015 000879 (22) 2015 09 03
 (24) 2015 09 03
 (28) 5
 (18) 2020 09 03
 (73) LTD "DAR CAPITAL" (GE)
 A. Shanidzis q. 5, 6000, Batumi (GE)
 (72) Dimitri Chaghalidze (GE)
 (74) Vakhtang Torotadze
 (54) PACKING BAG CAPSULE
 (55)



1.1



1.2



2.1



2.2



3.1

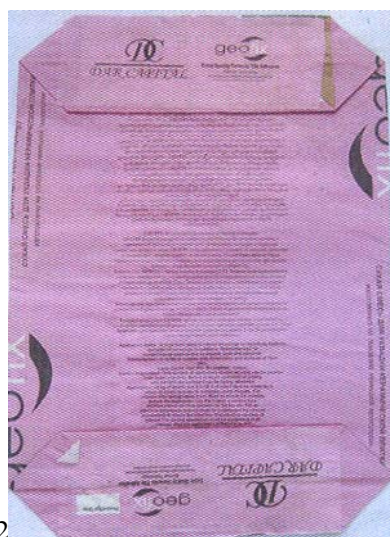

3.2



4.1



4.2



5.1

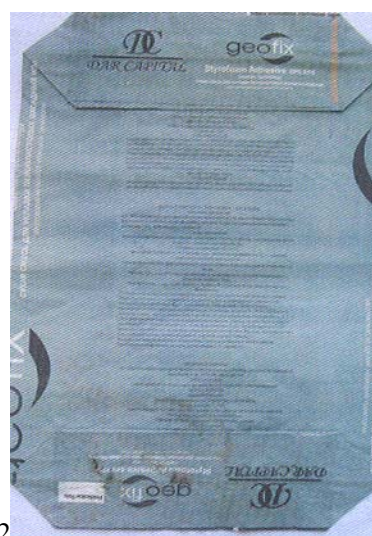

5.2

- (11) D 2015 647 S (51) 09-05
 (21) AD 2015 000880 (22) 2015 09 03
 (24) 2015 09 03
 (28) 1
 (18) 2020 09 03
 (73) LTD "DAR CAPITAL" (GE)
 A. Shanidzis q. 5, 6000, Batumi (GE)
 (72) Dimitri Chaghalidze (GE)
 (74) Vakhtang Torotadze
 (54) PACKING BAG CAPSULE
 (55)



1.1



1.2

- (11) D 2015 645 S (51) 09-07
 (21) AD 2015 000875 (22) 2015 08 17
 (24) 2015 08 17
 (28) 2
 (18) 2020 08 17
 (73) GONCHAR, Anatoly Vasilyevich (UA)
 Chernivtsi Region, Khotin District, Shilivci Village, Miru Str. 33, 60022 (UA)
 (72) GONCHAR, Anatoly Vasilyevich (UA)
 (74) Giorgi Kartvelishvili
 (54) LID FOR GLASS CAN SEALING
 (55)



1.1



1.2

1.3

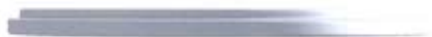

1.4



1.5



2.1



2.2



2.3



2.4



2.5



TRADEMARKS

APPLICATIONS FILED UNDER THE NATIONAL PROCEDURE APPROVED FOR REGISTRATION

The decision can be appealed at the Chamber of Appeal of Sakpatenti within 3 months from the publication or at the Mtskheta District Court Administrative Cases Board (Address: №17, Samkhedro St., Mtskheta), within 1 month following the publication.

(260) AM 2015 77262 A
(210) AM 77262
(220) 2014 05 23
(731) LTD "KVARLI CELLAR"
Sop. Chikaani, Kvarlis Raioni, Georgia
(740) Khatuna Imnadze
(540)

ყვარლის სარდაფი
Кварельский Погреб
Kvareli Cellar

(526) „ყვარლის“, „Кварельский“, "Kvareli"
(511) 33

(260) AM 2015 77725 A
(210) AM 77725
(220) 2014 06 27
(731) LTD "A-B-C PHARMACY"
Sanapiros q.10, 0108 Tbilisi, Georgia
(740) Salome Jeladze
(540)



(591) Black, (dark) yellow
(531) 26.04.22, 27.03.02, 29.01.12, 02.03.01
(511) 3, 5, 35, 44

(260) AM 2015 77857 A
(210) AM 77857
(220) 2014 07 08
(731) "GENERAL MOTORS LLC"
300 Renaissance Center, City of Detroit,
State of Michigan 48265-3000, USA
(740) Giorgi Taktakishvili
(540)

ESCALADE

(591) Black, white
(511) 12

(260) AM 2015 77858 A
(210) AM 77858
(220) 2014 07 08
(731) "GENERAL MOTORS LLC"
300 Renaissance Center, City of Detroit,
State of Michigan 48265-3000, USA
(740) Giorgi Taktakishvili
(540)

SRX

(591) Black, white
(511) 12

(260) AM 2015 79327 A
(210) AM 79327
(220) 2014 11 03
(731) LTD "AXA MEDICAL"
D. Agmasheneblis gamz.150, Tbilisi,
Georgia
(740) Nugzar Ksovreli
(540)

აქსა კოსმეტიკა
Axa Cosmetics
Акса Косметика

(591) Black, white
(526) The trademark is protected as a whole.
"კოსმეტიკა, Cosmetics, Косметика" shall not be
subject to independent legal protection.
(511) 3, 5, 35

(260) AM 2015 79476 A
(210) AM 79476
(220) 2014 11 13
(731) NOVARTIS AG.
4002 Basel, Switzerland
(740) Pavle Meipariani
(540)

PRILAM

(591) Black, white
(511) 5

(260) AM 2015 79578 A
(210) AM 79578
(220) 2014 11 20

(731) LTD "HERBAL PREPARATION"
Balanchivadzis q. 43, 0171, Tbilisi, Georgia
(540)

GINKGO Q10
გინგგო Q10
ГИНГГО Q10

(591) Black, white
(511) 5, 35

(260) AM 2015 79584 A
(210) AM 79584
(220) 2014 11 20
(731) LTD "HERBAL PREPARATION"
Balanchivadzis q. 43, 0171, Tbilisi, Georgia
(540)

WOMAN GEL
ვუმენ გელ
ВУМЕН ГЕЛ

(591) Black, white
(511) 35

(260) AM 2015 79588 A
(210) AM 79588
(220) 2014 11 20
(731) LTD "HERBAL PREPARATION"
Balanchivadzis q. 43, 0171, Tbilisi, Georgia
(540)

NANOCALC
ნანოკალცი
НАНОКАЛС

(591) Black, white
(511) 35

(260) AM 2015 79590 A
(210) AM 79590
(220) 2014 11 20
(731) LTD "HERBAL PREPARATION"
Balanchivadzis q. 43, 0171, Tbilisi, Georgia
(540)

NANOCALC BABY
ნანოკალცი ბები
НАНОКАЛС БЭИБИ

(591) Black, white
(511) 35

(260) AM 2015 79796 A
(210) AM 79796
(220) 2014 12 04
(731) ASSAN GIDA SANAYİ VE TİCARET
ANONİM ŞİRKETİ

Tersane Caddesi, Bakır Sokak, Assan Han,
No:11, Karaköy – İstanbul, Turkey
(740) Merab Kvimsadze
(540)



(591) Dark green, light green, cream
(531) 26.01.24, 27.05.19, 26.01.20, 29.01.13
(511) 32

(260) AM 2015 79842 A
(210) AM 79842
(220) 2014 12 08
(310) UK00003064893
(320) 2014 07 18
(330) GB
(731) BRITISH AMERICAN TOBACCO
(BRANDS) INC. (a Delaware corporation)
2711 Centerville Road, Suite 300,
Wilmington, Delaware 19808, USA
(740) Tamar Kochlamazashvili
(540)

1871 WILD

(511) 34

(260) AM 2015 79844 A
(210) AM 79844
(220) 2014 12 08
(310) UK00003064887
(320) 2014 07 18
(330) GB
(731) BRITISH AMERICAN TOBACCO
(BRANDS) INC. (a Delaware corporation)
2711 Centerville Road, Suite 300,
Wilmington, Delaware 19808, USA
(740) Tamar Kochlamazashvili
(540)

1871 CRISP

(511) 34

(260) AM 2015 79955 A
(210) AM 79955
(220) 2014 12 17
(731) UNITED WINERY AND DISTILLERY CO;
LTD.
14, Sangsom Building, Soi Yasoob 1,
Vibhavadi Rangsit Road, Chomphon
Sub-District, Chatuchak District,
Bangkok 10900, Thailand
(740) Liliana Darakhvelidze

(540)



(591) Black, white
 (531) 25.01.19, 27.05.03, 27.07.17, 19.01.05
 (526) The trademark is protected as a whole. "BLEND" shall not be subject to independent legal protection.
 (511) 33

(260) AM 2015 80446 A
 (210) AM 80446
 (220) 2015 01 23
 (731) LTD "INSURANCE COMPANY ARDI GROUP"
 Vazha-Pshavelas gamz. 3, Vake-Saburtalos raioni, Tbilisi, Georgia
 (740) Vakhtang Torotadze
 (540)



(591) White, grey, irelandian green, bright yellow-green, June bud
 (531) 26.04.12, 26.04.18, 27.05.05, 27.05.21, 28.19, 29.01.13
 (511) 35, 36, 37, 38 39, 41, 42, 45

(260) AM 2015 80464 A
 (210) AM 80464
 (220) 2015 01 26
 (731) Gestmusic Endemol, S.A.U.
 Santa Elionor, 3, 08024 Barcelona, Spain
 (740) Liliana Darakhvelidze
 (540)

ერთი ერთში

(591) Black, white
 (511) 9, 38, 41

(260) AM 2015 80481 A
 (210) AM 80481
 (220) 2015 01 26
 (731) LTD "J-M-P"

Sop. Ponichala 65, 0165, Tbilisi, Georgia
 (740) Nugzar Ksovreli
 (540)

ზუმ – 400
ЗУММ – 400
ZUMM – 400

(591) Black, white
 (511) 5

(260) AM 2015 80482 A
 (210) AM 80482
 (220) 2015 01 26
 (731) LTD "J-M-P"
 Sop. Ponichala 65, 0165, Tbilisi, Georgia
 (740) Nugzar Ksovreli
 (540)

ზუმ – 600
ЗУММ – 600
ZUMM – 600

(591) Black, white
 (511) 5

(260) AM 2015 80483 A
 (210) AM 80483
 (220) 2015 01 26
 (731) LTD "J-M-P"
 Sop. Ponichala 65, 0165, Tbilisi, Georgia
 (740) Nugzar Ksovreli
 (540)

სენა G
Сена G
Sena G

(591) Black, white
 (511) 5

(260) AM 2015 80910 A
 (210) AM 80910
 (220) 2015 02 19
 (731) LTD "BATONO"
 Iakob Nikoladzis q.12, 0179 Tbilisi, Georgia
 (540)

ლუჩიანო
Luchiano
Лучиано

(591) Black, white
 (511) 33

(260) AM 2015 80911 A
 (210) AM 80911
 (220) 2015 02 19

- (731) LTD "BATONO"
Iakob Nikoladzis q.12, 0179 Tbilisi, Georgia
(540)



- (591) Golden, green, brown and black
(531) 24.09.12, 25.01.10, 26.01.02, 29.01.14,
25.01.19
(511) 33

- (526) The trademark is protected as a whole. "CRE-
DIT" shall not be subject to independent legal pro-
tection.
(511) 36

- (260) AM 2015 80986 A
(210) AM 80986
(220) 2015 02 25
(731) LTD Microfinancial Organization
"RICO EXPRESS"
I. Chavchavadzis gamz. 70, 0162, Tbilisi,
Georgia
(740) Mindia Burduli
(540)



- (591) Lilac, dark grey, light grey
(531) 24.15.13, 27.05.02, 27.05.10, 29.01.13
(526) The trademark is protected as a whole. "mo-
ney transfer" shall not be subject to independent
legal protection.
(511) 36



- (591) Lilac, golden
(531) 26.01.04, 26.01.10, 26.01.21, 26.03.18,
26.07.03, 26.11.08, 27.01.12, 27.05.21,
29.01.12
(526) The trademark is protected as a whole.
"EXPRESS" shall not be subject to independent
legal protection.
(511) 36

- (260) AM 2015 80987 A
(210) AM 80987
(220) 2015 02 25
(731) LTD Microfinancial Organization
"RICO EXPRESS"
I. Chavchavadzis gamz. 70, 0162, Tbilisi,
Georgia
(740) Mindia Burduli
(540)



- (591) Lilac, golden
(531) 26.03.18, 26.07.03, 26.11.08, 27.05.21,
26.01.04, 29.01.13, 26.01.21, 26.01.10

- (260) AM 2015 80991 A
(210) AM 80991
(220) 2015 02 25
(731) LTD Microfinancial Organization
"RICO EXPRESS"
I. Chavchavadzis gamz. 70, 0162, Tbilisi,
Georgia
(740) Mindia Burduli
(540)



- (591) Lilac, golden
(531) 26.01.04, 26.01.10, 26.03.18, 26.07.03,
26.11.08, 27.05.21, 28.19, 29.01.12
(526) The trademark is protected as a whole. „ქვე-
პრესი“ shall not be subject to independent legal
protection.
(511) 36

(260) AM 2015 80992 A
(210) AM 80992
(220) 2015 02 25
(731) LTD Microfinancial Organization
"RICO EXPRESS"
I. Chavchavadzis gamz. 70, 0162, Tbilisi,
Georgia
(740) Mindia Burduli
(540)



(591) Lilac, golden
(531) 26.11.08, 27.05.21, 29.01.12, 26.01.04,
26.01.10, 26.01.21, 26.03.18, 26.07.03
(526) The trademark is protected as a whole.
"GROUP" shall not be subject to independent legal
protection.
(511) 36

(260) AM 2015 81003 A
(210) AM 81003
(220) 2015 02 25
(731) LTD "INSURANCE COMPANY ARDI
GROUP"
Vazha-Pshavelas gamz. 3, Vake-Saburtalos
raioni, Tbilisi, Georgia
(740) Vakhtang Torotadze
(540)



(591) White, grey, irelandian green, brightness
yellow-green, June bud
(531) 27.05.10, 28.19, 29.01.13, 26.04.18
(511) 36

REGISTERED TRADEMARKS

(111) M 2015 26251 R
 (151) 2015 09 08
 (181) 2025 09 08
 (260) AM 2015 82821 A
 (220) 2015 07 03
 (732) Public Joint-stock Company "ARNEST"
 6, ul. Kombinatskaya, RU-357107, Nevinnomyssk, Stavrapolsky Krai, Russian Federation

(111) M 2015 26252 R
 (151) 2015 09 08
 (181) 2025 09 08
 (260) AM 2015 75191 A
 (220) 2013 12 18
 (732) NEMIROFF INTELLECTUAL PROPERTY ESTABLISHMENT.
 Staedtle 31, 9490 Vaduz, Liechtenstein

(111) M 2015 26253 R
 (151) 2015 09 08
 (181) 2025 09 08
 (260) AM 2015 75719 A
 (220) 2014 01 29
 (732) LTD "GEORGIAN ALLIANCE"
 G. Nadareishvilis q.4, 0144 Tbilisi, Georgia

(111) M 2015 26254 R
 (151) 2015 09 08
 (181) 2025 09 08
 (260) AM 2015 76367 A
 (220) 2014 03 21
 (732) GÜROK TURİZM VE MADENCİLİK ANONİM ŞİRKETİ
 Eskişehir Karayolu Üzeri 5. Km, Merkez/Kütahya, Turkey

(111) M 2015 26255 R
 (151) 2015 09 08
 (181) 2025 09 08
 (260) AM 2015 76628 A
 (220) 2014 04 08
 (732) CURVES INTERNATIONAL, INC.
 100 Ritchie Road, Waco, Texas 76712, USA

(111) M 2015 26256 R
 (151) 2015 09 09
 (181) 2025 09 09
 (260) AM 2015 76630 A
 (220) 2014 04 08

(732) Ameed Food Industries W.L.L.
 P.O. Box 1557 Amman 11953, Jordan

(111) M 2015 26257 R
 (151) 2015 09 09
 (181) 2025 09 09
 (260) AM 2015 76843 A
 (220) 2014 04 28
 (732) LTD "IDS BORJOMI BEVERAGES COMPANY"
 Toris q. 39, 1200, Borjomi, Georgia

(111) M 2015 26258 R
 (151) 2015 09 09
 (181) 2025 09 09
 (260) AM 2015 77189 A
 (220) 2014 05 19
 (732) MR. PARDEEP JAIN and MR. SUDHIR HASIJA
 Trading as P. S. ASSOCIATES., OKHLA INDUSTRIAL AREA, Phase - I, NEW DELHI – 110 020, India

(111) M 2015 26259 R
 (151) 2015 09 09
 (181) 2025 09 09
 (260) AM 2015 77258 A
 (220) 2014 05 23
 (732) GILEAD SCIENCES IRELAND UC
 IDA Business and Technology Park, Carrigtohill, Co. Cork, Ireland

(111) M 2015 26260 R
 (151) 2015 09 09
 (181) 2025 09 09
 (260) AM 2015 78253 A
 (220) 2014 08 08
 (732) SHANTHA BIOTECHNICS LIMITED
 3rd & 4th Floor. Vasanta Chimberz, Fateh Maidan Road, Basheerbagh, Hiderabadi, 5000 004 Andhra Pradesh, India

(111) M 2015 26261 R
 (151) 2015 09 09
 (181) 2025 09 09
 (260) AM 2015 78263 A
 (220) 2014 08 11
 (732) JK TYRE & INDUSTRIES LIMITED.
 Jaykaygram, PO-Tyre Factory, Kankroli-313 342, Rajasthan, India

(111) M 2015 26262 R
(151) 2015 09 09
(181) 2025 09 09
(260) AM 2015 78272 A
(220) 2014 08 12
(732) BRITISH AMERICAN TOBACCO
(BRANDS) INC. (a Delaware corporation).
2711 Centerville Road, Suite 300,
Wilmington, Delaware 19808, USA

(111) M 2015 26263 R
(151) 2015 09 09
(181) 2025 09 09
(260) AM 2015 78273 A
(220) 2014 08 12
(732) NISSAN JIDOSHA KABUSHIKI KAISHA
(also trading as NISSAN MOTOR CO., LTD.)
2, Takara-cho, Kanagawa-ku, Yokohama-shi,
Kanagawa-ken, Japan

(111) M 2015 26264 R
(151) 2015 09 09
(181) 2025 09 09
(260) AM 2015 78382 A
(220) 2014 08 25
(732) SHULTON, INC.
One Procter & Gamble Plaza, Cincinnati
OH 45202, USA

(111) M 2015 26265 R
(151) 2015 09 09
(181) 2025 09 09
(260) AM 2015 78383 A
(220) 2014 08 25
(732) THE GILLETTE COMPANY
One Gillete Park, Boston, Massachusetts
02127, USA

(111) M 2015 26266 R
(151) 2015 09 09
(181) 2025 09 09
(260) AM 2015 78409 A
(220) 2014 08 29
(732) NOVARTIS AG
4002 Basel, Switzerland

(111) M 2015 26267 R
(151) 2015 09 09
(181) 2025 09 09
(260) AM 2015 78410 A
(220) 2014 08 29
(732) NOVARTIS AG
4002 Basel, Switzerland

(111) M 2015 26268 R
(151) 2015 09 09
(181) 2025 09 09
(260) AM 2015 78457 A
(220) 2014 09 02
(732) LTD "LOPOTA TOUR SERVICE"
Sop. Napareuli, Telavis raioni, Georgia

(111) M 2015 26269 R
(151) 2015 09 09
(181) 2025 09 09
(260) AM 2015 78721 A
(220) 2014 09 18
(732) LTD "FASTGOOD"
117186, Ul. Remizova, d. 14, korp. 1, kv. 17,
Moskow, Russian Federation

(111) M 2015 26270 R
(151) 2015 09 09
(181) 2025 09 09
(260) AM 2015 78728 A
(220) 2014 09 18
(732) THE GILLETTE COMPANY
One Gillete Park, Boston, Massachusetts
02127, USA

(111) M 2015 26271 R
(151) 2015 09 09
(181) 2025 09 09
(260) AM 2015 78754 A
(220) 2014 09 19
(732) DIAGEO NORTH AMERICA, INC
a Connecticut corporation
801 Main Avenue, Norwalk CT 06851, USA

(111) M 2015 26272 R
(151) 2015 09 09
(181) 2025 09 09
(260) AM 2015 78789 A
(220) 2014 09 24
(732) SWISS PHARMA INTERNATIONAL AG
Waldmannstrasse 8, 8001 Zurich, Switzerland

(111) M 2015 26273 R
(151) 2015 09 09
(181) 2025 09 09
(260) AM 2015 78790 A
(220) 2014 09 24
(732) SWISS PHARMA INTERNATIONAL AG
Waldmannstrasse 8, 8001 Zurich, Switzerland

(111) M 2015 26274 R
(151) 2015 09 09
(181) 2025 09 09
(260) AM 2015 78807 A
(220) 2014 09 26
(732) SOCIÉTÉ DES PRODUITS NESTLÉ S.A
CH-1800 Vevey, Switzerland

(111) M 2015 26275 R
(151) 2015 09 09
(181) 2025 09 09
(260) AM 2015 78849 A
(220) 2014 09 29
(732) KENTUCKY FRIED CHICKEN
INTERNATIONAL HOLDINGS, INC.
1441 Gardiner Lane, Louisville, Kentucky
40213, USA

(111) M 2015 26277 R
(151) 2015 09 09
(181) 2025 09 09
(260) AM 2015 78850 A
(220) 2014 09 29
(732) KENTUCKY FRIED CHICKEN
INTERNATIONAL HOLDINGS, INC.
1441 Gardiner Lane, Louisville, Kentucky
40213, USA

(111) M 2015 26278 R
(151) 2015 09 09
(181) 2025 09 09
(260) AM 2015 79202 A
(220) 2014 10 24
(732) DISCOVERY COMMUNICATIONS, LLC
One Discovery Place, Silver Spring, Maryland
20910, USA

TRADEMARKS REGISTERED ACCORDING TO THE ACCELERATED PROCEDURE

The decision can be appealed at the Chamber of Appeal of Sakpatenti within 3 months from the publication.

(111) M 2015 26250 R
(151) 2015 09 08
(181) 2025 09 08
(210) AM 83396
(220) 2015 08 17
(732) Davit Chrelashvili
Kavsadzis q. 3, 0179, Tbilisi, Georgia
(740) Davit Tchrelashvili
(540)



(591) Black, white
(531) 27.05.02, 28.19
(511) 29, 30, 43

(111) M 2015 26276 R
(151) 2015 09 09
(181) 2025 09 09
(210) AM 83390
(220) 2015 08 17
(310) 55942/2015
(320) 2015 05 20
(330) CH
(732) JAPAN TOBACCO INC.
2-2-1 Toranomon, Minato-ku, Tokyo, Japan
(740) Shalva Gvaramadze
(540)



(591) Black, white
(531) 14.01.01, 26.15.03, 27.05.15
(511) 34

(111) M 2015 26279 R
(151) 2015 09 09
(181) 2025 09 09
(210) AM 83332
(220) 2015 08 07
(732) CJSC "PHARMFIRM "SOTEX"
141345, Moskovskaya Oblast, Sergievo-
Posadski Municipalni Raion, Selskoe
Poselenie Bereznyakovskoe, Pos. Belikovo,
d. 11, Russian Federation
(740) Khatuna Imnadze

(540)

Дексалфен

(511) 5

(111) M 2015 26280 R
(151) 2015 09 09
(181) 2025 09 09
(210) AM 83372
(220) 2015 08 13
(732) LTD "TELAVI DISTILERI"
Sh. Nutsubidzis q.14, b.60, 0186 Tbilisi,
Georgia
(740) Jimsher Gurgendidze
(540)



(591) Black, white
(531) 22.05.03, 02.01.01
(511) 33, 35

(111) M 2015 26281 R
(151) 2015 09 10
(181) 2025 09 10
(210) AM 83337
(220) 2015 08 07
(732) CJSC "PHARMFIRM "SOTEX"
141345, Moskovskaya Oblast, Sergievo-
Posadski Municipalni Raion, Selskoe
Poselenie Bereznyakovskoe, Pos. Belikovo,
d. 11, Russian Federation
(740) Khatuna Imnadze
(540)

Гемоксипарин

(511) 5

(111) M 2015 26282 R
(151) 2015 09 11
(181) 2025 09 11
(210) AM 83429
(220) 2015 08 19

(732) JSC "PROCREDIT BANK"
Kazbegis gamz. 21, 0160, Tbilisi, Georgia
(740) Vladimer Kvataia
(540)



(591) Yellow, orange, red, green, lilac and blue
(531) 26.11.08, 26.11.09, 27.07.01, 28.19, 29.01.15
(511) 36

(111) M 2015 26283 R
(151) 2015 09 11
(181) 2025 09 11
(210) AM 83430
(220) 2015 08 19
(732) JSC "PROCREDIT BANK"
Kazbegis gamz. 21, 0160, Tbilisi, Georgia
(740) Vladimer Kvataia
(540)



(591) Yellow, orange, red, green, lilac and blue
(531) 26.11.08, 26.11.09, 27.05.11, 29.01.15,
27.07.01
(511) 36

(111) M 2015 26284 R
(151) 2015 09 16
(181) 2025 09 16
(210) AM 83635
(220) 2015 09 01
(732) LTD "TAXINET"
Delisis quchis dasatskisshi, sad. 1, sar. 1, b. 2,
0177, Tbilisi, Georgia
(740) Besik Tsimakuridze
(540)



(591) White, black, yellow
(531) 01.15.21, 26.01.18, 27.05.22, 29.01.12
(511) 39

(111) M 2015 26285 R
(151) 2015 09 17
(181) 2025 09 17
(210) AM 83734
(220) 2015 09 09
(732) "GEORGIAN WINES AND SPIRITS
COMPANY"
Achinebuli, 2200 Telavi, Georgia
(740) Elene Totibadze
(540)

ქობო
ELIBO
ЭЛИБО

(511) 33

(111) M 2015 26286 R
(151) 2015 09 17
(181) 2025 09 17
(210) AM 83484
(220) 2015 08 20
(732) CJSC "PHARMFIRM "SOTEX"
141345, Moskovskaya Oblast, Sergievo-
Posadski Municipalni Raion, Selskoe
Poselenie Bereznyakovskoe, Pos. Belikovo,
d. 11, Russian Federation
(740) Khatuna Imnadze
(540)

ПРОГЕПТИН

(511) 5

(111) M 2015 26287 R
(151) 2015 09 17
(181) 2025 09 17
(210) AM 83677
(220) 2015 09 03
(732) LTD "DAR CAPITAL"
Akaki Shanidzis q. 5, Batumi, Georgia
(740) Vakhtang Torotadze
(540)



(591) Light grey, dark grey, chestnut, white, black
(531) 26.04.24, 26.11.09, 26.11.12, 27.05.02,
27.05.24, 29.01.13
(526) The trademark is protected as a whole.
"SERAMIK FIX" shall not be subject to indepen-
dent legal protection.
(511) 19

(111) M 2015 26288 R
(151) 2015 09 17
(181) 2025 09 17
(210) AM 83678
(220) 2015 09 03
(732) LTD "DAR CAPITAL"
Akaki Shanidzis q. 5, Batumi, Georgia
(740) Vakhtang Torotadze
(540)



(591) White, color of sand, grey
(531) 26.11.12, 27.05.24, 29.01.13
(511) 19

(111) M 2015 26289 R
(151) 2015 09 18
(181) 2025 09 18
(210) AM 83351
(220) 2015 08 12
(732) Irakli Kverghelidze
Sop. Gurianta, 3508, Ozurgeti, Georgia
(740) Gela Makharadze
(540)

ორბი
ORBI
ОРБИ

(511) 35, 37

(111) M 2015 26290 R
(151) 2015 09 18
(181) 2025 09 18
(210) AM 83519
(220) 2015 08 24
(732) JSC "TELIANI VALLEY"
Tbilisis gzatketsili 3, 2200, Telavi, Georgia
(540)

ბიერიკა
BEERIKA

(511) 32, 33

(111) M 2015 26291 R
(151) 2015 09 18
(181) 2025 09 18
(210) AM 83520
(220) 2015 08 24

(732) JSC "TELIANI VALLEY"
Tbilisis gzatketsili 3, 2200, Telavi, Georgia
(540)

ბიერიკა
BIERIKA

(511) 32, 33

INTERNATIONAL TRADEMARKS FOR WHICH A DECISION ON GRANTING PROTECTIONS IS TAKEN

The decision can be appealed at the Chamber of Appeal of Sakpatenti within 3 months from the publication or at the Mtskheta District Court Administrative Cases Board (Address: №17, Samkhedro str., Mtskheta), within 1 month following the publication.

(260) AM 2015 77202 A*
(800) 1201681
(891) 2014 03 17
(731) NEMIROFF INTELLECTUAL PROPERTY ESTABLISHMENT
Städtle 31, FL-9490 Vaduz, Liechtenstein

(540)

NEMIROFF. Водка – это он!

(511)

33 – Alcoholic beverages namely vodka.

35 – Advertising; business management; business administration; office functions; importation and exportation of vodka; retail and wholesale services with vodka.

(260) AM 2015 78680 A
(800) 1214999
(891) 2014 05 12
(731) ERDINGER WEISSBRÄU Franz Brombach
Lange Zeile 1-3, 85435 Erding, Germany

(540)



(591) Gold, blue, white, red and chamouis

(511)

32 – Beer, included alcohol-reduced and alcohol-free beer, especially wheat beer, syrups and other preparations for making beverages.

(260) AM 2015 78806 A
(800) 1215931
(891) 2013 12 17
(731) AKSAN DANIŞMANLIK ANONİM ŞİRKETİ
Meclisi Mebusan Caddesi No:39, Salipazari
Beyoğlu, İstanbul, Turkey

(540)

AKSAN

(591) Blacvk, white

(511)

35 – Advertising, marketing and public relations services (including organization of exhibitions and fairs for commercial and advertising purposes); office functions; secretarial services; arranging newspaper subscriptions for others; compilation of statistics; rental of office machines; systemization of information into computer databases; telephone answering for unavailable subscribers; business management, business administration and business consultancy; accounting; commercial consultancy services; personnel placement; employment agencies; personnel recruitment; import-export agencies; business appraisal services for commercial or industrial products; auctioneering.

41 – Education and training; arranging and conducting of conferences, congresses and seminars; sporting and cultural activities; entertainment; publication and editing of printed matter, including magazines, books, newspapers, other than publicity texts; electronic publication services; production of movie films, radio and television programmes; news reporters services; photographic reporting services; photography; translation.

42 – Scientific and industrial analysis and research services; engineering; computer engineering services; computer programming, computer virus protection services, computer system design, creating, maintaining and updating websites for others, computer software design, updating and rental of computer software, providing search engines for the Internet, hosting websites, computer hardware consultancy, rental of computer hardware; industrial design services, other than engineering, computer and architectural design; graphic arts designing; authenticating works of art.

45 – Legal services, consultancy in the fields of intellectual and industrial property rights; security services for the protection of individuals and property; marriage agencies; funeral services; clothing rental; fire-fighting services; escorting in society (chaaperoning).

(260) AM 2015 78835 A
(800) 1216201
(891) 2014 04 29
(731) TYRE RECYCLING SOLUTIONS SA
Route Cité-Ouest 2, c/o ValleyRoad Capital
SA, CH-1196 Gland, Switzerland

(540)



(591) Black, white

(526) TYRE RECYCLING SOLUTIONS

(511)

7 – Machines and machine tools for cutting up used tires.

40 – Treatment (transformation) of used tires; recycling of used tires; transformation of used tires; cutting up of used tires; treatment of used tires for extracting rubber; services of devulcanization of used tires; provision of information relating to the treatment, transformation and recycling of used tires

(260) AM 2015 78939 A

(800) 1217047

(891) 2014 05 02

(731) IVOCLAR VIVADENT AG

Bendererstrasse 2, FL-9494 Schaan,
Liechtenstein

(540)

IPS e.matrix

(511)

5 – Dental impression and filling materials of ceramics, composites or synthetic materials.

10 – Dental apparatus, namely mounting systems for dental milling blocks made of ceramics, composites or synthetic materials.

(260) AM 2015 78959 A

(800) 1217112

(891) 2014 03 07

(731) INTEL CORPORATION

2200 Mission College Boulevard, Santa Clara,
CA 95052, USA

(540)

QUARK

(591) Black, white

(511)

9 – Computers; handheld computers; minicomputers; computer hardware; computer software; integrated circuits; integrated circuit memories; integrated circuit chips; computer chip sets; semiconductor processors; semiconductor processor chips; semiconductor chips; microprocessors; printed circuit boards; printed circuits, integrated circuit boards, and electrical circuit boards; electronic circuit boards; computer motherboards; computer memories; operating systems; microcontrollers; data processors; central processing units; semiconductor memory devices; semiconductor memories; semiconductor

memory units; software programmable processors; digital and optical microprocessors; computer peripherals; video circuit boards; audio circuit boards; audio-video circuit boards; video graphic accelerators; multimedia accelerators; video processors; video processor boards; data memories; electronic security apparatus and surveillance apparatus; computer hardware, computer chips and microprocessors optimized for electronic security surveillance; algorithm software programs for the operation and control of computers; computer operating system software; computer system extensions, tools and utilities in the field of application software for connecting personal computers, networks, telecommunications apparatus and global computer network applications; computerized telecommunications and networking equipment consisting of operating system software; computer hardware and software for enhancing and providing real-time transfer, transmission, reception, processing and digitizing of audio and video graphics information; computer firmware; computer utility software and other computer software used to maintain and operate computer systems; memory boards; personal digital assistants; portable and handheld electronic personal organizers; storage devices, jump drives, flash drives and thumb drives; security systems for computer hardware and software, firewalls, network access server hardware for creating and maintaining firewalls, virtual private network (VPN) computer hardware and computer server operating software for creating and maintaining firewalls; software for ensuring the security of computer networks; software for access control and security; computer hardware and software for use in protecting computer networks from data theft or damage by unauthorized users; components for computers; computer voice, data, image and video accelerator boards; flash memory boards and flash memory cards; telecommunications equipment and computer networks, namely processing and operating systems; telecommunications apparatus and instruments, computer routers, hubs, servers and switches; computer hardware and software for the development, maintenance, and use of local and wide area computer networks; set-top boxes; electronic control devices for the interface and control of computers and global computer and telecommunications networks with television and cable broadcasts and equipment; apparatus for testing and programming integrated circuits; computer peripheral memory apparatus and devices; fixed function computer servers; computer networking hardware; computer hardware and software for creating, facilitating, and managing remote access to and communication with local area networks (LANs), virtual private networks (VPN), wide area networks (WANs) and global computer networks; router, switch, hub and server operating software; computer software and hardware for use in providing multiple user access to a global

computer information network for searching, retrieving, transferring, manipulating and disseminating a wide range of information; computer software tools for the facilitation of third party software applications; computer hardware and software for wireless network communications; downloadable electronic publications in the nature of newsletters, books, magazines, journals, brochures and white papers in the area of electronics, semiconductors, integrated electronic apparatus and devices, computers, telecommunications, entertainment, telephony, and wired and wireless telecommunications; structural parts and fittings for all the aforesaid goods; instructional manuals sold as a unit with the aforementioned goods and electronic instructional manuals downloadable from a global computer network.

(260) AM 2015 78960 A

(800) 1217179

(891) 2014 03 17

(731) WORLD MEDICINE İLAÇ SANAYİ VE TİCARET ANONİM ŞİRKETİ
Evren Mah. Camiyolu Cad. No:50 K:1 B,
Zemin 4-5-6, Güneşli Bağcılar, İstanbul, Turkey

(540)

BRITIL
БРИТИЛ

(591) Black, white

(511)

5 – Medicines for human purposes, medicines for veterinary purposes, vitamin preparations, chemical preparations for medical purposes, dietetic substances adapted for medical use; dietetic foods adapted for medical purposes; baby foods, medicinal herbs, herbal beverages adapted for medical purposes, nutritional supplements, pollen dietary supplements, mineral food supplements, protein dietary supplements; dietary supplements for animals; fodder supplements for veterinary purposes; medicines for dental purposes, hygienic products for medical purposes including sanitary pads, breast-nursing pads and bunion pads, waddings for medical purposes, plasters for medical purposes, dressings for medical purposes, babies' napkins, preparations for destroying noxious plants, preparations for destroying noxious animals, fungicides, deodorants other than for human beings or for animals, air deodorising preparations, disinfectants for hygiene purposes, antiseptics, detergents for medical purposes.

(260) AM 2015 78961 A

(800) 1217181

(891) 2014 03 17

(731) WORLD MEDICINE İLAÇ SANAYİ VE TİCARET ANONİM ŞİRKETİ
Evren Mah. Camiyolu Cad. No:50 K:1 B,
Zemin 4-5-6, Güneşli Bağcılar, İstanbul, Turkey

(540)

MOTERIS
МОТЕРИС

(591) Black, white

(511)

5 – Medicines for human purposes, medicines for veterinary purposes, vitamin preparations, chemical preparations for medical purposes, dietetic substances adapted for medical use; dietetic foods adapted for medical purposes; baby foods, medicinal herbs, herbal beverages adapted for medical purposes, nutritional supplements, pollen dietary supplements, mineral food supplements, protein dietary supplements; dietary supplements for animals; fodder supplements for veterinary purposes; medicines for dental purposes, hygienic products for medical purposes including sanitary pads, breast-nursing pads and bunion pads, waddings for medical purposes, plasters for medical purposes, dressings for medical purposes, babies' napkins, preparations for destroying noxious plants, preparations for destroying noxious animals, fungicides, deodorants other than for human beings or for animals, air deodorising preparations, disinfectants for hygiene purposes, antiseptics, detergents for medical purposes.

(260) AM 2015 78962 A

(800) 1217182

(891) 2014 03 20

(731) FONTERRA CO-OPERATIVE GROUP
LIMITED
9 Princes Street, Auckland NZ, New Zealand

(540)

NZMP

(511)

1 – Chemical substances; chemical materials; chemical preparations; natural elements; casein for industrial purposes; compositions for use in food and beverages; casein for the food industry; lactose for the food industry; chemical and chemical substances including protein products; chemical and chemical substances including dairy by-products; chemical substances for preserving foodstuffs; adhesives for use in industry; adhesives for use in the foodstuffs industry; milk ferments for chemical purposes; milk ferments for the food industry; protein [raw material].

5 – Pharmaceuticals; pharmaceutical preparations; veterinary preparations; probiotic preparations; bacterial preparations for medical use; biological preparations for medical use; bacterial preparations for nutritional purposes; biological preparations for nutritional purposes; cultures of micro-organisms for medical and veterinary use; dietetic foods adapted for medical use; dietetic substances adapted for me-

dical use; dietetic beverages adapted for medical use; meal replacements adapted for medical use; dietetic foods adapted for veterinary use; dietetic substances adapted for veterinary use; dietetic beverages adapted for veterinary use; food for babies; food for infants; milk powder for babies; milk powder for infants; dietary supplements; protein dietary supplements; protein supplements for animals; casein dietary supplements; dietary supplements for humans; dietary supplements for animals; vitamins for human consumption; vitamin formulations for human consumption; mineral supplements; mineral supplements for foodstuffs; dietary supplements intended to supplement a normal diet; dietary supplements intended to have health benefits; nutritional additives; nutritional supplements; nutritional cultures (cultures of micro-organisms for medical and veterinary use); probiotic cultures; probiotic substances; sanitary preparations for medical purposes; probiotic preparations for veterinary use; dietetic foods adapted for animal use; dietetic substances adapted for animal use; dietetic beverages adapted for animal use; vitamins for animal consumption; vitamin formulations for animal consumption; feed additives for animals; probiotic cultures for veterinary use; probiotic substances for veterinary use; bacterial cultures; bacteriological preparations for medical and veterinary use; bacterial preparations for medical and veterinary use; vitamin preparations; albuminous preparations for medical purposes; food preparations adapted for medical purposes; food preparations adapted for medical use; lacteal flour; milk sugar (lactose for pharmaceutical purposes); lactose for pharmaceutical purposes; lacteal flour for babies; malted milk beverages for medical purposes; albuminous foodstuffs for medical purposes; nutritional additives for medical purposes; biological preparations for veterinary purposes; amino acids for veterinary purposes; teething (preparations to facilitate).

29 – Milk; milk products; dairy products included in this class; dairy-based beverages; dairy-based powders; UHT (ultra high temperature) milk; ESL (extended shelf life) milk; milk substitutes included in this class; milk concentrate; milk powder; milk protein; cream (dairy products); butter; yoghurt; dessert products included in this class (dairy products predominating); edible oils; edible fats; cheese; whey; meat; fish; poultry; game; preserved fruits; frozen fruits; dried fruits; cooked fruits; preserved vegetables; frozen vegetables; dried vegetables; cooked vegetables; jellies; jams; compotes; meat extracts; eggs; condensed milk; flavoured milk; flavoured milk powder; food spreads consisting principally of dairy products; margarine; blends of butter; milk protein products; milk beverages (milk predominating); flavoured milk beverages (milk predominating); fortified milk beverages (milk predominating); milk powder containing nutritional additives (milk powder predominating); milk powder containing

nutritional supplements (milk powder predominating); yoghurt beverages; flavoured yoghurt; yoghurt based desserts; cheddar cheese; ricotta cheese; parmesan cheese; feta cheese; havarti cheese; haloumi cheese; cottage cheese; cream cheese; soft cheese; hard cheese; cheese products; processed cheese; cheese spreads; blends of edible oils; blends of edible fats; albumin milk; gelatine for food; albumen for food; tofu; bean curd products; cream (whipped); acidophilus milk; kumys (milk beverage); kefir (milk beverage); buttercream; curd; rennet; koumiss (milk beverage); protein for human consumption; fatty substances for the manufacture of edible fats; soya milk; cocoa milk.

(260) AM 2015 78963 A

(800) 1217193

(891) 2014 06 06

(731) AEROPOSTALE PROCUREMENT
COMPANY, INC.

112 W. 34th Street, 22nd Floor, New York
NY 10120, USA

(540)

AERO

(511)

14 – Body jewelry; bracelets; charms; chokers; earrings; jewelry and imitation jewelry; necklaces; rings.

18 – All-purpose athletic bags; all-purpose carrying bags; backpacks; beach bags; book bags; cosmetic bags sold empty; handbags; messenger bags; pocket wallets; pocketbooks; sport bags; tote bags; umbrellas; wallets.

25 – Beach cover-ups; belts; blouses; board shorts; boxer shorts; button down shirts; caps; coats for men and women; collared shirts; fleece bottoms; fleece tops; hats; hooded sweatshirts; hosiery; jackets; jeans; knit shirts; long-sleeved shirts; loungewear; pajamas; panties, shorts and briefs; pants; polo shirts; shirts; shorts; skirts and dresses; socks; sweat pants; sweaters; sweatshirts; swimsuits; t-shirts; tank tops; tights; underwear.

(260) AM 2015 78964 A

(800) 1217224

(891) 2014 05 19

(731) VIENNA INSURANCE GROUP AG Wiener
Versicherung Gruppe

Schottenring 30, A-1010 Vienna, Austria

(540)

DONARIS 
VIENNA INSURANCE GROUP

(591) Black, red, green and white

(511)
36 – Insurance; financial affairs; monetary affairs;
real estate affairs.

(260) AM 2015 78965 A

(800) 1217267

(891) 2013 11 25

(731) UBIMET GmbH

Donau-City-Straße 11, ARES Tower, A-1220
Wien, Austria

(540)

UBIMET

(511)

42 – Scientific and technological services and research and design relating thereto; industrial analysis and research services; design and development of computer hardware and software; updating of computer software; consultancy in the field of energy-saving; information technology [IT] consulting services; consultancy in the design and development of computer hardware; web site design consultancy; providing search engines for the Internet; provision of scientific information, advice and consultancy in relation to carbon offsetting; computer software consultancy; computer system analysis; computer software design; computer system design; chemistry services; physics [research]; digitization of documents [scanning]; chemical analysis; energy auditing; computer programming; geological surveys; surveying; creation of programs for data processing in the area of natural hazard management, meteorology, oceanography, hydrology, climatology and environment; design and development of computer hardware and software in the area of natural hazard management, meteorology, hydrology, oceanography, climate research and environment; design and development of computer software for advertising as well as of computer software for weather, climate, oceanography, hydrology and meteorology; monitoring of computer systems by remote access; chemical research; technical research; research and development of new products for others; geological research; geological prospecting; creating and maintaining web sites for others; graphic arts design; cloud seeding; installation of computer software; data conversion of computer programs and data [not physical conversion]; conversion of data or documents from physical to electronic media; duplication of computer programs; land surveying; server hosting; software as a service [SaaS]; urban planning; technical project studies; research in the field of environmental protection; underwater exploration; rental of computer software; computer rental; rental of web servers; maintenance of computer software; water analysis; meteorological information; scientific research; scientific laboratory services; news services and weather forecast services and computer services, namely providing an online computer database for

weather data as well as in the area of natural hazard management, meteorology, climatology, hydrology, oceanography and life sciences; information about weather and forecasts; scientific information, especially in the area of weather, water, climate and environment; conducting of technical feasibility studies for technical projects related to weather, water and climate conditions; engineering; evaluations, assessments and research through engineers in scientific and technological areas, namely consultancy in the fields of natural hazard management, meteorology, hydrology, oceanography, climatology and environment; scientific research and modeling in the areas of natural hazard management, weather, water, climate and environment and their impact on business activity; scientific and technical consultancy in connection with natural hazard management, weather, water, climate and environment.

(260) AM 2015 78966 A

(800) 1217268

(891) 2013 11 25

(731) UBIMET GmbH

Donau-City-Straße 11, ARES Tower, A-1220
Wien, Austria

(540)

MORECAST

(511)

42 – Scientific and technological services and research and design relating thereto; industrial analysis and research services; design and development of computer hardware and software; providing search engines for the Internet; provision of scientific information, advice and consultancy in relation to carbon offsetting; computer software design; creation of programs for data processing in the area of natural hazard management, meteorology, oceanography, hydrology, climatology and environment; design and development of computer hardware and software in the area of natural hazard management, meteorology, hydrology, oceanography, climate research and environment; computer software for advertising; computer software for weather, climate, oceanography, hydrology and meteorology; news services and weather forecast services and computer services, namely providing an online computer database for weather data in the area of natural hazard management, meteorology, climatology, hydrology, oceanography and life sciences; information about weather and forecasts; information in the area of weather, water, climate and environment, namely information about weather, water, climate and environment; conducting of technical feasibility studies for technical projects related to weather, water and climate conditions; evaluations, assessments and research through engineers in scientific and technological areas, namely consultancy in the fields of natural hazard management, meteorology, hydrology, oceanography

hy, climatology and environment; scientific research and modeling in the areas of natural hazard management, weather, water, climate and environment and their impact on business activity; scientific and technical consultancy in connection with natural hazard management, weather, water, climate and environment.

(260) AM 2015 78967 A

(800) 1217282

(891) 2014 03 17

(731) WORLD MEDICINE İLAÇ SANAYİ VE
TİCARET ANONİM ŞİRKETİ

Evren Mah. Camiyolu Cad. No:50 K:1 B,

Zemin 4-5-6, Güneşli Bağcılar, İstanbul,

Turkey

(540)

BRITOSOPT
БРИТОСОПТ

(591) Black, white

(511)

5 – Medicines for human purposes, medicines for veterinary purposes, vitamin preparations, chemical preparations for medical purposes, dietetic substances adapted for medical use; dietetic foods adapted for medical purposes; baby foods, medicinal herbs, herbal beverages adapted for medical purposes, nutritional supplements, pollen dietary supplements, mineral food supplements, protein dietary supplements; dietary supplements for animals; fodder supplements for veterinary purposes; medicines for dental purposes, hygienic products for medical purposes including sanitary pads, breast-nursing pads and bunion pads, waddings for medical purposes, plasters for medical purposes, dressings for medical purposes, babies' napkins, preparations for destroying noxious plants, preparations for destroying noxious animals, fungicides, deodorants other than for human beings or for animals, air deodorising preparations, disinfectants for hygiene purposes, antiseptics, detergents for medical purposes.

(260) AM 2015 78968 A

(800) 1217291

(891) 2014 03 17

(731) AGREX S.p.A.

Via Balla, 55/57, I-35010 Villafranca

Padovana (Padova), Italy

(540)



(591) Black, white

(511)

7 – Machines and machine tools; machine coupling and transmission components (except for land vehicles); agricultural implements other than hand-operated; spreaders, salt spreaders, fertilizer spreaders (terms too vague in the opinion of the International Bureau – Rule 13(2)(b) of the Common Regulations); cement mixers (excluding cement mix trucks); hammermills; mill mixers (terms too vague in the opinion of the International Bureau – Rule 13(2)(b) of the Common Regulations); cereal dryers; maize degerminators; milling plants.

(260) AM 2015 78971 A

(800) 1217328

(891) 2013 12 18

(731) HYTECK

42 avenue Julien, F-63000 CLERMONT-
FERRAND, France

(540)

AROMA ZONE
EXPERT NATUREL EN SOINS & BEAUTÉ

(591) Purple, light green, dark green and gray

(526) The trademark is protected as a whole. "EXPERT NATUREL EN SOINS & BEAUTÉ" shall not be subject to independent legal protection.

(511)

3 – Bleaching preparations and other substances for laundry use; soaps; perfumes, essential oils, cosmetics, hair lotions; dentifrices; depilatories; make-up removing products; lipstick; beauty masks; shaving products; perfumery; pebbles scented with essential oils; preparations of shower gels, massage gels and soaps including essential oils and vegetable oils in their formulation; vegetable oils and essential oils for cosmetic purposes; essential oils.

5 – Pharmaceutical and veterinary products; sanitary products for medical purposes; dietetic food and substances for medical or veterinary use; food for babies; food supplements for humans and animals; materials for dressings; disinfectants; medicated baths; medicinal herbs; plasters; material for dental fillings and dental impressions; products for destroying vermin; fungicides, herbicides; chemical preparations for medical or pharmaceutical use; herbal teas; parasiticides; natural substances for medical purposes.

11 – Electric diffusers for essential oils.

21 – Utensils and containers for household or kitchen use; combs and sponges; brushes (except paint-brushes); hand-operated cleaning instruments; bottles; toilet utensils or cases; glasses (receptacles); non-electric diffusers for essential oils.

29 – Vegetable oils.

41 – Training in home-made cosmetics, via online training, downloadable recipes and videos, cosme-

tics training workshops and animated training; instruction in the use of essential oils and vegetable oils.

42 – Evaluations and assessments in the fields of science and technology provided by engineers; research and development of new products for others; programming for computers; consultancy relating to computers; styling (industrial design); technical project studies; software development (design); creation and maintenance of web sites for others; conversion of computer programs and data (other than physical conversion); conversion of documents from a physical medium to an electronic medium; hosting of web sites; vehicle roadworthiness testing; design of interior decor; packaging design services; research in the field of cosmetic and aromatherapy formulations for the others; chemical and bacteriological research and analysis; design and development of software for cosmetic and aromatherapy formulations; hosting websites for others for the sale of essential oils, vegetable oils, cosmetics, absolutes and all related products and derivatives.

45 – Agricultural, horticultural and forestry services; medical services; veterinary services; health and beauty treatments for human beings and animals; hospital services; nursing homes; plastic surgery; beauty salons; hairdressing salons; pet grooming; medical aromatherapy services and aromatherapy advice, advice in home-made cosmetics, via online training, downloadable recipes and videos, cosmetic training workshops and animated training.

(260) AM 2015 78973 A

(800) 1217330

(891) 2014 06 16

(731) RED88 PTY LTD

9-13 Bibby Street, CHISWICK NSW 2046,
Australia

(540)



(591) Black, grey

(511)

9 – Computers; tablet computers; computer hardware; computer software; mobile phones; televisions; cables, electronic; compact discs [audio-video].

(260) AM 2015 78977 A

(800) 1217335

(891) 2014 07 10

(731) MONTRES TUDOR SA

Rue François-Dussaud 3, CH-1211 Genève
26, Switzerland

(540)



(591) Black, white

(511)

14 – Fine jewelry, jewelry, timepieces, namely, watches, watch bracelets, components timepieces and accessories for timepieces not included in other classes, alarm clocks, clocks and other chronometric instruments, chronometric instruments, chronographs, apparatus for timing sports events, time measuring and marking apparatus and instruments not included in other classes; dials, cases, housings and boxes for timepieces and jewelry.

35 – Retail sale of timepieces and jewelry articles; advertising for the purchase and sale of timepieces and items of jewelry.

37 – Repair, reconditioning, maintenance and polishing of timepieces and jewelry articles.

(260) AM 2015 78978 A

(800) 1217367

(891) 2014 05 22

(731) VISUAL FAN S.R.L.

Str. Liliacului Nr.16, 500314 BRASOV, Romania

(540)



(591) Red and black

(511)

9 – Scientific, nautical, surveying, photographic, cinematographic, optical, weighing, measuring, signaling, checking (supervision), life-saving and teaching apparatus and instruments; apparatus and instruments for conducting, switching, transforming, accumulating, regulating, or controlling electricity; equipment for recording, transmission or reproduction of sound or images; magnetic data carriers, recording discs; mechanisms for coin-operated apparatus; cash registers, calculating machines, data processing equipment and computers; fire-extinguishing apparatus.

38 – Telecommunications.

(260) AM 2015 78979 A

(800) 1217386

(891) 2014 07 21

(731) PHILIP MORRIS PRODUCTS S.A.

Quai Jeanrenaud 3, CH-2000 Neuchâtel,
Switzerland

(540)

HEATSTICKS

(511)

34 – Tobacco, raw or manufactured; tobacco products, including cigars, cigarettes, cigarillos, tobacco for roll-your-own cigarettes, pipe tobacco, chewing tobacco, snuff tobacco, kretek; snus; tobacco substitutes (not for medical purposes); smokers' articles, including cigarette paper and tubes, cigarette filters, tobacco tins, cigarette cases and ashtrays, pipes, pocket apparatus for rolling cigarettes, lighters; matches; tobacco sticks, heated tobacco products, electronic apparatus that heat cigarettes; electronic smoking apparatus; electronic cigarettes; electronic cigarettes for use as an alternative to traditional cigarettes; electronic nicotine inhalation devices; vaporizing apparatus for tobacco, tobacco products and tobacco substitutes; smokers' articles for electronic cigarettes; chargers, extinguishers and accessories, parts and fittings for use in connection with electronic cigarettes or apparatus for heating tobacco; electronic rechargeable cigarette cases.

(260) AM 2015 79203 A

(800) 1218909

(891) 2014 03 25

(731) WIKIMEDIA FOUNDATION, INC.

149 New Montgomery Street, San Francisco
CA 94105, USA

(540)

**WIKIMEDIA
COMMONS**

(511)

9 – Downloadable software providing access to a collaboratively created and maintained repository of images, sound, text, and other media files; downloadable mobile application to view, upload, and share files to a repository of images, sound, text and other media files; downloadable publications in the nature of images, sound, text, and other media files of an encyclopedic nature.

41 – Arranging and conducting contests and incentive programs for educational purposes; providing a collaboratively created and maintained online repository of images, sound, text, and other media files; providing an online publication in the nature of an interactive index of general knowledge containing images, sound, text, and other media files for educational and entertainment purposes.

42 – Hosting a website featuring open source technology that enables users to view, discuss, edit, and contribute to an online repository of images, sound, text, and other media files; computer services, namely, maintaining an online repository of images, sound, text and other media files.

(260) AM 2015 79204 A

(800) 1218910

(891) 2014 03 25

(731) KONINKLIJKE PHILIPS N.V.

High Tech Campus 5, NL-5656 AE
Eindhoven, Netherlands

(540)

innovation  **you**

(591) Black, white

(511)

3 – Dentifrices; toothpaste; cosmetic tooth whitener; bleaching preparations and tooth whitening kits for cosmetic purposes.

5 – Pharmaceutical and veterinary preparations; sanitary preparations for medical purposes; dental prophylactic paste; dietetic food and substances adapted for medical or veterinary use, food for babies; dietary supplements for humans and animals; plasters, materials for dressings; material for stopping teeth, dental wax; disinfectants; preparations for destroying vermin; fungicides, herbicides; vitamin and mineral preparations; impregnated antiseptic or medicated wipes, moist wipes impregnated with a pharmaceutical lotion, sanitizing wipes, wipes for medical use; breast-nursing pads; inserts for breast shells; infants and babies' disposable napkins made of paper or cellulose; breast shells; sterilized wet wipes; baby diapers; tissues and wipes impregnated with pharmaceutical lotions and creams; milk powder for babies.

7 – Appliances for household purposes not included in other classes, electric blenders, can openers, food processors, fruit presses, mills and mixers (machines); electric knives; kitchen appliances for food not included in other classes; electric dust removing apparatus for cleaning purposes, including vacuum cleaners; vacuum cleaner hoses, vacuum cleaner bags and other parts of vacuum cleaners; ironing machines and ironing presses; parts of the aforesaid goods.

8 – Hand tools and implements (hand-operated); razors; electric and non-electric hair clippers and hair trimmers; scissors to trim hair; nail clippers; depilation appliances, also serving as nose cleaners; electric or non-electric hair-removing tweezers; electric or non-electric nail files; electric or non-electric manicure and pedicure sets; punches for making holes in teats (hand tools); tongs for picking up teats and other objects from a sterilizer; electric irons and steam irons; electric hair stylers; parts of the aforesaid goods.

9 – Scientific, nautical, surveying, photographic, cinematographic, optical, weighing, measuring, signalling, checking (supervision), life-saving and teaching apparatus and instruments; apparatus and instruments for conducting, switching, transforming, accumulating, regulating or controlling electricity;

television apparatus; control apparatus and computer software programs for lighting systems, not included in other classes; light-emitting diodes (leds), led modules fully or partially consisting of integrated leds, oleds, polymer light-emitting diodes; optical control apparatus, thermal control apparatus; apparatus for recording, transmission or reproduction of sound or images; magnetic data carriers, recording discs; compact discs, DVDs and other digital recording media; data processing equipment, computers; computer software; computer mice, data entry apparatus, trackballs, touch pads and joysticks; remote controls and peripheral control devices for personal computers, for media center PC, pointing devices and electronic, infrared and laser pointers, laser sensors, as well as apparatus combining aforesaid functionalities; detectors, chips; operating software for the aforesaid goods; alarms; scales for babies; DECT monitors, thermometers and electronic thermometers, other than for medical purposes, included soother thermometers; anti-radiation garment; downloadable electronic publications, provided online from databases or on the internet, storage media, interactive compact discs and cd-roms; records, tapes, discs, cassettes, cartridges, cards and other similar carriers, all containing or for recording sound, video, data, images, games, text, programs or information; all the aforesaid goods for or relating to babies, young children, pregnant women, breast-feeding mothers and young mothers; computer software programs and software applications for mobile phones and other handheld mobile digital electronic devices, mobile apps; computer programs for accessing, browsing and searching online databases, computer software and firmware, namely operating system programs, data synchronization programs, and application development computer software programs for personal and handheld computers; spectacle frames, eyeglasses, sunglasses; fridge magnets; monitoring apparatus, electric; baby monitors; audio monitors; digital video monitors; monitors (hardware); chargers for electric batteries; battery chargers; batteries and rechargeable batteries; rechargeable battery pack; central processing unit for baby monitor; electric connections for baby monitor; electrical power extension cords; charger stand for parent unit; parts of baby monitors; bath and room thermometers; digital photograph frames; stress meters not for medical use; parts of the aforesaid goods.

10 – Surgical, medical, dental and veterinary instruments and apparatus; clothes especially for operating rooms; lights and lamps for medical, curative, surgical, dental and veterinary use; artificial limbs, eyes and teeth; electric blankets for medical use; ultraviolet and infrared irradiation apparatus, devices and instruments for medical use; x-ray apparatus, tubes, installations and instruments for medical use; hearing instruments; feeding bottles; teats and soothers, including pacifiers, also chains, clips and other

similar holders therefor; teething rings; spoons and medical feeders for administering medicines; incubators for medical purposes; breast pumps; nursing appliances for use in breast feeding, namely, breast shields and nipple protectors; thermometers for medical use; condoms; incubators for babies; commode chairs for babies and children; massage apparatus, electric or non-electric, body and breast massage apparatus; gloves for massage; vibration generating apparatus for massage; pregnancy support belt; babies bottles; disposable feeding bottles; disposable babies bottles; nipple shields; ice pack for medical purposes; breast milk storage bottles, pouches and other similar containers, that also can be frozen or heated; dummies for babies; ear and forehead thermometers for medical use; medical apparatus for removing nasal mucous, namely, external nasal dilators, nasal aspirators, nasal irrigation vessels and nasal lavage vessels; lasers for medical and cosmetic treatment of the face and the skin; skin rejuvenating apparatus, namely, portable laser systems, consisting of a handheld laser for use in cosmetic, medical and dermatological treatment of the face and the skin; dental instruments and tools for polymerization; dental instruments and tools for dental bleaching, or whitening, namely dental curing lights, curing dental bite trays, intra-oral dental lights, parts of the aforesaid goods.

11 – Installations, apparatus and instruments for lighting, heating, steam generating, cooking, refrigerating, freezing, drying, ventilating, water supply and sanitary purposes; electric lamps; humidifying and dehumidifying installations, apparatus and instruments; apparatus and instruments for air conditioning; toasters and hot water tanks; installations for liquefying gases; apparatus and instruments for sterilizing; heaters and warmers for feeding bottles, foodstuffs, liquids and solids; steam generating apparatus to generate steam for ironing purposes, for domestic use; air purifiers and humidifiers; hot water bottles; electric fryers and low-fat fryers; electric hair dryers; electric coffee makers; garment steamers; coolers for breast milk; parts of the aforesaid goods.

21 – Household or kitchen utensils and containers; combs and sponges; brushes (except paint brushes); toothbrushes, finger toothbrush; apparatus for cleaning teeth and gums, for home use; flossing instruments for dental care; apparatus which use water and air for dental care, for home use; brush-making materials; articles for cleaning purposes; glassware, porcelain and earthenware not included in other classes, including figurines and statuettes; cups and vessels adapted for feeding babies and children; spouts for cups, adapted for feeding babies and children; cups for food; containers for use in the sterilization of babies' feeding bottles and closures for such containers; milk powder dispensers; heat

insulated containers for household use, including heat insulated containers for baby feeding bottles; baby food containers; non-spill covers or caps for use with cups; baths and potties for babies; bowls and buckets; drinking vessels; boxes, money boxes; boxes and holders for household use, including for storing, freezing, preserving, transporting and heating of breast milk; thermal and isothermic household containers to keep bottles and cups warm or cool, including insulated containers; insulated and vacuum flasks and vacuum bottles; parts of the aforesaid goods.

35 – Retail services regarding the goods mentioned in the classes 5, 7, 8, 9, 10, 11 and 21; advertising; business management; business administration; office functions.

37 – Building construction; repair; installation services.

41 – Education; providing of training; entertainment; the aforesaid services also delivered by internet and mobile services; sporting and cultural activities.

42 – Scientific and technological services and research and design relating thereto; industrial analysis and research services; design and development of computer hardware and software; online technological services and providing mobile software that enables users of computers and mobile devices to share information and images, to form virtual communities, to engage in social networking and to monitor babies and infants.

44 – Medical services; veterinary services; providing breastfeeding information; provision of health and beauty treatments; teeth whitening services; hygienic and beauty care services for people; nursing home services; providing of respite care; medical advice relating to the welfare of babies, infants, children and mothers; rental of medical equipment; the aforesaid services also delivered by internet and mobile services.

(260) AM 2015 79205 A

(800) 1218929

(891) 2014 06 05

(731) "RIBAMBELLE" SOCIÉTÉ À
RÉSPONSABILITÉ LIMITÉE
oul. Testovskaya, 10, étage 12, RU-123317
Moscou, Russian Federation

(540)



(591) Red, blue, purple, white, black, gray
(511)

16 – Paper, cardboard and goods made from these materials, not included in other classes; printing products; bookbinding material; photographs; stationery; adhesives (glues) for stationery or household purposes; artists' materials; paintbrushes; instructional or teaching material (except apparatus); plastic materials for packaging (not included in other classes); books; pennants (flags) of paper; place mats of paper; tablecloths of paper; towels of paper; handkerchiefs of paper; face towels of paper; labels, not of textile; dish mats of paper or cardboard; stickers [stationery]; packaging materials of cardboard or paper; small bags [envelopes, pouches] of paper or plastics for packaging; bookends; photograph stands; works of art made of paper mâché; silver paper; patterns for dressmaking; stencils; stencil plates; aquarelles; albums; booklets; bookmarkers; pencils; paintbrushes; plastics for modeling; modeling paste; writing materials; school supplies; rubber erasers.

28 – Games, toys.

41 – Education; entertainment; sporting and cultural activities; providing recreation facilities; entertainment; organization of contests [education or entertainment]; training courses stimulating creativity in children; education in connection with development; cooking, floristry, sewing and plastic arts classes; show production; presentation of live performances; amusement parks; cinematographic film projection; providing amusement arcade services; providing sports facilities; toy rental; rental of equipment for games; provision of non-downloadable online electronic publications; game services provided on-line from a computer network; organization of exhibitions for cultural or educational purposes; operating of lotteries.

43 – Services for providing food and drink; restaurants; coffee shops; tea room services.

(260) AM 2015 79206 A

(800) 1218931

(891) 2014 06 12

(731) CHEDDITE S.r.l. con socio unico
Via Del Giaggiolo, 189, I-57124 LIVORNO (LI)
BORNAGHI S.r.l.
Via dei Livelli, I-24047 Treviglio (Bergamo),
Italy

(540)



(591) Black, white

(511)

13 – Firearms; ammunition and projectiles; explosives; fireworks.

(260) AM 2015 79207 A

(800) 1218957

(891) 2014 09 17

(731) SEAT, S.A.

Autovia A-2 km.585, E-08760 Martorell
(Barcelona), Spain

(540)

SEAT TEQTA

(511)

12 – Vehicles, apparatus for locomotion by land, motor vehicles, parts and accessories thereof.

(260) AM 2015 79208 A

(800) 1218963

(891) 2014 08 26

(731) JANSSEN PHARMACEUTICA NV

Turnhoutseweg 30, B-2340 BEERSE,
Belgium

(540)

PRYMABDA

(511)

5 – Pharmaceutical products for human use.

(260) AM 2015 79210 A

(800) 1219043

(891) 2014 03 07

(731) Obshchestvo s ogranichennoy

otvetstvennostyu "SOSTRA"

ul. Tsentralnaya, d. 21, der. Buzharovo,
Istrinsky raion, RU-143514 Moskovskaya
Oblast, Russian Federation

(540)



(591) Black, white

(526) The trademark is protected as a whole. "ПРЕМИУМ" shall not be subject to independent legal protection.

(511)

29 – Meat, fish, poultry and game; eggs; milk and milk products; aloe vera prepared for human consumption; alginates for culinary purposes; anchovy; peanuts, prepared; albumen for culinary purposes; white of eggs; beans, preserved; soya beans, preserved, for food; bouillon; ginger jam; ham; fatty substances for the manufacture of edible fats; toasted laver; edible birds' nests; peas, preserved; mushrooms, preserved; gelatine; meat jellies; jellies for food; fruit jellies; yolk of eggs; coconut fat; bone oil, edible; lard; suet for food; fruit-based snack food; charcuterie; raisins; caviar; fish roe, prepared; yogurt; sauerkraut; kephir [milk beverage]; isinglass for food; clams, not live; milk shakes; black pudding

[blood sausage]; meat, tinned [canned (Am.)]; vegetables, tinned [canned (Am.)]; fish, tinned [canned (Am.)]; fruits, tinned [canned (Am.)]; bouillon concentrates; gherkins; shrimps, not live; prawns, not live; buttercream; croquettes; silkworm chrysalis, for human consumption; kumys [kumyss] [milk beverage]; spiny lobsters, not live; lecithin for culinary purposes; salmon; onions, preserved; margarine; piccalilli; marmalade; edible oils; peanut butter; cocoa butter; coconut oil; coconut butter; corn oil; sesame oil; linseed oil for culinary purposes; olive oil for food; palm oil for food; palm kernel oil for food; sunflower oil for food; colza oil for food; butter; shellfish, not live; almonds, ground; animal marrow for food; mussels, not live; soya milk [milk substitute]; fish meal for human consumption; vegetable mousses; fish mousses; fruit pulp; meat, preserved; milk beverages, milk predominating; potato fritters; olives, preserved; lobsters, not live; coconut, desiccated; nuts, prepared; tomato purée; liver pâté; pectin for culinary purposes; liver; pickles; jams; powdered eggs; foods made from fish; curd; poultry, not live; pollen prepared as foodstuff; cranberry sauce [compote]; apple purée; crayfish, not live; crustaceans, not live; fish, preserved; fish, not live; salted fish; vegetable salads; fruit salads; bacon; sardines; pork; herrings; seeds, prepared; sunflower seeds, prepared; cream [dairy products]; whipped cream; fat-containing mixtures for bread slices; tomato juice for cooking; vegetable juices for cooking; salted meats; sausages; sausages in batter; preparations for making bouillon; preparations for making soup; tripe; soups; vegetable soup preparations; whey; cheese; tahini [sesame seed paste]; tofu; sea-cucumbers, not live; truffles, preserved; tuna fish; oysters, not live; milk ferments for culinary purposes; rennet; fish fillets; dates; crystallized fruits; frozen fruits; fruit preserved in alcohol; potato flakes; hummus [chickpea paste]; fruit peel; preserved garlic; lentils, preserved; potato chips; low-fat potato chips; fruit chips; non-alcoholic eggnog; seaweed extracts for food; snail eggs for consumption; meat extracts; preserved, frozen, dried and cooked fruits and vegetables; jellies, jams, compotes; edible oils and fats; ajvar [preserved peppers]; albumin milk; kimchi [fermented vegetable dish].

30 – Coffee, tea, cocoa and artificial coffee; rice; ice cream; yeast, baking-powder; salt; mustard; spices; flavorings [flavourings], other than essential oils, for cakes; flavorings [flavourings], other than essential oils, for beverages; coffee flavorings [flavourings]; flavorings, other than essential oils; star aniseed; high-protein cereal bars; pancakes; noodle-based prepared meals; buns; bread rolls; vanillin [vanilla substitute]; vanilla [flavoring] [flavouring]; waffles; vermicelli [noodles]; natural sweeteners; sausage binding materials; binding agents for ice cream [edible ices]; sea water for cooking; seaweed [condiment]; malt biscuits; cloves [spice]; cake frosting

[icing]; glucose for culinary purposes; gluten additives for culinary purposes; thickening agents for cooking foodstuffs; leaven; rice-based snack food; cereal-based snack food; vegetal preparations for use as coffee substitutes; dressings for salad; fruit jellies [confectionery]; confectionery for decorating Christmas trees; cakes; pastries; peanut confectionery; almond confectionery; pasta; ginger [spice]; frozen yogurt [confectionery ices]; capers; caramels [candy]; curry [spice]; ketchup [sauce]; quiches; gluten prepared as foodstuff; sweetmeats [candy]; liquorice [confectionery]; peppermint sweets; cinnamon [spice]; unroasted coffee; starch for food; crackers; custard; hominy grits; semolina; oatmeal; crushed barley; groats for human food; corn, milled; corn, roasted; meat pies; couscous [semolina]; farinaceous foods; noodles; ice, natural or artificial; edible ices; candy; rice cakes; mayonnaise; macarons [pastry]; macaroni; maltose; hominy; marinades; marzipan; royal jelly; bean meal; corn flour; flour; wheat flour; soya flour; barley meal; dessert mousses [confectionery]; chocolate mousses; muesli; mint for confectionery; cocoa beverages with milk; coffee beverages with milk; coffee-based beverages; tea-based beverages; chocolate beverages with milk; chocolate-based beverages; cocoa-based beverages; infusions, not medicinal; crushed oats; husked oats; nutmegs; stick liquorice [confectionery]; soya bean paste [condiment]; pastilles [confectionery]; molasses for food; pepper; allspice; peppers [seasonings]; pesto [sauce]; cookies; petit-beurre biscuits; pies; pizzas; meat gravies; fondants [confectionery]; popcorn; powders for ice cream; mustard meal; pralines; meat tenderizers, for household purposes; flour-milling products; oat-based food; propolis; gingerbread; petits fours [cakes]; puddings; cake powder; fruit coulis [sauces]; ravioli; chewing gum; relish [condiment]; wheat germ for human consumption; spring rolls; aniseed; linseed for human consumption; golden syrup; confectionery; baking soda [bicarbonate of soda for cooking purposes]; malt for human consumption; salt for preserving foodstuffs; cooking salt; celery salt; sorbets [ices]; ham glaze; soya sauce; tomato sauce; sauces [condiments]; spaghetti; seasonings; preparations for stiffening whipped cream; rusks; breadcrumbs; sushi; sandwiches; tabbouleh; tacos; cream of tartar for culinary purposes; tarts; almond paste; tortillas; garden herbs, preserved [seasonings]; beer vinegar; ferments for pastes; halvah; bread; unleavened bread; chips [cereal products]; corn flakes; oat flakes; chicory [coffee substitute]; iced tea; chutneys [condiments]; cheeseburgers [sandwiches]; chow-chow [condiment]; saffron [seasoning]; chocolate; malt extract for food; essences for foodstuffs, except etheric essences and essential oils; husked barley; tapioca and sago; flour and preparations made from cereals; bread, pastry and confectionery; sugar, honey, treacle; vinegar, sauces [condiments]; ice for refreshment; aromatic prepara-

tions for food; sponge cakes; cocoa; turmeric; tapioca flour; potato flour; cake dough.

31 – Grains [seeds]; animal foodstuffs; peanuts, fresh; druff; beans, fresh; wreaths of natural flowers; grapes, fresh; algae for human or animal consumption; fruit residue [marc]; dog biscuits; peas, fresh; mushroom spawn for propagation; mushrooms, fresh; trees; palm trees; turf, natural; unsawn timber; undressed timber; yeast for animal consumption; Christmas trees; edible chews for animals; menagerie animals; peanut cake for animals; oil cake; maize cake for cattle; rape cake for cattle; bagasses of cane [raw material]; cereal seeds, unprocessed; grains [cereals]; grains for animal consumption; lime for animal forage; fish spawn; cocoa beans, raw; potatoes, fresh; chestnuts, fresh; copra; raw barks; rough cork; pet food; stall food for animals; bird food; strengthening animal forage; chicory roots; roots for food; nettles; groats for poultry; maize; sesame; shrubs; rose bushes; spiny lobsters, live; lemons, fresh; vine plants; onions, fresh vegetables; flower bulbs; leeks, fresh; olives, fresh; products for animal litter; bran mash for animal consumption; shellfish, live; almonds [fruits]; mussels, live; peanut meal for animals; linseed meal for animal consumption; meal for animals; flax meal [fodder]; rice meal for forage; fish meal for animal consumption; straw mulch; beverages for pets; oats; vegetables, fresh; cucumbers, fresh; lobsters, live; nuts [fruits]; coconuts; kola nuts; bran; distillery waste for animal consumption; residue in a still after distillation; palms [leaves of the palm tree]; cuttle bone for birds; peppers [plants]; aromatic sand for pets [litter]; locust beans; mash for fattening livestock; animal fattening preparations; preparations for egg laying poultry; fishing bait, live; by-products of the processing of cereals, for animal consumption; seed germ for botanical purposes; poultry, live; wheat; pollen [raw material]; crayfish, live; crustaceans, live; seedlings; plants; aloe vera plants; plants, dried, for decoration; rice, unprocessed; rye; wheat germ for animal consumption; fish, live; lettuce, fresh; linseed for animal consumption; hay; coconut shell; bred stock; sanded paper for pets [litter]; malt for brewing and distilling; straw [forage]; straw litter; salt for cattle; trunks of trees; wood chips for the manufacture of wood pulp; litter peat; garden herbs, fresh; sea-cucumbers, live; sugarcane; truffles, fresh; oysters, live; fruit, fresh; hazelnuts; fodder; hops; flowers, dried, for decoration; silkworms; lentils, fresh; pine cones; hop cones; spinach, fresh; berries, fresh fruits; juniper berries; eggs for hatching, fertilised; silkworm eggs; barley; grains and agricultural, horticultural and forestry products not included in other classes; live animals; fresh fruits and vegetables; natural plants and flowers; algarovilla for animal consumption; malt; oranges, fresh; citrus fruit, fresh; rhubarb, fresh; beet, fresh; squashes, fresh; chicory, fresh.

(260) AM 2015 79211 A
 (800) 1219051
 (891) 2014 08 07
 (731) SHANDONG KERUI PETROLEUM
 EQUIPMENT CO., LTD.
 Kesan Road, Shengli Industrial Park, Dong-
 ying City, 257067 Shandong Province, China
 (540)



(591) Blue and green
 (526) The trademark is protected as a whole.
 "GROUP" shall not be subject to independent legal
 protection.
 (511)
 1 – Nitrogen; nitric monoxide; nitrous oxide; dry ice
 (carbon dioxide).

(260) AM 2015 79213 A
 (800) 1219066
 (891) 2014 03 31
 (731) WORLD MEDICINE İLAÇ SANAYİ VE
 TİCARET ANONİM ŞİRKETİ
 Evren Mah. Camiyolu, Cad. No:50 Kat 1 B
 Zemin 4-5-6, Güneşli/Bağcılar, İstanbul,
 Turkey

(540)
UNAFIL
УНАФИЛ

(591) Black, white
 (511)
 5 – Medicines for human purposes, medicines for
 veterinary purposes, vitamin preparations, chemical
 preparations for medical purposes, dietetic substan-
 ces adapted for medical use; dietetic foods adapted
 for medical purposes; baby foods, medicinal herbs,
 herbal beverages adapted for medical purposes, nut-
 ritional supplements, pollen dietary supplements,
 mineral food supplements, protein dietary supple-
 ments; dietary supplements for animals; fodder sup-
 plements for veterinary purposes; medicines for den-
 tal purposes, hygienic products for medical purposes
 including sanitary pads, breast-nursing pads and
 bunion pads, wadding for medical purposes, plasters
 for medical purposes, dressings for medical purpo-
 ses, babies' napkins, preparations for destroying no-
 xious plants, preparations for destroying noxious
 animals, fungicides, deodorants other than for hu-
 man beings or for animals, air deodorising prepara-
 tions, disinfectants for hygiene purposes, antiseptics,
 detergents for medical purposes.

(260) AM 2015 79214 A
 (800) 1219132
 (891) 2014 03 14
 (731) ONTEX, besloten vennootschap met beperkte
 aansprakelijkheid
 Genthof 5, B-9255 Buggenhout, Belgium
 (540)

ONTEX

(511)
 5 – Sanitary preparations for medical purposes, in-
 cluding products for personal care and hygiene; for
 menstrual hygiene items (terms considered too va-
 gue by the International Bureau – rule 13.2.b) of the
 Common Regulations); including sanitary napkins,
 panty liners, tampons, tampon applicators and mens-
 trual shorts; wet wipes for hygienic use included in
 this class; incontinence diapers; incontinence briefs;
 pads for medical or hygienic purposes; cotton wool
 and cotton swabs for medical or hygienic purposes
 included in this class; disposable baby diapers; dis-
 posable nappies; disposable diapers and pants of
 paper and cellulose.

16 – Tissue paper and/or cellulose included in this
 class; coasters made of paper and/or cellulose for
 changing diapers.

(260) AM 2015 79215 A
 (800) 1219133
 (891) 2014 03 14
 (731) ONTEX, besloten vennootschap met beperkte
 aansprakelijkheid
 Genthof 5, B-9255 Buggenhout, Belgium
 (540)



(591) Various shades of blue, white

(511)
 5 – Sanitary preparations for medical purposes, in-
 cluding products for personal care and hygiene; for
 menstrual hygiene items (terms considered linguisti-
 cally incorrect by the International Bureau – rule
 13(2)(b) of the Common Regulations); including sa-
 nitary napkins, panty liners, tampons, tampon app-
 licators and menstrual shorts; wet wipes for hygienic
 use included in this class; incontinence diapers; in-
 continence briefs; pads for medical or hygienic pur-
 poses; cotton wool and cotton swabs for medical or
 hygienic purposes included in this class; disposable
 baby diapers; disposable nappies; disposable diapers
 and pants of paper and cellulose.

16 – Tissue paper and/or cellulose included in this
 class; coasters made of paper and/or cellulose for
 changing diapers.

(260) AM 2015 79216 A
 (800) 1219141
 (891) 2014 04 07
 (731) RESPEKT INVESTMENTS AG
 c/o Markus Rickli, Bälliz 67, CH-3600 Thun,
 Switzerland
 (540)

BITARGET

(511)
 9 – Software, in particular software for providing access to platforms on the Internet regarding the conclusion of commercial transactions in the field of on-line advertising for others (e-commerce platforms on the Internet) and computer software for creating and designing websites and platforms on the Internet regarding the conclusion of commercial transactions in the field of advertising services for others (e-commerce platforms on the Internet); computer programs; operating system programs; computer programs for mobile devices.

35 – Advertising for others, in particular advertising on the Internet, advertising services via the Internet and advertising for commercial websites; dissemination of advertisements, in particular dissemination of advertisements for others via the Internet; dissemination of commercial transactions in the field of advertising for others, in particular via Internet platforms or within the framework of e-commerce.

38 – Distribution and transmission of information, including websites, computer programs and any other data via computer networks and the Internet; providing access to platforms on the Internet regarding the conclusion of commercial transactions in the field of on-line advertising services for others (e-commerce platforms on the Internet).

42 – Design, development, creation, programming and updating of computer programs, operating system programs and computer programs for mobile devices; design and creation of websites and Internet platforms, in particular Internet platforms and websites regarding the conclusion of commercial transactions in the field of on-line advertising services for others (e-commerce platforms on the Internet); design, creation, development, programming and updating of computer software, in particular for creating and designing websites and platforms on the Internet regarding the conclusion of commercial transactions in the field of on-line advertising for others (e-commerce platforms on the Internet); research for the design, creation, development, programming and updating of computer software, in particular for creating and designing websites and platforms on the Internet regarding the conclusion of commercial transactions in the field of on-line advertising for others (e-commerce platforms on the Internet).

(260) AM 2015 79218 A
 (800) 1219152
 (891) 2014 03 31
 (731) WORLD MEDICINE İLAÇ SANAYİ VE
 TİCARET ANONİM ŞİRKETİ
 Evren Mah., Camiyolu Cad. No.50 K.1
 B Zemin 4-5-6, GÜNESLİ/BAGCILAR/İS-
 TANBUL, Turkey
 (540)

TAMOVIR TAMOVİR

(591) Black, white

(511)

5 – Medicines for human purposes, medicines for veterinary purposes, vitamin preparations, chemical preparations for medical purposes, dietetic substances adapted for medical use; dietetic foods adapted for medical purposes; baby foods, medicinal herbs, herbal beverages adapted for medical purposes, nutritional supplements, pollen dietary supplements, mineral food supplements, protein dietary supplements; dietary supplements for animals; fodder supplements for veterinary purposes; medicines for dental purposes, hygienic products for medical purposes including sanitary pads, breast-nursing pads and bunion pads, waddings for medical purposes, plasters for medical purposes, dressings for medical purposes, babies' napkins, preparations for destroying noxious plants, preparations for destroying noxious animals, fungicides, deodorants other than for human beings or for animals, air deodorising preparations, disinfectants for hygiene purposes, antiseptics, detergents for medical purposes.

(260) AM 2015 79219 A
 (800) 1219155
 (891) 2014 03 31
 (731) WORLD MEDICINE İLAÇ SANAYİ VE
 TİCARET ANONİM ŞİRKETİ
 Evren Mah., Camiyolu Cad. No:50 K:1 B,
 Zemin 4-5-6, Güneşli Bağcılar, İstanbul,
 Turkey
 (540)

FEMTA ΦEMTA

(591) Black, white

(511)

5 – Medicines for human purposes, medicines for veterinary purposes, vitamin preparations, chemical preparations for medical purposes, dietetic substances adapted for medical use; dietetic foods adapted for medical purposes; baby foods, medicinal herbs, herbal beverages adapted for medical purposes,

nutritional supplements, pollen dietary supplements, mineral food supplements, protein dietary supplements; dietary supplements for animals; fodder supplements for veterinary purposes; medicines for dental purposes, hygienic products for medical purposes including sanitary pads, breast-nursing pads and bunion pads, waddings for medical purposes, plasters for medical purposes, dressings for medical purposes, babies' napkins, preparations for destroying noxious plants, preparations for destroying noxious animals, fungicides, deodorants other than for human beings or for animals, air deodorising preparations, disinfectants for hygiene purposes, antiseptics, detergents for medical purposes.

(260) AM 2015 79225 A

(800) 1219171

(891) 2014 05 07

(731) EUROL B.V.

Energiestraat 12, NL-7442 DA NIJVERDAL,
Netherlands

(540)



(591) Blue red

(526) The trademark is protected as a whole. "LUBRICANTS" shall not be subject to independent legal protection.

(511)

1 – Chemical products for industrial and/or manufacturing purposes; cleaning fuel additives, chemical additives for fuels, lubricants and greases; additives for increasing the cetane number of diesel fuel; anti-freeze; antifreeze chemicals; chemical antifreeze additives for fuels, antifreeze, including for cooling systems of vehicles; dewatering fluids; degreasers for use in manufacturing processes; hydraulic fluids and hydraulic and bio-hydraulic oils, in this class; brake fluids; hydraulic brake fluids; hydraulic transmission fluids; fluids for hydraulic equipment; de-icing compounds; heat transfer fluids; clutch fluids; brake fluids; cutting oils; metalworking fluids [other than cutting fluids]; coolants; solvents, products for the safekeeping of metal or wood; transmission fluids; chemical preparations for distribution of oil, grease and petroleum; fluids and oils for the removal of lime, brine, scale, mortar oil, fats, waxes, inks, carbon, dirt, mildew, mould, grime and stains; chemical products for the treatment of cooling systems; fluids for hydraulic steering systems; radiator sealer; radiator flushing agents; sealants for leaks in power steering systems of cars; power steering (liquids); organic liquids for use in vacuum pumps; battery fluid, acidified water for batteries.

3 – Cleaners included in this class; detergents and degreasers other than for use in manufacturing processes; abrasives; cleansing oils; rust removing preparations; detergents; waxes (polishes); windscreen shampoo; liquids for cleaning vehicle windows; hand cleaners.

4 – Industrial oils and greases; lubricants; lubricating oils and fats; oils, especially oils for motor vehicles, including synthetic oils for motor vehicles, semi – synthetic oils for vehicles, oils for motorcycles, tractor oil, truck oil, oil for ship engines, oil for machinery and installations, racing oils, mono-grade oil, diesel oil, transmission oil, gearbox oil, power steering oils, synthetic transmission oils, two stroke oil, mono-grade oils, mineral based oils, air conditioning oils, chainsaw oils, vacuum pump oils, hydraulic and bio-hydraulic oils insofar in this class, gear case oils, oils for turbines; metal treatment means with lubricating properties; metal treatment liquids in the form of oils; oils for metal treatment; cutting oils for industrial metal treatment; industrial cooling lubricants; food grade oils; nontoxic oils including nontoxic grease for food machinery, compressor oils, including synthetic compressor oils, non-chemical additives for fuels, lubricants and greases, including non-chemical antifreeze additives; chain oils; high temperature lubricants; guide way oils; heat transfer oils; paraffinic oils.

(260) AM 2015 79256 A

(800) 1219639

(891) 2014 08 14

(731) NANAN SHIYING CLOTHING CO., LTD
No.9 Qingshuiyan, Guoqian Village, Shijing
Town, Nanan City, Fujian, China

(540)

Dear lover

(591) Black, white

(511)

25 – Underwear; underpants; pajamas; footwear; bathing suits; hats; hosiery; gloves.

(260) AM 2015 79257 A

(800) 1219643

(891) 2014 02 20

(731) Borsa İstanbul Anonim Şirketi
Teşitpaşa Mahallesi, Tuncay Artun Caddesi,
Emirgan, TR-34467 İstanbul, Turkey

(540)

BIST

(591) Black, white

(511)

35 – Provision of information, prices and statistical information within the scope of the stock exchange

services along with any other calculation relating to economic and financial data, recording and saving the same in a database; collection, arrangement and systematization of the foregoing in a database; computer aided processing of information relating to the stock exchange; information and research for trading activities; collection of trading information; services of trade value assessment; information and consultancy services for the foregoing services; price analysis services; economic forecast services.

36 – Providing services for trading capital market instruments, foreign exchange, precious metals and precious stones and other contracts, documents and assets deemed appropriate by the capital markets' regulator; distribution and publication of the established prices; services for matching the buy-sell orders or facilitating such matching; services for operating and/or managing the systems and regulated markets to that end; formation, calculation and publication of the indexes for the traded capital market instruments; compilation, custody, process and submission of all data related to the indexes; banking services; financial management services; financial analysis services; financial sponsorship services; information services for financial matters; financial consultancy services; underwriting business; stock exchange services; electronic stock exchange services; clearing and safe custody services; intermediary services for the purchase and sale of securities; services for the issue of financial products; services for portfolio management; computer aided analysis of the value of securities and index; formation, calculation and publication of the indexes for the securities traded on the stock exchange, distribution and publication of the price information, statistical data, index data, clearing and safe custody data, data relating to the intermediation activities that are related with the securities; computer aided financial services; organizational consultancy services relating to the services included in this class; provision of financial information through a computer database.

(260) AM 2015 79260 A

(800) 1219650

(891) 2014 05 28

(731) AVON PRODUCTS, INC.

777 Third Avenue, New York NY 10017,
USA

(540)

CUCINA DONNA

(511)

21 – Baking ware, baskets, basting spoons, beverage glassware, beverage stirrers, bottle openers, bottle squeegees, bowls, bread boards, bread boxes, brooms, brushes for basting meat, buckets, butter dishes, candle holders, candle snuffers, canister sets, carafes, carver rests, carving boards, dishes, cheese

graters, cinder sifters for household use, sponges for household use, cups, non-electric coffee pots, coffee stirrers, colanders for household use, cold packs used to keep food and drink cold, confectioners' moulds, containers for foods, containers for household or kitchen use, cookery moulds, cookie cutters, cookie jars, cookie sheets, cooking pots, cooking skewers, cooking ware, creamer pitchers, cutting boards, decanters, dinnerware, dish covers, dish drying racks, dish stands, drinking glasses, dust bins, dust pans, Dutch ovens, frying pans, household and/or kitchen utensils, mugs; non-electric coffee makers, percolators, egg beaters, griddles, juicers, kettles, pressure cookers, cooking saucepans, woks; salt and pepper shakers, recipe boxes, salad bowls, platters, pot lids, napkin holders, napkin rings, toothpick holders, towel holders, towel racks, trivets, troughs, vegetable mashers, whisks.

(260) AM 2015 79261 A

(800) 1219677

(891) 2014 04 14

(731) Beachbody, LLC

Third Floor, 3301 Exposition Blvd., Santa
Monica CA 90404, USA

(540)



(591) Black, white

(511)

9 – Pre-recorded DVDs, and CDs, featuring exercise, fitness, and dietary information instruction; downloadable, interactive multimedia computer software featuring audio, audiovisual and video training information on the subject of physical exercise, physical exercise equipment, diet and nutrition, and pictures, images, text, and photos related thereto; downloadable electronic game software.

41 – Providing a web site featuring on-line instruction in the field of physical exercise and nutrition and tracking progress of workouts; educational services and on-line educational services, namely, providing instruction in the fields of exercise equipment, physical exercise and nutrition, and instructional materials distributed in connection therewith; physical fitness training services, namely, tracking progress of workouts for others; entertainment services, namely, conducting contests; education and entertainment services, namely, providing a website featuring non-downloadable musical performances, musical videos, related audio, video and film clips, photographs, and other multimedia materials featur-

ring information in the field of exercise and physical fitness; educational services, namely, providing web-based, classroom and other training in the field of exercise equipment, physical fitness, diet and nutritional programs for certification of and continuing education for instructors and distribution of training material in connection therewith; educational services, namely, conducting classes, seminars, conferences, workshops, and field trips in the field of exercise equipment, diet and nutritional programs, and sales techniques and distribution of training material in connection therewith; membership club services, namely, providing training to members in the field of exercise equipment, diet and nutritional programs, and sales techniques; educational services, namely, offering of assessments and surveys in the field of educator training and performance for the purpose of improving teaching procedures; physical fitness training services and consultancy; providing information in the field of exercise training.

(260) AM 2015 79262 A
 (800) 1219680
 (891) 2014 03 26
 (731) EGIS Gyógyszergyár Zrt.
 Keresztúri út 30-38, H-1106 Budapest,
 Hungary
 (540)

AMEHT

(591) Black, white
 (511)
 5 – Human pharmaceutical preparations for the treatment diseases and disorders of the central nervous system or oncological and immune system related diseases and disorders.

(260) AM 2015 79263 A
 (800) 1219719
 (891) 2014 06 23
 (731) LODESTAR ANSTALT
 (a Liechtenstein company)
 Lova-Center, PO Box 1150, FL-9490 Vaduz,
 Liechtenstein
 (540)

UNTAMED REVOLUTIONARY RUM

(511)
 33 – Alcoholic beverages (except beer); distilled spirits; rum; whiskey; vodka; gin; distilled beverages; liqueurs; cocktails.

(260) AM 2015 79264 A
 (800) 1219740
 (891) 2014 07 08

(731) AHMED ELAFIFI
 Schwindgasse 19/17, A-1040 Vienna, Austria
 (540)

TRANQUINI

(511)
 5 – Dietary supplement beverages.
 32 – Non-alcoholic beverages.

(260) AM 2015 79266 A
 (800) 571835
 (891) 2014 07 04
 (731) ALLEGRINI SOCIETA' AGRICOLA
 SEMPLICE DI ALLEGRINI FRANCO,
 ALLEGRINI MARIA & C.
 Via Giare, 9/11, I-37022 FUMANE (VR), Italy
 (540)

ALLEGRINI

(511)
 33 – Wine, spirits, liqueurs.

(260) AM 2015 79269 A
 (800) 779181
 (891) 2014 06 19
 (731) SKY NETWORK MANAGEMENT
 COMPANY B.V.
 Bornhout 15, NL-1046 BE Amsterdam,
 Netherlands
 (540)



The logo features the words "SKY NET" in a large, bold, italicized sans-serif font. Below it, the words "WORLDWIDE EXPRESS" are written in a smaller, bold, sans-serif font, all contained within a thick, black horizontal bar.

(591) Black, white
 (526) WORLDWIDE EXPRESS
 (511)
 39 – Transport.

(260) AM 2015 79270 A
 (800) 961678
 (891) 2014 09 08
 (731) OJON CORPORATION
 767 Fifth Avenue, New York, NY 10153, USA
 (540)



The logo consists of a large, solid black circle positioned above the word "Ojon" in a lowercase, serif font.

(591) Black, white
 (511)
 3 – Hair care preparations; non-medicated skin care preparations; body and beauty care cosmetics.

(260) AM 2015 79271 A
(800) 994539
(891) 2014 07 02
(731) Modern Times Group MTG AB
P.O. Box 2094, SE-103 13 Stockholm, Sweden
(540)

VIASAT

(511)
35 – Advertising and promotional services; business management; business consultancy; management consultancy; business administration; rental of advertising space; provision of television advertising commercials, provision of radio advertising commercials; provision of advertising space/time for sponsors; rental of advertising space on the Internet; production of filmed/graphic advertising material for use in marketing or sponsorship; provision of information, advisory and consultancy services relating to advertising and promotional services; provision of information, advisory and consultancy services relating to organization, operation and supervision of sales and promotional incentive schemes; provision of information, advisory and consultancy services relating to rental of advertising space, television advertising commercials, radio advertising commercials, preparation and presentation of audiovisual displays for advertising purposes, dissemination of advertising matter and the arranging and conducting of trade shows and exhibitions; compilation of business statistics and commercial information; marketing studies; business planning, inspection, surveys and appraisal services; provision of business information; compilation and provision of computerized business information data; compilation of business statistics and commercial information, all relating to television, radio and satellite broadcasting; advisory and information services relating to the aforesaid.

38 – Cable, satellite and terrestrial television broadcasting; television, Internet and radio broadcasting; computer aided transmission of messages and images; satellite transmission; telecommunication; provision of information about telecommunication; rental of telecommunications, communications and broadcasting apparatus; provision of user access to telecommunication networks; provision of information about broadcasting via the Internet; professional consultancy services relating to television and radio broadcasting, transmission and communication services; provision of information, advisory and consultancy services relating to broadcasting and transmission of radio or television programs or computer aided transmission of messages and images; provision of information, advisory and consultancy services relating to communications services by satellite, television and radio; provision of information, advisory and consultancy services relating to news agency services; provision of information, advisory and consultancy services relating to hiring and rental

of communications apparatus and the provision of telecommunications links to computer databases and websites on the Internet; provision of information, advisory and consultancy services relating to telecommunications services dedicated to retailing goods through interactive communications with customers; provision of information, advisory and consultancy services relating to interactive television broadcasting services; provision of information, advisory and consultancy services relating to broadcasting and transmission of interactive television, interactive entertainment and interactive competitions; provision of information services relating to the aforesaid.

41 – Amusement, education and entertainment services including television and radio entertainment; production and performing of shows, theatre and other amusement performances; film, radio and video production; provision of film studios; recording studios and recording studio services; production of radio and television programmes; information regarding amusement, education and entertainment services; rental of movies, videotapes, DVDs and radio and television programmes; provision of information, advisory and consultancy services relating to education and entertainment services; provision of information, advisory and consultancy services relating to education and entertainment provided on-line and/or via the Internet; provision of information, advisory and consultancy services relating to television and radio entertainment services; provision of information, advisory and consultancy services relating to entertainment and education services provided on-line and/or via an interactive television platform; provision of information, advisory and consultancy services relating to interactive games, interactive entertainment and interactive competitions; provision of information, advisory and consultancy services relating to betting, gaming and gambling services; organization of conferences, lectures and symposiums relating to television and radio; provision of information, advisory and consultancy services relating to television viewing guide services; information services related to the aforesaid.

(260) AM 2015 79272 A
(800) 1021564
(891) 2014 07 02
(731) GALENIKA a.d.
Batajnički drum bb, 11080 ZEMUN-BEOGRAD,
Serbia
(540)

Bensedin

(591) Black, white
(511)
5 – Pharmaceutical products.

(260) AM 2015 79274 A
 (800) 1076107
 (891) 2014 09 30
 (731) ERBOZETA S.P.A.
 Strada delle Seriole, 41/43, 47894
 Chiesanuova, San Marino
 (540)



(591) Grey, white
 (511)

5 – Pharmaceutical and veterinary products; sanitary products for medical purposes; dietetic substances adapted for medical use, food for babies; plasters, materials for dressings; material for dental fillings and dental impressions; disinfectants; pesticides; fungicides, herbicides.

(260) AM 2015 79275 A
 (800) 1117127
 (891) 2014 07 07
 (731) CARPE DIEM GmbH & Co KG
 Trademark Department, Am Brunnen 1,
 A-5330 Fuschl am See, Austria
 (540)

CARPE DIEM

(511)
 32 – Non-alcoholic beverages, fruit drinks, fruit juices, lemonades, refreshing drinks including beverages containing tea, sugar, sucrose, glucose, fructose, yeast and lactic acid; energy drinks, isotonic, hypertonic and hypotonic drinks (for use and/or as required by athletes); whey beverages; mineral and aerated waters; syrups, essences and other preparations for making beverages as well as effervescent tablets and effervescent powders for drinks and non-alcoholic cocktails; beer, nutrient beer, malt beer, wheat beer, porter, ale, stout and lager; non-alcoholic malt beverages; kvass (rye-based fermented drink).

(260) AM 2015 79277 A
 (800) 1135648
 (891) 2014 09 30
 (731) DANSK LANDBRUGS
 GROVVARESELSKAB A.M.B.A.
 Vesterbrogade 4A, DK-1620 København V,
 Denmark
 (540)

Vilofoss

(511)
 1 – Chemicals used in industry, science and photography, as well as in agriculture, horticulture and forestry; unprocessed artificial resins, unprocessed plastics; manures; fire extinguishing compositions; tempering and soldering preparations; chemical substances for preserving foodstuffs; tanning substances; adhesives used in industry.

5 – Pharmaceutical and veterinary preparations; sanitary preparations for medical purposes; dietetic food and substances adapted for medical or veterinary use, food for babies; dietary supplements for humans and animals; plasters, materials for dressings; material for stopping teeth, dental wax; disinfectants; preparations for destroying vermin; fungicides, herbicides.

(260) AM 2015 79278 A
 (800) 1153463
 (891) 2014 06 30
 (731) NOVARTIS AG
 CH-4002 Basel, Switzerland
 (540)

PAZEO

(511)
 5 – Ophthalmic preparations.

(260) AM 2015 79280 A
 (800) 1219816
 (891) 2014 06 11
 (731) GUESS? IP HOLDER L.P.
 1444 South Alameda Street Los Angeles
 CA 90021, USA
 (540)

MARCIANO

(511)
 35 – Retail store services and online retail store services in the field of men's, women's and children's apparel and personal accessories.

(260) AM 2015 79385 A
 (800) 1220911
 (891) 2014 02 07
 (731) WILHELMSEN SHIPS SERVICE AS
 Strandveien 20, N-1366 Lysaker NO, Norway
 (540)

UNITOR

(511)
 1 – Chemicals used in industry and science; chemicals and gases for use in marine and/or maritime industry; industrial gases and refrigerants; cleaning and de-greasing chemicals; chemicals for treating water; chemicals for treating oils and gases; inert gases; unprocessed artificial resins, unprocessed plas-

tics; fire extinguishing compositions, including fire extinguishing gases, foams, powders and liquids; fireproofing and flame resistant preparations; chemical spill solutions; surface-active chemical agents; chemical products for industrial removal of corrosion and contamination; preparations to break down and decompose oil; chemical products for marine and industrial treatment of bunker oil and heavy fuel oil; tempering and soldering preparations, welding preparations; chemical substances for preserving foodstuffs; tanning substances; adhesives used in industry.

2 – Paints, varnishes and lacquers; preservatives against corrosion and rust and against deterioration of wood.

3 – Bleaching preparations and other substances for laundry use; cleaning, polishing, scouring, degreasing and abrasive preparations; paint and rust removing preparations; industrial abrasives; soaps; perfumery; essential oils; cosmetics; hair lotions; dentifrices; polishing paper, abrasive paper, grinding paper.

6 – Common metals and their alloys; metal building materials; transportable buildings of metal; ironmongery; small items of metal hardware; pipes and tubes of metal; goods of common metal not included in other classes; gas containers; consumables for welding, including welding rods and wires; welding metals; parts and fittings for refrigerators; ores; parts and fittings for all file aforementioned goods.

7 – Machines and machine tools, including electric welding machines end apparatus; gas welding machines and apparatus; compressors for refrigerators and refrigerating plants; equipment, apparatus and machines for the treatment and preparation of surfaces; equipment, apparatus and machines for sandblasting; equipment, apparatus and machines for grinding; equipment, apparatus and machines for the application of paint and coatings to surfaces; paint spraying equipment and apparatus, high pressure washing equipment and apparatus; air tools, air compressors; motors and engines (except for land vehicles); machine coupling and transmission components (except for land vehicles); pumps and pump systems and installations, including pumps and pump systems and pump installations for dosing and circulation of chemicals and liquids; parts and fillings for all the aforementioned goods.

8 – Hand tools and implements (hand-operated), including non-electric welding apparatus and welding tools; fire and escape related hand tools; parts and fittings for all the aforementioned goods.

9 – Scientific, nautical, surveying, photographic, optical, weighing, measuring, signalling, checking (supervision), life-saving and teaching apparatus and instruments; apparatus and instruments for conducting, switching, transforming, accumulating, regula-

ting or controlling electricity; apparatus for recording of sound, images and data; software; fire-extinguishing apparatus and installations; fire suppression apparatus, systems and installations, fire prevention apparatus, systems and installations; fire fighting apparatus, systems and installations; safety apparatus, installations and equipment; breathing apparatus, detection and alarm apparatus, systems and installations; life saving equipment; life rafts and buoys; protective clothing; electrical installation materials; parts and fittings for all the aforementioned goods.

10 – Medical apparatus and instruments, including respirators and masks for artificial respiration, resuscitation apparatus; stretchers; parts and fittings for all the aforementioned goods.

11 – Apparatus for lighting, heating, steam generating, cooking, cooling, refrigerating, drying, ventilating, water supply and sanitary purposes, including air conditioning and ventilation installations, provision stores (cooled), freezer and/or chiller compartments; parts and fittings for all the aforementioned goods.

17 – Rubber, gutta-percha, gum, asbestos, mica and goods made from these materials and not included in other classes; plastics in extruded form for use in manufacture; packing, stopping and insulating materials, including jointing materials and gaskets; flexible pipes, not of metal; flexible hoses and tubes, not of metal; hose couplings, not of metal; pipe connections, not of metal; hose fittings, not of metal; asbestos screens for fire protection; stoppers of rubber or plastics; plastic soldering threads; insulating paint; floating booms for the containment of pollutants; oil absorbent pads for containing and clean-up of oil spills.

35 – Business management; business administration; accounting services; cost reporting; cost assessment; inventory management services; sourcing and buying services; marketing services; dealing with shipping formalities related to customs, port, passport and health services; market research services; import agency and export agency services; arranging and co-ordinating provision of goods, supplies and fuel and support services for vessel owners, charterers or cargo owners; arranging and supply of marine, maritime and industrial spare parts and machinery for vessel owners, charterers or cargo owners; employment agency services for the provision of crew and staff for vessel owners, charterers or cargo owners; manning services; information and consultancy related to all the aforementioned services.

36 – Services provided by shipping agencies, namely prospecting and conclusion of vessel and freight insurance for ship owners; dealing with shipping formalities relating to customs, port, passport and health services; insurance services; insurance brokerage; insurance agency services; underwriting servi-

ces; re-insurance services; loss assessment services; loss adjustment services; debt factoring; customs brokerage, customs clearance of cargo; information and consultancy related to all the aforementioned services.

37 – Construction (building), installation, inspection, maintenance and repair services; services of ship-building, inspection, maintenance, repair, destruction and recycling for sea and ocean going rigs, vessels, and platforms; inspection of ship building and ship building projects; installation, inspection, maintenance and repair of fire-fighting and rescue and safety apparatus and systems; installation, inspection, maintenance and repair of refrigerating, heating, ventilating and air conditioning apparatus and systems; installation, inspection, maintenance and repair of thermal insulation; installation, inspection, maintenance and repair of electrical installations and systems, including electro automation installations and systems; installation, inspection, maintenance and repair of gas distribution apparatus and systems, installation, inspection, maintenance and repair of central welding and gas and inert gas installations; refilling and testing of gas containers; cleaning and repair of boilers; painting services; building, installation, maintenance and repair of machines; under water repair; rental of welding machines and equipment rental of gas cylinders and containers; rental of air compressors; rental of machines, systems and equipment for building, maintenance and repair purposes; rental of cleaning machines and equipment; rental of waste treatment machines and equipment; information and consultancy related to all the aforementioned services.

39 – Logistics, transport and freight services; shipping services; ship brokerage, bunker brokerage, transport brokerage; transport reservation; freight forwarding; freighting; arranging and managing transportation of cargo and/or containers to and from ports on behalf of vessel owners, charterers or cargo owners; container handling; distribution of goods; delivery of goods; warehousing; packaging and storage of goods; inspection of vehicles, ships and/or goods before transport; carriage of goods or cargo for others by land, sea or air, cargo handling services; logistics services for vessel owners, charterers or cargo owners; provisioning of ships; crew and passenger logistics; packaging and packing of goods for despatch; load handling; services in connection with marine towing, unloading and loading, and operating harbours and docks; rental of means of transport, including boats and ships; rental of containers; rental of warehouse space; travel arrangement services; including agency for ship clearance with customs, harbour, immigration and health authorities; delivery and brokerage of goods; arranging shore excursions; supervision of port and terminal operations; port services; distribution services; infor-

mation and consultancy related to all the aforementioned services.

41 – Education; providing of training; providing of training in the use and operation of safety equipment and installations; safety regulation training; information and consultancy related to all the aforementioned services.

42 – Scientific and technological services and research, including design and analysis; services for water and oil analysis, on board ship and/or in laboratory; industrial analysis and research services; design and development of computer hardware and software; information and consultancy related to all the aforementioned services.

(260) AM 2015 79392 A

(800) 1221021

(891) 2014 07 28

(731) BIOFARMA

50 rue Carnot, F-92284 SURESNES CEDEX,
France

(540)

PRESCORIEL

(511)

5 – Pharmaceutical and veterinary products; sanitary products for medical purposes; dietetic food and substances for medical or veterinary use, food for babies; food supplements for humans and animals; plasters, materials for dressings; material for dental fillings and dental impressions; disinfectants; products for destroying vermin; fungicides, herbicides.

(260) AM 2015 79419 A

(800) 1221219

(891) 2014 06 25

(731) DIAGEO SCOTLAND LIMITED

Edinburgh Park, 5 Lochside Way, Edinburgh,
EH12 9DT, United Kingdom

(540)

GLENDULLAN

(511)

33 – Alcoholic beverages but insofar as whisky and whisky based liqueurs are concerned only Scotch whisky and Scotch whisky based liqueurs made in Scotland.

(260) AM 2015 79420 A

(800) 1221220

(891) 2014 06 25

(731) AVON PRODUCTS INC

777 Third Avenue, New York NY 10017,
USA

(540)

IMARI ELIXIR

(511)

3 – Non-medicated toilet preparations; toiletries; skin care preparations; skin moisturizers; body and beauty care preparations; powders, creams and lotions, all for the face, hands and body; cosmetic suntan preparations; soaps; shower and bath preparations; beauty masks; talcum powder; nail polish; nail polish remover; enamel for nails; false nails; adhesives for cosmetic purposes; cosmetics; eye makeup remover, eye shadow, eye liner, mascara, lipstick, lip liner, lip gloss; make-up foundation; blusher; tissues impregnated with cosmetic lotions; cotton sticks for cosmetic purposes; cotton wool for cosmetic purposes; preparations for cleaning, moisturising, colouring and styling the hair; preparations for cleaning the teeth; shaving and aftershave preparations; perfumes, fragrances, toilet waters, eau de cologne; deodorants and anti-perspirants for personal use; essential oils (cosmetic).

(260) AM 2015 79421 A

(800) 1221227

(891) 2014 06 17

(731) CHURCH & DWIGHT CO., INC.

500 Charles Ewing Boulevard, Ewing
NJ 08628, USA

(540)

PEARL DROPS

(511)

3 – Oral care and oral hygiene products included in this class; dentifrices, toothpaste, tooth gels, tooth polish, tooth whitening preparations, non-medicated mouthwash and mouth rinse, non-medicated breath fresheners; medicated dentifrices; professional dental bleaching gels.

5 – Oral care and oral hygiene products included in this class; medicated mouthwash and mouth rinse, medicated breath fresheners and candies, professional dental polish, medicated dental rinse, adhesives for dentures.

21 – Toothbrushes, floss for dental purposes; medicated dental floss.

(260) AM 2015 79422 A

(800) 1221264

(891) 2014 04 07

(731) ERBAY PAZARLAMA VE TİCARET ANONİM ŞİRKETİ

İkitelli Osb Mah. Hurriyet Bulvarı, Deparko
San. Sitesi Deparko Sok. No:1/11, TR-34306
Basakşehir/Istanbul, Turkey

(540)



(591) Black, white

(511)

18 – Unworked or semi-worked leather and animal skins, imitations of leather, stout leather, leather used for linings; goods made of leather, imitations of leather or other materials, designed for carrying items, included in this class; bags; boxes and trunks made of leather or stout leather; key cases; umbrellas; parasols; sun umbrellas; walking sticks; whips; harnesses; saddlery; stirrups; straps of leather (saddlery).

25 – Clothing, including underwear and outerclotting, other than special purpose protective clothing; socks; footwear; headgear.

(260) AM 2015 79423 A

(800) 1221282

(891) 2014 05 20

(731) ELIF PLASTİK AMBALAJ SANAYİ VE TİCARET A.Ş.

Sanayi Mahallesi 1652. Sokak no:2 Esenyurt
İSTANBUL, Turkey

(540)



(591) Black, white, blue, pink and yellow

(511)

16 – Plastic materials for packaging and wrapping purposes.

(260) AM 2015 79425 A

(800) 1221284

(891) 2014 05 15

(731) STARS İNŞAAT TURİZM TEKSTİL SANAYİ VE TİCARET LİMİTED ŞİRKETİ
Ömerli Mevkii Adnan Kahveci Bulvarı
Koskoop San. Sit. 3 Cad. No:7, Hadimköy
Büyükcçekmece, İstanbul, Turkey

(540)

LK & JNS DEW

(591) Black, white

(511)

25 – Clothing, including underwear and outerclotting, other than special purpose protective clothing; socks; footwear; headgear.

(260) AM 2015 79426 A

(800) 1221322

(891) 2014 05 30

(731) Tovarystvo z obmezhenoiu vidpovidalnistiu "PATENT-KYIV"
vul. Vyshhorodska, 50B m. Kyiv 04114,
Ukraine

(540)

FIROCONN

(511)

9 – Coaxial cables; fibre [fiber (Am.)] optic cables; cables, electric; materials for electricity mains [wires, cables]; magnetic wires; telegraph wires; telephone wires; wires, electric; electricity conduits.

35 – Sales promotion for others; procurement services for others [purchasing goods and services for other businesses]; deployment in one place for benefit of others the range of goods that enable customers conveniently view and purchase these goods in stores of wholesale and retail trade.

42 – Scientific and technological services and research and design relating thereto; industrial analysis and research services; design and development of computer hardware and software; chemical analysis; analysis for oil-field exploitation; architecture; bacteriological research; chemistry services; chemical research; architectural consultation; construction drafting; technical research; oil-well testing; cosmetic research; design of interior decor; industrial design; packaging design/packaging design services; material testing; technical project studies; geological surveys; oil field surveys; engineering; meteorological information/weather forecasting; land surveying/land surveys; computer rental; computer programming; oil prospecting; physics [research]; mechanical research; textile testing; geological prospecting; geological research; authenticating works of art; calibration [measuring]; computer software design; updating of computer software; consultancy in the design and development of computer hardware; dress designing; graphic arts design; quality control; rental of computer software; research and development of new products for others; styling [industrial design]; underwater exploration; recovery of computer data; maintenance of computer software; computer system analysis; biological research; urban planning; surveying; computer system design; vehicle roadworthiness testing; duplication of computer programs; conversion of data or documents from physical to electronic media; creating and maintaining web sites for others; hosting computer sites [web sites]; installation of computer software; cloud seeding; data conversion of computer programs and data [not physical conversion]; computer software consultancy; rental of web servers; computer virus protection services; consultancy in the field of energy-saving; research in the field of environmental protection; providing search engines for the internet; digitization of documents [scanning]; handwriting analysis [graphology]; provision of scientific information, advice and consultancy in relation to carbon offsetting; quality evaluation of standing timber/quality valuation of standing timber; quality evaluation of wool; monitoring of computer systems by remote access; water analysis; scientific laboratory services;

energy auditing; web site design consultancy; software as a service [SaaS]; information technology [IT] consultancy; scientific research; server hosting; clinical trials; off-site data backup; electronic data storage; providing information on computer technology and programming via a web site; cartography services; cloud computing.

(260) AM 2015 79427 A

(800) 1221405

(891) 2014 03 28

(731) WIKIMEDIA FOUNDATION, INC.

149 New Montgomery Street, 3rd Floor,
San Francisco CA 94105, USA

(540)



(591) Black, white

(511)

41 – Providing a collaboratively created and maintained online multilingual digital library of textual source material; providing online publications on the use of and contribution to a digital library of textual source material.

42 – Hosting an online website featuring open source technology that enables users to view, edit, discuss, contribute to, and maintain an online multilingual digital library of textual source material; computer services, namely, maintaining a website featuring an online digital library of textual source material.

(260) AM 2015 79428 A

(800) 1221416

(891) 2014 06 03

(731) PHILIPP PLEIN

Säntisstrasse 5 CH-8580 Amriswil, Switzerland

(540)



(591) Black, white

(554) Three - Dimensional

(511)

3 – Essential oils, hair lotions; dentifrices.

14 – Precious metals and their alloys; precious stones; timepieces and chronometric instruments.

18 – Leather and imitation leather, goods made of these materials not included in other classes; animal skins; trunks and suitcases; whips; saddlery.

20 – Mirrors (looking glasses); frames; products (not included in other classes) of cane, wicker.

21 – Utensils and containers for household or kitchen use; combs and sponges.

24 – Fabrics and textile goods not included in other classes; bed and table covers.

25 – Clothing, footwear, headgear.

28 – Appliances for gymnastics; articles for gymnastics and sports; games.

35 – Retail or wholesale services, also via the Internet, in the field of soaps, perfumery, essential oils, cosmetics, hair lotions, dentifrices, precious metals and their alloys and goods made of these materials or coated therewith not included in other classes, jewelry, jewelry products, precious stones, timepieces and chronometric instruments, leather and imitations of leather, goods made of these materials not included in other classes, animal skins, trunks and suitcases, umbrellas, parasols, walking sticks, whips, saddlery, furniture, particularly household furniture, kitchen furniture, mirrors (looking glasses), frames, products (not included in other classes) of wood, cork, reed, cane, willow, horn, bone, ivory, whalebone, tortoiseshell, amber, mother-of-pearl, meerschaum, substitutes for all these materials or of plastic materials, household or kitchen utensils and containers, combs and sponges, glassware, porcelain and earthenware not included in other classes, fabrics and textile goods not included in other classes, bed and table covers, clothing, shoes, headgear, appliances for gymnastics, articles for gymnastics and sports, games, toys.

(260) AM 2015 79429 A

(800) 1221457

(891) 2014 01 07

(731) VITALI ZAVILEISKI

Fácán u. 2, H-2093 Budajenő, Hungary

(540)

BISTEP

(511)

1 – Acids; activated carbons; chemical additives for oils, fungicides, insecticides; agar-agar; agricultural chemicals, except fungicides; manure for agriculture; albumen; alginates for the food industry; alkalies; alkaloids; alum; ammonia; ammonia alum; ammoniacal salts; ammonium aldehyde; ammonium salts; anhydrides; anhydrous ammonia; animal albumen; animal carbon; animal carbon preparations; animal

charcoal; anti-sprouting preparations for vegetables; bacterial preparations other than for medical and veterinary use; beer-clarifying and preserving agents; blood charcoal; bone charcoal; by-products of the processing of cereals for industrial purposes; calcined soda; calcium carbide; calcium cyanamide; calcium salts; carbolineum for the protection of plants; carbon; animal carbon preparations; carbon sulphide; carbon tetrachloride; carbonates; carbonic acid; carbonic hydrates; activated carbons; caustic alkali; caustic soda for industrial and agricultural purposes; caustics for industrial and agricultural purposes; by-products of the processing of cereals for industrial and agricultural purposes; animal charcoal; blood charcoal; bone charcoal; agricultural chemicals, except fungicides; chemicals for forestry, except fungicides, herbicides, insecticides and parasiticides; industrial chemicals; china clay; expanded clay for hydroponic plant growing [substrate]; collodion; compost; biocompost; copper sulphate [vitriol]; cultures of microorganisms, other than for medical and veterinary use; defoliant; diatomaceous earth; potassium dioxalate; dioxide of hydrogen; oil dispersants; dolomite for industrial purposes; diatomaceous earth; earth for growing; enzyme preparations; esters; ethers; ethyl alcohol; ethyl ether; ion exchangers [chemicals]; expanded-clay for hydroponic plant growing [substrate]; fatty acids; [chemicals used in fermenting wine; ferments for industrial purposes; fertilizers; fertilizing preparations; fining preparations; fish meal fertilizers; flower preservatives; chemicals for forestry, except fungicides, herbicides, insecticides and parasiticides; hormones for hastening the ripening of fruit; gelatine for industrial purposes; genes of seeds for agricultural production; glucose for industrial purposes; glucosides; grafting mastic for trees; grafting wax for trees; plant growth regulating preparations; guano; hormones for hastening the ripening of fruit; horticulture chemicals; humus; humus top dressing; hydrates; hydrochlorates; hydrochloric acid; hydrofluoric acid; hydrogen peroxide; hypochlorite of soda; hyposulphites; kaolin; lactic acid; lactose; lecithin; loam; magnesite; magnesium carbonate; magnesium chloride; malt albumen; manganate; manganese dioxide; manure for agriculture; metalloids; microorganisms for industrial purposes; chemical preparations to prevent mildew; milk ferments for industrial purposes; mineral acids; nitrates; nitric acid; nitric monoxide; nitrite; nitrogen; nitrogenous fertilizers; nitrogenous lime [manure]; oenological bactericides [chemical preparations used in wine making]; peat [fertilizer]; peat pots for horticulture; pectin; perborate of soda; percarbonates; perchlorates; persulphates; persulphuric acid; phosphates [fertilizers]; phosphatides; phosphoric acid; phosphorus; plant growth regulating preparations; potash; potash water; potassium; potassium dioxalate; potato flour for industrial purposes; peat pots for horticulture; potting soil; flower preser-

vatives; substances for preserving foodstuffs; protein; rock salt; saccharin; sal ammoniac; salt for preserving, other than for foodstuffs; salt, raw; saltpeter; salts [chemical preparations]; salts [fertilizers]; salts for industrial purposes; seed preserving substances; slag [fertilizers]; soda ash; calcined soda; sodium; sodium salts; soil conditioning preparations; substrates for soil-free growing [agriculture]; sulphates; sulphides; sulphonic acids; sulphur; sulphuric acid; superphosphates [fertilizers]; vine disease preventing preparations; vinegar; vinic alcohol; volatile alkali [ammonia], for industrial purposes; preparations for protection against wheat blight [smut]; chemicals used in fermenting wine; wine finings; plant conditioner preparation; plant conditioner biological nano-preparation; bioorganic plant conditioner nano-preparation; complex bioorganic plant conditioner nano-preparation; biorganic nano fertilizer; microbiological preparation, microelement preparation, other than for medical and veterinary use; bio fertilizer; cow manure and any other manure; foliar fertilizer; humin preparation; preparation with bacterium, fungus, microelements, macroelements, humin acid, fulvous acid, amino acid, vitamins and other biologically active substances, namely microhumates, nanohumates, stimulating agents, all for industrial purposes; artificial fertilizer; liquid fertilizer; liquid plant conditioner preparation; soil improvers; root improvers; activators of germination; preparations for improving immune system of plants; preparations for improving protecting function of plants; anti-stress adaptogen for plants; preparation for reducing the vegetation period of plants; stimulator of oxidase activity of the plants; stimulator of respiratory and photosynthetic processes of the plants; stimulator of fermentative processes of the plants; seed treating preparation; stimulator of metabolic processes of the plants; amino acids for use in agriculture; bacteriological cultures for use in agriculture; bacteriological preparations for use in agriculture.

5 – Albumin dietary supplements; albuminous foodstuffs for medical purposes; albuminous preparations; aldehydes for pharmaceutical purposes; algicides; alginates; aloe vera preparations pharmaceutical purposes; bacteriological cultures for medical purposes; balms for medical purposes; biocides; insect repellent incense; cultures of microorganisms for medical and veterinary use; nutritive substances for microorganisms; preparations of microorganisms for medical and veterinary use; chemical preparations to treat mildew; chemical pesticides; biological pesticides; herbicides; insecticides and parasiticides; fungicides; bactericides; weedkillers.

(260) AM 2015 79430 A
(800) 1221465
(891) 2014 07 14
(731) EGIS GYÓGYSZERGYÁR ZRT.

Keresztúri út 30-38, H-1106 Budapest,
Hungary

(540)

MYFETIL

(511)

5 – Pharmaceutical preparations for human use.

(260) AM 2015 79433 A

(800) 1221468

(891) 2014 09 23

(731) DIAGEO SCOTLAND LIMITED

Edinburgh Park, 5 Lochside Way, Edinburgh,
EH12 9DT, United Kingdom

(540)

CAOL ILA

(511)

33 – Alcoholic beverages.

(260) AM 2015 79434 A

(800) 1221475

(891) 2014 09 25

(731) ZHONGSHANSHI AOKESHI ZHAOMING

DIANQI YOUXIAN GONGSI

No:1 Tengfeng Street, Gangdong Industrial
Park, Zhongxing Dadaonan, Guzhen
Town, Zhongshan, Guangdong Province, China

(540)

OKES

(591) Black, white

(511)

11 – Light bulbs; electric lamps; lamps; incandescent burners; ceiling lights; flares; luminous tubes for lighting; street lamps; gas burners; lanterns for lighting.

(260) AM 2015 79435 A

(800) 1221494

(891) 2014 01 22

(731) "AMALGAMA LUXE", LTD.

Gromodyanska, 119, of. 109 Mykolayiv
54017, Ukraine

(540)

СУЛЬСЕН

(591) Black, white

(511)

3 – Abrasive paper; abrasives; adhesives for affixing false hair; adhesives for affixing false eyelashes; adhesives for cosmetic purposes; after-shave lotions; air fragrancing preparations; almond soap; almond milk for cosmetic purposes; almond oil; aloe vera preparations for cosmetic purposes; alum stones [astringents]; amber [perfume]; ammonia [volatile alkali] [detergent]; antiperspirant soap; antiperspirants

[toiletries]; antistatic preparations for household purposes; aromatics [essential oils]; astringents for cosmetic purposes; badian essence; balms other than for medical purposes; bases for flower perfumes; bath salts, not for medical purposes; bath preparations, not for medical purposes; beard dyes; beauty masks; bergamot oil; bleaching preparations [decolorants] for cosmetic purposes; bleaching salts; bleaching soda; breath freshening sprays; breath freshening strips; cake flavourings [essential oils]; cakes of toilet soap; canned pressurized air for cleaning and dusting purposes; carbides of metal [abrasives]; preparations for cleaning dentures; cleaning preparations; cleaning chalk; cleansing milk for toilet purposes; cloths impregnated with a detergent for cleaning; cobblers' wax; color- [colour-] brightening chemicals for household purposes [laundry]; colorants for toilet purposes; colour-removing preparations; corundum [abrasive]; cosmetic pencils; cosmetic preparations for eyelashes; cosmetic preparations for baths; cosmetic preparations for skin care; cosmetic dyes; cosmetic creams; cosmetic kits; cosmetic preparations for slimming purposes; cosmetics; cosmetics for animals; cotton wool for cosmetic purposes; creams for leather; decorative transfers for cosmetic purposes; degreasers other than for use in manufacturing processes; dental bleaching gels; dentifrices; denture polishes; deodorant soap; deodorants for human beings or for animals; deodorants for pets; depilatory preparations; depilatory wax; detergents other than for use in manufacturing operations and for medical purposes; diamantine [abrasive]; disinfectant soap; douching preparations for personal sanitary or deodorant purposes [toiletries]; dry shampoos; dry-cleaning preparations; drying agents for dishwashing machines; eau de Cologne; emery paper; emery cloth; emery; essential oils of cedarwood; essential oils of citron; essential oils of lemon; ethereal essences; ethereal oils; extracts of flowers [perfumes]; eyebrow pencils; eyebrow cosmetics; fabric softeners for laundry use; false eyelashes; false nails; flavorings [flavourings] for beverages [essential oils]; floor wax removers [scouring preparations]; fumigation preparations [perfumes]; furbishing preparations; gaultheria oil; geraniol; glass cloth; greases for cosmetic purposes; grinding preparations; hair lotions; hair dyes; hair waving preparations; hair spray; heliotropine; henna [cosmetic dye]; hydrogen peroxide for cosmetic purposes; incense; ionone [perfumery]; jasmine oil; javelle water; joss sticks; lacquer-removing preparations; laundry bleach, laundry preparations; laundry blueing; laundry glaze; laundry wax; laundry soaking preparations; lavender water; lavender oil; leather bleaching preparations; leather preservatives [polishes]; lip glosses; lipsticks; lotions for cosmetic purposes; make-up preparations; make-up; mascara; massage gels other than for medical purposes; medicated soap; mint for perfumery; mint essence [es-

sential oil]; moustache wax; mouth washes, not for medical purposes; musk [perfumery]; nail varnish; nail care preparations; nail art stickers; neutralizers for permanent waving; non-slipping wax for floors; non-slipping liquids for floors; oil of turpentine for degreasing; oils for cosmetic purposes; oils for toilet purposes; oils for perfumes and scents; oils for cleaning purposes; paint stripping preparations; parquet floor wax; pastes for razor strops; perfumery; perfumes; petroleum jelly for cosmetic purposes; polish for furniture and flooring; polishing preparations; polishing wax; polishing creams; polishing rouge; polishing stones; polishing paper; pomades for cosmetic purposes; potpourris [fragrances]; make-up powder; pumice stone; quillaia bark for washing; make-up removing preparations; rose oil; rust removing preparations; sachets for perfuming linen; safrol; sandcloth; scale removing preparations for household purposes; scented water; scented wood; scouring solutions; shampoos; shampoos for pets; shaving soap; shaving preparations; shaving stones [astringents]; shining preparations [polish]; preparations to make shiny the leaves of plants; shoe cream; shoe polish; shoe wax; shoemakers' wax; silicon carbide [abrasive]; skin whitening creams; smoothing preparations [starching]; smoothing stones; soap; soap for foot perspiration; soap for brightening textile; soda lye; stain removers; starch glaze for laundry purposes; starch for laundry purposes; sun-tanning preparations [cosmetics]; sunscreen preparations; swabs [toiletries]; tailors' wax; talcum powder, for toilet use; terpenes [essential oils]; tissues impregnated with cosmetic lotions; toilet water; toiletries; tripoli stone for polishing; turpentine, for degreasing; preparations for unblocking drain pipes; varnish-removing preparations; volcanic ash for cleaning; wallpaper cleaning preparations; washing soda, for cleaning; whiting; windscreen cleaning liquids.

(260) AM 2015 79436 A

(800) 1221495

(891) 2014 03 27

(731) WIKIMEDIA FOUNDATION, INC.

149 New Montgomery Street, 3rd Floor,
San Francisco CA 94105, USA

(540)



(591) Black, white

(511)

41 – Providing collaboratively created and maintained online multilingual news articles on any subject; providing online publications on the use of and

contribution to online multilingual news articles on any subject.

42 – Hosting a website featuring an open source technology that enables users to view, discuss, write, edit, contribute to, and maintain online multilingual news articles on any subject; computer services, namely, maintaining an online source of news articles on any subject.

(260) AM 2015 79441 A

(800) 1221629

(891) 2014 05 23

(731) Limited Liability Company "MARTIN"
Tsentralnaya str., 109, Electrougli, Noginsk district, RU-142455 Moscow region, Russian Federation

(540)



(591) Black, white, red, pink, dark red, yellow, brown, dark grey, grey, purple, light blue, blue-grey, dusty blue, beige, dark beige, orange, dark orange, green, dark green and blue

(511)

29 – Processed sunflower seeds.

31 – Sunflower seeds, unprocessed.

(260) AM 2015 79442 A

(800) 1221653

(891) 2014 08 18

(731) BACARDI & COMPANY LIMITED
Aeulestrasse 5, FL-9490 Vaduz, Liechtenstein

(540)



(591) Blue, white, grey and black

(511)

33 – Alcoholic beverages, except beers.

(260) AM 2015 79456 A

(800) 1221710

(891) 2014 05 14

(731) LARA TEKSTİL SANAYİ TİCARET
LİMİTED ŞİRKETİ

Laleli Soğanağa Caddesi, Derinkuyu Sokak,
Bektaş Pasajı No:16/A, Laleli
Eminönü/İSTANBUL, Turkey

(540)



(591) Pink

(511)

25 – Clothing, footwear, headgear.

(260) AM 2015 79457 A

(800) 1221748

(891) 2014 08 26

(731) BALTIJAS DEHIDRĒTIE PRODUKTI, SIA
Kārļa Ulmaņa gatve 2, LV-1004 Rīga, Latvia

(540)

MOLCKE

(511)

30 – Cereal preparations (including rice, buckwheat, oats) and their meals, including porridges; noodles prepared meals, dry cereal products mixed for confectionery (for example, cakes) preparation; instant coffee based, cocoa based, chocolate based, tea based beverages or beverages based on their substitutes; instant non-alcoholic beverages; spices and mixes of spices.

(260) AM 2015 79683 A

(800) 1221861

(891) 2014 05 01

(731) AUSNUTRIA HYPROCA B.V.

Burgemeester Falkenaweg 58 101, NL-8442
LE Heerenveen, Netherlands

(540)

KABRITA

(511)

5 – Pharmaceutical products; food for babies; food for babies based on goat's milk; milk powder for babies; bottled food for babies; dietary supplements and nutritional supplements, all for human consumption and not for medical use.

29 – Dairy products; goat milk products, including goat milk, goat yogurt, goat cheeses and goat products; desserts made from goat's milk; preserved milk products; milk and milk products, as well as substitutes here for, as far as not included in other classes; ready-to-eat foods, not included in other classes, sold in bags and plastic containers, consisting principally of dairy products; milk powder; whey powder; cream powder; milk products and derivatives thereof as an ingredient and / or intermediate for foods and drinks, not included in other classes; milk derivatives.

(260) AM 2015 79691 A

(800) 1223039

(891) 2013 12 27

(731) BATMORE CAPITAL LTD, Midland Trust Limited

177 Main Street, P.O. Box 3169, PMB 257,
Road Town, Tortola, British Virgin Islands

(540)

Pocketbook

(511)

9 – Electronic publications, downloadable; audiovisual teaching apparatus; electronic notice boards; computer programs; computer games; computer game programs; computers; laptop computers; electronic apparatus for recording, transmission or reproduction of sounds or images; video recorders; sound reproduction apparatus; electronic pocket translators; electronic notebooks; spare parts and accessories for computers, laptops and electronic devices for recording, transmission or reproduction of sound or images, including: blocks of memory or microprocessors, integrated circuits, interfaces computers, cables, feeders electric, compact discs, computer keyboards, computer peripherals, storage media, magnetic; media optical, transmitters of electronic signals.

16 – Absorbent sheets of paper or plastic for foodstuff packaging; addressing machines; address plates for addressing machines; address stamps; adhesive bands for stationery or household purposes; adhesives [glues] for stationery or household purposes; adhesive tape dispensers [office requisites]; adhesive tapes for stationery or household purposes; advertisement boards of paper or cardboard; albums; almanacs; announcement cards [stationery]; apparatus for mounting photographs; aquarelles; architects' models; arithmetical tables; atlases; bags [envelopes, pouches] of paper or plastics, for packaging; bags for microwave cooking; balls for ball-point pens; bibs of paper; binding strips [bookbinding]; biological samples for use in microscopy [teaching materials]; blackboards; blotters; blueprints; bookbinding apparatus and machines [office equipment]; bookbinding cloth; bookbinding material; bookbindings;

bookends; booklets; bookmarkers; books; bottle envelopes of cardboard or paper; bottle wrappers of cardboard or paper; boxes of cardboard or paper; cabinets for stationery [office requisites]; calendars; canvas for painting; carbon paper; cardboard; cardboard articles; cardboard tubes; cards; cases for stamps [seals]; catalogues; chalk for lithography; chalk holders; charcoal pencils; chart pointers, non-electronic; chromolithographs [chromos]; cigar bands; clipboards; coasters of paper; comic books; compasses for drawing; composing frames [printing]; conical paper bags; copying paper [stationery]; cords for bookbinding; correcting fluids [office requisites]; correcting ink [heliography]; correcting tapes [office requisites]; covers of paper for flower pots; covers [stationery]; cream containers of paper; credit card imprinters, non-electric; diagrams; document files [stationery]; document holders [stationery]; document laminators for office use; drawer liners of paper, perfumed or not; drawing boards; drawing instruments; drawing materials; drawing pads; drawing pens; drawing pins; drawing rulers; drawing sets; drawing squares; drawing t-squares; duplicators; elastic bands for offices; electrocardiograph paper; electrotypes; embroidery designs [patterns]; engraving plates; engravings; envelope sealing machines, for offices; envelopes [stationery]; erasing products; erasing shields; etching needles; etchings; fabrics for bookbinding; face towels of paper; figurines [statuettes] of papier mâché; files [office requisites]; filtering materials [paper]; filter paper; finger-stalls [office requisites]; flags of paper; flyers; folders for papers; folders [stationery]; forms, printed; fountain pens; franking machines for office use; French curves; galley racks [printing]; garbage bags of paper or of plastics; geographical maps; glue for stationery or household purposes; gluten [glue] for stationery or household purposes; graining combs; graphic prints; graphic representations; graphic reproductions; greeting cards; gummed cloth for stationery purposes; gummed tape [stationery]; gums [adhesives] for stationery or household purposes; handkerchiefs of paper; hand labelling appliances; hand-rests for painters; handwriting specimens for copying; hat boxes of cardboard; hectographs; histological sections for teaching purposes; holders for checkbooks [cheque books]; holders for stamps [seals]; house painters' rollers; humidity control sheets of paper or plastic for foodstuff packaging; index cards [stationery]; indexes; Indian inks; ink; inking pads; inking ribbons; inking ribbons for computer printers; inking sheets for document reproducing machines; inking sheets for duplicators; inkstands; ink sticks; ink stones [ink reservoirs]; inkwells; isinglass for stationery or household purposes; labels, not of textile; ledgers [books]; letter trays; lithographic stones; lithographic works of art; lithographs; loose-leaf binders; luminous paper; magazines [periodicals]; manifolds [stationery]; manuals [handbooks]; mar-

king chalk; marking pens [stationery]; mats for beer glasses; mimeograph apparatus and machines; modelling clay; modelling materials; modelling paste; modelling wax, not for dental purposes; moisteners for gummed surfaces [office requisites]; moisteners [office requisites]; molds for modelling clays [artists' materials]; money clips; musical greeting cards; newsletters; newspapers; nibs; nibs of gold; note books; numbering apparatus; numbers [type]; obliterating stamps; office perforators; office requisites, except furniture; oleographs; packaging material made of starches; pads [stationery]; paint boxes [articles for use in school]; paintbrushes; painters' brushes; painters' easels; paintings [pictures], framed or unframed; paint trays; palettes for painters; pamphlets; pantographs [drawing instruments]; paper; paper bows; paper clasps; paper-clips; paper coffee filters; paper for radiograms; paper for recording machines; paper knives [cutters] [office requisites]; paper ribbons; paper sheets [stationery]; paper shredders for office use; paper tapes and cards for the recordal of computer programmes; paperweights; papier mâché; parchment paper; passport holders; pastels [crayons]; patterns for dressmaking; patterns for making clothes; pen cases; pencil holders; pencil lead holders; pencil leads; pencils; pencil sharpeners, electric or non-electric; pencil sharpening machines, electric or non-electric; pen clips; penholders; pens [office requisites]; pen wipers; perforated cards for jacquard looms; periodicals; photo-engravings; photographs [printed]; photograph stands; pictures; placards of paper or cardboard; place mats of paper; plastic bubble packs for wrapping or packaging; plastic cling film, extensible, for palletization; plastic film for wrapping; plastics for modelling; portraits; postage stamps; postcards; posters; printed matter; printed publications; printed timetables; printers' blankets, not of textile; printers' reglets; printing blocks; printing sets, portable [office requisites]; printing type; prints [engravings]; prospectuses; punches [office requisites]; rollers for typewriters; rosaries; rubber erasers; school supplies [stationery]; scrapers [erasers] for offices; sealing compounds for stationery purposes; sealing machines for offices; sealing stamps; sealing wafers; sealing wax; seals [stamps]; self-adhesive tapes for stationery or household purposes; sheets of reclaimed cellulose for wrapping; shields [paper seals]; signboards of paper or cardboard; silver paper; slate pencils; song books; spools for inking ribbons; square rulers; stamp pads; stamps [seals]; stamp stands; stands for pens and pencils; staples for offices; stapling presses [office requisites]; starch paste [adhesive] for stationery or household purposes; stationery; steatite [tailor's chalk]; steel letters; steel pens; stencil cases; stencil plates; stencils; stencils [stationery]; stickers [stationery]; tablecloths of paper; table linen of paper; tablemats of paper; table napkins of paper; tags for index cards; tailors' chalk; teaching materials [except

apparatus]; terrestrial globes; tickets; tissues of paper for removing make-up; toilet paper; towels of paper; tracing cloth; tracing needles for drawing purposes; tracing paper; tracing patterns; trading cards other than for games; transfers [decalcomanias]; transparencies [stationery]; trays for sorting and counting money; type [numerals and letters]; typewriter keys; typewriter ribbons; typewriters, electric or non-electric; vignetting apparatus; viscose sheets for wrapping; watercolor [watercolour] saucers for artists; waxed paper; wood pulp board [stationery]; wood pulp paper; wrapping paper; wristbands for the retention of writing instruments; writing board erasers; writing brushes; writing cases [sets]; writing cases [stationery]; writing chalk; writing instruments; writing materials; writing or drawing books; writing pads; writing paper; writing slates; xuan paper for Chinese painting and calligraphy.

18 – Animal skins; attaché cases; bags; bags [envelopes, pouches] of leather, for packaging; bags for campers; bags for climbers; bags for sports; bandoliers; beach bags; bits for animals [harness]; blinkers [harness]; boxes of leather or leather board; boxes of vulcanised fibre; bridles [harness]; bridoons; briefcases; butts [parts of hides]; card cases [notecases]; cases, of leather or leatherboard; casings, of leather, for springs; cat o' nine tails; cattle skins; chain mesh purses; chamois leather, other than for cleaning purposes; chin straps, of leather; clothing for pets; collars for animals; coverings of skins [furs]; covers for horse-saddles; curried skins; fastenings for saddles; frames for umbrellas or parasols; fur; furniture coverings of leather; game bags [hunting accessories]; garment bags for travel; girths of leather; gold beaters' skin; gut for making sausages; halters; handbag frames; handbags; harness fittings; harness for animals; harness straps; hat boxes of leather; haversacks; horse blankets; horse collars; horseshoes; imitation leather; key cases; kid; knee-pads for horses; leatherboard; leather laces; leather leads; leather straps; leather thread; leather, unworked or semi-worked; moleskin [imitation of leather]; mountaineering sticks; music cases; muzzles; net bags for shopping; nose bags [feed bags]; pads for horse saddles; parasols; parts of rubber for stirrups; pocket wallets; pouch baby carriers; purses; reins; riding saddles; rucksacks; saddlery; saddle trees; school bags; shopping bags; sling bags for carrying infants; slings for carrying infants; stirrup leathers; stirrups; straps for skates; straps for soldiers' equipment; straps of leather [saddlery]; suitcase handles; suitcases; tool bags of leather, empty; traces [harness]; travelling bags; travelling sets [leatherware]; travelling trunks; trimmings of leather for furniture; trunks [luggage]; umbrella covers; umbrella handles; umbrella or parasol ribs; umbrella rings; umbrellas; umbrella sticks; valises; valves of leather; vanity cases, not fitted; walking stick handles; walking

sticks; walking stick seats; wheeled shopping bags; whips.

35 – Administrative processing of purchase orders; advertising; advertising agencies; advertising by mail order; advisory services for business management; arranging newspaper subscriptions for others; arranging subscriptions to telecommunication services for others; auctioneering; bill-posting; book-keeping; business appraisals; business auditing; business efficiency expert services; business information; business inquiries; business investigations; business management and organization consultancy; business management assistance; business management consultancy; business management of hotels; business management of performing artists; business management of sports people; business organization consultancy; business research; commercial administration of the licensing of the goods and services of others; commercial information agencies; commercial information and advice for consumers [consumer advice shop]; commercial or industrial management assistance; compilation of information into computer databases; compilation of statistics; computerized file management; cost price analysis; data search in computer files for others; demonstration of goods; direct mail advertising; dissemination of advertising matter; distribution of samples; document reproduction; drawing up of statements of accounts; economic forecasting; employment agencies; import-export agencies; invoicing; layout services for advertising purposes; marketing; marketing research; marketing studies; modelling for advertising or sales promotion; news clipping services; office machines and equipment rental; on-line advertising on a computer network; opinion polling; organization of exhibitions for commercial or advertising purposes; organization of fashion shows for promotional purposes; organization of trade fairs for commercial or advertising purposes; outsourcing services [business assistance]; payroll preparation; personnel management consultancy; personnel recruitment; photocopying services; presentation of goods on communication media, for retail purposes; price comparison services; procurement services for others [purchasing goods and services for other businesses]; production of advertising films; professional business consultancy; psychological testing for the selection of personnel; publication of publicity texts; publicity columns preparation; publicity material rental; public relations; radio advertising; relocation services for businesses; rental of advertising space; rental of advertising time on communication media; rental of photocopying machines; rental of vending machines; retail or wholesale services for pharmaceutical, veterinary and sanitary preparations and medical supplies; sales promotion for others; secretarial services; shop window dressing; shorthand; sponsorship search; systemization of information into computer databases; tax preparation; telemarketing services;

telephone answering for unavailable subscribers; television advertising; transcription; typing; updating of advertising material; word processing; writing of publicity texts.

41 – Publication of electronic books and journals in computer networks, lending books from libraries in electronic form; publication of electronic books; preparation of publications (not for advertising purposes) by electronic publishing tools; gaming services over computer networks; educational information by electronic devices; information on leisure by electronic devices, information on entertainment by electronic devices, education, including individual, using electronic devices; providing on-line electronic publications, not downloadable; publication of texts other than advertising in computer networks or by electronic devices, rental of movies by electronic devices; services for digital images.

(260) AM 2015 79696 A

(800) 1223124

(891) 2014 07 16

(731) PEPSICO, INC.

(a North Carolina corporation)

700 Anderson Hill Road, Purchase NY 10577, USA

(540)



(591) White, blue and light blue

(526) AQUA MINERALE

(511)

32 – Waters [beverages]; aerated water; mineral water [beverages]; table waters; preparations for making aerated water; preparations for making mineral water; preparations for making beverages.

(260) AM 2015 79705 A

(800) 1223295

(891) 2014 07 16

(731) PEPSICO, INC.

(a North Carolina corporation)

700 Anderson Hill Road, Purchase NY 10577, USA

(540)



(591) White, blue and dark blue

(511)
32 – Waters [beverages]; aerated water; mineral water [beverages]; table waters; preparations for making aerated water; preparations for making mineral water; preparations for making beverages.

(260) AM 2015 79770 A

(800) 1224019

(891) 2014 07 25

(731) QUANZHOU CITY NEW CENTURY COMMUNICATION ELECTRONICS CO., LTD.

Beifeng Industrial Area, Fengze District, Quanzhou City, Fujian Province, China

(540)

KYDERA

(591) Black, white

(511)

9 – Walkie-talkies; telephone sets; calculating machines; facsimile machines; wires, electric; electric installations for the remote control of industrial operations; bells [warning devices]; galvanic batteries; portable telephones; spectacles [optics].

(260) AM 2015 79771 A

(800) 1224023

(891) 2014 07 03

(731) GRINDEKS, akciju sabiedrība

Krustpils iela 53, LV-1057 Rīga, Latvia

(540)

МИРИУМ

(511)

5 – Pharmaceutical preparations, namely antipsychotics.

(260) AM 2015 79774 A

(800) 1224054

(891) 2014 07 31

(731) DISTILLERIE MICHEL BOINAUD

Le Bois, F-16130 ANGEAC CHAMPAGNE, France

(540)

BIOSENT

(591) Black, white

(511)

1 – Wine products used during wine production (chemical products); bactericides for use in wine-making (chemical products used during wine production); tannins; liquid oak extracts for wine production; chemical products for making foodstuffs.

22 – Dried oak extracts (chips); wood shavings.

(260) AM 2015 79779 A

(800) 1224147

(891) 2013 12 26

(731) WORLD MEDICINE İLAÇ SANAYİ VE TİCARET ANONİM ŞİRKETİ

Evren Mah. Camiyolu Cad. No:50 Kat 1 B,

Zemin 4-5-6 Güneşli, Bağcılar, İstanbul,

Turkey

(540)

SALTAMARE

САЛТАМАРЕ

(591) Black, white

(511)

5 – Medicines for human purposes, medicines for veterinary purposes, vitamin preparations, chemical preparations for medical purposes, dietetic substances adapted for medical use; dietetic foods adapted for medical purposes; baby foods, medicinal herbs, herbal beverages adapted for medical purposes, nutritional supplements, pollen dietary supplements, mineral food supplements, protein dietary supplements; dietary supplements for animals; fodder supplements for veterinary purposes; medicines for dental purposes, hygienic products for medical purposes including sanitary pads, breast-nursing pads and bunion pads, wadding for medical purposes, plasters for medical purposes, dressings for medical purposes, babies' napkins, preparations for destroying noxious plants, preparations for destroying noxious animals, fungicides, deodorants other than for human beings or for animals, air deodorising preparations, disinfectants for hygiene purposes, antiseptics, detergents for medical purposes.

(260) AM 2015 79878 A

(800) 1176055

(891) 2014 08 25

(731) Obschestvo s ogranichennoy

otvetstvennostyu "ESTA"

Shegarskyj lane, bld. 2, 54 A, RU-634026

Tomsk, Russian Federation

(540)



(591) White, light grey, dark grey, black, light green, dark green, yellow and orange

(511)

43 – Snack-bars; cafes; cafeterias; restaurants; self-service restaurants; holiday camp services [lodging]; bar services; providing campground facilities; food and drink catering.

(260) AM 2015 79881 A
 (800) 1221561
 (891) 2014 10 07
 (731) IMPERIAL S.p.A.
 Via dei Lanaioli, 42 Blocco 11, Centergross,
 I-40050 Funo Di Argelato (Bologna), Italy
 (540)



591) Black, white
 (511)
 14 – Jewellery, precious stones; horological and
 chronometric instruments; rings [jewellery, jewelry
 (am.)]; bracelets [jewellery, jewelry (am.)]; watch-
 traps; pendants; necklaces; chronographs; timepie-
 ces; tie pins; earrings; watches; key rings [trinkets or
 fobs]; boxes of precious metal; tie pins; ornamental
 pins; ornamental pins.

18 – Trunks and travelling bags; umbrellas and para-
 sols; key bags; vanity cases, not fitted; trunks [lug-
 gage]; baggage; casual bags; gym bags; chain mesh
 purses; baggage; hand bags; travelling sets [leather-
 ware]; briefcases; satchels; leatherboard; card cases
 [notecases]; wallets; furniture coverings of leather;
 haversacks; beach bags; baggage; bags for climbers;
 shopping bags; handbag frames; harness traces; bag-
 gage; briefcases; briefcases; garment bags for travel;
 rucksacks.

25 – Clothing, footwear, headgear.

(260) AM 2015 79882 A
 (800) 1225050
 (891) 2014 07 10
 (731) SHENZHEN NOXCELL ELECTRONIC
 CO., LIMITED
 709, No:30 of Yuanfen New Village, Gaofeng
 Community, Dalang Regional Office, Longhua
 New District, Shenzhen City, China
 (540)

NOXCELL 诺科赛

(591) Black, white
 (511)
 9 – Galvanic cells; chargers for electric batteries; so-
 lar batteries; photovoltaic cells; accumulators, elect-
 ric; portable telephones; video telephones; earbuds
 (in-ear headphones); headphones; couplers [data
 processing equipment]; cell phone straps; cases for
 telephone sets; computer peripheral devices; naviga-
 tional instruments; network communication equip-
 ment; diaphragms [acoustics]; cabinets for loudspea-
 kers; protection devices for personal use against

accidents; video screens; semi-conductors; cameras
 [photography]; alarms.

(260) AM 2015 80046 A
 (800) 1226013
 (891) 2014 10 17
 (731) HAMLET, naamloze vennootschap
 Kerkstraat 77 B-9120 VRASENE, Belgium
 (540)



(591) beige
 (511)
 30 – Confectionery; chocolate and chocolate pro-
 ducts.

(260) AM 2015 80047 A
 (800) 1226014
 (891) 2014 10 17
 (731) COLUMBIA SPORTSWEAR NORTH
 AMERICA, INC.
 14375 NW Science Park Drive, Attn: Karen
 Cushman, Portland OR 97229, USA
 (540)

THERMAL COIL

(511)
 20 – Pillows; Sleeping bags.
 24 – Bed blankets; Bed sheets; Bed skirts; Bed
 throws; Blanket throws; Blankets for outdoor use;
 Comforters; Duvets; Pillow cases; Shams; Towels.
 25 – Coats; Footwear; Gloves; Headwear; Jacket li-
 ners; Jackets; Mittens; Pants; Parkas; Scarves;
 Shirts; Ski bibs; Socks; Sweaters; Vests.

(260) AM 2015 80048 A
 (800) 1226036
 (891) 2014 11 03
 (731) BROCK BEAUTY INC.
 840 Oak Harbor Blvd. Slidell LA 70458, USA
 (540)

ESSENTIOUS

(511)
 3 – Hair oils; Hair shampoos and conditioners.

(260) AM 2015 80050 A
 (800) 1226074
 (891) 2014 08 01
 (731) B.S.A.
 33 avenue du Maine, Tour Maine
 Montparnasse, F-75015 PARIS, France

(540)



(591) Red, gold, yellow and blue.

(511)

29 – Meat, fish, poultry and game; meat extracts; charcuterie; croquettes (food); caviar; crustaceans, not live; preserved, dried, frozen and cooked fruit, mushrooms and vegetables; fruit pulp and fruit salads; vegetable salads; prepared walnuts; agarics; canned meat, fish, vegetables and fruit; jams, marmalades, compotes; jellies for food; gelatine for food; pollen prepared as foodstuff; weed extracts for food; preserved soya beans for food; protein for human consumption; bouillon, broths, soups; vegetable juices for cooking; eggs, milk, fermented milk, powdered milk, butter, flavored butter, margarine, cream (dairy product), yogurts, milk desserts, cream desserts, drinking yogurts, cheeses, cheese spreads, dairy and cheese specialties, melted cheeses; milk beverages, milk predominating; soya milk; edible oils and fats; cooked dishes based on the aforesaid goods.

30 – Tea, cocoa, chocolate; chocolate products; tea, cocoa, chocolate; non-medicinal infusions; sugar, natural sweeteners; glucose for food; rice, tapioca, sago; pasta, semolina; flour and preparations made from cereals; dried cereal flakes; bread, pastry, cakes, brioches, pancakes, tarts, pies; soya flour; confectionery, sugar confectionery; popcorn; edible ices; honey; golden syrup, royal jelly for human consumption not for medical use; aniseed; star aniseed; malt extract for food; flavorings other than essential oils; aromatic preparations for food; yeast, baking powder; cooking salt; mustard; vinegar, sauces (condiments), dressings for salad; tomato ketchup; mayonnaise; seasonings; thickening agents for cooking foodstuffs; weeds (condiments); spices; preserved garden herbs; ice for refreshment; sandwiches; pizzas; rice-based snacks; spring rolls; sushi, tabbouleh; tortillas; tacos; meat tenderizers for household use; cooked dishes based on the aforesaid goods.

32 – Mineral and aerated waters and other non-alcoholic beverages particularly whey-based beverages excluding beers, ale and porter; non-alcoholic beverages consisting of milk or not excluding beers, ale and porter; isotonic beverages; lemonades; fruit beverages and fruit juices; tomato juice; vegetable juices (beverages); syrups for beverages; preparations for making beverages (except tea-based, coffee-based, or cocoa-based, milk beverages); pastilles and powders for effervescing beverages; essences for making beverages; preparations for making liqueurs.

(260) AM 2015 80052 A

(800) 1226084

(891) 2014 07 23

(731) LONKING (FUJIAN) MACHINERY CO., LTD.

1 Lonking Road, Longyan Economic

Development Zone, Fujian Province, China

(540)

(591) Black, White

(511)

7 – Loading machines; road rollers; graders; excavators; road milling machines; backhoe loaders; bulldozers; scrapers; pavers; road construction machines; valves [parts of machines]; bearing for transmission shafts; mixing machines; hoists; bearing [parts of machines]; lifts [other than ski-lifts].

(260) AM 2015 80054 A

(800) 1226161

(891) 2014 07 30

(731) PREMIER BEVERAGES P.B. LIMITED

Arch. Makariou III, 2-4, Capital Center, 9-th floor CY-1065 Nicosia, Cyprus

(540)



(591) White, brown-yellow, dark brown, black and yellow.

(511)

32 – Beers, particularly, ales.

(260) AM 2015 80057 A

(800) 802192

(891) 2014 08 11

(731) ORFIX International GmbH

Rottorfer Strasse 8, 21449 Radbruch, Germany

(540)

(511)

9 – Electric apparatus for counting, sorting and packaging of coins and banknotes; money scales; optical devices made of glass or plastic materials for reading microletters; false money detecting apparatus.

16 – Goods made of paper, cardboard and/or plastic materials for money packaging; cash boxes made of

cardboard and/or plastic materials for storing and counting money; bag seals and ties made of plastic materials for packaging money and values; safe bags made of plastic materials for transporting money and values.

39 – Transporting and storing of materials for money packaging for others.

40 – Printing of papers and plastic materials for money packaging for others.

42 – Designing of papers and plastic materials for money packaging for others.

(260) AM 2015 80058 A
 (800) 879905
 (891) 2014 10 20
 (731) PREFERRED GUEST, INC.
 One StarPoint, Stamford CT 06902, USA
 (540)

SPG

(511)
 35 – Promoting hotel, resort and vacation services through a rewards incentive program; tracking and monitoring incentive awards program for members.

(260) AM 2015 80059 A
 (800) 888865
 (891) 2014 09 16
 (731) DAINESE S.p.A.
 Via dell'Artigianato, 35, I-36060 Molvena
 (Vicenza), Italy
 (540)

DAINESE

(511)
 9 – Scientific, nautical, surveying, photographic, cinematographic, optical, weighing, measuring, signalling, checking (supervision), life-saving and teaching apparatus and instruments; apparatus and instruments for conducting, switching, transforming, accumulating, regulating or controlling electricity; apparatus for recording, transmission or reproduction of sound or images; magnetic data carriers, recording discs; automatic vending machines and mechanisms for coin-operated apparatus; cash registers, calculating machines, data processing equipment and computers; fire-extinguishing apparatus.

18 – Leather and imitations of leather, and goods made of these materials and not included in other classes; animal skins, hides; trunks and travelling bags; umbrellas, parasols and walking sticks; whips, harness and saddlery.

25 – Clothing, footwear, headgear.

28 – Games and playthings; gymnastic and sporting articles not included in other classes; decorations for Christmas trees.

18 – Leather and imitations of leather, and goods made of these materials and not included in other classes; animal skins, hides; trunks and travelling bags; umbrellas, parasols and walking sticks; whips, harness and saddlery.

25 – Clothing, footwear, headgear.

28 – Games and playthings; gymnastic and sporting articles not included in other classes; decorations for Christmas trees.

(260) AM 2015 80061 A
 (800) 1086893
 (891) 2014 11 18
 (731) PANDORA A/S
 Hovedvejen 2 DK-2600 Glostrup, Denmark
 (540)

ALE

(511)
 14 – Goods in precious metals and their alloys; brilliants; precious stones; ornaments in precious metals or coated therewith (not included in other classes); jeweller's work and jewellery; cufflinks and tiepins; watches; clocks; watch straps; bijouterie coated with precious metals; cases and other containers especially designed for clocks and jewellery.

(260) AM 2015 80180 A
 (800) 1227739
 (891) 2014 09 08
 (731) Tovarystvo z obmezhenoiu vidpovidalnistiu "OBIO"
 vul. Promyslova, 6, Zhytomyr 10025, Ukraine
 (540)



(591) Black, white
 (511)
 17 – Insulating materials; mineral wool (insulator); glass wool for insulation; insulating refractory materials; soundproofing materials; boiler composition to prevent the radiation of heat; non-conducting materials for retaining heat.

19 – Building materials, not of metal; refractory construction materials, not of metal.

37 – Building insulating.

(260) AM 2015 80181 A
 (800) 1227837
 (891) 2014 08 05
 (731) PRIVATE JOINT STOCK COMPANY
 "INDUSTRIAL ASSOCIATION "KONTI"
 Bul. Shevchenko, 6-b, Donetsk 83015,
 Ukraine
 (540)



(591) Black, white
 (511)
 30 – Cocoa; rice; tapioca and sago; flour and preparations made from cereals; bread, pastry and confectionery; ices; sugar, honey, treacle; yeast, baking-powder; salt; mustard; vinegar, sauces (condiments);

spices; ice; aniseed; peanut confectionery; high-protein cereal bars; baking soda (bicarbonate of soda for cooking purposes); soya bean paste (condiment); bean meal; star aniseed; tapioca flour for food; flour; flour-milling products; bread rolls; buns; sandwiches; vanillin (vanilla substitute); vanilla (flavoring); waffles; vermicelli (noodles); cream of tartar for culinary purposes; farinaceous foods; oatmeal; oat flakes; oat-based food; sea water for cooking; seaweed (condiment); binding agents for ice cream (edible ices); biscuits; cloves (spice); mustard meal; cake frosting (icing); glucose for culinary purposes; relish (condiment); gluten additives for culinary purposes; essences for foodstuffs, except etheric essences and essential oils; fruit jellies (confectionery); chewing gum; custard; leaven; rice-based snack food; cereal-based snack food; frozen yogurt (confectionery ices); frozen kefir (confectionery ices); flavorings, other than essential oils, for beverages; flavorings, other than essential oils, for cakes; flavorings, other than essential oils; wheat germ for human consumption; preparations for stiffening whipped cream; thickening agents for cooking foodstuffs; chips (cereal products); ginger (spice); cocoa-based beverages with milk; cocoa-based beverages; cocoa-based ingredients for confectionery products; cocoa; cocoa mixes; cocoa powder; capers; caramels (candy); lozenges (confectionery); curry (spice); potato flour for food; ketchup (sauce); gluten prepared as foodstuff; confectionery with sugar; tortillas; cinnamon (spice); starch for food; hominy grits; groats for human food; corn, milled; corn, roasted; corn flour; popcorn; corn flakes; turmeric for food; couscous (semolina); salt for preserving foodstuffs; confectionery for decorating Christmas trees; edible ices; ice for refreshment; ice, natural or artificial; liquorice (confectionery); noodles; candy; flaxseed for human consumption; mayonnaise; macaroni; maltose; hominy; chow-chow (condiment); marinades; marzipan; royal jelly; honey; molasses for food; macarons (pastry); almond paste; almond confectionery; pancakes; spring rolls; gruel, with a milk base, for food; ice-cream; dessert mousses (confectionery); chocolate mousses; nutmegs; muesli; meat gravies; meat tenderizers, for household purposes; mint for confectionery; peppermint sweets; infusions, not medicinal; husked oats; ravioli; pepper; pesto (sauce); beer vinegar; quiches; sweetmeats (candy); pizzas; pies; fondants (confectionery); powder for edible ices; pralines; condiments; dressings for salad; seasonings; unleavened bread; bee glue; gingerbread; puddings; cake powder; fruit coulis (sauces); rice cakes; baking powder; ferments for pastes; sago; garden herbs, preserved (seasonings); celery salt; golden syrup; salt for preserving foodstuffs; soya flour; soya sauce; malt for human consumption; malt biscuits; malt extract for food; tomato sauce; spaghetti; noodle-based prepared meals; ham glaze; rusks; breadcrumbs; petit-beurre biscuits; sushi;

tabbouleh; tacos; tapioca; petits fours (cakes); crackers; cake dough; tarts; sorbets (ices); halvah; bread; chutneys (condiments); saffron (seasoning); chocolate; chocolate-based beverages; chocolate beverages with milk; barley meal; crushed barley.

(260) AM 2015 80285 A

(800) 1229381

(891) 2014 10 20

(731) Open-Type Joint Stock Company

"ROT FRONT"

2-oy Novokuznetskiy pereulok, d. 13/15,
RU-113184 Moscow, Russian Federation

(540)

**ЮЖНАЯ
НОЧЬ**

(591) Black, white

(511)

30 – Pastry; confectionery made of sugar, namely candy, sweets, pralines, chocolate, pastilles, halvah, waffles.

(260) AM 2015 80438 A

(800) 1230775

(891) 2014 02 26

(731) APEX MICROELECTRONICS COMPANY
LIMITED

Areas B, 7/F 4 Bld., No.63, Mingzhubei road,
Qianshan, Zhuhai city, 519000 Guangdong
Province, China

(540)

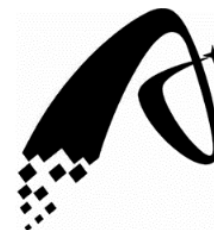

(591) Black, white

(511)

9 – Chip (integrated circuits) using germanium film; integrated circuits; blank integrated circuit cards; microprocessors; data processing apparatus, namely, computers, microprocessor, calculating machine; central processing units; electronic chips for the manufacturer of integrated circuits; integrated circuits block; computer memories; scanners; photographic, electrostatic, and thermic photocopiers; facsimile machines; printers for use with computers; electrical transducers; computer software (recorded); downloadable computer software for use in database management, use as a spreadsheet and word processing; part of photocopiers, copying machines, printers and/or scanning machines, namely, photoconductive drums, transfer rollers print heads, refillable

ink cartridges, magnetic rollers, charge rollers, wiper doctor blades, printers flour knife, toner supply rollers, development rollers, fuser rollers.

(260) AM 2015 80439 A

(800) 1230790

(891) 2014 06 16

(731) S.I.T. SORDINA IORT TECHNOLOGIES

SPA

Galleria del Pozzo Rosso, 13, I-36100

Vicenza, Italy

(540)



(591) Black, white

(511)

10 – Surgical apparatus and instruments; apparatus and installations for the production of x-rays, for medical purposes; radiotherapy apparatus; x-ray apparatus for medical purposes; protection devices against x-rays, for medical purposes; radiology screens for medical purposes; x-ray tubes for medical purposes; orthopedic articles; suture materials; protection devices for healthy tissue for use in intraoperative radiotherapy with electrons (IORT); linear electron accelerators for intraoperative radiotherapy on tumours; surgical, medical, dental and veterinary apparatus and instruments, artificial limbs, eyes and teeth.

INTERNATIONAL TRADEMARKS PROTECTED IN GEORGIA

(260) AM 2015 78181 A
(800) 1210444
(151) 2013 12 30
(181) 2023 12 30
(891) 2013 12 30
(511) 25, 35

(260) AM 2015 78441 A
(800) 1212413
(151) 2013 12 02
(181) 2023 12 02
(891) 2013 12 02
(511) 34

(260) AM 2015 78186 A
(800) 1210524
(151) 2014 04 16
(181) 2024 04 16
(891) 2014 04 16
(511) 08, 21

(260) AM 2015 78442 A
(800) 1212436
(151) 2014 02 10
(181) 2024 02 10
(891) 2014 02 10
(511) 09, 38, 42

(260) AM 2015 78188 A
(800) 532741
(151) 1988 12 21
(181) 2018 12 21
(891) 2014 05 12
(511) 30

(260) AM 2015 78444 A
(800) 1212446
(151) 2014 02 26
(181) 2024 02 26
(891) 2014 02 26
(511) 24

(260) AM 2015 78437 A
(800) 1204373
(151) 2014 04 01
(181) 2024 04 01
(891) 2014 07 18
(511) 01, 05

(260) AM 2015 78445 A
(800) 1212452
(151) 2014 03 20
(181) 2024 03 20
(891) 2014 03 20
(511) 25

(260) AM 2015 78438 A
(800) 1212324
(151) 2013 12 10
(181) 2023 12 10
(891) 2013 12 10
(511) 03, 05, 35

(260) AM 2015 78446 A
(800) 1212468
(151) 2014 05 20
(181) 2024 05 20
(891) 2014 05 20
(511) 30

(260) AM 2015 78439 A
(800) 1212361
(151) 2014 04 25
(181) 2024 04 25
(891) 2014 04 25
(511) 29, 30, 32

(260) AM 2015 78447 A
(800) 1212475
(151) 2014 06 27
(181) 2024 06 27
(891) 2014 06 27
(511) 03

(260) AM 2015 78440 A
(800) 1212377
(151) 2014 04 11
(181) 2024 04 11
(891) 2014 04 11
(511) 03, 04, 05

(260) AM 2015 78448 A
(800) 1212484
(151) 2014 06 12
(181) 2024 06 12
(891) 2014 06 12
(511) 05

(260) AM 2015 78632 A
(800) 1214661
(151) 2014 03 06
(181) 2024 03 06
(891) 2014 03 06
(511) 07, 09, 11

(260) AM 2015 78633 A
(800) 1214662
(151) 2014 03 06
(181) 2024 03 06
(891) 2014 03 06
(511) 07, 09, 11

(260) AM 2015 78657 A
(800) 1160614
(151) 2013 01 04
(181) 2023 01 04
(891) 2014 04 16
(511) 11

(260) AM 2015 78682 A
(800) 1215012
(151) 2014 03 06
(181) 2024 03 06
(891) 2014 03 06
(511) 07, 09, 11

(260) AM 2015 78684 A
(800) 1215025
(151) 2014 03 25
(181) 2024 03 25
(891) 2014 03 25
(511) 29, 31, 44

(260) AM 2015 78685 A
(800) 1215054
(151) 2014 03 27
(181) 2024 03 27
(891) 2014 03 27
(511) 05, 29, 30, 32

(260) AM 2015 78687 A
(800) 1215069
(151) 2014 02 10
(181) 2024 02 10
(891) 2014 02 10
(511) 12, 37, 42

(260) AM 2015 78688 A
(800) 1215082
(151) 2014 03 31

(181) 2024 03 31
(891) 2014 03 31
(511) 05

(260) AM 2015 78905 A
(800) 1216724
(151) 2014 03 03
(181) 2024 03 03
(891) 2014 03 03
(511) 01

(260) AM 2015 78907 A
(800) 1216765
(151) 2013 12 11
(181) 2023 12 11
(891) 2013 12 11
(511) 05, 44

(260) AM 2015 78913 A
(800) 1216774
(151) 2013 12 23
(181) 2023 12 23
(891) 2013 12 23
(511) 05, 35

(260) AM 2015 78920 A
(800) 1216813
(151) 2014 05 05
(181) 2024 05 05
(891) 2014 05 05
(511) 05

OFFICIAL NOTIFICATIONS

TRADEMARKS

RENEWAL OF REGISTRATIONS

(111) M 1995 1034 R2

(156) 2015 09 26

(186) 2025 09 26

(732) JAGUAR LAND ROVER LIMITED

Abbey Road, Whitley, Coventry CV3 4LF,
United Kingdom

(111) M 1995 1035 R2

(156) 2015 09 26

(186) 2025 09 26

(732) JAGUAR LAND ROVER LIMITED

Abbey Road, Whitley, Coventry CV3 4LF,
United Kingdom

(111) M 1995 1062 R2

(156) 2015 09 27

(186) 2025 09 27

(732) H-D U.S.A., LLC

3700 West Juneau Avenue, Milwaukee,
WI 53208, USA

(111) M 1995 1063 R2

(156) 2015 09 27

(186) 2025 09 27

(732) H-D U.S.A., LLC

3700 West Juneau Avenue, Milwaukee,
WI 53208, USA

(111) M 1995 1076 R2

(156) 2015 09 28

(186) 2025 09 28

(732) NEC CORPORATION

7-1, Shiba 5-chome, Minato-ku, Tokyo,
Japan

(111) M 1995 1081 R2

(156) 2015 09 28

(186) 2025 09 28

(732) NTN Corporation

3-17, Kyomachibori-1-chome, Nishi-ku,
Osaka-shi, Japan

(111) M 1995 1195 R2

(156) 2015 11 20

(186) 2025 11 20

(732) T.J. SMITH & NEPHEW LTD

101 Hessle Road, Hull HU3 2BN, United
Kingdom

(111) M 1995 1212 R2

(156) 2015 11 28

(186) 2025 11 28

(732) GIANT MANUFACTURING CO. LTD.

19, Shun Farn Road, Lung Chuan Li Tachia,
Taichung Hsien, Taiwan, Province of China

(111) M 2005 16105 R1

(156) 2015 08 04

(186) 2025 07 27

(732) CONDOR COMPANY

N94, Dr. Beheshti Avenue, Teihran, Iran
(Islamic Republic of)

(111) M 2005 16158 R1

(156) 2015 08 12

(186) 2025 08 12

(732) LTD "G-M-P"

Zemo Vedzisi Str. 103, 0160, Tbilisi, Georgia

(111) M 2005 16192 R1

(156) 2015 09 19

(186) 2025 09 19

(732) LTD "AVERSI-PHARMA"

Davit Agmasheneblis gamz., 148/2, 0112,
Tbilisi, Georgia

(111) M 2005 16230 R1

(156) 2015 09 28

(186) 2025 09 28

(732) LULULEMON ATHLETICA CANADA INC.

2113 West Fourth Avenue, Vancouver,
British Columbia, V6K 1N6, Canada

(111) M 2005 16297 R1

(156) 2015 11 02

(186) 2025 11 02

(732) DELL INC. (a Delaware corporation)

One Dell Way, Round Rock, Texas 78682,
USA

(111) M 2005 16317 R1
(156) 2015 11 02
(186) 2025 11 02
(732) SIXTY INTERNATIONAL S.A.
29, avenue Monterey, L-2163 Luxembourg,
Luxembourg

(111) M 2005 16343 R1
(156) 2015 11 29
(186) 2025 11 29
(732) ORACLE AMERICA, INC.
500 Oracle Parkway, Redwood Shores,
California 94065, USA

(111) M 2005 16368 R1
(156) 2015 11 29
(186) 2025 11 29
(732) EGIS GYOGYSZERGYAR NYRT
30-38 Kereszturi Ut, Budapest, H-1106,
Hungary

(111) M 2006 16486 R1
(156) 2016 02 15
(186) 2026 02 15
(732) N.V. SUMATRA TOBACCO TRADING
COMPANY
Jalan Pattimura No.3, Pematang Siantar,
Sumatera Utara, Indonesia

(111) M 2006 16801 R1
(156) 2016 08 14
(186) 2026 08 14
(732) MITSUBISHI KORPOREISHEN
3-1, Marunouchi 2-chome, Chiyoda-ku,
Tokyo, Japan

(111) M 2006 16802 R1
(156) 2016 08 14
(186) 2026 08 14
(732) MITSUBISHI KORPOREISHEN
3-1, Marunouchi 2-chome, Chiyoda-ku,
Tokyo, Japan

(111) M 2006 16807 R1
(156) 2016 08 14
(186) 2026 08 14
(732) LABORATOIRE HRA PHARMA
15, rue Beranger, 75003 Paris, France

(111) M 2005 16366 R1
(156) 2015 11 29
(186) 2025 11 29

(732) EGIS GYOGYSZERGYAR NYRT
30-38 Kereszturi Ut, Budapest, H-1106,
Hungary

(111) M 2005 16367 R1
(156) 2015 11 29
(186) 2025 11 29
(732) EGIS GYOGYSZERGYAR NYRT
30-38 Kereszturi Ut, Budapest, H-1106,
Hungary

(111) M 1995 799 R2
(156) 2015 09 04
(186) 2025 08 02
(732) McILHENNY COMPANY,
a corporation the State of Maine
State of Louisiana, USA

(111) M 1995 914 R2
(156) 2015 08 17
(186) 2025 08 17
(732) EGIS GYOGYSZERGYAR NYRT
30-38 Kereszturi Ut, Budapest, H-1106,
Hungary

(111) M 1995 978 R2
(156) 2015 09 21
(186) 2025 09 21
(732) JAGUAR LAND ROVER LIMITED
Abbey Road, Whitley, Coventry CV3 4LF,
United Kingdom

COMPLETE TRANSFER OF RIGHTS

(111) M 1996 001347 R1
 (732) TEVA GmbH
 Graf-Arco-Straße 3, 89079 Ulm, Germany
 (770) AWD.PHARMA GMBH & CO.KG,
 Wasastrasße 50, 01445 Radebeul, Germany
 (580) 2015 09 14

(111) M 1996 001395 R1
 (732) TEVA GmbH
 Graf-Arco-Straße 3, 89079 Ulm, Germany
 (770) AWD.PHARMA GMBH & CO.KG,
 Wasastrasße 50, 01445 Radebeul, Germany
 (580) 2015 09 14

(111) M 2001 014127 R1
 (732) MONDELEZ BULGARIA HOLDING AD
 Business Park Sofia Str., Building 3, Floor 4,
 1766 Sofia, Bulgaria
 (770) MONDELEZ EUROPE GMBH
 Lindbergh-Allee 1, 8152 Glattpark,
 Switzerland
 (580) 2015 09 04

(111) M 2001 014127 R1
 (732) MONDELEZ BULGARIA EOOD
 Business Park Sofia Str., Building 3, Floor 4,
 1766 Sofia, Bulgaria
 (770) MONDELEZ BULGARIA HOLDING AD
 Business Park Sofia Str., Building 3, Floor 4,
 1766 Sofia, Bulgaria
 (580) 2015 09 04

(111) M 2002 014294 R1
 (732) BAYER EAST COAST LLC
 100 Bayer Boulevard, Whippany, New Jersey
 07981, USA
 (770) MSD International Holdings GmbH
 Veystrasse 20, CH-6000, Lucerne 6,
 Switzerland
 (580) 2015 09 04

(111) M 2002 014299 R1
 (732) BAYER EAST COAST LLC
 100 Bayer Boulevard, Whippany, New Jersey
 07981, USA
 (770) MSD International Holdings GmbH
 Veystrasse 20, CH-6000, Lucerne 6,
 Switzerland
 (580) 2015 09 04

(111) M 1996 001486 R1
 (732) BAYER INTELLECTUAL PROPERTY
 GMBH
 Alfred-Nobel-Strasse 10, 40789 Monheim am
 Rhein, Germany
 (770) BAYER AG
 D-51368 Leverkusen, Germany
 (580) 2015 09 14

(111) M 1996 001487 R1
 (732) BAYER INTELLECTUAL PROPERTY GMBH
 Alfred-Nobel-Strasse 10, 40789 Monheim am
 Rhein, Germany
 (770) BAYER AG
 D-51368 Leverkusen, Germany
 (580) 2015 09 14

(111) M 1996 001489 R1
 (732) BAYER INTELLECTUAL PROPERTY
 GMBH
 Alfred-Nobel-Strasse 10, 40789 Monheim am
 Rhein, Germany
 (770) BAYER AG
 D-51368 Leverkusen, Germany
 (580) 2015 09 14

(111) M 1996 001490 R1
 (732) BAYER INTELLECTUAL PROPERTY GMBH
 Alfred-Nobel-Strasse 10, 40789 Monheim am
 Rhein, Germany
 (770) BAYER AG
 D-51368 Leverkusen, Germany
 (580) 2015 09 14

(111) M 1996 001493 R1
 (732) BAYER INTELLECTUAL PROPERTY GMBH
 Alfred-Nobel-Strasse 10, 40789 Monheim am
 Rhein, Germany
 (770) BAYER AG
 D-51368 Leverkusen, Germany
 (580) 2015 09 14

(111) M 1996 001496 R1
 (732) BAYER INTELLECTUAL PROPERTY GMBH
 Alfred-Nobel-Strasse 10, 40789 Monheim am
 Rhein, Germany
 (770) BAYER AG
 D-51368 Leverkusen, Germany
 (580) 2015 09 14

(111) M 1996 001704 R1
(732) BAYER INTELLECTUAL PROPERTY
GMBH
Alfred-Nobel-Strasse 10, 40789 Monheim am
Rhein, Germany

(770) BAYER AG
D-51368 Leverkusen, Germany
(580) 2015 09 14

(111) M 1996 001707 R1
(732) BAYER INTELLECTUAL PROPERTY
GMBH
Alfred-Nobel-Strasse 10, 40789 Monheim am
Rhein, Germany

(770) BAYER AG
D-51368 Leverkusen, Germany
(580) 2015 09 14

(111) M 1996 001970 R1
(732) BAYER INTELLECTUAL PROPERTY
GMBH
Alfred-Nobel-Strasse 10, 40789 Monheim am
Rhein, Germany

(770) BAYER AG
D-51368 Leverkusen, Germany
(580) 2015 09 14

(111) M 2010 020213 R
(732) BAYER INTELLECTUAL PROPERTY
GMBH
Alfred-Nobel-Strasse 10, 40789 Monheim am
Rhein, Germany

(770) BAYER AKTIENGESELLSCHAFT
D-51368 Leverkusen, Germany
(580) 2015 09 14

(111) M 2013 023413 R
(732) LTD "MARSI"
Kavtaradzis q. 5, 0186, Tbilisi, Georgia
(770) LTD "PLANETA-14"
Kavtaradzis q. 5, 0186, Tbilisi, Georgia
(580) 2015 08 19

(111) M 2013 023477 R
(732) LTD "MARSI"
Kavtaradzis q. 5, 0186, Tbilisi, Georgia
(770) LTD "PLANETA-14"
Qavtaradzis q. 5, 0186, Tbilisi, Georgia
(580) 2015 08 19

(111) M 2014 024521 R
(732) LTD "BATONO"
I. Nikoladzis q. 12, 0179, Tbilisi, Georgia

(770) LTD "INTELLECTPRODUCTS"
125047, Moscow, Pereulok Lesnoi 4,
dom 11, Russian Federation
(580) 2015 08 19

(111) M 1996 002488 R1
(732) BAYER EAST COAST LLC
100 Bayer Boulevard, Whippany, New Jersey
07981, USA
(770) MERCK SHARP & DOHME CORP.
One Merck Drive, Whitehouse Station,
New Jersey 08889, USA
(580) 2015 09 04

(111) M 1996 002489 R1
(732) BAYER EAST COAST LLC
100 Bayer Boulevard, Whippany, New Jersey
07981, USA
(770) MERCK SHARP & DOHME CORP.,
One Merck Drive, Whitehouse Station,
New Jersey 08889, USA
(580) 2015 09 04

(111) M 2014 025209 R
(732) LTD "YNNOVAS"
Sulkhan Tsintsadzis 12, sart. 4, 0160 Tbilisi,
Georgia
(770) LTD "SHTOLTSPHARM"
Sulkhan Tsintsadzis 12, sart. 4, 0160, Tbilisi,
Georgia
(580) 2015 09 14

(111) M 1994 000355 R2
(732) JOHNSON & JOHNSON
One Johnson & Johnson Plaza, New
Brunswick, New Jersey 08933, USA
(770) NEUTROGENA CORPORATION
5760 West 96 Street, Los Angeles, California
90045, USA
(580) 2015 09 04

(111) M 1996 003720 R1
(732) BAYER INTELLECTUAL PROPERTY
GMBH
Alfred-Nobel-Strasse 10, 40789 Monheim
am Rhein, Germany
(770) BAYER AG
D-51368 Leverkusen, Germany
(580) 2015 09 14

(111) M 1997 007723 R1
(732) BAYER INTELLECTUAL PROPERTY
GMBH

Alfred-Nobel-Strasse 10, 40789 Monheim am
Rhein, Germany
(770) BAYER AG
D-51368 Leverkusen, Germany
(580) 2015 09 14

(111) M 1995 000805 R1
(732) FL EUROPE HOLDINGS, INC.
112 west 34-th street, City of New York,
State of New York,10120, USA
(770) FOOT LOCKER RETAIL, INC.
112 west 34-th street, City of New York,
State of New York,10120, USA
(580) 2015 09 14

(111) M 1995 000806 R1
(732) FL EUROPE HOLDINGS, INC.
112 west 34-th street, City of New York,
State of New York,10120, USA
(770) FOOT LOCKER RETAIL, INC.
112 west 34-th street, City of New York,
State of New York,10120, USA
(580) 2015 09 14

(111) M 1998 008941 R1
(732) SUMITOMO HEAVY INDUSTRIES, LTD
1-1 Osaki 2-chome, Shinagawa-ku, Tokyo
141-6025, Japan
(770) NIPPON STEEL & SUMITOMO METAL
CORPORATION
6-1, Marunouchi 2-chome, Chiyoda-ku,
Tokyo 100-8071, Japan
(580) 2015 09 15

CHANGES IN NAMES AND/OR ADDRESSES OF OWNERS

(111) M 1998 010446 R1
(732) BECHER TEXTIL-UND STABLAU
GMBH
Gewerbeparkstr. 34, 51580 Reichshof-
Wehrath, Germany
(770) BECHER TEXTIL-UND STABLAU
GMBH
Konigstr. 35, 51645 Gummersbach, Germany
(580) 2015 09 04

(111) M 1999 011699 R1
(732) MOTOROLA TRADEMARK HOLDINGS,
LLC
222 W. Merchandise Mart Plaza, Suite 1800,
Chicago, IL 60654, USA
(770) Motorola Trademark Holdings, LLC
600 North U.S. Highway 45, Libertyville,
IL 60048, USA
(580) 2015 09 14

(111) M 1996 001347 R1
(732) AWD.PHARMA GMBH & CO.KG
Wasastrasße 50, 01445 Radebeul, Germany
(770) AWD.PHARMA GMBH & CO.KG
Leipziger Strasse 7-13, 01097 Dresden,
Germany
(580) 2015 09 14

(111) M 1996 001395 R1
(732) AWD.PHARMA GMBH & CO.KG,
Wasastrasße 50, 01445 Radebeul, Germany
(770) AWD.PHARMA GMBH & CO.KG
Leipziger Strasse 7-13, 01097 Dresden,
Germany
(580) 2015 09 14

(111) M 2005 015971 R1
(732) SPIRITS PRODUCT INTERNATIONAL
INTELLECTUAL PROPERTY B.V.
7, Rue Nicolas Bové, L-1253 Luxembourg,
Luxembourg
(770) SPIRITS PRODUCT INTERNATIONAL
INTELLECTUAL PROPERTY B.V.
1A, Rue Thomas Edison, L-1445, Strassen,
Luxembourg, Luxembourg
(580) 2015 08 24

(111) M 2005 015971 R1
(732) Spirits Product International Intellectual
Property B.V.

3, riu du Fort Rheinsheim, L-2419
Luxembourg, Luxembourg
(770) SPIRITS PRODUCT INTERNATIONAL
INTELLECTUAL PROPERTY B.V.
7, Rue Nicolas Bové, L-1253 Luxembourg,
Luxembourg
(580) 2015 08 24

(111) M 2005 015973 R1
(732) SPIRITS PRODUCT INTERNATIONAL
INTELLECTUAL PROPERTY B.V.
7, Rue Nicolas Bove, L-1253, Luxembourg
(770) SPIRITS PRODUCT INTERNATIONAL
INTELLECTUAL PROPERTY B.V.
1A, Rue Thomas Edison, L-1445, Strassen,
Luxembourg, Luxembourg
(580) 2015 08 19

(111) M 2005 015973 R1
(732) SPIRITS PRODUCT INTERNATIONAL
INTELLECTUAL PROPERTY B.V.
3, riu du Fort Rheinsheim, L-2419
Luxembourg, Luxembourg
(770) SPIRITS PRODUCT INTERNATIONAL
INTELLECTUAL PROPERTY B.V.
7, Rue Nicolas Bove, L-1253, Luxembourg
(580) 2015 08 19

(111) M 2005 016051 R1
(732) HEMOFARM AKCIONARSKO DRUŠTVO
FARMACEUTSKO-HEMIJSKA
INDUSTRIJA
Vršac (HEMOFARM A.D. Vršac)
Beogradski Put BB, 26300 Vršac, Serbia
and Montenegro
(770) HEMOFARM KONCERN A.D.
Pharmaceutical and Chemical Industry,
Beogradski put bb, 26300 Vršac, 26300,
Serbia and Montenegro
(580) 2015 08 19

(111) M 2005 016203 R
(732) KONICA MINOLTA HOLDINGS, INC.,
2-7-2, Marunouchi, Chiyoda-ku, Tokyo, Japan
(770) KONICA MINOLTA HOLDINGS, INC.,
(a corporation duly organized under the laws
of Japan)
6-1, Marunouchi 1- chome, Chiyoda-ku,
Tokyo, Japan
(580) 2015 09 14

(111) M 2005 016203 R
(732) KONICA MINOLTA, INC.
2-7-2, Marunouchi, Chiyoda-ku, Tokyo,
Japan
(770) KONICA MINOLTA HOLDINGS, INC.
2-7-2, Marunouchi, Chiyoda-ku, Tokyo,
Japan
(580) 2015 09 14

(111) M 2005 016206 R
(732) KONICA MINOLTA HOLDINGS, INC.
2-7-2, Marunouchi, Chiyoda-ku, Tokyo,
Japan
(770) KONICA MINOLTA HOLDINGS, INC.
(a corporation duly organized under the laws
of Japan)
6-1, Marunouchi 1- chome, Chiyoda-ku,
Tokyo, Japan
(580) 2015 09 14

(111) M 2005 016206 R
(732) KONICA MINOLTA, INC.
2-7-2, Marunouchi, Chiyoda-ku, Tokyo,
Japan
(770) KONICA MINOLTA HOLDINGS, INC.
2-7-2, Marunouchi, Chiyoda-ku, Tokyo,
Japan
(580) 2015 09 14

(111) M 2005 016366 R1
(732) EGIS GYOGYSZERGYAR NYRT.
30-38 Kereszturi Ut , Budapest H-1106,
Hungary
(770) EGIS GYOGYSZERGYAR RT
30-38 Kereszturi ut, Budapest, H-1106,
Hungary
(580) 2015 08 19

(111) M 2005 016366 R1
(732) EGIS GYOGYSZERGYAR NYRT
30-38 Kereszturi Ut, Budapest, H-1106,
Hungary
(770) EGIS GYOGYSZERGYAR NYRT.
30-38 Kereszturi Ut , Budapest H-1106,
Hungary
(580) 2015 08 19

(111) M 2005 016367 R1
(732) EGIS GYOGYSZERGYAR NYRT.
30-38 Kereszturi Ut , Budapest H-1106,
Hungary
(770) EGIS GYOGYSZERGYAR RT
30-38 Kereszturi ut, Budapest, H-1106,
Hungary

(580) 2015 08 19

(111) M 2005 016367 R1
(732) EGIS GYOGYSZERGYAR NYRT
30-38 Kereszturi Ut, Budapest, H-1106,
Hungary
(770) EGIS GYOGYSZERGYAR NYRT.
30-38 Kereszturi Ut , Budapest H-1106,
Hungary
(580) 2015 08 19

(111) M 2005 016368 R1
(732) EGIS GYOGYSZERGYAR NYRT.
30-38 Kereszturi Ut , Budapest H-1106,
Hungary
(770) EGIS GYOGYSZERGYAR RT
30-38 Kereszturi ut, Budapest, H-1106,
Hungary
(580) 2015 08 19

(111) M 2005 016368 R1
(732) EGIS GYOGYSZERGYAR NYRT
30-38 Kereszturi Ut, Budapest, H-1106,
Hungary
(770) EGIS GYOGYSZERGYAR NYRT.
30-38 Kereszturi Ut , Budapest H-1106,
Hungary
(580) 2015 08 19

(111) M 2008 018685 R
(732) JSC "SHATO MUKHRANI"
Sof. Mukhrani, 3309, Mtskheta, Georgia
(770) JSC "SHATO MUKHRANI"
Chavchavadzis gamz.11, 0179, Tbilisi,
Georgia
(580) 2015 08 19

(111) M 2008 018689 R
(732) JSC "SHATO MUKHRANI"
Sof. Mukhrani, 3309, Mtskheta, Georgia
(770) JSC "SHATO MUKHRANI"
Chavchavadzis gamz.11, 0179, Tbilisi,
Georgia
(580) 2015 08 19

(111) M 2008 018694 R
(732) JSC "SHATO MUKHRANI"
Sof. Mukhrani, 3309, Mtskheta, Georgia
(770) JSC "SHATO MUKHRANI"
Chavchavadzis gamz.11, 0179, Tbilisi,
Georgia
(580) 2015 08 19

(111) M 2011 021597 R
(732) LTD "SUPERBETI 2014"
Oniashvilis q. 1, 0160 Tbilisi, Georgia
(770) LTD "SUPERBETI 2014"
Baratashvilis q. 2, 0105, Tbilisi, Georgia
(580) 2015 08 19

(111) M 2013 023643 R
(732) KRAFT FOODS FRANCE
INTELLECTUAL PROPERTY S.A.S.
7 AV Réaumur, 92140 Clamart, France
(770) Kraft Foods France Intellectual Property
SAS
13 Avenue Morane Saulnier, 78140 Velizy
Villacoublay, France
(580) 2015 08 19

(111) M 2013 023869 R
(732) JSC "SHATO MUKHRANI"
Sof. Mukhrani, 3309, Mtskheta, Georgia
(770) JSC "SHATO MUKHRANI"
Chavchavadzis gamz. №11, 0179, Tbilisi,
Georgia
(580) 2015 08 19

(111) M 2013 023969 R
(732) JSC "SHATO MUKHRANI"
Sof. Mukhrani, 3309, Mtskheta, Georgia
(770) JSC "SHATO MUKHRANI"
Chavchavadzis gamz.11, 0179, Tbilisi,
Georgia
(580) 2015 08 19

(111) M 2014 024593 R
(732) LTD "SUPERBETI 2014"
Oniashvilis q. 1, 0160 Tbilisi, Georgia
(770) LTD "superbeti 2014"
Baratashvilis q. 2, 0105, Tbilisi, Georgia
(580) 2015 08 19

(111) M 2014 024594 R
(732) LTD "SUPERBETI 2014"
Oniashvilis q. 1, 0160 Tbilisi, Georgia
(770) LTD "SUPERBETI 2014"
Baratashvilis q. 2, 0105, Tbilisi, Georgia
(580) 2015 08 19

(111) M 1996 003511 R1
(732) CONSITEX S.A.
Via-Ligornetto 13, 6855 Stabio, Switzerland
(770) CONSITEX S.A.
Via-Laveggio 16, CH-6850 Mendrisio,
Switzerland, Switzerland
(580) 2015 08 19

(111) M 1996 003513 P R1
(732) CONSITEX S.A.
Via-Ligornetto 13, 6855 Stabio, Switzerland
(770) CONSITEX S.A.
Via-Laveggio 16, CH-6850 Mendrisio,
Switzerland, Switzerland
(580) 2015 08 19

(111) M 1996 003514 P R1
(732) CONSITEX S.A.
Via-Ligornetto 13, 6855 Stabio, Switzerland
(770) CONSITEX S.A.
Via-Laveggio 16, CH-6850 Mendrisio,
Switzerland, Switzerland
(580) 2015 08 19

(111) M 1997 005888 R1
(732) Motorola Trademark Holdings, LLC
222 W. Marchandise Mart Plaza, Suite 1800,
Chicago, IL 60654, USA
(770) Motorola Trademark Holdings, LLC
600 North U.S. Highway 45, Libertyville,
IL 60048, USA
(580) 2015 09 14

(111) M 1995 000763 R1
(732) GEO G. SANDEMAN SONS & CO.,
LIMITED
400 Capability Green, Bedfordshire, Luton,
United Kingdom
(770) Portugal Venture Limited
8 Henrietta Place, London W1G 0NB,
United Kingdom
(580) 2015 09 04

(111) M 1995 000764 R1
(732) GEO G. SANDEMAN SONS & CO.,
LIMITED
400 Capability Green, Bedfordshire, Luton,
United Kingdom
(770) PORTUGAL VENTURE LIMITED
8 Henrietta Place, London W1G 0NB,
(580) 2015 09 04

(111) M 1995 000765 R1
(732) GEO G. SANDEMAN SONS & CO.,
LIMITED
400 Capability Green, Bedfordshire, Luton,
United Kingdom
(770) Portugal Venture Limited,
8 Henrietta Place, London W1G 0NB,
United Kingdom
(580) 2015 09 04

(111) M 1995 000805 R1
(732) FOOT LOCKER RETAIL, INC.
112 west 34-th street, City of New York,
State of New York,10120, USA
(770) FOOT LOCKER RETAIL, INC.
233 BROADWAY, NEW YORK, USA
(580) 2015 09 14

(111) M 1995 000806 R1
(732) FOOT LOCKER RETAIL, INC.
112 west 34-th street, City of New York,
State of New York,10120, USA
(770) FOOT LOCKER RETAIL, INC.
233 BROADWAY, NEW YORK, USA
(580) 2015 09 14

(111) M 1995 000914 R2
(732) EGIS GYOGYSZERGYAR NYRT.
30-38 Kereszturi Ut , Budapest H-1106,
Hungary
(770) EGIS Gyógyszergyár Nyilvánosan Működő
Részvénytársaság (EGIS Nyrt)
Keresztúri út. 30-38, Budapest H-1106,
Hungary
(580) 2015 08 19

(111) M 1995 000914 R2
(732) EGIS GYOGYSZERGYAR NYRT
30-38 Kereszturi Ut, Budapest, H-1106,
Hungary
(770) EGIS GYOGYSZERGYAR NYRT.
30-38 Kereszturi Ut , Budapest H-1106,
Hungary
(580) 2015 08 19

(111) M 1995 000970 R1
(732) KONICA MINOLTA HOLDINGS, INC.
2-7-2, Marunouchi, Chiyoda-ku, Tokyo,
Japan
(770) KONICA MINOLTA HOLDINGS, INC.
6-1, Marunouchi 1- chome, Chiyoda-ku,
Tokyo, Japan
(580) 2015 09 14

(111) M 1995 000970 R1
(732) KONICA MINOLTA, INC.
2-7-2, Marunouchi, Chiyoda-ku, Tokyo,
Japan
(770) KONICA MINOLTA HOLDINGS, INC.
2-7-2, Marunouchi, Chiyoda-ku, Tokyo,
Japan
(580) 2015 09 14

CLASSIFICATION INDEXES

INVENTIONS

CONCORDANCE TABLE OF INTERNATIONAL CLASSIFICATION INDEX AND PUBLICATION NUMBERS

INTERNATIONAL CLASSIFICATION INDEXES (51)	NUMBER OF PUBLISHED APPLICATION (10)
A 01 N 43/42; A 61 K 31/44	AP 2015 12570 A
A 43 B 7/06; A 43 B 7/12	AP 2015 12631 A
A 43 B 7/06; A 43 B 7/12	AP 2015 12614 A
A 43 B 7/12; A 43 B 7/06	AP 2015 12630 A
A 61 K 31/55; A 61 P 9/04; C 07 C 209/88; C 07 C 217/74; C 07 D 223/16; C 12 P 17/10	AP 2015 13162 A
C 07 D 239/70; C 07 D 403/12; A 61 K 31/517; A 61 P 11/00	AP 2015 13210 A
G 02 B 5/08; G 02 B 5/28; H 01 S 3/08; H 01 S 5/00	AP 2015 13701 A
H 01 S 3/10; H 01 S 3/11	AP 2015 13702 A

CONCORDANCE TABLE OF PUBLICATION NUMBERS AND INTERNATIONAL CLASSIFICATION INDEX

NUMBER OF PUBLISHED APPLICATION (10)	INTERNATIONAL CLASSIFICATION INDEXES (51)
AP 2015 12570 A	A 01 N 43/42; A 61 K 31/44
AP 2015 12614 A	A 43 B 7/06; A 43 B 7/12
AP 2015 12630 A	A 43 B 7/12; A 43 B 7/06
AP 2015 12631 A	A 43 B 7/06; A 43 B 7/12
AP 2015 13162 A	A 61 K 31/55; A 61 P 9/04; C 07 C 209/88; C 07 C 217/74; C 07 D 223/16; C 12 P 17/10
AP 2015 13210 A	C 07 D 239/70; C 07 D 403/12; A 61 K 31/517; A 61 P 11/00
AP 2015 13701 A	G 02 B 5/08; G 02 B 5/28; H 01 S 3/08; H 01 S 5/00;
AP 2015 13702 A	H 01 S 3/10; H 01 S 3/11

CONCORDANCE TABLE OF INTERNATIONAL CLASSIFICATION INDEX, PATENT NUMBERS AND PUBLICATION NUMBERS

INTERNATIONAL CLASSIFICATION INDEX (51)	NUMBER OF PATENT (11)	NUMBER OF PUBLISHED APPLICATION (10)
A 61 K 31/54	P 2015 6366 B	AP 2015 12693 A
B 60 L 8/00	P 2015 6367 B	AP 2015 12771 A
C 07 C 55/10; C 07 C 57/15; C 07 C 69/86; C 07 C 227/18; C 07 C 229/12; C 07 D 239/557; A 61 K 31/616; A 61 K 31/205; A 61 K 31/197; A 61 K 31/513; A 61 P 9/00	P 2015 6373 B	AP 2015 13252 A
C 07 C 215/08; C 07 C 229/34; C 07 C 255/43; C 07 D 223/16	P 2015 6369 B	AP 2015 13040 A

1	2	3
C 07 D 213/64; C 07 D 213/69; C 07 D 401/04; C 07 D 401/10; C 07 D 405/04; C 07 D 405/12; C 07 D 413/10; C 07 D 417/12; A 61 P 31/00; A 61 K 31/4412; A 61 K 31/4427; A 61 K 31/4439; A 61 K 31/4433	P 2015 6370 B	AP 2015 13215 A
C 07 D 237/16; C 07 D 401/10; C 07 D 407/10; A 61 K 31/50; A 61 K 31/501; A 61 P 25/18; A 61 P 29/00; A 61 P 25/28	P 2015 6372 B	AP 2015 13407 A
C 07 D 401/06; A 61 K 31/4439; A 61 P 31/18	P 2015 6368 B	AP 2015 12882 A

**CONCORDANCE TABLE OF PATENT NUMBERS,
PUBLICATION NUMBERS AND INTERNATIONAL CLASSIFICATION INDEX**

NUMBER OF PATENT (11)	NUMBER OF PUBLISHED APPLICATION (10)	INTERNATIONAL CLASSIFICATION INDEX (51)
P 2015 6366 B	AP 2015 12693 A	A 61 K 31/54
P 2015 6367 B	AP 2015 12771 A	B 60 L 8/00
P 2015 6368 B	AP 2015 12882 A	C 07 D 401/06; A 61 K 31/4439; A 61 P 31/18
P 2015 6369 B	AP 2015 13040 A	C 07 C 215/08; C 07 C 229/34; C 07 C 255/43; C 07 D 223/16
P 2015 6370 B	AP 2015 13215 A	C 07 D 213/64; C 07 D 213/69; C 07 D 401/04; C 07 D 401/10; C 07 D 405/04; C 07 D 405/12; C 07 D 413/10; C 07 D 417/12; A 61 P 31/00; A 61 K 31/4412; A 61 K 31/4427; A 61 K 31/4439; A 61 K 31/4433
P 2015 6371 B	AP 2015 13265 A	G 06 Q 30/00
P 2015 6372 B	AP 2015 13407 A	C 07 D 237/16; C 07 D 401/10; C 07 D 407/10; A 61 K 31/50; A 61 K 31/501; A 61 P 25/18; A 61 P 29/00; A 61 P 25/28
P 2015 6373 B	AP 2015 13252 A	C 07 C 55/10; C 07 C 57/15; C 07 C 69/86; C 07 C 227/18; C 07 C 229/12; C 07 D 239/557; A 61 K 31/616; A 61 K 31/205; A 61 K 31/197; A 61 K 31/513; A 61 P 9/00

**CONCORDANCE TABLE OF APPLICATION NUMBERS, PUBLICATION NUMBERS
AND PATENTS**

NUMBER OF APPLICATION (21)	NUMBER OF PUBLISHED APPLICATION (10)	NUMBER OF PATENT (11)
AP 2010 012693	AP 2015 12693 A	P 2015 6366 B
AP 2010 012771	AP 2015 12771 A	P 2015 6367 B
AP 2011 012882	AP 2015 12882 A	P 2015 6368 B
AP 2013 013040	AP 2015 13040 A	P 2015 6369 B
AP 2012 013215	AP 2015 13215 A	P 2015 6370 B
AP 2012 013252	AP 2015 13252 A	P 2015 6373 B
AP 2013 013265	AP 2015 13265 A	P 2015 6371 B
AP 2012 013407	AP 2015 13407 A	P 2015 6372 B

UTILITY MODELS

CONCORDANCE TABLE OF INTERNATIONAL CLASSIFICATION INDEX, PATENT NUMBERS AND PUBLICATION NUMBERS

INTERNATIONAL CLASSIFICATION INDEX (51)	NUMBER OF PATENT (11)	NUMBER OF PUBLISHED APPLICATION (10)
A 61 K 36/80; B 01 D 11/02	U 2015 1871 Y	AU 2015 13380 U
B 28 B 1/00	U 2015 1870 Y	AU 2015 13058 U
C 07 B 7/22	U 2015 1872 Y	AU 2015 13588 U
D 06 F 57/12	U 2015 1873 Y	AU 2015 13637 U

CONCORDANCE TABLE OF PATENT NUMBERS, PUBLICATION NUMBERS AND INTERNATIONAL CLASSIFICATION INDEX

NUMBER OF PATENT (11)	NUMBER OF PUBLISHED APPLICATION (10)	INTERNATIONAL CLASSIFICATION INDEX (51)
U 2015 1870 Y	AU 2015 13058 U	B 28 B 1/00
U 2015 1871 Y	AU 2015 13380 U	A 61 K 36/80; B 01 D 11/02
U 2015 1872 Y	AU 2015 13588 U	C 07 B 7/22
U 2015 1873 Y	AU 2015 13637 U	D 06 F 57/12

CONCORDANCE TABLE OF APPLICATION NUMBERS, PUBLICATION NUMBERS AND PATENTS

NUMBER OF APPLICATION (21)	NUMBER OF PUBLISHED APPLICATION (10)	NUMBER OF PATENT (11)
AU 2013 013058	AU 2015 13058 U	U 2015 1870 Y
AU 2014 013380	AU 2015 13380 U	U 2015 1871 Y
AU 2014 013588	AU 2015 13588 U	U 2015 1872 Y
AU 2014 013637	AU 2015 13637 U	U 2015 1873 Y

**DESIGN REGISTERED ACCORDING TO THE
ACCELERATED PROCEDURE**

**CONCORDANCE TABLE OF INTERNATIONAL CLASSIFICATION INDEX
AND PATENTS NUMBERS**

INTERNATIONAL CLASSIFICATION INDEX (51)	NUMBER OF PATENT (11)
09-05	D 2015 646 S
09-05	D 2015 647 S
09-07	D 2015 645 S

**CONCORDANCE TABLE OF PATENT NUMBERS AND INTERNATIONAL
CLASSIFICATION INDEX**

NUMBER OF PATENT (11)	INTERNATIONAL CLASSIFICATION INDEX (51)
D 2015 645 S	09-07
D 2015 646 S	09-05
D 2015 647 S	09-05

**CONCORDANCE TABLE OF APPLICATION NUMBERS
AND PATENT NUMBERS**

NUMBER OF APPLICATION (21)	NUMBER OF PATENT (11)
AD 2015 000875	D 2015 645 S
AD 2015 000879	D 2015 646 S
AD 2015 000880	D 2015 647 S

TRADEMARKS

CONCORDANCE TABLE OF REGISTRATION NUMBERS, APPLICATION NUMBERS, PUBLICATION NUMBERS AND BULLETIN NUMBERS

NUMBER OF REGISTRATION (111)	NUMBER OF APPLICATIONS (210)	NUMBER OF PUBLISHED APPLICATIONS (260)	NUMBER OF BULLETIN
M 2015 26250 R	AM 83396	-	18(430) 2015
M 2015 26251 R	AM 82821	AM 2015 82821 A	18(430) 2015
M 2015 26252 R	AM 75191	AM 2015 75191 A	5(417) 2015
M 2015 26253 R	AM 75719	AM 2015 75719 A	9(421) 2015
M 2015 26254 R	AM 76367	AM 2015 76367 A	7(419) 2015
M 2015 26255 R	AM 76628	AM 2015 76628 A	6(418) 2015
M 2015 26256 R	AM 76630	AM 2015 76630 A	7(419) 2015
M 2015 26257 R	AM 76843	AM 2015 76843 A	8(420) 2015
M 2015 26258 R	AM 77189	AM 2015 77189 A	2(414) 2015
M 2015 26259 R	AM 77258	AM 2015 77258 A	10(422) 2015
M 2015 26260 R	AM 78253	AM 2015 78253 A	8(420) 2015
M 2015 26261 R	AM 78263	AM 2015 78263 A	7(419) 2015
M 2015 26262 R	AM 78272	AM 2015 78272 A	8(420) 2015
M 2015 26263 R	AM 78273	AM 2015 78273 A	8(420) 2015
M 2015 26264 R	AM 78382	AM 2015 78382 A	8(420) 2015
M 2015 26265 R	AM 78383	AM 2015 78383 A	8(420) 2015
M 2015 26266 R	AM 78409	AM 2015 78409 A	8(420) 2015
M 2015 26267 R	AM 78410	AM 2015 78410 A	8(420) 2015
M 2015 26268 R	AM 78457	AM 2015 78457 A	9(421) 2015
M 2015 26269 R	AM 78721	AM 2015 78721 A	9(421) 2015
M 2015 26270 R	AM 78728	AM 2015 78728 A	8(420) 2015
M 2015 26271 R	AM 78754	AM 2015 78754 A	8(420) 2015
M 2015 26272 R	AM 78789	AM 2015 78789 A	9(421) 2015
M 2015 26273 R	AM 78790	AM 2015 78790 A	7(419) 2015
M 2015 26274 R	AM 78807	AM 2015 78807 A	9(421) 2015
M 2015 26275 R	AM 78849	AM 2015 78849 A	8(420) 2015
M 2015 26276 R	AM 83390	-	18(430) 2015
M 2015 26277 R	AM 78850	AM 2015 78850 A	8(420) 2015
M 2015 26278 R	AM 79202	AM 2015 79202 A	10(422) 2015
M 2015 26279 R	AM 83332	-	18(430) 2015
M 2015 26280 R	AM 83372	-	18(430) 2015
M 2015 26281 R	AM 83337	-	18(430) 2015
M 2015 26282 R	AM 83429	-	18(430) 2015
M 2015 26283 R	AM 83430	-	18(430) 2015
M 2015 26284 R	AM 83635	-	18(430) 2015
M 2015 26285 R	AM 83734	-	18(430) 2015
M 2015 26286 R	AM 83484	-	18(430) 2015
M 2015 26287 R	AM 83677	-	18(430) 2015
M 2015 26288 R	AM 83678	-	18(430) 2015
M 2015 26289 R	AM 83351	-	18(430) 2015
M 2015 26290 R	AM 83519	-	18(430) 2015
M 2015 26291R	AM 83520	-	18(430) 2015

**CONCORDANCE TABLE OF PUBLICATION NUMBERS
AND APPLICATION NUMBERS**

NUMBER OF PUBLISHED APPLICATION (260)	NUMBER OF APPLICATION (210)	1	2
1	2		
AM 2015 77262 A	AM 77262	AM 2015 79842 A	AM 79842
AM 2015 77725 A	AM 77725	AM 2015 79844 A	AM 79844
AM 2015 77857 A	AM 77857	AM 2015 79955 A	AM 79955
AM 2015 77858 A	AM 77858	AM 2015 80446 A	AM 80446
AM 2015 79327 A	AM 79327	AM 2015 80464 A	AM 80464
AM 2015 79476 A	AM 79476	AM 2015 80481 A	AM 80481
AM 2015 79578 A	AM 79578	AM 2015 80482 A	AM 80482
AM 2015 79584 A	AM 79584	AM 2015 80483 A	AM 80483
AM 2015 79588 A	AM 79588	AM 2015 80910 A	AM 80910
AM 2015 79590 A	AM 79590	AM 2015 80911 A	AM 80911
AM 2015 79796 A	AM 79796	AM 2015 80986 A	AM 80986
		AM 2015 80987 A	AM 80987
		AM 2015 80989 A	AM 80989
		AM 2015 80991 A	AM 80991
		AM 2015 80992 A	AM 80992
		AM 2015 81003 A	AM 81003

**CONCORDANCE TABLE OF INDEX OF GOODS AND/OR SERVICES
AND APPLICATION NUMBERS**

INDEX OF GOODS AND/OR SERVICES (511)	NUMBER OF PUBLISHED APPLICATIONS (260)	1	2
1	2		
3	AM 2015 77725 A	35	AM 2015 77725 A
3	AM 2015 79327 A	35	AM 2015 79327 A
5	AM 2015 77725 A	35	AM 2015 79578 A
5	AM 2015 79327 A	35	AM 2015 79584 A
5	AM 2015 79476 A	35	AM 2015 79588 A
5	AM 2015 79578 A	35	AM 2015 79590 A
5	AM 2015 80481 A	35	AM 2015 80446 A
5	AM 2015 80482 A	36	AM 2015 80446 A
5	AM 2015 80483 A	36	AM 2015 80986 A
9	AM 2015 80464 A	36	AM 2015 80987 A
12	AM 2015 77857 A	36	AM 2015 80989 A
12	AM 2015 77858 A	36	AM 2015 80991 A
32	AM 2015 79796 A	36	AM 2015 80992 A
33	AM 2015 77262 A	36	AM 2015 81003 A
33	AM 2015 79955 A	37	AM 2015 80446 A
33	AM 2015 80910 A	38	AM 2015 80446 A
33	AM 2015 80911 A	38	AM 2015 80464 A
34	AM 2015 79842 A	39	AM 2015 80446 A
34	AM 2015 79844 A	41	AM 2015 80446 A
		41	AM 2015 80464 A
		42	AM 2015 80446 A
		44	AM 2015 77725 A
		45	AM 2015 80446 A

CONCORDANCE TABLE OF INDEX OF GOODS AND/OR SERVICES
AND NUMBERS OF TRADEMARKS REGISTERED ACCORDING
TO THE ACCELERATED PROCEDURE

INDEX OF GOODS AND/OR SERVICES (511)	NUMBERS OF REGISTERED ACCORDING TO THE ACCELERATED PROCEDURE (111)
5	M 2015 26279 R
5	M 2015 26281 R
5	M 2015 26286 R
19	M 2015 26287 R
19	M 2015 26288 R
29	M 2015 26250 R
30	M 2015 26250 R
32	M 2015 26290 R
32	M 2015 26291 R
33	M 2015 26280 R
33	M 2015 26290 R
33	M 2015 26291 R
33	M 2015 26285 R
34	M 2015 26276 R
35	M 2015 26289 R
35	M 2015 26280 R
36	M 2015 26282 R
36	M 2015 26283 R
37	M 2015 26289 R
39	M 2015 26284 R
43	M 2015 26250 R

OFFICIAL BULLETIN OF THE INDUSTRIAL PROPERTY

18(430)

EDITOR-IN-CHIEF: N. Bebrishvili

EDITORS-TRANSLATORS: E. Gabunia

PROOFREADER: A. Shikhashvili

COMPUTER LAYOUT: M. Ordenidze
K. Svanidze

www.sakpatenti.org.ge
E-mail: info@sakpatenti.org.ge