

საქართველოს ინტელექტუალური საკუთრების
ეროვნული ცენტრი
საქპატენტი

სამრეწველო საკუთრების
ო ფ ი ს ი ა ლ უ რ ი
ბიულეტენი

5(393)

**გამოგონებები
სასარგებლო მოდელები
დიზაინები
სასაქონლო ნიშნები**

საერთაშორისო კოდეზი ბიბლიოგრაფიული მონაცემების იდენტიფიკაციისათვის

გამოგონებები, სასარგებლო მოდელები

- (10) – ექსპერიმენტული განაცხადის გამოქვეყნების ნომერი
- (11) – პატენტის ნომერი და სახეობის კოდი
- (21) – განაცხადის სარეგისტრაციო ნომერი
- (22) – განაცხადის შეტანის თარიღი
- (23) – საგამოყენებლო პრიორიტეტის თარიღი ან აღინიშნული პრიორიტეტის მქონე განაცხადის შეტანის თარიღი და, თუ შესაძლებელია, განაცხადის ომერი
- (24) – თარიღი, რომლიდანაც იწყება პატენტის მოქმედება
- (31) – საპროორიტეტო განაცხადის ნომერი
- (32) – საპროორიტეტო განაცხადის შეტანის თარიღი
- (33) – კოდი ქვეყნის ან რეგიონული ორგანიზაციისა, რომლის უწყებამაც მიანიჭა ნომერი საპროორიტეტო განაცხადს
- (44) – დამცავი სახეობის ჯერ არმქონე, მაგრამ ექსპერიმენტული განაცხადის გამოქვეყნების თარიღი და ბიულეტენის ნომერი
- (45) – რეგისტრაცია გავლელი საპატენტო სახეობის გამოქვეყნების თარიღი
- (51) – საერთაშორისო საპატენტო კლასიფიკაციის ინდექსი

- (54) – გამოგონების დასახელება
- (57) – რეზიუმე ტექსტი
- (60) – სრულ ექსპერიმენტული გამოგონებაზე უცხოური საპატენტო უწყების მიერ გაცემული დამცავი სახეობის ნომერი, თარიღი, რომლიდანაც იწყება ამ დამცავი სახეობის მოქმედება, და კოდი ქვეყნის ან რეგიონული ორგანიზაციისა, რომლის უწყებამაც გასცა ეს დამცავი სახეობა
- (62) – უფრო აღინიშნული განაცხადის ნომერი და, თუ შესაძლებელია, წარდგენის თარიღი გამოცალკევებული განაცხადის შემთხვევაში
- (71) – განმცხადებლის სახელი, გვარი [ქვეყნის კოდი]
- (72) – გამომგონებლის სახელი, გვარი [ქვეყნის კოდი]
- (73) – პატენტფლობელის სახელი, გვარი [ქვეყნის კოდი], მისამართი
- (74) – წარმომადგენლის ან პატენტმფუნდების სახელი, გვარი
- (85) – საერთაშორისო განაცხადის ეროვნული ფაზის დანერგვის თარიღი
- (86) – საერთაშორისო განაცხადის ნომერი და შეტანის თარიღი
- (87) – საერთაშორისო განაცხადის გამოქვეყნების ნომერი და თარიღი

ლიზინგები

- (10) – განაცხადის გამოქვეყნების ნომერი
- (11) – პატენტის ნომერი და სახეობის კოდი ან რეგისტრაციის ნომერი
- (15) – რეგისტრაციის თარიღი/პატენტის გაგრძელების თარიღი
- (18) – პატენტის ან რეგისტრაციის მოქმედების ვადის გასვლის საფარული თარიღი
- (21) – განაცხადის ნომერი
- (22) – განაცხადის შეტანის თარიღი
- (23) – საგამოყენებლო პრიორიტეტის თარიღი ან აღინიშნული პრიორიტეტის მქონე განაცხადის შეტანის თარიღი და, თუ შესაძლებელია, განაცხადის ნომერი
- (24) – თარიღი, რომლიდანაც იწყება პატენტის მოქმედება
- (28) – ღირებულების რაოდენობა განაცხადში
- (30) – საპროორიტეტო მონაცემები [განაცხადის ნომერი, განაცხადის შეტანის თარიღი და ორსაოიანი კოდი იმ ორგანიზაციის იდენტიფიკაციისათვის, სადაც იყო წარდგენილი საპროორიტეტო განაცხადი]
- (31) – საპროორიტეტო განაცხადის ნომერი
- (32) – საპროორიტეტო განაცხადის შეტანის თარიღი
- (33) – კოდი ქვეყნის ან რეგიონული ორგანიზაციისა, რომლის უწყებამაც მიანიჭა ნომერი საპროორიტეტო განაცხადს
- (34) – I.S.T. სტანდარტის (S.T.3) შესაბამისი ორსაოიანი კოდი იმ ორგანიზაციის იდენტიფიკაციისათვის, სადაც იყო წარდგენილი საპროორიტეტო განაცხადი
- (44) – ღირებულების გამოქვეყნების თარიღი და ბიულეტენის ნომერი [პირველი პუბლიკაცია]

- (45) – საერთაშორისო ბიუროს მიერ დარეგისტრირებული ღირებულების გამოქვეყნების თარიღი და ბიულეტენის ნომერი
- (51) – ღირებულების საერთაშორისო კლასიფიკაცია (ლოკარნოს კლასიფიკაციის კლასი და ქვეკლასი)
- (54) – ღირებულების დასახელება
- (55) – ღირებულების გამოსახულება
- (57) – ღირებულების არსებითი ნიშნების აღწერა, ფერის ჩათვლით
- (58) – ყველა სახის ცვლილების შესახებ რეკომენდებული ჩანაწერის შეტანის თარიღი
- (62) – აღინიშნული განაცხადის, რეგისტრაციის ან სახეობის ნომერი და, თუ შესაძლებელია, წარდგენის თარიღი, გამოცალკევებული განაცხადის შემთხვევაში
- (71) – განმცხადებლის სახელი, გვარი [ქვეყნის კოდი], მისამართი
- (72) – ავტორის სახელი, გვარი ან დასახელება [ქვეყნის კოდი]
- (73) – პატენტფლობელის სახელი, გვარი [ქვეყნის კოდი], მისამართი
- (74) – წარმომადგენლის სახელი, გვარი და მისამართი
- (81) – შესაბამისი მონაწილე მხარეები:
 - II. მონაწილე მხარეები, აღნიშნული 1960 წლის აქტის თანახმად
 - III. მონაწილე მხარეები, აღნიშნული 1999 წლის აქტის თანახმად
- (85) – მფლობელის მუდმივი საცხოვრებელი ადგილი
- (86) – მფლობელის მოქალაქეობა
- (87) – მფლობელის საცხოვრებელი ადგილი
- (88) – ქვეყანა, სადაც მფლობელს აქვს ნამდვილი და მოქმედი სამრეწველო ან სავაჭრო სანაწიმი

სასაქონლო ნიშნები

- (111) – რეგისტრაციის ნომერი
- (151) – რეგისტრაციის თარიღი
- (156) – რეგისტრაციის ვადის გაგრძელების თარიღი
- (181) – რეგისტრაციის ვადის გასვლის საფარული თარიღი
- (186) – ვადის გაგრძელების გასვლის საფარული თარიღი
- (141) – რეგისტრაციის მოქმედების ვადის გაუქმების თარიღი
- (210) – განაცხადის ნომერი
- (220) – განაცხადის შეტანის თარიღი
- (230) – საგამოყენებლო მონაცემები
- (260) – ნომერი განაცხადისა, რომელზედაც გამოტანილია ექსპერიმენტის დადებითი გადაწყვეტილება რეგისტრაციის შესახებ [გამოქვეყნების ნომერი]
- (310) – პირველი განაცხადის ნომერი
- (320) – პირველი განაცხადის შეტანის თარიღი
- (330) – პირველი განაცხადის მიმღები ეროვნული ან რეგიონული უწყების ან ორგანიზაციის საიდენტიფიკაციო კოდი
- (511) – საქონლისა და მომსახურების საერთაშორისო კლასიფიკაცია სასაქონლო ნიშნის რეგისტრაციისათვის და/ან კლასიფიკირებული საქონლისა და/ან მომსახურების ჩამონათვალი
- (526) – ლისენზაცია
- (531) – სასაქონლო ნიშნის გამოსახულებითი ელემენტების აღწერა სასაქონლო ნიშნის გამოსახულებითი ელემენტების საერთაშორისო კლასიფიკაციის (ვენის კლასიფიკაცია) მიხედვით

- (540) – ნიშნის გამოსახულება
- (550) – სასაქონლო ნიშნის ტიპი ან სახეობა
- (580) – განაცხადსა და ნიშნის რეგისტრაციისათვის დაკავშირებული ყველა სახის ცვლილებას ჩანაწერის შეტანის თარიღი
- (591) – ინფორმაცია განაცხადებულ ფერებზე
- (731) – განმცხადებლის სახელი და მისამართი
- (732) – მფლობელის სახელი და მისამართი
- (740) – წარმომადგენლის სახელი და მისამართი
- (750) – მიმწერის მისამართი
- (770) – ცვლილებამდე განმცხადებლის ან მფლობელის სახელი და მისამართი უფლების გადაცემის შემთხვევაში
- (771) – ცვლილებამდე განმცხადებლის ან მფლობელის სახელი და მისამართი უფლების გადაცემის გარეშე
- (791) – ლიცენზიაციის სახელი და მისამართი
- (793) – ლიცენზიის პირობები და/ან შეზღუდვა მინიშნება (ლიცენზიის სახე, სალიცენზიო ხელშეკრულების ნომერი, სალიცენზიო ხელშეკრულების თარიღი, სალიცენზიო ხელშეკრულების მოქმედების ვადა)
- (800) – სასაქონლო ნიშნის რეგისტრაციის მონაცემები ნიშნის საერთაშორისო რეგისტრაციის მდრიდის ხელშეკრულებასთან დაკავშირებული პროცედურის მიხედვით [საერთაშორისო რეგისტრაციის ნომერი]
- (891) – შემდგომი გავრცელების თარიღი

- (21) AP 0000 000000 – გამოგონებაზე განაცხადის ნომერი
- (10) AP 0000 0000 A – გამოგონებაზე განაცხადის გამოქვეყნების ნომერი [პირველი პუბლიკაცია]
- (11) P 0000 0000 B – გამოგონების პატენტის ნომერი [მეორე პუბლიკაცია]
- (21) API 0000 000000 – შემოტანილ პატენტზე განაცხადის ნომერი
- (11) PI 0000 0000 A – შემოტანილი პატენტის ნომერი [პირველი პუბლიკაცია]
- (21) AU 0000 000000 – სასარგებლო მოდელებზე განაცხადის ნომერი
- (10) AU 0000 000 U – სასარგებლო მოდელებზე განაცხადის გამოქვეყნების ნომერი [პირველი პუბლიკაცია]
- (11) U 0000 000 Y – სასარგებლო მოდელების პატენტის ნომერი [მეორე პუბლიკაცია]
- (21) AD 0000 000000 – ღირებულება განაცხადის ნომერი
- (10) AD 0000 000 S – ღირებულება განაცხადის გამოქვეყნების ნომერი [პირველი პუბლიკაცია]
- (11) D 0000 000 S – რეგისტრირებული ღირებულება

გამოგონებებისა და სასარგებლო მოდელების საერთაშორისო კლასიფიკაციის იდენტიფიკაცია

- განყოფილება A – ადამიანის პირველადი მოთხოვნილებების საგნები
- განყოფილება B – ტექნოლოგიური პროცესები; ტრანსპორტირება
- განყოფილება C – ქიმიკა; მეტალურგია
- განყოფილება D – საფეიქრო ნაწარმი; ქაღალდი
- განყოფილება E – მშენებლობა; საძოო საქმი; სტაციონარული ნაგებობები
- განყოფილება F – მექანიკა; განათება; გათბობა; იარაღი; ასაფეთქებელი სამუშაოები
- განყოფილება G – ფიზიკა
- განყოფილება H – ელექტრობა

- M – სასაქონლო ნიშანი
- (210) AM 0000 000000 – განაცხადის ნომერი
- (260) AAM 0000 00000 A – განაცხადის გამოქვეყნების ნომერი
- (111) M 0000 00000 Rn – რეგისტრაციის ნომერი
- MMM0000 00000 Rn – მომღვერო ვადით რეგისტრაციის ნომერი, სადაც n=1,2,3...
- M 0000 00000 R(P) – რეგისტრაციის ნომერი ნიშანზე უფლების ნაწილობრივი გადაცემისას
- * – საქპატენტის საპულააციო პალატის გადაწყვეტილების შემდეგ გამოქვეყნებული განაცხადის ნომერი
- ** – სასამართლოს გადაწყვეტილების შემდეგ გამოქვეყნებული განაცხადის ნომერი

**ისმო-ს წევრი სახელმწიფოებისა და ორგანიზაციების აღნიშვნის
ორასოიანი კოდეზი
(ისმოს სტანდარტი ST.3)**

AD	ანდორა	GD	გრენადა	MY	მალაიზია
AE	არაბთა გაერთიანებული საამიროები	GE	საქართველო	MZ	მოზამბიკი
AF	ავღანეთი	GG	გენზი	NA	ნამიბია
AG	ანტიგუა და ბარბუდა	GH	განა	NE	ნიგერი
AI	ანგილია	GI	გიბრალტარი	NG	ნიგერია
AL	ალბანეთი	GL	გრენლანდია	NI	ნიჟარაგუა
AM	სომხეთი	GM	გამბია	NL	ნიდერლანდები
AN	ანტილის კუნძულები (ნიდერლანდები)	GN	გვინეა	NO	ნორვეგია
AO	ანგოლა	GQ	ეკვატორული გვინეა	NP	ნეპალი
AP	ინტელექტუალური საკუთრების აფრიკის რეგიონალური ორგანიზაცია (ARIPO)	GR	საბერძნეთი	NR	ნაურუ
AR	არგენტინა	GS	სამხრეთი ჯორჯია და სამხრეთი სენდვიჩის კუნძულები	NZ	ახალი ზელანდია
AT	ავსტრია	GT	გვატემალა	OA	აფრიკის ინტელექტუალური საკუთრების ორგანიზაცია (OAPI)
AU	ავსტრალია	GW	გვინეა-ბისაუ	OM	ომანი
AW	არუბა	GY	გაიანა	PA	პანამა
AZ	აზერბაიჯანი	HK	ჰონგ კონგი	PE	პერუ
BA	ბოსნია და ჰერცეგოვინა	HN	ჰონდურასი	PG	პაპუა-ახალი გვინეა
BB	ბარბადოსი	HR	ხორვატია	PH	ფილიპინები
BD	ბანგლადეში	HT	ჰაიტი	PK	პაკისტანი
BE	ბელგია	HU	უნგრეთი	PL	პოლონეთი
BF	ბურკინა-ფასო	IB	ინტელექტუალური საკუთრების მსოფლიო ორგანიზაციის (ისმო, WIPO) საერთაშორისო ბიურო	VE	ვენესუელა
BG	ბულგარეთი	ID	ინდონეზია	VG	ვირჯინის კუნძულები (ბრიტანეთი)
BH	ბაჰრეინი	IE	ირლანდია	PY	პარაგვაი
BI	ბურუნდი	IL	ისრაელი	QA	კატარი
BJ	ბენინი	IM	მენის კუნძული	QZ	ევროპის თანამეგობრობის მცენარეთა ჯიშების უწყება (CPVO)
BM	ბერმუდის კუნძულები	IN	ინდოეთი	RO	რუმინეთი
BN	ბრუნეი-დარუსალამი	IQ	ერაყი	RS	სერბია
BO	ბოლივია	IR	ირანის ისლამური რესპუბლიკა	RU	რუსეთის ფედერაცია
BR	ბრაზილია	IS	ისლანდია	RW	რუანდა
BS	ბაჰამის კუნძულები	IT	იტალია	SA	საუდის არაბეთი
BT	ბჰუტანი	JE	ჯეზი	SB	სოლომონის კუნძულები
BV	ბუვეტის კუნძულები	JM	იამაიკა	SC	სეიშელის კუნძულები
BW	ბოტსვანა	JO	იორდანია	SD	სუდანი
BX	ბენელუქსის ინტელექტუალური საკუთრების უწყება (BOIP)	JP	იაპონია	SE	შვედეთი
BY	ბელორუსია	KE	კენია	SG	სინგაპური
BZ	ბელისი	KG	ყირგიზეთი	SH	წმინდა ჰელენის კუნძული
CA	კანადა	KH	კამბოჯა	SI	სლოვენია
CD	კონგოს დემოკრატიული რესპ.	KI	კირიბატი	SK	სლოვაკია
CF	ცენტრალური აფრიკის რესპ.	KM	კომორის კუნძულები	SL	სიერა-ლეონე
CG	კონგო	KN	სენტ კიტსი და ნევისი	SM	სან-მარინო
CH	შვეიცარია	KP	კორეის სახალხო დემოკრატიული რესპუბლიკა	SN	სენეგალი
CI	კოტ-დ'ივუარი	KR	კორეის რესპუბლიკა	SO	სომალი
CK	კუკის კუნძულები	KW	კუვეიტი	SR	სურინამი
CL	ჩილე	KY	კაიმენის კუნძულები	ST	სან-ტომე და პრინსიპი
CM	კამერუნი	KZ	ყაზახეთი	SV	სალვადორი
CN	ჩინეთი	LA	ლაოსი	SY	სირია
CO	კოლუმბია	LB	ლიბანი	SZ	სვაზილენდი
CR	კოსტა-რიკა	PT	პორტუგალია	TC	თურქის და კაიკოსის კუნძულები
CU	კუბა	PW	პალაუ	TD	ჩადი
CV	მწვანე კონცხის კუნძულები	LC	სენტ-ლუსია	TG	ტოგო
CY	კვიპროსი	LI	ლიხტენშტაინი	TH	ტაილანდი
CZ	ჩეხეთის რესპუბლიკა	LK	შრი-ლანკა	TJ	ტაჯიკეთი
DE	გერმანია	LR	ლიბერია	TL	ტიმოლ-ლესტე
DJ	ჯიბუტი	LS	ლესოტო	TM	თურქმენეთი
DK	დანია	LT	ლიტვა	TN	ტუნისი
DM	დომინიკა	LU	ლუქსემბურგი	TO	ტონგა
DO	დომინიკელთა რესპუბლიკა	LV	ლატვია	TR	თურქეთი
DZ	ალჟირი	LY	ლიბია	TT	ტრინიდადი და ტობაგო
EA	ევრაზიის საპატენტო ორგანიზაცია (EAPO)	MA	მაროკო	TV	ტუვალუ
EC	ეკვადორი	MC	მონაკო	TW	ტაივანი, ჩინეთის პროვინცია
EE	ესტონეთი	MD	რესპუბლიკა მოლდოვა	TZ	ტანზანია
EG	ეგვიპტე	ME	ჩერნოგორია (მონტენეგრო)	UA	უკრაინა
EH	დასავლეთი საჰარა	MG	მადაგასკარი	UG	უგანდა
EM	მინაგანი ბაზრის ჰარმონიზაციის უწყება (სასაქონლო ნიშნების და სამრეწველო ნიშნების (OHIM) ევროპის საპატენტო უწყება (EPO))	MK	მაკედონია ყოფილი იუგოსლავიის რესპუბლიკა	US	ამშ
EP	ევროპის საპატენტო უწყება (EPO)	ML	მალი	UY	ურუგვაი
ER	ერიტრეა	MM	მიანმა	UZ	უზბეკეთი
ES	ესპანეთი	MN	მონღოლეთი	VA	ვატიკანი
ET	ეთიოპია	MO	მაკაო	VC	სანტ-ვინსენტი და გრენადინები
FI	ფინეთი	MP	ჩრდ. მარიანას კუნძულები	VN	ვიეტნამი
FJ	ფიჯი	MR	მავრიტანია	VU	ვანუატუ
FK	ფოლკლენდის კუნძულები	MS	მოსკერავტი	WO	WIPO-ინტელექტუალური საკუთრების მსოფლიო ორგანიზაცია
FO	ფარერის კუნძულები	MT	მალტა	WS	სამოა
FR	საფრანგეთი	MU	მავრიკია	XN	ნორდული საპატენტო ინსტიტუტი (NPI)
GA	გაბონი	MV	მალდივის კუნძულები	YE	იემენი
GB	დიდი ბრიტანეთი	MW	მალავი	ZA	სამხრეთ აფრიკა
GC	სპარსეთის ყურის არაბული სახელმწიფოების თანამშრომლობის საბჭოს უწყება (GCC)	MX	მექსიკა	ZM	ზამბია
				ZW	ზიმბაბვე

შ ი ნ ა ა რ ს ი

გამოკვეთილი ობიექტები	3
გამოგონები	
• განაცხადები, რომლებზეც გამოტანილია გადაწყვეტილება პატენტის გაცემის შესახებ	4
• გამოგონების პატენტები	5
სასარგებლო მოდელები	
• განაცხადები, რომლებზეც გამოტანილია გადაწყვეტილება პატენტის გაცემის შესახებ	8
• სასარგებლო მოდელების პატენტი.....	9
დიზაინები	
• განაცხადები, რომლებზეც გამოტანილია გადაწყვეტილება რეგისტრაციის შესახებ	10
• რეგისტრირებული დიზაინი.....	12
• საერთაშორისო ბიუროში რეგისტრირებული დიზაინები, რომლებზეც გამოტანილია გადაწყვეტილება საქართველოს ტერიტორიაზე რეგისტრაციის მოქმედების გავრცელების შესახებ.....	13
სასაქონლო ნიშნები	
• ეროვნული პროცედურით შემოტანილი განაცხადები, რომლებზეც გამოტანილია გადაწყვეტილება რეგისტრაციის შესახებ	39
• დაჩქარებული პროცედურით რეგისტრირებული სასაქონლო ნიშნები	47
• საერთაშორისო სასაქონლო ნიშნები, რომლებზეც გამოტანილია გადაწყვეტილება დაცვის მინიჭების შესახებ	49
• საერთაშორისო სასაქონლო ნიშნები, რომლებსაც მიენიჭათ დაცვა საქართველოში.....	131
ოფიციალური შეტყობინებები	
გამოგონება	
• პატენტების მოქმედების აღდგენა.....	139
სასაქონლო ნიშნები	
• სასაქონლო ნიშნის რეგისტრაციის ბათილად ცნობა	140
სისტემური საძიებლები	
გამოგონებები	141
სასარგებლო მოდელები	143
დიზაინი	144
სასაქონლო ნიშნები	145

გამოქვეყნებული ოზიქტები

გამოგონებები

- განაცხადები:
12624
- პატენტები:
6050-6058

სასარგებლო მოდელები

- განაცხადი:
12841
- პატენტი:
1801-1803

ღიზინები

- განაცხადები:
769, 770; 778
- რეგისტრირებული ღიზინი:
570-572
- საერთაშორისო ბიუროში რეგისტრირებული ღიზინები, რომლებზეც გამოტანილია გადაწყვეტილება საქართველოს ტერიტორიაზე რეგისტრაციის მოქმედების გავრცელების შესახებ
82239; 82258; 82282; 82288; 81660; 82334; 79775; 81087; 81088, 81089; 81098; 81178; 82414; 81256; 81817; 82481; 82488; 82505

სასაქონლო ნიშნები

- ეროვნული პროცედურით გამოტანილი განაცხადები:
71529; 71656, 71657; 71994; 72328; 72743, 72744; 72791; 72800, 72801; 72810; 72854; 72856, 72857; 72874; 72930; 72972, 72973; 73002; 73100; 73105; 73125; 73184, 73185
- დაქარაზებული პროცედურით რეგისტრირებული სასაქონლო ნიშნები:
24525-24528
- საერთაშორისო სასაქონლო ნიშნები, რომლებზეც გამოტანილია გადაწყვეტილება დაცვისმინიჭების შესახებ:
70528, 70529; 70531, 70532; 70534, 70535; 70537, 70538; 70540; 70542; 70633-70638; 70641, 70642; 70646, 70647; 70653-70656; 70658-70661; 70835; 70853; 70859; 70883, 70884; 70887; 70889; 70891, 70892; 70974; 70981, 70982; 71046, 71047; 71050-71052; 71193-71196; 71199-71202; 71204-71211; 71213-71219; 71226-72229; 71231-71236; 71239; 71241-71243; 71245, 71246; 71249-71251; 71262-71270; 71332; 71563; 71583; 71740, 71741; 71743-71745; 71747; 71749-71757; 71760, 70761; 71763, 71764; 71767; 71774-71778; 71787, 71788; 71891, 71892; 71896-71899; 72086, 72087; 72089; 72091, 72092; 72094-72098; 72102; 72105-72107; 72109-72112; 72115-72123; 72126; 72128-72130; 72255; 72258-72262; 72266, 72267; 72269; 72276; 72279-72281; 72287, 72288; 72663-72667; 73218; 73676; 73678, 73679; 60858*
- საერთაშორისო სასაქონლო ნიშნები, რომლებსაც მიენიჭათ დაცვა საქართველოში:
68887-68892; 68895-68900; 68912, 68913; 68915; 69071; 69074, 69075; 69146; 69151; 69235; 69416; 69526; 69715; 69881-69884; 69886; 69888-69890; 69892-69894; 69942-69954; 69966; 70065, 70066; 70069; 70149-70154; 70159, 70160; 70167-70174; 70176-70181; 70183-70187; 70194; 70202-70204; 70253; 70255; 70318; 70320-70331; 70339-70343; 70382-70387; 70391; 70393-70397

გამოგონებები

ბანასხაღები, რომლებზეც გამოტანილია გადაწყვეტილება პატენტის ბასემის შესახებ

გადაწყვეტილების გასახიფრება შესაძლებელია საქპატენტის სააპელაციო პალატაში გამოქვეყნებიდან 3 თვის ვადაში ან მცხეთის რაიონული სასამართლოს ადმინისტრაციულ საქმეთა კოლეგიაში 1 თვის ვადაში (მის.: ქ. მცხეთა, სამხედროს ქ. №17).

განყოფილება C

C 07

(10) AP 2014 12624 A (51) Int. Cl. (2006)
C 07 D 231/12
C 07 D 401/04
C 07 D 401/06
C 07 D 401/12
C 07 D 401/14

(21) AP 2010 012624 (22) 2010 08 06

(31) 09167741.9

(32) 2009 08 12

(33) EP

(71) სინჯუნტა პარტიციპეიშენს აგ (CH)
შვარცვალდალეე 215, CH-4058,
ბაზელი (CH)

(72) სარა სულზერ-მოსი (FR);
კლემენს ლამბერტი (DE);
ლაურა კვარანტა (IT);
მატიას, სტეფან რესპონდეკი (DE)

(74) თამარ კოჭლამაზაშვილი

(85) 2012 03 12

(86) PCT/EP2010/061464, 2010 08 06

(54) მიკრობიოციდური პეპტიდები

(57) ნაერთი ფორმულით (I),

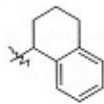
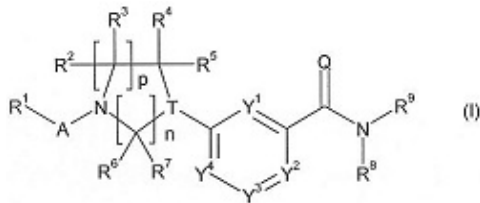

(a)

ფუნგიციდური კომპოზიცია მის საფუძველზე და მისი გამოყენება მიკრობების კონტროლის მიზნით.

მუხლები: 4 დამოუკიდებელი
11 დამოკიდებული

ცხრილი: 2

ბამომონების კატეგორია

ბანყოფილება A

A 01

- (11) P 2014 6052 B (51) Int. Cl. (2006)
 A 01 N 43/62
 A 61 K 31/55
- (10) AP 2013 12106 A (44) 22(386)/2013
 (21) AP 2009 012106
 (22) 2009 07 16
 (24) 2009 07 16
 (31) 61/081,052
 (32) 2008 07 16
 (33) US
 (86) PCT/US2009/050835, 2009 07 16
 (73) რისტერ გედონ ნორტ. (HU)
 დომროი უტ. 19 - 21, H-1103
 ბუდაპეშტი (HU)
 (72) რანჯოი სარკარი (IN);
 მახენდრა გ. დედხიაი (US);
 ენილ შეტრი (IN)
 (74) ლილიანა დარახველიძე
 (54) **ფოკამინის რეცეპტორის ლიბანდების
 შემცველი ფარმაცევტული
 კომპოზიციები**

A 61

- (11) P 2014 6058 B (51) Int. Cl. (2006)
 A 61 K 33/26
 A 61 K 49/00
 H 01 F 1/28
 H 05 B 6/10
- (10) AP 2013 12942 A (44) 22(386)/2013
 (21) AP 2012 012942
 (22) 2012 12 25
 (24) 2012 12 25
 (73) ბესიკ სურგულაძე (GE)
 ბარათაშვილის ქ. 6/10, ბ. 48,
 თბილისი (GE)
 (72) ბესიკ სურგულაძე (GE)
 (54) **პრეპარატი ავთვისებიანი სიმსივნეების
 დროს მეთრადი მეთასტაზირების
 დიაგნოსტიკისა და მკურნალობი-
 სათვის**

- (11) P 2014 6050 B (51) Int. Cl. (2006)
 A 61 K 39/395
 C 07 K 16/22
 G 01 N 33/53
 C 12 N 15/68
 C 12 N 5/10
 A 61 P 25/00
 A 61 P 35/00
- (10) AP 2013 11890 A (44) 22(386)/2013
 (21) AP 2004 011890
 (22) 2004 07 15
 (24) 2004 07 15
 (62) 60/487,431 2003 07 15 (US)
 (31) 60/487,431
 (32) 2003 07 15
 (33) US
 (86) PCT/US2004/022876, 2004 07 15
 (73) ამჯენ ინკ. (US)
 ვან ამჯენ სენტერ დრაივ, თაუსენდ ლუკს,
 კალიფორნია 91320-1799 (US);
 მედარექს, ინკ. (US)
 707 სთეით როუდ პრინსტონი, ნიუ ჯერსი
 08540 (US)
 (72) კენეთ დ. ვაილდი (US);
 ჯეიმს ჯ. ს. ტრინორი (GB);
 ჰაიუნ ჰუნგი (US);
 ჰეთერ ინოუე (US);
 ტიუ ჯ. ჟანგი (US);
 ფრენკ მარტინი (US)
 (74) შალვა გვარამაძე
 (54) **ალამიანის ანტი-NGF
 გამანეიტრალებელი ანტი-სეპტინი,
 როგორც NGF ბზის შერჩევითი
 ინჰიბიტორები**

- (11) P 2014 6051 B** **(51) Int. Cl. (2006)**
A 61 L 2/16
A 61 L 2/18
- (10) AP 2013 12078 A (44) 22(386)/2013
 (21) AP 2009 012078
 (22) 2009 06 29
 (24) 2009 06 29
 (31) 12/167,343; 12/491,943
 (32) 2008 07 03; 2009 06 25
 (33) US; US
 (86) PCT/US2009/049001, 2009 06 29
- (73) რეგრატივულ ტექნოლოჯის, ინკ. (US)
 511 ლობო ლეინ, ლიტლ ელმ, ტეხასი
 75068 (US);
 თომას, ჯ. შაუ (US)
 5310 ბუენა ვისტა, ფრისკო, ტეხასი,
 75034 (US)
- (72) თომას, ჯ. შაუ (US);
 ნი ჟუ (US);
 მარკ სმოლ (US);
 სტივენ, ე. შაუ (US)
- (74) ალექსანდრე გეგეჰკორი
 (54) **საწმენდი მოწყობილობა**

- (72) ალექსანდრე პასტერნაკი (US);
 აურაშ შაპრიპური (US);
 ხაიფინ ტანი (CN);
 ნარდოს ჰ.ტუმელსანი (ET);
 ლიპუ იანი (US);
 იუპინ ჩუ (CN);
 შონ პ. ოულში (US)
- (74) შალვა გვარამაძე
 (54) **თირკმლის ბარე მელულარული
 კალიუმის არხის ინჰიბიტორები**

ბანყოფილება C

C 07

- (11) P 2014 6055 B** **(51) Int. Cl. (2006)**
C 07 D 307/88
C 07 D 405/08
C 07 D 407/08
C 07 D 413/08
C 07 D 487/08
C 07 D 493/04
C 07 D 295/135
C 07 D 295/155
A 61 K 31/495
A 61 K 31/529
A 61 P 7/10
- (10) AP 2013 12494 A (44) 22(386)/2013
 (21) AP 2010 012494
 (22) 2010 04 29
 (24) 2010 04 29
 (31) 61/175847
 (32) 2009 05 06
 (33) US
 (86) PCT/US2010/032872, 2010 04 29
- (73) მერკ შარპ & დოუმ კორპ. (US)
 126 ისტ ლინკოლნ ავენიუ, რავეი,
 ნიუ ჯერსი 07065 (US)

- (11) P 2014 6053 B** **(51) Int. Cl. (2006)**
C 07 D 473/04
C 07 D 487/04
A 61 K 31/52
A 61 K 31/519
A 61 P 37/00
- (10) AP 2013 12209 A (44) 22(386)/2013
 (21) AP 2009 012209
 (22) 2009 10 29
 (24) 2009 10 29
 (31) 61/109,821; 61/242,765
 (32) 2008 10 30; 2009 09 15
 (33) US; US
 (86) PCT/US2009/062646, 2009 10 29
- (73) აიერემ ელელსი (US)
 131 ფრონტ სტრიტ, ს/ე HM 2899,
 ჰამილტონი, HM LX (BM) (US);
 ზი სკრიპს რისერჩ ინსტიტიუტ (US)
 10550 ნორთ ტორეი პაინს როუდ,
 ლა ჯოლა, კალიფორნია 92037 (US)
- (72) ენტონი ბოიტანო (US);
 მაიკლ კუკი (US);
 შიფენგ პანი (US);
 პიტერ ჯ. შულცი (US);
 ჯონ ტელიუ (US);
 იონგჰინ ვანი (US);
 ხინგ ვანგი (CN)
- (74) ალექსანდრე ქართველიშვილი
 (54) **ნაერთები ჰემოკოაგულური ფეროზანი
 უჯრედების რაოდენობის
 ბაზრდისათვის**

- (11) P 2014 6056 B** **(51) Int. Cl. (2006)**
C 07 K 14/605
A 61 K 38/26
A 61 P 5/48
- (10) AP 2013 12567 A (44) 22(386)/2013
 (21) AP 2010 012567
 (22) 2010 06 24
 (24) 2010 06 24
 (31) 09251780.4; 61/225080; 10157240.2;
 PA201000412
 (32) 2009 07 13; 2009 07 13; 2010 03 22; 2010 05 10
 (33) EP; US; EP; DK
 (86) PCT/DK2010/000099, 2010 06 24

- (73) ზილენდ ფარმა ა/ს (DK)
სმედელენდ 36, DK-2600 გლოსტრაპი (DK)
- (72) ლიტე რიბერი (DK);
ელი შეიერი (DK);
იენს როსენგრენ დაუგაარდი (DK);
მარი სკოვგაარდი (DK);
იაკობ ლინდ ტოლბორგი (DK);
გიტა კამპენი (DK);
კამილა ერტებერგ ბეკი (DK)
- (74) შალვა გვარამაძე
- (54) **ბლუპაბონის აცილირებული ანალოგები**

- ზურაბ ვარსიმაშვილი (GE)
მცხეთის ქ. 20, ბ. 34, 0179,
თბილისი (GE);
რევაზ კახიანი (GE)
სულხან ცინცაძის ქ. 56, ბ.1, 0160,
თბილისი (GE);
აკაკი კახიანი (GE)
სულხან ცინცაძის ქ. 56, ბ.1, 0160,
თბილისი (GE)
- (72) რევაზ ვარსიმაშვილი (GE);
მერაბ კახიანი (GE);
ზურაბ ვარსიმაშვილი (GE);
რევაზ კახიანი (GE);
აკაკი კახიანი (GE)
- (54) **კბილა ბაღანმა**

C 12

- (11) P 2014 6057 B (51) Int. Cl. (2006)
C 12 C 11/00
- (10) AP 2013 12620 A (44) 22(386)/2013
- (21) AP 2010 012620
- (22) 2010 08 20
- (24) 2010 08 20
- (31) 61/274875; 61/280860; 61/283524; 12/777238
- (32) 2009 08 21; 2009 11 09; 2009 12 04; 2010 05 10
- (33) US; US; US; US
- (86) PCT/US2010/046211, 2010 08 20
- (73) პროტია ლლს (US)
15025 ბრიოლი დრ., რენო, ნევადა
89511(US)
- (72) ენთონი ცზარნიკი (US);
ჯეფრი მაკკინლი (US)
- (74) შალვა გვარამაძე
- (54) **აქტივაციის უმცირესი რისკის მქონე ალკოჰოლური კომპოზიციები**

განყოფილება F

F 16

- (11) P 2014 6054 B (51) Int. Cl. (2006)
F 16 H 3/56
- (10) AP 2013 12491 A (44) 20(384)/2013
- (21) AP 2011 012491
- (22) 2011 12 06
- (24) 2011 12 06
- (73) რევაზ ვარსიმაშვილი (GE)
ვაჟა-ფშაველას გამზ., V კვარტ., კორპ. 4,
ბ. 82, 0186, თბილისი (GE);
მერაბ კახიანი (GE)
სულხან ცინცაძის ქ. 56, ბ. 1, 0160,
თბილისი (GE);

სასარგებლო მოდელები

ბანასხადები, რომლებზეც გამოტანილია გადაწყვეტილება პატენტის ბასემის შესახებ

გადაწყვეტილების გასაჩივრება შესაძლებელია საქპატენტის სააპელაციო პალატაში გამოქვეყნებიდან 3 თვის ვადაში ან მცხეთის რაიონული სასამართლოს ადმინისტრაციულ საქმეთა კოლეგიაში 1 თვის ვადაში (მის.: ქ. მცხეთა, სამხედროს ქ. №17).

ბანყოფილება E

E 01

(10) AU 2014 12841 U (51) Int. Cl. (2006)
E 01 D 1/00

(21) AU 2012 012841 (22) 2012 08 21

(71) ზაურ კაჭარავა (GE)

გლდანის მას., VIII მკრ., კორპ.12, ბ. 141,
0107, თბილისი (GE)

(72) ზაურ კაჭარავა (GE)

(54) მოწყობილობა რეგულირებად
გადასასვლელზე ქვეითად
მოსიარულეთა გადასაყვანად

(57) მოწყობილობა რეგულირებად გადასასვლელზე ქვეითად მოსიარულეთა გადასაყვანად შეიცავს შუქნიშანთან 1 დაკავშირებულ ტროტუარებს შორის საპირისპიროდ და სინქრონულად მოძრავ. ამძრავებით 2 აღჭურვილ ორ კაბინას 3 და 4.

მუხლები: 1 დამოუკიდებელი

ფიგურა: 1

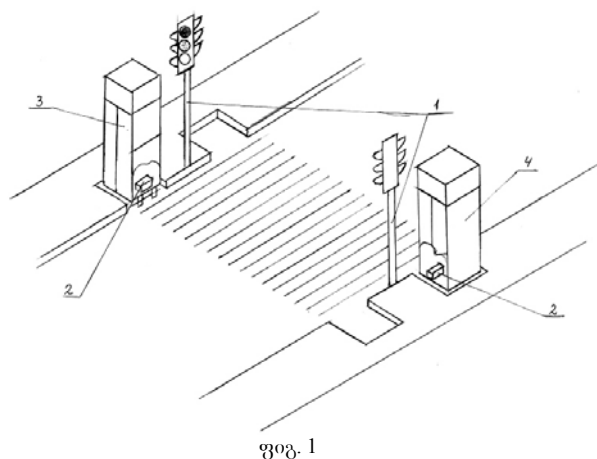

სასარგებლო მოდელების კატენტი

განყოფილება A

A 23

- (11) U 2014 1803 Y (51) Int. Cl. (2006)
A 23 L 1/22
- (10) AU 2013 13085 U (44) 22(386)/2013
- (21) AU 2013 013085
- (22) 2013 05 10
- (24) 2013 05 10
- (73) ზვიად გუგავა (GE)
დავით აღმაშენებლის ქ. 1, 2900,
დაბა ლენტეხი (GE)
- (72) ზვიად გუგავა (GE)
- (74) ხათუნა იმნაძე
- (54) სუნელ-სანელებელი

A 61

- (11) U 2014 1801 Y (51) Int. Cl. (2006)
A 61 K 9/02
- (10) AU 2013 12914 U (44) 22(386)/2013
- (21) AU 2012 012914
- (22) 2012 12 07
- (24) 2012 12 07
- (73) შპს „ავერსი-რაციონალი“ (GE)
ჭირნახულის ქ. 14, 0198, თბილისი (GE)
- (72) მალხაზ კურტანიძე (GE)
- (74) შალვა გვარამაძე
- (54) კომბინირებული მცენარეული პარა-სამკურნალო საშუალება მენსიერების სტიმულირებისათვის სიროფის ფორმით

- (11) U 2014 1802 Y (51) Int. Cl. (2006)
A 61 K 9/02
- (10) AU 2013 12915 U (44) 22(386)/2013
- (21) AU 2012 012915
- (22) 2012 12 07
- (24) 2012 12 07
- (73) შპს „ავერსი-რაციონალი“ (GE)
ჭირნახულის ქ. 14, 0198, თბილისი (GE)
- (72) მალხაზ კურტანიძე (GE)
- (74) შალვა გვარამაძე
- (54) კომბინირებული მცენარეული პარა-სამკურნალო საშუალება მენსიერების სტიმულირებისათვის კაფსულის ფორმით

დიზაინები

ბანასხადი, რომელზეც გამოტანილია გადაწყვეტილება რეგისტრაციის შესახებ

გადაწყვეტილების გასაჩივრება შესაძლებელია საქპატენტის სააპელაციო პალატაში გამოქვეყნებიდან 3 თვის ვადაში ან მცხეთის რაიონული სასამართლოს ადმინისტრაციულ საქმეთა კოლეგიაში 1 თვის ვადაში (მის.: ქ. მცხეთა, სამხედროს ქ. №17).

(10) AD 2014 769 S (51) 25-03

(21) AD 2013 000769

(22) 2013 11 11

(28) 1

(71) ბექა ფხაკაძე (GE)

ვაჟა-ფშაველას გამზ., II კვარტ., კორპ. 22, ბ. 5, 0186, თბილისი (GE)

(72) ბექა ფხაკაძე (GE)

(54) **შენობა**

(55)



1.1



1.2



1.3

(10) AD 2014 770 S (51) 09-01

(21) AD 2013 000770

(22) 2013 11 12

(28) 1

(71) სიმონ ბეღელაძე (GE)

სოფ. გამოღმა არგვეთი, 4000, საჩხერე (GE)

(72) სიმონ ბეღელაძე (GE)

(54) **კონტაინერი-სუშენი**

(55)



1.1



1.2



1.3

(10) AD 2014 778 S (51) 17-01

(21) AD 2013 000778

(22) 2013 12 12

(28) 1

(71) ომარ კვინიკაძე (GE)

დიდის მას., III კვარტ., კორპ. 39, ბ. 61, 0159, თბილისი (GE)

(72) ომარ კვინიკაძე (GE)

(54) კლავიატურა მუსიკალური ინსტრუმენტისათვის

(55)

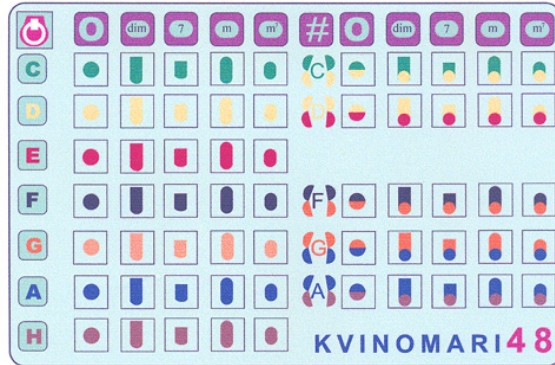

რეგისტრირებული ღიზანი

(11) D 2014 570 S **(51) 13-03**
(10) AD 2013 755 S (44) 22(386) 2013
(21) AD 2013 000755
(22) 2013 07 12
(24) 2013 07 12
(28) 1
(18) 2018 07 12
(73) გიუნსან ელექტრიქ მალზემელერი
სანაი ვე ტიჯარეტ ანონიმ შირკეტი (TR)
ოსმანგაზი მახ. ილდირიმ ბეიაზიტ ჯად
N 29 სანჯაკტეპე სტამბული 34887 (TR)
(72) გუნი მურატ (TR)
(74) ქეთევან წაქაძე
(54) ელექტრონული მოწყობილობის
პარკასი

(11) D 2014 571 S **(51) 13-03**
(10) AD 2013 756 S (44) 22(386) 2013
(21) AD 2013 000756
(22) 2013 07 12
(24) 2013 07 12
(28) 1
(18) 2018 07 12
(73) გიუნსან ელექტრიქ მალზემელერი
სანაი ვე ტიჯარეტ ანონიმ შირკეტი (TR)
ოსმანგაზი მახ. ილდირიმ ბეიაზიტ ჯად
N 29 სანჯაკტეპე სტამბული 34887 (TR)
(72) გუნი მურატ (TR)
(74) ქეთევან წაქაძე
(54) ელექტრონული ჩამრთველი

(11) D 2014 572 S **(51) 13-03**
(10) AD 2013 757 S (44) 22(386) 2013
(21) AD 2013 000757
(22) 2013 07 12
(24) 2013 07 12
(28) 1
(18) 2018 07 12
(73) გიუნსან ელექტრიქ მალზემელერი
სანაი ვე ტიჯარეტ ანონიმ შირკეტი (TR)
ოსმანგაზი მახ. ილდირიმ ბეიაზიტ ჯად
N 29 სანჯაკტეპე სტამბული 34887 (TR)
(72) გუნი მურატ (TR)
(74) ქეთევან წაქაძე
(54) ტელევიზორის ორბიტო

საერთაშორისო ბიუროში რეგისტრირებული ლიზენიები, რომლებზეც გამოტანილია გადაწყვეტილება საქართველოს ტერიტორიაზე რეგისტრაციის მოქმედების გავრცელების შესახებ

გადაწყვეტილების გასაჩივრება შესაძლებელია საქპატენტის სააპელაციო პალატაში გამოქვეყნებიდან 3 თვის ვადაში ან მცხეთის რაიონული სასამართლოს ადმინისტრაციულ საქმეთა კოლეგიაში 1 თვის ვადაში (მის.: ქ. მცხეთა, სამხედროს ქ. №17).

(11) DM/082239 (51) 13-02

(15) 2012 12 04 (45) 2013/48 (2013 12 06)

(22) 2012 12 04 (28) 1

(30) 05.06.2012; 2012-013285; JP

(73) SONY OVERSEAS SA Wiesenstrasse 5, CH-8952 Schlieren (CH)

(85) --

(86) CH

(87) CH

(88) CH

(89) CH

(81) II. BZ, KP, MA, SR. III. AL, AM, AZ, BA, BW, CH, EG, GE, GH, HR, IS, KG, LI, MC, MD, ME, MK, MN, NA, NO, OA, OM, RS, RW, SG, ST, SY, TJ, TN, TR, UA

(72) 1) Kiyoshi Yonishi, c/o Sony Energy Devices Corporation, 1-1 Shimosugishita, Takakura Hiwada-machi, Koriyama-shi, Fukushima, Japan; 2) Atsuhiko Kumagai, c/o Sony Corporation, 1-7-1 Konan, Minato-ku, Tokyo, Japan

(54) 1. Rechargeable battery

(55)

1.1

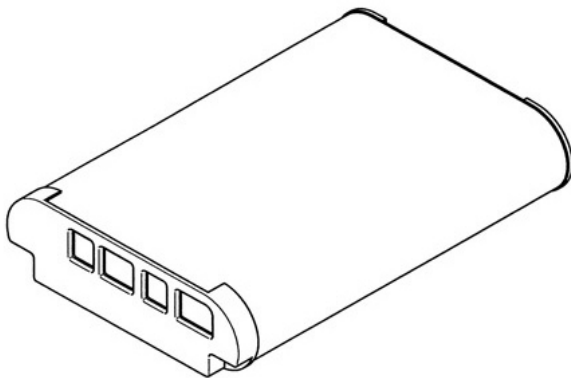

1.2

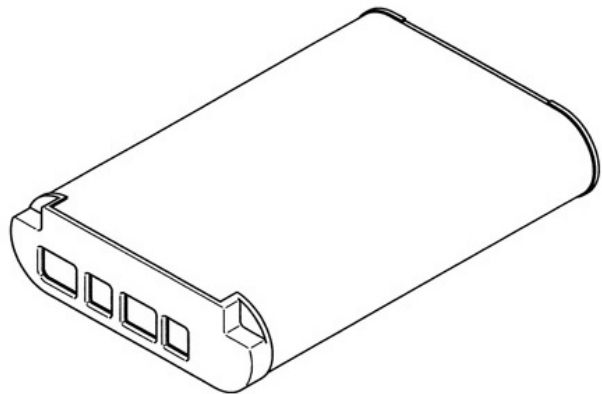

1.3

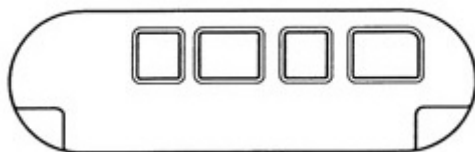

1.4

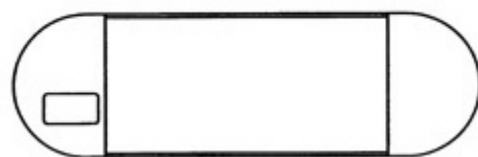

1.5

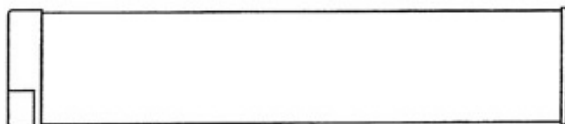

1.6



1.7

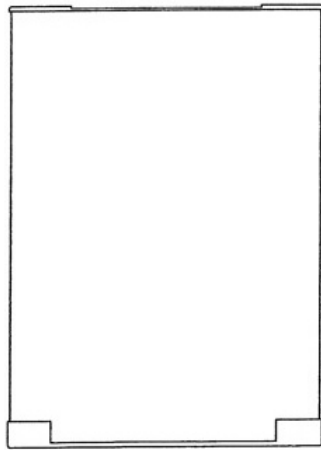

1.8

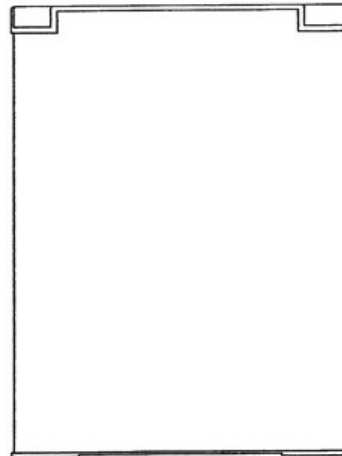

(11) DM/082258 (51) 11-01

(15) 2013 11 22 (45) 2013/48 (2013 12 06)

(22) 2013 11 22 (28) 2

(73) OMEGA SA (OMEGA AG) (OMEGA LTD.) Jakob-Stämpfli-Strasse 96, CH-2502 Biel/Bienne (CH)

(85) CH

(86) CH

(87) CH

(88) CH

(89) CH

(81) II. BZ, MA. III. AL, AM, AZ, BA, CH, EM, GE, KG, LI, MC, MD, ME, MK, MN, NO, OM, SG, TJ, TN, TR, UA

(72) 1-2: Jean-Claude Monachon, Rue Alice-de-Chambrier 1, 2022 Bevaix, Suisse

(54) 1. Bracelet; 2. Collier

(55)

1.1



1.2



1.3



2.1



2.2



2.3



(11) DM/082282 (51) 08-06

(15) 2013 04 01 (45) 2013/48 (2013 12 06)

(22) 2013 04 01 (28) 1

(30) 02.10.2012; 2012/06323; TR

(73) SAMET KALIP VE MADENI ESYA SANAYI VE TICARET ANONIM SIRKETI Ataturk Mahallesi
Inonu Caddesi No:8-13 Kirac-Esenyurt, TR-34513 Buyukcekmece ISTANBUL (TR)

(85) TR

(86) TR

(87) TR

(88) n/a

(89) TR

(81) III. AZ, EG, EM, GE, KG, OM, SY, UA

(72) Defne Koz Susani, 720 North Franklin, suite 501, Chicago IL 60654; Marco Susani, 720 North Franklin,
suite 501, Chicago IL 60654

(54) 1. Opening/closing mechanism for furniture doors

(55)

1.1

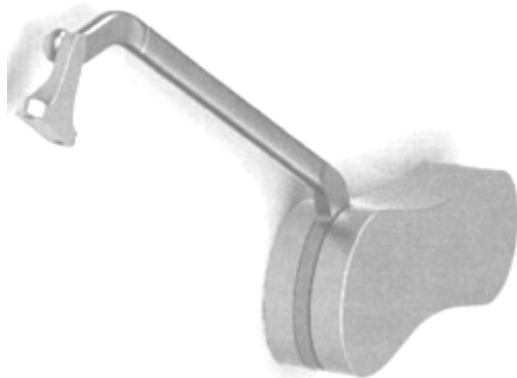

1.2



1.3



(11) DM/082288 (51) 09-01

(15) 2013 09 19 (45) 2013/48 (2013 12 06)

(22) 2013 09 19 (28) 1

(73) TARIMSAN TARIM SANAYI VE TICARET ANONIM SIRKETI Sirasögütler Mah. Beyazit Cad.
No.24, Gebze, Kocaeli (TR)

(85) --

(86) TR

(87) TR

(88) TR

(89) TR

(81) III. AZ, BA, EG, EM, GE, GH, KG, TN, TR, UA

(72) SEVKET ARSLANOGLU Istasyon Mahallesi Yildirim Beyazit Caddesi No.24 Gebze Kocaeli

(54) 1. Bottle

(55)

1.1



1.2



(11) DM/081660 (51) 03-01

(15) 2013 06 10 (45) 2013/49 (2013 12 13)

(22) 2013 06 10 (28) 2

(73) DOMINIK MAREK Za sokolovnou 601, CZ-285 04 Uhlířské Janovice (CZ)

(85) EM

(86) EM

(87) EM

(88) n/a

(89) EM

(81) III. AL, AM, AZ, BA, BW, CH, EG, EM, GE, GH, HR, IS, KG, LI, MC, MD, ME, MK, MN, NA, NO,
OA, OM, RS, RW, SG, SY, TJ, TN, TR, UA

(72) Oldrich Marek, Za sokolovnou 601, CZ-285 04, Uhlířské Janovice

(54) 1.-2. Net shopping bags

(55)

1.1

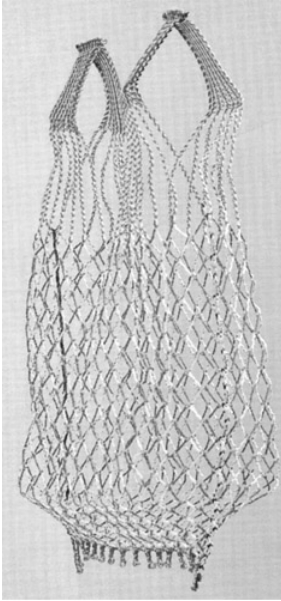

1.2

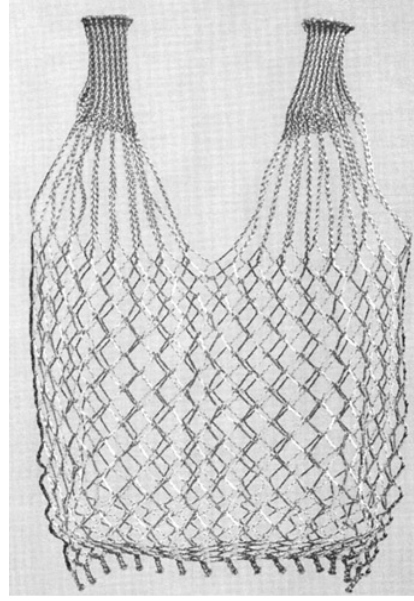

1.3

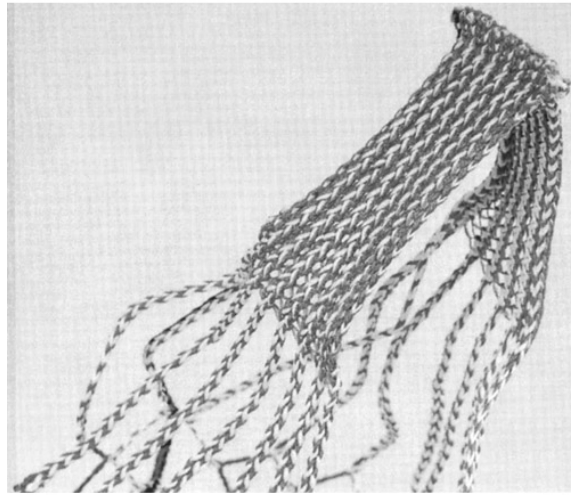

2.1

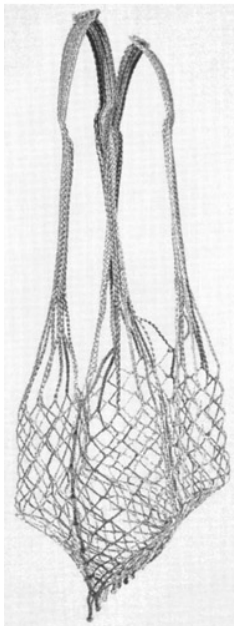

2.2

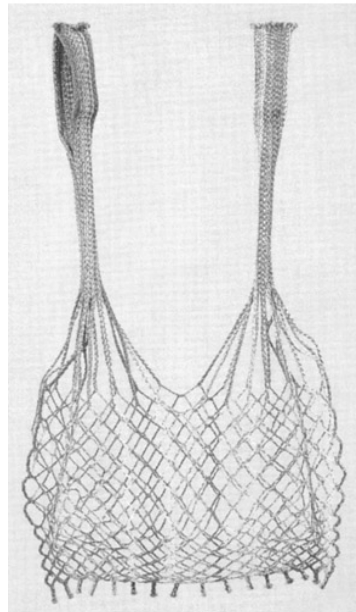

2.3

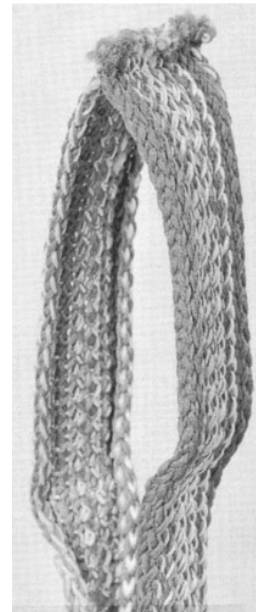

(11) DM/082334 (51) 25-03

(15) 2013 11 05 (45) 2013/49 (2013 12 13)

(22) 2013 11 05 (28) 1

(73) CHINDIA AS Nordraaksgate 14, N-0260 Oslo (NO)

(85) NO

(86) NO

(87) NO

(88) n/a

(89) NO

(81) III. EG, EM, GE, MC, NO, OA, OM, SG, TN, TR, UA

(72) Thord Peter Mossberg, Nordraaksgate 14, 0260 Oslo, Norway

(54) 1. Floating parking house facility with Helicopter landing deck

(55)

1.1

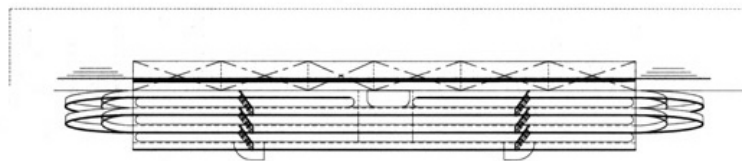

1.2

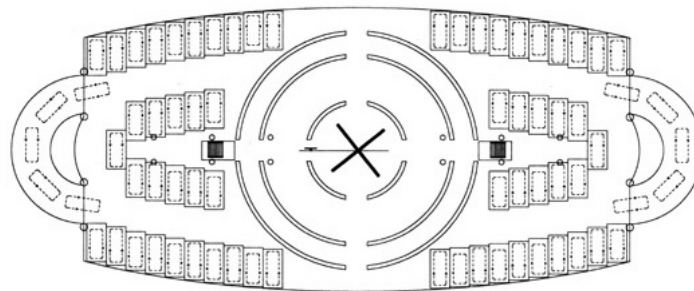

(11) DM/079775 (51) 15-05

(15) 2012 12 18 (45) 2013/50 (2013 12 20)

(22) 2012 12 18 (28) 6

(73) ALFRED KÄRCHER GMBH & CO. KG Alfred-Kärcher-Straße 28-40, 71364 Winnenden (DE)

(85) DE, EM

(86) DE, EM

(87) DE, EM

(88) DE, EM

(89) EM

(81) II. KP, MA. III. BA, CH, EG, EM, GE, LI, MD, ME, MK, MN, OM, TR

(54) 1.-6. Parts of High Pressure Cleaners

(55)

1.1

1.2



1.3

1.4

1.5



1.6



1.7



2.1

2.2

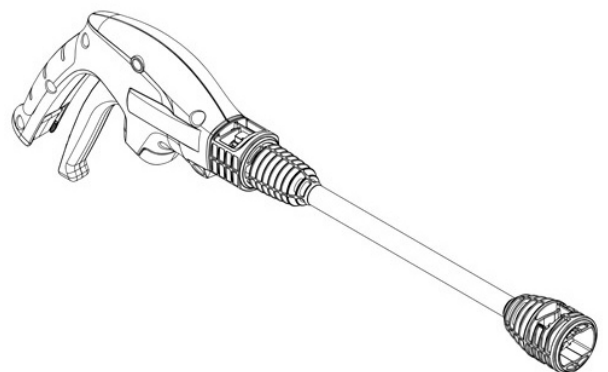
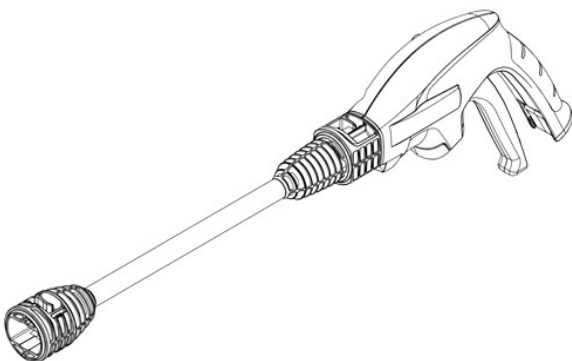

2.3



2.4

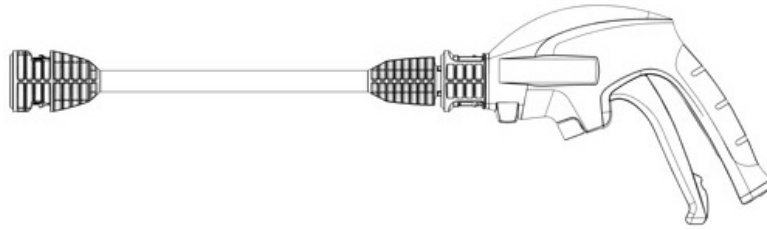

2.5

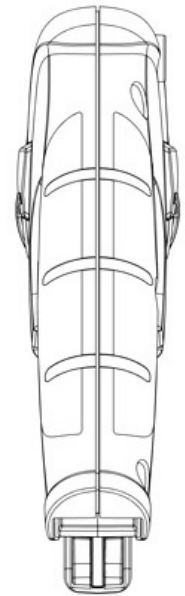

2.6

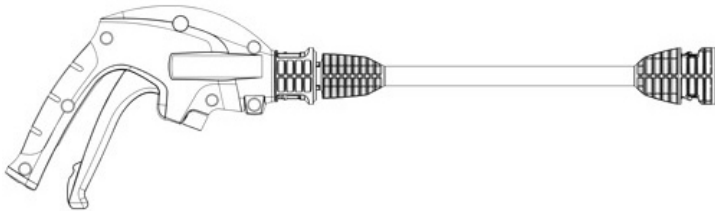

3.1



2.7

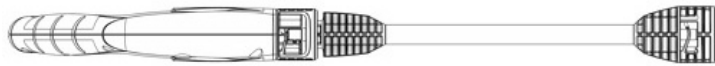

3.3

3.2



3.4



3.5



3.6



3.7



4.1

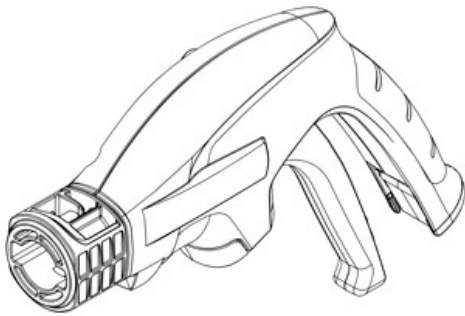

4.2



4.3

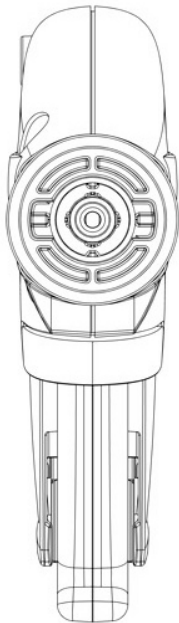

4.5

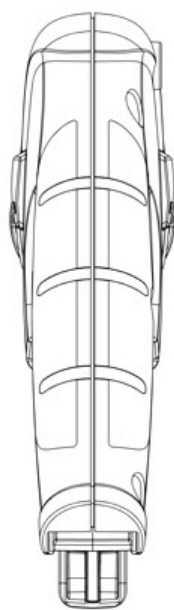

4.6

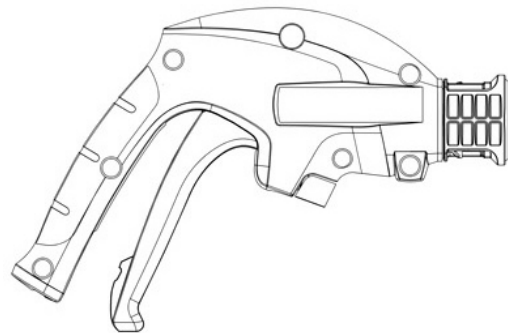

4.4

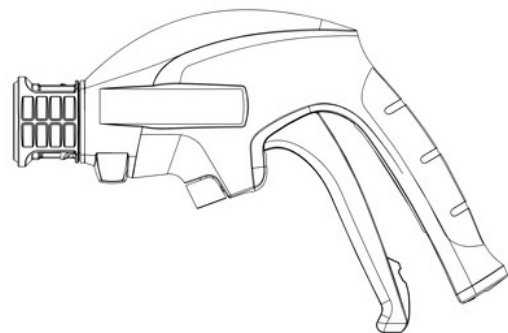

4.7

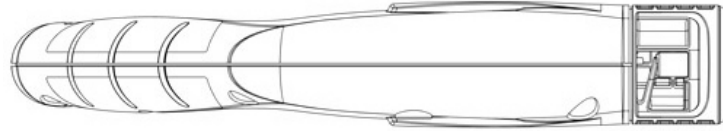

5.1

5.2



5.3

5.5



5.4



5.6



5.7



6.1

6.2

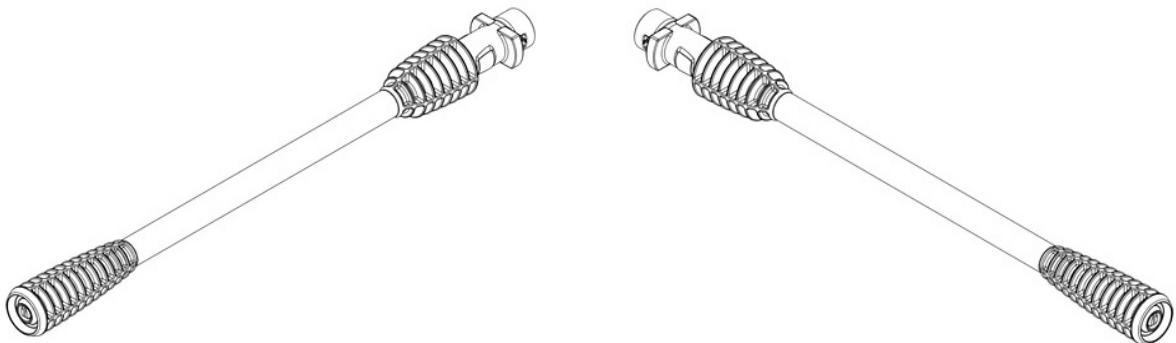

6.3

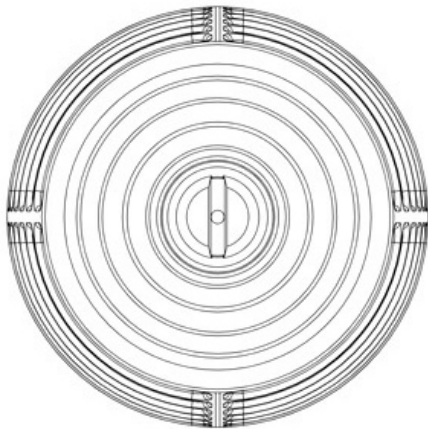

6.5

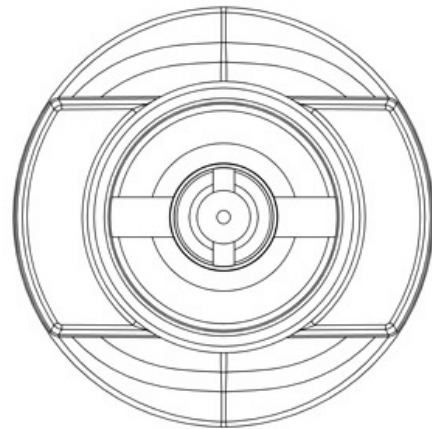

6.4



6.6



6.7



(11) DM/081087 (51) 10-02, 07

(15) 2013 06 17 (45) 2013/50 (2013 12 20)

(22) 2013 06 17 (28) 2

(73) OMEGA SA (OMEGA AG) (OMEGA LTD.) Jakob-Stämpfli-Strasse 96, CH-2502 Biel/Bienne (CH)

(85) CH

(86) CH

(87) CH

(88) CH

(89) CH

(81) II. BZ, MA. III. AL, AM, AZ, BA, CH, EM, GE, HR, KG, LI, MC, MD, ME, MK, MN, NO, OM, SG, TJ, TN, TR, UA

(72) No. 1, 2: Monachon Jean-Claude, Rue Alice-de-Chambrier 1, CH-2022 Bevaix

(54) 1. Watch; 2. Dial

(55)

1.1



1.2



1.3



1.4



1.5



1.6



1.7



1.8



2



(11) DM/081088 (51) 10-02

(15) 2013 06 18 (45) 2013/50 (2013 12 20)

(22) 2013 06 18 (28) 3

(73) SWATCH AG (SWATCH SA) (SWATCH LTD.) Jakob-Stämpfli-Strasse 94, CH-2502 Biel/Bienne (CH)

(85) CH

(86) CH

(87) CH

(88) CH

(89) CH

(81) II. BZ, MA, III. AL, AM, AZ, BA, CH, EM, GE, HR, KG, LI, MC, MD, ME, MK, MN, NO, OM, SG, TJ, TN, TR, UA

(72) No. 1: Andrea Arrigoni, c/o Swatchlab, Via Archimede 6, I-20129 Milano; No. 2: Patrizio Vita, c/o Swatchlab, Via Archimede 6, I-20129 Milano; No. 3: Danilo Sala, c/o Swatchlab, Via Archimede 6, I-20129 Milano

(54) 1.-3. Wristwatches

(55)

1

2

3



(11) DM/081089 (51) 10-02

(15) 2013 06 18 (45) 2013/50 (2013 12 20)

(22) 2013 06 18 (28) 3

(73) SWATCH AG (SWATCH SA) (SWATCH LTD.) Jakob-Stämpfli-Strasse 94, CH-2502 Biel/Bienne (CH)

(85) CH

(86) CH

(87) CH

(88) CH

(89) CH

(81) II. BZ, MA, III. AL, AM, AZ, BA, CH, EM, GE, HR, KG, LI, MC, MD, ME, MK, MN, NO, OM, SG, TJ, TN, TR, UA

(72) No. 1: Rossana Boffi, c/o Swatchlab, Via Archimede 6, I-20129 Milano; No. 2: Andrea Arrigoni, c/o Swatchlab, Via Archimede 6, I-20129 Milano; No. 3: Danilo Sala, c/o Swatchlab, Via Archimede 6, I-20129 Milano

(54) 1.-3. Wristwatches

(55)

1.1



1.2



2



3



(11) DM/081098 (51) 10-02

(15) 2013 06 18 (45) 2013/50 (2013 12 20)

(22) 2013 06 18 (28) 3

(73) SWATCH AG (SWATCH SA) (SWATCH LTD.) Jakob-Stämpfli-Strasse 94, CH-2502 Biel/Bienne (CH)

(85) CH

(86) CH

(87) CH

(88) CH

(89) CH

(81) II. BZ, MA. III. AL, AM, AZ, BA, CH, EM, GE, HR, KG, LI, MC, MD, ME, MK, MN, NO, OM, SG, TJ, TN, TR, UA

(72) No. 1, 2, 3: Andrea Arrigoni, c/o Swatchlab, Via Archimede 6, I-20129 Milano

(54) 1.-3. Wristwatches

(55)

1

2

3



(11) DM/081178 (51) 10-02, 07

(15) 2013 06 21 (45) 2013/51 (2013 12 27)

(22) 2013 06 21 (28) 3

(73) OMEGA SA (OMEGA AG) (OMEGA LTD.) Jakob-Stämpfli-Strasse 96, CH-2502 Biel/Bienne (CH)

(85) CH

(86) CH

(87) CH

(88) CH

(89) CH

(81) II. BZ, MA, III. AL, AM, AZ, BA, CH, EM, GE, HR, KG, LI, MC, MD, ME, MK, MN, NO, OM, SG, TJ, TN, TR, UA

(72) Monachon Jean-Claude, Rue Alice-de-Chambrier 1, CH-2022 Bevaix

(54) 1. Watch; 2. Dial; 3. Bracelet clasp

(55)

1.1



1.2



1.3



1.4



1.5



1.6



1.7



1.8



2.1



2.2



3.1



3.2



3.3

3.4



3.5



(11) DM/082414 (51) 09-01

- (15) 2013 12 13 (45) 2013/51 (2013 12 27)
 (22) 2013 12 13 (28) 1
 (30) 23.09.2013; 002313817-0001; EM
 (73) SAVERGLASS, 3 rue de la Gare F-60960 FEUQUIERES (FR)
 (85) FR, EM
 (86) FR, EM
 (87) FR, EM
 (88) FR, EM
 (89) FR
 (81) III. AM, AZ, BA, CH, EG, GE, MC, MD, ME, MK, NO, RS, SG, TR, UA
 (54) 1. Bottle
 (55)

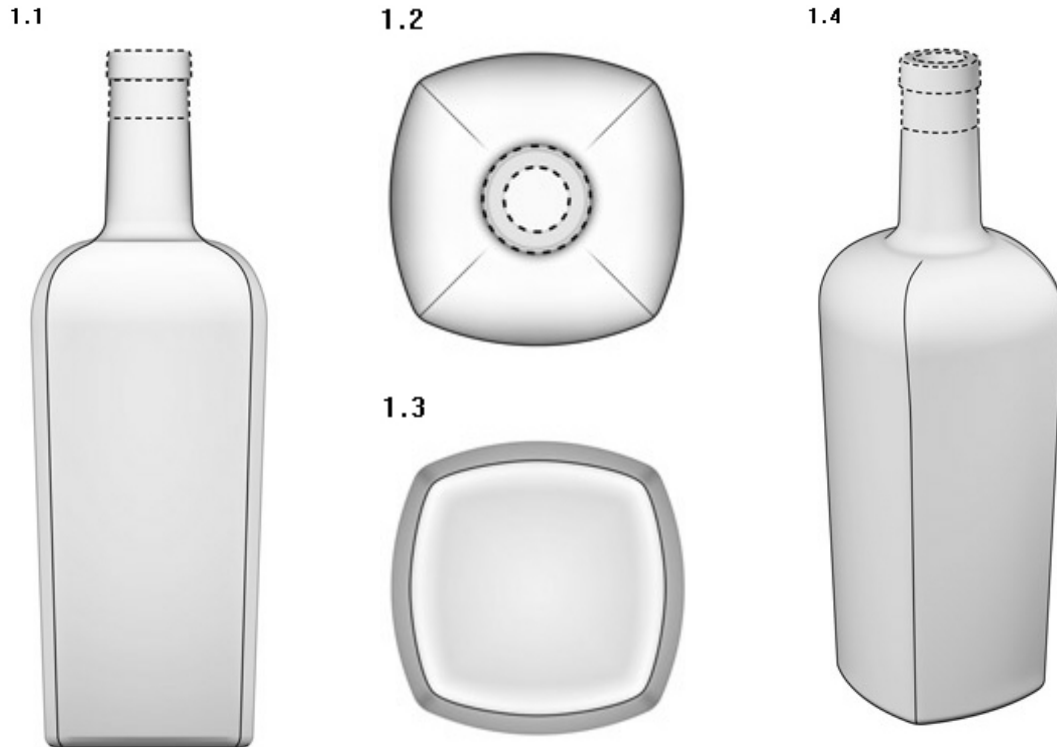

(11) DM/081256 (51) 12-08

- (15) 2013 06 28 (45) 2013/52 (2014 01 03)
 (22) 2013 06 28 (28) 2
 (30) 31.12.2012; 002160747; EM
 (73) SEAT, S.A. SEAT, S.A., Autovía A-2, Km. 585, E-08760 Martorell (Barcelona) (ES)
 (85) ES, EM
 (86) ES, EM
 (87) ES, EM
 (88) ES, EM
 (89) ES
 (81) III. AL, AM, AZ, BA, CH, EG, GE, IS, KG, MD, ME, MK, NO, OM, RS, SG, TR, UA
 (72) Juan José Adrados Herrero, Autovía A-2, Km. 585, E-08760 Martorell, Barcelona
 (54) 1.-2. Motor vehicles
 (55)

1.1



1.2



1.3

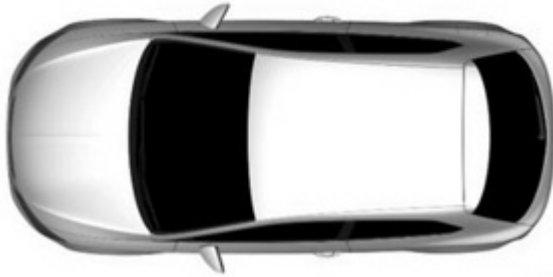

1.4



1.5



1.6



1.7



2.1



2.2



2.3



2.4



2.5

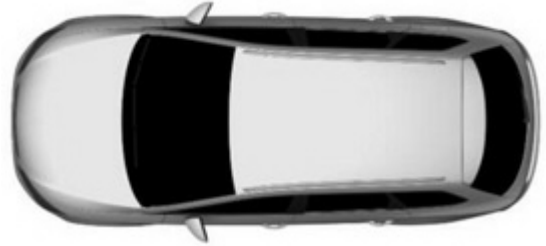

2.6



2.7



(11) DM/081817 (51) 15-05

(15) 2013 06 28 (45) 2013/52 (2014 01 03)

(22) 2013 06 28 (28) 3

(30) 03.01.2013; 002161406; EM

(73) PRO-AQUA INTERNATIONAL Technologiepark 1, 91522 Ansbach (DE)

(85) –

(86) DE, EM

(87) n/a

(88) n/a

(89) EM

(81) III. AL, AM, AZ, BA, CH, EG, GE, HR, IS, KG, LI, MC, MD, ME, MK, MN, NO, OM, RS, SG, TJ, TN, TR, UA

(72) 1-3: Christoph Böhler, Benno-Strauss-Str. 5, 90763 Fürth

(54) 1.-3. Vacuum cleaners

(55)

1.1



1.2



1.3



2



3



(11) DM/082481 (51) 02-04

(15) 2013 12 19 (45) 2013/52 (2014 01 03)

(22) 2013 12 19 (28) 6

(30) 25.06.2013; 002262378; EM

(73) VALENTINO S.P.A. Via Turati, 16/18, I-20121 Milano (IT)

(85) --

(86) EM, IT

(87) EM, IT

(88) EM, IT

(89) EM

(81) III. AZ, GE, KG, ME, RS, TJ, UA

(72) SASSI Stefano, c/o Valentino S.p.A. Via Turati 16/18, I-20121 MILANO, Italy

(54) 1.-6. Shoes

(55)

1.1



1.2



1.4



1.5



1.6

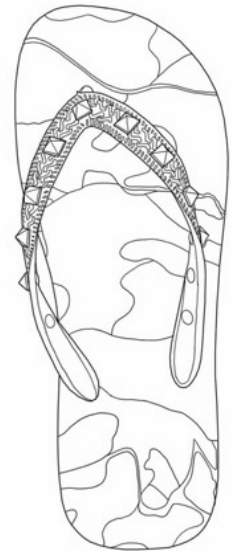

1.3

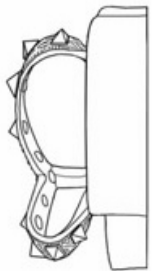

1.7

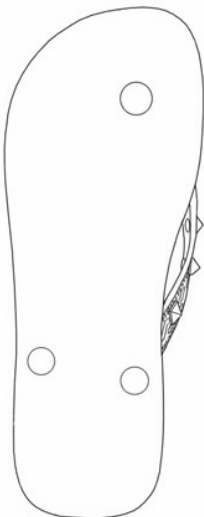

2.1

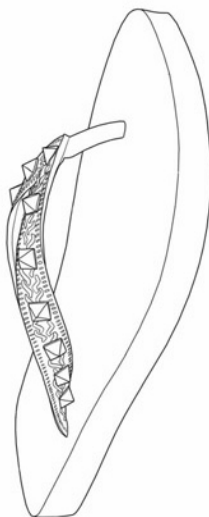

2.2



2.4



2.5



2.3

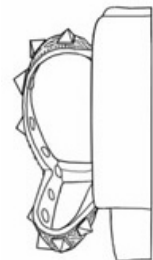

2.6

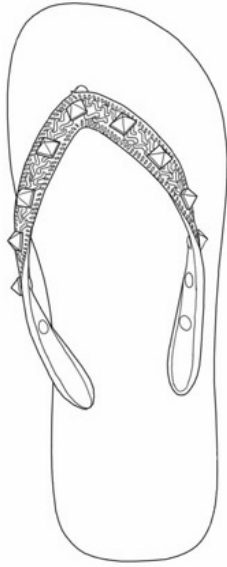

2.7

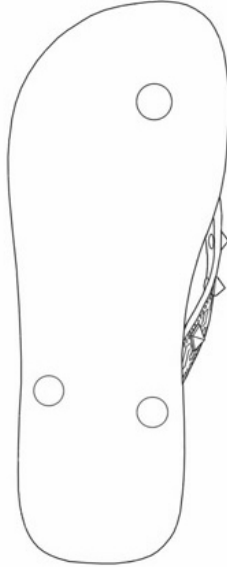

3.1



3.2



3.3

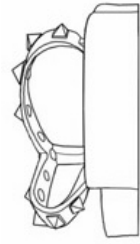

3.4



3.5

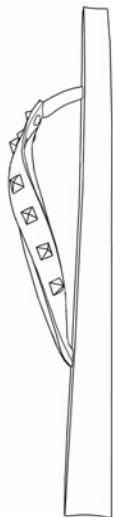

3.6

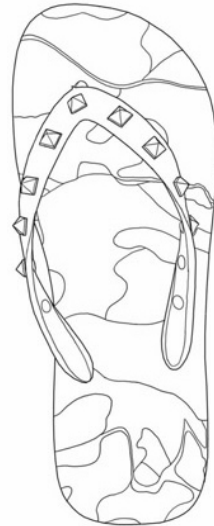

3.7

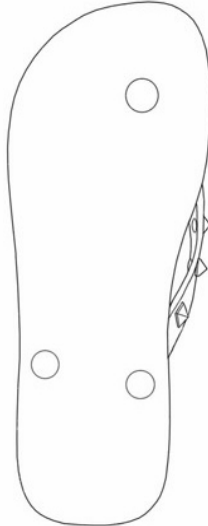

4.1

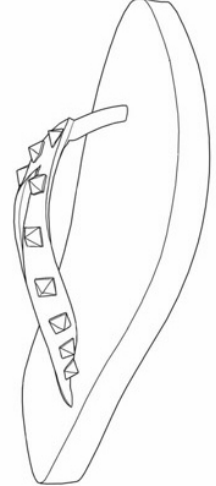

4.2



4.4

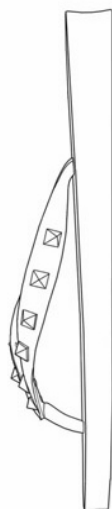

4.5

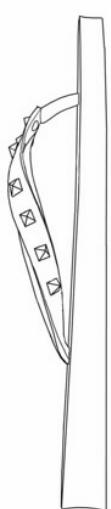

4.6

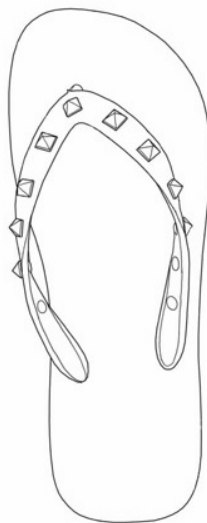

4.7

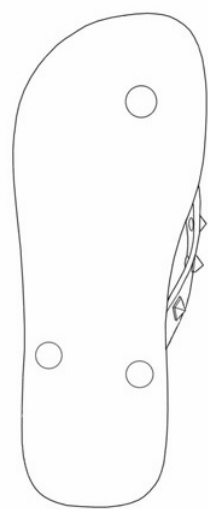

4.3

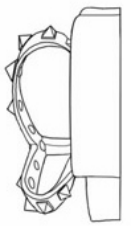



(11) DM/082488 (51) 14-03

(15) 2013 05 27 (45) 2013/52 (2014 01 03)

(22) 2013 05 27 (28) 2

(30) 06.12.2012; 29/439,095; US

(73) FRANZ ANTONIO WAKEFIELD COOLTVNETWORK.COM, INC. 17731 North West 14th Court, Miami, FL 33169 (US)

(85) --

(86) n/a

(87) EM

(88) n/a

(89) EM

(81) III. AL, AM, AZ, BA, BW, CH, DE, EG, EM, GE, IS, LI, MC, ME, MN, NA, NO, OA, RS, SG, TN, TR, UA

(72) Franz Antonio Wakefield, Cooltvnetwork.com, onc. 17731 NorthWest 14th Court Miami, Florida 33169

(54) 1.-2. Mobile smartphones

(55)

1.1

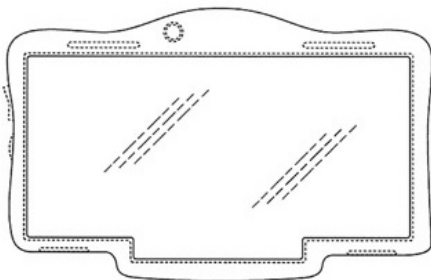

1.2

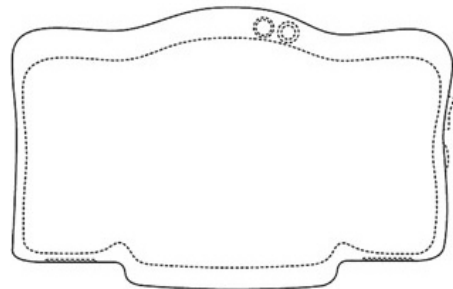

1.4

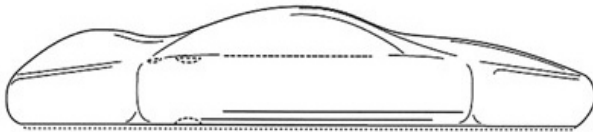

1.5

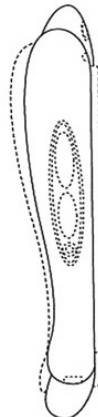

1.6

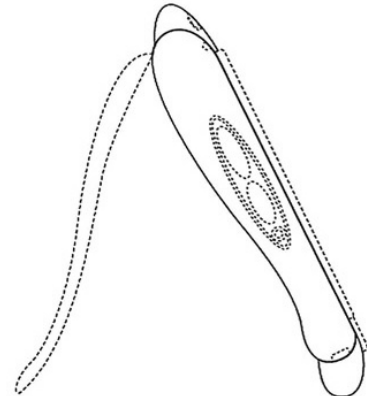

1.3

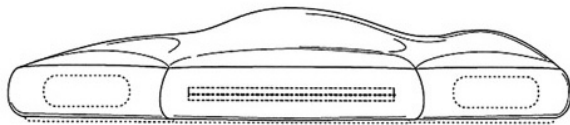

1.7

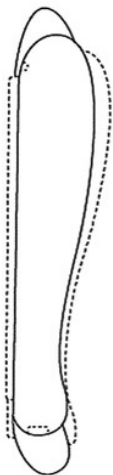

1.8

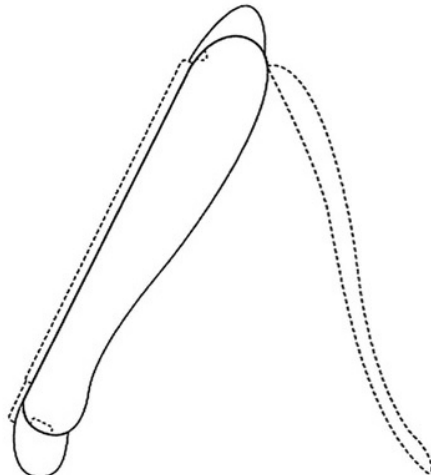

1.9

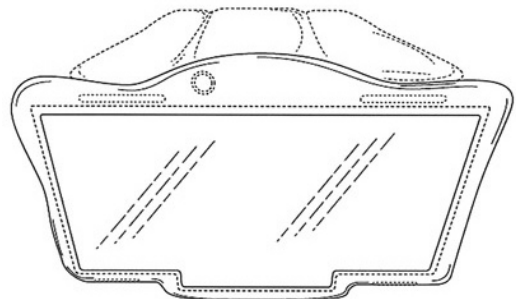

2.1

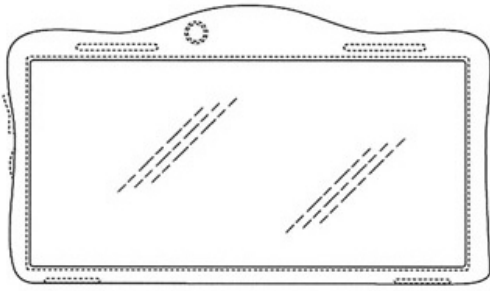

2.2

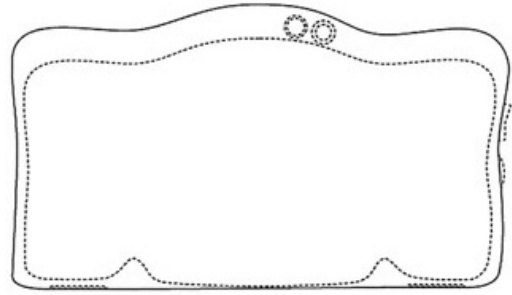

2.3

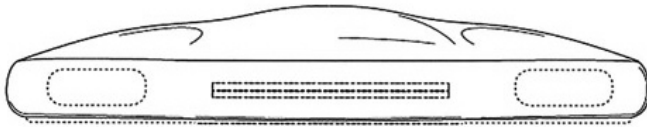

2.5

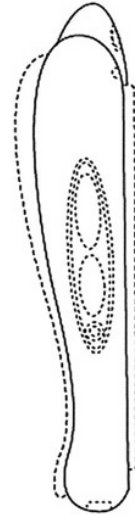

2.4

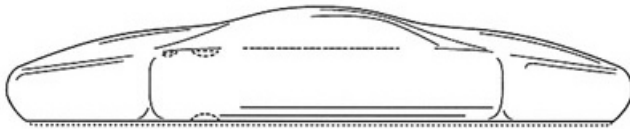

2.6

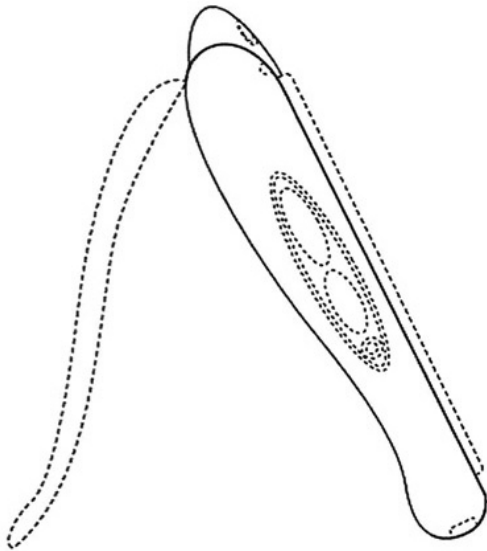

2.7

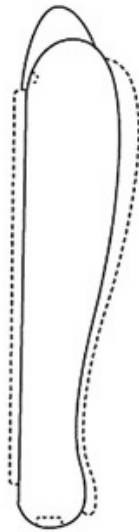

2.8

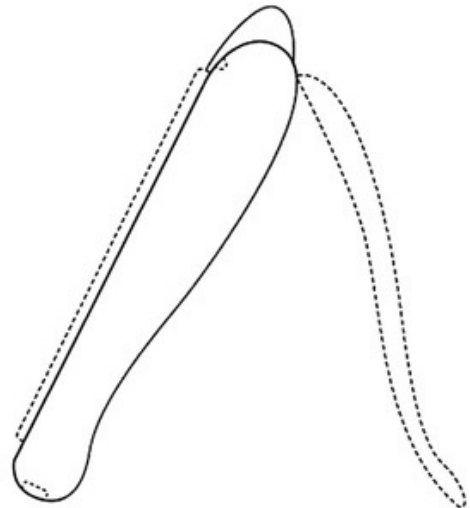

(11) DM/082505 (51) 01-01

(15) 2013 11 28 (45) 2013/52 (2014 01 03)

(22) 2013 11 28 (28) 1

(30) 29.05.2013; 002246389-0003; EM

(73) DIJO BAKING HORECA SERVICE SPÓLKA Z O.O. SPÓLKA KOMANDYTOWO AKCYJNA
Zabrodzie 28, PL-52-351 Wrocław (PL)

(85) –

(86) PL, EM

(87) PL,EM

(88) PL, EM

(89) PL

(81) III. AL, AM, AZ, BA, CH, EG, GE, IS, KG, LI, MC, MD, ME, MK, MN, NO, OM, RS, SY, TJ, TN, TR, UA

(72) 1: Dioklecjan Swiercz, Zabrodzie 28, 52-351 Wrocław, Poland

(54) 1. Bakers' product

(55)

1.1



1.2



სასაქონლო ნიშნები

ეროვნული პროცედურით შემოტანილი განაცხადები, რომლებზეც გამოტანილია გადაწყვეტილება რეგისტრაციის შესახებ

გადაწყვეტილების გასაჩივრება შესაძლებელია საქპატენტის სააპელაციო პალატაში გამოქვეყნებიდან 3 თვის ვადაში ან მცხეთის რაიონული სასამართლოს ადმინისტრაციულ საქმეთა კოლეგიაში 1 თვის ვადაში (მის.: ქალაქი მცხეთა, სამხედროს ქ. №17).

(260) AM 2014 71529 A

(210) AM 071529

(220) 2013 03 25

(731) „ფელბრუკ ჰოლდინგს ლტდ“
3რდ ფლორ, აირის ჰაუს, ჯონ კენედი
სტრიტ 3106 ლიმასოლი, კვიპროსი

(740) ხათუნა იმნაძე

(540)

Тайна Колхиды

(591) შავ-თეთრი

(526) **ფისკლამატი** – ნიშანი დაცულია მთლიანობაში. სიტყვიერი აღნიშვნა "Колхиды" არ ექვემდებარება დამოუკიდებელ სამართლებრივ დაცვას.

(511)

32 – ლუდი; მინერალური და გაზიანი წყალი და სხვა უაღკოპოლო სასმელები; ხილის სასმელები და ხილის წვენები; ვაჟინები და სასმელების დასამზადებელი სხვა შედგენილობები (ქართული წარმოშობის).

33 – ქართული წარმოშობის ალკოჰოლიანი სასმელები (ლუდის გარდა).

(260) AM 2014 71656 A

(210) AM 071656

(220) 2013 04 03

(731) სს „ასალ დიშ თიჯარეთის
წარმომადგენლობა საქართველოში“
მეტეხის ქ. 22, 0103, თბილისი,
საქართველო

(740) მაია სამადაშვილი

(540)

FOSFOMAS

ფოსფომასი

ФОСФОМАС

(591) შავ-თეთრი

(511)

5 – ფარმაცევტული პრეპარატები, მათ შორის, სამკურნალო საშუალებები.

(260) AM 2014 71657 A

(210) AM 071657

(220) 2013 04 03

(731) სს „ასალ დიშ თიჯარეთის
წარმომადგენლობა საქართველოში“
მეტეხის ქ. 22, 0103, თბილისი,
საქართველო

(740) მაია სამადაშვილი

(540)

ZERALGO

ზერალგო

ЗЕРАЛГО

(591) შავ-თეთრი

(511)

5 – ფარმაცევტული პრეპარატები, მათ შორის, სამკურნალო საშუალებები.

(260) AM 2014 71994 A

(210) AM 071994

(220) 2013 04 23

(731) შპს „გამომცემლობა ღველი“
ოსეების ქ.49, 0160, თბილისი,
საქართველო

(740) შოთა ღვედაძე

(540)

ქართული სპორტის ვარსკვლავი

(591) წითელი

(531) 28.19.00-29.01.01-

(511)

14 – კეთილშობილი ლითონები და მათი შენადნობები, მათგან დამზადებული ან დაფარული ნაკეთობა, რომელიც არ მიეკუთვნება სხვა კლასებს; საიუველირო ნაწარმი, ძვირფასი ქვები; საათები და სხვა ქრონომეტრული ხელსაწყოები.

35 – რეკლამა; მართვა საქმიან სფეროში; ადმინისტრირება საქმიან სფეროში; საოფისე სამსახური.

(260) AM 2014 72328 A
(210) AM 072328
(220) 2013 05 23
(731) შპს GVG

სოფელი ველისციხე, 1506, გურჯაანის რაიონი, საქართველო
(740) ალექსანდრე გიოშვილი
(540)



(591) ლურჯი, თეთრი
(531) 27.05.23-28.19.00-29.01.04-
(526) **დისკლამაცია** – ნიშანი დაცულია მთლიანობაში. სიტყვიერი აღნიშვნა „გურჯაანის“ არ ექვემდებარება დამოუკიდებელ სამართლებრივ დაცვას.

(511)
29 – ხორცი, თევზი, ფრინველი და ნანადირევი; ხორცის ექსტრაქტები; დაკონსერვებული, გამხმარი და თბურად დამუშავებული ბოსტნეული და ხილი; ჟელე, მურაბა, კომპოტი; კვერცხი, რძე და რძის პროდუქტები; ზეთები და საკვები ცხიმები.

30 – ყავა, ჩაი, კაკაო, შაქარი, ბრინჯი, ტაპიოკა (მანიოკა), საგო, ყავის შემცველები, ფქვილი და მარცვლოვანი პროდუქტი, პურ-ფუნთუშეული, საკონდიტრო ნაწარმი, ნაყინი, თაფლი, ბადავის ვაჟინი; საფუარი, საცხობი ფხვნილები; მარილი, მღოვავი; ძმარი, საკაზმები; სანელებლები; საკვები ყინული.

32 – ლუდი; მინერალური და გაზიანი წყალი და სხვა უაღკოპლო სასმელები; ხილის სასმელები და ხილის წვენები; ვაჟინები და სასმელების დასამზადებელი სხვა შედგენილობები.

35 – რეკლამა; მართვა საქმიან სფეროში; ადმინისტრირება საქმიან სფეროში; საოფისე სამსახური.

(260) AM 2014 72743 A
(210) AM 072743
(220) 2013 06 18
(731) EYGN ლიმიტიდ
უან მონტაგ ფლეის ისტ ბეი სტრიტი,
ნასაუ, ბაჰამის კუნძულები
(740) გიორგი ქართველიშვილი
(540)



(591) მუქი რუხი, ყვითელი, თეთრი
(531) 01.15.09-26.03.04-26.11.07-29.01.12-
(511)

45 – იურიდიული მომსახურება, იურიდიული და საგადასახადო და კვლევითი მომსახურების ჩათვლით; სხვათა წარმომადგენლობა იურიდიულ და საგადასახადო საქმეებში; იმიგრაციასთან დაკავშირებული იურიდიული მომსახურების წარმოდგენა; ინფორმაციული, რჩევითი და საკონსულტაციო მომსახურება იმიგრაციასთან დაკავშირებით; ინტელექტუალური საკუთრების მომსახურება, ინტელექტუალური საკუთრების და საავტორო უფლებების მენეჯმენტის ჩათვლით; საკუთრების და ინდივიდუალურ პირთა დაცვის მომსახურება; ინდივიდუალურ პირთა მოთხოვნილებების დასაკმაყოფილებლად სხვა პირთა მიერ გაწეული პერსონალური და სოციალური მომსახურება, ყველა ზემოაღნიშნული მომსახურების ჩათვლით, უზრუნველყოფილი ელექტრონულად ან ონლაინ კომპიუტერის მონაცემთა ბაზებიდან ან ინტერნეტით; საინფორმაციო, რჩევითი და საკონსულტაციო მომსახურება, რომელიც დაკავშირებულია ზემოაღნიშნულ მომსახურებასთან, ინფორმაციის წარმოდგენასთან (არ მოიცავს სხვა კლასებს), დაკავშირებული იურიდიულ საქმეებთან და ინტელექტუალურ საკუთრებასთან, უზრუნველყოფილი ონლაინ კომპიუტერის მონაცემთა ბაზიდან, ინტერნეტის ვებ-გვერდების დახმარებით; იურიდიული კვლევა; კომპიუტერის პროგრამული უზრუნველყოფის ლიცენზირება; საინფორმაციო, რჩევითი და საკონსულტაციო მომსახურება, რომელიც დაკავშირებულია ზემოაღნიშნულ მომსახურებასთან.

(260) AM 2014 72744 A

(210) AM 072744

(220) 2013 06 18

(731) EYGN ლიმიტიდ

უან მონტაგ ფლეის ისტ ბეი სტრიტი,

ნასაუ, ბაჰამის კუნძულები

(740) გიორგი ქართველი შვილი

(540)

EY

(591) შავ-თეთრი

(511)

35 – რეკლამა; სარეკლამო მომსახურება; პერსონალური და კადრების შერჩევის მომსახურება; ბუღალტრული და აუდიტორული მომსახურება; საგადასახადო კონსულტაცია, საგადასახადო მომზადება, საბუღალტრო აღრიცხვა, ბიზნეს აუდიტი და ბიზნეს საკონსულტაციო მომსახურება; ინტერნეტით განხორციელებული სარეკლამო მომსახურება; ბიზნესის მართვის მომსახურება; ბიზნესის ადმინისტრირება; ბიზნეს საკონსულტაციო მომსახურება, კონსულტაცია და ინფორმაცია; ბიზნესის ინფორმაციის წარდგენა; საოფისე სამსახური; საზოგადოებრივი აზრის შესწავლა; ბაზრის კვლევა; ბიზნესის და ბაზრის კვლევის მომსახურება; ბიზნესის მიმოხილვა, რომელიც ეხება ფინანსურ მომსახურებას; ბაზრის მიმოხილვა; ბაზრის მიმოხილვის ანალიზი; მონაცემთა დამუშავება; პრეზენტაციის მომზადება ბიზნესისთვის, კომერციული და სავაჭრო მიზნებისთვის; ბიზნესის მართვის კონსულტაცია; დახმარება ბიზნესის მართვაში; ბიზნეს ოპერაციის საკონსულტაციო მომსახურება; ბიზნეს მოდელირების მომსახურება; ბიზნეს რესტრუქტურის მომსახურება; საკონსულტაციო მომსახურება ინტელექტუალური საკუთრების მართვის სფეროში; პერსონალური მომსახურება; პერსონალური მართვის კონსულტაცია; ინფორმაციის სისტემატიზაცია კომპიუტერის მონაცემთა ბაზებში; კომპიუტერიზებული ფაილების მართვა; ყველა ზემოაღნიშნული მომსახურების ჩათვლით, წარდგენილი ელექტრონულად ან ონლაინ კომპიუტერული მონაცემთა ბაზებიდან ან ინტერნეტით; ინფორმაცია, კონსულტაცია და საკონსულტაციო მომსახურება, რომელიც მოყვება ზემოაღნიშნულ მომსახურებას.

36 – საფინანსო საქმიანობა; ფინანსების მართვა, დახმარება, რჩევა, კონსულტაცია, საინფორმაციო და საძიებო მომსახურება; საგადასახადო საკონსულტაციო მომსახურება; საგადასახადო და სავალდებულო საკონსულტაციო მომსახურება; საგადასახადო აღრიცხვის მომსახურება; საგადასახადო შესრულების საკონსულტაციო მომსახურება; ფინანსური

ტრანსსახელმწიფო საკონსულტაციო მომსახურება, სატრანსფერო ფასწარმოქმნა და საგადასახადო ეფექტური საწარმო-სარეალიზაციო ქსელის მართვის მომსახურება, გადახდის უზუნარობის მომსახურება; საინვესტიციო მომსახურება; შეფასების მომსახურება; კორპორატიული საფინანსო მომსახურება; კორპორატიული საფინანსო კონსულტაციები; კორპორატიული აქტივების შეფასება; რეალური და პიროვნული საკუთრების ფინანსური შეფასება; ფინანსური ანალიზი და კონსულტაცია, კერძოდ, გაკორტრებული კომპანიების რესტრუქტურისა; სადაზღვევო კონსულტაცია, კერძოდ, სადაზღვევო მარეგულირებელი მხარდაჭერა და საკონსულტაციო მომსახურება; ინტელექტუალური საკუთრების შეფასების მომსახურება; ქონების სააგენტო და ქონების მართვის მომსახურება; ფულად-საკრედიტო ოპერაციები; უძრავ ქონებასთან დაკავშირებული ოპერაციები; უძრავ ქონებასთან დაკავშირებული მომსახურება, უძრავი ქონების შეფასების ჩათვლით; ფინანსური ინფორმაციის უზურუნველყოფა; დაზღვევა; ფინანსური ინფორმაციის უზურუნველყოფა; საინვესტიციო მომსახურება; შეფასების მომსახურება; ფულად-საკრედიტო ოპერაციები; ინვესტირებასთან დაკავშირებით საკონსულტაციო მომსახურება; საკაპიტალიზაციო მომსახურება; ყველა ზემოაღნიშნული მომსახურების ჩათვლით უზურუნველყოფილი ელექტრონულად ან ონლაინ კომპიუტერის მონაცემთა ბაზებიდან ან ინტერნეტით; ფინანსური ანალიზი; დისტრიბუცია (ფინანსური); ფინანსური სპონსორობა; მინდობლობით მართვის მომსახურება; ფინანსური შეფასება (დაზღვევა, საბანკო ოპერაციები, უძრავი ქონება); ბიზნესის სალიკვიდაციო მომსახურება (ფინანსური); საფინანსო მომსახურება, დაკავშირებული ფულად-საკრედიტო ოპერაციებთან; საინფორმაციო, რჩევითი და საკონსულტაციო მომსახურება, დაკავშირებული ზემოაღნიშნულ მომსახურებასთან.

45 – იურიდიული მომსახურება, იურიდიული და საგადასახადო და კვლევითი მომსახურების ჩათვლით; სხვათა წარმომადგენლობა იურიდიულ და საგადასახადო საქმეებში; იმიგრაციასთან დაკავშირებული იურიდიული მომსახურების წარმოდგენა; ინფორმაციული, რჩევითი და საკონსულტაციო მომსახურება იმიგრაციასთან დაკავშირებით; ინტელექტუალური საკუთრების მომსახურება, ინტელექტუალური საკუთრების და საავტორო უფლებების მენეჯმენტის ჩათვლით; საკუთრების და ინდივიდუალურ პირთა დაცვის მომსახურება; ინდივიდუალურ პირთა მოთხოვნილებების დასაკმაყოფილებლად სხვა პირთა მიერ გაწეული პერსონალური და სოციალური მომ-

სახურება, ყველა ზემოაღნიშნული მომსახურების ჩათვლით, უზრუნველყოფილი ელექტრონულად ან ონლაინ კომპიუტერის მონაცემთა ბაზებიდან ან ინტერნეტით; საინფორმაციო, რჩევითი და საკონსულტაციო მომსახურება, რომელიც დაკავშირებულია ზემოაღნიშნულ მომსახურებასთან, ინფორმაციის წარმოდგენასთან (არ მოიცავს სხვა კლასებს), დაკავშირებული იურიდიულ საქმეებთან და ინტელექტუალურ საკუთრებასთან, უზრუნველყოფილი ონლაინ კომპიუტერის მონაცემთა ბაზიდან, ინტერნეტის ვებ-გვერდების დახმარებით; იურიდიული კვლევა; კომპიუტერის პროგრამული უზრუნველყოფის ლიცენზირება; საინფორმაციო, რჩევითი და საკონსულტაციო მომსახურება, რომელიც დაკავშირებულია ზემოაღნიშნულ მომსახურებასთან.

(260) AM 2014 72791 A

(210) AM 2014 072791

(220) 2013 06 20

(731) შპს „ართაიმი“
ცაბაძის ქ.№9, 0179, თბილისი, საქართველო

(540)



(591) წითელი, შავი, თეთრი

(531) 26.04.12-26.04.18-26.04.24-27.05.19-27.05.21-29.01.13-

(511)

14 – კეთილშობილი ლითონები და მათი შენადნობები, მათგან დამზადებული ან დაფარული ნაკეთობა, რომელიც არ მიეკუთვნება სხვა კლასებს; საიუველირო ნაწარმი, ძვირფასი ქვები; საათები და სხვა ქრონომეტრული ხელსაწყოები.

35 – რეკლამა; მართვა საქმიან სფეროში; აღმინისტრირება საქმიან სფეროში; საოფისე საშუალებები.

(260) AM 2014 72800 A

(210) AM 072800

(220) 2013 06 20

(731) ჰანჯინ შიპინგ კოლდინგ ზ კო., ლტდ.
25-11, იოიდო-დონგ, იოუნგდეუნგპო-კუ, სეული, კორეის რესპუბლიკა

(740) შალვა გვარამაძე

(540)



(591) შავ-თეთრი

(531) 27.05.17-

(511)

39 – საჰაერო, ბარუით, გემებით (წყლის ტრანსპორტით), ავტომანქანებით, ბორნით, ფრახტით, რკინიგზით, სატვირთო ავტომობილებით და გემებით გადაზიდვები; გემებისთვის, ძრავიანი სატრანსპორტო საშუალებებისთვის, სარკინიგზო ტრანსპორტისთვის და თვითმფრინავებისთვის ტვირთის საწვობში შენახვის მომსახურების უზრუნველყოფა; საწვობებში და კონტეინერულ ტერმინალებში საქონლის შენახვაში მომსახურებები; საფუთი საშუალებები ტრანსპორტირებისთვის, სახელდობრ, საქონლის განთავსება ყუთებში; საშუამავლო მომსახურებები გადაზიდვებში; გადაზიდვები სატვირთო ტრანსპორტით; სატვირთო მანქანებით აგეჯის გადაზიდვაში მომსახურებები; სატრანსპორტო საშუალებების გაქირავება, სახელდობრ, ავტომობილების და სატვირთო ავტომობილების გაქირავება; სასაწყობო ფართობების, შესანახი საწყობების, კონტეინერების ტერმინალების გაქირავება; ძვირფასეულობის გადაზიდვა დაჯავშნული საჰაერო, საზღვაო, სარკინიგზო და სატვირთო სატრანსპორტო საშუალებებით; ამანათების ავიატრანსპორტით, საზღვაო ტრანსპორტით, სარკინიგზო ტრანსპორტით და სატვირთო ტრანსპორტით მიწოდება; გადმოტვირთვებთან დაკავშირებული მომსახურებები; სურსათის საყინულე კამერების გაქირავება; ლისტერით ტვირთის გადაზიდვა; საზღვაო გადაზიდვებში საშუამავლო მომსახურებები; სატრანსპორტო საშუალებების ბუქსირება; რეფრიჯერატორების გაქირავება; მდინარის ტრანსპორტით გადაზიდვები; ტურისტული ბიუროები; მოგზაურთა ესკორტირება; ტურისტული სააგენტოების მომსახურებები.

(260) AM 2014 72801 A

(210) AM 072801

(220) 2013 06 20

(731) ჰანჯინ შიპინგ კოლდინგ ზ კო., ლტდ.
25-11, იოიდო-დონგ, იოუნგდეუნგპო-კუ, სეული, კორეის რესპუბლიკა

(740) შალვა გვარამაძე

(540)



(591) შავ-თეთრი

(531) 26.01.18-

(511)

39 – საჰაერო, ბარუით, გემებით (წყლის ტრანსპორტით), ავტომანქანებით, ბორნით, ფრახტით, რკინიგზით, სატვირთო ავტომობილებით

და გემებით გადაზიდვები; გემებისთვის, ძრავიანი სატრანსპორტო საშუალებებისთვის, სარკინიგზო ტრანსპორტისთვის და თვითმფრინავებისთვის ტვირთის საწვობში შენახვის მომსახურების უზრუნველყოფა; საწვობებში და კონტეინერულ ტერმინალებში საქონლის შენახვაში მომსახურებები; საფუთო საშუალებები ტრანსპორტირებისთვის, სახელდობრ, საქონლის განთავსება ყუთებში; საშუამავლო მომსახურებები გადაზიდვებში; გადაზიდვები სატვირთო ტრანსპორტით; სატვირთო მანქანებით ავჯის გადაზიდვაში მომსახურებები; სატრანსპორტო საშუალებების გაქირავება, სახელდობრ, ავტომობილების და სატვირთო ავტომობილების გაქირავება; სასაწვობო ფართობების, შესანახი საწვობების, კონტეინერების ტერმინალების გაქირავება; ძვირფასეულობის გადაზიდვა დაჯავშნული საპაერო, საზღვაო, სარკინიგზო და სატვირთო სატრანსპორტო საშუალებებით; ამანათების ავიატრანსპორტით, საზღვაო ტრანსპორტით, სარკინიგზო ტრანსპორტით და სატვირთო ტრანსპორტით მიწოდება; გადმოტვირთვებთან დაკავშირებული მომსახურებები; სურსათის საყინულე კამერების გაქირავება; ლიხტერით ტვირთის გადაზიდვა; საზღვაო გადაზიდვებში საშუამავლო მომსახურებები; სატრანსპორტო საშუალებების ბუქსირება; რეფრიჯერატორების გაქირავება; მდინარის ტრანსპორტით გადაზიდვები; ტურისტული ბიუროები; მოგზაურთა ესკორტირება; ტურისტული სააგენტოების მომსახურებები.

კვერცხი; ზეთები და საკვები ცხიმები; ძეხვეული; კიბოები (არაცოცხალი), ხორცის კონსერვები, თევზის კონსერვები.

35 – საკვებით საცალო ვაჭრობის მომსახურება, მათ შორის, შემდეგი საქონელის ჩათვლით: ბოსტნეულის, ხორცის, თევზის, ფრინველის ან ნანადირევისაგან დამზადებული (მოხარშული) კერძები, ხორცი, თევზი, ფრინველი და ნანადირევი, დაკონსერვებული, გაყინული, გამხმარი და თბურად დამუშავებული ხილი და ბოსტნეული; კარტოფილის სრაშუნა; დაკონსერვებული ზეთისხილი; ტაპენადა; დამუშავებული კაკალი, თხილი და ნუში; კორნიშონი, ქელები; მურაბები; კომპოტები; ხილის სალათები; სარკალით დაფარული ხილი; ნამცხვრის საკვები მოსართავეები, პიცა, კიში, ტაქოსი, ტორტილია, სენდვიჩები, მაკარონის ნაწარმი, ხორციანი დვეჯელები, საკვები ყინული, მოხარშული კრემი, თაფლი, ბადაგი, საფუარი, საცხობი ფხვნილები, მარილი, მდოგვი, ძმარი, საკაშმები, სანელებლები, დაკონსერვებული მწვანილი, სუნელები, ყინული, შოკოლადი; ყავის სასმელები, ჩაის სასმელები, კაკაოს სასმელები ან შოკოლადის სასმელები; მაიონეზი.

43 – საკვებითა და სასმელებით უზრუნველყოფა, საკვების შეკვეთით დამზადება და მიტანა, თვითმომსახურების რესტორნები, სასაუზმეები, კაფეტერიები, კაფე-რესტორნები, ბარების მომსახურება, ჩაის სახლები, საკვებისა და კერძების დამზადება წასაღებად.

- (260) AM 2014 72810 A
- (210) AM 072810
- (220) 2013 06 24
- (731) პოლ სუის სა
2 რიუ სან-ლეგერი, CH-1205 უენევა,
შვეიცარია
- (740) გიორგი თაქთაქიშვილი
- (540)

PAUL

(591) შავ-თეთრი
(511)
29 – ბოსტნეულის, ხორცის, თევზის, ფრინველის ან ნანადირევისაგან დამზადებული (მოხარშული) კერძები; ხორცი, თევზი, ფრინველი და ნანადირევი; დაკონსერვებული, გაყინული, გამხმარი და თბურად დამუშავებული ხილი და ბოსტნეული; კარტოფილის სრაშუნა; დაკონსერვებული ზეთისხილი; ტაპენადა; დამუშავებული კაკალი, თხილი და ნუში; კორნიშონი; ქელები; მურაბები; კომპოტები; ხილის სალათები; სარკალით დაფარული ხილი; ხილზე დამზადებული საუზმეული; ბოსტნეულის სალათები; წვნიანები;

- (260) AM 2014 72854 A
- (210) AM 072854
- (220) 2013 06 27
- (731) შპს „კორპორაცია ქართული ღვინო“
სიმონ ჩიქოვანის ქ. №35, 0171, თბილისი,
საქართველო
- (540)

“მზიური”

“MZIURI”

“МЗИУРИ”

(591) შავ-თეთრი
(511)
33 – ალკოჰოლური სასმელები.

(260) AM 2014 72856 A
(210) AM 072856
(220) 2013 06 27
(731) შპს „კორპორაცია ქართული ღვინო“
სიმონ ჩიქოვანის ქ. №35, 0171, თბილისი,
საქართველო
(540)

“ფიალა”
“PHIALA”
“ПИАЛА”

(591) შავ-თეთრი
(511)
33 – ალკოჰოლური სასმელები.

(260) AM 2014 72857 A
(210) AM 072857
(220) 2013 06 27
(731) შპს „კორპორაცია ქართული ღვინო“
სიმონ ჩიქოვანის ქ. №35, 0171, თბილისი,
საქართველო
(540)

“სერენადა”
“SERENADA”
“СЕРЕНАДА”

(591) შავ-თეთრი
(511)
33 – ალკოჰოლური სასმელები.

(260) AM 2014 72874 A
(210) AM 072874
(220) 2013 06 28
(731) ჯენერალ მოტორს ლღკ
300 რეინესანს სენტერი, სიტი ოფ
დეტროიტი, მიჩიგანის შტატი
48265-3000, აშშ
(740) გიორგი თაქთაქიშვილი
(540)



(591) შავ-თეთრი
(531) 21.01.11-24.11.25-24.13.01-
(511)
12 – მოტორიანი სატრანსპორტო საშუალებე-
ბი და მათი ნაწილები.

(260) AM 2014 72930 A
(210) AM 072930
(220) 2013 07 02
(731) შპს „ავერსი-ფარმა“
დავით აღმაშენებლის გამზ., 148/2, 0112,
თბილისი, საქართველო
(540)

ბარალგავერსი
баралгаверси
Baralgaversi

(591) შავ-თეთრი
(511)
5 – სამკურნალო საშუალება (ფარმაცევ-
ტული პროდუქტი, მედიკამენტი).

(260) AM 2014 72972 A
(210) AM 072972
(220) 2013 07 05
(731) შპს „ტექნო ბუმი“
ვაჟა-ფშაველას გამზ. 30ა, 0160,
თბილისი, საქართველო
(740) ასმათ ნეფარიძე
(540)

ფლექსი
Flax

(591) შავ-თეთრი
(511)
35 – სავაჭრო საქმიანობა-საყოფაცხოვრებო
და ნებისმიერი სხვა ტექნიკით ვაჭრობა.

(260) AM 2014 72973 A
(210) AM 072973
(220) 2013 07 05
(731) შპს „ტექნო ბუმი“
ვაჟა-ფშაველას გამზ. 30ა, 0160,
თბილისი, საქართველო
(740) ასმათ ნეფარიძე
(540)

ვაგნერი

Vagner

(591) შავ-თეთრი
(531) 27.05.17-28.19.00-
(511)
35 – სავაჭრო საქმიანობა-საყოფაცხოვრებო
და ნებისმიერი სხვა ტექნიკით ვაჭრობა.

(260) AM 2014 73002 A
 (210) AM 073002
 (220) 2013 07 08
 (731) საჯარო სააქციო საზოგადოება
 „ობოლონ“
 ულ. ბოგატირსკაია, 3, ქ. კიევი, უკრაინა
 (740) დავით ზურაბიშვილი
 (540)



(591) შავ-თეთრი
 (531) 19.07.16-27.05.02-
 (511)
 21 – ბოთლები.

32 – ლუდი; მინერალური და გაზირებული წყალი და სხვა უაღკოპლო სასმელები; დასაღევი წყალი.

(260) AM 2014 73100 A
 (210) AM 073100
 (220) 2013 07 12
 (731) შპს ჯეო-თრეიდიინგი Geo-Trading LTD
 ვარკეთილის მე-4 მ/რ, მე-3 კვ. 7-19, 0163,
 თბილისი, საქართველო
 (540)



(591) წითელი, თეთრი
 (531) 24.09.11-25.01.05-29.01.12-
 (511)

11 – განათების, გათბობის, ორთქლწარმოქმნის, საკვები პროდუქტის თბური დამუშავების, გასაცივებელი, საშრობი, ვენტილაციის, წყალგამანაწილებელი და სანიტარულ-ტექნიკური მოწყობილობები.

35 – რეკლამა; მართვა საქმიან სფეროში; ადმინისტრირება საქმიან სფეროში; საოფისე საშუალებები; ვაჭრობა და რეალიზაცია.

(260) AM 2014 73105 A
 (210) AM 073105
 (220) 2013 07 15
 (731) პიცა ჰატ ინტერნეიშენელ, ლ.ლ.კ.
 (ე. დელავერ ლიმიტედ ლაიპსილიტი
 კომპანი)
 7100 კორპორეიტ დრაივი, პლანო,
 ტეხასი, 75024, აშშ
 (740) თამარ კოჭლამაზაშვილი
 (540)



(591) შავ-თეთრი
 (531) 09.07.17-
 (511)

29 – ხორცი, თავში ფრინველი და ნანადირევი; ხორცის ექსტრაქტები; დაკონსერვებული, გამხმარი და თბურად დამუშავებული ბოსტნეული და ხილი; კვლე, მურაბა, კომპოტი; კვერცხი, რძე და რძის პროდუქტები; ზეთები და საკვები ცხიმები.

30 – ყავა, ჩაი, კაკაო და ყავის შემცველები, ბრინჯი, ტაპიოკა (მანიოკა) და საგო; ფქვილი და მარცვლოვანი პროდუქტი, პურ-ფუნთუშეული, საკონდიტრო ნაწარმი, ნაყინი; შაქარი, თაფლი, ბადაგის ვაჟინი; საფუარი, საცხობი ფხვნილები; მარილი, მდოგვი; ძმარი, საკაზმები; სანელებლები; საკვები ყინული.

43 – საკვები პროდუქტებითა და სასმელებით უზრუნველყოფა; დროებითი საცხოვრებელი უზრუნველყოფა.

(260) AM 2014 73125 A
 (210) AM 073125
 (220) 2013 07 17
 (731) დუბაი ვიეიშიშენ კორპორეიშენ ტ/ა
 ფლაიდუბაი
 ფლაიდუბაი ჰელტოტერს ტერმინალ 2,
 პო ბოქს 353, დუბაი, არაბთა
 გაერთიანებული საამიროები
 (740) პაატა სალია
 (540)

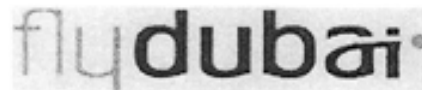

(591) რუხი, შავი
 (531) 27.05.10-27.05.22-
 (511)

39 – ავიახაზების მომსახურება, საჰაერო გადაზიდვების მომსახურება, თვითმფრინავის დაფრახტვის მომსახურება; მოგზაურობის

მომსახურება; კურიერის მომსახურება; ტვირთის ჩატვირთვა-განტვირთვის მომსახურება; ტვირთის შენახვის მომსახურება; ტვირთის გადაზიდვის მომსახურება; საქონლის ავიაცხეებით მიწოდება; მოგზაურთა თანხლება; ფრახტთან დაკავშირებული საშუაშაველო საქმიანობა და ტვირთის ექსპერტიზა; აეროპორტის სახმელეთო მომსახურება; საქონლის შეფუთვა და შენახვა; მოგზაურობის შეკვეთისა და დაჯავშნის სააგენტოები; სამოგზაურო სააგენტოების მომსახურება; რეისების დაჯავშნა; რეისების ორგანიზება; დასვენების ორგანიზება; საგზურებით დასვენების მომსახურება; საინფორმაციო მომსახურება ტურისტებისათვის; ფრენის რეგისტრაციისა და მოგზაურობის ორგანიზებაში დახმარების გაწევა; 39-ე კლასში შეტანილი ყველა ზემოჩამოთვლილი მომსახურების საინფორმაციო და საკონსულტაციო მომსახურება.

- (260) AM 2014 73184 A
- (210) AM 073184
- (220) 2013 07 26
- (731) ვიზა ინტერნეშენელ სერვის ასოციეშიენ 900 მეტრო სენტერ ბულვარი, ფოსტერ სიტი, კალიფორნია 94404, აშშ
- (740) გიორგი მეიფარიანი
- (540)

უპირატესობათა სამყარო

- (591) შავ-თეთრი
- (531) 28.19.00-
- (511)
- 36 – საფინანსო საქმიანობა; ფულად საკრედიტო ოპერაციები; დაზღვევა; საფინანსო მომსახურება, სახელდობრ, საბანკო მომსახურება; სახლიდან განხორციელებადი საბანკო ოპერაციები ინტერნეტის მეშვეობით, საკრედიტო ბარათებთან, სადებეტო ბარათებთან, არაპროლონგირებადი კრედიტის მქონე საკრედიტო ბარათებთან და წინასწარგადახდილ ბარათებთან დაკავშირებული მომსახურება; ელექტრონული ანგარიშსწორების სისტემაში ფულადი სახსრების გადარიცხვის მომსახურება და ვალუტის გადარიცხვის მომსახურება, ელექტრონული გადახდების მომსახურება, ფულადი გაცემების მომსახურება; დაზღვევის მომსახურება, სახელდობრ, სამედიცინო დაზღვევის, სამგზავრო დაზღვევის, საავტომობილო გზებზე გადაუდებელი დახმარების დაზღვევის და იჯარის დაზღვევის დაფარვა მგზავრებისათვის, გაფართოებული გარანტიის მომსახურება; ვალდებულებების დაცვის მომსახურება; მუდმივი კლიენტები-

სათვის ფასდაკლებების პროგრამების და შედავათიანი გადახდების პროგრამების ადმინისტრირება და გაწევა; ყველა ზემოჩამოთვლილი მომსახურება დაკავშირებული ადმინისტრირებასთან და სარგებლის უზრუნველყოფასთან საგადახლო ბარათების მფლობელებისათვის.

- (260) AM 2014 73185 A
- (210) AM 073185
- (220) 2013 07 26
- (731) ვიზა ინტერნეშენელ სერვის ასოციეშიენ 900 მეტრო სენტერ ბულვარი, ფოსტერ სიტი, კალიფორნია 94404, აშშ
- (740) გიორგი მეიფარიანი
- (540)

WORLD OF PRIVILEGES

- (591) შავ-თეთრი
- (511)
- 36 – საფინანსო საქმიანობა; ფულად საკრედიტო ოპერაციები; დაზღვევა; საფინანსო მომსახურება, სახელდობრ, საბანკო მომსახურება; სახლიდან განხორციელებადი საბანკო ოპერაციები ინტერნეტის მეშვეობით, საკრედიტო ბარათებთან, სადებეტო ბარათებთან, არაპროლონგირებადი კრედიტის მქონე საკრედიტო ბარათებთან და წინასწარგადახდილ ბარათებთან დაკავშირებული მომსახურება; ელექტრონული ანგარიშსწორების სისტემაში ფულადი სახსრების გადარიცხვის მომსახურება და ვალუტის გადარიცხვის მომსახურება, ელექტრონული გადახდების მომსახურება, ფულადი გაცემების მომსახურება; დაზღვევის მომსახურება, სახელდობრ, სამედიცინო დაზღვევის, სამგზავრო დაზღვევის, საავტომობილო გზებზე გადაუდებელი დახმარების დაზღვევის და იჯარის დაზღვევის დაფარვა მგზავრებისათვის, გაფართოებული გარანტიის მომსახურება; ვალდებულებების დაცვის მომსახურება; მუდმივი კლიენტებისათვის ფასდაკლებების პროგრამების და შედავათიანი გადახდების პროგრამების ადმინისტრირება და გაწევა; ყველა ზემოჩამოთვლილი მომსახურება დაკავშირებული ადმინისტრირებასთან და სარგებლის უზრუნველყოფასთან საგადახლო ბარათების მფლობელებისათვის.

დაჩქარებული პროცედურით რეგისტრირებული სასაქონლო ნიშნები

რეგისტრაციის გაუქმების მოთხოვნით საჩივრის შეტანა შესაძლებელია საქპატენტის სააპელაციო პალატაში გამოქვეყნებიდან 3 თვის ვადაში.

- (111) M 2014 24525 R
- (151) 2014 02 28
- (181) 2024 02 28
- (210) AM 075804
- (220) 2014 02 07
- (732) რეკე ინდუსტრის
ჰონკონგი, კაუზევი ბეი, ტაიმს სკვერი,
მათესონის ქ.1, შენობა 2, ოთახი 2912,
ჰონკონგი ჩინეთის სახალხო
რესპუბლიკის სპეციალური
ადმინისტრაციული რეგიონი
- (740) ნინო კუბლაშვილი
- (540)



- (591) მუქი ლურჯი, თეთრი
- (531) 27.05.04-29.01.04-
- (511)
- 7 – სარეცხი მანქანა.

9 – მონიტორი, ტელევიზორი, მობილური, პლანშეტური კომპიუტერი.

11 – კონდენციონერი, მიკროტალღური ღუმელი, ღუმელი, მაცივარი, მრავალფუნქციური საკვების მოსამზადებელი ქვაბი.

- (111) M 2014 24526 R
- (151) 2014 02 28
- (181) 2024 02 28
- (210) AM 075914
- (220) 2014 02 14
- (732) შპს სოკარ ჯორჯია პეტროლეუმი
300 არაგველის ქ.№24, 0114, თბილისი,
საქართველო
- (740) არჩილ ფირცხალავა
- (540)



- (591) შავი, თეთრი, ლურჯი
- (531) 26.05.04-27.05.05-29.01.12-
- (526) დისკლამაცია –ნიშანი დაცულია მთლიანობაში. სიტყვიერი აღნიშვნა "NANO" არ ექვემდებარება დამოუკიდებელ სამართლებრივ დაცვას.

- (511)
- 4 – ტექნიკური ზეთები და საპოხები (კონსისტენტური); საზეთი მასალა; მტვრის შთამთქმელი, დამსველავებელი და შემკვრელი შედგენილობები; საწვავი (მათ შორის, ძრავას ბენზინი) და გასანათებელი ნივთიერებები; გასანათებელი პატრუქები და სანთლები; ბენზინი; დიზელის საწვავი.

- (111) M 2014 24527 R
- (151) 2014 02 28
- (181) 2024 02 28
- (210) AM 075915
- (220) 2014 02 14
- (732) შპს სოკარ ჯორჯია პეტროლეუმი
300 არაგველის ქ.№24, 0114, თბილისი,
საქართველო
- (740) არჩილ ფირცხალავა
- (540)



- (591) შავი, ლურჯი, თეთრი
- (531) 26.05.04-28.19.00-29.01.12-
- (526) დისკლამაცია –ნიშანი დაცულია მთლიანობაში. სიტყვიერი აღნიშვნა „ნანო“ არ ექვემდებარება დამოუკიდებელ სამართლებრივ დაცვას.
- (511)

- 4 – ტექნიკური ზეთები და საპოხები (კონსისტენტური); საზეთი მასალა; მტვრის შთამთქმელი, დამსველავებელი და შემკვრელი შედგენილობები; საწვავი (მათ შორის, ძრავას ბენზინი) და გასანათებელი ნივთიერებები; გასანათებელი პატრუქები და სანთლები; ბენზინი; დიზელის საწვავი.

(111) M 2014 24528 R

(151) 2014 02 28

(181) 2024 02 28

(210) AM 075805

(220) 2014 02 07

(732) შპს „მითანა“

გ. ჭყონდიდელის ქ.№26, 0180 თბილისი,
საქართველო

(740) გიორგი გეგეჭკორი

(540)



(591) მუქი ყავისფერი, მუქი ნარინჯისფერი,
თეთრი, ბაცი ნარინჯისფერი

(531) 03.04.24-26.11.12-29.01.01-

(511)

29 – სოსისი, სარდელი, ძეხვეული, შაშხი, ქა-
ბაბი, კუპატი.

30 – მღოგვი, აჯიკა.

35 – წარმოებული პროდუქციის გასაღება.

საერთაშორისო სასაქონლო ნიშნები, რომლებზეც ბამოტანილია გადაწყვეტილება დაცვის მინიჭების შესახებ

გადაწყვეტილების გასაჩივრება შესაძლებელია საქპატენტის სააპელაციო პალატაში გამოქვეყნებიდან 3 თვის ვადაში ან მცხეთის რაიონული სასამართლოს ადმინისტრაციულ საქმეთა კოლეგიაში 1 თვის ვადაში (მის.: ქალაქი მცხეთა, სამხედროს ქ. №17).

(260) AM 2014 70528 A

(800) 1143582

(151) 2012 11 06

(731) BIOFARMA

50 rue Carnot, F-92284 SURESNES CEDEX,
France

(540)

ΑΡΙΦΑΜ

(591) Black, white

(511)

5 – Pharmaceutical preparations for the prevention and/or treatment of cardiovascular diseases.

(260) AM 2014 70529 A

(800) 1143609

(151) 2012 06 15

(731) OSMANLI MAKINA TURIZM OTOMOTIV

TEMIZLIK INSAAT ITHALAT IHRACAT
SANAYI VE TICARET LIMITED SIRKETI
Aydinli Mah. Tuzla Mermerciler, Organize
Sanayi Bölgesi, Gazi Bulvarı No:5 Tuzla,
Istanbul, Turkey

(540)

MATTIOLI

(591) Blue, white, dark green

(511)

7 – Machines for wood, metal, glass and plastic materials and minerals processing and giving shape, machine tools and industrial robots are used for this purpose; business machines, robotic mechanisms which have the same function; lifting, carrying and forwarding machines, robotic mechanisms which have the same function (elevators, escalators, cranes included); machinery and robotic mechanisms which are used for agriculture, animal husbandry, grain/fruit/vegetable/food processing; motors other than for land vehicles, electric motors, their parts and fittings; bearings, ball or roller bearings; tire removal and replacement machines; alternators, generators, electric generators, solar-powered generators; paint machines, automatic paint spray guns, electric staple machines and guns, electric glue guns, guns for compressed air or liquid spray machines, electric hand drills, electric hand saws, jigsaw machines, spiral machines, pressurized air generators, compre-

ssor, car washing machines and robots which have the same function with the above mentioned machinery and tools; welding machines and robots which have the same function with those; printing machines; packaging machines, filling-plugging and sealing machines, labeling machines, sorting machines and robots and robotic mechanisms which have the same function with mentioned above; textile machines, sewing machines and industrial robots which have the same function with mentioned above; pumps which are not part of the machine or engine; electrical appliances for chopping, grinding, crushing, mixing and crumbling for the kitchen use; washing machines (washing/dishwashing machines included); floor, carpet or upholstery cleaning electrical machines, vacuum cleaners and parts thereof.

(260) AM 2014 70531 A

(800) 1143676

(151) 2012 05 07

(731) KUTLUSAN KAFES EKİPMAN VE
HAYVANCILIK TAŞIMACILIK SANAYİ
VE TİCARET LİMİTED ŞİRKETİ
Ankara Karayolu 33. Km., Akalan Köyü,
Kemalpaşa, İzmir, Turkey

(540)

KUTLUSAN

(591) Yellow and dark blue

(511)

6 – Non-precious metal ores, common metals and their alloys and semi-manufactured products of common metals and their alloys; metal building products for sheltering, preserving, conserving, covering, girdling, warehousing (including metal ladders), metal floors, metal staircases, metal gates and fences, metal railings for fences, metal roofing, metal palings; metal products manufactured for sifting, filtering and similar purposes; namely, metal window screens, drain traps (valves) of metal; metal doors and windows, metal rolling shutters, metal жалусии, metallic door handles, metallic window handles, metal panels of doors and windows; metal cables and wires not for electrical purposes; ironmongery (hardware) articles, small items of metal hardware, namely, screws, nails, bolts, nuts, metal chains, pulley; ducts of metal for ventilating and air conditioning and heating installations, metal roof vents for residential and commercial buildings,

metal vent covers for HVAC ducts, drains and pitch pans, metal chimneys, chimney cowls of metal, metal manhole covers for drains, poles of metal for electric power lines, metal gratings; signs, non-luminous and non-mechanical, of metal; signaling panels, non-luminous and non-mechanical, of metal; identity plates of metal; metal pipes for liquid or gas transfer and their connection parts (including valves of metal), drilling pipes of metal; metal cash boxes; materials of metal for railway construction; metal bollards, metal mooring buoys, anchors for sea vehicles; metallic moulds for metal casting; works of art made of common metals and their alloys; metal bottle caps; poles of metal; metal pallets, metal ropes for lifting, loading and transportation, metal wires, cords, columns, strips, bands and tapes for use in lifting and carrying load; poultry cages of metal.

7 – Machines and machine tools to process wooden, glass and plastic materials; lathes, milling machines, planing machines, saws, emery machines, grinding machines, chisels for machines, plastic injection machines, threading machines; bulldozers, diggers, excavators, road making machines, road rollers, hammer drills, road sweeping machines; rolling mills, power hammers, moulding machines, rolling mill cylinders; conveyors and lifting apparatus; elevators, loading ramps, lifts, winches, hoists, moving staircases, belt conveyors; milking machines; churn machines; incubators for eggs; agricultural tools other than hand-operated and machines; reapers and binders, ploughs, harrows, straw cutters, grass mowing machines, spraying machines for use in agriculture; motors and engines (other than for land vehicles); connecting rods for motors and engines, machine wheels, transmission chains and shafts other than for land vehicles, bearings for transmission shafts, pressure reducers (parts of machines and motors), pressure regulators (parts of machines and motors), pressure valves, hydraulic and pneumatic controls for machines, torque converters, not for land vehicles, motors and engines; pulleys, bobbins for weaving looms, pistons for engines, speed governors for machines, converters for steel works; clutches, other than for land vehicles; turbines, other than for land vehicles; brake linings, segments and shoes, other than for land vehicles; starters for motors and engines; dynamos, bicycle dynamos, sparking plugs and igniting devices for internal combustion engines, injectors for engines; exhausts for motors and engines, silencers for motors and engines; belts for motors and engines; dynamo belts, belt conveyors; bearings (parts of machines), ball rings for bearings; carburetors, carburetor feeders; fuel economizers for motors and engines, fuel conversion apparatus for internal combustion engines; radiators (cooling) for motors and engines, fans for motors and engines; fuel and air filters for parts of motors and engines; hydraulic and pneumatic cylinders, cylinder heads

for engines; electric motors, other than for land vehicles; machines used for changing wheels; alternators, current generators, generators of electricity, generators of solar energy; painting machines, spray guns for paint, electric punching machines and guns, electric glue guns, spray guns for pressed air and liquids, electric hand drills, hand saws (machines) robots (machines); hair cutting machines for animals; compressed air machines, compressors; welding apparatus, gas-operated; electric welding machines; printing machines, parts and fittings of printing machines; mine borers, mine working machines; packaging machines, packing machines, labellers (machines); sewing machines, embroidering machines, buttonhole sewing machines, cutting machines for use in the textile industry; textile machines; bale unpacking machines, threshing machines, raking machines, threading machines, weaving looms; water pumps, pumps for heating installations; pumps (parts of machines and engines); pumps for liquids and gas; electric kitchen equipment for chopping, grinding, crushing, mixing and crumbling; mixers and electric blenders for household purposes, food processors, electric knives, meat mincers (machines), electric waste processors; dishwashers, washing machines and compressors for washing machines, electric polishing machines and apparatus; electric vacuum cleaners and electric carpet washing machines and their parts and components); casting machines; parts and fittings of casting machines, converters for steel works; washing installations for vehicles; automatic kneading machines, dough shaping machines, dough-cutting machines, sieving machines, sifters; vacuum cleaners; mills (machines), grain processing machines, grain husking machines, grain separators; haulers; stamping machines.

(260) AM 2014 70532 A

(800) 1143677

(151) 2012 06 19

(731) Obshchestvo s ogranichennoy

otvetstvennostyu "Roschai"

36, lit. A, pom. 25-H, pr-kt Prosveshcheniya,

RU-194358 Saint-Petersburg, Russian

Federation

(540)

SebaSTea

(591) White and light brown

(511)

30 – tea.

(260) AM 2014 70534 A
 (800) 1143741
 (151) 2012 08 20
 (731) Zakritoe akcionernoe obchtchestvo
 "Twins Tec"
 Ryabinovaya street 65, building 1,
 RU-121471 Moscow, Russian Federation

(540)

ДО И ПОСЛЕ

(591) Black, white
 (511)
 3 – Toiletries; dentifrices; hair lotions; shampoos; aromatics [essential oils]; flavorings for beverages [essential oils]; sachets for perfuming linen; scented water; toilet water; cotton wool for cosmetic purposes; essential oils; ethereal oils.
 5 – Tonics [medicines]; medicinal tea; mineral waters for medical purposes.

(260) AM 2014 70535 A
 (800) 249892
 (151) 1961 11 24
 (891) 2012 08 24
 (731) Silesia Gerhard Hanke GmbH & Co KG
 Am Alten Bach 20-24, 41470 Neuss,
 Germany

(540)

Silesia

(591) Black, white
 (511)
 3 – Essential oils.
 29 – Meat, fish, meat extracts, canned meat, fish, fruit and vegetables; meat, fish, fruit and vegetable jellies.
 30 – Flavors and essences for making spirits; coffee, artificial coffee, tea, honey, flour and edible products (Vorkost), pasta, condiments, spices, sauces, vinegar, mustard, cooking salt, flavors and essences for making sugar confectionery.
 31 – Vegetables, fruits.
 32 – Essences for making spirits, fruit juices.
 33 – Wines, spirits, essences for making spirits.

(260) AM 2014 70537 A
 (800) 715631
 (151) 1999 05 13
 (891) 2012 10 30
 (731) FIDIA FARMACEUTICI S.p.A.
 Via Ponte della Fabbrica, 3/A, I-35031
 ABANO TERME (PD), Italy

(540)

ITAMI

(591) Black, white
 (511)
 5 – Pharmaceutical preparations.

(260) AM 2014 70538 A
 (800) 720977
 (151) 1999 07 27
 (891) 2012 07 24
 (731) LABORATOIRES SVR
 ZAC de la Tremblaie, Rue de la Mare à Blot,
 F-91220 Le Plessis Pate, France

(540)

calmobrul

(591) Black, white
 (511)
 3 – Perfumery, cosmetics, soaps, hair products, skin-care creams, dentifrices, deodorants, antiperspirants.
 5 – Veterinary, sanitary products.

(260) AM 2014 70540 A
 (800) 738591
 (151) 2000 08 03
 (891) 2012 09 26
 (731) OM Pharma SA
 Rue du Bois-du-Lan 22 CH-1217 Meyrin
 2 / Genève, Switzerland

(540)

OM PHARMA

(591) Black, white
 (511)
 5 – Pharmaceutical and veterinary products.

(260) AM 2014 70542 A
 (800) 783395
 (151) 2002 06 18
 (891) 2012 10 22
 (731) Newport Pharmaceuticals Limited
 A4, Swords Enterprise Park, Feltrim Road
 Swords, County Dublin, Ireland

(540)

ISOPRINOSINE

(591) Black, white
 (511)
 5 – Pharmaceutical preparations and substances.

(260) AM 2014 70633 A
 (800) 1144765
 (151) 2012 02 22
 (731) Twin Disc, Incorporated
 1328 Racine Street, Racine WI 53403, USA

(540)



(591) Black, white
(511)

7 – Hydraulic and air clutches other than for land vehicles, mechanical and hydraulic power take-off units other than for land vehicles, reduction gear units other than for land vehicles, marine transmissions, hydraulic torque converters other than for land vehicles, power-shift transmissions other than for land vehicles, gear boxes other than for land vehicles, marine jets, marine drives, propulsion mechanisms for marine vessels, hydraulic systems for controlling the above goods, and component machine parts for all of the above.

9 – Electronic controls for automated operation of clutches and power-shift transmissions, marine management systems, dynamic vessel positioning systems, electronic shift control, electronic trim control, emergency backup gear control, joystick control system for controlling the maneuvering of a marine vessel.

12 – Clutches for land vehicles, pump drives, gear boxes and transmissions for land vehicles, mechanical and hydraulic power take off units for land vehicles, torque converters for land vehicles, trim tabs for marine vessels.

35 – Distributorships and dealerships in the field of marine, automotive, and industrial machines and components.

37 – Service, maintenance, and repair services in the field of marine, automotive, and industrial machines and components.

42 – Services relating to engineering, engineering consulting, industrial design of marine, automotive, and industrial machines and components.

(260) AM 2014 70634 A
(800) 1144777
(151) 2012 04 13

(731) Dr. med. Matthias Rath
1260 Memorex Drive, Santa Clara,
CA 95050, USA

(540)

Dr. Rath Vitamin B Complex

(591) Black, white
(511)

5 – Pharmaceutical products; vitamin preparations and food supplements with a base of minerals, all for medical purposes; food supplements not for medical purposes, mainly consisting of vitamins, amino acids, minerals and trace elements; food supplements and dietetic substances not for medical use with a base of vitamins, amino acids, minerals and trace elements.

29 – Foodstuffs of animal origin, included in this class, in particular meat, fish, poultry, game and

meat extracts; vegetables and other edible horticultural products, prepared for consumption or preservation, included in this class, in particular preserved, dried and cooked fruit and vegetables; jellies, jams, eggs, milk and milk products; edible oils and fats; fat-containing mixtures for bread slices; tofu.

(260) AM 2014 70635 A

(800) 1144778

(151) 2012 04 13

(731) Dr. med. Matthias Rath
1260 Memorex Drive, Santa Clara,
CA 95050, USA

(540)

Dr. Rath Q10 Complex

(591) Black, white
(511)

5 – Pharmaceutical products; vitamin preparations and food supplements with a base of minerals, all for medical purposes; food supplements not for medical purposes, mainly consisting of vitamins, amino acids, minerals and trace elements; food supplements and dietetic substances not for medical use with a base of vitamins, amino acids, minerals and trace elements.

29 – Foodstuffs of animal origin, included in class 29, in particular meat, fish, poultry, game and meat extracts; vegetables and other edible horticultural products, prepared for consumption or preservation, included in this class, in particular preserved, dried and cooked fruit and vegetables; jellies, jams, eggs, milk and milk products; edible oils and fats; fat-containing mixtures for bread slices; tofu.

(260) AM 2014 70636 A

(800) 1144827

(151) 2012 09 13

(731) KAZAR FOOTWEAR Sp. z o.o.
ul. Lwowska 154, PL-37-700 Przemysl,
Poland

(540)

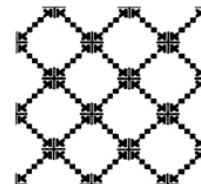

(591) Black, white
(511)

18 – Leather and leather imitations, and goods made of these materials and not included in other classes; trunks; suitcases and travel bags.

25 – Clothing; footwear; headgear; furs, clothing made of leather and leather imitation.

(260) AM 2014 70637 A
 (800) 664580
 (151) 1996 07 30
 (891) 2012 11 13
 (731) S.C. BIOTEHNOS S.A.
 Gorunului Street 3-5, 075100 OTOPENI,
 ILFOV, Romania

(540)
A L F L U T O P

(591) Black, white
 (511)
 5 – Medicines.

(260) AM 2014 70638 A
 (800) 746294
 (151) 2000 10 30
 (891) 2012 11 16
 (731) DAVINES S.p.A.
 Via Ravasini, 9/A, I-43100 PARMA, Italy

(540)

(591) Black, white
 (511)
 3 – Dyes and cosmetic products for colouring hair; cosmetics, gel for beards, perfumes, after-shave lotions, cosmetic products for skin care, make-up products, hair gels and lotions, shampoos, bleaching preparations for cosmetic purposes.

(260) AM 2014 70641 A
 (800) 885413
 (151) 2006 05 18
 (891) 2012 11 28
 (731) KISTLER HOLDING AG
 Eulachstrasse 22, CH-8408 Winterthur,
 Switzerland

(540)
KISTLER

(591) Black, white
 (511)
 9 – Scientific measuring and checking apparatus and instruments; apparatus for recording, transmission, monitoring and reproduction of electric, electronic, optical and acoustic signals; data processing apparatus and equipment; monitors; computer programs.
 42 – Scientific and technological services as well as research, development and calibration services relating thereto; industrial analysis and research services; design and development of computers and software.

(260) AM 2014 70642 A
 (800) 895250
 (151) 2006 06 27
 (891) 2012 12 04
 (731) Carlsberg Breweries A/S
 Ny Carlsberg Vej 100, DK-1760 Copenhagen
 V, Denmark

(540)

HOLSTEN

(591) Black, white
 (511)
 32 – Beer; low-alcohol beers, non-alcoholic beers; mineral water, sparkling waters and other non-alcoholic beverages.

(260) AM 2014 70646 A
 (800) 907113
 (151) 2006 10 25
 (891) 2012 12 10
 (731) Obschestvo s ogranichennoy otvetstvennostyu
 "Masloekstraktsionniy zavod Yug Rusi"
 Tolstogo sq., 8, RU-344037 Rostov-on-Don,
 Russian Federation

(540)
СТО РЕЦЕПТОВ

(591) Black, white
 (511)
 29 – Colza oil for food; rape oil for food; edible oils; corn oil, maize oil, palm kernel oil for food; sesame oil, palm oil for food, olive oil for food, sunflower oil for food; coconut oil.
 30 – Cookies; pancakes, bread rolls, waffles, vermicelli (noodles), confectionery for decorating Christmas trees, cakes, pastries, peanut confectionery, almond confectionery; farinaceous food pastes; pasta; macaroni, pasty, pate (pastries), capers; groats for human food, husked barley, crushed barley, sago, semolina, farinaceous foods, noodles, ribbon vermicelli, fruit jellies (confectionery), marzipan; custard, lozenges (confectionery), pastilles (confectionery), molasses for food; golden syrup, pepper, biscuits; malt biscuits, macaroons (pastry), petit-beurre biscuits; pies; pizzas; popcorn; weeds (condiment), condiments; ketchup (sauce); sauces (condiments), chow-chow (condiment), relish (condiment), tomato sauce, mayonnaise, soya sauce, chutneys (condiments), dressings for salad; meat gravies, cereal preparations, flour-milling products, gingerbread, cinnamon (spice); curry (spice); cloves (spice), spices, allspice, ginger (spice), cake paste, pastry, confectionery, sugar confectionery, salt for

preserving foodstuffs; spaghetti, rusks, breadcrumbs, tarts, edible decorations for cakes; halvah; bread; unleavened bread, corn flakes, maize flakes, oat flakes, chips (cereal products).

(260) AM 2014 70647 A

(800) 910478

(151) 2005 12 13

(891) 2012 12 11

(731) General Electric Company

1 River Road, Schenectady, NY 12345, USA

(540)



(591) Black, white

(511)

1 – Chemicals, biochemicals and reagents for use in industry, science and research; chemical preparations and reagents for analysis or diagnosis used for scientific purposes, namely, chemical preparations for cell separation and culture, nucleic acid purification, nucleotides, fluorescent nucleotides, oligonucleotides, peptides, proteins, amino acids, organic molecules, and markers for DNA/RNA synthesis; reagents for luminescence; reagents for gene expression quantification; reagents for use with the polymerase chain reaction process; reagents for use with the rolling circle amplification process; reagents for cDNA cloning and vectors, modifying and restriction enzymes; reagents for labeling, sequencing and fragment analysis of nucleic acids, proteins and custom synthesis; reagents for recombinant protein expression purification; chromatography media; reagents for electrophoresis, bioinformatics, spectrophotometry and fluorometry; radiochemicals; reagents for scintillating proximity assays; chemical preparations (assays) for high through put screening for drug development; reagents for high resolution laser fluorescence confocal microscopy; specialty chemicals for industry, science and research; gases and gas mixtures for industrial, research and scientific purposes; chemical preparations and substances for use in the manufacture of pharmaceutical products, diagnostic preparations and substances; chemical test reagents, saline solution and reagent-coated paper all for scientific and laboratory use; fissionable chemical elements; radioactive elements and isotopes for industrial, scientific and research purposes; radioactive sources and standards for use in radiographic techniques; radioactive sources for use in non-destructive testing, purification and sterilizing techniques; radionuclides; chemicals and

chemical compositions for use in the treatment of water systems, wastewater treatment systems, cooling water systems, boiler water and steam generating systems, boiler condensate systems, fluid separation systems, water clarification and dewatering in aqueous systems, water conditioning systems, gas cleaning systems, industrial process systems, fuels and fuel processing systems, hydrocarbon and gas processing systems, oil and gas processing and petrochemical systems, pulp and papermaking systems, metal and plastic coating systems, metal processing systems, and material handling; chemical gasoline additives and distillate fuel additives; performance additives for fuels used in turbine engines; desiccants for water-absorption in the form of bags of chemically-treated granular materials for placement into fuel tanks; test kit consisting of reagents used for determining the presence of algae and active organic organisms in diesel fuel; bacteria cultures and nutrients for wastewater and sludge treatment; polymeric chemicals used to disperse particulate matter in steam generating equipment; chemicals and chemical compositions as antifoulants and demulsifiers in coke-making and by-product operations of iron and steel industries.

2 – Chemicals and chemical compositions for use in the metal finishing industry as a final aqueous acidic rinse in the conversion coating of steel, aluminum, galvanized and mixed metal coil surfaces to enhance corrosion protection and paint adhesion; chemicals and chemical compositions for use as corrosion inhibitors in cooling water systems; resinous coatings for metal and masonry surfaces.

3 – Chemicals and chemical compositions for use in cleaning steel, aluminum, galvanized and mixed metal surfaces for general industrial use in the manufacture of metal products; chemicals and chemical compositions for use in industry, namely cleaning agents to remove contaminants from industrial process systems and paint strippers to remove paint from equipment surfaces in paint spray booth operations.

5 – Pharmaceutical and veterinary preparations, medicines and substances; diagnostic agents, preparations and substances for medical purposes; contrast media for medical imaging; diagnostic scanning agents for in vivo use; diagnostic imaging agents for magnetic resonance imaging (MRI); radiopharmaceutical products; radioactive substances for use in nuclear medicine; radioactive pharmaceutical preparations and non-radioactive reagents for producing radiopharmaceuticals for in vivo diagnostic or therapeutic use; gases and gas mixtures for medical imaging; chemical compositions used to inhibit cooling water system fouling due to mollusca and microorganisms; bactericides, fungicides, and algicides for use in the treatment of aqueous systems used in the preparation of wood pulp, paper, and paper

products; compositions for the control of bacteria, fungi, and algae; pre-filled vials containing medical diagnostic reagents; pre-filled cartridges containing chemical solutions for medical use; pre-filled cylinders containing gases and gas mixtures for medical use; pre-filled cartridges containing X-ray contrast media for medical purposes.

6 – Metal locks; metal security enclosures, namely, key cabinets, storage tubes and storage boxes for securing keys; metal lockboxes for residential, vehicular, industrial and real estate sales use; lockable metal key cabinets for storing keys; metal key safes.

7 – Pumps, namely, centrifugal pumps, diaphragm pumps, bellows pumps and process and transfer pumps; fluid control devices, namely, valves, regulators, and ejectors; filter cartridges for various industrial machines for filtration applications including the filtration of coating solutions for the manufacture of magnetic tape and the filtration of petrochemicals, potable water, beer in the brewing industry, and other specialty chemicals; machines for the feeding and application of chemicals for industrial uses.

9 – Software and software programs for industrial, research, and medical use; apparatus for electrophoresis; chromatography columns and pumps for laboratory use; apparatus for microfabrication (nanotechnology); computer systems and laboratory apparatus for bioinformatics; scintillation counters; imaging apparatus for radioactive and luminescent emissions; synthesis and purification integrated systems; laboratory apparatus for producing oligonucleotides; laboratory apparatus for use with microarrays; laser-based optical systems for digital imaging; microarray slides; laboratory glassware; vials and microvials; microtitre plates; computer software for hospital operating room management; computer software for critical care information management; industrial process control software; computer software programs for use in factory management; graphical user interface based computer programs for controlling machines in industrial automation applications; software for creating graphics displays and editing dynamic data interfaces for realtime graphics applications for industrial and business applications; communications software for connecting computer network users; software for plastic injection molding; software for control, monitoring, simulation, communications, data logging and collection, and factory automation; software to integrate manufacturing machine operations, control processes, provide data for visualization, track problems and generate production reports; packaged software for use in the operation and programming of grinding machines in the manufacturing industry; Industrial process control hardware, namely, computer monitors; laptop computers, ethernet cards and cables; computer networking hardware, memory cards;

microchips; microprocessors; computer network hubs, switches and routers, computer accessories, display devices and terminals; computer whiteboards; system boards and processors; computer software for call control, operator interfaces, gage interfaces and data collection; computer software for control and manufacturing applications, namely, statistical process control, data collection, and distributed numerical control; computer hardware and software for manufacturing execution systems and document management; digital signal processing products and systems, namely industrial automation controls and programmable logic controllers; electronic control apparatus for machine tools, namely, an adaptive control product in the nature of an external controller to optimize machine tool cutting performance of rough and semi-rough cuts; distributed and remote input/output hardware devices, input/output modules, interface modules, power supplies and mounting hardware; digital music players; cellular telephones; intrusion and burglar alarm systems; security devices, namely, programming logic computers, control panels, electronic intrusion detectors, electronic glassbreak sensors, electronic vibration sensors, magnetic contacts for use in security systems, electronic switch plates, electronic motion sensors for alarm systems, electronic motion sensitive switches, hardwire sirens, audio speakers, electronic drivers, access control and alarm monitoring systems; fire, heat and smoke detecting and alarm units; computer card operated access control systems; card readers, card encoders, and encoded cards for use with card operated access control systems; video cameras; video systems for use in object recognition, object tracking, alarm verification, face recognition, and vehicle recognition; video license plate readers; video traffic detectors; video access door controllers; video intrusion detectors; processing hardware and software that analyzes digital video images to automatically extract, record and report intelligence, and remote video monitoring systems for security and surveillance applications; central video monitors; video recorders; cameras; closed circuit video systems; closed circuit video system comprising one or more cameras, and a camera housing; short range, wireless, radio frequency transceivers; power line transceivers; communication control hardware for operating closed circuit cameras; communication control hardware, namely keypad controllers, matrix switches, multiplexers, digital video recorders, integrated pan-tilt-zoom domes, remote video controllers, receivers, electronic alarm, management controls and triggers, and video transmission devices sold separately or as part of a system for operating closed circuit cameras; personal digital assistant devices configured for use by real estate professionals; communications interface devices for use with personal digital assistant devices; fiber-optic trans-

mission systems, namely, fiber optic transmitters, receivers and transceivers used in the transmission of video, audio, and data signals over optical fibers; electrical switches; electromechanical locks; magnetic locks; electric keys; hand-held electronic hardware for receiving, controlling, storing, manipulating, displaying and transmitting data and for operating electronic locks; electronic access cards and readers and encoders therefor; magnetic access cards and readers and encoders therefor; smart access cards and readers and encoders therefor; proximity cards and readers and encoders therefor; bar code access cards and readers and encoders; access keypads; radio frequency tracking tags; tracking and control system comprising one or more radio frequency tags, transceivers, and sensors used to determine and monitor the location and movement of tangible assets, inventory and individuals; infrared sensors; computer hardware and software for facilities management and controlling facility access systems and components therefor, namely, control panels, access card readers, and equipment and systems for video imaging, video monitoring; computer hardware and software for digital hard drive recording, network transmission and remote access; networked digital video storage servers, computer hardware and software for access control and surveillance applications, including alarm monitoring and security; computer software and hardware for controlling and operating security and access systems comprising locks, doors, access, and identification; devices and security enclosures in the nature of boxes for securing keys with an electronic time stamp that records the last nine access events; surveillance equipment sold individually as components or together as a system comprising one or more surveillance cameras, covert cameras, closed circuit television cameras, camera housings, camera mounts, camera lenses, video monitors, video recorders, digital recorders, video storage media, video switches, control panels, keypad controllers, joystick controllers, interface apparatus for alarms and access control equipment, transceivers, receivers, transmitters, signal processors, multiplexers, matrix switches, controllers, control panel housing, switch housing, transformer switches, splitters, coaxial cables, connectors, motion detectors, microphones and speakers; computer user interface software and control software for managing security, fire and access systems; electric locks; hand-held electronic computer and communication hardware for receiving, controlling, storing, manipulating, displaying and transmitting data for operating electronic locks; electronic key fobs, readers and encoders; magnetic data carriers; data processing software and computer hardware; power supplies, namely batteries, rectifiers, voltage and current regulators and transformers; control panels, namely, electronic apparatus adapted to electrically monitor a pre-determined

activity and activate a burglar alarm; siren speakers, and electronic siren drivers, namely, tone generators and amplifiers adapted to be used for sirens; computer software to control communication hardware for operating and controlling closed circuit cameras; switch units incorporating magnetically actuated reed switches for use in burglary and fire sensing alarm systems, in industrial position sensing apparatus, in revolution counters, in equipment cabinet safety interlock systems, in industrial position controlling apparatus, in electrical cables and in pump and valve controlling apparatus and home security alarm systems; electrical and electronic checking apparatus for screening individuals, baggage, and cargo for the presence of particular substances; electrical and electronic checking apparatus for screening individuals, baggage, and cargo for the presence of explosives and/or narcotics; apparatus for detecting presence of explosives and other contraband; time or condition sensing apparatus for initiating and controlling regeneration or backwash cycles for water treatment equipment; bioreactors for culturing cells (laboratory apparatus); portable analytical instruments, namely, a probe with a microprocessor-based data conversion logger for measurement of organic and inorganic chemicals in water; filters and filter housings for laboratory use; fluid separation apparatus for laboratory use; membrane filters for laboratory use; silt density measuring device; deionization units for laboratory use; fluid flow control devices, namely, pumps, valves, flow meters and regulators for laboratory use; ozone monitors; laboratory equipment, namely, porous microtitre plates for use in cell biology and other life science applications; electronic water and process treatment controls, namely, apparatus for use in the treatment of commercial and industrial water systems, boiler water systems, cooling water systems, and closed water systems, pulp and paper processing systems, fuel processing systems, and metal processing systems to analyze the chemistry of the system, determine the proper treatment program, apply the desired treatment and monitor the effectiveness of the treatment; computer software for data management in the water treatment and pulp and paper fields; electronic controllers used for processing information in the water treatment and pulp and paper fields; apparatus for use in industrial water systems to measure and control ph and conductivity; apparatus for feeding chemicals to an industrial, commercial or municipal water system in measured amounts; electronic test apparatus for use in water treatment; laboratory testing equipment, namely, deposition and corrosion rate testers; mobile laboratory equipped with equipment and instrumentation to monitor and measure ph, conductivity, and chromate concentration of industrial and domestic waters, to conduct inorganic analysis of water and to conduct microbiological testing of water; flow me-

ters, pressure switches, sequence timers, electrical controls and switches; test tubes; automatic controls and instruments to monitor operating parameters of units and systems for water purification; computer systems for anesthesia record keeping and data management.

10 – Apparatus for use in medical analysis; medical apparatus and accessories systems for the dispensing of measured unit doses of pharmaceutical preparations; cannulas; syringes; injectors; infusion pumps for intravenous administration of fluids; needles for medical purposes; implantable radiation therapy devices consisting of encapsulated radioisotope brachytherapy sources; radiation therapy delivery system consisting of radioactive seeds and a bio-absorbable carrier assembly; cardiac output monitors; heat and moisture exchangers for respiratory apparatus for medical use; bacteria filters for medical use; gas analyzers for medical purposes; patient monitoring systems, namely, gas monitors, pulse oximeters, multiparameter monitors, ECG monitors, invasive and non-invasive blood pressure monitors, neuromuscular transmission monitors, metabolic monitors and spirometers for anesthesia, intensive care and diagnostic applications; anesthesia machines and ventilators; intensive care and anesthesia accessories for single patient use, namely, gas sampling lines, airway adapters, breathing circuits, spirometry sensors and tubes, tubes, water traps, pulse oximetry sensors, non-invasive blood pressure cuffs, flushing sets, anesthesia masks, carbon dioxide absorbers, temperature probes and nebulizers; central nervous system monitors; gastrointestinal tonometers.

11 – Apparatus for water purification and treatment, and for waste water treatment, namely fluid separation units, fluid concentration units and fluid recycling units; filter apparatus used for filtering solids from gases and liquids or filtering liquids from gases, and for filtering one immiscible liquid from another; filters in the form of spirally-wound elements or cartridges contained within a tubular plastic sleeve for concentrating products and removing impurities in fluid treatment systems; water conditioning units for residential purposes; reverse osmosis modules and membranes therefor; water purification units and systems consisting of clarifiers, electrodeionization systems, condensate polishers being apparatus for water purification, vacuum degasification units for water treatment, ultra filtration units, ultraviolet sterilizers, ion exchangers, acid and caustic regeneration systems for water treatment, reverse osmosis systems, forced draft decarbonator units for treating waste water, filters, chemical feed systems and bulk storage units for use in water treatment; electrochemical liquid purification units for use in the industrial, commercial and

municipal sectors; water filtering units for domestic, commercial and industrial use; waste water purification units; water purifying units for potable water for domestic, commercial and industrial use; control valves for water conditioning and water filtration equipment; fluid separation units, namely industrial fluid filters; recycling units, namely, fluid purification units; water treatment equipment, namely, filter cartridges; water treatment equipment for household use, namely, water softeners and water conditioners; media filters and depth filters for removing sediments, iron, sulfur, tastes and odors from water; depth filter units and depth filter cartridges for liquid and air filtration for domestic, industrial and commercial use; disposable cartridge filters for industrial use; apparatus for purifying water using reverse osmosis technology, namely semi-permeable membrane filter cartridges and parts thereof.

16 – Program manuals for computer software for use in factory management; card lamination apparatus; indicator charts for evaluating test results.

17 – Polymeric membrane material for use in the separation of fluids.

21 – Vials.

40 – Reverse osmosis water purification.

(260) AM 2014 70653 A

(800) 922394

(151) 2007 04 16

(891) 2012 10 19

(731) Richter Gedeon Nyrt.

Gyömrői út 19-21, H-1103 Budapest,
Hungary

(540)

BEJARA

(591) Black, white

(511)

5 – Pharmaceutical products for human use namely hormone-based medicines.

(260) AM 2014 70654 A

(800) 931930

(151) 2007 02 15

(891) 2012 11 14

(731) Ludorum Plc

2B River Court, 27 Brewhouse Lane, Putney
Wharf, London SW15 2JX, United Kingdom

(540)

CHUGGINGTON

(591) Black, white

(511)

9 – Computer software; compact discs; music videos and games downloadable from the Internet; computer game equipment; mouse mats; mobile phone

accessories; interactive games; televisions, video and CD players; ring tones; screen savers; interactive computer game programs; interactive virtual reality games; computer hardware and computer software programs for the integration of text, audio, graphics, still images and moving pictures into an interactive delivery for multi-media applications.

16 – Books, magazines, comics, stationery, pens.

28 – Games, toys, self-contained computer game equipment.

41 – Education, entertainment, sporting and cultural activities; production, preparation, presentation, distribution, and rental of television and radio programmes and films, animated films, videos, DVDs, computer games and sound and/or visual recordings; production of live entertainment; electronic games services provided by the Internet; entertainment services, namely providing music, games and videos via the Internet (not downloadable); provision of music (not downloadable) from the Internet; providing a computer game that may be accessed network wide by network users; entertainment services featuring fictional characters; music publishing services; provision of on-line electronic publications (not downloadable); electronic game services provided from a computer database, the Internet or any other communications network including wireless, cable, satellite; advisory and consultancy services related to the aforementioned services.

42 – Production of art work for animated films.

45 – Licensing of film products.

(260) AM 2014 70655 A

(800) 1001876

(151) 2009 04 02

(891) 2012 11 20

(731) Obshchestvo s ogranichennoi otvetstvennostyuu "Aleksandrovy pogreba" str. 25, 79A Altufyevskoe Sh. RU-127410 Moscow, Russian Federation

(540)

RUSSIAN CHALLENGE

(591) Black, white

(511)

33 – Vodka.

(260) AM 2014 70656 A

(800) 1003345

(151) 2009 04 06

(891) 2012 11 05

(731) CORTEFIEL, S.A

Avda. del Llano Castellano, 51, E-28034

MADRID, Spain

(540)



(591) Black, white

(511)

25 – Clothing, footwear (except orthopedic footwear) and headgear.

(260) AM 2014 70658 A

(800) 1026338

(151) 2009 09 07

(891) 2012 10 12

(731) ERK PAZARLAMA VE GİYİM SANAYİ VE TİCARET ANONİM ŞİRKETİ

Zafer Mahallesi, Çınar Sokak No:2, Kat:3,

Yenibosna – İstanbul, Turkey

(540)



(591) Black, white

(511)

25 – Clothing, namely, trousers, jackets, overcoats, coats, skirts, suits, jerseys, waistcoats, shirts, T-shirts, sweatshirts, dresses, Bermuda shorts, shorts, pajamas, pullovers, jeans, tracksuits, rainwear, beachwear, bathing suits, swimming suits; clothing for sportswear, clothing for babies; underclothing, namely, boxer shorts, brassieres, briefs, pants, socks; footwear, namely, shoes (excluding orthopedic shoes), sandals, waterproof boots, walking boots, bootees, sporting shoes, slippers; shoe parts namely heelpieces, insoles for footwear, footwear uppers; headgear, namely, caps, skull caps, sports caps, hats, berets; gloves (clothing), stockings, belts (clothing), camisoles, sarongs, scarves, neck scarves, shawls, collars, neckties, ties, suspender belts.

35 – Advertising agencies services, marketing and publicity bureaus services; commercial or advertisement exhibition and trade fair organization services, organization of exhibitions for promoting the sale of clothing and textiles, public relations; providing office functions; secretarial services, document reproduction, photocopying, typing services, word processing, compilation of information into computer databases, systemization of information into

computer databases; business administration consultancy; commercial or industrial management assistance, business management and organization consultancy, import and export agencies; evaluations, expert appraisals, information and research of industrial and commercial goods, auctioneering; bringing together, for the benefit of others, goods made of leather, clothing, footwear, headgear (excluding the transport thereof), enabling customers to view and purchase those goods.

(260) AM 2014 70659 A
 (800) 1033984
 (151) 2010 02 02
 (891) 2012 10 31
 (731) I.T.C.G. International Tea Company
 (Germany) GmbH
 Oststr. 84 40210 Düsseldorf, Germany
 (540)

BERNLEY

(591) Black, white
 (511)
 30 – Coffee, tea, cocoa, sugar, artificial coffee, preparations made from cereals, bread, pastry and confectionery; honey, treacle.

(260) AM 2014 70660 A
 (800) 1037865
 (151) 2010 01 29
 (891) 2012 08 02
 (731) Bilfinger SE
 Carl-Reiss-Platz 1-5, 68165 Mannheim,
 Germany
 (540)

bilfinger

(591) Black, white
 (511)
 1 – Industrial chemicals; chemical preparations for scientific, agricultural, horticultural and forestry purposes; unprocessed artificial resins and plastics; fire extinguishing compositions; preparations for tempering and soldering of metals; adhesives for industrial purposes; oil-separating chemicals; concrete-aeration chemicals; agglutinants for concrete.
 6 – Metal building materials; transportable buildings of metal; building materials of metal for railway tracks; non-electric cables and wires of common metal; ironmongery, small items of metal hardware; metallic pipes and tubes; goods of common metal, included in this class; buildings of metal; containers of metal; casks; vats and tanks of metal; metal constructions.
 7 – Machines for chemical industry, woodworking, metalworking, production of concrete and bitumen and for agricultural purposes, machine tools, and

parts thereof; motors, other than for land vehicles; hydraulic and pneumatic drives for machines; cranes for machines and motors; generators; blowers (machines); presses (machines); compressors (machines); condensers included in this class; lifts and cranes; pumps (machines); construction machinery.

9 – Scientific apparatus and instruments; optical, weighing, measuring, signalling, checking (supervision) and life-saving apparatus and instruments; apparatus and instruments for conducting, switching, transforming, accumulating, regulating and controlling electricity; data processing equipment and computers; fire-extinguishing apparatus; magnetic data carriers; alarms; electronic controls; computer operating programs (recorded); magnetic and optical data carriers; protection devices for personal use against accidents.

11 – Lighting, heating, steam generating, cooking, cooling, drying, ventilation and water supply apparatus and installations; sanitary apparatus and installations; purification installations for sewage; watering machines for agricultural purposes; desalination plants; ionisation apparatus for the treatment of air; water purification installations.

19 – Non-metallic building materials; buildings and transportable buildings (non-metallic); asphalt; pitch; bitumen; non-metallic rigid pipes for building; road-building materials and road-surfacing materials; monuments, not of metal; non-metallic linings for buildings; roofs and roof coverings, not of metal; docks, not of metal, included in this class; scaffolding, not of metal; materials for road marking, included in this class; non-metallic crash barriers for roads.

35 – Advertising; business management; business administration; office functions; business project management services for construction projects; business organisation consultancy; business organisation project management; rental of office equipment, provision of office staff; layout services for advertising purposes; conducting and organisation of trade fairs; compilation of information into computer databases; professional business consultancy.

36 – Rental of office space; insurance; financial affairs; monetary affairs; real estate affairs; financial preparation of building projects, namely project financing in the field of building construction; facility management, namely the management of buildings of all kinds; rental of offices (real estate); real estate management; brokerage; vehicle fleet management services, namely vehicle financing.

37 – Construction; repair of construction machines and construction equipment, water vehicles, process technology installations for building services and environmental technology; installation services; construction information; building construction super-

vision; building services, namely the implementation of construction projects; demolition of buildings; interior and exterior cleaning of buildings; rental of construction equipment; maintenance, repair and cleaning of buildings (caretaking); installation, maintenance and repair of computer hardware; domestic repair and cleaning services (caretaking); vehicle fleet management services, namely vehicle repair, cleaning and maintenance.

39 – Transport; packaging and storage of goods; waste and rubbish disposal, namely transport and dumping of waste; vehicle fleet management services, namely transport of vehicles, vehicle towing, chauffeur services; vehicle rental.

40 – Treatment of materials; water treatment; recycling; sorting of waste and recyclable material; destruction of waste and trash; recycling of waste and trash, in particular treatment of building rubble and incineration of waste and rubbish in incineration installations; printing; production of energy; air freshening (air conditioning); air purification; rental of space heating apparatus.

42 – Structural and civil engineering; scientific and technological services and research and design relating thereto; industrial analysis and research; design and development of computer software; architecture; architectural consultation; consultancy in the field of computers; installation, duplication, updating, rental and maintenance of computer software; rental of computer hardware; engineering; calibration; consultancy in the field of energy saving; geological surveys; technical surveying; creating and maintaining web sites for others; construction drafting; land surveying; urban planning; research and development for others; administration of data stored on servers; architectural services, namely technical preparation of construction projects; technical design services for construction purposes.

(260) AM 2014 70661 A
(800) 1038944
(151) 2009 12 17
(891) 2012 08 07
(731) MUSTAFA TUNCER ABDULLAH SERVET TERZİLER
Izzettin Çalışlar Cad., Naci Kasim Sk. No: 7,
Bahçelievler, İstanbul, Turkey
(540)



(591) Black, white
(511)
44 – Medical services; beauty care services, veterinary and other animal related services; agricultural, horticultural and forestry services.

(260) AM 2014 70835 A
(800) 1146000
(151) 2012 12 03
(731) KRKA, tovarna zdravil, d.d., Novo mesto
Šmarješka cesta 6, SI-8501 Novo mesto,
Slovenia
(540)

ALSAMOD

(591) Black, white
(511)
5 – Pharmaceutical preparations.

(260) AM 2014 70853 A
(800) 1146052
(151) 2012 08 02
(731) CHONGQING HIJOY INDUSTRY GROUP
CO., LTD.
A070-1, A093-1 Konggang Industrial Park,
Yubei District, Chongqing, China
(540)



(591) Black, white
(511)
12 – Motorcycles; motors for motorcycles; motorcycles rims; motorcycles wheel axis holders; shock absorbers for motorcycles; saddles for motorcycles; motorcycles cell (Terms Too Vague in the opinion of the International Bureau – Rule 13(2)(b) of the Common Regulations); side cars; motorcycles chain bowl (Terms Too Vague in the opinion of the International Bureau – Rule 13(2)(b) of the Common Regulations); motorcycle petrol (gas) tanks; motorcycle rear carriers; motorcycle rear forks; motorcycle frames; direction signals for motorcycles; motorcycle rearview mirrors.

(260) AM 2014 70859 A
(800) 1146068
(151) 2012 10 26
(731) Abstragan Holding Limited
Intershore Suites Vernon House, Sicilian
Avenue, London WC1A 2QS, United
Kingdom
(540)

SEDALITE
СЕДАЛИТ

(591) Black, white

(511)
 5 – Pharmaceutical and veterinary preparations; sanitary preparations for medical purposes; dietetic substances adapted for medical use, food for babies; plasters, materials for dressings; material for stopping teeth, dental wax; disinfectants; preparations for destroying vermin; fungicides, herbicides; foods and beverages which are adapted for medical purposes; air deodorising preparations.

(260) AM 2014 70883 A
 (800) 1146419
 (151) 2012 09 17
 (731) INTEGER.PL SPÓŁKA AKCYJNA
 ul. Malborska 130, PL-30-624 Kraków,
 Poland
 (540)

easyPack 24/7

(591) Black, white
 (511)
 6 – Chests of metal; metal containers for sorting, storage and delivery of shipments and parcels.
 9 – Electronic systems for announcements.
 35 – Distribution of advertising materials; dissemination of advertising matter; rental of advertising space; publication of publicity texts.
 39 – Shipping of goods; packing of goods; storage of goods; delivery of goods; courier services; postal services-parcels delivery; delivery of goods by mail order; transportation information; storage information.

(260) AM 2014 70884 A
 (800) 1146423
 (151) 2012 11 07
 (731) BSH Bosch und Siemens Hausgeräte GmbH
 Carl-Wery-Str. 34, 81739 München, Germany
 (540)

TouchSelect

(591) Black, white
 (511)
 11 – Apparatus for heating, steam generating and cooking, in particular stoves, baking, roasting, grilling, toasting, defrosting and heating devices, water heaters, immersion heaters, slow-cookers, microwave ovens, waffle irons (electric), egg-boilers, deep-fat fryers (electric); electrical tea and coffee makers, espresso coffee machines, automatic coffee machines (included in this class); refrigerating apparatus, in particular refrigerators, chest freezers, refrigerated cabinets, beverage-cooling apparatus, fridge-freezers, freezers, ice machines and apparatus; drying apparatus, in particular including tumble dryers, laundry drying machines, hand dryers, hair dryers;

infrared lamps (other than for medical use); heating pads (not for medical purposes), electric blankets (not for medical purposes); ventilating apparatus, in particular fans, extractor hood filters, extractor hood equipment and covers for extractor hoods, air-conditioning apparatus and devices for improving air quality, air humidifiers, air deodorisers, fragrance dispensing apparatus (not for personal use); air purifying apparatus, apparatus for water supply and sanitary purposes, in particular including fittings for steam, air and water supply installations; water heaters, storage water heaters and instantaneous water heaters; kitchen sinks; heat pumps; parts for all the aforesaid goods, included in this class; mechanical taps (dispensers) for dispensing chilled beverages for use in combination with apparatus for chilling beverages (other than vending machines).

(260) AM 2014 70887 A
 (800) 1146463
 (151) 2012 10 25
 (731) GSH Trademarks Limited
 Afroditis, 25 2nd floor, office 204, Nicosia,
 Cyprus
 (540)



(591) Black, white
 (511)
 33 – Vodka.

(260) AM 2014 70889 A
 (800) 1146487
 (151) 2012 12 12
 (731) Publichne aktsionerne tovarystvo
 "Kharkivska biskvitna fabryka"
 vul. Lozivska, 8, Kharkiv 61017, Ukraine
 (540)



(591) Black, white
 (511)
 30 – Cookies, pastries.

(260) AM 2014 70891 A
 (800) 1146547
 (151) 2012 11 15
 (731) TMD Friction Services GmbH
 Schlebuscher Straße 99, 51381 Leverkusen,
 Germany
 (540)

MINTEX

(591) Black, white
 (511)
 1 – Brake fluid, hydraulic fluid for brakes and clutch systems.
 4 – Greases, lubricating graphite, oils for industrial purposes, lubricating oils, industrial oils, permanent lubricant for brake systems.
 12 – Brake pads, brake segments, brake discs, brake drums, accessories for vehicles, all the aforesaid goods for land vehicles.

(260) AM 2014 70892 A
 (800) 1146566
 (151) 2012 07 25
 (731) Limited Liability Company
 "Fabrica Universalnykh Pokrytiy"
 2, Uglovoy pereulok, office 1011, RU-127055
 Moscow, Russian Federation
 (540)



(591) Black, red and white
 (511)
 2 – Anti-pollution paints; coatings [paints].
 6 – Duckboards of metal.
 19 – Asbestos cement; asphalt; concrete; bitumen; binding material for manufacture of bricks and brick

(stone) masonry; binding material for road repair; gravel; rubble; artificial stone; bituminous products for building; tar; road coating materials; materials for making and coating roads; building materials; pitch; refractory construction materials, not of metal; tiles for duckboards, not of metal; floor tiles, not of metal; paving slabs, not of metal; cement slabs; paving; asphalt paving; lighting slabs; macadam; fireproof cement coatings; road paving stone; grout; glass granules for road marking; clinker ballast.

(260) AM 2014 70974 A
 (800) 1147017
 (151) 2012 10 10
 (731) ECE HOLDING ANONİM ŞİRKETİ
 Organize Sanayi Bölgesi 5 Cadde, Çorum,
 Turkey
 (540)

İSVEA

(591) Black, white
 (511)
 11 – Sanitary apparatus and installations, sanitary ware (including bath tubs, shower trays, bidets, shower cubicles, urinals (sanitary fixtures), water closets, toilet seats, sinks, flushing apparatus, flushing tanks, cisterns, wash-hand basins, squatting pan closets, fittings and installation fixtures thereof, bath fittings, bath installations, bath plumbing fixtures, water taps, cocks (faucets), water flushing installations, shower nozzle, shower head.
 20 – Furniture (including bath and kitchen furniture).

(260) AM 2014 70981 A
 (800) 1147098
 (151) 2012 08 15
 (731) GLENDLANE HOLDING LIMITED
 Trident Center, 115 Griva Digeni, CY-3101
 Limassol, Cyprus
 (540)



НОВАЯ
ВОЛНА

(591) Black, white
 (511)
 14 – Agates; alarm clocks; alloys of precious metal; amulets [jewellery, jewelry (am.)]; anchors [clock and watch making]; atomic clocks; badges of precious metal; barrels [clock and watch making];

beads for making jewelry; boxes of precious metal; bracelets [jewellery, jewelry (am.)]; brooches [jewellery, jewelry (am.)]; busts of precious metal; cases for clock- and watchmaking; cases for watches [presentation]; chains [jewellery, jewelry (am.)]; watch chains; charms [jewellery, jewelry (am.)]; chronographs [watches]; chronometers; chronometrical instruments; chronoscopes; tie clips; clock cases; clock hands [clock and watch making]; clocks; clocks and watches, electric; clockworks; coins; control clocks [master clocks]; copper tokens; cuff links; dials [clock and watch making]; sun dials; diamonds; earrings; figurines [statuettes] of precious metal; gold thread [jewellery, jewelry (am.)]; gold, unwrought or beaten; hat ornaments of precious metal; ingots of precious metals; iridium; ivory [jewellery, jewelry (am.)]; ornaments of jet; jet, unwrought or semi-wrought; jewellery; jewellery cases [caskets]; jewellery of yellow amber; paste jewellery; jewelry; jewelry cases [caskets]; jewelry of yellow amber; paste jewelry [costume jewelry]; key rings [trinkets or fobs]; master clocks; medallions [jewellery, jewelry (am.)]; medals; movements for clocks and watches; necklaces [jewellery, jewelry (am.)]; olivine [gems]; ornamental pins; ornaments [jewellery, jewelry (am.)]; shoe ornaments of precious metal; osmium; palladium; ruthenium; semi-precious stones; silver thread; silver, unwrought or beaten; spinel [precious stones]; watch springs; spun silver [silver wire]; statues of precious metal; statuettes of precious metal; stopwatches; straps for wristwatches; sundials; threads of precious metal [jewellery, jewelry (am.)]; trinkets [jewellery, jewelry (am.)]; watch bands; watch cases; watch crystals; watch glasses; watch straps; watches; wire of precious metal [jewellery, jewelry (am.)]; works of art of precious metal; wristwatches; cloisonné jewellery [jewelry (Am.)]; precious metals, unwrought or semi-wrought; jewellery [costume jewelry (am.)]; pearls [jewellery, jewelry (am.)]; pearls made of ambroid [pressed amber]; pendulums [clock and watch making].

24 – Adhesive fabric for application by heat; banners; bath linen, except clothing; bed blankets; bed clothes; bed covers; bed covers of paper; bed linen; bedspreads; billiard cloth; bolting cloth; brocades; buckram; bunting; calico; printed calico cloth; canvas for tapestry or embroidery; cheese cloth; chenille fabric; cheviots [cloth]; cloth; coasters [table linen]; cotton fabrics; furniture coverings of textile; coverings of plastic for furniture; coverlets [bedspreads]; fitted toilet lid covers of fabric; covers for cushions; covers [loose] for furniture; crepe [fabric]; crepon; curtain holders of textile material; curtains of textile or plastic; damask; diapered linen; dimity; door curtains; drugget; eiderdowns [down coverlets]; elastic woven material; traced cloth for embroidery; esparto fabric; fabric; fabric for footwear; fabric, impervious to gases, for aeronautical balloons; fabric of imi-

tation animal skins; fabrics for textile use; face towels of textile; felt; fiberglass fabrics, for textile use; fiberglass fabrics for textile use; filtering materials of textile; flags, not of paper; flannel [fabric]; sanitary flannel; frieze [cloth]; furniture coverings of plastic; loose covers for furniture; fustian; gauze [cloth]; glass cloths [towels]; gummed cloth, other than for stationery; haircloth [sackcloth]; handkerchiefs of textile; hat linings, of textile, in the piece; hemp cloth; hemp fabric; household linen; jersey [fabric]; jute fabric; knitted fabric; labels of cloth; linen cloth; lingerie fabric; lining fabric for shoes; linings [textile]; napkins for removing make-up [cloth]; marabouts [cloth]; textile material; place mats, not of paper; mattress covers; washing mitts; moleskin [fabric]; mosquito nets; napkins, of cloth, for removing make-up; table napkins of textile; net curtains; non-woven textile fabrics; oilcloth for use as tablecloths; pillow shams; pillowcases; plastic material [substitute for fabrics]; printers' blankets of textile; quilts; ramie fabric; rayon fabric; travelling rugs [lap robes]; table runners; serviettes of textile; sheets [textile]; shower curtains of textile or plastic; shrouds; silk [cloth]; silk fabrics for printing patterns; sleeping bags [sheeting]; table linen, not of paper; tablecloths, not of paper; tablemats, not of paper; taffeta [cloth]; tapestry [wall hangings], of textile; tick [linen]; ticks [mattress covers]; tissues of textile for removing make-up; towels of textile; traced cloths for embroidery; trellis [cloth]; tulle; upholstery fabrics; velvet; wall hangings of textile; woollen cloth; woollen fabric; zephyr [cloth].

28 – Air pistols [toys]; amusement machines, automatic and coin-operated; arcade video game machines; archery implements; ascenders [mountaineering equipment]; backgammon games; bags especially designed for skis and surfboards; artificial fishing bait; play balloons; balls for games; bar-bells; baseball gloves; bats for games; batting gloves [accessories for games]; bells for christmas trees; weight lifting belts [sports articles]; stationary exercise bicycles; billiard balls; billiard cue tips; billiard cues; billiard markers; billiard table cushions; billiard tables; coin-operated billiard tables; bingo cards; bite indicators [fishing tackle]; bite sensors [fishing tackle]; bladders of balls for games; building blocks [toys]; board games; bob-sleighs; body boards; body-building apparatus; body-training apparatus; explosive bonbons [christmas crackers]; skating boots with skates attached; bowling apparatus and machinery; bows for archery; boxing gloves; building games; butterfly nets; camouflage screens [sports articles]; candle holders for christmas trees; caps for pistols [toys]; playing cards; chalk for billiard cues; checkerboards; checkers [games]; chess games; chessboards; chest expanders [exercisers]; chips for gambling; christmas tree stands; christmas trees of synthetic material; ornaments for christmas trees, except illumination articles and con-

fectionery; clay pigeon traps; clay pigeons [targets]; climbers' harness; golf clubs; confetti; conjuring apparatus; cosaques [toy fireworks]; counters [discs] for games; sole coverings for skis; creels [fishing traps]; cricket bags; cups for dice; darts; decoys for hunting or fishing; detonating caps [toys]; dice; discuses for sports; divot repair tools [golf accessories]; dolls; dolls' beds; dolls' clothes; dolls' feeding bottles; dolls' houses; dolls' rooms; dominoes; draughtboards; draughts [games]; dumb-bells; edges of skis; elbow guards [sports articles]; electronic targets; rollers for stationary exercise bicycles; exercisers [expanders]; fairground ride apparatus; fencing gauntlets; fencing masks; fencing weapons; fish hooks; fishing tackle; flippers for swimming; floats for bathing and swimming; floats for fishing; flying discs [toys]; tables for indoor football; hunting game calls; games; apparatus for games; marbles for games; gaming machines for gambling; fencing gloves; gloves for games; golf gloves; golf bags, with or without wheels; harpoon guns [sports articles]; paintball guns [sports apparatus]; gut for fishing; gut for rackets; appliances for gymnastics; hang gliders; harness for sailboards; hockey sticks; horseshoe games; ice skates; in-line roller skates; jigsaw puzzles; practical jokes [novelties]; kaleidoscopes; kite reels; kites; knee guards [sports articles]; landing nets for anglers; lines for fishing; lures for hunting or fishing; scent lures for hunting or fishing; mah-jong; marionettes; theatrical masks; toy masks; masts for sailboards; men's athletic supporters [sports articles]; mobiles [toys]; scale model vehicles; nets for sports; ninepins; novelties for parties, dances [party favors, favours]; pachinkos; protective paddings [parts of sports suits]; paintballs [ammunition for paintball guns] [sports apparatus]; paper party hats; paragliders; parlor games; parlour games; percussion caps [toys]; machines for physical exercises; pinatas; toy pistols; pitch mark repair tools [golf accessories]; playing balls; plush toys; poles for pole vaulting; swimming pools [play articles]; portable games with liquid crystal displays; punching bags; puppets; quoits; rackets; guts for rackets; strings for rackets; radio-controlled toy vehicles; rattles [playthings]; reels for fishing; ring games; rocking horses; rods for fishing; roller skates; rosin used by athletes; roulette wheels; sailboards; scale model kits [toys]; scooters [toys]; scrapers for skis; scratch cards for playing lottery games; seal skins [coverings for skis]; shin guards [sports articles]; shuttlecocks; skateboards; ski bindings; skis; wax for skis; skittles; skittles [games]; sleighs [sports articles]; slides [playthings]; sling shots [sports articles]; slot machines [gaming machines]; artificial snow for christmas trees; snow globes; snowboards; snowshoes; soap bubbles [toys]; spinning tops [toys]; spring boards [sports articles]; starting blocks for sports; stuffed toys; surfboards; surf skis; surfboard leashes; swimming belts; swim-

ming jackets; swimming kick boards; swimming webs [flippers]; swings; tables for table tennis; targets; teddy bears; tennis ball throwing apparatus; tennis nets; toy vehicles; toys; toys for domestic pets; trampolines; twirling batons; video game machines; water wings; waterskis; body rehabilitation apparatus.

30 – Allspice; almond confectionery; almond paste; aniseed; aromatic preparations for food; artificial coffee; baking powder; baking soda [bicarbonate of soda for cooking purposes]; crushed barley; husked barley; barley meal; bean meal; bee glue; beer vinegar; chocolate-based beverages; cocoa-based beverages; coffee-based beverages; flavorings [flavourings], other than essential oils, for beverages; tea-based beverages; bicarbonate of soda for cooking purposes [baking soda]; binding agents for ice cream [edible ices]; biscuits; bread; ginger bread; bread rolls; breadcrumbs; buns; cake paste; cake powder; cakes; flavorings [flavourings], other than essential oils, for cakes; rice cakes; candy; capers; caramels [candy]; celery salt; cereal preparations; cereal-based snack food; cheeseburgers [sandwiches]; chewing gum; chicory [coffee substitute]; chips [cereal products]; chocolate; chocolate beverages with milk; chow-chow [condiment]; confectionery for decorating christmas trees; chutneys [condiments]; cinnamon [spice]; cloves [spice]; cocoa; cocoa beverages with milk; cocoa products; coffee; coffee beverages with milk; coffee flavorings [flavourings]; vegetal preparations for use as coffee substitutes; unroasted coffee; condiments; confectionery; cookies; cooking salt; corn flakes; corn flour; corn meal; corn, milled; pop corn; corn, roasted; fruit coulis [sauces]; couscous [semolina]; crackers; ice cream; cream of tartar for cooking purposes; cream of tartar for culinary purposes; curry [spice]; custard; dressings for salad; edible ices; essences for foodstuffs, except etheric essences and essential oils; farinaceous food pastes; farinaceous foods; ferments for pastes; maize flakes; oat flakes; flavorings, other than essential oils; flaxseed for human consumption; flour; flour-milling products; fondants [confectionery]; cake frosting [icing]; frozen yoghurt [confectionery ices]; frozen yogurt [confectionery ices]; fruit jellies [confectionery]; garden herbs, preserved [seasonings]; ginger [spice]; gingerbread; glucose for culinary purposes; gluten additives for culinary purposes; gluten prepared as foodstuff; golden syrup; meat gravies; groats for human food; gruel, with a milk base, for food; halvah; ham glaze; high-protein cereal bars; hominy; hominy grits; honey; husked oats; binding agents for ice cream; ice for refreshment; ice, natural or artificial; iced tea; binding agents for edible ices; powder for edible ices; infusions, not medicinal; ketchup [sauce]; leaven; linseed for human consumption; liquorice [confectionery]; lozenges [confectionery]; macaroni; macaroons [pastry]; maize flour; maize meal; maize, milled; maize, roasted;

malt biscuits; malt extract for food; malt for human consumption; maltose; marinades; marzipan; mayonnaise; meat pies; meat tenderizers, for household purposes; mint for confectionery; molasses for food; chocolate mousses; dessert mousses [confectionery]; muesli; mustard; mustard meal; noodle-based prepared meals; noodles; nutmegs; oat-based food; oatmeal; crushed oats; pancakes; pasta; soya bean paste [condiment]; pasties; pastilles [confectionery]; pastries; pastry; peanut confectionery; pepper; peppermint sweets; peppers [seasonings]; pesto [sauce]; petit-beurre biscuits; petits fours [cakes]; pies; pizzas; popcorn; potato flour for food; powders for ice cream; pralines; propolis; puddings; quiches; ravioli; relish [condiment]; ribbon vermicelli; rice; rice-based snack food; royal jelly; rusks; saffron [seasoning]; sago; salt for preserving foodstuffs; sandwiches; tomato sauce; sauces [condiments]; sausage binding materials; sea water for cooking; seasonings; semolina; sherbets [ices]; sorbets [ices]; soya flour; soya sauce; spaghetti; spices; spring rolls; star aniseed; starch for food; stick liquorice [confectionery]; preparations for stiffening whipped cream; sugar; sugar confectionery; sushi; natural sweeteners; sweetmeats [candy]; tabbouleh; tacos; tapioca; tapioca flour for food; tarts; tea; thickening agents for cooking foodstuffs; tortillas; turmeric for food; unleavened bread; vanilla [flavoring] [flavouring]; vanillin [vanilla substitute]; vermicelli [noodles]; vinegar; waffles; weeds [condiment]; wheat flour; wheat germ for human consumption; yeast; meal.

- (260) AM 2014 70982 A
 (800) 1147099
 (151) 2012 08 15
 (731) GLENDLANE HOLDING LIMITED
 Trident Center, 115 Griva Digeni, CY-3101
 Limassol, Cyprus
 (540)



- (591) Black, white
 (511)
 14 – Agates; alarm clocks; alloys of precious metal; amulets [jewellery, jewelry (am.)]; anchors [clock and watch making]; atomic clocks; badges of precious metal; barrels [clock and watch making]; beads for making jewelry; boxes of precious metal; bracelets [jewellery, jewelry (am.)]; brooches [je-

wellery, jewelry (am.)]; busts of precious metal; cases for clock- and watchmaking; cases for watches [presentation]; chains [jewellery, jewelry (am.)]; watch chains; charms [jewellery, jewelry (am.)]; chronographs [watches]; chronometers; chronometrical instruments; chronoscopes; tie clips; clock cases; clock hands [clock and watch making]; clocks; clocks and watches, electric; clockworks; coins; control clocks [master clocks]; copper tokens; cuff links; dials [clock and watch making]; sun dials; diamonds; earrings; figurines [statuettes] of precious metal; gold thread [jewellery, jewelry (am.)]; gold, unwrought or beaten; hat ornaments of precious metal; ingots of precious metals; iridium; ivory [jewellery, jewelry (am.)]; ornaments of jet; jet, unwrought or semi-wrought; jewellery; jewellery cases [caskets]; jewellery of yellow amber; paste jewellery; jewelry; jewelry cases [caskets]; jewelry of yellow amber; paste jewelry [costume jewelry]; key rings [trinkets or fobs]; master clocks; medallions [jewellery, jewelry (am.)]; medals; movements for clocks and watches; necklaces [jewellery, jewelry (am.)]; olivine [gems]; ornamental pins; ornaments [jewellery, jewelry (am.)]; shoe ornaments of precious metal; osmium; palladium; paste jewellery [costume jewelry (am.)]; pearls [jewellery, jewelry (am.)]; pearls made of ambroid [pressed amber]; pendulums [clock and watch making]; pins [jewellery, jewelry (am.)]; tie pins; platinum [metal]; precious stones; rhodium; rings [jewellery, jewelry (am.)]; ruthenium; semi-precious stones; silver thread; silver, unwrought or beaten; spinel [precious stones]; watch springs; spun silver [silver wire]; statues of precious metal; statuettes of precious metal; stopwatches; straps for wristwatches; sundials; threads of precious metal [jewellery, jewelry (am.)]; trinkets [jewellery, jewelry (am.)]; watch bands; watch cases; watch crystals; watch glasses; watch straps; watches; wire of precious metal [jewellery, jewelry (am.)]; works of art of precious metal; wristwatches; cloisonné jewellery [jewelry (Am.)]; precious metals, unwrought or semi-wrought.

24 – Adhesive fabric for application by heat; banners; bath linen, except clothing; bed blankets; bed clothes; bed covers; bed covers of paper; bed linen; bedspreads; billiard cloth; bolting cloth; brocades; buckram; bunting; calico; printed calico cloth; canvas for tapestry or embroidery; cheese cloth; chenille fabric; cheviots [cloth]; cloth; coasters [table linen]; cotton fabrics; furniture coverings of textile; coverings of plastic for furniture; coverlets [bedspreads]; fitted toilet lid covers of fabric; covers for cushions; covers [loose] for furniture; crepe [fabric]; crepon; curtain holders of textile material; curtains of textile or plastic; damask; diapered linen; dimity; door curtains; drugget; eiderdowns [down coverlets]; elastic woven material; traced cloth for embroidery; esparto fabric; fabric; fabric for footwear; fabric, impervious

to gases, for aeronautical balloons; fabric of imitation animal skins; fabrics for textile use; face towels of textile; felt; fiberglass fabrics, for textile use; fibreglass fabrics for textile use; filtering materials of textile; flags, not of paper; flannel [fabric]; sanitary flannel; frieze [cloth]; furniture coverings of plastic; loose covers for furniture; fustian; gauze [cloth]; glass cloths [towels]; gummed cloth, other than for stationery; haircloth [sackcloth]; handkerchiefs of textile; hat linings, of textile, in the piece; hemp cloth; hemp fabric; household linen; jersey [fabric]; jute fabric; knitted fabric; labels of cloth; linen cloth; lingerie fabric; lining fabric for shoes; linings [textile]; napkins for removing make-up [cloth]; marabouts [cloth]; textile material; place mats, not of paper; mattress covers; washing mitts; moleskin [fabric]; mosquito nets; napkins, of cloth, for removing make-up; table napkins of textile; net curtains; non-woven textile fabrics; oilcloth for use as tablecloths; pillow shams; pillowcases; plastic material [substitute for fabrics]; printers' blankets of textile; quilts; ramie fabric; rayon fabric; travelling rugs [lap robes]; table runners; serviettes of textile; sheets [textile]; shower curtains of textile or plastic; shrouds; silk [cloth]; silk fabrics for printing patterns; sleeping bags [sheeting]; table linen, not of paper; tablecloths, not of paper; tablemats, not of paper; taffeta [cloth]; tapestry [wall hangings], of textile; tick [linen]; ticks [mattress covers]; tissues of textile for removing make-up; towels of textile; traced cloths for embroidery; trellis [cloth]; tulle; upholstery fabrics; velvet; wall hangings of textile; woollen cloth; woollen fabric; zephyr [cloth].

28 – Air pistols [toys]; amusement machines, automatic and coin-operated; arcade video game machines; archery implements; ascenders [mountaineering equipment]; backgammon games; bags especially designed for skis and surfboards; artificial fishing bait; play balloons; balls for games; bar-bells; baseball gloves; bats for games; batting gloves [accessories for games]; bells for christmas trees; weight lifting belts [sports articles]; stationary exercise bicycles; billiard balls; billiard cue tips; billiard cues; billiard markers; billiard table cushions; billiard tables; coin-operated billiard tables; bingo cards; bite indicators [fishing tackle]; bite sensors [fishing tackle]; bladders of balls for games; building blocks [toys]; board games; bob-sleighs; body boards; body-building apparatus; body-training apparatus; explosive bonbons [christmas crackers]; skating boots with skates attached; bowling apparatus and machinery; bows for archery; boxing gloves; building games; butterfly nets; camouflage screens [sports articles]; candle holders for christmas trees; caps for pistols [toys]; playing cards; chalk for billiard cues; checkerboards; checkers [games]; chess games; chessboards; chest expanders [exercisers]; chips for gambling; christmas tree stands; christmas trees of synthetic material; ornaments for christmas

trees, except illumination articles and confectionery; clay pigeon traps; clay pigeons [targets]; climbers' harness; golf clubs; confetti; conjuring apparatus; cozaques [toy fireworks]; counters [discs] for games; sole coverings for skis; creels [fishing traps]; cricket bags; cups for dice; darts; decoys for hunting or fishing; detonating caps [toys]; dice; discuses for sports; divot repair tools [golf accessories]; dolls; dolls' beds; dolls' clothes; dolls' feeding bottles; dolls' houses; dolls' rooms; dominoes; draughtboards; draughts [games]; dumb-bells; edges of skis; elbow guards [sports articles]; electronic targets; rollers for stationary exercise bicycles; exercisers [expanders]; fairground ride apparatus; fencing gauntlets; fencing masks; fencing weapons; fish hooks; fishing tackle; flippers for swimming; floats for bathing and swimming; floats for fishing; flying discs [toys]; tables for indoor football; hunting game calls; games; apparatus for games; marbles for games; gaming machines for gambling; fencing gloves; gloves for games; golf gloves; golf bags, with or without wheels; harpoon guns [sports articles]; paintball guns [sports apparatus]; gut for fishing; gut for rackets; appliances for gymnastics; hang gliders; harness for sailboards; hockey sticks; horseshoe games; ice skates; in-line roller skates; jigsaw puzzles; practical jokes [novelties]; kaleidoscopes; kite reels; kites; knee guards [sports articles]; landing nets for anglers; lines for fishing; lures for hunting or fishing; scent lures for hunting or fishing; mah-jong; marionettes; theatrical masks; toy masks; masts for sailboards; men's athletic supporters [sports articles]; mobiles [toys]; scale model vehicles; nets for sports; ninepins; novelties for parties, dances [party favors, favours]; pachinkos; protective paddings [parts of sports suits]; paintballs [ammunition for paintball guns] [sports apparatus]; paper party hats; paragliders; parlor games; parlour games; percussion caps [toys]; machines for physical exercises; pinatas; toy pistols; pitch mark repair tools [golf accessories]; playing balls; plush toys; poles for pole vaulting; swimming pools [play articles]; portable games with liquid crystal displays; punching bags; puppets; quoits; rackets; guts for rackets; strings for rackets; radio-controlled toy vehicles; rattles [playthings]; reels for fishing; ring games; rocking horses; rods for fishing; roller skates; rosin used by athletes; roulette wheels; sailboards; scale model kits [toys]; scooters [toys]; scrapers for skis; scratch cards for playing lottery games; seal skins [coverings for skis]; shin guards [sports articles]; shuttlecocks; skateboards; ski bindings; skis; wax for skis; skittles; skittles [games]; sleighs [sports articles]; slides [playthings]; sling shots [sports articles]; slot machines [gaming machines]; artificial snow for christmas trees; snow globes; snowboards; snowshoes; soap bubbles [toys]; spinning tops [toys]; spring boards [sports articles]; starting blocks for sports; stuffed toys; surfboards;

surf skis; surfboard leashes; swimming belts; swimming jackets; swimming kick boards; swimming webs [flippers]; swings; tables for table tennis; targets; teddy bears; tennis ball throwing apparatus; tennis nets; toy vehicles; toys; toys for domestic pets; trampolines; twirling batons; video game machines; water wings; waterskis; body rehabilitation apparatus.

30 – Allspice; almond confectionery; almond paste; aniseed; aromatic preparations for food; artificial coffee; baking powder; baking soda [bicarbonate of soda for cooking purposes]; crushed barley; husked barley; barley meal; bean meal; bee glue; beer vinegar; chocolate-based beverages; cocoa-based beverages; coffee-based beverages; flavorings [flavourings], other than essential oils, for beverages; tea-based beverages; bicarbonate of soda for cooking purposes [baking soda]; binding agents for ice cream [edible ices]; biscuits; bread; ginger bread; bread rolls; breadcrumbs; buns; cake paste; cake powder; cakes; flavorings [flavourings], other than essential oils, for cakes; rice cakes; candy; capers; caramels [candy]; celery salt; cereal preparations; cereal-based snack food; cheeseburgers [sandwiches]; chewing gum; chicory [coffee substitute]; chips [cereal products]; chocolate; chocolate beverages with milk; chow-chow [condiment]; confectionery for decorating Christmas trees; chutneys [condiments]; cinnamon [spice]; cloves [spice]; cocoa; cocoa beverages with milk; cocoa products; coffee; coffee beverages with milk; coffee flavorings [flavourings]; vegetal preparations for use as coffee substitutes; unroasted coffee; condiments; confectionery; cookies; cooking salt; corn flakes; corn flour; corn meal; corn, milled; pop corn; corn, roasted; fruit coulis [sauces]; couscous [semolina]; crackers; ice cream; cream of tartar for cooking purposes; cream of tartar for culinary purposes; curry [spice]; custard; dressings for salad; edible ices; essences for foodstuffs, except etheric essences and essential oils; farinaceous food pastes; farinaceous foods; ferments for pastes; maize flakes; oat flakes; flavorings, other than essential oils; flaxseed for human consumption; flour; flour-milling products; fondants [confectionery]; cake frosting [icing]; frozen yoghurt [confectionery ices]; frozen yogurt [confectionery ices]; fruit jellies [confectionery]; garden herbs, preserved [seasonings]; ginger [spice]; gingerbread; glucose for culinary purposes; gluten additives for culinary purposes; gluten prepared as foodstuff; golden syrup; meat gravies; groats for human food; gruel, with a milk base, for food; halvah; ham glaze; high-protein cereal bars; hominy; hominy grits; honey; husked oats; binding agents for ice cream; ice for refreshment; ice, natural or artificial; iced tea; binding agents for edible ices; powder for edible ices; infusions, not medicinal; ketchup [sauce]; leaven; linseed for human consumption; liquorice [confectionery]; lozenges [confectionery];

macaroni; macaroons [pastry]; maize flour; maize meal; maize, milled; maize, roasted; malt biscuits; malt extract for food; malt for human consumption; maltose; marinades; marzipan; mayonnaise; meat pies; meat tenderizers, for household purposes; mint for confectionery; molasses for food; chocolate mousses; dessert mousses [confectionery]; muesli; mustard; mustard meal; noodle-based prepared meals; noodles; nutmegs; oat-based food; oatmeal; crushed oats; pancakes; pasta; soya bean paste [condiment]; pasties; pastilles [confectionery]; pastries; pastry; peanut confectionery; pepper; peppermint sweets; peppers [seasonings]; pesto [sauce]; petit-beurre biscuits; petits fours [cakes]; pies; pizzas; popcorn; potato flour for food; powders for ice cream; pralines; propolis; puddings; quiches; ravioli; relish [condiment]; ribbon vermicelli; rice; rice-based snack food; royal jelly; rusks; saffron [seasoning]; sago; salt for preserving foodstuffs; sandwiches; tomato sauce; sauces [condiments]; sausage binding materials; sea water for cooking; seasonings; semolina; sherbets [ices]; sorbets [ices]; soya flour; soya sauce; spaghetti; spices; spring rolls; star aniseed; starch for food; stick liquorice [confectionery]; preparations for stiffening whipped cream; sugar; sugar confectionery; sushi; natural sweeteners; sweetmeats [candy]; tabbouleh; tacos; tapioca; tapioca flour for food; tarts; tea; thickening agents for cooking foodstuffs; tortillas; turmeric for food; unleavened bread; vanilla [flavoring] [flavouring]; vanillin [vanilla substitute]; vermicelli [noodles]; vinegar; waffles; weeds [condiment]; wheat flour; wheat germ for human consumption; yeast; meal.

(260) AM 2014 71046 A

(800) 1147504

(151) 2012 08 10

(731) ThyssenKrupp VDM GmbH

Plettenberger Strasse 2, 58791 Werdohl,
Germany

(540)

VDM

(591) Black, white

(511)

6 – Sheet metals, strips, ingots, poles, rods, rings, plates, foils, wires (not for electric purposes), soldering wires, round plates, blanks, punched, deep-drawn, rolled and bent parts, riveted and cold-formed parts, mill bars, slabs, blocks, tubes (weldless and welded), forged, continuous cast and cast parts, all goods made of base metals and metal alloys or made of stainless steels, especially special steels, especially containing nickel, chromium, iron, copper, zirconium, titanium, niobium, tantalum, manganese, cobalt, aluminium, magnesium, zinc, tin, molybdenum and the alloys thereof, in particular usable as components in gas and vapour turbines, as

boiler components, as building components in the construction of furnaces and power stations, in the chemical and petrochemical industry as well as in the field of nuclear energy technology, electronics, electrical engineering, offshore, in the automobile and aircraft industry, medical technique and architecture; crude and partially worked base metals and metal alloys; semi-finished products and metal goods, especially made of nickel, chromium, iron, copper, zirconium, titanium, cobalt, molybdenum, aluminium, magnesium, niobium, tantalum, manganese, zinc, tin, lead and the alloys thereof; semi-finished products made of brass; crude and partially worked nonferrous alloys in the form of blocks, slabs, plates, sheet metals, poles, rods, tubes (seamlessly welded), round plates, billets, disks, cast, drawn, rolled, pressed, forged; moulded metal parts, slide bearings; bronzes in the form of rods, tubes, strips and pressed pieces, parts made of bronze for highly stressed bearing bushes, tubes made of bronze for pipes; composite metals (in which the core metal and the coating metal are welded or soldered to each other); filler metals on the base of iron-chrome-nickel alloys; components as well as finished building parts made of metal and the alloys thereof for the electrolytic recovery of tin; billets made of base metals and the alloys thereof, especially nickel, chromium, cobalt, iron and the alloys thereof for electrical purposes.

9 – Calibrating resistors, measuring, precision and slide resistors; intermediate resistors for measuring instruments, shunt resistors for ammeters, starting resistors, bleeders, adjustment and control resistors, heating resistors; anodes, wires made of base metals and the alloys thereof, especially nickel, chromium, cobalt, iron and the alloys thereof for electrical purposes; electric heat conductors and resistors made of metallic materials in the form of wires, strips, foils and spirals; fuel cells and parts thereof, made of base metals, especially iron and chromium; semi-finished products made of magnetic materials, especially in the form of strips, sheet metals, foils, wires, poles, profiles.

(260) AM 2014 71047 A
(800) 1147506
(151) 2012 08 24
(731) EGIS GYÓGYSZERGYÁR Nyilvánosan
Működő Részvénytársaság
Keresztúri út 30-38, H-1106 Budapest,
Hungary

(540)

EGALIS

(591) Black, white

(511)

5 – Pharmaceutical preparations for human use, with the exception of medical and medicinal preparations for the treatment and/or prevention of sexual disorders.

(260) AM 2014 71050 A
(800) 1147737
(151) 2012 11 23
(731) Roam Technology, Besloten vennootschap
met beperkte aansprakelijkheid
Blindestraat 7, B-3740 Bilzen, Belgium
(540)

HUWA-SAN

(591) Black, white

(511)

1 – Chemicals used in industry, science and photography, as well as in agriculture, horticulture and forestry; unprocessed artificial resins, unprocessed plastics; soil fertilizers; fire extinguishing compositions; metal tempering and soldering preparations; chemical substances for preserving foodstuffs; tanning substances; adhesives for industrial purposes; chemical products for water treatment.

3 – Cleaning products with disinfectant properties; products for cosmetic use with disinfectant properties.

5 – Disinfectants; disinfectants for swimming pools; products with disinfectant properties for medical, pharmaceutical and veterinary use; disinfectants used in agriculture, horticulture and forestry.

(260) AM 2014 71051 A
(800) 202410
(151) 1957 08 07
(891) 2012 12 21
(731) Staatliches Hofbräuhaus in München
Hofbräu Allee 1, 81829 München, Germany
(540)

Hofbräuhaus München

(591) Black, white

(511)

32 – Beer.

(260) AM 2014 71052 A
(800) 213173
(151) 1958 09 23
(891) 2012 12 06
(731) Gabor Shoes Aktiengesellschaft
Marienberger Strasse 31, 83024 Rosenheim,
Germany
(540)

GABOR

(591) Black, white

(511)

25 – Shoes.

(260) AM 2014 71193 A
 (800) 463168
 (151) 1981 07 07
 (891) 2013 01 08
 (731) Werzalit GmbH + Co. KG
 Gronauer Strasse 70, 71720 Oberstenfeld,
 Germany
 (540)

COLORPAN

(591) Black, white
 (511)
 19 – Moulded parts made of wood, moulded parts made of organic materials and of a blend of inorganic and organic materials; components of prefabricated walls for the building industry, covering materials for ceilings and walls, washboards, window frames, supports and mouldings for windows, cases of doors and windows, door leafs, building components for claddings for garage doors, balconies, walls and ceilings, construction parts placed inside separation walls, components of clerestory intermediate ceilings; construction parts for coating radiators and convectors, construction parts for sealing and covering roofs, all the above made of wood, organic materials and blend of inorganic and organic materials; excluding glass intended for windowpane and looking glasses.

(260) AM 2014 71194 A
 (800) 510383
 (151) 1987 02 20
 (891) 2012 07 30
 (731) Skincode AG
 Seestrasse 59, CH-8703 Erlenbach,
 Switzerland
 (540)

SKINCODE

(591) Black, white
 (511)
 3 – Soaps, perfumery; essential oils, cosmetics, hair lotions.

(260) AM 2014 71195 A
 (800) 798631
 (151) 2002 12 17
 (891) 2012 12 18
 (731) Toruńskie Zakłady Materiałów
 Opatrunkowych Spółka Akcyjna
 ul. Żółkiewskiego 20/26, PL-87-100 Toruń,
 Poland
 (540)

plastopore

(591) Black, white
 (511)
 5 – Sticking plasters.

(260) AM 2014 71196 A
 (800) 909347
 (151) 2006 05 09
 (891) 2012 10 31
 (731) KAPLAN GIYIM SAN. VE TIC. LTD. STI.
 Mesrutiyet Mah. Haci Mansur, Sok.
 No. 96-98-100, Sisli/Istanbul, Turkey
 (540)

PIENA

(591) Black, white
 (511)
 25 – Clothing, underclothing and outer clothing; jerseys; knitwear; clothing of jean; clothing of leather, clothing for gymnastics, bathrobes and beach clothes, underwear, vests, underpants, brassieres, petticoats, camisoles, flannels, bodices, bustiers, corsets, morning gowns, night-gowns, overcoats, mantillas, coats, frocks, waterproof clothing, trench coats, jackets, trousers, skirts, dresses, waistcoats, shirts, T-shirts, pullovers, cardigans, sweaters, blouses, shorts, bermuda shorts, smocks, overalls, school suits, working clothes, socks, footwear; shoes, boots, slippers, galoshes and accessories thereof, sports shoes and tips for sports shoes, accessories for shoes i.e. soles, heelpieces for shoes, uppers, holsters; headgear: hoods, caps, hats, berets, babies' special clothing included in this class; babies' diapers of textile, babies' pants, undershirts, triangular diapers, diapers of textiles, nylon underpants; accessories: suspenders, dress parts, sarongs, collars, collar protectors, bandanas, garters, belts, neckties, bowties, scarves, muffs, gloves, shawls, cuffs, headbands, veils, wristbands; ready made linings (parts of clothing).

35 – Grouping for third parties of the goods listed in the above class (excluding their transport) to enable consumers to examine and buy them conveniently; marketing; sales assistance, consulting in sales and purchasing (included in this class), market research and market analysis; enterprise, organisation, human resources and business management consulting; advertising, shop window dressing; provision of information and know-how in the field of sales and business matters, particularly for trading in foodstuffs; accounting, brokering and concluding business deals, brokerage of contracts for the acquisition and sale of commodities; distribution of samples for advertising purposes; collection of data in data banks; acceptance of orders, ordering and delivery of goods and issuing of invoices, also for electronic commerce purposes.

(260) AM 2014 71199 A
 (800) 1138843
 (151) 2012 08 10
 (731) PepsiCo, Inc.
 700 Anderson Hill Road, Purchase,
 New York 10577, USA
 (540)



(591) White, black and red
 (511)
 30 – Coffee, tea, cocoa and artificial coffee; rice; tapioca and sago; flour and preparations made from cereals; bread, pastry and confectionery; ices; sugar, honey, treacle; yeast, baking-powder; salt; mustard; vinegar, sauces (condiments); spices; ice.

(260) AM 2014 71200 A
 (800) 1148897
 (151) 2012 12 12
 (731) Zhejiang Tugong Instrument Co., Ltd
 Daoxu Industrial Park, Shangyu, Zhejiang,
 China
 (540)



(591) Black, white
 (511)
 9 – Gauges; measuring instruments; material testing instruments and machines; apparatus and instruments for physics; furnaces for laboratory use; precision measuring apparatus; geological survey analytical instrument; teaching apparatus; furnaces for laboratory use; measuring apparatus and instruments for physical and chemical testing and composition analysis.

(260) AM 2014 71201 A
 (800) 1148903
 (151) 2012 09 19
 (731) Spey Medical Limited
 Lynton House, 7-12 Tavistock Square,
 London WC1H 9LT, United Kingdom
 (540)

BELANJ
БЕЛАНДЖ

(591) Black, white
 (511)
 5 – Pharmaceutical and veterinary preparations; sanitary preparations for medical purposes; dietetic

substances adapted for medical use, food for babies; plasters, materials for dressings; material for stopping teeth, dental wax; disinfectants; preparations for destroying vermin; fungicides, herbicides; food and beverages which are adapted for medical purposes; air deodorising preparations.

(260) AM 2014 71202 A
 (800) 1148909
 (151) 2012 10 26
 (731) Abstragan Holding Limited
 Intershore Suites Vernon House, Sicilian
 Avenue, London WC1A 2QS, United
 Kingdom
 (540)

TERAMIZIN
ТЕРАМИЗИН

(591) Black, white
 (511)
 5 – Pharmaceutical and veterinary preparations; sanitary preparations for medical purposes; dietetic substances adapted for medical use, food for babies; plasters, materials for dressings; material for stopping teeth, dental wax; disinfectants; preparations for destroying vermin; fungicides, herbicides; foods and beverages which are adapted for medical purposes; air deodorising preparations.

(260) AM 2014 71204 A
 (800) 1148915
 (151) 2012 08 26
 (731) YETIGEL INTERNATIONAL
 220 rue des Quatre Gendarmes d'Ouvéa,
 Z.I. Courtine, F-84000 AVIGNON, France
 (540)

YETI

(591) Black, white
 (511)
 29 – Fish; preserved, frozen, dry and cooked fruits and vegetables; jellies, jams, compotes; eggs, milk and dairy products; edible oils and fats; fats for food; butter; crustaceans (not live); canned fish; cheese; milk beverages, milk predominating; jellies, frozen fruit purées, jams, compotes which can be packed in standard packaging or individual flexible pouches standard or in the form of ready-to-eat lollipops.

30 – Coffee, tea, cocoa, sugar, rice, tapioca, sago, artificial coffee; flour and preparations made from cereals, bread, pastry and confectionery, edible ices; honey, treacle; yeast, baking-powder; salt, mustard; vinegar, sauces (condiments); spices; ice for refreshment; sandwiches, pizzas; pancakes; cookies; cakes; rusks; sugar confectionery; chocolate; beverages based on cocoa, coffee, chocolate or tea; con-

fectionery with water and syrup, or milk, or fruit, or with other ingredients in flexible packaging, marketed as a freezable liquid, or in solid or gelled form; edible ices, stick ice made with water and syrup, or milk, or fruit, or with other ingredients, these goods being deep-frozen; water-based ices, fruit ices, sorbets, milk ices, ice cream, frozen yoghurt, frozen confectioneries, frozen desserts, ice cubes and blocks of ice; preparations for the aforesaid goods, aromatic preparations for food, starch for food, natural sweeteners, unprocessed, natural or artificial ice.

32 – Beers; mineral and carbonated waters; fruit beverages and fruit juices; syrups and other preparations for making beverages; lemonades; fruit nectars; soda water; non-alcoholic aperitifs; beverages with water and syrup, or fruit, or with other ingredients, packaged in flexible bags having the form of a liquid marketed lollipop that the consumer freezes prior to consumption.

33 – Alcoholic beverages (except beers); ciders; digesters (liqueurs and spirits); wines; spirits; peppermint, orange and arbose liqueur.

(260) AM 2014 71205 A

(800) 1148917

(151) 2013 01 10

(731) Henkel AG & Co. KGaA

Henkelstr. 67, 40589 Düsseldorf, Germany

(540)

POWER-ACTIVE

(591) Black, white

(511)

3 – Bleaching preparations and other substances for laundry use, dishwashing and laundry detergents; cleaning, polishing, scouring and grinding preparations, preparations for cleaning metal, enamelled sheets and plates of metal, wood, cork, porcelain, ceramic, glass, plastic, leather and textiles; stain removing preparations; soap, not for personal use; perfumery goods, ethereal oils.

(260) AM 2014 71206 A

(800) 1148955

(151) 2012 08 29

(731) Tovarishchestvo s ogranichennoi
otvetstvennostyu "Effective Media Liaison"
ul. Begalina, d. 148/1A, 050000 g. Almaty,
Kazakstan

(540)



**TENGRI
NEWS**
актуальные новости
в любое время

(591) Green, white, grey and black

(511)

16 – Albums, almanacs, placards, posters, pamphlets, booklets, newspapers, printed publications, calendars, tear-off calendars, catalogues, periodicals, printed matter, prospectuses.

35 – Import-export agencies; opinion polling; marketing research; layout services for advertising purposes; updating of advertising material; presentation of goods on communication media, for retail purposes; sales promotion for others; rental of advertising time on communication media; publicity material rental; publication of publicity texts; radio advertising; dissemination of advertising matter; television advertising; on-line advertising; publicity columns preparation; news clipping services.

38 – Radio and television broadcasting, communications and telecommunications, transmission of radio and television programmes, information transfer; sending of texts, messages, information, sound and visual signal; transmission of radio and television programmes, texts, messages, information, sound and visual signal by communication and computer network; computer aided transmission of information, messages, texts, sound and visual signal, radio and television programmes; broadcasting of digital information by cable, wire and fiber optic networks; information, texts, messages, sound and visual signal, database electronic interchange; electronic mail, telex services, interactive transmission of video over digital networks; information and news agencies, message sending, communications by computer terminals, providing access to databases, providing user access to global computer networks; communication services for access to information, texts, sound and visual signal and database by communication and computer networks; telecommunications gateway services; transmission of information; providing access to a computer database; electronic transmission of information, messages, texts, sound and visual signal and data; on-line message sending services; providing on-line information and consulting services related to abovementioned services.

41 – Editorial and publishing services, providing on-line electronic publications (not downloadable), development and dissemination of educational materials of others, publication with the help of desktop publishing systems, interactive publication of books and periodicals, publication of texts, other than publicity texts, editing of texts, other than publicity texts, services of calligraphers; information services in the field of culture and sport; information on upbringing and education; recreation information; entertainment information; news reporting services; organizational services on cultural and educational work; organization and management of electronic conferences; organization of debates and on-line conversations (chats).

(260) AM 2014 71207 A
 (800) 1148960
 (151) 2012 08 29
 (731) Shtokman Development AG
 c/o Markus Schnurrenberger, Baarerstrasse 8,
 CH-6301 ZUG, Switzerland
 (540)



(591) White, green, orange, purple, blue, red and black

(511)
 1 – Chemicals for use in the construction, treating, servicing, completion and working of oil, gas, geothermal and water wells and cleaning of industrial facilities; industrial chemicals.

4 – Gas, oil gas, fuel gas, liquid gas, liquefied petroleum gas, compressed gas, electrical energy.

9 – Computer software for use in the fields of energy, chemicals, petroleum, petroleum products, exploration, engineering, solar power, retailing and design; measuring, signaling, checking (supervision) and analysis apparatus, gas testing instruments; gasometers; apparatus and instruments for conducting, distributing, accumulating, regulating or controlling gas energy.

37 – Gas drilling services; drilling of deep gas-wells; extraction of gas from gas fields; safe maintenance and repair of gas wells.

39 – Distribution of energy; storage of goods; distribution of gas; storage of gas; transport by gas pipeline.

40 – Refining and processing of dry gas, natural gas and natural gas liquids, gas well treatment, production and processing of fuels and of other sources of energy.

42 – Construction planning for the energy industry; engineering, in particular in the energy sector, including in the field of gas transport and gas application; technological consultancy in the fields of energy production and use; technical measuring services for pipe systems; surveying in the field of energy; technical development services in the energy sector, in particular gas transport technology and gas application technology development; consultancy and design of computer programs; computer software design; computer software consultancy; computer software maintenance; gas exploration services, geophysical exploration and searching of gas.

(260) AM 2014 71208 A
 (800) 1148961
 (151) 2012 09 04
 (731) Zakaraiya Goderzi Raminovich
 kv.48, 6/1, ul. 2-ya Pyatiletka, RU-350040 g.
 Krasnodar, Russian Federation
 (540)



(591) White, gray, black, green, light green, dark green, yellow, light yellow, dark yellow, brown, orange, red and dark red

(511)
 29 – Meat, fish, poultry and game; meat extracts; preserved, frozen, dried and cooked fruits and vegetables; jellies, jams, compotes; eggs; milk and milk products; edible oils and fats; ajvar [preserved peppers]; aloe vera prepared for human consumption; alginates for culinary purposes; anchovy; peanuts, processed; albumen for culinary purposes; white of eggs; beans, preserved; soya beans, preserved, for food; bouillon; ginger jam; ham; fatty substances for the manufacture of edible fats; toasted laver; edible birds' nests; peas, preserved; mushrooms, preserved; game, not live; gelatine; meat jellies; jellies for food; fruit jellies; yolk of eggs; coconut fat; bone oil, edible; lard for food; suet for food; edible fats; fruit-based snack food; charcuterie; raisins; caviar; processed fish spawn; yoghurt; sauerkraut; kefir [milk beverage]; isinglass for food; clams [not live]; milk shakes; black pudding; meat, tinned [canned (am.)]; vegetables, tinned [canned (am.)]; fish, tinned [canned (am.)]; fruits, tinned [canned (am.)]; bouillon concentrates; gherkins; shrimps, not live; prawns, not live; buttercream; croquettes; silkworm chrysalis, for human consumption; koumiss [kumiss] [milk beverage]; spiny lobsters, not live; lecithin for culinary purposes; salmon; onions, preserved; margarine; piccalilli; marmalade; edible oils; peanut butter; chocolate nut butter; colza oil for food; coconut butter; corn oil; sesame oil; flaxseed oil for culinary purposes; olive oil for food; palm oil for food; palm kernel oil for food; sunflower oil for food; coconut oil; butter; shellfish, not live; almonds, ground; animal marrow for food; mussels, not live; milk; albumin milk; soya milk [milk substitute]; fish meal for human consumption; vegetable mousses; fish mousses; fruit pulp; meat; meat, preserved; milk beverages, milk predominating; vegetables, preserved; vegetables, dried; vegetables, cooked; potato fritters; olives, preserved; lobsters, not live; coconut, desiccated; nuts, prepared; tomato purée; liver pâté; pectin for culinary purposes; liver; pickles; jams; powdered eggs; milk products; fermented vegetable foods [kimchi]; foods prepared from fish; curd; poultry, not live; pollen prepared as foodstuff; cranberry sauce [compote];

apple purée; crayfish, not live; crustaceans, not live; fish, preserved; fish, not live; salted fish; vegetable salads; fruit salads; bacon; sardines; pork; herrings; processed seeds; processed sunflower seeds; cream [dairy products]; whipped cream; fat-containing mixtures for bread slices; tomato juice for cooking; vegetable juices for cooking; salted meats; sausages; sausages in batter; preparations for making bouillon; preparations for making soup; tripe; soups; vegetable soup preparations; whey; cheese; tahini [sesame seed paste]; tofu; sea-cucumbers, not live; truffles, preserved; tuna fish; oysters, not live; milk ferments for culinary purposes; rennet; fish fillets; dates; crystallized fruits; frozen fruits; fruit, preserved; fruit preserved in alcohol; fruit, stewed; potato flakes; hummus [chickpea paste]; fruit peel; preserved garlic; lentils, preserved; potato chips; low-fat potato chips; fruit chips; non-alcoholic egg nog; weed extracts for food; snail eggs for consumption.

30 – Coffee, tea, cocoa and artificial coffee; rice; tapioca and sago; flour and preparations made from cereals; bread, pastry and confectionery; ices; sugar, honey, treacle; yeast, baking-powder; salt; mustard; vinegar, sauces (condiments); spices; ice; aromatic preparations for food; flavorings, other than essential oils, for cakes; flavorings, other than essential oils, for beverages; coffee flavorings [flavourings]; flavorings, other than essential oils; star aniseed; high-protein cereal bars; cookies; pancakes; noodle-based prepared meals; buns; bread rolls; vanillin [vanilla substitute]; vanilla [flavoring] [flavouring]; waffles; vermicelli [noodles]; natural sweeteners; sausage binding materials; binding agents for ice cream [edible ices]; sea water for cooking; weeds [condiment]; malt biscuits; cloves [spice]; cake frosting [icing]; glucose for culinary purposes; gluten additives for culinary purposes; yeast; thickening agents for cooking foodstuffs; leaven; rice-based snack food; cereal-based snack food; artificial coffee; vegetal preparations for use as coffee substitutes; dressings for salad; fruit jellies [confectionery]; confectionery for decorating christmas trees; cakes; pastries; peanut confectionery; almond confectionery; farinaceous food pastes; pasties; ginger [spice]; frozen yoghurt [confectionery ices]; cocoa; cocoa products; capers; caramels [candy]; curry [spice]; gruel, with a milk base, for food; ketchup [sauce]; quiches; gluten prepared as foodstuff; sweetmeats [candy]; liquorice [confectionery]; peppermint sweets; cinnamon [spice]; coffee; unroasted coffee; starch for food; crackers; custard; hominy grits; semolina; oatmeal; crushed barley; groats for human food; maize, milled; corn, roasted; meat pies; turmeric for food; couscous [semolina]; farinaceous foods; noodles; ice for refreshment; ice, natural or artificial; edible ices; candy; rice cakes; mayonnaise; macarons [pastry]; macaroni; maltose; hominy; marinades; marzipan; honey; royal jelly; ice cream; bean meal; wheat flour; soya flour; barley meal;

dessert mousses [confectionery]; chocolate mousses; muesli; mint for confectionery; cocoa beverages with milk; coffee beverages with milk; coffee-based beverages; tea-based beverages; chocolate beverages with milk; chocolate-based beverages; husked oats; nutmegs; stick liquorice [confectionery]; soya bean paste [condiment]; lozenges [confectionery]; molasses for food; pepper; allspice; peppers [seasonings]; pesto [sauce]; biscuits; petit-beurre biscuits; pies; pizzas; meat gravies; fondants [confectionery]; popcorn; powders for ice cream; baking powder; mustard meal; pralines; condiments; meat tenderizers, for household purposes; cereal preparations; flour-milling products; oat-based food; bee glue; gingerbread; petits fours [cakes]; puddings; cake powder; fruit coulis [sauces]; ravioli; chewing gum; relish [condiment]; wheat germ for human consumption; spring rolls; sago; sugar; aniseed; flaxseed for human consumption; golden syrup; cake paste; confectionery; baking soda [bicarbonate of soda for cooking purposes]; malt for human consumption; salt for preserving foodstuffs; cooking salt; celery salt; sherbets [ices]; ham glaze; soya sauce; tomato sauce; sauces [condiments]; spaghetti; seasonings; preparations for stiffening whipped cream; rusks; breadcrumbs; sushi; sandwiches; tabbouleh; tacos; tapioca; cream of tartar for culinary purposes; cream of tartar for cooking purposes; tarts; almond paste; tortillas; garden herbs, preserved [seasonings]; vinegar; beer vinegar; ferments for pastes; halvah; bread; unleavened bread; chips [cereal products]; corn flakes; oat flakes; chicory [coffee substitute]; tea; iced tea; chutneys [condiments]; cheeseburgers [sandwiches]; chow-chow [condiment]; saffron [seasoning]; chocolate; malt extract for food; essences for foodstuffs, except etheric essences and essential oils; husked barley.

35 – Advertising; business management; business administration; office functions; import-export agencies; commercial information agencies; efficiency experts; demonstration of goods; marketing studies; business information; commercial information and advice for consumers [consumer advice shop]; business investigations; marketing research; marketing; organization of exhibitions for commercial or advertising purposes; organization of trade fairs for commercial or advertising purposes; presentation of goods on communication media, for retail purposes; auctioneering; sales promotion for others; distribution of samples; on-line advertising on a computer network; commercial administration of the licensing of the goods and services of others; administrative processing of purchase orders; procurement services for others [purchasing goods and services for other businesses]; outsourcing services [business assistance].

(260) AM 2014 71209 A
 (800) 1148986
 (151) 2012 10 30
 (731) BASF SE
 Carl-Bosch-Strasse 38, 67063 Ludwigshafen
 am Rhein, Germany
 (540)

KERDYN

(591) Black, white
 (511)
 17 – Insulating materials, plastic substances, semi-processed.
 19 – Building materials (not of metal).

(260) AM 2014 71210 A
 (800) 1149024
 (151) 2012 12 25
 (731) GUANGDONG HOLATZ PLUMBING
 FITTINGS INDUSTRY CO., LTD
 No. 18 Tangliang Road, the 3rd Industrial
 Zone, Shuikou Town, Kaiping, 529321
 Guangdong, China
 (540)

ALISE

(591) Black, white
 (511)
 11 – Taps [faucets]; faucets for pipes (am.); pressure water tanks; floor drains; hot air bath fittings; bath tubs for sitz baths; water closets; toilet bowls; sauna bath installations.

(260) AM 2014 71211 A
 (800) 1149031
 (151) 2012 12 11
 (731) MERIAL
 29, avenue Tony Garnier, F-69007 LYON,
 France
 (540)

CONFIGARD

(591) Black, white
 (511)
 5 – Veterinary preparations; antiparasitic veterinary products.

(260) AM 2014 71213 A
 (800) 1149045
 (151) 2012 12 21
 (731) SOCAR Energy Holdings AG
 Uraniastrasse 40, CH-8001 Zürich,
 Switzerland
 (540)



(591) Blue, red and green
 (511)
 4 – Industrial oils and greases; lubricants; dust absorbing, wetting and binding compositions; fuels (including motor spirit) and illuminants; candles and wicks for lighting; non-chemical additives to motor fuel; alcohol used as fuel; benzene; benzol; combustible oils (fuel oil); diesel oil; fuel gas; lean gas; solidified gases; gasoline; kerosene; mazut; petrol (fuel); raw or refined petroleum.

35 – Advertising, wholesale and retail sale of Industrial oils and greases, lubricants, dust-absorbing, wetting and binding compositions, fuels [including motor spirit] and illuminants, candles and wicks for lighting, non-chemical additives for fuels, alcohol used as fuel, benzene, benzol, fuel oil, diesel oil, fuel gas, lean gas, solidified gases, gasoline, kerosene, heating oil, petrol [fuel], vehicle fuels, petroleum [crude or refined], food and beverages [alcoholic or not], car accessories, cigarettes, candy, cards, books, newspapers and magazines.

37 – Service stations; cleaning and washing of automobiles; vehicle lubrication [greasing]; recharging services for electric vehicles; battery recharging services; vehicle maintenance and repair; burner maintenance and repair.

39 – Transport, particularly transport of petroleum and gas; packaging and storage of goods, particularly of petroleum and gas; storage information; provision of parking spaces and areas.

40 – Treatment of materials; material treatment information; processing of petroleum; production of energy.

43 – Services for providing food and drink.

(260) AM 2014 71214 A
 (800) 1149055
 (151) 2012 12 17
 (731) Tovarystvo z obmezheniou vidpovidalnistiu
 "LIKERO-HORILCHANYI ZAVOD
 "PRAIM"
 vul. Olimpiiska, 1, smt. Malynivka,
 Chuhuiivskiyi r-n, Kharkivska obl. 63525,
 Ukraine;
 Tovaristvo z obmegenoyu vidpovidalnistyu
 "OLIMP"
 prosp. Miru, bud. 13, UA-83015 m. Donetsk,
 Ukraine;
 Klymez Pavlo Anatoliyovych
 vul. Kropyvnyzkogo, 10, kv. 21, Kyiv 01004,
 Ukraine

(540)

ПЛАКУЧАЯ ИВА

(591) Black, white
 (511)
 33 – Alcoholic beverages (except beers).

(260) AM 2014 71215 A
 (800) 1149064
 (151) 2012 12 11
 (731) MBG Holding GmbH
 Oberes Feld 13, 33106 Paderborn, Germany

(540)

FRUTINIO

(591) Black, white
 (511)
 32 – Beers; mineral and aerated waters and other
 non-alcoholic beverages; fruit beverages and fruit
 juices.
 33 – Alcoholic beverages (except beers).

(260) AM 2014 71216 A
 (800) 1149065
 (151) 2012 12 11
 (731) MBG Holding GmbH
 Oberes Feld 13, 33106 Paderborn, Germany

(540)

FRUTINIO

(591) Black, white
 (511)
 32 – Beers; mineral and aerated waters and other
 non-alcoholic drinks; fruit beverages and fruit juices.
 33 – Alcoholic beverages (except beers).

(260) AM 2014 71217 A
 (800) 1149076
 (151) 2012 12 15
 (731) Ulrich Bruhnke
 Lindenstraße 28, 71139 Ehingen, Germany

(540)

MnE21

(591) Black, white
 (511)
 6 – Magnesium based alloy.

(260) AM 2014 71218 A
 (800) 1149078
 (151) 2013 01 09
 (731) GRINDEKS, akciju sabiedrība
 Krustpils iela 53, LV-1057 Rīga, Latvia

(540)



(591) Black, white
 (511)
 5 – Pharmaceutical and veterinary preparations;
 sanitary preparations for medical purposes; dietetic
 food and substances adapted for medical or ve-
 terinary use, food for babies; dietary supplements for
 humans and animals; plasters, materials for dress-
 ings; material for stopping teeth, dental wax; disin-
 fectants; preparations for destroying vermin; fungi-
 cides, herbicides.

(260) AM 2014 71219 A
 (800) 1149101
 (151) 2012 11 12
 (731) Sovmestnoe obshchestvo s ogranichennoy
 otvetstvennostyuu "LEKPHARM"
 Komn. 301, d. 2A, ul. Minskaya, 223110
 g. Logoysk, Minskaya obl., Belarus

(540)



(591) Orange
 (511)
 5 – Pharmaceutical and veterinary preparations; sa-
 nitary preparations for medical purposes; dietetic
 substances adapted for medical use, food for babies;
 plasters, materials for dressings; teeth filling and
 dental impression materials; disinfectants; prepara-
 tions for destroying vermin; fungicides, herbicides;
 biologically active additives, including nutraceuti-
 cals, parapharmaceuticals.

(260) AM 2014 71226 A

(800) 1149141

(151) 2013 01 08

(731) Citodat Invest OÜ

Narva mnt 13a, EE-10151 Tallinn, Estonia

(540)

Контейнерный поезд "Зубр"

(591) Black, white

(511)

39 – Rental of storage containers; freight forwarding, brokering and logistic services relating to the transportation of freight and property by land, sea, air or rail.

(260) AM 2014 71227 A

(800) 1149150

(151) 2012 04 20

(731) BORUSAN MAKİNA VE GÜÇ
SİSTEMLERİ SANAYİ VE TİCARET
ANONİM ŞİRKETİ

Pürtelaş Hasan Mahallesi, Meclisi Mebusan
Caddesi No: 35-37, İstanbul, Turkey

(540)



(591) Orange, black and white

(511)

6 – Ores of metal, namely, zinc ores, nickel ores, iron ores, lead ores, manganese ores, chrome ores; common metals, unwrought and semi-worked, for further manufacture, namely, irons and steels, nickel, tin and its alloys, zinc based alloys, copper based alloys, iron alloys, lead-tin alloys, aluminium and its alloys; steel plates and sheets, cast iron for use in building; construction materials of metal; portable metal buildings, construction material of metal, metal floors, metal staircases, portable metal staircases, metal gates and fences, metal railings for fences, metal roofing, metal palings, prefabricated metal platforms, metal telephone booths, vendor booths made primarily of metal, transportable greenhouses of metal for household use, metal swimming pools, metal diving boards, metal silos, crash barriers of metal for roads, metal scaffolding, metal casting forms for concrete, metal posts, construction elements made of metal, namely, shores, supports; high pressure metal containers, general purpose metal storage containers, containers of metal for chemicals, compressed gases and liquids, metal containers for the storage and transportation of goods, metal barrels, vats of metal, flexible metal foils for use in the manufacture of pouches, bags and lids; metal tool boxes, metal mail boxes, metal shelf brackets; metal window screens, metal sieves being parts of drains; metallic doors, windows, shutters,

slatted shutters, metal jalousies, metal accessories of doors and windows, namely, door handles, window handles, metal panels for doors and windows, doors and windows closers and openers, non-electric, window latches of metal; non-electric cables, metal cable wire, metal rods for brazing and welding; metal hardware, namely, screws, nails, bolts, nuts, metal chains, pulley; door hardware, namely keys and key cylinders; metal hinges, rivets, non-electric metal door bells, metal bells, metal nameplates and door nameplates, door chains of metal, door and window handles of metal, fittings of metal for doors and windows, marine anchors, metal handles for tools, badges of metal for vehicles; ducts of metal for ventilating and air conditioning and heating installations, metal vent covers for HVAC ducts, metal drains for use in the construction of basement waterproofing system and pitch pans, metal chimneys, metal manhole covers for drains, poles of metal for electric power lines; boards of metal, namely, advertising boards, wall boards of metal; metal license plates, non-luminous and non-mechanical metal road signs, loading and unloading pallets of metal, metal name badges, metal name plates; metal pipes for liquid and gas transfer, metal pipe couplings and joints, metal pipe collars, metal junctions for pipes, metal pipe muffs, elbows of metal for pipes, metal valves other than parts of machines, metal taps for casks; (including valves of metal, drilling pipes of metal); metal cash boxes; materials of metal for railway construction, metal rails, metal railway crossovers; metal bollards, metal mooring buoys, metal structural supports therefor, used to support decking; metallic moulds for metal casting; works of art of common metal, sculptures made of non-precious metal, statuettes of non-precious metal, monuments of non-precious metal, busts of non-precious metal; metal bottle caps; poles of metal, for electric lines, telegraph poles of metal, metal fence posts; metal ropes, belts of metal, tow ropes of metal; automatic doors, automatic turnstiles.

7 – Machines, machine tools and industrial robots to process and give shape to wooden, metal, glass, plastic materials and mining machines and apparatus; construction machines, wooden working machines, metal working machines, glass working machines stone working machines; lifting, carrying and transmission machines including elevators, moving staircases and winches; machines and robots to process grain, fruit, vegetable and food; agricultural tools and machinery; engines and motors not for land vehicles, electrical motors, their parts and apparatus except for land vehicles; bearings, ball and rolling bearings; hydraulic jacks for wheel removing and mounting; alternators, generators, electricity generator, solar-powered electricity generators; machines for painting, automatic spray guns for paint, electric punching machines and guns, electric glue guns,

guns (tools using explosives) for compressed air and liquids, electric hand drills, hand saws (machines), electric air compressors, washing installations for vehicles; welding machines, namely, electric welding machines, electric point welding machines; printing machines and apparatus; packaging machines, bottling and capping machines, industrial printing machines, namely, labelers, classifiers; textile machines, sewing machines; pumps other than machine and motor parts; electrically operated kitchen machines used for chopping, grinding, crushing, trimming and crumbling; washing machines, dishwashers, floor polishing machines, carpet cleaning machines; electric vacuum cleaners and their parts; automatic vending machines, electric welding apparatus including welding electrodes; electric or electronic door opening and closing installations for buildings; apparatus and machines for electrolysis and galvanization.

9 – Apparatus and instruments used for measurement for scientific purposes and used in laboratory, apparatus for recording, transmission or reproduction of sound and images including data processing apparatus, communication devices, computer software and hardware; magnetic and optical data media and exposed camera films; antennas, satellite antennas, amplifiers and parts thereof; ticket automates, cash machines; electronic devices used in machines and devices, electronic semi-conductors, electronic integrated circuits, electronic chips; electric meters, water meters, gas meters, counters and timers used for measuring the consumption in a unit of time; protective clothing, life saving and protecting equipments; eyeglasses, sun glasses, lenses and their boxes, cases, parts and accessories; apparatus and instruments for transmitting, converting and storing electrical energy including cables and power supplies used in electric and electronic; electric door bells, alarms other than vehicle alarms; traffic signalization equipments; fire-extinguishing apparatus; radars, submarine radars (sonars), night vision providing and increasing devices and apparatus, namely, night vision goggles; remote controls for opening and closing vehicle doors; anodes, cathodes; magnets; decorative magnets.

11 – Lighting installations, lighting apparatus for vehicles, interior and exterior lights; lamps, light bulbs, projector lamps, lanterns, chandeliers, lamp glasses, lamp mantles, lamps for directional signals and parking lights of vehicles (bulbs), headlights, stop lights, light bulbs for signals and park lights, vehicle reflectors, reflector lamps; devices for heating and vapor producing installations, stoves (heating apparatus), boilers for central heating and natural gas installations, gas boilers, burners, heaters, heaters for baths, radiators, heat pumps, electric water boilers, solar collectors and devices (heating), heating apparatus for solid, liquid or gaseous fuels,

cookers; air-conditioning installations and apparatus, air blowing fans, ventilators, air-conditioning apparatus including for vehicles; air sterilisers and purifying devices, installations and their parts and accessories for residences; refrigerators, deep freezers, ice boxes, ice machines and devices; electric and gas operated apparatus, machines and equipment used in cooking and boiling, namely, toasters, bread toasters, deep fryers, grills, ovens, stoves, electric popcorn poppers, autoclaves, coffee and tea machines, water boilers (kettles) and their parts; clothes drying machines (electric, for household purposes) electric hair dryers, hand drying apparatus for washrooms; bath tubs, bidets, bath installations, shower enclosures, urinals (sanitary fixtures); water closets, toilets, portable; lavatories, sinks, thermostatic valves as parts of heating installations, level controlling valves in tanks, regulating accessories for water or gas apparatus, whirlpool-jet apparatus; automatic watering installations, water-pipes for sanitary installations, watering machines for agricultural purposes; water softening apparatus and installations, water purifying apparatus and machines, water purification installations, incinerators, water purifiers; bed warmers and blankets, electric, not for medical purposes; electric heating pads and cushions, not for medical purposes; electric foot warmers; foot muffs, electrically heated; hot water bottles; aquarium filters, filtration apparatus incorporating a motor device; aquarium heaters and lights; industrial type furnaces, industrial type dryer installations, industrial type cooling installations, cooling towers, air cooling apparatus; pasteurisers and sterilizers.

37 – Construction services, namely custom construction of residential and commercial communities, building construction and repair, building demolition, consultation relating to painting of buildings, underwater repair, underwater building and construction, road paving; providing information relating to the rental of construction equipment; rental of construction and building equipment, rental of earth moving equipment and excavators, rental of bulldozers, rental of excavators; cleaning of clothing, buildings, vehicles, cleaning of external surfaces of buildings, street sweeping services, chimney sweeping services, window cleaning services, rental of street cleaning machines, rental of cleaning equipment; rental of cleaning machines; disinfection of equipment and linen; vermin extermination services other than for agriculture; land vehicle repair and maintenance; repair or maintenance of vessels; aircraft repair and maintenance; upholstery services, upholstery repair services, furniture restoration, repair and maintenance; installation, repair and maintenance of heating equipment, repair or maintenance of air-conditioning apparatus for industrial purposes; clothing repair, mending clothing, cleaning of clothing services, leather cleaning and repair,

laundry services for cloth, clothing, fabric, linen, textiles washing of cloth, clothing, fabric, linen, textiles; repair or maintenance of movie projectors, repair or maintenance of photographic machines and apparatus, repair or maintenance of office machines and apparatus, installation and maintenance of burglar and/or fire alarms, repair or maintenance of elevators and lifts, artificial snow-making services; clock and watch repair or maintenance, wallpaper hanging; mining extraction, repair or maintenance of mining machines and apparatus, floor sanding services, knife sharpening services, safe maintenance or repair; umbrella repair services, shoe repair services.

39 – Land, air and sea transport of passengers; transport commission agency services in the nature of arranging excursions for tourists, freight commission agency services in the nature of freight brokerage, ship agency services in the nature of freight ship transport, ambulance transport services, private chauffeur services, airplane piloting services, tourist bureau services in the nature of tourist agency services and tour guide services, making reservations and bookings for transportation and travel and tour tickets, tour organization services, message and goods delivery by courier, distribution of goods by mail services, namely, cargo handling, shipping and delivery services, namely, pickup, transportation, and delivery of packages and letters by various modes of transportation, distribution services, namely, delivery of newspapers, package delivery services via airline transportation; rental of land, air and sea vehicles; parking lot services, garage space rental services; boat sheltering services in the nature of boat storage; pipeline transport services, namely, transmission of oil and gas through pipelines; electricity distribution services; water supply services; vehicle and goods rescue services; storage, packaging and crating of baggages; garbage storage and transport services, waste collection and transport services; rental of divers' decompression chambers.

(260) AM 2014 71228 A

(800) 1149172

(151) 2012 09 04

(731) Ostapenko Dmytro Oleksandrovykh
vul. Izmailivs'ka, bud. 148, Dnipropetrovs'k
49008, Ukraine

(540)



(591) Black, white

(511)

7 – Machines and machine tools; motors and engines (except for land vehicles); machine coupling and

transmission components (except for land vehicles); agricultural implements other than hand-operated; incubators for eggs; automatic vending machines; acetylene cleaning apparatus; adhesive bands for pulleys; adhesive tape dispensers [machines]; aerated beverage-making machines; aerated water making apparatus; aerating pumps for aquaria; aerocondensers; aeronautical engines; aeroplane engines; agitators; agricultural elevators; agricultural machines; air brushes for applying colour; air condensers; air cushion devices for moving loads; engines for air cushion vehicles; air pumps [garage installations]; air suction machines; alternators; anti-friction pads for machines; anti-pollution devices for motors and engines; automatic grapnels for marine purposes; axles for machines; ball rings for bearings; ball-bearings; basket presses; bearing brackets for machines; bearings [parts of machines]; bearings for transmission shafts; beaters, electric; beating machines; apparatus for drawing up beer under pressure; beer pumps; bellows [machines]; belt conveyors; belts for conveyors; belts for machines; belts for motors and engines; bending machines; beverage preparation machines, electromechanical; bicycle assembling machines; bicycle dynamos; binding apparatus for hay; bitumen making machines; blade holders [parts of machines]; blade sharpening [stropping] machines; blades [parts of machines]; blenders, electric, for household purposes; blowing engines; blowing machines; blowing machines for the compression, exhaustion and transport of gases; blowing machines for the compression, sucking and carrying of grain; bobbins for weaving looms; machine boiler scale collectors; boiler tubes [parts of machines]; bookbinding apparatus and machines for industrial purposes; bottle capping machines; bottle filling machines; bottle sealing machines; bottle stoppering machines; bottle washing machines; boxes for matrices [printing]; braiding machines; brake linings other than for vehicles; brake pads other than for vehicles; brake segments other than for vehicles; brake shoes other than for vehicles; bread cutting machines; brewing machines; brushes [parts of machines]; brushes, electrically operated; bulldozers; butter machines; capstans; carbon brushes [electricity]; carburetter feeders; carburetters; card clothing [parts of carding machines]; carding machines; machines and apparatus for carpet shampooing, electric; carriage aprons; cartridges for filtering machines; catalytic converters; central vacuum cleaning installations; centrifugal machines; centrifugal mills; centrifugal pumps; chaff cutter blades; chaff cutters; chain saws; chisels for machines; chucks [parts of machines]; churns; cigarette machines for industrial purposes; cipher sifters [machines]; clack valves [parts of machines]; machines and apparatus for cleaning, electric; cleaning appliances utilizing steam; clippers [machines]; clutches other than for land vehicles; coalcutting machines; coffee grinders, other than

hand-operated; coin-operated washing machines; colour-washing machines; compressed air engines; compressed air guns for the extrusion of mastics; compressed air machines; compressed air pumps; compressors [machines]; compressors for refrigerators; concrete mixers [machines]; condensers [steam] [parts of machines]; condensing installations; connecting rods for machines, motors and engines; control cables for machines, engines or motors; control mechanisms for machines, engines or motors; hydraulic controls for machines, motors and engines; pneumatic controls for machines, motors and engines; converters for steel works; conveyors [machines]; cord making machines; couplings other than for land vehicles; cranes [lifting and hoisting apparatus]; crank shafts; crankcases for machines, motors and engines; cranks [parts of machines]; cream/milk separators; cultivators [machines]; current generators; curtain drawing devices, electrically operated; cutters [machines]; cutting blow pipes, gas-operated; cutting machines; cylinder heads for engines; cylinders for machines; cylinders for motors and engines; dairy machines; darning machines; de-aerators for feedwater; degreasers [machines]; derricks; die-cutting and tapping machines; die-stamping machines; diggers [machines]; dishwashers; disintegrators; garbage [waste] disposals; distribution machines, automatic; ditchers [ploughs]; dividing machines; door closers, electric; hydraulic door openers and closers [parts of machines]; door openers, electric; drain cocks; drainage machines; drill chucks [parts of machines]; drilling bits [parts of machines]; drilling heads [parts of machines]; drilling machines; drilling rigs, floating or non-floating; electric hand drills; driving chains other than for land vehicles; driving motors other than for land vehicles; drums [parts of machines]; dust exhausting installations for cleaning purposes; dust removing installations for cleaning purposes; dyeing machines; dynamo belts; dynamo brushes; dynamos; earth moving machines; machines for making edible pastes; ejectors; electric arc cutting apparatus; electric arc welding apparatus; electric hammers; electric welding apparatus; electrodes for welding machines; electromechanical machines for chemical industry; electroplating machines; elevating apparatus; elevator chains [parts of machines]; elevators [lifts]; embossing machines; emergency power generators; engines for boats; engines, other than for land vehicles; engraving machines; escalators; excavators; exhausts for motors and engines; expansion tanks [parts of machines]; extractors for mines; fan belts for motors and engines; fans for motors and engines; feeders [parts of machines]; feeding apparatus for engine boilers; feedwater regulators; filling machines; filter presses; filtering machines; filters [parts of machines or engines]; filters for cleaning cooling air, for engines; finishing machines; fittings for engine boilers; fleshing machines; flour mill machines;

flues for engine boilers; fodder presses; food preparation machines, electromechanical; food processors, electric; forge bellows; foundry machines; freewheels other than for land vehicles; friezing machines; fruit presses, electric, for household purposes; fuel conversion apparatus for internal combustion engines; fuel dispensing pumps for service stations; fuel economisers for motors and engines; galvanizing machines; gasifiers; gas-operated blow torches; gear boxes other than for land vehicles; gears for weaving looms; gears, other than for land vehicles; generators of electricity; glass working machines; glaziers' diamonds [parts of machines]; glow plugs for diesel engines; glue guns, electric; grain separators; grating machines for vegetables; grease boxes [parts of machines]; grease rings [parts of machines]; grinders/crushers, electric, for household purposes; grinding machines; guides for machines; guns [tools using explosives]; hammers [parts of machines]; hand-held tools, other than hand-operated; handling apparatus for loading and unloading; handling machines, automatic [manipulators]; hangers [parts of machines]; harrows; harvesting machines; heat exchangers [parts of machines]; heel-making machines; hemming machines; high pressure washers; hoists; holding devices for machine tools; hoods [parts of machines]; hoppers [mechanical discharging]; hosiery looms; housings [parts of machines]; corn and grain husking machines; hydraulic engines and motors; hydraulic turbines; igniting devices for internal combustion engines; igniting magnetos; injectors for engines; inking apparatus for printing machines; ironing machines; jacks [machines]; jet engines other than for land vehicles; joints [parts of engines]; journal boxes [parts of machines]; journals [parts of machines]; kick starters for motorcycles; kitchen machines, electric; kneading machines; knitting machines; knives [parts of machines]; knives for mowing machines; knives, electric; labellers [machines]; lace making machines; lasts for shoes [parts of machines]; lathes [machine tools]; lawnmowers [machines]; leather paring machines; leather-working machines; lift belts; lift operating apparatus; lifting apparatus; lifts, other than ski-lifts; loading ramps; loom shafts; looms; lubricating pumps; lubricators [parts of machines]; machine flywheels; machine tools; machine wheels; machine wheelwork; machines for the textile industry; mangles; exhaust manifold for engines; matrices for use in printing; meat mincers [machines]; mechanized livestock feeders; metal drawing machines; metalworking machines; milking machines; milling machines; mills [machines]; mills for household purposes, other than hand-operated; millstones; mine borers; mineral water making machines; mineworking machines; mixers [machines]; mixing machines; molding machines; molds [parts of machines]; mortising machines; motorized cultivators; motors for boats; motors, electric, other than for land ve-

hicles; moving pavements [sidewalks]; mud catchers and collectors [machines]; mufflers for motors and engines; net hauling machines [fishing]; notchers [machine tools]; oil refining machines; ore treating machines; packaging machines; packing machines; painting machines; paper feeders [printing]; paper machines; papermaking machines; parquet wax-polishers, electric; pedal drives for sewing machines; peeling machines; pepper mills other than hand-operated; piston segments; pistons [parts of machines or engines]; pistons for cylinders; pistons for engines; planing machines; ploughs; ploughshares; pneumatic door openers and closers [parts of machines]; pneumatic hammers; pneumatic transporters; pneumatic tube conveyors; machines and apparatus for polishing [electric]; potters' wheels; power hammers; presses [machines for industrial purposes]; pressure reducers [parts of machines]; pressure regulators [parts of machines]; pressure valves [parts of machines]; printing cylinders; printing machines; printing machines for use on sheet metal; printing plates; printing presses; printing rollers for machines; propulsion mechanisms other than for land vehicles; puddling machines; pulleys; pulleys [parts of machines]; pump diaphragms; pumps [machines]; pumps [parts of machines, engines or motors]; pumps for heating installations; punches for punching machines; punching machines; rack and pinion jacks; racket stringing machines; radiators [cooling] for motors and engines; rail-laying machines; railroad constructing machines; rakes for raking machines; raking machines; rams [machines]; reapers; reapers and binders; reapers and threshers; reduction gears other than for land vehicles; reeling apparatus, mechanical; reels [parts of machines]; reels, mechanical, for flexible hoses; regulators [parts of machines]; piston rings; rinsing machines; riveting machines; road making machines; road sweeping machines [self-propelled]; robots [machines]; roller bearings; roller bridges; rolling mill cylinders; rolling mills; rotary printing presses; rotary steam presses, portable, for fabrics; satinizing machines; sausage machines; saw benches [parts of machines]; saw blades [parts of machines]; saws [machines]; scissors, electric; sealing machines for industrial purposes; electrical apparatus for sealing plastics [packaging]; self-oiling bearings; self-regulating fuel pumps; separators; sewage pulverizers; sewing machines; shaft couplings [machines]; sharpening machines; sharpening wheels [parts of machines]; sheaf-binding machines; shearing machines for animals; shears, electric; shock absorber plungers [parts of machines]; shoe lasts [parts of machines]; shoe polishers, electric; shovels, mechanical; shredders [machines] for industrial use; shuttles [parts of machines]; sieves [machines or parts of machines]; sifters; sifting installations; sifting machines; sizing machines; slide rests [parts of machines]; sliders for knitting machines; smoothing presses; snow plo-

ughs; soldering apparatus, electric; soldering apparatus, gas-operated; soldering blow pipes, gas-operated; soldering irons, electric; soldering irons, gas-operated; soldering lamps; sorting machines for industry; sowers [machines]; sparking plugs for internal combustion engines; speed governors for machines, engines and motors; spin driers [not heated]; spinning frames; spinning machines; spinning wheels; spray guns for paint; spraying machines; springs [parts of machines]; stalk separators [machines]; stamping machines; stands for machines; starters for motors and engines; stators [parts of machines]; steam engine boilers; steam engines; steam traps; steam/oil separators; steamrollers; stereotype machines; stitching machines; stone working machines; stropping machines; stuffing boxes [parts of machines]; suction cups for milking machines; suction machines for industrial purposes; sugar making machines; superchargers; superheaters; swaging machines; tables for machines; tambours for embroidery machines; taps [parts of machines, engines or motors]; tarring machines; tedding machines; thermic lances [machines]; threading machines; threshing machines; tilt hammers; tin openers, electric; tobacco processing machines; tools [parts of machines]; torque converters other than for land vehicles; transmission chains other than for land vehicles; transmission shafts, other than for land vehicles; transmissions for machines; transmissions, other than for land vehicles; trash compacting machines; trimming machines; trueing machines; turbines other than for land vehicles; turbocompressors; turf removing ploughs; tympan [parts of printing presses]; typecasting machines; type-setting machines [photocomposition]; type-setting machines [printing]; typographic machines; typographic presses; universal joints [cardan joints]; vacuum cleaner attachments for disseminating perfumes and disinfectants; vacuum cleaner bags; vacuum cleaner hoses; vacuum cleaners; vacuum pumps [machines]; valves [parts of machines]; vehicle washing installations; vending machines; vibrators [machines] for industrial use; vulcanisation apparatus; waggon lifts; washing apparatus; washing installations for vehicles; washing machines; washing machines [laundry]; waste compacting machines; waste disposals; water heaters [parts of machines]; machines and apparatus for wax-polishing, electric; weeding machines; welding apparatus, gas-operated; welding machines, electric; whisks, electric, for household purposes; winches; wind turbines; wine presses; winnowers; woodworking machines; wrapping machines; wringing machines for laundry.

9 – Scientific, nautical, surveying, photographic, cinematographic, optical, weighing, measuring, signalling, checking (supervision), life-saving and teaching apparatus and instruments; apparatus and instruments for conducting, switching, transforming, accumulating, regulating or controlling electricity;

apparatus for recording, transmission or reproduction of sound or images; magnetic data carriers, recording discs; compact discs, DVDs and other digital recording media; mechanisms for coin-operated apparatus; cash registers, calculating machines, data processing equipment, computers; computer software; fire-extinguishing apparatus; abacuses; accounting machines; accumulator boxes; accumulator jars; accumulators, electric; accumulators, electric, for vehicles; acid hydrometers; acidimeters for batteries; acoustic conduits; acoustic couplers; actinometers; adding machines; aerometers; electronic agendas; air analysis apparatus; alarm bells, electric; alarms; alcoholmeters; alidades; altimeters; ammeters; amplifiers; amplifying tubes; anemometers; animated cartoons; anodes; answering machines; antennas; anticathodes; anti-dazzle shades; anti-glare glasses; anti-interference devices [electricity]; anti-theft warning apparatus; apertometers [optics]; armatures [electricity]; asbestos clothing for protection against fire; asbestos gloves for protection against accidents; asbestos screens for firemen; apparatus and instruments for astronomy; audiovisual teaching apparatus; automated teller machines [ATM]; azimuth instruments; balances [steelyards]; balancing apparatus; bar code readers; barometers; batteries for lighting; batteries, electric; battery chargers; battery jars; beacons, luminous; bells [warning devices]; betatrons; binoculars; blinkers [signalling lights]; blueprint apparatus; boiler control instruments; branch boxes [electricity]; breathing apparatus for underwater swimming; breathing apparatus, except for artificial respiration; bullet-proof waistcoats [vests (am.)]; buzzers; cabinets for loudspeakers; fibre [fiber (am.)] optic cables; junction sleeves for electric cables; cables, electric; calculating disks; calculating machines; calibrating rings; calipers; camcorders; cameras [photography]; capacitors; capillary tubes; carpenters' rules; carriers for dark plates [photography]; cases especially made for photographic apparatus and instruments; cases fitted with dissecting instruments [microscopy]; cash registers; cassette players; cathodes; cathodic anti-corrosion apparatus; cell phone straps; centering apparatus for photographic transparencies; central processing units [processors]; chargers for electric batteries; chemistry apparatus and instruments; chips [integrated circuits]; choking coils [impedance]; chromatography apparatus for laboratory use; chronographs [time recording apparatus]; cinematographic cameras; apparatus for editing cinematographic film; cinematographic film, exposed; circuit breakers; circuit closers; cleaning apparatus for phonograph records; cleaning apparatus for sound recording discs; clothing especially made for laboratories; clothing for protection against accidents, irradiation and fire; clothing for protection against fire; coaxial cables; coils, electric; coin-operated mechanisms for television sets; collectors, electric; electric apparatus for commutation; commutators; co-

mpact disc players; compact discs [audio-video]; compact discs [read-only memory]; comparators; directional compasses; compasses [measuring instruments]; computer game programs; computer keyboards; computer memory devices; computer operating programs, recorded; computer peripheral devices; computer programmes [programs], recorded; computer programs [downloadable software]; computer software, recorded; conductors, electric; connections for electric lines; connections, electric; connectors [electricity]; contact lenses; contacts, electric; containers for contact lenses; containers for microscope slides; control panels [electricity]; converters, electric; copper wire, insulated; correcting lenses [optics]; cosmographic instruments; mechanisms for counter-operated apparatus; counters; couplers [data processing equipment]; covers for electric outlets; crash test dummies; cupels [laboratory]; current rectifiers; cyclotrons; darkroom lamps [photography]; darkrooms [photography]; magnetic data media; data processing apparatus; decompression chambers; demagnetizing apparatus for magnetic tapes; densimeters; densitometers; detectors; diagnostic apparatus, not for medical purposes; diaphragms [acoustics]; diaphragms [photography]; diaphragms for scientific apparatus; dictating machines; diffraction apparatus [microscopy]; discharge tubes, electric, other than for lighting; disk drives for computers; disks, magnetic; distance measuring apparatus; distance recording apparatus; distillation apparatus for scientific purposes; distribution boards [electricity]; distribution boxes [electricity]; distribution consoles [electricity]; divers' masks; diving suits; DNA chips; dog whistles; dosage dispensers; downloadable image files; downloadable music files; downloadable ring tones for mobile phones; drainers for use in photography; dressmakers' measures; drying apparatus for photographic prints; drying racks [photography]; ducts [electricity]; DVD players; dynamometers; ear plugs for divers; editing appliances for cinematographic films; egg timers [sandglasses]; egg-candlers; electric door bells; electric installations for the remote control of industrial operations; electric loss indicators; electricity conduits; materials for electricity mains [wires, cables]; electrified fences; electrified rails for mounting spot lights; electro-dynamic apparatus for the remote control of railway points; electro-dynamic apparatus for the remote control of signals; electrolyzers; electromagnetic coils; electronic notice boards; electronic pens [visual display units]; electronic pocket translators; electronic publications, downloadable; electronic tags for goods; encoded identification bracelets, magnetic; encoded magnetic cards; enlarging apparatus [photography]; epidiascopes; ergometers; exposure meters [light meters]; eyeglass cases; eyeglass chains; eyeglass cords; eyeglass frames; eyepieces; instruments containing eyepieces; facsimile machines; false coin detectors; apparatus for fermentation [laboratory apparatus];

film cutting apparatus; films, exposed; filters [photography]; filters for respiratory masks; filters for ultraviolet rays, for photography; fire alarms; fire beaters; fire blankets; fire boats; fire engines; fire escapes; fire extinguishing apparatus; fire hose; fire hose nozzles; flash-bulbs [photography]; flashing lights [luminous signals]; flashlights [photography]; floppy disks; fluorescent screens; fog signals, non-explosive; food analysis apparatus; frames for photographic transparencies; frequency meters; furniture especially made for laboratories; fuse wire; fuses; galena crystals [detectors]; galvanic batteries; galvanic cells; galvanometers; garments for protection against fire; gas testing instruments; gasometers [measuring instruments]; gauges; glass covered with an electrical conductor; graduated glassware; glazing apparatus for photographic prints; global positioning system [GPS] apparatus; gloves for divers; gloves for protection against accidents; gloves for protection against X-rays for industrial purposes; goggles for sports; gradient indicators; grids for batteries; hands free kits for phones; head cleaning tapes [recording]; headphones; heat regulating apparatus; heliographic apparatus; hemline markers; high tension batteries; high-frequency apparatus; holders for electric coils; holograms; horns for loudspeakers; hydrometers; hygrometers; identification sheaths for electric wires; identification threads for electric wires; identity cards, magnetic; igniting apparatus, electric, for igniting at a distance; inclinometers; incubators for bacteria culture; inductors [electricity]; integrated circuit cards [smart cards]; integrated circuits; intercommunication apparatus; interfaces for computers; inverters [electricity]; invoicing machines; ionization apparatus not for the treatment of air or water; jigs [measuring instruments]; juke boxes for computers; juke boxes, musical; junction boxes [electricity]; kilometer recorders for vehicles; knee-pads for workers; laboratory centrifuges; laboratory trays; lactodensimeters; lactometers; laptop computers; lasers, not for medical purposes; appliances for measuring the thickness of leather; lens hoods; lenses for astrophotography; letter scales; levelling instruments; levelling staffs [surveying instruments]; levels [instruments for determining the horizontal]; life belts; life buoys; life jackets; life nets; life saving apparatus and equipment; life-saving rafts; light dimmers [regulators], electric; light-emitting diodes [LED]; light-emitting electronic pointers; lighting ballasts; lightning arresters; limiters [electricity]; locks, electric; logs [measuring instruments]; loudspeakers; magic lanterns; magnetic encoders; magnetic tape units for computers; magnetic tapes; magnetic wires; magnets; decorative magnets; magnifying glasses [optics]; marine compasses; marine depth finders; marking buoys; marking gauges [joinery]; masts for wireless aerials; material testing instruments and machines; mathematical instruments; measures; measuring apparatus; measuring

devices, electric; measuring glassware; measuring instruments; measuring spoons; mechanical signs; megaphones; mercury levels; metal detectors for industrial or military purposes; meteorological balloons; meteorological instruments; metronomes; micrometer gauges; micrometer screws for optical instruments; microphones; microprocessors; microscopes; microtomes; mirrors [optics]; mirrors for inspecting work; modems; money counting and sorting machines; monitoring apparatus, electric; monitors [computer hardware]; monitors [computer programs]; motor fire engines; mouse [data processing equipment]; mouse pads; nautical apparatus and instruments; naval signalling apparatus; navigation apparatus for vehicles [on-board computers]; navigational instruments; neon signs; nets for protection against accidents; nose clips for divers and swimmers; notebook computers; objectives [lenses] [optics]; observation instruments; octants; ohmmeters; optical apparatus and instruments; optical character readers; optical condensers; optical data media; optical discs; optical fibers [fibres] [light conducting filaments]; optical glass; optical goods; optical lamps; optical lenses; oscillographs; ovens for laboratory use; oxygen transvasing apparatus; ozonisers [ozonators]; parking meters; particle accelerators; pedometers; peepholes [magnifying lenses] for doors; periscopes; personal stereos; petrol gauges; phonograph records; photocopiers [photographic, electrostatic, thermic]; photometers; phototelegraphy apparatus; photovoltaic cells; apparatus and instruments for physics; pince-nez; pince-nez chains; pipettes; plane tables [surveying instruments]; planimeters; plates for batteries; plotters; plugs, sockets and other contacts [electric connections]; plumb bobs; plumb lines; pocket calculators; polarimeters; portable media players; portable telephones; precision balances; precision measuring apparatus; pressure gauges; automatic indicators of low pressure in vehicle tires [tyres]; pressure indicator plugs for valves; pressure indicators; pressure measuring apparatus; printed circuit boards; printed circuits; printers for use with computers; prisms [optics]; probes for scientific purposes; projection apparatus; projection screens; protection devices against X-rays, not for medical purposes; protection devices for personal use against accidents; protective helmets; protective helmets for sports; protective masks; protective suits for aviators; protractors [measuring instruments]; punched card machines for offices; push buttons for bells; pyrometers; quantity indicators; radar apparatus; radio pagers; radiological apparatus for industrial purposes; radiology screens for industrial purposes; radios; radiotelegraphy sets; radiotelephony sets; railway traffic safety appliances; readers [data processing equipment]; audio and video receivers; apparatus for changing record player needles; record players; reducers [electricity]; reflecting discs for wear, for the prevention of traffic accidents; refrac-

tometers; refractors; regulating apparatus, electric; relays, electric; remote control apparatus; resistances, electric; respirators for filtering air; respirators, other than for artificial respiration; resuscitation mannequins [teaching apparatus]; retorts; retorts' stands; revolution counters; rheostats; riding helmets; road signs, luminous or mechanical; rods for water diviners; rulers [measuring instruments]; rules [measuring instruments]; saccharometers; safety restraints, other than for vehicle seats and sports equipment; safety tarpaulins; salinometers; satellite navigational apparatus; satellites for scientific purposes; scales; scanners [data processing equipment]; screens [photography]; screens for photoengraving; screw-tapping gauges; semi-conductors; sextants; sheaths for electric cables; shoes for protection against accidents, irradiation and fire; shutter releases [photography]; shutters [photography]; sighting telescopes for firearms; signal bells; signal lanterns; signalling buoys; signalling panels, luminous or mechanical; signalling whistles; signals, luminous or mechanical; signs, luminous; simulators for the steering and control of vehicles; sirens; apparatus for measuring the thickness of skins; slide calipers; slide-rules; slides [photography]; smoke detectors; socks, electrically heated; solar batteries; solderers' helmets; solenoid valves [electromagnetic switches]; sonars; sound alarms; sound locating instruments; sound recording apparatus; sound recording carriers; sound recording discs; sound recording strips; sound reproduction apparatus; sound transmitting apparatus; sounding apparatus and machines; sounding leads; sounding lines; spark-guards; speaking tubes; spectacle cases; spectacle frames; spectacle glasses; spectacles [optics]; spectrograph apparatus; spectroscopes; speed checking apparatus for vehicles; speed indicators; speed measuring apparatus [photography]; speed regulators for record players; spherometers; spirit levels; spools [photography]; sprinkler systems for fire protection; stage lighting regulators; apparatus to check stamping mail; stands for photographic apparatus; starter cables for motors; steelyards [lever scales]; steering apparatus, automatic, for vehicles; step-up transformers; stereoscopes; stereoscopic apparatus; stills for laboratory experiments; styli for record players; sulphitometers; sunglasses; surveying apparatus and instruments; surveying chains; surveying instruments; surveyors' levels; switchboards; switchboxes [electricity]; switches, electric; tachometers; tape recorders; taximeters; teaching apparatus; teeth protectors; telegraph wires; telegraphs [apparatus]; telemeters; telephone apparatus; telephone receivers; telephone transmitters; telephone wires; teleprompters; telerupters; telescopes; teletypewriters; television apparatus; temperature indicators; terminals [electricity]; test tubes; testing apparatus not for medical purposes; theft prevention installations, electric; theodolites; thermionic tubes; thermionic valves; thermometers, not

for medical purposes; thermostats; thermostats for vehicles; thread counters; ticket dispensers; time clocks [time recording devices]; time recording apparatus; time switches, automatic; tone arms for record players; totalizers; traffic-light apparatus [signalling devices]; transformers [electricity]; transistors [electronic]; transmitters [telecommunication]; transmitters of electronic signals; transmitting sets [telecommunication]; transparencies [photography]; transparency projection apparatus; transponders; triodes; tripods for cameras; urinometers; USB flash drives; vacuum gauges; vacuum tubes [radio]; variometers; vehicle breakdown warning triangles; vehicle radios; verniers; video cassettes; video game cartridges; video recorders; video screens; video telephones; videotapes; viewfinders, photographic; viscosimeters; voltage regulators for vehicles; voltage surge protectors; voltmeters; voting machines; wafers [silicon slices]; waling glasses; walkie-talkies; washing trays [photography]; water level indicators; wavemeters; weighbridges; weighing apparatus and instruments; weighing machines; weights; whistle alarms; wind socks for indicating wind direction; wire connectors [electricity]; wires, electric; word processors; workmen's protective face-shields; wrist rests for use with computers; X-ray apparatus not for medical purposes; X-ray films, exposed; X-ray photographs, other than for medical purposes; X-ray tubes not for medical purposes; X-rays producing apparatus and installations, not for medical purposes.

11 – Apparatus for lighting, heating, steam generating, cooking, refrigerating, drying, ventilating, water supply and sanitary purposes; acetylene burners; acetylene flares; acetylene generators; air conditioners for vehicles; air conditioning apparatus; air conditioning installations; air cooling apparatus; air deodorising apparatus; air driers [dryers]; air filtering installations; air purifying apparatus and machines; air reheaters; air sterilizers; air valves for steam heating installations; alcohol burners; anti-dazzle devices for automobiles [lamp fittings]; anti-glare devices for vehicles [lamp fittings]; anti-splash tap nozzles; aquarium filtration apparatus; aquarium heaters; aquarium lights; arc lamps; ash conveyor installations, automatic; ash pits for furnaces; autoclaves [electric pressure cookers]; bakers' ovens; barbecues; bath fittings; sauna bath installations; bath linings; bath plumbing fixtures; bath tubs; bath tubs for sitz baths; bedwarmers; beverage cooling apparatus; bicycle lights; bidets; blankets, electric, not for medical purposes; boiler pipes [tubes] for heating installations; boilers, other than parts of machines; brackets for gas burners; bread baking machines; bread toasters; bread-making machines; burners; burners for lamps; carbon for arc lamps; ceiling lights; central heating radiators; chandeliers; chimney blowers; chimney flues; Chinese lanterns; chromatography apparatus for industrial purposes; clean chambers [sanitary installations]; coffee filters, elec-

tric; coffee machines, electric; coffee percolators, electric; coffee roasters; coils [parts of distilling, heating or cooling installations]; cookers; cooking apparatus and installations; cooking rings; cooking utensils, electric; coolers for furnaces; cooling appliances and installations; cooling installations and machines; cooling installations for liquids; cooling installations for tobacco; cooling installations for water; curling lamps; cycle lights; dampers [heating]; deep fryers, electric; defrosters for vehicles; apparatus for dehydrating foodstuff organic materials; dental ovens; deodorising apparatus, not for personal use; desalination plants; desiccating apparatus; discharge tubes, electric, for lighting; disinfectant apparatus; disinfectant dispensers for toilets; disinfectant distributors for toilets; disposable sterilization pouches; distillation apparatus; distillation columns; diving lights; drip irrigation emitters [irrigation fittings]; drying apparatus; drying apparatus and installations; drying apparatus for fodder and forage; electric appliances for making yogurt; electric lamps; electrically heated carpets; evaporators; expansion tanks for central heating installations; extractor hoods for kitchens; fairy lights for festive decoration; electric fans for personal use; fans [air-conditioning]; fans [parts of air-conditioning installations]; faucets for pipes (am.); feeding apparatus for heating boilers; filaments for electric lamps; filters [parts of household or industrial installations]; filters for air conditioning; filters for drinking water; fire bars; fireplaces, domestic; fittings, shaped, for furnaces; fittings, shaped, for ovens; flare stacks for use in the oil industry; flares; flashlights [torches]; flues for heating boilers; flushing tanks; footmuffs, electrically heated; footwarmers, electric or non-electric; forage drying apparatus; forges, portable; fountains; freezers; friction lighters for igniting gas; fruit roasters; fuel economisers; fumigation apparatus, not for medical purposes; furnace ash boxes; furnace grates; furnaces, other than for laboratory use; gas boilers; gas burners; gas condensers, other than parts of machines; gas lamps; gas lighters; gas scrubbers [parts of gas installations]; gas scrubbing apparatus; germicidal burners; germicidal lamps for purifying air; glue-heating appliances; hair driers [dryers]; hand drying apparatus for washrooms; headlights for automobiles; hearths; heat accumulators; heat exchangers, not parts of machines; heat pumps; heat regenerators; heaters for baths; heaters for heating irons; heaters for vehicles; heaters, electric, for feeding bottles; heating apparatus; heating apparatus for defrosting windows of vehicles; heating apparatus for solid, liquid or gaseous fuels; heating apparatus, electric; heating boilers; heating cushions [pads], electric, not for medical purposes; heating elements; heating filaments, electric; heating installations; heating installations [water]; heating plates; hot air apparatus; hot air bath fittings; hot air ovens; hot plates; hot water bottles; humidifiers for central

heating radiators; hydrants; hydromassage bath apparatus; ice boxes; ice machines and apparatus; immersion heaters; incandescent burners; incinerators; ionization apparatus for the treatment of air or water; kettles, electric; kiln furniture [supports]; kilns; kitchen ranges [ovens]; laboratory burners; laboratory lamps; lamp chimneys; lamp glasses; lamp globes; lamp mantles; lamp reflectors; lamp shades; lamps; lamps for directional signals of automobiles; lampshade holders; lanterns for lighting; laundry dryers, electric; laundry room boilers; lava rocks for use in barbecue grills; level controlling valves in tanks; light bulbs; light bulbs for directional signals for vehicles; light bulbs, electric; light diffusers; light-emitting diodes [LED] lighting apparatus; lighters; lighting apparatus and installations; lighting apparatus for vehicles; lighting installations for air vehicles; lights for automobiles; lights for vehicles; lights, electric, for Christmas trees; loading apparatus for furnaces; luminous house numbers; luminous tubes for lighting; magnesium filaments for lighting; malt roasters; microwave ovens [cooking apparatus]; microwave ovens for industrial purposes; milk cooling installations; miners' lamps; mixer taps for water pipes; nuclear reactors; oil burners; oil lamps; oil-scrubbing apparatus; ornamental fountains; oven fittings made of fireclay; oxhydrogen burners; pasteurisers; petrol burners; pipe line cocks [spigots]; plate warmers; pocket searchlights; pocket torches, electric; pocket warmers; polymerisation installations; pressure cookers [autoclaves], electric; pressure cooking saucepans, electric; pressure water tanks; processing installations for fuel and nuclear moderating material; projector lamps; purification installations for sewage; radiator caps; radiators [heating]; radiators, electric; refining towers for distillation; refrigerating apparatus and machines; refrigerating appliances and installations; refrigerating cabinets; refrigerating chambers; refrigerating containers; refrigerating display cabinets [display cases]; refrigerators; regulating accessories for water or gas apparatus and pipes; regulating and safety accessories for gas apparatus; regulating and safety accessories for gas pipes; regulating and safety accessories for water apparatus; roasters; roasting apparatus; roasting jacks; roasting spits; rotisseries; safety accessories for water or gas apparatus and pipes; safety lamps; sanitary apparatus and installations; scrubbers [parts of gas installations]; searchlights; shower cubicles [enclosures (am.)]; showers; sinks; sockets for electric lights; solar furnaces; solar thermal collectors [heating]; spa baths [vessels]; standard lamps; steam accumulators; steam boilers, other than parts of machines; steam facial apparatus [saunas]; steam generating installations; fabric steamers; sterilizers; stills; stoves; stoves [heating apparatus]; street lamps; structural plates for ovens; swimming pool chlorinating apparatus; tanning apparatus [sun beds]; taps [faucets]; thermostatic valves [parts of heating

installations]; toasters; tobacco roasters; toilet bowls; toilet seats; toilets, portable; torches for lighting; Turkish bath cabinets, portable; ultraviolet ray lamps, not for medical purposes; urinals [sanitary fixtures]; vehicle headlights; vehicle reflectors; ventilation [air-conditioning] installations and apparatus; ventilation [air-conditioning] installations for vehicles; ventilation hoods; ventilation hoods for laboratories; waffle irons, electric; walk-in refrigerators; warming pans; washers for water taps; wash-hand bowls [parts of sanitary installations]; water closets; water conduits installations; water distribution installations; water filtering apparatus; water flushing installations; water heaters; water heaters [apparatus]; water intake apparatus; water purification installations; water purifying apparatus and machines; water softening apparatus and installations; water sterilizers; water supply installations; watering installations, automatic; watering machines for agricultural purposes; water-pipes for sanitary installations; whirlpool-jet apparatus.

(260) AM 2014 71229 A
 (800) 1149179
 (151) 2012 09 04
 (731) LIMITED LIABILITY COMPANY
 "AXOR INDUSTRY"
 Sobinova, 1, Dnipropetrovsk 49083, Ukraine
 (540)

AXOR

(591) Black, white
 (511)
 37 – Building; repair, except motor vehicle; installation of equipment, namely: installation of doors and windows; electric appliance installation and repair; isolation for building; construction and repair of warehouses; window cleaning.
 40 – Treatment of materials, namely: lamination.

(260) AM 2014 71231 A
 (800) 1149213
 (151) 2012 11 14
 (731) ALTERFIL NÄHFADEN GMBH
 33, Bahnhofstrasse, 09569 OEDERAN,
 Germany
 (540)

ALTERFIL

(591) Black, white
 (511)
 23 – Yarns (single or twisted) and threads made of natural and/or synthetic materials (substances), dyed or not dyed; monofilaments, wool, thread kits; sewing threads packed for the retail.

(260) AM 2014 71232 A
 (800) 1149218
 (151) 2012 12 12
 (731) Wabi-Sabi Enterprises Limited
 Craigmuir Chambers, Road Town, Tortola,
 British Virgin Islands
 (540)



(591) White, black, green
 (511)
 43 – Services for providing food and drink; temporary accommodation; accommodation bureaux [hotels, boarding houses]; rental of temporary accommodation; rental of meeting rooms; tourist homes; hotel reservations; boarding house bookings; temporary accommodation reservations; hotels; retirement homes; snack-bars; cafés; cafeterias; motels; boarding houses; boarding for animals; rental of chairs, tables, table linen, glassware; rental of tents; rental of transportable buildings; restaurants; self-service restaurants; canteens; holiday camp services [lodging]; bar services; providing campground facilities; food and drink catering; day-nurseries [crèches].

(260) AM 2014 71233 A
 (800) 1149269
 (151) 2012 10 02
 (731) NUBE, S.L
 Avda. 8 de Agosto, 27, E-07800 IBIZA
 (BALEARES), Spain
 (540)



(591) Black, white
 (511)
 41 – Education; training; entertainment services; sporting and cultural activities.
 43 – Services for providing food and drink; temporary accommodation.

(260) AM 2014 71234 A
 (800) 1149271
 (151) 2012 11 14
 (731) ROYAL-VOSTOK INVESTMENTS LIMITED
 8 Kalypsous street, CY-3101 Limassol, Cyprus

(540)
BELUGA HUNTING

(591) Black, white
 (511)
 33 – Alcoholic beverages containing fruit; alcoholic beverages, except beer; alcoholic essences, alcoholic extracts; anise [liqueur]; anisette [liqueur]; aperitifs; arrack [arak]; bitters; brandy; cider; cocktails; curacao; digesters [liqueurs and spirits]; distilled beverages; fruit extracts, alcoholic; gin; kirsch; liqueurs; mead [hydromel]; peppermint liqueurs; perry; piquette; pre-mixed alcoholic beverages, other than beer-based; rice alcohol; rum; sake; spirits [beverages]; vodka; whisky; wine.

(260) AM 2014 71235 A
 (800) 1149274
 (151) 2012 12 28
 (731) ANHUI FORKLIFT TRUCK GROUP CO., LTD.
 15 Wangjiang West Road, Hefei, Anhui, China

(540)
HELI

(591) Black, white
 (511)
 12 – Forklift trucks; trailers; electrical trucks; trucks powered by a battery (storage battery); gear boxes for land vehicles; undercarriages for land vehicles; gearing for land vehicles; crankcases for land vehicles components other than for engines.

(260) AM 2014 71236 A
 (800) 1149287
 (151) 2012 12 21
 (731) GUANGZHOU NEAR MAP TRADING CO., LTD.
 No. 23 Store, 1st FL. No. 47, Dongguanhuang Road, Tianhe District, Guangzhou, Guangdong Province, China

(540)
KAILAS

(591) Black, white
 (511)
 6 – Ice nails [climbing irons]; crampons [climbing irons]; bolts of metal; plugs of metal; pulleys of metal [other than for machines]; pitons of metal [mountaineering equipment].

8 – Sharpening instruments; garden tools, hand-operated; harpoons; razors, electric or non-electric; hand tools, hand-operated; metal band stretchers [hand tools]; glaziers's diamonds [parts of hand tools]; knives; side arms; table cutlery [knives, forks and spoons].

18 – Furniture coverings of leather; backpacks; valises; bags for sports; leather straps; handbags; leather, unworked or semi-worked; travelling sets [leatherware]; alpenstocks; umbrellas; leather leashes; gut for making sausages; harness straps.

(260) AM 2014 71239 A
 (800) 1149311
 (151) 2013 01 08
 (731) Citodat Invest OÜ
 Narva mnt 13a, EE-10151 Tallinn, Estonia

(540)

(591) Red, white
 (511)
 39 – Rental of storage containers; freight forwarding, brokering and logistic services relating to the transportation of freight and property by land, sea, air or rail.

(260) AM 2014 71241 A
 (800) 1149334
 (151) 2012 08 15
 (731) GLENDLANE HOLDING LIMITED
 Trident Center, 115 Griva Digeni, CY-3101 Limassol, Cyprus

(540)

(591) Black, white
 (511)
 41 – Academies [education]; providing amusement arcade services; amusement parks; amusements; animal training; arranging and conducting of colloquiums; arranging and conducting of concerts; arranging and conducting of conferences; arranging and conducting of congresses; arranging and conducting of seminars; arranging and conducting of symposiums; arranging and conducting of workshops [training]; arranging of beauty contests; boarding schools; booking of seats for shows; bookmobile services; publication of books; calligraphy services; holiday camp services [entertainment]; sport camp services; providing casino facilities [gambling]; rental of cine-films; cinema presentations; circuses;

club services [entertainment or education]; coaching [training]; organization of competitions [education or entertainment]; organization of sports competitions; conducting fitness classes; correspondence courses; disc jockey services; discotheque services; rental of skin diving equipment; dubbing; videotape editing; education information; religious education; educational examination; educational services; electronic desktop publishing; entertainer services; entertainment; entertainment information; organization of exhibitions for cultural or educational purposes; organization of fashion shows for entertainment purposes; film production, other than advertising films; gambling; game services provided on-line from a computer network; games equipment rental; providing golf facilities; vocational guidance [education or training advice]; gymnastic instruction; health club services [health and fitness training]; recreation information; instruction services; sign language interpretation; language interpreter services; layout services, other than for advertising purposes; lending libraries; mobile library services; presentation of live performances; operating lotteries; microfilming; modelling for artists; rental of motion pictures; rental of movie projectors and accessories; movie studios; movie theatre presentations; providing museum facilities [presentation, exhibitions]; music composition services; music-halls; news reporters services; night clubs; nursery schools; orchestra services; organization of balls; organization of shows [impresario services]; organization of sports competitions amusement parks; party planning [entertainment]; personal trainer services [fitness training]; photographic reporting; photography; physical education; practical training [demonstration]; production of music; production of radio and television programmes; production of shows; videotape film production; providing karaoke services; providing on-line electronic publications, not downloadable; providing sports facilities; publication of electronic books and journals on-line; publication of texts, other than publicity texts; rental of radio and television sets; radio entertainment; rental of video cassette recorders; recording studio services; providing recreation facilities; rental of audio equipment; rental of camcorders; rental of lighting apparatus for theatrical sets or television studios; rental of show scenery; rental of sound recordings; rental of sports equipment, except vehicles; rental of sports grounds; rental of stadium facilities; rental of stage scenery; rental of tennis courts; rental of video cameras; rental of videotapes; script-writing services; timing of sports events; subtitling; teaching; television entertainment; writing of texts, other than publicity texts; theatre productions; ticket agency services [entertainment]; toy rental; translation; tuition; videotaping; vocational retraining; zoological garden services.

(260) AM 2014 71242 A
 (800) 1149335
 (151) 2012 08 20
 (731) GLENDLANE HOLDING LIMITED
 Trident Center, 115 Griva Digeni, CY-3101
 Limassol, Cyprus
 (540)



(591) Black, white
 (511)

41 – Academies [education]; providing amusement arcade services; amusement parks; amusements; animal training; arranging and conducting of colloquiums; arranging and conducting of concerts; arranging and conducting of conferences; arranging and conducting of congresses; arranging and conducting of seminars; arranging and conducting of symposiums; arranging and conducting of workshops [training]; arranging of beauty contests; boarding schools; booking of seats for shows; bookmobile services; publication of books; calligraphy services; holiday camp services [entertainment]; sport camp services; providing casino facilities [gambling]; rental of cine-films; cinema presentations; circuses; club services [entertainment or education]; coaching [training]; organization of competitions [education or entertainment]; organization of sports competitions; conducting fitness classes; correspondence courses; disc jockey services; discotheque services; rental of skin diving equipment; dubbing; videotape editing; education information; religious education; educational examination; educational services; electronic desktop publishing; entertainer services; entertainment; entertainment information; organization of exhibitions for cultural or educational purposes; organization of fashion shows for entertainment purposes; film production, other than advertising films; gambling; game services provided on-line from a computer network; games equipment rental; providing golf facilities; vocational guidance [education or training advice]; gymnastic instruction; health club services [health and fitness training]; recreation information; instruction services; sign language interpretation; language interpreter services; layout services, other than for advertising purposes; lending libraries; mobile library services; presentation of live performances; operating lotteries; microfilming; modelling for artists; rental of motion pictures; rental of movie projectors and accessories; movie studios; movie theatre presentations; providing museum facilities [presentation, exhibitions]; music composition services; music-halls; news reporters services; night clubs; nursery schools; orchestra services; organization of balls; organization of shows [impresario ser-

vices]; organization of sports competitions amusement parks; party planning [entertainment]; personal trainer services [fitness training]; photographic reporting; photography; physical education; practical training [demonstration]; production of music; production of radio and television programmes; production of shows; videotape film production; providing karaoke services; providing on-line electronic publications, not downloadable; providing sports facilities; publication of electronic books and journals on-line; publication of texts, other than publicity texts; rental of radio and television sets; radio entertainment; rental of video cassette recorders; recording studio services; providing recreation facilities; rental of audio equipment; rental of camcorders; rental of lighting apparatus for theatrical sets or television studios; rental of show scenery; rental of sound recordings; rental of sports equipment, except vehicles; rental of sports grounds; rental of stadium facilities; rental of stage scenery; rental of tennis courts; rental of video cameras; rental of videotapes; scriptwriting services; timing of sports events; subtitling; teaching; television entertainment; writing of texts, other than publicity texts; theatre productions; ticket agency services [entertainment]; toy rental; translation; tuition; videotaping; vocational retraining; zoological garden services.

(260) AM 2014 71243 A

(800) 1149348

(151) 2012 08 14

(731) WORLD MEDICINE OPHTHALMICS
İLAÇLARI LİMİTED ŞİRKETİ
Evren Mah. Camiyolu Cad. No.50 K.2,
Güneşli, Bağcılar, İstanbul, Turkey

(540)

SLEZAVIT

(СЛЕЗАВИТ)

(591) Black, white

(511)

5 – Medicines for human purposes, medicines for veterinary purposes, chemical preparations for medical purposes, dietetic substances adapted for medical use; dietetic foods adapted for medical purposes; amino acids for medical purposes, nutritional supplements, pollen dietary supplements, mineral food supplements, protein dietary supplements, baby foods, medicinal herbs, herbal beverages adapted for medical purposes; medicines for dental purposes, hygienic products for medical purposes including pads, waddings for medical purposes, plasters for medical purposes, dressings for medical purposes, preparations for destroying noxious plants, preparations for destroying noxious animals, fungicides, disinfectants for hygiene purposes, antiseptics, detergents for medical purposes.

(260) AM 2014 71245 A

(800) 1149385

(151) 2012 11 02

(731) KORES HOLDING ZUG AG

112, Baarerstrasse, CH-6302 Zug, Switzerland

(540)

KORES

(591) Black, white

(511)

16 – Paper, cardboard and goods made from these material, not included in other classes; carbon paper; binders and folders of cardboard and/or plastic; stationery, in particular markers, colored pencils, felt-tip pens and ballpoint pens; adhesives for stationery or household purposes; adhesive tapes and self-stick items, in particular adhesive notes, adherable flags; labels and adhesive labels; glue sticks and adhesive rollers; correcting rollers and correcting pens, correcting fluids; artists' materials; office requisites (except furniture), including inking and correction ribbons; stamps, stamping inks and stamp pads; staples and paper clips; instructional and teaching material (except apparatus).

(260) AM 2014 71246 A

(800) 1149410

(151) 2012 11 15

(731) Carlsberg A/S

Ny Carlsberg Vej 100, DK-1799 Copenhagen
V, Denmark

(540)



(591) Black, white

(511)

32 – Beers; mineral and aerated waters and other non-alcoholic beverages; fruit beverages and fruit juices; syrups and other preparations for making beverages.

(260) AM 2014 71249 A

(800) 1149425

(151) 2012 11 19

(731) "Delta Medical Promotions AG"

Oetenbachgasse 26, CH-8001 Zurich,
Switzerland

(540)

PRIORA

(591) Black, white

(511)

3 – Almond milk for cosmetic purposes; almond oil; almond soap; amber [perfume]; antiperspirant soap; antiperspirants [toiletries]; aromatics [essential oils]; astringents for cosmetic purposes; bath salts, not for

medical purposes; cosmetic preparations for baths; beauty masks; bergamot oil; bleaching preparations [laundry]; bleaching salts; breath freshening sprays; color- [colour-] brightening chemicals for household purposes [laundry]; cakes of toilet soap; essential oils of cedarwood; essential oils of citron; cleaning preparations; cleansing milk for toilet purposes; cloths impregnated with a detergent for cleaning; color-removing preparations; colorants for toilet purposes; cosmetic kits; cosmetics; cosmetics for animals; cotton sticks for cosmetic purposes; cotton wool for cosmetic purposes; cosmetic creams; skin whitening creams; deodorant soap; detergents other than for use in manufacturing operations and for medical purposes; disinfectant soap; dry-cleaning preparations; eau de Cologne; ethereal essences; essential oils; extracts of flowers [perfumes]; bases for flower perfumes; soap for foot perspiration; fumigation preparations [perfumes]; laundry glaze; greases for cosmetic purposes; jasmine oil; petroleum jelly for cosmetic purposes; joss sticks; lacquer-removing preparations; laundry bleach; laundry soaking preparations; lavender oil; lavender water; sachets for perfuming linen; tissues impregnated with cosmetic lotions; lotions for cosmetic purposes; make-up powder; medicated soap; mint essence [essential oil]; mint for perfumery; mouth washes, not for medical purposes; musk [perfumery]; oil of turpentine for degreasing; oils for cleaning purposes; oils for cosmetic purposes; oils for perfumes and scents; oils for toilet purposes; perfumery; perfumes; shampoos for pets; potpourris [fragrances]; rose oil; scented water; scented wood; scouring solutions; shampoos; shining preparations [polish]; cosmetic preparations for skin care; soap; stain removers; talcum powder, for toilet use; terpenes [essential oils]; toilet water; toiletries; deodorants for human beings or for animals.

5 – Dental abrasives; absorbent cotton; acaricides; acetates for pharmaceutical purposes; acids for pharmaceutical purposes; aconitine; adhesive bands for medical purposes; adhesive plaster; fly catching adhesives; adhesives for dentures; adjuvants for medical purposes; air deodorising preparations; air purifying preparations; albuminous foodstuffs for medical purposes; albuminous preparations for medical purposes, except vaccines; alcohol for pharmaceutical purposes; aldehydes for pharmaceutical purposes; algicides; alkaline iodides for pharmaceutical purposes; alkaloids for medical purposes; alloys of precious metals for dental purposes; milk of almonds for pharmaceutical purposes; aluminium acetate for pharmaceutical purposes; dental amalgams; amino acids for medical purposes; amino acids for veterinary purposes; anaesthetics; analgesics; angostura bark for medical purposes; animal washes; anthelmintics; anti-rheumatism bracelets; anti-rheumatism rings; anti-uric preparations; antibiotics; anticryptogamic preparations; antiparasitic collars for animals; antiparasitic preparations; antiseptic cotton; antiseptics;

appetite suppressants for medical purposes; aseptic cotton; asthmatic tea; bacterial poisons; bacterial preparations for medical and veterinary use, except vaccines; bouillons for bacteriological cultures; bacteriological preparations for medical and veterinary use; balms for medical purposes; balsamic preparations for medical purposes; hygienic bandages; menstruation bandages; bandages for dressings; barks for pharmaceutical purposes; therapeutic preparations for the bath; bath preparations, medicated; bath salts for medical purposes; oxygen baths; salts for mineral water baths; belts for sanitary napkins [towels]; bicarbonate of soda for pharmaceutical purposes; biocides; biological preparations for medical purposes, except vaccines; biological preparations for veterinary purposes; bismuth preparations for pharmaceutical purposes; bismuth subnitrate for pharmaceutical purposes; blood for medical purposes; blood plasma; bone cement for surgical and orthopaedic purposes; bracelets for medical purposes; diabetic bread adapted for medical use; breast-nursing pads; bromine for pharmaceutical purposes; bronchodilating preparations; bunion pads; preparations for the treatment of burns; by-products of the processing of cereals for dietetic or medical purposes; cachets for pharmaceutical purposes; cachou for pharmaceutical purposes; preparations for callouses; calomel; camphor for medical purposes; camphor oil for medical purposes; candy for medical purposes; candy, medicated; powder of cantharides; capsules for medicines; carboli-neum [parasiticide]; castor oil for medical purposes; cattle washes; caustic pencils; caustics for pharmaceutical purposes; cedar wood for use as an insect repellent; cellulose esters for pharmaceutical purposes; cellulose ethers for pharmaceutical purposes; cement for animal hooves; charcoal for pharmaceutical purposes; chemical conductors for electrocardiograph electrodes; chemical preparations for medical purposes; chemical preparations for pharmaceutical purposes; chemical preparations for veterinary purposes; chemical reagents for medical or veterinary purposes; chemico-pharmaceutical preparations, except vaccines; chewing gum for medical purposes; chilblain preparations; chinoline for medical purposes; chloroform; tobacco-free cigarettes for medical purposes; cinchona for medical purposes; contact lens cleaning preparations; deodorants for clothing and textiles; cocaine; cod liver oil; collodion for pharmaceutical purposes; compresses; condurango bark for medical purposes; medicines for alleviating constipation; solutions for use with contact lenses; chemical contraceptives; corn remedies; corn rings for the feet; cotton for medical purposes; cream of tartar for pharmaceutical purposes; creosote for pharmaceutical purposes; croton bark; cultures of microorganisms for medical and veterinary use; curare; pharmaceutical preparations for treating dandruff; decoctions for pharmaceutical purposes; dental cements; dental impression materials; dental lac-

quer; dental mastics; deodorants, other than for human beings or for animals; depuratives; detergents for medical purposes; chemical preparations for the diagnosis of pregnancy; diagnostic preparations for medical purposes; diastase for medical purposes; dietetic beverages adapted for medical purposes; dietetic foods adapted for medical purposes; dietetic substances adapted for medical use; digestives for pharmaceutical purposes; digitalin; dill oil for medical purposes; disinfectants for chemical toilets; disinfectants for hygiene purposes; dog lotions; dog washes; repellents for dogs; surgical dressings; dressings, medical; medicinal drinks; drugs for medical purposes; preparations for destroying dry rot fungus; elixirs [pharmaceutical preparations]; enzyme preparations for medical purposes; enzyme preparations for veterinary purposes; enzymes for medical purposes; enzymes for veterinary purposes; ergot for pharmaceutical purposes; esters for pharmaceutical purposes; ethers for pharmaceutical purposes; eucalyptol for pharmaceutical purposes; eucalyptus for pharmaceutical purposes; evacuants; eye-washes; eyepatches for medical purposes; febrifuges; fennel for medical purposes; milk ferments for pharmaceutical purposes; ferments for pharmaceutical purposes; first-aid boxes, filled, except vaccines; fish meal for pharmaceutical purposes; flaxseed for pharmaceutical purposes; flour for pharmaceutical purposes; flowers of sulphur for pharmaceutical purposes; fly catching paper; fly destroying preparations; food for babies; remedies for foot perspiration; formic aldehyde for pharmaceutical purposes; frostbite salve for pharmaceutical purposes; fumigating pastilles; fumigation preparations for medical purposes; fungicides; gallic acid for pharmaceutical purposes; gamboge for medical purposes; gases for medical purposes; gauze for dressings; gelatine for medical purposes; gentian for pharmaceutical purposes; germicides; glucose for medical purposes; glycerine for medical purposes; glycerophosphates; dental amalgams of gold; goulard water; greases for medical purposes; greases for veterinary purposes; guaiacol for pharmaceutical purposes; gum for medical purposes; gurjun [gurjon, gurjan] balsam for medical purposes; haematogen; haemoglobin; haemorrhoid preparations; haemostatic pencils; medicinal hair growth preparations; articles for headache; headache pencils; herbal teas for medicinal purposes; herbicides; medicinal herbs; smoking herbs for medical purposes; extracts of hops for pharmaceutical purposes; hormones for medical purposes; hydrastine; hydrastinine; hydrated chloral for pharmaceutical purposes; hydrogen peroxide for medical purposes; surgical implants [living tissues]; insect repellent incense; napkins for incontinents; pants, absorbent, for incontinents; medicinal infusions; insect repellents; insecticides; semen for artificial insemination; iodides for pharmaceutical purposes; iodine for pharmaceutical purposes; iodoform; Irish moss for medical

purposes; isotopes for medical purposes; jalap; petroleum jelly for medical purposes; jujube, medicated; menstruation knickers; lacteal flour for babies; lactose for pharmaceutical purposes; larvae exterminating preparations; laxatives; lecithin for medical purposes; leeches for medical purposes; preparations of lime for pharmaceutical purposes; liniments; lint for medical purposes; liquorice for pharmaceutical purposes; tissues impregnated with pharmaceutical lotions; lotions for pharmaceutical purposes; lotions for veterinary purposes; lozenges for pharmaceutical purposes, except vaccines; lupulin for pharmaceutical purposes; magnesia for pharmaceutical purposes; malt for pharmaceutical purposes; malted milk beverages for medical purposes; mangrove bark for pharmaceutical purposes; medicinal oils; medicinal roots; medicinal tea; medicine cases, portable, filled; medicines for dental purposes; medicines for human purposes; medicines for veterinary purposes; melissa water for pharmaceutical purposes; menthol; mercurial ointments; preparations for destroying mice; nutritive substances for microorganisms; chemical preparations to treat mildew; milking grease; mineral food supplements; mineral water salts; mineral waters for medical purposes; mint for pharmaceutical purposes; molding wax for dentists; moleskin for medical purposes; mothproofing paper; mothproofing preparations; mouthwashes for medical purposes; medicinal mud; mud for baths; mustard for pharmaceutical purposes; mustard oil for medical purposes; mustard plasters; myrobalan bark for pharmaceutical purposes; narcotics; nervines; preparations for destroying noxious animals; nutritional supplements; oil of turpentine for pharmaceutical purposes; ointments for pharmaceutical purposes; opiates; opium; opodeldoc; opotherapy preparations; oxygen for medical purposes; panty liners [sanitary]; paper for mustard plasters; parasiticides; pectin for pharmaceutical purposes; pepsins for pharmaceutical purposes; peptones for pharmaceutical purposes; pharmaceutical preparations, except vaccines; phenol for pharmaceutical purposes; phosphates for pharmaceutical purposes; chemical preparations for treating phylloxera; plasters for medical purposes; poisons; pomades for medical purposes; porcelain for dental prostheses; potassium salts for medical purposes; poultices; pyrethrum powder; quassia for medical purposes; quebracho for medical purposes; quinine for medical purposes; radioactive substances for medical purposes; radiological contrast substances for medical purposes; radium for medical purposes; rat poison; remedies for perspiration; rhubarb roots for pharmaceutical purposes; rubber for dental purposes; salts for medical purposes; sanitary napkins; sarsaparilla for medical purposes; scapulars for surgical purposes; sea water for medicinal bathing; sedatives; serotherapeutic medicines; serums, except vaccines; siccatives [drying agents] for medical purposes; pharmaceutical preparations for skin care;

medical preparations for slimming purposes; slug exterminating preparations; smelling salts; sodium salts for medical purposes; soil-sterilising preparations; solvents for removing adhesive plasters; soporifics; starch for dietetic or pharmaceutical purposes; sterilising preparations; steroids; stick liquorice for pharmaceutical purposes; sulphur sticks [disinfectants]; strychnine; styptic preparations; sugar for medical purposes; sulphenamides [medicines]; sunburn ointments; sunburn preparations for pharmaceutical purposes; suppositories; surgical cloth [tissues]; syrups for pharmaceutical purposes, except vaccines; tartar for pharmaceutical purposes; teeth filling material; preparations to facilitate teething; thermal water; thymol for pharmaceutical purposes; tincture of iodine; tinctures for medical purposes; tobacco extracts [insecticides]; tonics [medicines]; preparations of trace elements for human and animal use; turpentine for pharmaceutical purposes; vaginal washes; vermin destroying preparations; vesicants; veterinary preparations; vine disease treating chemicals; vitamin preparations; wadding for medical purposes; wart pencils; chemical preparations to treat wheat blight [smut]; yeast for pharmaceutical purposes.

(260) AM 2014 71250 A

(800) 1149426

(151) 2012 11 19

(731) "Delta Medical Promotions AG"

Oetenbachgasse 26, CH-8001 Zurich,
Switzerland

(540)

HRAPEX

(591) Black, white

(511)

5 – Dental abrasives; absorbent cotton; acaricides; acetates for pharmaceutical purposes; acids for pharmaceutical purposes; aconitine; adhesive bands for medical purposes; adhesive plaster; fly catching adhesives; adhesives for dentures; adjuvants for medical purposes; air deodorising preparations; air purifying preparations; albuminous foodstuffs for medical purposes; albuminous preparations for medical purposes; alcohol for pharmaceutical purposes; aldehydes for pharmaceutical purposes; algicides; alkaline iodides for pharmaceutical purposes; alkaloids for medical purposes; alloys of precious metals for dental purposes; milk of almonds for pharmaceutical purposes; aluminium acetate for pharmaceutical purposes; dental amalgams; amino acids for medical purposes; amino acids for veterinary purposes; anaesthetics; analgesics; angostura bark for medical purposes; animal washes; anthelmintics; anti-rheumatism bracelets; anti-rheumatism rings; anti-uric preparations; antibiotics; anticryptogamic preparations; antiparasitic collars for animals; antiparasitic preparations; antiseptic cotton; antiseptics; appetite

suppressants for medical purposes; aseptic cotton; asthmatic tea; bacterial poisons; bacterial preparations for medical and veterinary use; bouillons for bacteriological cultures; bacteriological preparations for medical and veterinary use; balms for medical purposes; balsamic preparations for medical purposes; hygienic bandages; menstruation bandages; bandages for dressings; barks for pharmaceutical purposes; therapeutic preparations for the bath; bath preparations, medicated; bath salts for medical purposes; oxygen baths; salts for mineral water baths; belts for sanitary napkins [towels]; bicarbonate of soda for pharmaceutical purposes; biocides; biological preparations for medical purposes; biological preparations for veterinary purposes; bismuth preparations for pharmaceutical purposes; bismuth subnitrate for pharmaceutical purposes; blood for medical purposes; blood plasma; bone cement for surgical and orthopaedic purposes; bracelets for medical purposes; diabetic bread adapted for medical use; breast-nursing pads; bromine for pharmaceutical purposes; bronchodilating preparations; bunion pads; preparations for the treatment of burns; by-products of the processing of cereals for dietetic or medical purposes; cachets for pharmaceutical purposes; cachou for pharmaceutical purposes; preparations for callouses; calomel; camphor for medical purposes; camphor oil for medical purposes; candy for medical purposes; candy, medicated; powder of cantharides; capsules for medicines; carbolineum [parasiticide]; castor oil for medical purposes; cattle washes; caustic pencils; caustics for pharmaceutical purposes; cedar wood for use as an insect repellent; cellulose esters for pharmaceutical purposes; cellulose ethers for pharmaceutical purposes; cement for animal hooves; charcoal for pharmaceutical purposes; chemical conductors for electrocardiograph electrodes; chemical preparations for medical purposes; chemical preparations for pharmaceutical purposes; chemical preparations for veterinary purposes; chemical reagents for medical or veterinary purposes; chemico-pharmaceutical preparations; chewing gum for medical purposes; chilblain preparations; chinoline for medical purposes; chloroform; tobacco-free cigarettes for medical purposes; cinchona for medical purposes; contact lens cleaning preparations; deodorants for clothing and textiles; cocaine; cod liver oil; collodion for pharmaceutical purposes; compresses; condurango bark for medical purposes; medicines for alleviating constipation; solutions for use with contact lenses; chemical contraceptives; corn remedies; corn rings for the feet; cotton for medical purposes; cream of tartar for pharmaceutical purposes; creosote for pharmaceutical purposes; croton bark; cultures of microorganisms for medical and veterinary use; curare; pharmaceutical preparations for treating dandruff; decoctions for pharmaceutical purposes; dental cements; dental impression materials; dental lacquer; dental mastics; deodorants, other

than for human beings or for animals; depuratives; detergents for medical purposes; chemical preparations for the diagnosis of pregnancy; diagnostic preparations for medical purposes; diastase for medical purposes; dietetic beverages adapted for medical purposes; dietetic foods adapted for medical purposes; dietetic substances adapted for medical use; digestives for pharmaceutical purposes; digitalin; dill oil for medical purposes; disinfectants for chemical toilets; disinfectants for hygiene purposes; dog lotions; dog washes; repellents for dogs; surgical dressings; dressings, medical; medicinal drinks; drugs for medical purposes; preparations for destroying dry rot fungus; elixirs [pharmaceutical preparations]; enzyme preparations for medical purposes; enzyme preparations for veterinary purposes; enzymes for medical purposes; enzymes for veterinary purposes; ergot for pharmaceutical purposes; esters for pharmaceutical purposes; ethers for pharmaceutical purposes; eucalyptol for pharmaceutical purposes; eucalyptus for pharmaceutical purposes; evacuants; eye-washes; eyepatches for medical purposes; febrifuges; fennel for medical purposes; milk ferments for pharmaceutical purposes; ferments for pharmaceutical purposes; first-aid boxes, filled; fish meal for pharmaceutical purposes; flaxseed for pharmaceutical purposes; flour for pharmaceutical purposes; flowers of sulphur for pharmaceutical purposes; fly catching paper; fly destroying preparations; food for babies; remedies for foot perspiration; formic aldehyde for pharmaceutical purposes; frostbite salve for pharmaceutical purposes; fumigating pastilles; fumigation preparations for medical purposes; fungicides; gallic acid for pharmaceutical purposes; gamboge for medical purposes; gases for medical purposes; gauze for dressings; gelatine for medical purposes; gentian for pharmaceutical purposes; germicides; glucose for medical purposes; glycerine for medical purposes; glycerophosphates; dental amalgams of gold; goulard water; greases for medical purposes; greases for veterinary purposes; guaiacol for pharmaceutical purposes; gum for medical purposes; gurjun [gurjon, gurjan] balsam for medical purposes; haematogen; haemoglobin; haemorrhoid preparations; haemostatic pencils; medicinal hair growth preparations; articles for headache; headache pencils; herbal teas for medicinal purposes; herbicides; medicinal herbs; smoking herbs for medical purposes; extracts of hops for pharmaceutical purposes; hormones for medical purposes; hydrastine; hydrastinine; hydrated chloral for pharmaceutical purposes; hydrogen peroxide for medical purposes; surgical implants [living tissues]; insect repellent incense; napkins for incontinents; pants, absorbent, for incontinents; medicinal infusions; insect repellents; insecticides; semen for artificial insemination; iodides for pharmaceutical purposes; iodine for pharmaceutical purposes; iodoform; Irish moss for medical purposes; isotopes for medical purposes; jalap; petroleum jelly for medical

purposes; jujube, medicated; menstruation knickers; lacteal flour for babies; lactose for pharmaceutical purposes; larvae exterminating preparations; laxatives; lecithin for medical purposes; leeches for medical purposes; preparations of lime for pharmaceutical purposes; liniments; lint for medical purposes; liquorice for pharmaceutical purposes; tissues impregnated with pharmaceutical lotions; lotions for pharmaceutical purposes; lotions for veterinary purposes; lozenges for pharmaceutical purposes; lupulin for pharmaceutical purposes; magnesia for pharmaceutical purposes; malt for pharmaceutical purposes; malted milk beverages for medical purposes; mangrove bark for pharmaceutical purposes; medicinal oils; medicinal roots; medicinal tea; medicine cases, portable, filled; medicines for dental purposes; medicines for human purposes; medicines for veterinary purposes; melissa water for pharmaceutical purposes; menthol; mercurial ointments; preparations for destroying mice; nutritive substances for microorganisms; chemical preparations to treat mildew; milking grease; mineral food supplements; mineral water salts; mineral waters for medical purposes; mint for pharmaceutical purposes; molding wax for dentists; moleskin for medical purposes; mothproofing paper; mothproofing preparations; mouthwashes for medical purposes; medicinal mud; mud for baths; mustard for pharmaceutical purposes; mustard oil for medical purposes; mustard plasters; myrobalan bark for pharmaceutical purposes; narcotics; nervines; preparations for destroying noxious animals; nutritional supplements; oil of turpentine for pharmaceutical purposes; ointments for pharmaceutical purposes; opiates; opium; opodeldoc; ophotherapy preparations; oxygen for medical purposes; panty liners [sanitary]; paper for mustard plasters; parasitocides; pectin for pharmaceutical purposes; pepsins for pharmaceutical purposes; peptones for pharmaceutical purposes; pharmaceutical preparations; phenol for pharmaceutical purposes; phosphates for pharmaceutical purposes; chemical preparations for treating phylloxera; plasters for medical purposes; poisons; pomades for medical purposes; porcelain for dental prostheses; potassium salts for medical purposes; poultices; pyrethrum powder; quassia for medical purposes; quebracho for medical purposes; quinine for medical purposes; radioactive substances for medical purposes; radiological contrast substances for medical purposes; radium for medical purposes; rat poison; remedies for perspiration; rhubarb roots for pharmaceutical purposes; rubber for dental purposes; salts for medical purposes; sanitary napkins; sarsaparilla for medical purposes; scapulars for surgical purposes; sea water for medicinal bathing; sedatives; serotherapeutic medicines; serums; siccatives [drying agents] for medical purposes; pharmaceutical preparations for skin care; medical preparations for slimming purposes; slug exterminating preparations; smelling salts; sodium salts for medical

purposes; soil-sterilising preparations; solvents for removing adhesive plasters; soporifics; starch for dietetic or pharmaceutical purposes; sterilising preparations; steroids; stick liquorice for pharmaceutical purposes; sulphur sticks [disinfectants]; strychnine; styptic preparations; sugar for medical purposes; sulphonamides [medicines]; sunburn ointments; sunburn preparations for pharmaceutical purposes; suppositories; surgical cloth [tissues]; syrups for pharmaceutical purposes; tartar for pharmaceutical purposes; teeth filling material; preparations to facilitate teething; thermal water; thymol for pharmaceutical purposes; tincture of iodine; tinctures for medical purposes; tobacco extracts [insecticides]; tonics [medicines]; preparations of trace elements for human and animal use; turpentine for pharmaceutical purposes; vaginal washes; vermin destroying preparations; vesicants; veterinary preparations; vine disease treating chemicals; vitamin preparations; wadding for medical purposes; wart pencils; chemical preparations to treat wheat blight [smut]; yeast for pharmaceutical purposes.

(260) AM 2014 71251 A

(800) 1149436

(151) 2012 11 12

(731) Sovmestnoe obshchestvo s ogranichennoy otvetstvennostyuu "ЛЕКPHARM"
Komn. 301, d. 2A, ul. Minskaya, 223110 g.
Logoysk, Minskaya obl., Belarus

(540)

ГРИППОМИКС

(591) Black, white

(511)

5 – Pharmaceutical and veterinary preparations; sanitary preparations for medical purposes; dietetic food; substances adapted for medical or veterinary use; dietary supplements for humans and animals; antipyretic analgesics; analgesics; antipyretics; drugs for medical purposes; medicines for veterinary purposes; medicines for human purposes; anti-inflammatory preparations, including antipyretic preparations; vitamin C preparations; chemico-pharmaceutical preparations; chemical preparations for veterinary purposes; chemical preparations for medical purposes; chemical preparations for pharmaceutical purposes; preparations for treating colds; diaphoretics; anti-inflammatories; pharmaceutical preparations for treating respiratory diseases; pharmaceutical antitussive-cold preparations.

(260) AM 2014 71262 A

(800) 1149437

(151) 2012 11 12

(731) Sovmestnoe obshchestvo s ogranichennoy otvetstvennostyuu "ЛЕКPHARM"
Komn. 301, d. 2A, ul. Minskaya, 223110 g.
Logoysk, Minskaya obl., Belarus

(540)

ЭКВАПРИЛ

(591) Black, white

(511)

5 – Pharmaceutical and veterinary preparations; drugs for medical purposes; sanitary preparations for medical purposes; pharmaceutical preparations; ferments for pharmaceutical and medical purposes; herbal teas for medicinal purposes; disinfectants for hygiene purposes; vitamin preparations; bacterial preparations for medical and veterinary use; dietetic substances adapted for medical use, medicinal oils; food for babies, plasters, dressing materials; teeth filling and dental impression materials; disinfectants; biologically active additives; lotions for pharmaceutical purposes; nutritional supplements; radioactive substances for medical purposes; nutritive substances for microorganisms; cachets for pharmaceutical purposes.

(260) AM 2014 71263 A

(800) 1149468

(151) 2012 12 19

(731) Elfona Holdings LTD
Arch. Makariou III, 155, Proteas House,
5th floor, CY-3026 Limassol, Cyprus

(540)



(591) Brown, light brown, green and yellow

(511)

30 – Coffee; artificial coffee; coffee flavorings [flavourings]; coffee beverages with milk; coffee-based beverages.

43 – Services for providing food and drink, including snack-bars, cafés, cafeterias.

(260) AM 2014 71264 A
 (800) 1149502
 (151) 2012 12 28
 (731) Kalisto Business Corp.
 P.O. 3321, Drake Chambers, Road Town,
 Tortola, British Virgin Islands
 (540)



(591) Red and white
 (511)
 18 – Leather and imitations of leather, and goods made of these materials and not included in other classes; chamois leather, other than for cleaning purposes; imitation leather; leather, unworked or semi-worked; leatherboard; moleskin (imitation of leather); leather thread.
 24 – Fabrics for textile use; non-woven textile fabrics; textile material; moleskin (fabric); fabric for footwear; adhesive fabric for application by heat; lining fabric for shoes; fabric of imitation animal skins.
 35 – Demonstration of goods; commercial information and advice for consumers; presentation of goods on communication media, for retail purposes; sales promotion for others, including retail shop services; procurement services for others.

(260) AM 2014 71265 A
 (800) 1149505
 (151) 2013 01 23
 (731) Société des Produits Nestlé S.A.
 CH-1800 Vevey, Switzerland
 (540)

STORMIO

(591) Black, white
 (511)
 30 – Coffee, coffee extracts, coffee-based beverages and preparations; iced coffee; artificial coffee, artificial coffee extracts, artificial coffee-based beverages and preparations; chicory (coffee substitute); tea, tea extracts, tea-based beverages and preparations; iced tea; cocoa and cocoa-based beverages and preparations; chocolate, chocolate products, chocolate-based beverages and preparations; sugar; biscuits.

(260) AM 2014 71266 A
 (800) 1149506
 (151) 2013 01 23
 (731) Société des Produits Nestlé S.A.
 CH-1800 Vevey, Switzerland
 (540)

ODACIO

(591) Black, white
 (511)
 30 – Coffee, coffee extracts, coffee-based beverages and preparations; iced coffee; artificial coffee, artificial coffee extracts, artificial coffee-based beverages and preparations; chicory (coffee substitute); tea, tea extracts, tea-based beverages and preparations; iced tea; cocoa and cocoa-based beverages and preparations; chocolate, chocolate products, chocolate-based beverages and preparations; sugar; biscuits.

(260) AM 2014 71267 A
 (800) 1149507
 (151) 2013 01 23
 (731) Société des Produits Nestlé S.A.
 CH-1800 Vevey, Switzerland
 (540)

MELOZIO

(591) Black, white
 (511)
 30 – Coffee, coffee extracts, coffee-based beverages and preparations; iced coffee; artificial coffee, artificial coffee extracts, artificial coffee-based beverages and preparations; chicory (coffee substitute); tea, tea extracts, tea-based beverages and preparations; iced tea; cocoa and cocoa-based beverages and preparations; chocolate, chocolate products, chocolate-based beverages and preparations; sugar; biscuits.

(260) AM 2014 71268 A
 (800) 1149508
 (151) 2013 01 23
 (731) Société des Produits Nestlé S.A.
 CH-1800 Vevey, Switzerland
 (540)

DIAVOLITTO

(591) Black, white
 (511)
 30 – Coffee, coffee extracts, coffee-based beverages and preparations; iced coffee; artificial coffee, artificial coffee extracts, artificial coffee-based beverages and preparations; chicory (coffee substitute); tea, tea extracts, tea-based beverages and preparations; iced tea; cocoa and cocoa-based beverages and preparations; chocolate, chocolate products, chocolate-based beverages and preparations; sugar; biscuits.

(260) AM 2014 71269 A
 (800) 1149509
 (151) 2013 01 23
 (731) Société des Produits Nestlé S.A.
 CH-1800 Vevey, Switzerland
 (540)

VOLTESSO

(591) Black, white
 (511)
 30 – Coffee, coffee extracts, coffee-based beverages and preparations; iced coffee; artificial coffee, artificial coffee extracts, artificial coffee-based beverages and preparations; chicory (coffee substitute); tea, tea extracts, tea-based beverages and preparations; iced tea; cocoa and cocoa-based beverages and preparations; chocolate, chocolate products, chocolate-based beverages and preparations; sugar; biscuits.

(260) AM 2014 71270 A
 (800) 1149510
 (151) 2013 01 23
 (731) Société des Produits Nestlé S.A.
 CH-1800 Vevey, Switzerland
 (540)

ELVAZIO

(591) Black, white
 (511)
 30 – Coffee, coffee extracts, coffee-based beverages and preparations; iced coffee; artificial coffee, artificial coffee extracts, artificial coffee-based beverages and preparations; chicory (coffee substitute); tea, tea extracts, tea-based beverages and preparations; iced tea; cocoa and cocoa-based beverages and preparations; chocolate, chocolate products, chocolate-based beverages and preparations; sugar; biscuits.

(260) AM 2014 71332 A
 (800) 1150128
 (151) 2013 01 23
 (731) Société des Produits Nestlé S.A.
 CH-1800 Vevey, Switzerland
 (540)

HAZELINO

(591) Black, white
 (511)
 30 – Coffee, flavored coffee, coffee extracts, coffee-based beverages and preparations; iced coffee; artificial coffee, artificial coffee extracts, artificial coffee-based beverages and preparations; chicory (coffee substitute); tea, tea extracts, tea-based beverages and preparations; iced tea; cocoa and cocoa-based beverages and preparations.

(260) AM 2014 71563 A
 (800) 1151877
 (151) 2013 02 08
 (731) Japan Tobacco Inc.
 2-2-1 Toranomom, Minato-ku, Tokyo, Japan
 (540)



(591) Black, white
 (511)
 34 – Cigarettes.

(260) AM 2014 71583 A
 (800) 1151924
 (151) 2012 05 23
 (731) WORLD MEDICINE İLAÇLARI LİMİTED
 ŞİRKETİ
 Evren Mah., Camiyolu Cad. No.50 K.2,
 GÜNEŞLİ/BAĞCILAR/İSTANBUL, Turkey
 (540)



(591) Blue, red, white
 (511)
 3 – Bleaching preparations and other substances for laundry use; perfumery, cosmetics, essential oils for personal use, soaps, dental care products, abrasive products; emery clothes, emery papers, emery powders and pastes, pumice stones and abrasive pastes.
 5 – Medicines for human purposes, medicines for veterinary purposes, chemical preparations for medical purposes, dietetic substances adapted for medical use; dietetic foods adapted for medical purposes; aminoacids for medical purposes, nutritional substances, pollen dietary substances, mineral food substances, protein dietary supplements, baby foods, medicinal herbs, herbal beverages adapted for medical purposes; medicines for dental purposes, hygienic products for medical purposes including pads, wadings for medical purposes, plasters for medical purposes, dressings for medical purposes, preparations for destroying noxious plants, preparations for destroying noxious animals, fungicides, deodorants other than for personal use, disinfectants for hygiene purposes, antiseptics, detergents for medical purposes.

10 – Surgical, medical, dental and veterinary apparatus and instruments; artificial limbs, eyes and teeth and prosthesis; orthopedic articles; suture materials and sterilized covers; devices and equipments for sexual purposes; preservatives (condom); feeding bottles, baby bottles, teethers for babies.

31 – Agricultural products, horticultural products and seeds, fruits and vegetables, forestry products included in this class, live animals (including eggs for incubation, fertilized eggs), live and dried plants and herbs, fodders and non-medical additives to fodders, malt (not for human consumption).

35 – Services related to advertising, marketing and public relations including organization of exhibitions and fairs for commercial or advertising purposes, office services, business management and administration, consultancy for business management and administration including accountancy services, import export agency services, commercial and industrial management expertise services, organization of auctioneering services and auctioneering; the bringing together of bleaching preparations and other substances for laundry use, perfumery, cosmetics, essential oils for personal use, soaps, dental care products, abrasive products, emery clothes, emery papers, emery powders and pastes, pumice stones and abrasive pastes, medicines for human purposes, medicines for veterinary purposes, chemical preparations for medical purposes, dietetic substances adapted for medical use, dietetic foods adapted for medical purposes; aminoacids for medical purposes, nutritional substances, pollen dietary substances, mineral food substances, protein dietary supplements, baby foods, medicinal herbs, herbal beverages adapted for medical purposes, medicines for dental purposes, hygienic products for medical purposes including pads, waddings for medical purposes, plasters for medical purposes, dressings for medical purposes, preparations for destroying noxious plants, preparations for destroying noxious animals, fungicides, deodorants other than for personal use, disinfectants for hygiene purposes, antiseptics, detergents for medical purposes, surgical, medical, dental and veterinary apparatus and instruments, artificial limbs, eyes and teeth and prosthesis, orthopedic articles, suture materials and sterilized covers, devices and equipments for sexual purposes, preservatives (condom), feeding bottles, baby bottles, teethers for babies, agricultural products, horticultural products and seeds, fruits and vegetables, forestry products included in this class, live animals (including eggs for incubation, fertilized eggs), live and dried plants and herbs, fodders and non medical additives to fodders, malt (not for human consumption), enabling customers to conveniently view and purchase those goods (the mentioned services can be provided by wholesale, retail, electronic media, catalogues and alike other methods).

44 – Medical services; hygienic and beauty care for human beings; veterinary services, agriculture, horticulture and forestry services, services of a nursing home.

(260) AM 2014 71740 A

(800) 1152739

(151) 2012 11 05

(731) Vegapharm LLP

Intershore Suites Vernon House,
Sicilian Avenue London WC1A 2QS,
United Kingdom

(540)

VERABEZ
ВЕРАБЕЗ

(591) Black, white

(511)

5 – Pharmaceutical and veterinary preparations; sanitary preparations for medical purposes; dietetic substances adapted for medical use, food for babies; plasters, materials for dressings; material for stopping teeth, dental wax; disinfectants; preparations for destroying vermin; fungicides, herbicides; foods and beverages which are adapted for medical purposes; air deodorising preparations.

(260) AM 2014 71741 A

(800) 1152740

(151) 2012 11 05

(731) Vegapharm LLP

Intershore Suites Vernon House,
Sicilian Avenue London WC1A 2QS,
United Kingdom

(540)

SECNIRON
СЕКНИРОН

(591) Black, white

(511)

5 – Pharmaceutical and veterinary preparations; sanitary preparations for medical purposes; dietetic substances adapted for medical use, food for babies; plasters, materials for dressings; material for stopping teeth, dental wax; disinfectants; preparations for destroying vermin; fungicides, herbicides; foods and beverages which are adapted for medical purposes; air deodorising preparations.

- (260) AM 2014 71743 A
 (800) 1152766
 (151) 2012 12 13
 (731) Fresh Catch Limited
 Kirk Square, Peterhead, Aberdeenshire
 AB42 1RQ, United Kingdom
 (540)



- (591) Blue, white
 (511)
 29 – Fish (none being live); fresh fish; frozen fish; processed fish; fresh seafood; frozen seafood; processed seafood; mackerel; graded whole round mackerel; headed and gutted mackerel; machine cut mackerel fillets; single cut mackerel fillets; mackerel flaps; mackerel pieces; horse mackerel; herring; graded whole herring; graded herring flaps; herring singles; skinless herring fillets and pieces; deli herring; marinated herring; white fish; black halibut; j-cut black halibut; straight cut black halibut; whole round black halibut; cod; skinless and boneless cod fillets; skinless and boneless cod portions; skinless and boneless haddock fillets; skinless and boneless haddock portions; skinless and boneless saithe fillets; skinless and boneless saithe portions; scallops; salmon portions; prawns; shrimp.

- (260) AM 2014 71744 A
 (800) 1152753
 (151) 2012 12 18
 (731) TRANSTECH RESEARCH PTY LTD
 346 Boundary Road, Derrimut VIC 3030,
 Australia
 (540)



- (591) Black, white
 (511)
 12 – Land vehicles, load carrying apparatus and appliances, cargo handling equipment, vehicle bodies of all kinds included in this class, side curtains for road transport vehicles, particularly trailers; trailers, including skeletal trailers, flat top trailers, flat bed trailers, curtain sided trailers, flexiliners, tankers and other trailers for the carriage of goods, and bodies, including flat top, flat bed, curtain, sided and other types, being capable of mounting on truck chassis; rail vans; transport vehicles including trucks and trailers, semi-trailer vehicles, container freight vehicles, articulated trailers, refrigerated and dry freight pantechnicons, shipping and rail containers, fre-

ight containers; bodies for freight-carrying vehicles and containers, including truck, trailer and semitrailer bodies; load restraint systems for trucks, trailers and semi-trailers, vehicle trailers; transport trailers; suspension apparatus for trailers; supports for trailers (legs and dolly wheels); load carrying trailers; freight carrying vehicles; bodies for freight carrying motor vehicles; trains (vehicles); tippers (lorries); tipping apparatus for trailers; tipping apparatus for vehicles; tipping bodies for trucks; tipping bodies for vehicles; side tipping semi-trailers; transport trailers; vehicle trailers; semi-trailers; road trailers and off-road trailers; refrigerated trailers; load carrying trailers; fifth wheel connectors for road trailers; landing gear and apparatus for truck trailers; road trains and other combinations of several trailers towed as a group; parts and accessories therefore in this class.

- (260) AM 2014 71745 A
 (800) 1152782
 (151) 2013 01 03
 (731) PlayLot Limited
 Trident Chambers, Road Town, Tortola,
 British Virgin Islands
 (540)

PlayLot

- (591) Black, white
 (511)
 9 – Computer software for operating, managing, monitoring and supervising lottery, including online lottery, lottery through computerized land based machines and traditional lottery; computer software for support of processing payment in connection with lottery, including online lottery, lottery through computerized land based machines and traditional lottery; computer software for providing remote access to lottery land based machines; computer software for providing remote access to lottery operated online.

42 – Design and development of software in the field of lottery; installation, maintenance, upgrade and repair of software in the field of lottery.

- (260) AM 2014 71747 A
 (800) 1152810
 (151) 2013 01 16
 (731) KRKA, tovarna zdravil, d.d., Novo mesto
 Šmarješka cesta 6, SI-8501 Novo mesto,
 Slovenia
 (540)

ATORDAPIN

- (591) Black, white
 (511)
 5 – Pharmaceutical preparations.

(260) AM 2014 71749 A

(800) 1152893

(151) 2012 07 18

(731) BTA HAVA LİMANLARI YİYECEK VE
İÇECEK HİZMETLERİ ANONİM ŞİRKETİ
Atatürk Havalimanı Dış Hatlar, Terminali
PK.44, Yeşilköy İSTANBUL, Turkey

(540)

GRAB&GO

(591) Black, white

(511)

35 – Advertising, marketing and public relations, and related services (including organization of exhibitions and fairs for commercial and advertising purposes); office services; business management, administration and consultancy on these issues, book-keeping and accounting services, drawing up of statements of accounts and import-export agency services; commercial and industrial management assistance; arranging and conducting of auctions; retail services for, bleaching and cleaning substances, perfumery, cosmetic products, for personal use flavorings (including deodorants for humans and animals), soaps, dental care products, abrasive products (abrasive cloth, abrasive paper, pumice stones, abrasives, including cakes), polishing and maintenance products (for leather, vinyl, metal, wood etc), personal care appliances and instruments used for beauty purposes including shaving, epilation, manicure, pedicure, (electric hair straighteners and crimpers, including scissors), magnetic, optical recording carriers and their recorded computer programs and software, electronic publications that can be downloaded and recorded on magnetic and optical media through computer networks, magnetic/optical reader cards, printed documents, printed publications, calendars, posters, photographs, posters, charts, stickers (stamps), stationery, office, educational and teaching materials (except furniture and appliances), games and toys (including inflatable toys used during bath or swimming), saloon games, instruments, machinery and equipments for games that may be operated with an external screen or monitor (including the ones that are operated with coins), toys for animals, toys for playgrounds and parks, gymnastics and sports apparatus and materials, artificial Christmas trees and decorations, artificial snow, bells, entertainment (party, disco, etc) decorations, party hats, tobacco and tobacco products, smoker's articles (including pipes, cigar and cigarette holders, ashtrays, tobacco boxes, mobile devices to wrap cigarettes, cigarette papers, hookahs, flint, lighters), matches, (specified services may be provided through retail, wholesale stores, electronic media, catalogs and other similar methods.

43 – Providing food and drink services; temporary accommodation services (day care (nursery) services); boarding of animals.

(260) AM 2014 71750 A

(800) 1152940

(151) 2013 01 23

(731) Schöffel Sportbekleidung GmbH
Ludwig-Schöffel-Strasse 15, 86830
Schwabmünchen, Germany

(540)

VENTLOFT BY SCHÖFFEL

(591) Black, white

(511)

9 – Bags adapted to carry mobile phones and tablet computers.

18 – Rucksacks; bags.

24 – Blankets, including quilts; pillowcases.

25 – Clothing, in particular outdoor and functional clothing, included in this class; gloves, including ski gloves and mittens; footwear, including slippers and slipper socks as well as wadded foot lets; headgear.

(260) AM 2014 71751 A

(800) 1152942

(151) 2013 01 30

(731) SILHOUETTE International Schmied AG
Ellbognerstr. 24, A-4020 Linz, Austria

(540)

LiteStyle

(591) Black, white

(511)

9 – Optical apparatus and instruments, in particular ophthalmological apparatus; spectacles, in particular optical glasses, sunglasses, sports spectacles, safety goggles, glasses provided with decorative elements; glasses frames, rims for glasses and arms and bars for glasses; glasses frames, rims for glasses and arms and bars for glasses, all being provided with decorative elements; optical spectacles and sunglasses whose frames are manufactured of metal or a combination of metal and plastics; rims for glasses, bars for glasses, arms for glasses and glasses frames, manufactured from metal or from a combination of metal and plastic; spectacle chains, in particular chains for glasses, provided with decorative elements; spectacle lenses; contact lenses, optical lenses; optical goods, opticians' goods of plastic; optical glass; containers and cases for all the aforesaid goods.

18 – Leather and imitations of leather, and goods made of these materials and not included in other classes; trunks and travelling bags; umbrellas, parasols, and walking sticks; bags, especially handbags, key cases (leatherware), beauty cases.

42 – Industrial design; providing technical expertise and documentation, research in the optics field, in particular in the field of lenses and glasses and in the field of materials for making optical devices, apparatus and instruments, in particular for making ophthalmic apparatus, and glasses and rims for glasses.

(260) AM 2014 71752 A
 (800) 1152946
 (151) 2012 12 19
 (731) Unitary Enterprise "Green plant"
 Komnata No. 19, administrativnoe
 pomeshchenie Pyatnitskogo A.L., rayon
 derevni Uglyany, 223045 Minskiy rayon,
 Minskaya oblast, Belarus

(540)

Green plant

(591) Black, white

(511)

19 – Door casings, not of metal; beams, not of metal; joists, not of metal; doors, not of metal; folding doors, not of metal; wood for making household utensils; veneer wood; moldable wood; framework, not of metal, for building; cornices, not of metal; buildings, not of metal; manufactured timber; sawn timber; wood, semi-worked; moldings, not of metal, for cornices; moldings, not of metal, for building; wood panelling; partitions, not of metal; lintels, not of metal; planks [wood for building]; tarred strips, for building; door panels, not of metal; sills, not of metal; scantlings [carpentry]; wood veneers.

20 – Wood ribbon; door fittings, not of metal.

35 – Demonstration of goods; commercial information and advice for consumers [consumer advice shop]; professional business consultancy; presentation of goods on communication media, for retail purposes; sales promotion for others; distribution of samples; dissemination of advertising matter.

(260) AM 214 71753 A

(800) 1152947

(151) 2012 12 19

(731) Unitary Enterprise "Green plant"
 Komnata No. 19, administrativnoe
 pomeshchenie Pyatnitskogo A.L., rayon
 derevni Uglyany, 223045 Minskiy rayon,
 Minskaya oblast, Belarus

(540)



(591) Green and black

(511)

19 – Door casings, not of metal; beams, not of metal; joists, not of metal; doors, not of metal; folding doors, not of metal; wood for making household utensils; veneer wood; moldable wood; framework, not of metal, for building; cornices, not of metal; buildings, not of metal; manufactured timber; sawn timber; wood, semi-worked; moldings, not of metal, for cornices; moldings, not of metal, for building; wood panelling; partitions, not of metal; lintels, not of metal; planks [wood for building]; tarred strips,

for building; door panels, not of metal; sills, not of metal; scantlings [carpentry]; wood veneers.

20 – Wood ribbon; door fittings, not of metal.

35 – Demonstration of goods; commercial information and advice for consumers [consumer advice shop]; professional business consultancy; presentation of goods on communication media, for retail purposes; sales promotion for others; distribution of samples; dissemination of advertising matter.

(260) AM 2014 71754 A

(800) 1152973

(151) 2013 02 14

(731) MBG Holding GmbH

Oberes Feld 13, 33106 Paderborn, Germany

(540)

Acqua Morelli

(591) Black, white

(511)

32 – Mineral water.

(260) AM 2014 71755 A

(800) 1153007

(151) 2013 01 29

(731) cobenu Ltd.

Unit 117, Orion Mall, Palm Street, PO Box

828, Victoria, Mahé, Seychelles

(540)

SXRG

(591) Black, white

(511)

5 – Mineral food supplements; vitamin preparations.

25 – Clothing; footwear; headgear; belts; bath robes.

32 – Non-alcoholic beverages; powders for effervescent beverages; pastilles for effervescent beverages; aerated water; preparations for making beverages; mineral water; isotonic beverages; beer.

(260) AM 2014 71756 A

(800) 1153008

(151) 2013 02 08

(731) Bayer Aktiengesellschaft

Kaiser-Wilhelm-Allee, 51373 Leverkusen,

Germany

(540)

Эйлеа

(591) Black, white

(511)

5 – Pharmaceutical preparations.

(260) AM 2014 71757 A
 (800) 1153024
 (151) 2012 12 20
 (731) MARAZZI GROUP S.p.A.
 Viale Virgilio, 30, I-41123 MODENA,
 Italy

(540)

MARAZZI LIVING

(591) Black, white
 (511)
 11 – Sanitary apparatus and installations; sinks; bath
 tubs; bidets; wash-hand basins; water closets; sho-
 wers and shower cubicles; taps and fittings.

19 – Non metallic building materials; wall and floor
 covering materials; ceramic tiles.

20 – Bathroom furniture including washstands, toilet
 cabinets, furniture shelves, counter tops and mirrors.

35 – Services consisting of the bringing together, for
 the benefit of others, of a variety of goods (exclu-
 ding the transport thereof), enabling customers to
 conveniently view and purchase those goods; adver-
 tising; business management.

(260) AM 2014 71760 A
 (800) 1153051
 (151) 2012 12 19
 (731) British American Tobacco (Brands) Limited
 Globe House, 4 Temple Place, London
 WC2R 2PG, United Kingdom

(540)

iAMP

(591) Black, white
 (511)
 34 – Cigarettes; tobacco; tobacco products; lighters
 for smokers; matches; smokers' articles.

(260) AM 2014 71761 A
 (800) 1153082
 (151) 2013 02 22
 (731) Becton, Dickinson and Company
 1 Becton Drive, MC 090 Franklin Lakes,
 NJ 07417, USA

(540)

FACSVia

(591) Black, white
 (511)
 9 – Laboratory instruments, namely, flow cytome-
 ters and computer software therefor.

(260) AM 2014 71763 A
 (800) 699851
 (151) 1998 09 10
 (891) 2013 02 07
 (731) Unilever N.V.
 Weena 455, NL-3013 AL Rotterdam,
 Netherlands

(540)

FRUTTARE

(591) Black, white
 (511)
 30 – Edible ices.

(260) AM 2014 71764 A
 (800) 701123
 (151) 1998 09 08
 (891) 2013 01 30
 (731) Boehringer Ingelheim Pharma GmbH & Co.
 KG
 55218 Ingelheim, Germany

(540)

FINALGEL

(591) Black, white
 (511)
 5 – Pharmaceutical preparations.

(260) AM 2014 71767 A
 (800) 725863
 (151) 2000 01 17
 (891) 2012 11 13
 (731) MAGIN INTO GIYIM SANAYI VE
 TICARET LIMITED ŞİRKETİ
 Eski Edirne Asfaltı No. 38, İSTANBUL,
 Turkey

(540)



(591) Black, white
 (511)
 25 – Underwear, clothing, headgear, footwear.

(260) AM 2014 71774 A
 (800) 917635
 (151) 2007 01 10
 (891) 2012 11 28
 (731) KANAAT TRIKO KONFEKSIYON
 SANAYI VE TICARET LIMITED
 SIRKETI Numunebağ Caddesi No. 7,
 BAYRAMPAŞA – İSTANBUL, Turkey

(540)

FELICITA

(591) Black, white
 (511)
 25 – Clothing, footwear, headgear.

(260) AM 2014 71775 A
 (800) 930061
 (151) 2007 06 18
 (891) 2013 01 25
 (731) Ningbo Jiejie Tools Co., Ltd.
 Industrial Park, Zhuangshi Road, Zhenhai
 District, Ningbo, China

(540)

FIXMAN

(591) Black, white
 (511)
 6 – Chest of metal; tool boxes of metal (empty); tool chest of metal (empty); packaging containers of metal; boxes of common metal; tanks of metal; container of metal (storage, transport); pipes of metal; preserve tins.
 8 – Garden tools (hand-operated); saws (hand tools); spanners (hand tools); screw-thread cutters (hand tools); hand tools, hand operated; gimlet (hand tools); pliers; scraper tools (hand tools); tool belts (holder); pruning knives

(260) AM 2014 71776 A
 (800) 936263
 (151) 2007 08 31
 (891) 2013 01 18
 (731) Novartis AG
 CH-4002 Basel, Switzerland

(540)

JAKAVI

(591) Black, white
 (511)
 5 – Pharmaceutical preparations, vaccines, pharmaceutical preparations for diagnostic use.

(260) AM 2014 71777 A
 (800) 990922
 (151) 2008 11 04
 (891) 2012 12 21
 (731) ZHEJIANG GACIA ELECTRICAL
 APPLIANCE CO., LTD.
 No. 545 Dongjie, Beibaixiang,
 Baitawang Industrial Zone, Yueqing,
 325603 Zhejiang, China

(540)

GACIA

(591) Black, white
 (511)
 9 – Plugs, sockets and other contacts (electric connections); circuit breakers; switches, electric; fuses; voltage surge protectors; material for electricity mains (wires, cables); relays, electric; signal lanterns; watt-hour meters; coils, electric.

(260) AM 2014 71778 A
 (800) 1095662
 (151) 2011 09 15
 (891) 2013 01 18
 (731) AKEBONO BRAKE INDUSTRY CO., LTD.
 19-5, Nihonbashi Koami-cho, Chuo-ku,
 Tokyo 103-8534, Japan

(540)

AKEBONO

(591) Black, white
 (511)
 7 – Brakes (machine elements not for land vehicles).
 12 – Railway rolling stock and their parts and fittings, automobiles and their parts and fittings, two-wheeled motor vehicles and their parts and fittings, bicycles and their parts and fittings, brakes (for land vehicles).

(260) AM 2014 71787 A
 (800) 1135387
 (151) 2012 03 28
 (891) 2012 01 25
 (731) The British Council
 10 Spring Gardens, London SW1A 2BN,
 United Kingdom

(540)

APTIS

(591) Black, white
 (511)
 41 – Educational services; provision of instructional, training, teaching, testing, examination and student assessment services; provision of interactive and distance learning courses; publication of instructional, training, teaching, testing, examination and student assessment materials, including examination papers and syllabuses and materials for the testing of english language skills; testing of english language skills; information, advisory and consultancy services relating to all the aforesaid services.

(260) AM 2014 71788 A
 (800) 1135497
 (151) 2012 08 16
 (891) 2013 02 01
 (731) MI-NY S.R.L.
 Via Friuli, 3, I-24052 AZZANO SAN
 PAOLO (BG), Italy

(540)

mi-ny
 beauty

(591) Black, white
 (511)
 3 – Bleaching preparations and other substances for laundry use; cleaning, polishing, scouring and abra-

sive preparations; soaps; perfumery, essential oils, cosmetics, hair lotions; dentifrices.

(260) AM 2014 71891 A

(800) 1153660

(151) 2012 11 05

(731) Vegapharm LLP

Intershore Suites Vernon House, Sicilian
Avenue London WC1A 2QS,
United Kingdom

(540)

Vegaflox
Вегафлокс

(591) Black, white

(511)

5 – Pharmaceuticals or medical products for human use.

(260) AM 2014 71892 A

(800) 1153662

(151) 2012 11 22

(731) Dunhill Tobacco of London Limited

Globe House, 4 Temple Place, London,
WC2R 2PG, United Kingdom

(540)

DUNHILL CLASSIC BLEND

(591) Black, white

(511)

34 – Cigarettes, cigars, cigarillos, hand-rolling tobacco, pipe tobacco and tobacco products.

(260) AM 2014 71896 A

(800) 1153670

(151) 2012 12 21

(731) ALTHEIA

2 place de Touraine, F-78000 VERSAILLES,
France

(540)



(591) Medium blue, dark blue and light blue

(511)

35 – Advertising; business management; business administration; office functions; direct mail advertising (leaflets, prospectuses, printed matter, samples); arranging newspaper subscriptions (for others); arranging subscriptions to telecommunication services for others; presentation of goods on communication media, for retail purposes; business management and organization consultancy; accounting; document reproduction; employment agencies;

computerized file management; organization of exhibitions for commercial or advertising purposes; on-line advertising on a computer network; rental of advertising time on all communication media; publication of advertising texts; rental of advertising space; dissemination of advertisements; public relations.

38 – Telecommunications; telecommunication information; communications by computer terminals or by fiber-optic networks; communications by radio or telephone; cellular telephone communication services; provision of user access to global computer networks; providing chat forums on the Internet; providing access to databases; electronic bulletin board services (telecommunication services); provision of telecommunication connections to a global computer network; news agencies; rental of telecommunication apparatus; radio or television programs (broadcasts); teleconferencing services; electronic messaging services; rental of access time to global computer networks.

42 – Evaluations, assessments and research in the fields of science and technology provided by engineers; design and development of computers and software; research and development of new products for others; technical project study; architecture; design of interior decor; development (design), installation, maintenance, updating or rental of software; computer programming; computer system analysis; computer system design; consultancy relating to computers; conversion of computer programs and data [not physical conversion]; conversion of data or documents from physical to electronic media; vehicle roadworthiness testing; graphic arts designing services; styling (industrial design); authentication of works of art.

(260) AM 2014 71897 A

(800) 1153690

(151) 2013 02 01

(731) Publichne aktsionerne tovarystvo

"Kharkivska biskvitna fabryka"

vul. Lozivska, 8, Kharkiv 61017, Ukraine

(540)

ВЫДУМКА
ВИДУМКА

(591) Black, white

(511)

30 – Sponge cakes; cookies; buns; waffles; confectionery; pastries; confectionery for decorating Christmas trees; fruit jellies (confectionery); cakes; peanut confectionery; almond confectionery; pies; cocoa; cocoa products; caramels (candy); sweetmeats (candy); liquorice (confectionery); peppermint sweets; crackers; candy; marzipan; custard; pastilles (confectionery); lozenges (confectionery); petits

fours (cakes); biscuits; fondants (confectionery); popcorn; pralines; gingerbread; puddings; cake powder; sugar; sweet paste for cakes, pies, cookies, buns, gingerbread, puddings; sweets (confectionery); rusks; sandwiches; tarts; candy decorations for cakes; chocolate decorations for cakes; halvah; chips (cereal products); chocolate.

(260) AM 2014 71898 A

(800) 1153738

(151) 2013 02 01

(731) Apple Inc.

1 Infinite Loop, Cupertino, CA 95014, USA

(540)

COCOA

(591) Black, white

(511)

9 – Computer programming software for use as an advanced object oriented programming tool and manuals sold therewith.

(260) AM 2014 71899 A

(800) 1153759

(151) 2012 10 26

(731) MANIFATTURA MARIO COLOMBO & C.
S.P.A.

Via Olimpia, 3, I-20900 MONZA (MB), Italy

(540)



(591) White, red and blue

(511)

18 – Leather and imitations of leather, and goods made of these materials and not included in other classes; animal skins, hides; trunks and travelling bags; umbrellas and parasols; walking sticks; whips, harness and saddlery; clothing for pets; umbrella rings; saddle trees; saddlery; key cases; fastenings for saddles; bandoliers; harness for animals; alpenstocks; walking sticks; umbrella sticks; vanity cases, not fitted; trunks [luggage]; travelling trunks; sling bags for carrying infants; bags for sports; chain mesh purses; tool bags of leather, empty; purses; travelling sets [leatherware]; bridles [harness]; bridoons; gut for making sausages; straps for soldiers' equipment; kid; game bags [hunting accessories]; briefcases; school bags; leatherboard; cases, of leather or leatherboard; halters; bands of leather; collars for animals; horse collars; coverings of skins [furs]; horse blankets; leather laces; leather straps; straps of leather [saddlery]; harness straps; straps for skates;

leather, unworked or semi-worked; horseshoes; leather twist; moleskin [imitation of leather]; umbrella covers; whips; knee-pads for horses; casings, of leather, for springs; covers for horse-saddles; pads for horse saddles; trimmings of leather for furniture; harness fittings; leather leads; imitation leather; walking cane handles; umbrella handles; suitcase handles; slings for carrying infants; pouch baby carriers; cat o' nine tails; chin straps, of leather; bits for animals [harness]; muzzles; parasols; blinders [harness]; umbrellas; pelts; cattle skins; curried skins; chamois leather, other than for cleaning purposes; fur; gold beaters' skin; parts of rubber for stirrups; card cases [notecases]; music cases; pocket wallets; reins; net bags for shopping; handbags; furniture coverings of leather; haversacks; nose bags [feed bags]; pouches, of leather, for packaging; bags for campers; beach bags; travelling bags; bags for climbers; shopping bags; wheeled shopping bags; boxes of leather or leather board; boxes of vulcanised fibre; hat boxes of leather; butts [parts of hides]; walking stick seats; riding saddles; stirrups; stirrup leathers; umbrella or parasol ribs; frames for umbrellas or parasols; handbag frames; traces [harness]; valises; suitcases; attaché cases; garment bags for travel; valves of leather; backpacks.

25 – Clothing, footwear, headgear; clothing of imitations of leather; clothing of leather; motorists' clothing; cyclists' clothing; clothing for gymnastics; dresses; dressing gowns; bath robes; non-slipping devices for footwear; clothing; bandanas [neckerchiefs]; bibs, not of paper; caps [headwear]; berets; underwear; anti-sweat underwear; smocks; boas [necklets]; teddies [undergarments]; suspenders; studs for football boots; corsets [underclothing]; galoshes; skull caps; footwear; boots for sports; stockings; sweat-absorbent stockings; slippers; socks; breeches for wear; short-sleeve shirts; shirts; stuff jackets [clothing]; bodices [lingerie]; hats; top hats; paper hats [clothing]; coats; hoods [clothing]; hat frames [skeletons]; footmuffs, not electrically heated; belts [clothing]; money belts [clothing]; tights; shoulder wraps; detachable collars; camisoles; headgear for wear; collar protectors; ear muffs [clothing]; layettes [clothing]; corselets; suits; beach clothes; masquerade costumes; neckties; ascots; bathing caps; shower caps; headbands [clothing]; pocket squares; scarfs; fittings of metal for footwear; ready-made linings [parts of clothing]; gabardines [clothing]; spats; jackets [clothing]; fishing vests; garters; skirts; jumper dresses; aprons [clothing]; girdles; gloves [clothing]; mittens; ski gloves; welts for footwear; waterproof clothing; ready-made clothing; paper clothing; knitwear [clothing]; jerseys [clothing]; leg warmers; leggings [trousers]; liveries; singlets; hosiery; swimsuits; sweaters; muffs [clothing]; maniples; pelerines; mantillas; sleep masks; skorts; miters [hats]; pants; bathing trunks; vests; babies' pants [clothing]; trousers; parkas; pelisses; furs [clothing]; shirt

yokes; chasubles; pyjamas; cuffs; ponchos; pull-overs; tips for footwear; stocking suspenders; sock suspenders; brassieres; heelpieces for footwear; heelpieces for stockings; sandals; bath sandals; saris; sarongs; shoes; esparto shoes or sandals; bath slippers; gymnastic shoes; beach shoes; football boots; sports shoes; ski boots; shawls; sashes for wear; underpants; lace boots; wimples; topcoats; outerclot-ting; dress shields; gaiter straps; petticoats; slips [undergarments]; shirt fronts; half-boots; boots; fur stoles; soles for footwear; inner soles; heels; pockets for clothing; tee-shirts; togas; footwear uppers; boot uppers; turbans; wet suits for water-skiing; combina-tions [clothing]; uniforms; veils [clothing]; cap peaks; wooden shoes.

28 – Games and playthings; gymnastic and sporting articles not included in other classes; decorations for Christmas trees; Christmas trees of synthetic mate-rial; masts for sailboards; swings; fish hooks; tennis ball throwing apparatus; apparatus for games; body-building apparatus; appliances for gymnastics; conj-uring apparatus; video game machines; kites; bows for archery; fencing weapons; fishing tackle; ascen-ders [mountaineering equipment]; ski bindings; arch-ery implements; machines for physical exercises; divot repair tools [golf accessories]; swimming pools [play articles]; dolls; Christmas tree stands; golf clubs; hockey sticks; twirling batons; targets; electronic targets; stationary exercise bicycles; mar-bles for games; skittles; ninepins; starting blocks for sports; building blocks [toys]; playing balls; body boards; soap bubbles [toys]; cricket bags; golf bags, with or without wheels; gut for rackets; cups for dice; kaleidoscopes; bladders of balls for games; dolls' rooms; bells for Christmas trees; rods for fish-ing; paper party hats; detonating caps [toys]; caps for pistols [toys]; playing cards; dolls' houses; roc-king horses; chips for gambling; swimming belts; surfboard leashes; weight lifting belts [sports arti-cles]; cosaques [toy fireworks]; strings for rackets; confetti; gut for fishing; dice; ornaments for Chris-mas trees, except illumination articles and confec-tionery; hang gliders; discuses for sports; flying discs [toys]; billiard markers; artificial fishing bait; lures for hunting or fishing; exercisers [expanders]; horseshoe games; sling shots [sports articles]; hun-ting game calls; darts; harpoon guns [sports articles]; water wings; floats for fishing; chalk for billiard cues; counters [discs] for games; toys; toys for do-mestic pets; rattles [playthings]; games; amusement machines, automatic and coin-operated; board gam-es; ring games; building games; checkers [games]; dominoes; chess games; parlor games; portable gam-es with liquid crystal displays; pachinkos; fairg-round ride apparatus; snow globes; scratch cards for playing lottery games; gloves for games; baseball gloves; golf gloves; fencing gauntlets; batting gloves [accessories for games]; boxing gloves; bob-sleighs; protective paddings [parts of sports suits]; climbers'

harness; harness for sailboards; scale model kits [toys]; lines for fishing; dolls' beds; bowling appa-ratus and machinery; gaming machines for gamb-ling; arcade video game machines; mah-jong; bar-bells; puppets; toy masks; theatrical masks; fencing masks; mobiles [toys]; scale model vehicles; scoo-ters [toys]; reels for fishing; paintballs [ammunition for paintball guns] sports apparatus; creels [fishing traps]; artificial snow for Christmas trees; practical jokes [novelties]; novelties for parties, dances [party favors, favours]; teddy bears; poles for pole vaul-ting; billiard balls; balls for games; play balloons; swimming jackets; knee guards [sports articles]; elbow guards [sports articles]; paragliders; shin guards [sports articles]; roller skates; in-line roller skates; ice skates; seal skins [coverings for skis]; stuffed toys; plush toys; quoits; clay pigeons [tar-gets]; roulette wheels; piñatas; flippers for swim-ming; air pistols [toys]; toy pistols; paintball guns [sports apparatus]; dolls' feeding bottles; candle hol-ders for Christmas trees; punching bags; billiard cue tips; jigsaw puzzles; rackets; snowshoes; scrapers for skis; rosin used by athletes; nets for sports; but-terfly nets; tennis nets; landing nets for anglers; scent lures for hunting or fishing; sole coverings for skis; kite reels; rollers for stationary exercise bicyc-les; bags especially designed for skis and surfboards; chessboards; bingo cards; camouflage screens [sports articles]; skis; surf skis; waterskis; wax for skis; bite sensors [fishing tackle]; skateboards; men's athletic supporters [sports articles]; sleighs [sports articles]; slot machines [gaming machines]; snow-boards; edges of skis; billiard table cushions; billiard cues; skating boots with skates attached; bite in-dicators [fishing tackle]; sailboards; surf boards; swimming kick boards; billiard tables; coin-operated billiard tables; tables for indoor football; tables for table tennis; checkerboards; clay pigeon traps; slides [playthings]; trampolines; spring boards [sports articles]; backgammon games; spinning tops [toys]; toy vehicles; radio-controlled toy vehicles; dolls' clothes; shuttlecocks.

(260) AM 2014 72086 A

(800) 1155389

(151) 2013 01 09

(731) ZHEJIANG AOSRAN LIGHTING
ELECTRICAL EQUIPMENT CO., LTD.
Tianhe Ind. Zone Longwan District Wenzhou
City Zhejiang Province 325000, China

(540)

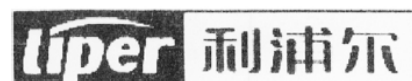

(591) Black, white

(511)

9 – Eyeglasses; contacts, electric; electrical distribu-tion boxes; meters; photocopiers [photographic, el-

ectrostatic, thermic]; signal lanterns; telephone apparatus; record players; monitoring apparatus, electric; bells [warning devices]; cameras [photography]; water meters; watt-hour meters; wires, electric; printed circuits; cell switches [electricity]; current rectifiers; remote control apparatus; power distributing devices for high voltage explosion proof; galvanic cells.

(260) AM 2014 72087 A
(800) 1155420
(151) 2013 02 07
(731) Stiftung Anton Proksch-Institut Wien
Mackgasse 7-11, A-1230 Wien, Austria
(540)

ORPHEUS

(591) Black, white
(511)
41 – Education, providing of training, entertainment, sporting and cultural activities, in particular on the basis of concepts for addictive disorders/addicts.
42 – Scientific and technological services and research and design relating thereto; industrial analysis and research services, in particular on the basis of concepts for addictive disorders/addicts.
44 – Medical services, in particular on the basis of concepts for addictive disorders/addicts.

(260) AM 2014 72089 A
(800) 1155447
(151) 2013 01 15
(731) ORIFLAME COSMETICS S.A.
24, avenue Emile Reuter, L-2420
LUXEMBOURG, Luxembourg
(540)

ORIFLAME VIVACITY

(591) Black, white
(511)
3 – Soaps, perfumery, essential oils, cosmetics; dentifrices.

(260) AM 2014 72091 A
(800) 1155524
(151) 2013 02 19
(731) Prokopyev Sergei Viktorovich
14, ul. Ozernaya, p. Katun, Altaisky raion,
RU-659635 Altai territory, Russian Federation
(540)

ГИНЕКОЛЬ

(591) Black, white
(511)
5 – Balms for medical purposes; dietetic substances adapted for medical use; nutritional supplements for

medical purposes; capsules for medicines; cachets for pharmaceutical purposes; medicinal roots; lozions for pharmaceutical purposes; ointments for pharmaceutical purposes; medicinal oils; drugs for medical purposes; medicinal drinks; flour for pharmaceutical purposes; medicinal beverages; dietetic beverages adapted for medical purposes; medicinal infusions; tinctures for medical purposes; decoctions for pharmaceutical purposes; pectin for pharmaceutical purposes; pepsins for pharmaceutical purposes; preparations of trace elements for human use; pharmaceutical preparations; syrups for pharmaceutical purposes; tablets for pharmaceutical purposes; medicinal herbs; herbal teas for medicinal purposes; elixirs for pharmaceutical purposes.

(260) AM 2014 72092 A
(800) 1155525
(151) 2013 02 27
(731) Obshchestvo s ogranichennoy
otvetstvennostyu "Upravlyayushchaya
kompania "Tatneft-Neftekhim"
ul. Shevchenko, 9, RU-423450 Almetyevsk,
Republic of Tatarstan, Russian Federation
(540)



(591) Red, light red, black, white
(511)
35 – Demonstration of goods; marketing studies; marketing research; shop window dressing; presentation of goods on communication media, for retail purposes; sales promotion for others; publication of publicity texts; radio advertising; advertising; on-line advertising on a computer network; television advertising; advertising by mail order; dissemination of advertising matter.
37 – Car wash; vehicle wash; retreading of tires [tyres]; vulcanization of tires [tyres] [repair].
40 – Custom assembling of materials for others; vulcanization [material treatment].

(260) AM 2014 72094 A
(800) 1155545
(151) 2013 02 28
(731) HUF HAUS GmbH u. Co. KG
Mühlenweg 1, 56244 Hartenfels, Germany
(540)

HUF HAUS

(591) Black, white

(511)
37 – Construction, namely construction of buildings made of pre-fabricated components.

(260) AM 2014 72095 A

(800) 1155548

(151) 2013 02 22

(731) Loxley Sp. z o.o.

ul. 1 Maja 12, PL-27-200 Starachowice,
Poland

(540)

LOXLEY

(591) Black, white

(511)

6 – Metal building materials; doors of metal; window and door frames of metal; sills of metal; garage gates of metal, windows of metal; metal fittings for windows; outdoor blinds of metal; metal ironmongery; locks; fittings of metal for building; portable metal construction structures.

19 – Non-metallic building materials; non-metallic windows; non-metallic window frames; non-metallic doors.

37 – Construction and repair services; installation and servicing of windows, doors, gates, blinds and portable metal construction structures.

(260) AM 2014 72096 A

(800) 1155555

(151) 2012 05 28

(731) AKTAS HAVA SUSPANSIYON

SISTEMLERI SANAYI VE TICARET

ANONIM SIRKETI

Kestel Sanayi Bolgesi, Kayasan Sokak No:5,
Kestel-Bursa, Turkey

(540)

AKTAS
NEWTONE

(591) Black, red

(511)

12 – Vehicles for locomotion by land, water and rail; apparatus for locomotion by land and water; air springs, roller bellows for motor vehicle air springs, air springs for motor vehicles, air spring suspension struts for motor vehicles, vibration damping devices and suspension systems for motor vehicle suspensions; bellows and bellows having components made of rubber or plastics for motor vehicle air springs.

17 – Rubber shock absorbers for machines, rubber stoppers, sealing plugs made primarily from rubber, rubber, gutta-percha, asbestos, mica or semi-finished synthetic goods made from these materials in the form of dusts, sheets, bars and folios; goods made from finished or semi finished synthetic materials included in this class for energy absorption and

isolation; flexible pipes and hoses made of rubber or plastic; pipe covers and fittings; textile hoses; non-metallic pipe covers and fittings; hose fittings; radiator hoses for vehicles; flexible tubes and hoses made from elastic, plastic or rubber, connecting hose for vehicles; goods made of rubber, natural rubber, plastic and similar materials namely rubber and natural rubber pads (shock absorbers), expansion bellows, billets of rubber, sleeves and brackets of rubber, foam rubber for protecting parts of machinery, rings of rubber for use as pipe connection seals, gasket sealer for use in plumbing, gasket rings.

(260) AM 2014 72097 A

(800) 1155565

(151) 2012 12 07

(731) OBSHESTVO S OGRANICHENNOY

OTVETSTVENNOSTYU

"SPLAT-COSMETICA"

ul. Stromynka, dom 19, korp. 2, RU-107076
Moscow, Russian Federation

(540)

BIOMIO

(591) Black, white

(511)

21 – Buckets; baby baths, portable; plungers for clearing blocked drains; carpet beaters [hand instruments]; abrasive sponges for scrubbing the skin; sponges for household purposes; toilet sponges; deodorising apparatus for personal use; sponge holders; toothpick holders; soap holders; shaving brush stands; toilet paper holders; soap dispensers; ironing boards; washing boards; containers for household or kitchen use; buckskin for cleaning; toothpicks; brush goods; cleaning instruments, hand-operated; shaving brushes; polishing leather; polishing materials for making shiny, except preparations, paper and stone; polishing apparatus and machines, for household purposes, non-electric; feather-dusters; brooms; saucepan scourers of metal; soap boxes; toilet cases; floss for dental purposes; cotton waste for cleaning; wool waste for cleaning; cleaning tow; gloves for household purposes; polishing gloves; gardening gloves; abrasive pads for kitchen purposes; pads for cleaning; toilet utensils; trouser presses; appliances for removing make-up, non-electric; dusting apparatus, non-electric; steel wool for cleaning; currycombs; clothes racks, for drying; basins [receptacles]; cloth for washing floors; cloths for cleaning; dusting cloths [rags]; furniture dusters; urns; water apparatus for cleaning teeth and gums; strainers for household purposes; dishwashing brushes; brushes for cleaning tanks and containers; lamp-glass brushes; horse brushes; scrubbing brushes; toothbrushes; toothbrushes, electric; carpet sweepers; brushes for footwear; toilet brushes; electric brushes, except parts of machines; brushes; nail brushes; boxes of metal, for dispensing paper towels; dustbins.

(260) AM 2014 72098 A

(800) 1155568

(151) 2012 12 03

(731) T-Platforms

Krupskaya Str., 4, building 2, RU-119311
Moscow, Russian Federation

(540)

TPL

(591) Black, white

(511)

9 – Testing apparatus not for medical purposes; monitoring apparatus, electric; electric apparatus for commutation; computer memory devices; interfaces for computers; fibre [fiber (Am.)] optic cables; commutators; compact discs [read-only memory]; computers; notebook computers; monitors [computer hardware]; branch boxes [electricity]; distribution boxes [electricity]; junction boxes [electricity]; battery boxes; microprocessors; sound recording carriers; magnetic data media; optical data media; limiters [electricity]; diagnostic apparatus, not for medical purposes; apparatus for conducting, switching, transforming, accumulating, regulating or controlling electricity; computer programmes [programs], recorded; computer programs [downloadable software]; processors [central processing units]; data processing apparatus; couplers [data processing equipment]; computer peripheral devices; readers [data processing equipment].

11 – Cooling appliances and installations; cooling installations and machines; sanitary apparatus and installations; air cooling apparatus.

35 – Demonstration of goods; marketing studies; commercial information and advice for consumers [consumer advice shop]; data search in computer files for others; office machines and equipment rental; advertising; on-line advertising on a computer network; compilation of information into computer databases; systemization of information into computer databases; efficiency experts; sales promotion for others.

37 – Building insulating; repair information; construction information; building construction supervision; factory construction; construction; installation, maintenance and repair of computer hardware; freezing equipment installation and repair; electric appliance installation and repair; machinery installation, maintenance and repair; office machines and equipment installation, maintenance and repair.

38 – Providing access to databases; computer aided transmission of messages and images; communications by fiber [fibre] optic networks; communications by computer terminals.

41 – Education information; practical training [demonstration]; educational services.

42 – Computer system analysis; recovery of computer data; technical project studies; engineering; installation of computer software; research and development for others; technical research; computer software consultancy; updating of computer software; maintenance of computer software; computer system design; duplication of computer programs; computer software design; computer programming; surveying; rental of web servers; computer rental; rental of computer software; packaging design; graphic arts designing; consultancy in the design and development of computer hardware; data conversion of computer programs and data [not physical conversion]; styling [industrial design].

(260) AM 2014 72102 A

(800) 1155585

(151) 2013 02 07

(731) Grundig Multimedia B.V.

Luna Arena, Herikerbergweg 238, NL-1101
CM Amsterdam Zuidoost, Netherlands

(540)

Multisense

(591) Black, white

(511)

7 – Engines, electrical engines, their parts and fittings and accessories other than for land vehicles (including parts), electric door openers-closers used in land vehicles (included in this class); alternators, generators, generators of electricity, generators working with solar energy; textile milling, scotch, tentering or washing machines, sewing machines and industrial robots with the same function as the above-mentioned machines; pumps other than parts of machines or engines (including fuel dispensing pumps and guns for these); electrical appliances used in kitchen for chopping, grinding, crushing, whisking and milling; washing machines (laundry machines / dishwashing machines); electrical machines for cleaning floors and carpets, vacuum cleaners and their parts.

(260) AM 2014 72105 A
 (800) 1155654
 (151) 2013 02 25
 (731) Malysheva Olga Valentinovna
 Tutaevscoe shosse, 41-45, RU-150042
 Yaroslavl, Russian Federation
 (540)



(591) Black, white
 (511)
 12 – Vehicle wheels; hub caps; rims for vehicle wheels; hubs for vehicle wheels; automobile tires; vehicle wheel tires.

(260) AM 2014 72106 A
 (800) 1155662
 (151) 2013 02 07
 (731) Grundig Multimedia B.V.
 Luna Arena, Herikerbergweg 238, NL-1101
 CM Amsterdam Zuidooost, Netherlands
 (540)

EcoChamp

(591) Black, white
 (511)
 7 – Engines, electrical engines, their parts and fittings and accessories other than for land vehicles (including parts), electric door openers-closers used in land vehicles (included in this class); alternators, generators, generators of electricity, generators working with solar energy; textile milling, scotching, tentering or washing machines, sewing machines and industrial robots with the same function as the above-mentioned machines; pumps other than parts of machines or engines (including fuel dispensing pumps and guns for these); electrical appliances used in kitchen for chopping, grinding, crushing, whisking and milling; washing machines (laundry machines / dishwashing machines); electrical machines for cleaning floors and carpets, vacuum cleaners and their parts; laundry dryers namely machines not drying with heating method.

11 – Lighting apparatus and installations (lighting installations for vehicles, interior and exterior spaces); devices for cooking, heating and vapor producing installations and apparatus (including electric ovens, microwave ovens, gas ovens, electric heating apparatus or heating apparatus for solid, liquid or gaseous fuels); air conditioning devices; cooling apparatus, namely refrigerators, milk coolers, water coolers, ice-boxes, ice machines and devices, freezers; electric and gas operated apparatus, machines and devices used in cooling, drying and boiling (including electric and heating-operated

laundry dryers, hair dryers and hand drying apparatus); industrial type cooking, drying and cooling installations; laundry dryers.

(260) AM 2014 72107 A
 (800) 1155673
 (151) 2013 02 25
 (731) Zakrytoe Aktsionernoe Obshchestvo
 Torgovaya Kompaniya
 "Yarshintorg"
 ul. Bazovaya, d. 3, str. 2, RU-150044
 Yaroslavl, Russian Federation
 (540)

LEGEARTIS

(591) Black, white
 (511)
 12 – Vehicle wheels; hub caps; bands for wheel hubs; rims for vehicle wheels; axles for vehicles; balance weights for vehicle wheels; hubs for vehicle wheels; spoke clips for wheels; automobile tires; vehicle wheel tires.

(260) AM 2014 72109 A
 (800) 1155708
 (151) 2012 09 24
 (731) ICM ULUSLARARASI İNŞAAT
 DANIŞMANLIK PAZ. SAN.VE DIŞ TİC.
 LTD.ŞTİ
 Bağdat Cad. Heper Apt. No.165/5,
 Selamiceşme Kadiköy İstanbul, Turkey
 (540)

INDOORLIFE

(591) Black, white
 (511)
 19 – Materials for constructing, coating, repairing roads, namely, asphalt, pitch and tar, bitumen asphalt; sand, gravel, slag stone; aggregate material composed of sand and sand stone, gravel, non-agricultural lime for use in construction, slag-lime cement, gypsum; blocks of concrete, plaster and colored plaster for building purposes; articles of artificial stone for building purposes; shaped building, construction and road construction materials made of concrete, gypsum, earth, clay, sand, natural stone, artificial stone, wooden, plastic or synthetic materials; poles, barriers; concrete, clay roofing tiles, natural stones, artificial stones, building materials, namely, semi-worked woods, plastic tiles; flooring or wall-claddings of synthetic materials; natural marbles, artificial marbles, inner and outer facings of natural or artificial stones, place and floor coatings; concrete panels, concrete pipes, concrete beams, concrete blocks, concrete bollards, concrete walls, concrete fences, concrete roof repair compounds, concrete slabs, concrete roof tiles, barrier of concrete, concrete poles for electric power lines;

plaster for building purpose, namely, plaster boards, plaster panels, plaster walls, plasters for prefabricated buildings; bricks, rigid pipes, not of metal, tubes and connection pieces; non-luminous, non-mechanical signs not of metal; monuments of stone, concrete or marble; statues of stone, concrete or marble; natural or synthetic surface coatings for building purposes in form of plates or strips (heat-adhesive); glass blocks for building, glass bricks, glass tiles, glass panes, glass panels for building construction, aquarium sand.

20 – Furniture, display stands and boards, index cabinets, medicine cabinets, writing and drawing desks, service carts, deck chairs, counters (tables) not of metal, work benches, vice benches, furniture chests, mailboxes, fixed towel dispensers (not of metal), coat hangers, coat stands; mirrors; beehives, comb foundations for beehives, sections of wood for beehives; playpens for babies, high chairs for babies, bassinets, infant walkers; vehicle plates not of metal, signs, signboards of wood or plastics, display boards, picture frames, picture frame brackets, moldings (moldings) for picture frames, identity plates, not of metal; nameplates, not of metal; registration plates, not of metal; number plates, not of metal; wooden barrels, casks, kegs, liquid containers, wood boxes, boxes for transportation purposes, chests, transport palettes, packaging containers of plastic, plastic barrels, reservoirs, neither of metal nor of masonry; boxes, non-metal valves for containers, taps for casks (not of metal); handles, stalks, stems, buttons for tools and instruments, of wood, wood substitute materials or synthetic materials, latches not of metal, bottle closures, not of metal; bottle caps, not of metal; corks for bottles, cork bands, window fittings, not of metal; door fittings, not of metal; locks, not of metal; racks, door handles, not of metal; drawer rails; casters, not of metal; bolts, not of metal; screws, not of metal; dowels, not of metal; pipe or cable clips, plugs (dowels) not of metal; works of art in this class, of wood, wax, plaster or plastic; sculptures, busts; mannequins, mobiles (decoration), wall plaques made of plastic or wood (furniture), stuffed animals; baskets, bakers' bread baskets, hamper baskets, reed baskets, fishing baskets; kennels, nesting boxes, cushions, beds for household pets; portable steps (ladders), not of metal, of wood or plastic; mobile boarding stairs not of metal for passengers; curtain holders, not of textile material; curtain hooks, curtain rails, curtain rings, curtain rods, curtain rollers, curtain tie-backs, bamboo curtains, indoor window blinds (shades), slatted indoor blinds, bead curtains for decoration.

(260) AM 2014 72110 A

(800) 1155714

(151) 2012 11 16

(731) GRUPPO COIN SpA

Via Terraglio, 17, I-30174 VENEZIA
MESTRE (VE), Italy

(540)

OVS DESIGN AREA

(591) Black, white

(511)

8 – Leather and imitation leather goods, and goods made of these materials and not included in other classes namely, handbags, shoulder bags, duffel bags, tote bags, school bags, schoolchildren's backpacks, beach bags, garment bags for travel, sport bags, overnight bags, shoe bags for travelling, business card cases, briefcases, pouches, wallets, leather credit card cases, backpacks, haversacks, waist packs, slings for carrying infants, pouch baby carriers, baby backpacks, key cases, shopping bags, toiletry bags (sold empty), vanity cases (sold empty); animal skins; hides; trunks and travelling bags, luggage, travelling sets, briefcases, luggage tags; umbrellas and parasols; walking sticks; whips, harness and saddlery.

25 – Clothing, footwear, headgear; clothing, footwear and headgear for men, women, children and babies; underwear, nightwear, beach wear for men, women, children and babies; clothing accessories, in particular, mufflers, gloves, mittens, belts, ties, stockings, socks, tights, panty hose, body warmers, bathrobes.

35 – Advertising; business management; business administration; presentation of goods and services on all means of communication for retailing; retailing and online sales of cosmetics, perfumery, preparations for care and treatment of the body and hair, jewelry, horological and chronometric instruments, leather and imitations of leather, trunks and travelling bags, umbrellas and parasols, clothing, footwear, headgear for men, women and children and personal accessories; management of department stores, shops and outlets; business management advisory services relating to franchising; provision of business information relating to franchising; organization, implementation, management and supervision of customer loyalty schemes, customer reward schemes, customer incentive schemes, including via the Internet; arranging fashion shows for promotional purposes.

41 – Organisation of artistic competitions; academies for stylists; arranging courses and seminars in the fashion design sector; conducting of training laboratories in the fashion and design sector; photography (reporting); arranging fashion shows for entertainment.

42 – Fashion design; dress designing; graphic arts design; interior design; design of fashion accessories; packaging designs; styling (industrial design); consultancy in fashion design; interior design for the retailing sector.

(260) AM 2014 72111 A

(800) 1155715

(151) 2013 01 15

(731) GROUPE CAHORS

Regourd, F-46000 CAHORS, France

(540)

CAHORS

(591) Black, white

(511)

9 – Scientific, optical, signaling and monitoring apparatus and instruments; apparatus and instruments for conducting, switching, transforming, accumulating, regulating or controlling electricity; apparatus for the recording, transmission, reproduction of data; magnetic recording media, optical or digital; Calculating machines and data processing equipment and computers; electric batteries, distribution cabinets (electricity), ignition batteries, connection, branching, distributing and junction boxes (electricity), electric cables, sheaths for electric cables, electrical connections and conduits, circuit breakers, electric collectors, control and distribution panels (electricity), switches, electrical capacitors, electrical conduits, connections, meters, cabinets and casings for meters, electrical transformers, recorded computer programs, luminous or mechanical signaling panels, lightning arresters, lightning conductors, telemeters, transmitters (telecommunication), satellites, satellite receivers, antennas, remote reading apparatus, namely telecommunications apparatus; power interface and information panels for electricity; electrical and telecommunication cable couplings; water or gas metering apparatus.

11 – Apparatus for lighting and for water or gas supply and connection; faucets for pipes, water and gas supply facility, protective housings therefor.

38 – Electronic display services for remotely transmitted data; communication by computer terminals, or satellite; Rental of telecommunications apparatus to be used for remote readout, remote transmission, namely rental of telecommunications apparatus; electronic messaging; message transmission, image and data assisted by computers; telecommunications connections to a computer network for the remote control of energy and fluid supply, connection and metering apparatus, remote metering and remote readout.

(260) AM 2014 72112 A

(800) 1155752

(151) 2012 10 30

(731) SPC MANUFACTURING

104 rue de Lisbonne – Parc d'Activités de Sermenaz, F-69140 RILLIEUX LA PAPE, France

(540)



(591) Black, white

(511)

7 – Machines and parts of machines for filling containers with fluids; parts of machines for filling containers with liquids, namely pistons (parts of machines), cylinders, valve items, check valves, slide valves, pumps, valves (parts of machines); filling apparatus (machines); filling needles (machine parts); distributors (machines) for filling; machines and parts of machines for dosing fluids; parts for dosing machines namely pistons, cylinders, valves, check valves, slide valves, pumps; nozzles (component parts of machines) for threading resins, air induction nozzles (component parts of machines known as Venturi nozzles) for determining the flow of gases; filling and dosing pumps (parts of machines); pumps (machines); pistons (parts of machines); regulators (machine parts); pressure regulators (parts of machines); fastening devices (parts of machines) for dosing and filling pumps; volumetric pumps for machines; autonomous filling machines (machines); pumps (machines) with piston plungers without seals with or without distributors; rotary distributors (machines); machines for compressing powders and components thereof, namely dosing screws for regulating speed and volume flow of fluids, punches, sinter molds; dosing machines, namely for the production of gel capsules; machines for dosing and compressing powder.

(260) AM 2014 72115 A

(800) 1155760

(151) 2012 11 20

(731) FIDIA FARMACEUTICI S.p.A.

Via Ponte della Fabbrica, 3/A, I-35031 ABANO TERME (PD), Italy

(540)

HYMOVIS

(591) Black, white

(511)

5 – Pharmaceutical and veterinary preparations; hygienic products for medical use; dietetic substances for medical use; food for babies; plasters, materials for dressings; disinfectants.

10 – Surgical, medical, dental and veterinary apparatus and instruments, orthopaedic articles; syringes and cannulas, applicators and medical devices for the administration of pharmaceutical preparations; medical devices for the treatment of traumatic and degenerative joint diseases and for orthopaedic surgery.

(260) AM 2014 72116 A

(800) 1155783

(151) 2013 02 04

(731) Bernard GRAF

9 Parc du Chapitre, F-76420 Bihorel, France;

Didier TURPIN

Route de Mont Cauvaire, Le Petit Cordeville,

F-76690 CLERES, France

(540)



(591) Black, white, red

(511)

18 – Leather and imitation leather, goods made of these materials (leather and imitation leather) not included in other classes, namely bags for climbers, bridles (harnesses), wallets, cases for keys (leatherware), briefcases, purses, school satchels and bags, leather strips, leather straps, leashes, muzzles, garment bags for travel, saddlery, handbags, backpacks, travel bags and tool bags (empty); hat boxes of leather; shoulder belts (straps) of leather; boxes of leather, leatherboard or vulcanized fiber; harnesses; purses; chain mesh purses; boxes of leather, leather board or vulcanized fiber; walking sticks; satchels; card cases (wallets); leatherboard; travel trunks; vanity cases (not fitted); collars for animals; leather leads, straps of leather (saddlery); coverings of skins (furs); unworked or semi-worked leather; document holders (briefcases); school bags; school bags; key cases; shopping nets and bags; furs (animal skins); clothing for animals; trunks [luggage]; attaché cases; moleskin (imitation leather); beach umbrellas; umbrellas; Animal hides; beach bags; purses (coin purses); wheeled shopping bags; bags and small bags (envelopes, pouches) of leather for packaging; backpacks; handbags; travel bags; bags for sports; saddlery; briefcases; traveling sets (leather goods); suitcases.

25 – Clothing, footwear, headgear; shirts; leather or imitation leather clothing; belts (clothing); furs (clothing); gloves (clothing); scarves; neckties; hosiery; socks; slippers; beach, ski or sports footwear; underwear.

35 – Services involving procurement, bringing together for the benefit of others (excluding the transport

thereof), sales promotion for others and sales, wholesale and retail, in stores, catalogs, by mail order, on a website or any other form of electronic communication media in the field of the following goods, especially leather and imitation leather, goods made of these materials (leather and imitation leather), not included in other classes, namely, bags for climbers, bridles (harnesses), wallets, cases for keys (leatherware), briefcases, purses, school satchels and bags, leather strips, leather straps, leashes, muzzles, garment bags for travel, saddlery, handbags, backpacks, travel bags and tool bags (empty), hat boxes of leather, shoulder bags (belts) of leather, boxes of leather, leather board or vulcanized fiber, saddlery, purses, chain mesh purses, cases of leather, leather board or vulcanized fiber, walking sticks, school bags, card cases (wallets), leatherboard, travel chests, vanity cases, collars for animals, leather laces, leather strips (saddlery), coverings of skins (furs), unworked or semi-worked leather, briefcases, school bags, school satchels, key cases, shopping nets and bags, furs (animal skins), clothing for animals, trunks, attaché cases, moleskin (imitation leather), parasols, umbrellas, animal skins, hides, beach bags, purses, bags with wheels, bags and satchels (envelopes, small bags) of leather for packaging, rucksacks, handbags, traveling bags, sports bags, saddlery, briefcases (leatherware), traveling sets (leatherware), suitcases, clothing, footwear, headgear, shirts, clothing of leather or imitation leather, belts (clothing), furs (clothing), gloves (clothing), scarves, neckties, hosiery, socks, slippers, beach, ski or sports footwear, underwear.

(260) AM 2014 72117 A

(800) 1155834

(151) 2013 03 20

(731) YANG LIANG

Room 701, Unit 6, Building No. 3,

Yuan Ding District, Qing Yun Road,

Sui Fen He, HEI LONG JIANG PROVINCE,

China

(540)



(591) Black, white

(511)

25 – Clothing; underpants; footwear; headgear; gloves [clothing]; hosiery; panty hose; stockings; socks; underwear.

(260) AM 2014 72118 A
 (800) 1155839
 (151) 2013 02 07
 (731) Grundig Multimedia B.V.
 Luna Arena, Herikerbergweg 238, NL-1101
 CM Amsterdam Zuidoost, Netherlands
 (540)

Brillissimo

(591) Black, white
 (511)
 7 – Engines, electrical engines, their parts and fittings and accessories other than for land vehicles (including parts), electric door openers-closers used in land vehicles (included in this class); alternators, generators, generators of electricity, generators working with solar energy; textile milling, scotching, tentering or washing machines, sewing machines and industrial robots with the same function as the above-mentioned machines; pumps other than parts of machines or engines (including fuel dispensing pumps and guns for these); electrical appliances used in kitchen for chopping, grinding, crushing, whisking and milling; washing machines (laundry machines / dishwashing machines); electrical machines for cleaning floors and carpets, vacuum cleaners and their parts.

(260) AM 2014 72119 A
 (800) 1155867
 (151) 2013 02 21
 (731) JEAN-CLAUDE VAN VARENBERG also known as JEAN-CLAUDE VAN DAMME
 The Harbourside, Union Square, 1 Austin Road West, Tower 2, Floor 75 A&B, Kowloon, Tsim Sha Tsui, Hong Kong, The Hong Kong Special Administrative Region of the people's republic of China, The Hong Kong Special Administrative Region of the people's republic of China
 (540)



(591) Black, white
 (511)
 5 – Food supplements, particularly food supplements for human beings, food supplements for medical purposes, dietetic food supplements, protein food supplements, royal jelly food supplements, linseed food supplements, powdered mixes for fruit-flavored rinks as food supplements, anti-oxidants for use as food supplements, nutritional supplements, food supplements for controlling cholesterol, vitamin and mineral food supplements, yeast food supplements, glucose food supplements, wheat germ food supplements, food supplements consisting of vitamins, vitamins.

9 – Spectacles (optics); sunglasses; spectacle cases; apparatus for recording, transmitting or reproducing sound and images; magnetic data media, blank disks; compact disks; videotapes; recording (music) tapes; films, not included in other classes; cameras [photography].

25 – Clothing, footwear, headgear, including training clothes, gym clothes, nightwear, beach clothes, rain clothing, leather clothing, T-shirts, sweaters, bandanas (neckerchiefs), stockings, blouses, hosiery, boots, half-boots, braces for clothing (suspenders), berets, caps (clothing), baseball caps, belts (clothing), money belts (clothing), hats, chasubles, socks, shoes, shirts, short-sleeved shirts, shawls, collars (clothing), overalls (clothing), suits, ear muffs (clothing), neckties, espadrilles, scarves, furs (clothing), gabardines (clothing), gloves (clothing), waistcoats, jerseys (clothing), skirts, slippers, robes, parkas, pocket squares (clothing), ponchos, pullovers, pajamas, dresses, clogs (footwear), sandals, bath sandals, gymnastic shoes, sports shoes, shoes, knitwear (clothing), jackets, scarves.

32 – Non-alcoholic beverages, energizing beverages, sports beverages, energy beverages, powders for making non-alcoholic beverages, preparations for making beverages, preparations for manufacturing beverages, concentrates used in the preparation of non-alcoholic beverages, non-alcoholic beverages with a low calorie count.

33 – Alcoholic beverages, alcoholic energizing beverages, alcoholic energy beverages, wines, wines protected by the appellation of origin "Champagne".

(260) AM 2014 72120 A
 (800) 1155883
 (151) 2012 11 09
 (731) ÜNLÜ ZİRAAT ALETLERİ ZİRAİ ÜRÜNLERİ SANAYİ VE TİCARET LİMİTED ŞİRKETİ
 Üç Tepeler Mevki MURADIYE/MANİSA, Turkey
 (540)



(591) Black, white
 (511)
 7 – Machines and machine tools; motors and engines (except for land vehicles); machine coupling and transmission components (except for land vehicles); agricultural implements other than hand-operated; incubators for eggs; automatic vending machines.

(260) AM 2014 72121 A
 (800) 1155894
 (151) 2013 01 31
 (731) ORIFLAME COSMETICS S.A.
 24, avenue Emile Reuter, L-2420
 LUXEMBOURG, Luxembourg

(540)
ORIFLAME POWER WOMAN

(591) Black, white
 (511)
 3 – Soaps; perfumery, essential oils, cosmetics, hair lotions; dentifrices.

(260) AM 2014 72122 A
 (800) 1155895
 (151) 2013 01 31
 (731) ORIFLAME COSMETICS S.A.
 24, avenue Emile Reuter, L-2420
 LUXEMBOURG, Luxembourg

(540)
ORIFLAME LOVELY BETTY

(591) Black, white
 (511)
 3 – Soaps; perfumery, essential oils, cosmetics, hair lotions; dentifrices.

(260) AM 2014 72123 A
 (800) 1155900
 (151) 2012 08 29
 (731) Shtokman Development AG
 c/o Markus Schnurrenberger, Baarerstrasse 8,
 CH-6301 ZUG, Switzerland



(591) White, green, orange, purple, blue, red and black
 (511)
 1 – Chemicals for use in the construction, treating, servicing, completion and working of oil, gas, geothermal and water wells and cleaning of industrial facilities; industrial chemicals.
 4 – Gas, oil gas, fuel gas, liquid gas, liquefied petroleum gas, compressed gas, electrical energy.
 9 – Computer software for use in the fields of energy, chemicals, petroleum, petroleum products, exploration, engineering, solar power, retailing and design; measuring, signaling, checking (supervision) and analysis apparatus, gas testing instruments; gasometers; apparatus and instruments for conducting, distributing, accumulating, regulating or controlling gas energy.
 37 – Gas drilling services; drilling of deep gas-wells; extraction of gas from gas fields; safe maintenance and repair of gas wells.

39 – Distribution of energy; storage of goods; distribution of gas; storage of gas; transport by gas pipeline.

40 – Refining and processing of dry gas, natural gas and natural gas liquids, gas well treatment, production and processing of fuels and of other sources of energy.

42 – Construction planning for the energy industry; engineering, in particular in the energy sector, including in the field of gas transport and gas application; technological consultancy in the fields of energy production and use; technical measuring services for pipe systems; surveying in the field of energy; technical development services in the energy sector, in particular gas transport technology and gas application technology development; consultancy and design of computer programs; computer software design; computer software consultancy; computer software maintenance; gas exploration services, geophysical exploration and searching of gas.

(260) AM 2014 72126 A
 (800) 1155912
 (151) 2012 12 12
 (731) JINJIANG FOOKHING ZIPPER CO., LTD.
 Hangbian Industrial Area, Longhuzhen,
 Jinjiang Fujian, China

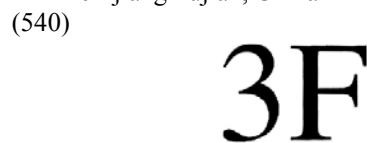

(591) Black, white
 (511)
 26 – Lace trimmings; trimmings for clothing; zippers; sewing needles; heat adhesive patches for decoration of textile articles [haberdashery]; letters for marking linen; artificial flowers; shoulder pads for clothing; buttons.

(260) AM 2014 72128 A
 (800) 1155914
 (151) 2012 11 30
 (731) VimpelCom Ltd.
 Claude Debussylaan 88, NL-1082
 MD AMSTERDAM, Netherlands

(540)
VIMPELCOM

(591) Black, white
 (511)
 9 – Communication and telecommunication apparatus, peripheral apparatus; computer software and apparatus, hardware and software in relation to networks; SIM cards; magnetically encoded cards; chips (integrated circuits); recorded software and computer programs; electronic apparatus for use in

the field of telecommunications, telephone switchboards, apparatus for displaying numbers and radio-paging apparatus; electronic apparatus for remote control of signals; transmitters of electronic signals; transmitters for telephones; transmitters (telecommunications); electronic telephone directories, accessible online and on CD-ROM; magnetic and optical media and data media; apparatus and instruments for dissemination, recording, transmission or reproduction of sound, images or data.

35 – Advertising; business management; business administration; office functions.

36 – Insurance underwriting; financial affairs; monetary affairs; real estate affairs; insurance services; financial services and rental services in the field of telecommunications and information networks; electronic payment services (checks); electronic money transfer services; reference credit agencies; charitable fund raising, financial sponsorship; trusteeship; financial services; (company) information and consultancy services, all in connection with the foregoing.

38 – Telecommunications; communication by mobile telephone; radiotelephone communication; radiorelay communication; communication by satellite; communication by telephone; facsimile transmission; electronic bulletin services (telecommunication services); information regarding telecommunications; telecommunications routing and junction services; computer-aided transmission of messages and images; transmission of messages, photographs and video images by means of mobile telephony services and satellites; telephone services; subscription telephone services; electronic mail; provision of user access to a global computer network (service providers) for data transfer and reception on a wide range of information, provision of user access to a global network (service providers); provision of telecommunication connections to a global computer network; teleconferencing services; rental of telecommunication equipment; rental of telephone equipment; (company) information and consultancy services, all in connection with the foregoing; technical consultancy and information relating to telecommunications.

42 – Software design, development and maintenance; computer programming; analysis of computer systems; design and planning services concerning telecommunication apparatus.

(260) AM 2014 72129 A

(800) 1155928

(151) 2012 12 10

(731) DOKTOR TARSA TARIM SANAYI VE TICARET ANONIM SİRKETİ
Organize Sanayi Bölgesi 2. Kısım 22.
Cadde, ANTALYA, Turkey

(540)



(591) Black, white

(511)

1 – Chemicals used in agriculture, horticulture and forestry; fertilizers.

(260) AM 2014 72130 A

(800) 1155931

(151) 2013 02 05

(731) Luitpold Pharmaceuticals, Inc.
One Luitpold Drive, Shirley, NY 11967,
USA

(540)

SocketKAP

(591) Black, white

(511)

10 – A device made of biocompatible materials placed over an extraction socket used to support, seal and protect the socket as it heals, used alone or in combination with other socket management devices.

(260) AM 2014 72255 A

(800) 1157034

(151) 2013 03 15

(731) RHODIA OPERATIONS
40 rue de la Haie-Coq, F-93306
AUBERVILLIERS, France

(540)

GOVANIL

(591) Black, white

(511)

30 – Aromatic preparations for food, essences for foodstuffs excluding etheric essences and essential oils, flavorings other than essential oils, flavorings (other than essential oils) for cakes, vanilla (flavoring), vanillin (vanilla substitute).

(260) AM 2014 72258 A
 (800) 1157066
 (151) 2013 03 15
 (731) Farmaprim S.R.L.
 Str. Gheorghe Tudor nr.3, MD-2028 Chişinău,
 Republic of Moldova

(540)

INSERT MHCEPT

(591) Black, white

(511)

5 – Pharmaceutical and veterinary products; sanitary products for medical purposes; dietetic substances for medical use, food for babies; plasters, materials for dressings; material for dental fillings and dental impressions; disinfectants; products for destroying vermin; fungicides, herbicides.

(260) AM 2014 72259 A
 (800) 1157081
 (151) 2013 03 25
 (731) TransAct Technologies Incorporated
 Suite 3B, 2319 Whitney Avenue, Hamden
 CT 06518, USA

(540)

PRINTREX

(591) Black, white

(511)

9 – Printers, namely thermal line printers and inkjet printers; computer software for printing systems.

(260) AM 2014 72260 A
 (800) 1157122
 (151) 2012 11 12
 (731) Zentiva Group, a.s.
 U kabelovny 130, CZ-102 37 Praha 10 – dolní
 Měcholupy, Czech Republic

(540)

BONEFORT

(591) Black, white

(511)

5 – Medicines, pharmaceutical preparations for human use.

(260) AM 2014 72261 A
 (800) 1157129
 (151) 2013 01 11
 (731) Union des Associations Européennes de
 Football (UEFA)
 Route de Genève 46, CH-1260 Nyon,
 Switzerland

(540)

UEFA CHAMPIONS LEAGUE

(591) Black, white

(511)

3 – Cosmetic products; soaps; cosmetic preparations for baths; perfumes, eaux de Cologne; shaving and after-shave lotions; shaving creams; shampoos, conditioners; dentifrices, dental rinses (mouthwashes); deodorants and antiperspirants for personal use; care creams, cosmetic creams; make-up removing creams for the face; make-up removing preparations; sun care lotions; hair lotions, hair sprays; toiletry creams; make-up products, eye shadows, face powders, cosmetic pencils; decorative transfers for cosmetic use; cleaning, polishing, degreasing and abrasive preparations for household use; washing powders; synthetic cleaning products; shoe waxes and creams; leather care products.

4 – Lubricants; engine oils and fuels, including gasoline, diesel oil, gases and bio-fuels; candles; waxes; greases; natural gas; liquid gases; industrial oils and greases; lubricating oils and greases; motor fuels; liquid petroleum gas; non-chemical additives for fuel, lubricants and greases; dust absorbing, wetting and binding compositions; lighting fuel; lubricants, oils and greases and lubricating preparations for industrial use; cutting oils for industrial purposes; milling oils.

9 – Exposed films, slides, video game disks; software (recorded programs), including game software; computer databases and programs; video game accessories; recorded or downloaded data, sound or images; videotapes, magnetic tapes, magnetic disks, DVDs, minidisks, floppy disks, optical disks, compact disks, CD-ROMs, video disks, memory cards, USB flash drives, whether blank or pre-recorded with music, sound or images (which may be cartoons); holograms; electronic publications provided by means of CD-ROMs, databases and the Internet; spectacles, sunglasses, diving and swimming goggles; cases, cords and chains for sunglasses and spectacles; binoculars; magnets and decorative magnets; directional compasses; sound and image recording, transmission and reproduction apparatus; satellite dishes; decoders, namely, computer software and hardware which can convert, supply and transmit audio and video data; televisions; flat screens, liquid crystal display screens, high-definition screens and plasma screens; radios; home cinema systems; video recorders; CD players; DVD players; MP3 players; cassette players; mini disk players; digital music players; loudspeakers; headphones, earphones; computers, including laptop computers and electronic tablets; karaoke systems; systems for editing and mixing sounds; systems for editing and mixing video images; computer data processing apparatus; computer keyboards; computer screens; modems; accessories for computers included in this class; computer mice, mouse pads; navigation systems; personal digital assistants (PDAs); electronic pocket translators; dictating machines; electronic diaries; scanners;

printers; photocopiers; facsimile machines; telephones; answering machines; video telephones; cellular telephones; accessories for cellular telephones, included in this class, namely cases for cellular telephones, hands-free kits for cellular telephones, earphones and headsets for cellular telephones, keypads for cellular telephones, lanyards for cellular telephones, special cases for carrying cellular telephones, photographic cameras and video cameras integrated in cellular telephones; remote controls for television sets and video systems; teleconferencing systems; calculating machines; credit card readers; currency converters; automated teller machines; video cameras, camcorders; photographic equipment, photographic apparatus, cameras (cinematographic apparatus), projectors, flash lamps, special cases and cords for photographic apparatus and instruments, electric cells and batteries; computer screen saver programs; magnetic, digital or analog recording media, recorded or not, for sounds or images; magnetic cards (encoded); memory cards; integrated circuit cards (smart cards); magnetic or chip-based credit cards, magnetic or chip-based telephone cards, magnetic or chip-based cards for cash dispensers, magnetic or chip-based cards for automated teller machines and currency converters, prepaid magnetic or chip-based cards for cellular telephones, magnetic or chip-based cards for travel and shows, magnetic or chip-based check guarantee cards and magnetic or chip-based debit cards; alarms; wind socks for indicating wind direction; distance measuring equipment; speed measuring and displaying equipment; gloves for protection; audio receivers, audio amplifiers; television tubes; cathode ray tubes; decoders, namely computer software and hardware capable of converting, supplying and transmitting audio and video data; disk drives for computers; protected semi-conductors; integrated circuits containing programs for processing audio, visual or computer data; rechargeable batteries; audio and video data processors and converters; cables for data transmission; payment apparatus for electronic commerce; protective helmets for sports; magnetic identification bracelets; electronic instrument assemblies; fuel/air coefficient analyzers; remote control devices for locking cars; photovoltaic cells; manually or voice-activated game cassettes.

12 – Bicycles, motorcycles, motor cars, trucks, vans, utility vehicles, buses, camper vans, refrigerated vehicles; airplanes and boats; air balloons, dirigible balloons [airships]; vehicle accessories, namely sun visors, pneumatic tires, tire covers, luggage racks, ski racks, rims and hub caps for wheels; seat linings, vehicle covers, baby carriages, strollers, safety seats for infants and children (for vehicles); engines and motors for land vehicles; safari bars; headlamp covers; steering wheels for vehicles; trailers.

16 – Coloring and drawing books; activity books; magazines; newspapers; books and journals, inclu-

ding those concerning sportsmen, sportswomen or sports events; bookmarks; printed teaching material; score sheets; event programs; albums for events; photograph albums; autograph books; printed timetables; pamphlets; collectible photographs of players; bumper stickers, stickers, albums, sticker albums; posters; photographs; tablecloths of paper; napkins of paper; bags of paper; invitation cards; greeting cards; gift wrapping paper; coasters and place mats of paper; garbage bags of paper or of plastics; food wrapping paper; small bags for preserving foodstuffs; coffee filters of paper; labels (not of textile); hand towels of paper; wet wipes of paper; toilet paper; napkins for removing make-up; boxes for handkerchiefs of paper and cardboard; handkerchiefs of paper; stationery and instructional and teaching material (except apparatus); typewriter paper; copying paper; envelopes; notepads; folders for papers; tissue paper; writing books; paper sheets for note-taking; writing paper; binder paper; files; covering paper; luminous paper; adhesive paper for notes; paperweights; crêpe paper; cloth paper; badges or insignia of paper; flags of paper; pennants (flags) of paper; writing instruments; fountain pens; pencils; ball-point pens; ball-point pen and pencil sets; felt-tip pens (marking pens); fiber-tip pens and felt-tip pens; marking pens; ink, inking pads, rubber stamps; typewriters (electric or non-electric); lithograph prints, lithographic works of art; framed or unframed paintings (pictures); paint boxes, paints and colored pencils; chalks; pencil ornaments [stationery]; printing blocks; address books; diaries; personal organizers of paper; road maps; tickets, entry tickets; checks; comic books; calendars; postcards; advertising boards, banners and material included in this class; transfers [decalcomanias]; sticking labels; office requisites (except furniture); correction fluids; rubber erasers; pencil sharpeners; stands and containers for office articles; paper clips; drawing pins; rulers; adhesive tapes for stationery purposes, adhesive tape dispensers; staples; stencils; document holders; paper clips; holders for notepads; business card cases; bookends; stamps (seals); postage stamps; credit cards, telephone cards, cash cards, cards for traveling and for shows, check guarantee cards and debit cards, which are non-magnetic and made of paper or cardboard; baggage tags of paper; metal note cases; letter trays; identity card holders.

18 – Leathers and imitation leathers; thongs [straps] of leather; umbrellas, parasols; sports bags (other than those adapted for products they are designed to contain); leisure bags; travel bags, backpacks; school bags; bags for hanging on belts; handbags, leather bags; beach bags; garment bags; suitcases; document holders (briefcases); belts for suitcases; briefcases; unfitted vanity cases; toiletry sets; key cases (leather goods); Wallets; purses (coin purses); whips; collars for animals; luggage tags of leather.

25 – Clothing; shoes and footwear; headgear; shirts; knitwear (clothing); pullovers; slipovers; tee shirts; vests; singlets; sleeveless jerseys, dresses; skirts; underwear; bathing suits; bath robes; shorts; trousers; sweaters; caps; caps (headwear); hats; sashes for wear; scarves, shawls; caps with visors; tracksuits; sweatshirts; jackets, sports jackets, stadium jackets (chasubles); blazers; waterproof clothing; coats; uniforms; neckties; wrist bands; headbands (clothing); gloves (clothing); bibs (not of paper); pajamas; play suits for infants and children; socks and stockings; garters; belts (clothing); suspenders.

28 – Games and toys; sports balls; play balloons; board games; tables for indoor football; dolls and plush toys; vehicles (toys); jigsaw puzzles; balloons; inflatable toys; play disks (pogs); playing cards; confetti; articles for gymnastics and sports; football equipment, namely balls for football, gloves, knee guards, elbow guards, shoulder guards, shin guards; football goals; sports bags and containers adapted for carrying sports articles; party hats (toys); small electronic games designed for use with a television set; apparatus for video games; game consoles; video game apparatus; electronic games other than those designed to be used only with a television set; steering wheels for video games and mats for video games on which one can dance; hands made of rubber or of foam (toys); robots for entertainment; appliances for gymnastics; kites; roller skates; scooters (toys); skateboards; coin-operated video games for game halls (arcade games); electronic games with liquid crystal displays; scratch cards; lottery tickets.

29 – Meat; fish, poultry and game; meat extracts; canned fish and meat; cooked fruits and vegetables; canned fruits and vegetables; edible oils and fats; potato chips; French fries; prepared nuts; jams; marmalades and jellies; milk; milk products (milk predominating), dairy products; cheese; soya milk (milk substitute).

32 – Non-alcoholic beverages; syrups and powders for making non-alcoholic beverages; mineral and carbonated waters; other non-alcoholic beverages; isotonic beverages; fruit and vegetable beverages; fruit and vegetable juices; frozen fruit beverages; beers; strong dark beers; lagers and ales; non-alcoholic or low-alcohol beers.

36 – Issuance and management of credit cards and travelers' checks; financial services; banking services, credit and investment services; insurance underwriting; hire-purchase financing; hire-purchase services; financial sponsorship of sports events; information services related to finance and insurance, provided online from a computer database or the Internet or on wireless electronic communication networks; home banking services; banking services over the Internet or over wireless electronic commu-

nication networks; payment services, including services provided on-line from a computer database or via the Internet or via mobile telephones; safe deposit services; issue of vouchers, namely issue of loyalty cards to fans, which contain personal data on the identity of the cardholder and are used for access control at sports stadiums; Financial promotion of football events; financial payment services for electronic commerce, namely transfer of funds, all via electronic communication networks; financial payment services for electronic commerce in connection with the purchase of goods and services provided by others, all via electronic communication networks, and clearing and settlement of financial transactions via electronic communication networks; issue of vouchers in the form of travel vouchers.

37 – Installation and maintenance of wireless electronic communication networks (hardware); computer connection installation services related to sports; installation and repair of sports grounds with natural or artificial turf; vehicle cleaning and washing; vehicle lubrication; vehicle maintenance; vehicle repair; overhaul, lubrication, maintenance and repair of vehicles, engines and machinery; preventive anti-rust treatment for vehicles; mounting of tire trims and repair of punctured tires; electronic calibration services for motors, engines and transmissions, construction of energy production plants; construction and maintenance of pipelines; extraction of gas and petroleum; construction of structures for the production of crude petroleum; installation of apparatus for the production of oil; installation of solar power systems; installation of wind power systems; installation of hydraulic power systems; mining extraction services.

38 – Telecommunication services; communication by mobile telephones; communication by telex; communication via electronic computer terminals linked to telecommunication networks, data banks and the Internet or via wireless electronic communication devices; communication by telegraphs; communication by telephones; communications by facsimile; paging services; telephone or video conferencing services; television program broadcasting; broadcasting of cable television programs; radio program broadcasting; radio and television broadcasting of sports and sporting events; news agency services; other message transmission services; rental of telephones, facsimile machines and other telecommunication apparatus; transmission of commercial Internet pages online or via wireless electronic communication devices; services for transmitting and broadcasting television and radio programs provided via the Internet or via any wireless electronic communication network; electronic transmission of messages; simultaneous broadcasting of film recordings and sound and video recordings; provision of access to telematic servers and real-time chat forums; com-

puter-aided transmission of messages and images; telecommunication via fiber-optic networks; provision of access to a global computer network or interactive communication technologies for access to private and commercial purchasing and ordering services; transmission of information and other data via websites and computers; transmission of information (including sites by telematic means) via telecommunication, of computer programs and other data; transmission of information, computer programs and other data by telematic means; electronic mail services; provision of access via the Internet or on any wireless electronic communication network (telecommunication services); providing connections for telecommunications with a global computer network (the Internet) or data banks; provision of access to websites offering digital music on the Internet by means of a global computer network or via wireless electronic communication devices; rental of access time to MP3 websites over the Internet, via a global computer network or via wireless electronic communication devices; rental of access time to a database server center (telecommunication services); rental of access time to a computer database (telecommunication services); transmission of digital music by telecommunications; online transmission of electronic publications; digital music transmission via the Internet or on any wireless electronic communication network; digital music transmission via MP3 Internet sites; simultaneous dissemination and/or networking of film recordings and sound and video recordings (telecommunications); simultaneous dissemination and/or networking of interactive educational and entertainment products, interactive compact disks, CD-ROMs, computer programs and computer games (telecommunications); provision of access to blackboards (notice and advertisement boards) and chat rooms in real time via a global computer network; rental and provision of access time to blackboards (boards for displaying information and advertisements) and to chat rooms in real time by means of a global computer network (communication services); telecommunication services dedicated to retail sale by means of interactive communications with customers; multimedia telecommunication; videotext and teletext transmission services; information transmission via communication satellite, microwave or by electronic, digital or analog means; transmission of digital information by cable, wire or fiber; transmission of information by mobile telephones, telephones, fax machines and telex; telecommunication services for receiving and exchanging information, messages, images and data; telecommunication services for setting up discussion groups on the Internet and on any wireless electronic communication network; provision of access to search engines for obtaining data and information on global networks.

39 – Operation of a travel agency, namely travel arrangement and reservations; ticket reservation and information services for travel; transport by airplane, railway, bus and truck; Boat transport; ship travel services; tourist travel services; vehicle rental; rental of parking spaces; taxi services; services for the transport of goods by boat ; distribution of water, heat, gas or electricity; distribution of newspapers, magazines and books; postal services, mail delivery and courier services; storage of goods; delivery of solvents, paraffins, waxes, bitumens and petroleum products, excluding liquid gas; distribution (delivery) of films and sound and image recordings; distribution (delivery) of interactive educational and entertainment products, interactive compact disks, CD-ROMs, computer programs and computer games; advisory services relating to power and electricity distribution.

40 – Processing of cinematographic films; letterpress printing; enlargement of photographs, printing of photographs, photographic film development; rental of machines and equipment for developing, printing, enlarging and finishing photographs; waste disposal services; services provided by a fashion designer; treatment of substances and materials; petroleum and gas treatment; transformation and refining of organic substances; production of energy; petroleum refining; refining services; advisory services relating to the production of energy and electricity.

41 – Education; training; entertainment; organization of lotteries, raffles and competitions; betting and gaming services in connection with sports; hospitality services (sports, entertainment), namely providing entry tickets and information brochures on sports for VIPs, as well as guiding and gathering VIPs during sports or entertainment events; hospitality services, namely customer reception services (entertainment services), including providing entry tickets to sports or entertainment events; entertainment services relating to sporting events; entertainment services in the form of public gatherings during the retransmission of sports events; sporting and cultural activities; organization of sporting and cultural events and activities; organization of sports competitions; organization of events in the field of football; sports camp services; operation of sports facilities; rental of video and audiovisual installations; production, presentation, distribution and/or rental of film recordings and sound and video recordings; presentation, distribution and/or rental of interactive educational and entertainment products, interactive compact disks, CD-ROMs, and computer games; radio and television coverage of sporting events; production services for radio and television programs and video films; ticket reservation services and information services for sports or entertainment events; sports events timing services; organization of

beauty contests; interactive entertainment; on-line betting and gaming services on the Internet or on any wireless electronic communication network; entertainment information (including in the field of sports), provided on-line from a computer database or via the Internet or via any wireless electronic communication network; electronic game services transmitted via the Internet or on mobile telephones; book publishing; publication of books and electronic journals on-line; audio and video recording services; production of animated cartoons for movies, production of animated cartoons for television; rental of sound and image recordings for entertainment purposes; education information provided on-line from a computer database or via the Internet or any wireless electronic communication network; translation services; photographic services; provision of entertainment infrastructures; ticket agency services in connection with sports events.

43 – Providing food and drink, snack-bars; hospitality services, namely providing of food and drink; food and drink catering; hotel services; providing accommodation and food and drink, booking hotels and temporary accommodation; hospitality services, namely providing food and drink at sports and entertainment events.

(260) AM 2014 72262 A

(800) 1157133

(151) 2012 12 20

(731) Mademoiselle Alice Taylor

32 rue de Picardie, F-75003 Paris, France;

Monsieur Thomas Taylor

143 rue d'Alésia, F-75014 Paris, France

(540)

BARBAPAPA

(591) Black, white

(511)

9 – Electronic agendas; magnets; decorative magnets; radios; cameras [photography] digital; Portable media players; scales; videotapes and videodiscs recorded with animation; covers for power outlets; digital photograph frames; pocket calculators; cameras digital; animated cards with screens; protective helmets for sports; helmets flexible; prerecorded audio cassettes; prerecorded video cassettes featuring cartoons; prerecorded CD-Is; prerecorded CD-ROMs; USB flash drives; electronic pens; animated cartoons; educational computer software; protection devices for personal use against accidents, namely reflective armbands; protection devices for personal use against accidents; prerecorded audio discs; prerecorded compact discs; video game discs; computer game discs; laser discs; videodisks; DVDs; DVDs interactive; screens electronic; screens magnetic; downloadable video recordings; spectacle cases; cases for sun glasses; cases for compact discs or

DVDs; video films; loudspeakers; holograms; covers and housings for digital tablets; covers for electronic games consoles; covers for computers; covers for portable computers; covers and cases for portable telephones; cases for cameras; joysticks for computer games; cassette players audiotapes and compact discs; DVD players; MP3 players; MP4 players; interactive electronic children's books; interactive entertainment software for use with computers; downloadable interactive entertainment software for playing computer games; interactive multimedia software for playing games; spectacles (optics); sunglasses; goggles for sports; swim masks; microphones; automatic time switches; computers; computers for children; CD storage sleeves; DVD sleeves; illuminated key rings; downloadable electronic publications; clock radios; radios portable; computer mice; telephone holders for cars; tablets graphics; mouse pads; telephones decorated; thermometers not for medical use.

16 – Posters; diaries; personal diaries with padlocks; pocket diaries; appointment diaries; staplers; photograph albums; photograph albums plush; sticker albums; photograph albums; sticker albums with or without stickers; albums; writing slates; removable decorative stickers; stickers wall-mounted; stickers; small comics and other pictorial press; comic strips; banners of paper; pads (stationery); adhesive notepads; notepads; foldable storage boxes; letter boxes; stationery boxes; boxes made of cardboard or paper; writing or drawing books; jotters; text exercise books; advent calendars; calendars perpetual; calendars birthday; calendars wall-mounted; calendars; secret books with locks; spiral-bound notebooks; notebooks creative; address books; sketch books; drawing blocks; note books; cards animated; note cards; greeting cards; cards musical; postcards; cardboard boxes (cartons) invitation; ink cartridges for pens and fountain pens; file folders; folders for papers; files; glue for stationery; wreaths of paper; color pencils; painting pencils; pencils; retractable pencils; pencils black; 3D decals for use on any surface; wall decorations; adhesive tape dispensers for stationery or household purposes; adhesive tape dispensers; lever arch files; private files and diaries; flags of paper; flags of paper or cardboard in the form of letters; ink erasers; magnetic or cardboard schedules ; ink; stamp sets; envelopes gifts; baggage tags of paper; adhesive labels, not of fabric; labels of paper; address labels; paper gift tags; paper sheets for coloring; felt-tip markers; figurines of papier mâché; figures made of paper; erasers; binder inserts; private diaries without padlocks; private diaries with a lock; newspapers; books animated; activity books; books handicrafts; plastic bath books; coloring books; story books; magic books; painting books; paperback books; books exercise; books golden; educational books; books illustrated; books, musical; books; magazines illustrated; maga-

zines; marking pens; mini drawing boards; mini books; handkerchiefs of paper; paper tissues for cosmetic use; handkerchiefs of paper; doilies of paper; tablecloths of paper; organizers for stationery use; door signs of paper or cardboard; stationery school; writing paper; writing paper; paper, blotting; gift wrapping paper; tracing paper; kitchen paper; wrapping paper; paper electrostatic; toilet paper; desk sets; pastels; modeling paste; painting; framed or unframed paintings (pictures); decorative figures releasably attachable to walls; photographs; drawing boards; sheets of stickers; pens; pen cases; file pockets for stationery use; paper or plastic bags for packaging; passport holders; gift bags of paper; drawing stencils; stencil plates; pencil holders; photograph stands of cardboard; propelling pencils; place cards; pen holders; mounted posters; posters; pen boxes; paperweights; exercise book covers; document covers (stationery); drawing rulers; drafting rulers; ring binders; indexes; adhesive tapes for stationery purposes; bags of paper; bags (envelopes, pouches) of paper or plastics, for packaging goods; bags of paper for parties; magnetic weekly planners; weekly planners; napkins of paper; place mats of paper; writing pads; stereograms; color ball-point pens; ball-point pens; fountain pens; pens retractable; pens fancy; pens illuminated; pens; felt pens; document markers [highlighting pens]; coloring boards; boards on stands; magnetic boards; blackboards; pencil sharpeners; ink stamps; inking pads; tattoos; webs for stationery.

18 – Purses; satchels; satchels with wheels; vanity cases (not fitted); key cases; net bags for shopping; leather leads; umbrellas; parasols; clutches (purses); Card cases (wallets); document holders (briefcases); wallets; wallets made of silicone; purses (coin purses); music cases; backpacks; rucksacks on casters; bags for snacks; handbags; handbags made exclusively of silicone; shopping bags; reusable shopping bags; shopping bags with wheels; plush pajama bags; wheeled shopping bags; bags worn around the waist; bags hobo bag; gym bags; gardening bags; gardening bags; beach bags; bags for sports; travel bags; fabric bags; bags fancy; bags sea; bags baby carriers; school book bags; bags for use in schools; garment bags for travel; briefcases; cosmetic kits; toiletry sets empty; traveling sets (leather goods); empty bags for cosmetic products; suitcases; wheeled suitcases; cardboard suitcases for children; suitcases of metal.

21 – Watering cans; table plates; dessert plates; plates made of melamine; disposable table plates; Chinese chopsticks; portable baby bathtubs; brooms; brooms and shovels; jerrycans (flasks); glass jars [carboys]; cookie jars; candy boxes; tooth cases; cake boxes; bread bins; pill boxes; sandwich boxes; sugar boxes; boxes of metal for dispensing paper towels; sugar bowls; bowls; ceramic bowls; bowls

made of melamine; candelabra (candlesticks); bottles; fancy bottles; bottles heat-insulated; Trinkets for drinking glasses for the purpose of identification; hair brushes; toothbrushes; toothbrushes with suction cups; toothbrushes musical with or without cups; decanters; saucepans; ceramic mugs; mugs made of melamine; egg cups; ceramic egg cups; egg cups made of melamine; waste paper baskets; portion cups; dish covers; cup lids; egg prickers of plastic for microwave ovens; absorbent paper dispensers; toilet paper dispensers; soap dispensers; soap dispensers liquid; towel dispensers; cookie and biscuit cutters; sponges for household purposes; toilet sponges; figurines (statuettes) of porcelain, ceramic, earthenware or glass; resin figurines; empty spray bottles; non-electric whisks for household purposes; gloves for washing dishes; goblets; goblets of paper or plastic; drinking flasks for travelers; drinking bottles of aluminum; kitchen ladles (basting spoons); bird houses; oven gloves (gloves for household use); molds; cake molds; ice cube molds; silicone molds for chocolates; cake tins made of silicone; silicone molds for eggs; drinking straws; strainers; scoops (table accessories); clothes-pegs; tablecloth clamps; decorative plaques; melamine trays for domestic use; metal meal trays; pastry bags; stencils for cakes; pepper pots; egg racks; toilet roll holders; toothbrush holders; bag holders; napkin holders; fancy lollipop holders; dishes for soap; pots; pots; toothbrush pots; flower pots; trash cans; kitchen trash receptacles; plush covers for health diaries; plush CD racks; graters for household purposes; rolling pins; bread bags; isothermic bags; salad bowls; salt cellars; coffee services (tableware); tea sets; cruet stands for salt, pepper, vinegar and oil; bath seats for babies; coasters; spatulas (kitchen utensils); sugar bowls; pads for pastries; ceramic cups and saucers; cups; cups made of melamine; plastic cups; corkscrews; corkscrews; piggy banks; kitchen utensils; cooking utensils of silicon; ceramic and porcelain tableware; tableware made of melamine; tableware of paper; disposable party tableware; perfume vaporizers; vases; vases magnetic; glasses (receptacles); drinking glasses.

24 – Facecloths; crib canopies; comforters [bedding]; blankets fleece; baby blankets; bed blankets; plush covers for hot water bottles; baby bed covers; bed covers; bath sheets; baby comforters; labels of cloth; washing mitts; covers for chairs and high chairs; eiderdown covers; nursing table covers; bed linen; linen sponge; tablecloths of textile; travel rugs (lap robes) polar wear; travel rugs (lap robes); diaper holders; door curtains; pajama racks; shower curtains; window curtains; curtains; sleeping bags for babies; sleeping bags (sewn envelopes used as sheeting); table napkins of textile; towels, not of paper; terry towels; beach towels; plastic place mats; table sets not of paper; pillow cases; padded or textile cot bumpers.

25 – Clothing, footwear, headgear; bandanas (neckerchiefs); bandeaux; romper suit; plastic bibs; bib; Bermuda shorts; blousons; bathing caps; caps; rain boots; suspenders; bathing trunks; cardigans; caps (headwear); belts; paper hats; rain hats; hats; socks; slippers; dance slippers; bootees; slipper socks; footwear except for orthopedic footwear; beach shoes; shirts; rain suits; jump suits [clothing]; suits for adults and children; tank top; sashes for wear; short sets [clothing]; espadrilles for children and adults; gloves; sleeper suit; leggings [leg warmers]; skirts; leggings (trousers); bathing suits; raincoats; trousers; rain trousers; slippers; sweaters; pajamas; dresses; beach dresses; bath sandals; shorts; underwear; sweatshirts; aprons; tee-shirts; printed T-shirts; jackets; rain jackets; dance clothing; nightwear; nightwear for babies; Beach clothes; swaddling clothes.

28 – Games, toys; toy animals; entertainment apparatus for use with television sets; swings; stress balls for the hands; balls for games; balls for juggling; soft balls for stress-relieving exercises; play balloons; dolls' feeding bottles; marbles for games; building blocks (toys); explosive bonbons [Christmas crackers]; playing balls; soap bubbles (toys); playing cards; kites; dolls' rooms; paper party hats; confetti; checkerboards; Christmas tree ornaments and decorations; dice (games); toy figurines; nets (sports articles); swimming jackets; cups for games; rattles; counters [disks] for games; ring games; building games; checkers [games]; dominoes; educational games; dart games; parlor games; board games; chess games; portable games with liquid crystal displays; plastic toys; electronic learning toys; inflatable toys; inflatable toys for swimming pools; toys cushioned; toys solar; toys mechanical; toys, musical; kaleidoscopes; dolls' beds; electronic educational game machines for children; mah-jong; dolls' houses; roundabouts and games for children; coin-operated roundabouts for public places such as shopping malls; puppets; toy masks; mobiles (toys); scale model vehicles; scale model kits (toys); novelties for parties; teddy bears; ice skates; roller skates; in-line roller skates; stuffed toys; swimming pools (play articles); windsurfing boards; swim boards for recreational use; surfboards; dolls; dolls , talking ; elbow guards (sports articles); knee guards (sports articles); wrist guards [sports articles]; shin guards (sports articles); punching balls; jigsaw puzzles; skittles (games); rackets; cricket bags; toy whistles; snowboards; tables for table football; billiard tables; activity mats for children; toboggans (games); spinning tops (toys); kite reels; trampolines; scooters; vehicles (toys); radio-controlled vehicles (toys); clothes for dolls; toy cars; shuttlecocks; yo-yos.

41 – Entertainment and cultural activities; radio, Internet and television entertainment; entertainment in

the form of animated television series; editing of printed matter containing pictures, other than for advertising purposes; editing and publication of printed matter and texts, other than publicity texts; recording, production and distribution of films, video and audio recordings, radio and television programs; rental of videotapes; provision of movie, television and music video entertainment via an interactive web site; providing online non-loadable comic books and graphic novels; provision of educational entertainment services for children in after school centers; production of films and audiovisual and television programs; Production of films on DVD and CD-ROM; publication of calendars; publication of books, magazines and other texts, other than advertising texts; multimedia publishing of printed matter.

(260) AM 2014 72266 A

(800) 1157141

(151) 2013 01 25

(731) Union des Associations Européennes de Football (UEFA)
Route de Genève 46, CH-1260 Nyon,
Switzerland

(540)

EURO 2020

(591) Black, white

(511)

3 – Cosmetic products; soaps; cosmetic preparations for baths; perfumes, eaux de Cologne; pre-shave and after-shave lotions; shaving creams; shampoos, conditioners; dentifrices, dental rinses (mouthwashes); deodorants and antiperspirants for personal use; care creams, cosmetic creams; make-up removing creams for the face; make-up removing preparations; sun care lotions; hair lotions, hair sprays; toiletry creams; make-up products, eye shadows, face powders, cosmetic pencils; decorative transfers for cosmetic use; cleaning, polishing, degreasing and abrasive preparations for household use; laundry powders; synthetic cleaning products; shoe waxes and creams; leather care products; all the aforesaid goods are from Europe.

4 – Lubricants; engine oils and fuels, including gasoline, diesel oil, gases and bio-fuels; candles; waxes; greases; natural gas; liquid gases; industrial oils and greases; lubricating oils and greases; motor fuels; liquid petroleum gas; non-chemical additives for fuel, lubricants and greases; dust absorbing, wetting and binding products; lighting fuel; lubricants, oils and greases and lubricating preparations for industrial use; cutting oils for industrial purposes; milling oils; all the aforesaid goods are from Europe.

12 – Bicycles, motorcycles, motor cars, trucks, vans, utility vehicles, buses, camper vans, refrigerated

vehicles; airplanes and boats; air balloons, dirigible balloons [airships]; vehicle accessories, namely sun visors, pneumatic tires, tire covers, luggage racks, ski racks, rims and hub caps for wheels; seat linings, vehicle covers, baby carriages, strollers, safety seats for infants and children (for vehicles); engines and motors for land vehicles; safari bars; headlamp covers; steering wheels for vehicles; trailers; all the aforesaid goods are from Europe.

14 – Jewelry, necklaces; jewelry products; watches; wristwatches, clocks; chronographs; wall clocks; medallions, pendants, brooches; bracelets; pins (jewelry); lapel pins (jewelry); tie clips and tie pins; cuff links; commemorative medals of precious metal; prize cups, commemorative plates, trophies, statues, sculptures, all of precious metal; decorative hat pins, key rings (trinkets or fobs), printed metal disks for collection purposes (pogs), all made of precious metal; decorative key holders; coins; medals for clothing; cases for watches; badges of precious metal; alarm clocks; badges and pins (jewelry); leather bracelets; bracelets of plastic materials; ornamental key rings of plastic materials; all the aforesaid goods are from Europe.

18 – Leathers and imitation leathers; thongs [straps] of leather; umbrellas, parasols; sports bags (other than those adapted for products they are designed to contain); leisure bags; travel bags, backpacks; school bags; bags for hanging on belts; handbags, leather bags; beach bags; garment bags; suitcases; document holders (briefcases); belts for suitcases; briefcases; unfitted vanity cases; toiletry sets; key cases (leather goods); wallets; purses (coin purses); whips; collars for animals; luggage tags of leather; all the aforesaid goods are from Europe.

25 – Clothing; shoes and footwear; headgear; shirts; knitwear (clothing); pullovers; slipovers; Tee shirts; vests; singlets; sleeveless jerseys, dresses; skirts; underwear; bathing suits; bath robes; shorts; trousers; sweaters; caps; caps (headwear); hats; sashes for wear; scarves, shawls; caps with visors; tracksuits; sweatshirts; jackets, sports jackets, stadium jackets (chashubles); blazers; waterproof clothing; coats; uniforms; neckties; wrist bands; headbands; gloves; aprons; bibs (not of paper); pajamas; play suits for infants and children; socks and stockings; garters; belts; suspenders; all the aforesaid goods are from Europe.

32 – Non-alcoholic beverages; syrups and powders for making non-alcoholic beverages; mineral and carbonated waters; other non-alcoholic beverages; isotonic beverages; fruit and vegetable beverages; fruit and vegetable juices; frozen fruit beverages; beers; strong dark beers; lagers and ales; non-alcoholic or low-alcohol beers; all the aforesaid goods are from Europe.

36 – Issuance and management of credit cards and travelers' checks; financial services; banking services, credit and investment services; insurance underwriting; hire-purchase financing; hire-purchase services; financial sponsorship of sports events; information services related to finance and insurance, provided online from a computer database or the Internet or on wireless electronic communication networks; home banking services; banking services over the Internet or over wireless electronic communication networks; financial sponsorship search for football competitions; payment services, including services provided on-line from a computer database or via the Internet or via mobile telephones; safe deposit services; issue of vouchers, namely issue of loyalty cards to fans, which contain personal data on the identity of the cardholder and are used for access control at sports stadiums; Financial promotion of football events; financial payment services for electronic commerce, namely transfer of funds, all via electronic communication networks; financial payment services for electronic commerce in connection with the purchase of goods and services provided by others, all via electronic communication networks, and clearing and settlement of financial transactions via electronic communication networks; issue of vouchers in the form of travel vouchers.

37 – Installation and maintenance of wireless electronic communication networks (hardware); computer connection installation services related to sports; installation and repair of sports grounds with natural or artificial turf; vehicle cleaning and washing; vehicle lubrication; vehicle maintenance; vehicle repair; overhaul, lubrication, maintenance and repair of vehicles, engines and machinery; preventive anti-rust treatment for vehicles; tire trim fitting and tire puncture repair; construction and maintenance of pipelines; extraction of gas and petroleum; construction of structures for the production of crude petroleum; installation of apparatus for the production of oil; installation of solar power systems; installation of wind power systems; installation of hydraulic power systems; mining extraction services; construction of power plants.

38 – Telecommunication services; communication by mobile telephones; communication by telex; communication via electronic computer terminals linked to telecommunication networks, data banks and the Internet or via wireless electronic communication devices; communication by telegraphs; communication by telephones; communications by facsimile; paging services; telephone or video conferencing services; broadcasting of television programs; broadcasting of cable television programs; radio program broadcasting; radio and television broadcasting of sports and sporting events; news agency services; other message transmission

services; rental of telephones, facsimile machines and other telecommunication apparatus; transmission of commercial Internet pages online or via wireless electronic communication devices; services for transmitting and broadcasting television and radio programs provided via the Internet or via any wireless electronic communication network; electronic transmission of messages; simultaneous broadcasting of film recordings and sound and video recordings; provision of access to telematic servers and real-time chat forums; computer-aided transmission of messages and images; telecommunication via fiber-optic networks; provision of access to a global computer network or interactive communication technologies for access to private and commercial purchasing and ordering services; transmission of information and other data via websites and computers; transmission of information (including sites by telematic means) via telecommunication, of computer programs and other data; transmission of information, computer programs and other data by telematic means; electronic mail services; provision of access via the Internet or on any wireless electronic communication network (telecommunication services); providing connections for telecommunications with a global computer network (the Internet) or data banks; provision of access to websites offering digital music on the Internet by means of a global computer network or via wireless electronic communication devices; rental of access time to MP3 websites over the Internet, via a global computer network or via wireless electronic communication devices; rental of access time to a database server center (telecommunication services); rental of access time to a computer database (telecommunication services); transmission of digital music by telecommunications; online transmission of electronic publications; digital music transmission via the Internet or on any wireless electronic communication network; digital music transmission via MP3 Internet sites; simultaneous dissemination and/or networking of film recordings and sound and video recordings (telecommunications); simultaneous dissemination and/or networking of interactive educational and entertainment products, interactive compact disks, CD-ROMs, computer programs and computer games (telecommunications); provision of access to blackboards (notice and advertisement boards) and chat rooms in real time via a global computer network; rental and provision of access time to blackboards (boards for displaying information and advertisements) and to chat rooms in real time by means of a global computer network (communication services); telecommunication services dedicated to retail sale by means of interactive communications with customers; multimedia telecommunication; videotext and teletext transmission services; information transmission via communication satellite, microwave or by electronic, digital or

analog means; transmission of digital information by cable, wire or fiber; transmission of information by mobile telephones, telephones, facsimile or telex; telecommunication services for receiving and exchanging information, messages, images and data; telecommunication services for setting up discussion groups on the Internet and on any wireless electronic communication network; provision of access to search engines for obtaining data and information on global networks.

42 – Computer consultancy services; data processing (programming); provision or rental of computer software; computer rental; compilation of websites in computer networks (particularly the Internet) or via wireless electronic communication devices; introduction of websites in computer networks (particularly the Internet) or via wireless electronic communications devices; provision of search engines for obtaining data and information on global networks; hosting services for Internet sites or wireless electronic communication sites; creation and maintenance of websites and of wireless electronic communication networks; networking and/or rental of computer programs; installation and maintenance of computer software; computer software development; calibration; provision of Internet search engines; analysis, testing and monitoring (supervision) of oils, coolants, greases and lubricants; analysis and diagnosis of degrees of wear, faults and breakdown on motors, engines and machines; advice relating to the aforesaid fields and provided on the basis of results from the aforesaid analysis and diagnosis; quality control services in connection with overhaul, lubrication, maintenance and repair of vehicles, motors, engines and machinery; programming of computer programs; design and development of computer programs; technical development of discussion forums on the Internet or on any wireless electronic communication network; testing services relating to prospecting in the oil and gas industry; prospecting to locate oil and gas; analyses services for exploitation of oil deposits; assistance services related to technology in the oil industry; analysis, advice, assistance and design services related to technology in the oil industry; advice in connection with technology and technical development services, technical design and technical planning for photovoltaic installations; advice in connection with technology and technical development services, technical design and technical planning for wind installations; advisory services relating to electronic control devices for the monitoring of solar and/or wind-powered electric systems; design of energy and electricity systems; analysis of the energy requirements of others; development of energy and electricity management systems; project study and technical advice and development services, all in connection with the needs of others for electricity and energy; technical design services for

electrical installations; technical development relating to energy and electricity distribution; technical development relating to energy and electricity production; electronic calibration services for motors, engines and transmissions.

(260) AM 2014 72267 A

(800) 1157142

(151) 2013 02 05

(731) Union des Associations Européennes de Football (UEFA)
Route de Genève 46, CH-1260 Nyon,
Switzerland

(540)

UEFA EURO 2020

(591) Black, white

(511)

9 – Exposed films, slides, video game disks; software (recorded programs), including game software; computer databases and programs; video game accessories; recorded or downloaded data, sound or images; videotapes, magnetic tapes, magnetic disks, DVDs, minidisks, floppy disks, optical disks, compact disks, CD-ROMs, video disks, memory cards, USB flash drives, whether blank or pre-recorded with music, sound or images (which may be cartoons); holograms; electronic publications provided by means of CD-ROMs, databases and the Internet; spectacles, sunglasses, diving and swimming goggles; cases, cords and chains for sunglasses and spectacles; binoculars; magnets and decorative magnets; directional compasses; sound and image recording, transmission and reproduction apparatus; satellite dishes; decoders, namely computer software and hardware capable of converting, providing and transmitting audio and video data; televisions; flat screens, liquid crystal display screens, high-definition screens and plasma screens; radios; home cinema systems; video recorders; CD players; DVD players; MP3 players; cassette players; mini disk players; digital music players; loudspeakers; headphones, earphones; computers, including laptop computers and electronic tablets; karaoke systems; systems for editing and mixing sounds; systems for editing and mixing video images; computer data processing apparatus; computer keyboards; computer screens; modems; accessories for computers included in this class; computer mice, mouse pads; navigation systems; personal digital assistants (PDAs); electronic pocket translators; dictating machines; electronic diaries; scanners; printers; photocopiers; facsimile machines; telephones; answering machines; video telephones; cellular telephones; accessories for cellular telephones, included in this class, namely cases for cellular telephones, hands-free kits for cellular telephones, earphones and headsets for cellular telephones, keypads for cellular telephones, lanyards for cellular telephones, special

cases for carrying cellular telephones, photographic cameras and video cameras integrated in cellular telephones; remote controls for television sets and video systems; teleconferencing systems; calculating machines; credit card readers; currency converters; automated teller machines; video cameras, camcorders; photographic equipment, photographic apparatus, cameras (cinematographic apparatus), projectors, flash lamps, special cases and cords for photographic apparatus and instruments, electric cells and batteries; computer screen saver programs; magnetic, digital or analog recording media, recorded or not, for sounds or images; magnetic cards (encoded); memory cards; integrated circuit cards (smart cards); magnetic or chip-based credit cards, magnetic or chip-based telephone cards, magnetic or chip-based cards for cash dispensers, magnetic or chip-based cards for automated teller machines and currency converters, prepaid magnetic or chip-based cards for cellular telephones, magnetic or chip-based cards for travel and shows, magnetic or chip-based check guarantee cards and magnetic or chip-based debit cards; alarms; wind socks for indicating wind direction; distance measuring equipment; speed measuring and displaying equipment; gloves for protection; audio receivers, audio amplifiers; television tubes; cathode ray tubes; decoders, namely computer software and hardware capable of converting, supplying and transmitting audio and video data; disk drives for computers; protected semi-conductors; integrated circuits containing programs for processing audio, visual or computer data; rechargeable batteries; audio and video data processors and converters; cables for data transmission; payment apparatus for electronic commerce; protective helmets for sports; magnetic identification bracelets; electronic instrument assemblies; fuel/air coefficient analyzers; remote control devices for locking cars; photovoltaic cells; video game cassettes; joysticks, voice-activated or manually operated joysticks.

16 – Coloring and drawing books; activity books; magazines; newspapers; books and journals, including those concerning sportsmen, sportswomen or sports events; bookmarks; printed teaching material; score sheets; event programs; albums for events; photograph albums; autograph books; printed timetables; pamphlets; collectible photographs of players; bumper stickers, stickers (stationery), albums, sticker albums; posters; photographs; tablecloths of paper; paper napkins; bags of paper; invitation cards; greeting cards; gift wrapping paper; coasters and place mats of paper; garbage bags of paper or of plastics; food wrapping paper; small bags for preserving foodstuffs; coffee filters of paper; labels (not of textile); hand towels of paper; wet wipes of paper; toilet paper; napkins for removing make-up; boxes for handkerchiefs of paper and cardboard; handkerchiefs of paper; stationery and instructional and teaching material (except apparatus); typewriter

paper; copying paper; envelopes; notepads; folders for papers; tissue paper; writing books; paper sheets for note-taking; writing paper; binder paper; files; covering paper; luminous paper; adhesive paper for notes; paperweights; crêpe paper; tissue paper; badges or insignia of paper; flags of paper; pennants (flags) of paper; writing instruments; fountain pens; pencils; ball-point pens; ball-point pen and pencil sets; felt-tip pens (marking pens); fiber-tip pens and felt-tip pens; marking pens; ink; inking pads, rubber stamps; typewriters (electric or non-electric); lithograph prints, lithographic works of art; framed or unframed paintings (pictures); paint boxes, paints and colored pencils; chalks; pencil ornaments [stationery]; printing blocks; address books; diaries; personal organizers of paper; road maps; tickets, entry tickets, checks; comic books; calendars; postcards; advertising boards, banners and materials included in this class; transfers [decalcomanias]; sticking labels; office requisites (except furniture); correction fluids; rubber erasers; pencil sharpeners; stands and containers for office articles; paper clips; drawing pins; rulers; adhesive tapes for stationery purposes, adhesive tape dispensers; staples; stencils; document holders; paper clips; holders for notepads; bookends; stamps (seals); postage stamps; credit cards, telephone cards, cash cards, cards for traveling and for shows, check guarantee cards and debit cards, which are non-magnetic and made of paper or cardboard; baggage tags of paper; passport cases; travelers' checks; holders for checkbooks; money clips of metal; letter trays; identity card holders.

28 – Games and toys; sports balls; play balloons; board games; tables for indoor football; dolls and plush toys; vehicles (toys); jigsaw puzzles; balloons; inflatable toys; play disks (pogs); playing cards; confetti; articles for gymnastics and sports; football equipment, namely balls for football, gloves, knee guards, elbow guards, shoulder guards, shin guards; football goals; sports bags and containers adapted for carrying sports articles; party hats (toys); small electronic games designed for use with a television set; apparatus for video games; game consoles; video game apparatus; electronic games other than those designed to be used only with a television set; steering wheels for video games and mats for video games on which one can dance; hands made of rubber or of foam (toys); entertainment robots; appliances for gymnastics; kites; roller skates; scooters; skateboards; coin-operated video games for game halls (arcade games); electronic games with liquid crystal displays; lottery tickets; scratch cards.

35 – Employment agencies; personnel recruitment; advertising services; services provided by an agency publishing advertising texts; advertising agency services; advertising agency services on a global computer network (the Internet) or via wireless electronic communication devices; dissemination of

advertisements; rental of advertising space; rental of advertising time in film credits; television advertising, radio advertising; advertising in the form of animated cartoons; promotional agency services, promotion agency services for sports and public relations; promotion of football events; market study services; market research services; opinion polling services; organization of exhibitions for commercial or advertising purposes; organization of advertising for trade fairs; collection and systematization of information into data banks; data bank management services; compilation of statistics; advertising for football-related sports events; retail sale services for and bringing together of various goods for the benefit of others (excluding the transport thereof), namely clothing, footwear, headgear, sports articles, stationery, apparatus for recording, transmission and reproduction of sound and images, books, newspapers, magazines, publications, video games, toys, dolls, badges of all kinds, key rings, tickets, watches and jewelry, souvenir items in connection with football, bags, luggage, briefcases, umbrellas, flags and pennants, alcoholic and non-alcoholic beverages, confectionery, medical apparatus and instruments, vehicles and accessories for motor cars; retail sale services for solvents, paraffin, waxes, bitumen and petroleum; bringing together of the following goods for the benefit of others (excluding transport thereof) to enable customers to conveniently view and purchase these goods in a store or on a global computer network (the Internet) or via wireless electronic communication devices, namely clothing, footwear, headgear, sports articles, stationery, apparatus for recording, transmission and reproduction of sound and images, books, newspapers, magazines, publications, video games, toys, dolls, badges of all kinds, key rings, tickets, watches and jewelry, souvenir items in connection with football, bags, luggage, briefcases, umbrellas, flags and pennants, alcoholic and non-alcoholic beverages, confectionery, medical apparatus and instruments, vehicles and accessories for motor cars; advertising and promotion services, information services with regard to advertising and promotion, commercial information agencies, all the aforesaid services provided on-line from a computer database or via a global computer network (the Internet) or via wireless electronic communication devices; design and compilation of advertisements for use as a web site on a global computer network (the Internet) or via wireless electronic communication devices; provision of space on web sites, for advertising of goods and services; auctioneering on a global computer network (the Internet) or via wireless electronic communication devices; collection of directories for publication on the Internet and on a wireless electronic communication network; business administration services for processing commercial services on a global computer network (Internet) or via wireless

electronic communication devices; compilation, creation and management of databases, namely collection of domain names in a register; promotion of sales, namely creation of preferential programs for customers; development of bonus programs for customers in sports stadiums by distributing encoded loyalty and membership cards that may contain users' personal data; development, launch and administration of loyalty programs, namely issuing loyalty cards to fans, that contain personal information on the identity of the card holder; electronic commerce (e-commerce) services, namely provision of information on goods via telecommunication networks for advertising or sales purposes; compilation of data into a computer database, especially still or animated images; e-commerce services, namely online services for providing contracts for the purchase and sale of goods on behalf of others; promotion of football-related sports events; promotion of the goods and services of others, through contractual agreements, particularly partnership (sponsoring) and licensing agreements, providing them with increased notoriety and enhanced image derived from cultural and sporting events, particularly international events; compilation and recording of data and information on sporting performances; provision of personnel, particularly for selling beverages and foods; promotion of football events; retail services for goods for interactive education and entertainment purposes, compact disks, CD-ROMs and computer games; Retail sale services, particularly on a global computer network, for interactive educational and entertainment products, interactive compact disks, CD-ROMs and computer games; presentation of computer programs for retail sale purposes; procurement services for others (purchasing goods and services for other businesses); procurement services for others (purchasing goods and services for other businesses) for sports events or entertainment; promotion of the goods and services of others, through contractual agreements, particularly partnership (sponsoring) and licensing agreements, providing them with increased notoriety and/or enhanced image and/or sympathy derived from cultural and sporting events, particularly international events.

39 – Operation of a travel agency, namely travel arrangement and reservations; ticket reservation and information services for travel; transport by airplane, railway, bus and truck; Boat transport; boat travel services; tourist travel services; vehicle rental; rental of parking spaces; taxi services; boat transport services for goods; distribution of water, heat, gas or electricity; distribution of newspapers, magazines and books; postal services, mail delivery and courier services; storage of goods; delivery of solvents, paraffins, waxes, bitumens and petroleum products, excluding liquid gas; distribution (delivery) of films and sound and image recordings; distribution (deli-

very) of interactive educational and entertainment products, interactive compact disks, CD-ROMs, computer programs and computer games; advisory services relating to power and electricity distribution.

41 – Education; training; entertainment; organization of lotteries, raffles and competitions; betting and gaming services in connection with sports; hospitality services (sports, entertainment), namely providing entry tickets and information brochures on sports for VIPs, as well as guiding and gathering VIPs during sports or entertainment events; hospitality services, namely customer reception services (entertainment services), including providing entry tickets to sports or entertainment events; entertainment services relating to sporting events; entertainment services in the form of public gatherings during the retransmission of sports events; sporting and cultural activities; organization of sporting and cultural events and activities; organization of sports competitions; organization of events in the field of football; sports camp services; operation of sports facilities; rental of video and audiovisual installations; production, presentation, distribution and/or rental of film recordings and sound and video recordings; presentation, distribution and/or rental of interactive educational and entertainment products, interactive compact disks, CD-ROMs, and computer games; radio and television coverage of sporting events; production services for radio and television programs and video films; ticket reservation services and information services for sports or entertainment events; sports events timing services; organization of beauty contests; interactive entertainment; on-line betting and gaming services on the Internet or on any wireless electronic communication network; entertainment information (including in the field of sports), provided on-line from a computer database or via the Internet or via any wireless electronic communication network; electronic game services transmitted via the Internet or on mobile telephones; book publishing; publication of books and electronic journals on-line; audio and video recording services; production of animated cartoons for movies, production of animated cartoons for television; rental of sound and image recordings for entertainment purposes; education information provided on-line from a computer database or via the Internet or any wireless electronic communication network; translation services; photographic services; provision of entertainment infrastructures; ticket agency services in connection with sports events.

43 – Providing food and drink, snack-bars; hospitality services, namely providing of food and drink; food and drink catering; hotel services; providing accommodation and food and drink, booking hotels and temporary accommodation; hospitality services, namely providing food and drink at sports and entertainment events.

(260) AM 2014 72269 A
 (800) 1157201
 (151) 2012 11 19
 (731) WORLD MEDICINE İLAÇLARI LİMİTED
 ŞİRKETİ
 Evren Mah., Camiyolu Cad. No.50
 K.2, GÜNEŞLİ/BAĞCILAR/İSTANBUL,
 Turkey

(540)

LIMENDA

(591) Black, white

(511)

5 – Medicines for human purposes, medicines for veterinary purposes, chemical preparations for medical purposes, dietetic substances adapted for medical use; dietetic foods adapted for medical purposes; aminoacids for medical purposes, nutritional supplements, pollen dietary substances, mineral food supplements, protein dietary supplements, baby foods, medicinal herbs, herbal beverages adapted for medical purposes; medicines for dental purposes, hygienic products for medical purposes including pads, waddings for medical purposes, plasters for medical purposes, dressings for medical purposes, preparations for destroying noxious plants, preparations for destroying noxious animals, fungicides, disinfectants for hygiene purposes, antiseptics, detergents for medical purposes.

(260) AM 2014 72276 A

(800) 1157255

(151) 2012 11 12

(731) WORLD VET İLAÇ SANAYİ VE TİCARET
 LİMİTED ŞİRKETİ
 Evren Mah. Camiyolu Cad. No.50 K.1,
 GÜNEŞLİ İSTANBUL, Turkey

(540)

PensVET LA

(591) Black, white

(511)

5 – Medicines for human purposes, medicines for veterinary purposes, chemical preparations for medical purposes, dietetic substances adapted for medical use; dietetic foods adapted for medical purposes; amino acids for medical purposes, nutritional supplements, pollen dietary substances, mineral food supplements, protein dietary supplements, baby foods, medicinal herbs, herbal beverages adapted for medical purposes; medicines for dental purposes, hygienic products for medical purposes including pads, waddings for medical purposes, plasters for medical purposes, dressings for medical purposes, preparations for destroying noxious plants, preparations for destroying noxious animals, fungicides, disinfectants for hygiene purposes, antiseptics, detergents for medical purposes.

(260) AM 2014 72279 A

(800) 1157333

(151) 2013 03 29

(731) Obshchestvo s ogranichennoy
 otvetstvennostyu "RUSINVEST"
 Novomytishchenskiy prospekt, 41, korp. 1,
 Mytishchi, RU-141018 Moskovskaya Oblast,
 Russian Federation

(540)

E J A X A

(591) Black, white

(511)

32 – Beers; mineral and aerated waters and other non-alcoholic beverages; fruit beverages and fruit juices; syrups and other preparations for making beverages.

33 – Alcoholic beverages (except beers).

(260) AM 2014 72280 A

(800) 155119

(151) 1951 07 23

(891) 2013 03 27

(731) Boehringer Ingelheim Pharma GmbH & Co.
 KG
 55218 Ingelheim, Germany

(540)

Thomapyrin

(591) Black, white

(511)

1 – Food preserving products.

(260) AM 2014 72281 A

(800) 860378

(151) 2005 05 04

(891) 2013 02 27

(731) AKAPP-Stemmann B.V.
 Nijverheidsweg 14, NL-3771 ME Barneveld,
 Netherlands

(540)

AKAPP

(591) Black, white

(511)

9 – Electric cables and other electric installation equipment; equipment for electric wires and cables; connections for electric wires and cables; coaxial cables; devices, instruments and devices for measuring cables, wires, steel wires, lines and pipes; electric installations composed of guiding instruments for supply and/or electronic control of mobile apparatus and machines and/or their parts; friction contacts (electric components); electrical junctions, junction boxes, connecting terminals; bus bars, sheaths for electric cables; electrical outlets and plugs.

(260) AM 2014 72287 A
 (800) 1131972
 (151) 2012 06 27
 (891) 2013 01 21
 (731) G-Star Raw C.V.
 Keienbergweg 100 NL-1101, GH
 AMSTERDAM ZUIDOOST,
 Netherlands

(540)

RAW

(591) Black, white

(511)

18 – Goods of leather or imitations of leather included in this class; trunks and traveling bags; rucksacks; bags; wallets; umbrellas; parasols and walking sticks.

25 – Clothing; footwear; headgear; belts (clothing).

35 – Retail store services in the field of soaps, perfumery, essential oils, cosmetics, hair lotions, dentifrices, sunglasses and spectacles, spectacle frames, spectacle glasses, spectacle cases, sound-, image and data carriers, such as CD's and DVD's, jewelry, bijoux, horological and chronometric instruments, including watches, goods of leather or imitation of leather, trunks and traveling bags, rucksacks, bags, wallets, umbrellas, parasols and walking sticks, clothing, footwear, headgear, belts (clothing) and fashion accessories; business intermediary services relating to the purchase and sale of soaps, perfumery, essential oils, cosmetics, hair lotions, dentifrices, sunglasses and spectacles, spectacle frames, spectacle glasses, spectacle cases, sound, image and data carriers, such as CD's and DVD's, jewelry, bijoux, horological and chronometric instruments, including watches, goods of leather or imitations of leather, trunks and traveling bags, rucksacks, bags, wallets, umbrellas, parasols and walking sticks, clothing, footwear, headgear, belts (clothing) and fashion accessories; business management; business administration and administrative services; sales promotion; commercial business and administrative services in the field of the franchising and exploitation of retail businesses.

(260) AM 2014 72288 A
 (800) 1138127
 (151) 2012 10 18
 (891) 2013 02 27
 (731) Denard Ltd. Offices of Aleman, Cordero,
 Galindo & Lee Trust (BVI) Limited
 P.O. Box 3175 Road Town, Tortola, British
 Virgin Islands

(540)

OSTIN

(591) Black, white

(511)

18 – Leather and imitations of leather, and goods made of these materials and not included in other classes; trunks and travelling bags; umbrellas, parasols and walking sticks.

25 – Clothing, footwear, headgear.

35 – Sales promotion (for others).

(260) AM 2014 72663 A

(800) 1160729

(151) 2013 04 16

(731) ENTERPRISE HOLDINGS, INC.
 600 CORPORATE PARK DRIVE
 ST. LOUIS MO 63105, USA

(540)

VIRTUAL CAR

(591) Black, white

(511)

39 – Rental and leasing services, and reservation services for the rental and leasing of vehicles.

(260) AM 2014 72664 A

(800) 1160745

(151) 2013 04 09

(731) Japan Tobacco Inc.
 2-2-1 Toranomom, Minato-ku, Tokyo, Japan

(540)



(591) Black, white

(511)

34 – Tobacco, raw or manufactured; smoking tobacco, pipe tobacco, rolling tobacco, chewing tobacco, moist tobacco powder called "snus"; cigarettes, cigars, cigarillos; substances for smoking sold separately or mixed with tobacco for non-medical and non-therapeutic purposes; snuff; smokers' articles included in this class; cigarette paper, cigarette tubes and matches.

(260) AM 2014 72665 A

(800) 1160746

(151) 2013 04 09

(731) Japan Tobacco Inc.
 2-2-1 Toranomom, Minato-ku, Tokyo, Japan

(540)

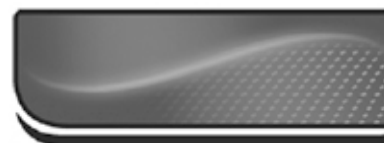

(591) Black, white

(511)

34 – Tobacco, raw or manufactured; smoking tobacco, pipe tobacco, rolling tobacco, chewing tobacco, moist tobacco powder called "snus"; cigarettes, cigars, cigarillos; substances for smoking sold separately or mixed with tobacco for non-medical and non-therapeutic purposes; snuff; smokers' articles included in this class; cigarette paper, cigarette tubes and matches.

(260) AM 2014 72666 A

(800) 1160759

(151) 2013 04 12

(731) Dr. THEISS Naturwaren GmbH
Michelinstr. 10, 66424 Homburg, Germany

(540)

DR.THEISS
AQUAMED COSMETICS



(591) Blue and grey

(511)

3 – Bleaching preparations and other substances for laundry use; cleaning, polishing, scouring and abrasive preparations; soaps; perfumery, ethereal oils, cosmetics, including non-medicated preparations for cleaning and caring for the skin, and hair care preparations; hair lotions; dentifrices.

5 – Pharmaceutical and veterinary preparations; medicines for human or veterinary purposes; sanitary preparations for medical purposes; food and dietetic substances adapted for medical use, food for babies; nutritional supplements; vitamin preparations, including beauty capsules; plasters, materials for dressings; material for stopping teeth, dental wax; disinfectants.

(260) AM 2014 72667 A

(800) 1160819

(151) 2013 04 02

(731) Tamasu Butterfly Europa GmbH
Am Schürmannshütt 30h, 47441 Moers,
Germany

(540)



(591) Black, white

(511)

18 – Bags; bags for sports; luggage boxes.

24 – Hand towels.

25 – Clothing, in particular outer clothing, winter jackets, windbreakers, fleece jackets, underpants, T-shirts, sportswear and leisurewear, sport shirts, sport trousers, training suits, jogging suits and leotards, sweatbands and headbands, knitwear, in particular stockings, socks, sports socks, sweaters, singlets, jersey clothing; knitwear (clothing), in particular jumpers, sweatshirts; terry-towelling goods, namely bathrobes; footwear, in particular sports shoes and sports shoes for tennis and table tennis; headgear, in particular caps.

28 – Articles of sporting apparatus; sports and games equipment for table tennis and tennis, and parts therefor; ball pitching machines; table tennis tables and parts therefor.

(260) AM 2014 73218 A

(800) 1166350

(151) 2013 05 22

(731) Schöffel Sportbekleidung GmbH
Ludwig-Schöffel-Strasse 15, 86830
Schwabmünchen, Germany

(540)

VENTLOFT

(591) Black, white

(511)

9 – Bags specially adapted to mobile phones and tablet computers.

24 – Blankets, including quilts; pillowcases.

25 – Clothing, in particular outdoor and functional clothing, (as far as included class 25); gloves, including ski gloves and mittens; footwear, including slippers and slipper socks as well as wadded footlets; headgear.

(260) AM 2014 73676 A

(800) 1171238

(151) 2012 12 11

(731) WORLD MEDICINE İLAÇLARI LİMİTED
SİRKETİ
Evren Mah. Camiyolu Cad. No.50 K:2,
İSTANBUL, Turkey

(540)

My Source Lotion

(591) Black, white

(511)

3 – Detergents other than for use in manufacturing operations and for medical purposes, laundry bleach, laundry starch blueing for laundry, soft soap, fabric softeners for laundry purposes, cleaning preparations for waste pipes, granular soap; windscreen cleaning liquids, preparations for bleaching and polishing purposes; perfumery, ethereal essences, eau de cologne, lotions, deodorants for human beings, rose

oil, after-shave lotions, antiperspirant deodorants; cosmetic products, nail polish, lipsticks, mascara, cosmetic creams, hair dyes, shampoos, hair care preparations, eyebrow pencils, powders for cosmetic purposes, acetone (for cosmetic purposes), shaving preparations, shower gel, petroleum jelly for cosmetic purposes, depilatory preparations, cosmetic dyes, cosmetics preparations for slimming purposes, cosmetic kits, tissues impregnated with cosmetic lotions, cotton wool and cotton sticks for cosmetic purposes, wet tissues; soaps for personal use including medical purposes and deodorant soap, disinfectant soap, antiperspirant soap; tooth care products, toothpastes, dentifrices, tooth cleaning materials for medical purposes, tooth cleaning powders, tooth waters preparations for cleaning dentures, mouth washes, not for medical purposes, anti-tartar tooth pastes; abrasive products namely, emery clothes, emery papers, pumice stones, including pastes; polishing preparations; leather preservative polishes, polish for furniture and flooring; oils for cosmetic purposes.

35 – Services related to advertising, marketing and public relations including organization of exhibitions and fairs for commercial or advertising purposes, office services, business management and administration, consultancy for business management and administration including accountancy services, import export agency services, commercial and industrial management expertise services, organization of auctioneering services and auctioneering, the bringing together of detergents other than for use in manufacturing operations and for medical purposes, laundry bleach, laundry starch blueing for laundry, soft soap, fabric softeners for laundry purposes, cleaning preparations for waste pipes, granular soap; windscreen cleaning liquids, preparations for bleaching and polishing purposes; perfumery, ethereal essences, eau de cologne, lotions, deodorants for human beings, rose oil, after-shave lotions, antiperspirant deodorants; cosmetic products, nail polish, lipsticks, mascara, cosmetic creams, hair dyes, shampoos, hair care preparations, eyebrow pencils, powders for cosmetic purposes, acetone (for cosmetic purposes), shaving preparations, shower gel, petroleum jelly for cosmetic purposes, depilatory preparations, cosmetic dyes, cosmetics preparations for slimming purposes, cosmetic kits, tissues impregnated with cosmetic lotions, cotton wool and cotton sticks for cosmetic purposes, wet tissues; soaps for personal use including medical purposes and deodorant soap, disinfectant soap, antiperspirant soap; tooth care products, toothpastes, dentifrices, tooth cleaning materials for medical purposes, tooth cleaning powders, tooth waters preparations for cleaning dentures, mouth washes, not for medical purposes, anti-tartar tooth pastes; abrasive products namely, emery clothes, emery papers, pumice stones, including pastes; polishing preparations; leather

preservative polishes, polish for furniture and flooring; oils for cosmetic purposes, enabling customers to conveniently view and purchase those goods, the mentioned services can be provided by wholesale outlets, retail stores, by means of electronic media or through mail order catalogues and other similar methods.

44 – Medical services; hygienic and beauty care for human beings; veterinary and animal breeding services, agriculture, horticulture and forestry services.

(260) AM 2014 73678 A
(800) 1171299
(151) 2013 07 09
(731) GUK-Falzmaschinen Griesser & Kunzmann GmbH & Co. KG
Bahnhofstraße 4, 78669 Wellendingen, Germany
(540)



(591) Red, blue and white
(511)
7 – Folding machines, paper cutting machines, packaging machines and parts therefor, included in this class.

(260) AM 2014 73679 A
(800) 1171309
(151) 2013 07 02
(731) Bayer Intellectual Property GmbH
Alfred-Nobel-Straße 10, 40789 Monheim am Rhein, Germany
(540)



(591) Aqua blue, green, lime.
(511)
5 – Pharmaceutical preparations for the treatment of cancer.

(260) AM 60858 A *
(800) 1059579
(731) NOVARTIS AG
CH-4002 Basel, Switzerland
(540)

AFLUCELL

(591) Black, white
(511)
5 – Vaccines for human use.

**საერთაშორისო სასაქონლო ნიშნები,
რომლებსაც მიენიჭათ დაცვა საქართველოში**

(260) AM 2013 68887 A
(800) 1125657
(151) 2012 06 07
(181) 2022 06 07
(511) 07, 12, 35, 37, 40, 42

(260) AM 2013 68896 A
(800) 1125802
(151) 2012 06 04
(181) 2022 06 04
(511) 06, 21

(260) AM 2013 68888 A
(800) 1125711
(151) 2012 02 13
(181) 2022 02 13
(511) 29

(260) AM 2013 68897 A
(800) 1125824
(151) 2012 06 19
(181) 2022 06 19
(511) 12

(260) AM 2013 68889 A
(800) 1125726
(151) 2012 06 19
(181) 2022 06 19
(511) 12

(260) AM 2013 68898 A
(800) 1125825
(151) 2012 06 19
(181) 2022 06 19
(511) 12

(260) AM 2013 68890 A
(800) 1125753
(151) 2012 02 29
(181) 2022 02 28
(511) 18, 25

(260) AM 2013 68899 A
(800) 1125861
(151) 2011 10 07
(181) 2021 10 07
(511) 09, 35, 36, 37, 38, 41, 42

(260) AM 2013 68891 A
(800) 1125754
(151) 2012 03 27
(181) 2022 03 27
(511) 09, 42

(260) AM 2013 68900 A
(800) 1125871
(151) 2012 07 23
(181) 2022 07 23
(511) 05

(260) AM 2013 68892 A
(800) 1125758
(151) 2012 03 02
(181) 2022 03 02
(511) 03

(260) AM 2013 68912 A
(800) 1125883
(151) 2011 09 06
(181) 2021 09 06
(511) 06, 07, 12

(260) AM 2013 68895 A
(800) 1125788
(151) 2012 05 15
(181) 2022 05 15
(511) 34

(260) AM 2013 68913 A
(800) 1125899
(151) 2011 10 20
(181) 2021 10 20
(511) 35, 38, 41

(260) AM 2013 68915 A
 (800) 1125907
 (151) 2011 10 28
 (181) 2021 10 28
 (511) 06, 07, 08, 09, 16, 17, 38, 41, 42

(260) AM 2013 69526 A
 (800) 925099
 (151) 2007 04 06
 (891) 2012 09 21
 (181) 2017 04 06
 (511) 18, 25

(260) AM 2013 69071 A
 (800) 1127704
 (151) 2012 05 08
 (181) 2022 05 08
 (511) 11, 20, 21

(260) AM 2013 69715 A
 (800) 1096672
 (151) 2011 10 20
 (891) 2012 09 27
 (181) 2021 10 20
 (511) 05

(260) AM 2013 69074 A
 (800) 1127814
 (151) 2012 06 20
 (181) 2022 06 20
 (511) 13

(260) AM 2013 69881 A
 (800) 1135811
 (151) 2012 09 24
 (181) 2022 09 24
 (511) 41

(260) AM 2013 69075 A
 (800) 1127838
 (151) 2012 08 13
 (181) 2022 08 13
 (511) 35

(260) AM 2013 69882 A
 (800) 1135838
 (151) 2012 09 28
 (181) 2022 09 28
 (511) 25

(260) AM 2013 69146 A
 (800) 798100
 (151) 2002 12 30
 (891) 2012 06 18
 (181) 2012 12 30
 (511) 25

(260) AM 2013 69883 A
 (800) 1135862
 (151) 2012 09 26
 (181) 2022 09 26
 (511) 05

(260) AM 2013 69151 A
 (800) 910184
 (151) 2006 05 25
 (891) 2012 06 04
 (181) 2016 05 25
 (511) 02

(260) AM 2013 69884 A
 (800) 1135875
 (151) 2012 08 22
 (181) 2022 08 22
 (511) 05

(260) AM 2013 69235 A
 (800) 1092143
 (151) 2011 07 19
 (891) 2012 08 29
 (181) 2021 07 19
 (511) 05

(260) AM 2013 69886 A
 (800) 1135890
 (151) 2012 10 04
 (181) 2022 10 04
 (511) 05

(260) AM 2013 69416 A
 (800) 1131557
 (151) 2012 04 20
 (181) 2022 04 20
 (511) 30

(260) AM 2013 69888 A
 (800) 1135954
 (151) 2012 06 19
 (181) 2022 06 19
 (511) 01, 02, 19

(260) AM 2013 69889 A
(800) 1135981
(151) 2012 07 17
(181) 2022 07 17
(511) 16

(260) AM 2013 69890 A
(800) 1135987
(151) 2012 09 18
(181) 2022 09 18
(511) 03, 16, 44

(260) AM 2013 69892 A
(800) 1135991
(151) 2012 07 27
(181) 2022 07 27
(511) 05

(260) AM 2013 69893 A
(800) 1136005
(151) 2012 09 19
(181) 2022 09 19
(511) 32, 33

(260) AM 2013 69894 A
(800) 1136026
(151) 2012 09 28
(181) 2022 09 28
(511) 14

(260) AM 2013 69942 A
(800) 1136712
(151) 2012 09 28
(181) 2022 09 28
(511) 09

(260) AM 2013 69943 A
(800) 1136736
(151) 2011 12 26
(181) 2021 12 26
(511) 30

(260) AM 2013 69944 A
(800) 1136737
(151) 2012 01 25
(181) 2022 01 25
(511) 09, 16, 35, 36, 38, 42, 45

(260) AM 2013 69945 A
(800) 1136742
(151) 2012 04 27
(181) 2022 04 27
(511) 05, 10

(260) AM 2013 69946 A
(800) 1136760
(151) 2012 07 05
(181) 2022 07 05
(511) 03

(260) AM 2013 69947 A
(800) 1136763
(151) 2012 06 29
(181) 2022 06 29
(511) 01, 05

(260) AM 2013 69948 A
(800) 1136786
(151) 2012 08 27
(181) 2022 08 27
(511) 30

(260) AM 2013 69949 A
(800) 1136787
(151) 2012 08 27
(181) 2022 08 27
(511) 29, 30

(260) AM 2013 69950 A
(800) 1136841
(151) 2012 10 10
(181) 2022 10 10
(511) 09

(260) AM 2013 69951 A
(800) 1136847
(151) 2012 10 04
(181) 2022 10 04
(511) 01, 04, 16, 35, 37, 39, 40, 42

(260) AM 2013 69952 A
(800) 1136868
(151) 2012 10 22
(181) 2022 10 22
(511) 29, 30

(260) AM 2013 69953 A
(800) 1136882
(151) 2012 07 23
(181) 2022 07 23
(511) 05, 29, 30

(260) AM 2013 70151 A
(800) 1138836
(151) 2012 11 02
(181) 2022 11 02
(511) 05

(260) AM 2013 69954 A
(800) 1136884
(151) 2012 08 16
(181) 2022 08 16
(511) 03, 05, 29

(260) AM 2013 70152 A
(800) 1138870
(151) 2012 09 28
(181) 2022 09 28
(511) 09, 38

(260) AM 2013 69966 A
(800) 1137137
(151) 2012 08 27
(181) 2022 08 27
(511) 02, 08, 27, 37

(260) AM 2013 70153 A
(800) 1138910
(151) 2012 08 01
(181) 2022 08 01
(511) 05

(260) AM 2013 70065 A
(800) 1138346
(151) 2012 02 01
(181) 2022 02 01
(511) 05, 16, 29, 30, 43, 44

(260) AM 2013 70154 A
(800) 1138917
(151) 2012 05 23
(181) 2022 05 23
(511) 09, 38

(260) AM 2013 70066 A
(800) 1138352
(151) 2012 05 22
(181) 2022 05 22
(511) 25

(260) AM 2013 70159 A
(800) 1138952
(151) 2012 03 21
(181) 2022 03 21
(511) 18, 25, 35

(260) AM 2013 70069 A
(800) 1138379
(151) 2012 07 05
(181) 2022 07 05
(511) 35, 39, 42, 43

(260) AM 2013 70160 A
(800) 1139041
(151) 2012 10 10
(181) 2022 10 10
(511) 01

(260) AM 2013 70149 A
(800) 1138813
(151) 2012 02 03
(181) 2022 02 03
(511) 05

(260) AM 2013 70167 A
(800) 1139255
(151) 2012 09 25
(181) 2022 09 25
(511) 01, 05

(260) AM 2013 70150 A
(800) 1138830
(151) 2012 09 04
(181) 2022 09 04
(511) 05

(260) AM 2013 70168 A
(800) 1139307
(151) 2012 09 21
(181) 2022 09 21
(511) 05

(260) AM 2013 70169 A
(800) 1139372
(151) 2012 08 10
(181) 2022 08 10
(511) 09, 35, 38, 41, 42

(260) AM 2013 70178 A
(800) 1138834
(151) 2012 10 04
(181) 2022 10 04
(511) 01, 04, 16, 35, 37, 39, 40, 42

(260) AM 2013 70170 A
(800) 1139416
(151) 2012 10 24
(181) 2022 10 24
(511) 11

(260) AM 2013 70179 A
(800) 1138873
(151) 2012 08 31
(181) 2022 08 31
(511) 30

(260) AM 2013 70171 A
(800) 1138421
(151) 2012 07 27
(181) 2022 07 27
(511) 03, 35, 39, 41, 43, 44

(260) AM 2013 70180 A
(800) 1138961
(151) 2012 05 22
(181) 2022 05 22
(511) 05, 10, 35, 36, 39, 44

(260) AM 2013 70172 A
(800) 1138464
(151) 2012 09 26
(181) 2022 09 26
(511) 05

(260) AM 2013 70181 A
(800) 1138966
(151) 2012 05 10
(181) 2022 05 10
(511) 30

(260) AM 2013 70173 A
(800) 1138566
(151) 2012 09 24
(181) 2022 09 24
(511) 02

(260) AM 2013 70183 A
(800) 1139034
(151) 2012 08 17
(181) 2022 08 17
(511) 36

(260) AM 2013 70174 A
(800) 1138582
(151) 2012 07 25
(181) 2022 07 25
(511) 07, 09, 12

(260) AM 2013 70184 A
(800) 1139131
(151) 2012 09 06
(181) 2022 09 06
(511) 32

(260) AM 2013 70176 A
(800) 1138796
(151) 2012 07 13
(181) 2022 07 13
(511) 14

(260) AM 2013 70185 A
(800) 1139158
(151) 2012 09 06
(181) 2022 09 06
(511) 36, 39

(260) AM 2013 70177 A
(800) 1138833
(151) 2012 10 04
(181) 2022 10 04
(511) 01, 04, 16, 35, 37, 39, 40, 42

(260) AM 2013 70186 A
(800) 1139335
(151) 2012 10 04
(181) 2022 10 04
(511) 29

(260) AM 2013 70187 A
 (800) 1139370
 (151) 2012 08 24
 (181) 2022 08 24
 (511) 09, 35, 38, 41, 42

(260) AM 2013 70318 A
 (800) 1140582
 (151) 2012 05 22
 (181) 2022 05 22
 (511) 01, 02, 16, 35, 37, 40, 42

(260) AM 2013 70194 A
 (800) 453571
 (151) 1980 05 16
 (891) 2012 10 29
 (181) 2020 05 16
 (511) 14

(260) AM 2013 70320 A
 (800) 1140599
 (151) 2012 08 07
 (181) 2022 08 07
 (511) 09, 35, 38, 42, 45

(260) AM 2013 70202 A
 (800) 813866
 (151) 2003 10 14
 (891) 2012 10 19
 (181) 2013 10 14
 (511) 07

(260) AM 2013 70321 A
 (800) 1140612
 (151) 2012 08 10
 (181) 2022 08 10
 (511) 09, 35, 38, 41, 42

(260) AM 2013 70203 A
 (800) 851352
 (151) 2005 05 31
 (891) 2012 11 05
 (181) 2015 05 31
 (511) 03, 18, 25

(260) AM 2013 70322 A
 (800) 1140661
 (151) 2012 10 18
 (181) 2022 10 18
 (511) 07, 12

(260) AM 2013 70204 A
 (800) 857367
 (151) 2005 07 27
 (891) 2012 10 12
 (181) 2015 07 27
 (511) 14

(260) AM 2013 70323 A
 (800) 1140675
 (151) 2012 10 12
 (181) 2022 10 12
 (511) 30

(260) AM 2013 70253 A
 (800) 1140259
 (151) 2012 09 04
 (181) 2022 09 04
 (511) 12

(260) AM 2013 70324 A
 (800) 1140676
 (151) 2012 10 12
 (181) 2022 10 12
 (511) 30

(260) AM 2013 70255 A
 (800) 1140270
 (151) 2012 09 20
 (181) 2022 09 20
 (511) 05

(260) AM 2013 70325 A
 (800) 1140677
 (151) 2012 09 07
 (181) 2022 09 07
 (511) 05, 35

(260) AM 2013 70326 A
 (800) 1140711
 (151) 2012 10 29
 (181) 2022 10 29
 (511) 01, 03, 05, 42, 44

(260) AM 2013 70327 A
(800) 1140712
(151) 2012 10 22
(181) 2022 10 22
(511) 04, 07, 35, 37, 42

(260) AM 2013 70342 A
(800) 1140888
(151) 2012 11 07
(181) 2022 11 07
(511) 43

(260) AM 2013 70328 A
(800) 1140723
(151) 2012 10 08
(181) 2022 10 08
(511) 03

(260) AM 2013 70343 A
(800) 1140906
(151) 2012 02 19
(181) 2022 02 19
(511) 06, 19, 35, 39

(260) AM 2013 70329 A
(800) 1140724
(151) 2012 10 08
(181) 2022 10 08
(511) 03

(260) AM 2013 70382 A
(800) 1141464
(151) 2012 08 30
(181) 2022 08 30
(511) 35, 36

(260) AM 2013 70330 A
(800) 1140740
(151) 2012 08 29
(181) 2022 08 29
(511) 05, 10

(260) AM 2013 70383 A
(800) 1141472
(151) 2012 09 19
(181) 2022 09 19
(511) 09, 35, 38, 41

(260) AM 2013 70331 A
(800) 1140749
(151) 2012 08 31
(181) 2022 08 31
(511) 30

(260) AM 2013 70384 A
(800) 1141527
(151) 2012 10 09
(181) 2022 10 09
(511) 18, 25

(260) AM 2013 70339 A
(800) 1140854
(151) 2012 09 05
(181) 2022 09 05
(511) 12, 35, 37, 39, 40, 42

(260) AM 2013 70385 A
(800) 1141541
(151) 2012 08 31
(181) 2022 08 31
(511) 14, 18, 25, 26

(260) AM 2013 70340 A
(800) 1140886
(151) 2012 11 07
(181) 2022 11 07
(511) 43

(260) AM 2013 70386 A
(800) 1141548
(151) 2012 08 10
(181) 2022 08 10
(511) 25

(260) AM 2013 70341 A
(800) 1140887
(151) 2012 11 07
(181) 2022 11 07
(511) 43

(260) AM 2013 70387 A
(800) 1012579
(151) 2009 08 06
(891) 2012 10 10
(181) 2019 08 06
(511) 29, 31

(260) AM 2013 70391 A
(800) 969690
(151) 2008 06 09
(891) 2012 11 13
(181) 2018 06 09
(511) 43

(260) AM 2013 70393 A
(800) 1004231
(151) 2009 02 18
(891) 2012 09 06
(181) 2019 02 18
(511) 18, 25

(260) AM 2013 70394 A
(800) 1005125
(151) 2009 06 12
(891) 2012 11 13
(181) 2019 06 12
(511) 33

(260) AM 2013 70395 A
(800) 1010001
(151) 2009 07 05
(891) 2012 10 11
(181) 2019 07 05
(511) 03, 05

(260) AM 2013 70396 A
(800) 1018407
(151) 2009 07 21
(891) 2012 10 17
(181) 2019 07 21
(511) 07, 11

(260) AM 2013 70397 A
(800) 1024016
(151) 2009 11 03
(891) 2012 10 15
(181) 2019 11 03
(511) 35, 41

ოფიციალური შეტყობინებები
პატენტების მოქმედების აღდგენა
ბამობონება

(11) P 2011 5346 B

(73) ომარ ლომთაძე (GE);

მიხეილ ჟღენტი (GE);

გივი ჩიმაკაძე (GE)

(54) **აპარატიული თვისების უეთოვანოვლიანი ემულსიის კონცენტრატი**

პატენტის მოქმედების აღდგენის თარიღი: 2014 03 10

(11) P 2012 5608 B

(73) მარსელ კაპანაძე (GE)

(54) **ენერგეტიკული დანადგარი**

პატენტის მოქმედების აღდგენის თარიღი: 2014 03 10

სასაქონლო ნიშნები

სასაქონლო ნიშნის რეგისტრაციის ბათილად ცნობა

(111) M 2003 14947 R

(151) 2003 01 30

(141) 2013 07 30, არ არის გადახდილი
რეგისტრაციის შემდგომი 10 წლით
გაგრძელების საფასური

(732) ზაკრიტოე აკციონერნოე ობშჩესტვო
„ფარმაცევტიკაია ფირმა „დარნიცა“
ბორისპოლსკაია 13, 02093, კიევი,
უკრაინა

სისტემური საძიებლები

გამომონებები

საერთაშორისო კლასიფიკაციის ინდექსის და განაცხადის
გამოქვეყნების ნომრის შესაბამისობის ცხრილი

საერთაშორისო კლასიფიკაციის ინდექსი (51)	განაცხადის გამოქვეყნების ნომერი (10)
C 07 D 231/12; C 07 D 401/04; C 07 D 401/06; C 07 D 401/12; C 07 D 401/14	AP 2014 12624 A

განაცხადის გამოქვეყნების ნომრის და საერთაშორისო
კლასიფიკაციის ინდექსის შესაბამისობის ცხრილი

განაცხადის გამოქვეყნების ნომერი (10)	საერთაშორისო კლასიფიკაციის ინდექსი (51)
AP 2014 12624 A	C 07 D 231/12; C 07 D 401/04; C 07 D 401/06; C 07 D 401/12; C 07 D 401/14

საერთაშორისო კლასიფიკაციის ინდექსის, პატენტის ნომრისა
და გამოქვეყნების ნომრის შესაბამისობის ცხრილი

საერთაშორისო კლასიფიკაციის ინდექსი (51)	პატენტის ნომერი (11)	განაცხადის გამოქვეყნების ნომერი (10)
A 01 N 43/62; A 61 K 31/55	P 2014 6052 B	AP 2013 12106 A
A 61 K 33/26; A 61 K 49/00; H 01 F 1/28; H 05 B 6/10	P 2014 6058 B	AP 2013 12942 A
A 61 K 39/395; C 07 K 16/22; G 01 N 33/53; C 12 N 15/68, 5/10; A 61 P 25/00, 35/00	P 2014 6050 B	AP 2013 11890 A
A 61 L 2/16; A 61 L 2/18	P 2014 6051 B	AP 2013 12078 A
C 07 D 307/88; C 07 D 405/08; C 07 D 407/08; C 07 D 413/08; C 07 D 487/08; C 07 D 493/04; C 07 D 295/135; C 07 D 295/155; A 61 K 31/495; A 61 K 31/529; A 61 P 7/10	P 2014 6055 B	AP 2013 12494 A
C 07 D 473/04; C 07 D 487/04; A 61 K 31/52; A 61 K 31/519; A 61 P 37/00	P 2014 6053 B	AP 2013 12209 A
C 07 K 14/605; A 61 K 38/26; A 61 P 5/48	P 2014 6056 B	AP 2013 12567 A
C 12 C 11/00	P 2014 6057 B	AP 2013 12620 A
F 16 H 3/56	P 2014 6054 B	AP 2013 12491 A

**კატენტის ნომრის, ბანაცხადის ბამოქვეყნების ნომრისა
და სართაშორისო კლასიფიკაციის ინდექსის შესაბამისობის ცხრილი**

კატენტის ნომერი (11)	ბანაცხადის ბამოქვეყნების ნომერი (10)	სართაშორისო კლასიფიკაციის ინდექსი (51)
P 2014 6050 B	AP 2013 11890 A	A 61 K 39/395; C 07 K 16/22; G 01 N 33/53; C 12 N 15/68, 5/10; A 61 P 25/00, 35/00
P 2014 6051 B	AP 2013 12078 A	A 61 L 2/16; A 61 L 2/18
P 2014 6052 B	AP 2013 12106 A	A 01 N 43/62; A 61 K 31/55
P 2014 6053 B	AP 2013 12209 A	C 07 D 473/04; C 07 D 487/04; A 61 K 31/52; A 61 K 31/519; A 61 P 37/00
P 2014 6054 B	AP 2013 12491 A	F 16 H 3/56
P 2014 6055 B	AP 2013 12494 A	C 07 D 307/88; C 07 D 405/08; C 07 D 407/08; C 07 D 413/08; C 07 D 487/08; C 07 D 493/04; C 07 D 295/135; C 07 D 295/155; A 61 K 31/495; A 61 K 31/529; A 61 P 7/10
P 2014 6056 B	AP 2013 12567 A	C 07 K 14/605; A 61 K 38/26; A 61 P 5/48
P 2014 6057 B	AP 2013 12620 A	C 12 C 11/00
P 2014 6058 B	AP 2013 12942 A	A 61 K 33/26; A 61 K 49/00; H 01 F 1/28; H 05 B 6/10

**ბანაცხადის ნომრის, ბანაცხადის ბამოქვეყნების ნომრისა
და კატენტის ნომრის შესაბამისობის ცხრილი**

ბანაცხადის ნომერი (21)	ბანაცხადის ბამოქვეყნების ნომერი (10)	კატენტის ნომერი (11)
AP 2004 011890	AP 2013 11890 A	P 2014 6050 B
AP 2009 012078	AP 2013 12078 A	P 2014 6051 B
AP 2009 012106	AP 2013 12106 A	P 2014 6052 B
AP 2009 012209	AP 2013 12209 A	P 2014 6053 B
AP 2010 012494	AP 2013 12494 A	P 2014 6055 B
AP 2010 012567	AP 2013 12567 A	P 2014 6056 B
AP 2010 012620	AP 2013 12620 A	P 2014 6057 B
AP 2011 012491	AP 2013 12491 A	P 2014 6054 B

სასარგებლო მოდელები

საერთაშორისო კლასიფიკაციის ინდექსის და განაცხადის
გამოქვეყნების ნომრის შესაბამისობის ცხრილი

საერთაშორისო კლასიფიკაციის ინდექსი (51)	განაცხადის გამოქვეყნების ნომერი (10)
E 01 D 1/00	AU 2014 12841 U

განაცხადის გამოქვეყნების ნომრის და საერთაშორისო
კლასიფიკაციის ინდექსის შესაბამისობის ცხრილი

განაცხადის გამოქვეყნების ნომერი (10)	საერთაშორისო კლასიფიკაციის ინდექსი (51)
AU 2014 12841 U	E 01 D 1/00

საერთაშორისო კლასიფიკაციის ინდექსის, კატეგორიის ნომრისა
და გამოქვეყნების ნომრის შესაბამისობის ცხრილი

საერთაშორისო კლასიფიკაციის ინდექსი (51)	კატეგორიის ნომერი (11)	განაცხადის გამოქვეყნების ნომერი (10)
A 23 L 1/22	U 2014 1803 Y	AU 2013 13085 U
A 61 K 9/02	U 2014 1801 Y	AU 2013 12914 U
A 61 K 9/02	U 2014 1802 Y	AU 2013 12915 U

კატეგორიის ნომრის, განაცხადის გამოქვეყნების ნომრისა
და საერთაშორისო კლასიფიკაციის ინდექსის შესაბამისობის ცხრილი

კატეგორიის ნომერი (11)	განაცხადის გამოქვეყნების ნომერი (10)	საერთაშორისო კლასიფიკაციის ინდექსი (51)
U 2014 1801 Y	AU 2013 12914 U	A 61 K 9/02
U 2014 1802 Y	AU 2013 12915 U	A 61 K 9/02
U 2014 1803 Y	AU 2013 13085 U	A 23 L 1/22

განაცხადის ნომრის, განაცხადის გამოქვეყნების ნომრისა
და კატეგორიის ნომრის შესაბამისობის ცხრილი

განაცხადის ნომერი (21)	განაცხადის გამოქვეყნების ნომერი (10)	კატეგორიის ნომერი (11)
AU 2012 012914	AU 2013 12914 U	U 2014 1801 Y
AU 2012 012915	AU 2013 12915 U	U 2014 1802 Y
AU 2013 013085	AU 2013 13085 U	U 2014 1803 Y

ღიზინები

საერთაშორისო კლასიფიკაციის ინდექსის და განაცხადის
გამოქვეყნების ნომრის შესაბამისობის ცხრილი

საერთაშორისო კლასიფიკაციის ინდექსი (51)	განაცხადის გამოქვეყნების ნომერი (10)
25-03	AD 2014 769 S
09-01	AD 2014 770 S
17-01	AD 2014 778 S

განაცხადის გამოქვეყნების ნომრის და საერთაშორისო
კლასიფიკაციის ინდექსის შესაბამისობის ცხრილი

განაცხადის გამოქვეყნების ნომერი (10)	საერთაშორისო კლასიფიკაციის ინდექსი (51)
AD 2014 769 S	25-03
AD 2014 770 S	09-01
AD 2014 778 S	17-01

საერთაშორისო კლასიფიკაციის ინდექსის, კატეგორიის ნომრისა
და გამოქვეყნების ნომრის შესაბამისობის ცხრილი

საერთაშორისო კლასიფიკაციის ინდექსი (51)	კატეგორიის ნომერი (11)	განაცხადის გამოქვეყნების ნომერი (10)
13-03	D 2014 570 S	AD 2013 755 S
13-03	D 2014 571 S	AD 2013 756 S
13-03	D 2014 572 S	AD 2013 757 S

კატეგორიის ნომრის, განაცხადის გამოქვეყნების ნომრისა
და საერთაშორისო კლასიფიკაციის ინდექსის შესაბამისობის ცხრილი

კატეგორიის ნომერი (11)	განაცხადის გამოქვეყნების ნომერი (10)	საერთაშორისო კლასიფიკაციის ინდექსი (51)
D 2014 570 S	AD 2013 755 S	13-03
D 2014 571 S	AD 2013 756 S	13-03
D 2014 572 S	AD 2013 757 S	13-03

განაცხადის ნომრის, განაცხადის გამოქვეყნების ნომრისა
და კატეგორიის ნომრის შესაბამისობის ცხრილი

განაცხადის ნომერი (21)	განაცხადის გამოქვეყნების ნომერი (10)	კატეგორიის ნომერი (11)
AD 2013 000755 S	AD 2013 755 S	D 2014 570 S
AD 2013 000756 S	AD 2013 756 S	D 2014 571 S
AD 2013 000757 S	AD 2013 757 S	D 2014 572 S

სასაქონლო ნიშნები

რეგისტრაციის ნომრის, განაცხადის ნომრის,
განაცხადის გამოქვეყნების ნომრისა და ბიულეტენის ნომრის
შესაბამისობის ცხრილი

რეგისტრაციის ნომერი (11)	განაცხადის ნომერი (210)	განაცხადის გამოქვეყნების ნომერი (260)	ბიულეტენის ნომერი
1	2	3	4
M 2014 24525 R	AM 2014 75804	-	5(393) 2014
M 2014 24526 R	AM 2014 75914	-	5(393) 2014
M 2014 24527 R	AM 2014 75915	-	5(393) 2014
M 2014 24528 R	AM 2014 75805	-	5(393) 2014

განაცხადის გამოქვეყნების ნომრის და განაცხადის ნომრის
შესაბამისობის ცხრილი

განაცხადის გამოქვეყნების ნომერი (260)	განაცხადის ნომერი (210)	1	2
1	2		
AM 2014 71529 A	AM 2013 71529	AM 2014 72810 A	AM 2013 72810
AM 2014 71656 A	AM 2013 71656	AM 2014 72854 A	AM 2013 72854
AM 2014 71657 A	AM 2013 71657	AM 2014 72856 A	AM 2013 72856
AM 2014 71994 A	AM 2013 71994	AM 2014 72857 A	AM 2013 72857
AM 2014 72328 A	AM 2013 72328	AM 2014 72874 A	AM 2013 72874
AM 2014 72743 A	AM 2013 72743	AM 2014 72930 A	AM 2013 72930
AM 2014 72744 A	AM 2013 72744	AM 2014 72972 A	AM 2013 72972
AM 2014 72791 A	AM 2013 72791	AM 2014 72973 A	AM 2013 72973
AM 2014 72800 A	AM 2013 72800	AM 2014 73002 A	AM 2013 73002
AM 2014 72801 A	AM 2013 72801	AM 2014 73100 A	AM 2013 73100
		AM 2014 73105 A	AM 2013 73105
		AM 2014 73125 A	AM 2013 73125
		AM 2014 73184 A	AM 2013 73184
		AM 2014 73185 A	AM 2013 73185

ბანაცხადის გამოქვეყნების ნომრის საძიებელი საქონლისა და/ან მომსახურების კლასის მიხედვით

საქონლისა და/ან მომსახურების კლასი (511)	ბანაცხადის გამოქვეყნების ნომერი (260)	1	2
1	2		
5	AM 2014 71656 A	33	AM 2014 72854 A
5	AM 2014 71657 A	33	AM 2014 72856 A
5	AM 2014 72930 A	33	AM 2014 72857 A
11	AM 2014 73100 A	35	AM 2014 71994 A
12	AM 2014 72874 A	35	AM 2014 72328 A
14	AM 2014 71994 A	35	AM 2014 72744 A
14	AM 2014 72791 A	35	AM 2014 72791 A
21	AM 2014 73002 A	35	AM 2014 72810 A
29	AM 2014 72328 A	35	AM 2014 72972 A
29	AM 2014 72810 A	35	AM 2014 72973 A
29	AM 2014 73105 A	35	AM 2014 73100 A
30	AM 2014 72328 A	36	AM 2014 72744 A
30	AM 2014 73105 A	36	AM 2014 73184 A
32	AM 2014 71529 A	36	AM 2014 73185 A
32	AM 2014 72328 A	39	AM 2014 72800 A
32	AM 2014 73002 A	39	AM 2014 72801 A
33	AM 2014 71529 A	39	AM 2014 73125 A
		43	AM 2014 72810 A
		43	AM 2014 73105 A
		45	AM 2014 72743 A
		45	AM 2014 72744 A

დაჩქარებული პროცედურით რეგისტრირებული სასაქონლო ნიშნის ნომრის საძიებელი საქონლისა და/ან მომსახურების კლასის მიხედვით

საქონლისა და/ან მომსახურების კლასი (511)	დაჩქარებული პროცედურით რეგისტრირებული სასაქონლო ნიშნის ნომერი (111)
4	M 2014 24526 R
4	M 2014 24527 R
7	M 2014 24525 R
9	M 2014 24525 R
11	M 2014 24525 R
29	M 2014 24528 R
30	M 2014 24528 R
35	M 2014 24528 R

სამრეწველო საკუთრების ოფისიალური ბიულეტენი

5(393)

ბიულეტენების ქართული და ინგლისურენოვანი გამოცემების ელექტრონული ვერსიის გაცნობა შესაძლებელია საქპატენტის ვებგვერდზე (www.sakpatenti.org.ge).

შენიშვნა:

ბიულეტენებში გამოქვეყნებული ობიექტების ზუსტი გამოსახულებები იხილეთ საქპატენტის ვებგვერდზე განთავსებულ ელექტრონულ ვერსიაში.

მთავარი რედაქტორი:	ნ. ბებრიშვილი
რედაქტორი:	ა. შიხაშვილი
კორექტორი:	ლ. ჭანტურია
დამაკაბადონებელი:	ქ. სვანიძე
პოლიგრაფიული ჯგუფი:	მ. მეჩიტაშვილი
	ი. გოგოლაშვილი
	ლ. დოლიძე

ხელმოწერილია გამოსაცემად: 2014 03 07

ტირაჟი: 40
შეკვეთა №5